

Bloco de intertravamento Mecânico BLIM / Mechanical Interlock BLIM
Enclavamiento Mecânico BLIM / Mechanische Verriegelung BLIM

Passo 1 - Step 1 - Paso 1 - Schritt 1

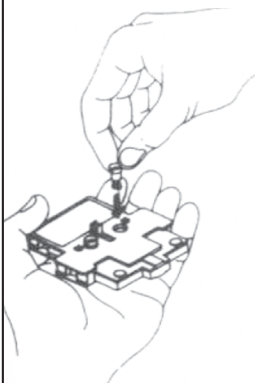

Passo 2 - Step 2 - Paso 2 - Schritt 2

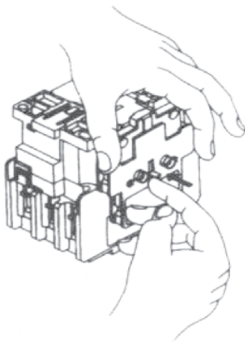

Passo 3 - Step 3 - Paso 3 - Schritt 3

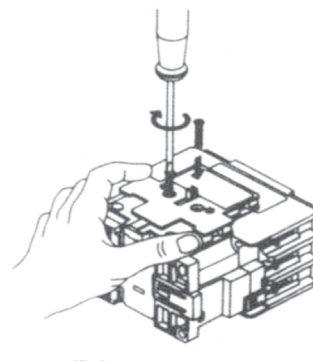

Passo 4 - Step 4 - Paso 4 - Schritt 4

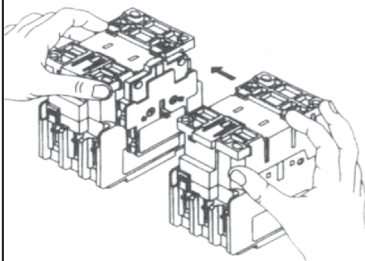

Passo 5 - Step 5 - Paso 5 - Schritt 5

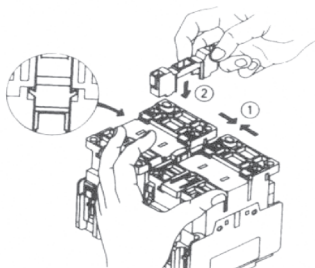
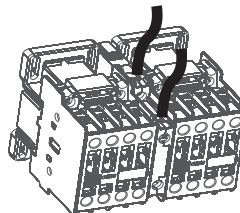

 Passo 6 - Step 6 - Paso 6 - Schritt 6
 Para BLIM.02 / For BLIM.02
 Para BLIM.02 / Für BLIM.02

| | | |
|---------------|--------------|---|
| Contatos 2NO | | |
| Contacts 2NO | | |
| Contactos 2NO | | |
| Kontakte 2NO | | |
| | N.m lb.in | 0,8 ... 1,5 7,1 ... 13,1 |
| | mm² | 1 x(4) 2x (0,5 ... 2,5) |
| | mm² | 1 x(4) 2x (0,5 ... 2,5) |
| AWG | | 12 ... 32 |

WEG Indústrias Ltda. - ACIONAMENTOS

 Av. Prefeito Waldemar Grubba, 3000
 89256-900 - Jaraguá do Sul - SC - BRASIL
 Tel. (0xx47) 3372-4000 - FAX (0xx47) 3372-4050

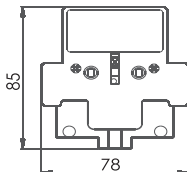
www.weg.net - e-mail: wa-mkt@weg.net

 São Paulo: TEL (0xx11) 5053-2300 - FAX (0xx11) 5052-4212
 CNPJ 07.175.725/0004-02

 Dimensões
 Dimensions
 Dimensiones
 Maße