

**Relays, Timers, Interface Modules,
Sockets and Accessories.**
2003 - 2004 Catalogue



Finder's 10,000 different products represent one of the most extensive product lines available on the market. They are the result of specialization across a variety of relay types: step relays, light dependent relays, miniature and sub-miniature p.c.b relays, plug-in general purpose and power relays, relay interface modules, timers relay sockets and accessories.



Our four factories produce over 150,000 relays every day, using machines which have been designed and built in-house by our own team of technicians, who are experts in their own right in production techniques and industrial automation.

Finder has always followed a product value strategy aimed at constantly increasing quality. Product line reliability has been recognized through approvals by international standards organizations such as the ABS, BBJ, BEAB, CSA, DEMKO, FIMKO, GERMANISCHER LLOYD, GOST, IMO, IRAM, LLOYD'S REGISTER, NEMKO, LCIE, RINA, SEV, SEMKO, TUV, UL and VDE, and through CE certification.

As important as these quality approvals are, Finder considers it no more important than its partnerships with customers, who are able to value the quality of its products and after-sales service.

For up-to-date information regarding Finder, visit our web site at www.findernet.com

FINDER S.p.A.

Via Drubiaglio, 14
10040 ALMESE (TO)
ITALY

Tel.+39/011.9346211
Fax +39/011.9359079
Export@findernet.com

For further information on the following, please complete and return:

Name: Position:

Company:

Address:

Postcode: E-mail:

Telephone: Fax:

















Finder customer: YES NO

PRICE LIST

CATALOGUE ON CD-ROM (includes DXF files for AUTOCAD R13)

SALES ENGINEER TO VISIT

	<p>30 Series.....Page 4 Subminiature D.I.L. Relays 1.25 A</p>		<p>56 Series.....Page 53 Miniature Power Relays 12 A</p> <p>96 Series.....Page 58 Sockets and Accessories</p>
	<p>34 Series.....Page 6 Ultra-Slim P.C.B. Relays 0.1 - 2 - 6 A</p>		<p>60 Series.....Page 60 General Purpose Relays 10 A</p> <p>90 Series.....Page 65 Sockets and Accessories</p>
	<p>36 Series.....Page 13 Miniature Relays 10 A</p>		<p>62 Series.....Page 70 Power Relays 16 A</p> <p>92 Series.....Page 79 Sockets and Accessories</p>
	<p>40 Series.....Page 16 Miniature P.C.B. Relays 8 - 10 - 16 A</p> <p>95 Series.....Page 23 Sockets and Accessories</p>		<p>65 Series.....Page 81 Power Relays 20 - 30 A</p>
	<p>41 Series.....Page 26 Low-Profile P.C.B. Relays 8 - 12 - 16 A</p> <p>95 Series.....Page 29 Sockets and Accessories</p>		<p>19 Series.....Page 85 Modular AUTO-OFF-ON Relays 10 A</p>
	<p>43 Series.....Page 30 Low-Profile P.C.B. Relays 10 A</p> <p>95 Series.....Page 33 Sockets and Accessories</p>		<p>38 Series.....Page 87 Relay Interface Module 0.1 - 2 - 6 A</p>
	<p>44 Series.....Page 34 Miniature P.C.B. Relays 6 - 10 A</p> <p>95 Series.....Page 37 Sockets and Accessories</p>		<p>48 Series.....Page 94 Relay Interface Modules 8 - 10 - 16 A</p>
	<p>45 Series.....Page 40 Miniature P.C.B. Relays 16 A</p>		<p>58 Series.....Page 99 Relay Interface Module 7 - 10 A</p>
	<p>55 Series.....Page 43 Miniature General Purpose Relays 7 - 10 A</p> <p>94 Series.....Page 48 Sockets and Accessories</p>		

	71 SeriesPage 103 Monitoring Relay 10 A		13 SeriesPage 152 Electronic Step Relays 10 - 16 A	30
	80 SeriesPage 117 Modular Timers 16 A		14 SeriesPage 155 Electronic Staircase Timers 16 A	34
	85 SeriesPage 121 Miniature Plug-in Timers 7 - 10 A		20 SeriesPage 158 Modular Step Relays 16 A	36
	94 SeriesPage 124 Sockets and Accessories		22 SeriesPage 161 Modular Monostable Relays 20 A	40
	86 SeriesPage 126 Timer Modules		26 SeriesPage 164 Step Relays 10 A	41
	90 - 92 - 94 - 95 SeriesPage 130 Sockets and Accessories		27 SeriesPage 167 Step Relays 10 A	43
	87 SeriesPage 132 Modular Timers 5 - 8 A		General Technical InformationPage 171	44
	88 SeriesPage 140 Plug-in Timers 5 - 8 A			45
	90 SeriesPage 143 Sockets and Accessories			46
	10 SeriesPage 144 Light Dependent Relays 12 - 16 A			55
	11 SeriesPage 146 Modular Light Dependent Relays 16 A			56
	12 SeriesPage 149 Time Switches 16 A			60

30

- Sub miniature relay
- Low level switching capability
- Sensitive DC coil, 200mW
- Wash tight: RT III

30.22



- Low consumption
- P.C.B. mounting

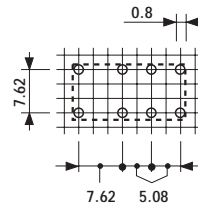
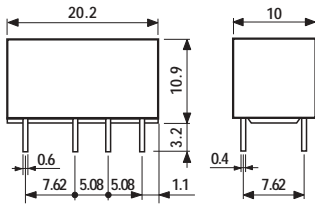
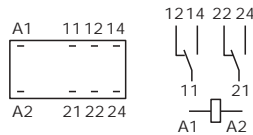

Copper side view

Contact specifications		
Contact configuration		2 CO
Rated current/Maximum peak current	A	1.25/2
Rated voltage/Maximum switching voltage V AC		125/250
Rated load in AC1	VA	125
Rated load in AC15 (230 VAC)	VA	25
Single phase motor rating (230 VAC)	kW	—
Breaking capacity in DC1: 30/110/220V	A	2/0.3/—
Minimum switching load	mW (V/mA)	10 (0.1/1)
Standard contact material		AgNi+Au
Coil specifications		
Nominal voltage (U _N)	V AC (50/60 Hz)	—
	V DC	5 - 6 - 9 - 12 - 24 - 48
Rated power AC/DC	VA (50 Hz)/W	—/0.2
Operating range	AC	—
	DC	see table page 5
Holding voltage	AC/DC	—/0.35 U _N
Must drop-out voltage	AC/DC	—/0.05 U _N
Technical data		
Mechanical life AC/DC	cycles	—/10 · 10 ⁶
Electrical life at rated load AC1	cycles	100 · 10 ³
Operate/release time	ms	6/2
Insulation according to EN 61810-5		1.2 kV/2
Insulation between coil and contacts (1.2/50µs)	kV	1.5
Dielectric strength between open contacts	V AC	750
Ambient temperature range	°C	-40...+85
Environmental protection		RT III
Approvals: (according to type)		GOST US

ORDERING INFORMATION

Example: a 30 series P.C.B. relay with 2 CO contacts, with coil rated at 12 V sensitive DC.

3	0	.	2	.	2	.	7	.	0	1	2	.	0	0	.	1	0
----------	----------	---	----------	---	----------	---	----------	---	----------	----------	----------	---	----------	----------	---	----------	----------

A	0
B	0
C	1
D	0

Series ————— 30

Type ————— 2
2 = P.C.B.

No. of poles ————— 2
2 = 2 pole, 1.25 A

Coil version ————— 7
7 = Sensitive DC

Coil voltage ————— 012
see coil specifications

A: Contact material
0 = Standard
AgNi + Au (5µm)

B: Contact circuit
0 = CO

C: Options
1 = None

D: Special versions
0 = Wash tight (RT III)

TECHNICAL DATA

INSULATION

INSULATION according to EN 61810-5	insulation rated voltage	V	125
	rated impulse withstand voltage	kV	1.2
	pollution degree		2
	overvoltage category		I

OTHER DATA

BOUNCE TIME: NO/NC	ms	1/3
VIBRATION RESISTANCE (10...55Hz): NO/NC	g/g	10/10
POWER LOST TO THE ENVIRONMENT	without contact current	W
	with rated current	W
RECOMMENDED DISTANCE between RELAYS mounted on P.C.B.s	mm	≥5

COIL SPECIFICATIONS

DC VERSION DATA (0.2 W sensitive)

Nominal voltage U_N	Coil code	Operating range		Resistance R	Rated coil consumption I at U_N
		U_{min}	U_{max}		
V		V	V	Ω	mA
5	7.005	3.7	7.5	125	40
6	7.006	4.5	9	180	33
9	7.009	6.7	13.5	405	22
12	7.012	8.4	18	720	16
24	7.024	16.8	36	2,880	8.3
48	7.048	36	72	11,520	4.1

R 30 DC

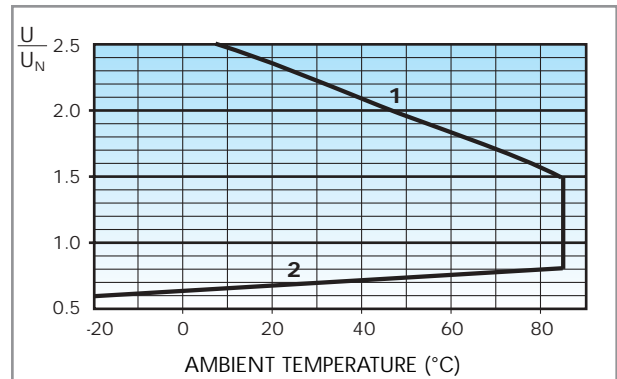

Operating range vs ambient temperature.

1 - Max coil voltage permitted.

2 - Min pick-up voltage with coil at ambient temperature.

34

- Ultra-slim, 5 mm wide
- Sensitive DC coil, 170mW
- 6/8 mm clearance/creepage distance
- 6kV (1.2/50 μs) between coil and contacts

34.51



- 5 mm wide
- P.C.B. mounting

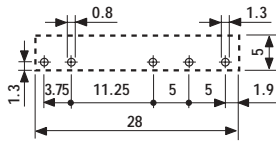
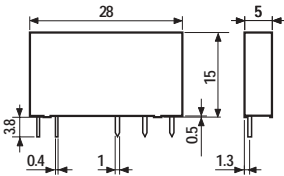
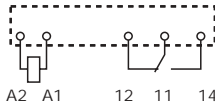

Copper side view

* For 400 V applications, where requirements for pollution degree 2 are met.

Contact specifications		
Contact configuration		1 CO
Rated current/Maximum peak current	A	6/10
Rated voltage/Maximum switching voltage	V AC	250/400*
Rated load in AC1	VA	1,500
Rated load in AC15 (230 VAC)	VA	300
Single phase motor rating (230 VAC)	kW	—
Breaking capacity in DC1: 30/110/220V	A	6/0.2/0.12
Minimum switching load	mW (V/mA)	500 (12/10)
Standard contact material		AgNi
Coil specifications		
Nominal voltage (U _N)	V AC (50/60 Hz)	—
	V DC	5 · 12 · 24 · 48 · 60
Rated power AC/DC	VA (50 Hz)/W	—/0.17
Operating range	AC	—
	DC	(0.7... 1.5)U _N
Holding voltage	AC/DC	—/0.4 U _N
Must drop-out voltage	AC/DC	—/0.05 U _N
Technical data		
Mechanical life AC/DC	cycles	—/10 · 10 ⁶
Electrical life at rated load AC1	cycles	60 · 10 ³
Operate/release time	ms	5/3
Insulation according to EN 61810-5		4 kV/3
Insulation between coil and contacts (1.2/50μs)	kV	6 (8 mm)
Dielectric strength between open contacts	V AC	1,000
Ambient temperature range	°C	-40...+85
Environmental protection		RT II
Approvals: (according to type)		GOST

- Ultra-slim, 5 mm wide
- High switching speed and endurance
- Silent switching

34.81....9024

34.81....7048



- Switching current 2A -
24 V DC
- P.C.B. mounting

- Switching current 0.1A -
48 V DC
- P.C.B. mounting

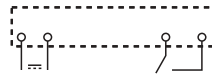

A2- A1+ + A
input output

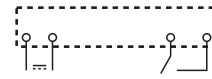

A2- A1+ + A
input output

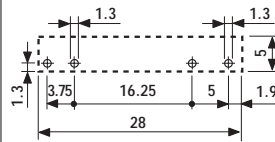
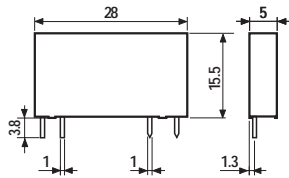

Copper side view

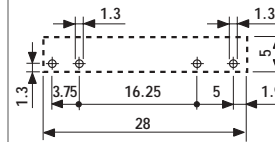

Copper side view

Output circuit					
Rated current/Maximum peak current (10 ms)	A	2/20		0.1/0.5	
Rated voltage/Maximum blocking voltage	V DC	24/33		48/60	
Switching voltage range	V DC	1.5...24		1.5...48	
Minimum switching current	mA	1		0.05	
Max "OFF-state" leakage current	µA	1		1	
Max "ON-state" voltage drop	V	0.12		1	
Input circuit					
Nominal voltage	V DC	24	60	24	60
Operating range	V DC	16...30	35...72	16...30	35...72
Control current	mA	7	3	7	3
Release voltage	V DC	10	20	10	20
Impedance	Ω	3,200	21,300	3,200	21,300
Technical data					
Operate/release time	µs	90/280		18/90	
Dielectric strength between input/output	V	2,500		2,500	
Ambient temperature range	°C	-30...+60		-30...+60	
Environmental protection		RT III		RT III	
Approvals: (according to type)		—		—	

ORDERING INFORMATION

34 ELECTROMECHANICAL RELAY

Example: a 34 series slim electromechanical relay, 1 CO - 6 A, with 24 V sensitive DC coil.

	3	4	5	1	7	0	2	4	A	B	C	D
Series												
Type												
5 = Electromechanical type												
No. of poles												
1 = 1 pole, 6 A												
Coil version												
7 = Sensitive DC												
Coil voltage												
see coil specifications												
									A: Contact material			D: Special versions
									0 = Standard AgNi		0 = Flux proof (RT II)	
									4 = AgSnO ₂		9 = Flat version	
									5 = AgNi + Au			
									B: Contact circuit			C: Options
									0 = CO		1 = None	
									3 = NO			

Only combinations in the same row are possible

Preferred versions

	coil version	A	B	C	D
34.51	sens. DC	0	0	1	0

All versions

	coil version	A	B	C	D
34.51	sens. DC	0 - 4 - 5	0 - 3	1	0
34.51	sens. DC	0 - 4 - 5	0	1	9

SOLID STATE RELAY

Example: a 34 series SSR relay, 2A, with 24VDC supply.

	3	4	8	1	7	0	2	4	9	0	2	4
Series												
Type												
8 = SSR type												
Output												
1 = 1 NO												
Input circuit												
see input specifications												
									Output circuit			
									9024 = 2 A - 24 VDC			
									7048 = 0.1A - 48 VDC			

Note: All technical data are referred using the relay directly on PCB or PCB socket mounted type 93.11.

If the relay is use with 35 mm rail socket types 93.01 or 93.51, referer to the technical data of 38 Series, page 87

POSSIBLE OPTIONS



Option = 34.51.7xxx.x019

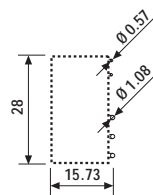
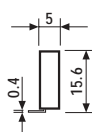
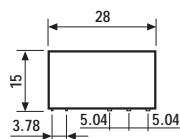

Copper side view



ELECTROMECHANICAL RELAY

TECHNICAL DATA

INSULATION

INSULATION according to EN 61810-5	insulation rated voltage	V	250
	rated impulse withstand voltage	kV	4
	pollution degree		3
	overvoltage category		III

IMMUNITY

CONDUCTED DISTURBANCE IMMUNITY	BURST (according to EN 61000-4-4) level 4 (4 kV)
	SURGE (according to EN 61000-4-5) level 3 (2 kV)

OTHER DATA

BOUNCE TIME: NO/NC	ms	1/6	
VIBRATION RESISTANCE (10...55Hz): NO/NC	g/g	10/5	
POWER LOST TO THE ENVIRONMENT	without contact current	W	0.2
	with rated current	W	0.5
RECOMMENDED DISTANCE between RELAYS mounted on P.C.B.s	mm	≥5	

CONTACT SPECIFICATIONS

F 34

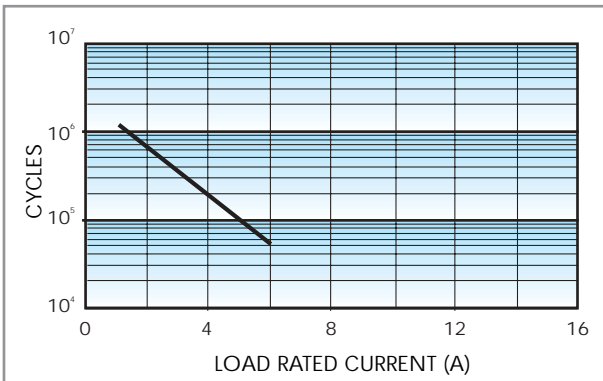

Electrical life vs AC1 load.

H 34

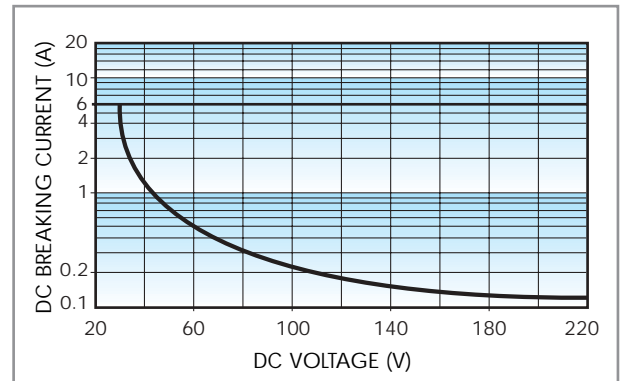

Breaking capacity in DC1 load.

- When switching a resistive load (DC1) having voltage and current values under the curve the expected electrical life is $\geq 100 \cdot 10^3$ cycles.
 - In case of DC13 loads the connection of a diode in parallel with the load will permit the same electrical life as for a DC1 load.
- Note:** the release time of load will be increase.

COIL SPECIFICATIONS

DC VERSION DATA

Nominal voltage U_N V	Coil code	Operating range		Resistance R Ω	Rated coil consumption I at U_N mA
		U_{min} V	U_{max} V		
5	7.005	3.5	7.5	130	38.4
12	7.012	8.4	18	840	14.2
24	7.024	16.8	36	3,350	7.1
48	7.048	33.6	72	12,300	3.9
60	7.060	42	90	19,700	3

R 34 DC

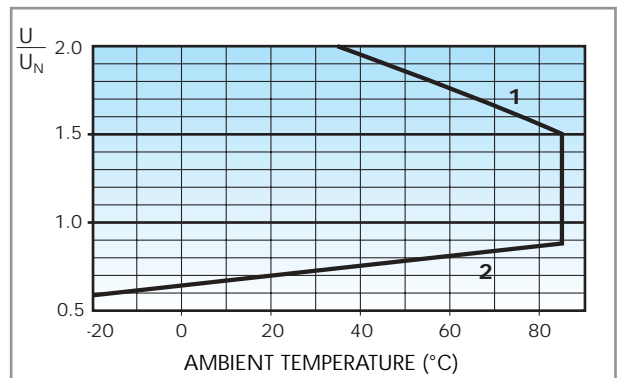

Operating range vs ambient temperature.

- 1 - Max coil voltage permitted.
- 2 - Min pick-up voltage with coil at ambient temperature.

SOLID STATE RELAY

34 TECHNICAL DATA

OTHER DATA

POWER LOST TO THE ENVIRONMENT	without output current W	0.17
	with rated current W	0.4

INPUT SPECIFICATION

DC VERSION DATA

Nominal voltage U_N	Input code	Operating range		Release voltage	Control current I at U_N
		U_{min}	U_{max}		
V		V	V	V	mA
24	7.024	16	30	10	7
60	7.060	35	72	20	3

OUTPUT SPECIFICATION

L 34/2A

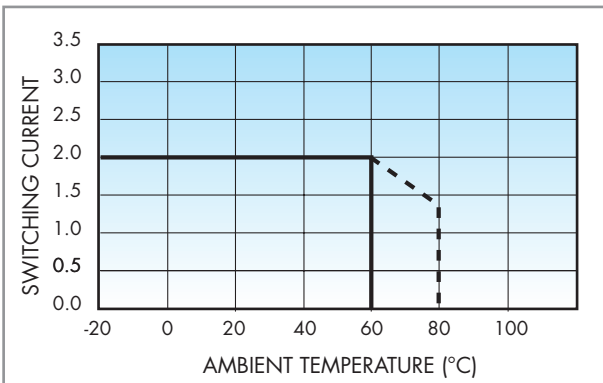

Type 34.81 (2A-24VDC)
Switching current vs ambient temperature

L 34/0.1A

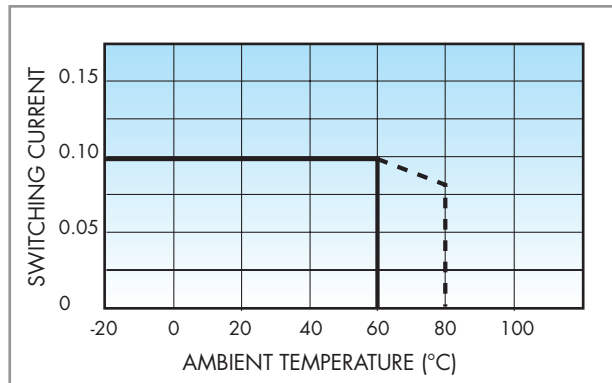

Type 34.81 (100mA-48VDC)
Switching current vs ambient temperature



93.01

Approvals
(according to type):

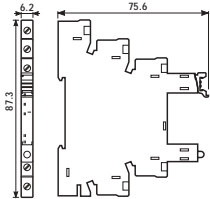

Relay type	34.51, 34.81	
Screw terminal socket: 35 mm (EN 50022) mounting		
Supply voltage	Relay type	Socket type
12 VAC/DC	34.51.7.012.xx10	93.01.0.024
24 VAC/DC	34.51.7.024.xx10	93.01.0.024
48 VAC/DC	34.51.7.048.xx10	93.01.0.060
60 VAC/DC	34.51.7.060.xx10	93.01.0.060
110...125 VAC/DC	34.51.7.060.xx10	93.01.0.125
220...240 VAC/DC	34.51.7.060.xx10	93.01.0.240
110...125 VAC/DC*	34.51.7.060.xx10 or 34.81.7.060.xxxx	93.01.3.125*
220...240 VAC*	34.51.7.060.xx10 or 34.81.7.060.xxxx	93.01.3.240*
6 VDC	34.51.7.005.xx10	93.01.7.024
12 VDC	34.51.7.012.xx10	93.01.7.024
24 VDC	34.51.7.024.xx10 or 34.81.7.024.xxxx	93.01.7.024
48 VDC	34.51.7.048.xx10	93.01.7.060
60 VDC	34.51.7.060.xx10 or 34.81.7.060.xxxx	93.01.7.060



93.51

Approvals
(according to type):

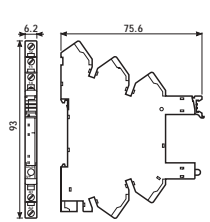

Relay type	34.51, 34.81	
Screwless terminal socket: 35 mm (EN 50022) mounting		
Supply voltage	Relay type	Socket type
12 VAC/DC	34.51.7.012.xx10	93.51.0.024
24 VAC/DC	34.51.7.024.xx10	93.51.0.024
110...125 VAC/DC	34.51.7.060.xx10	93.51.0.125
220...240 VAC/DC	34.51.7.060.xx10	93.51.0.240
110...125 VAC/DC*	34.51.7.060.xx10 or 34.81.7.060.xxxx	93.51.3.125*
220...240 VAC*	34.51.7.060.xx10 or 34.81.7.060.xxxx	93.51.3.240*
12 VDC	34.51.7.012.xx10	93.51.7.024
24 VDC	34.51.7.024.xx10 or 34.81.7.024.xxxx	93.51.7.024
60 VDC	34.51.7.060.xx10 or 34.81.7.060.xxxx	93.51.7.060

* Leakage current suppression



93.11

Approvals
(according to type):



- RATED VALUES: 6A - 250 V
- INSULATION: ≥ 6 kV (1.2/50 μ s) between coil and contacts
- PROTECTION CATEGORY: IP 20
- AMBIENT TEMPERATURE: (-40...+70) °C

Relay type	34.51/34.81
Colour	BLUE
P.C.B. sockets with retaining and release clip	93.11

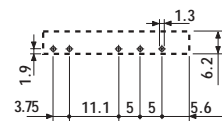
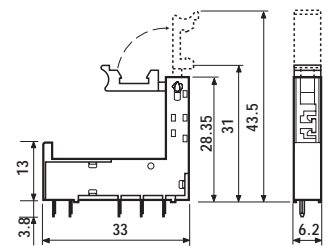

Copper side view

Retaining and release clip use:

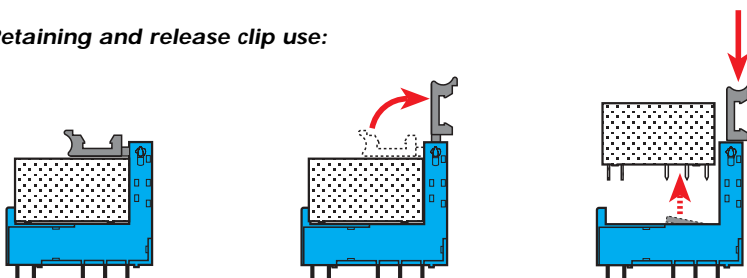

ACCESSORIES

34



093.20

Approvals
(according to type):



20-way jumper link for 38 series	093.20
---	--------

- RATED VALUES: 36 A - 250 V

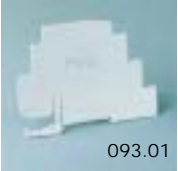
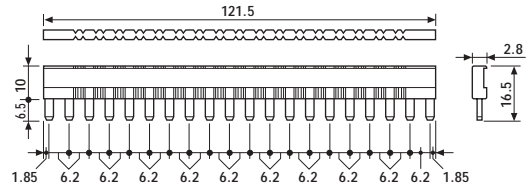

093.01

Plastic separator	093.01
--------------------------	--------

Thickness 2mm, required at the start and the end of a group of interfaces.

Can be used for visual separation group, must be used for:

- protective separation of different voltages of neighbouring PLC interfaces according to VDE 0106-101
- protection of cut jumper links



093.64

Sheet of marker tags (64 tags): 6x10 mm	093.64
--	--------

- P.C.B. mount
- Sugar cube
- Sensitive DC coil
- Wash tight: RT III
- Basic insulation VDE 0435

36.11
36.11....0300

- Sugar cube
- 1 CO
- P.C.B. mounting

- Sugar cube
- 1 NO
- P.C.B. mounting

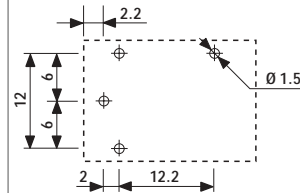
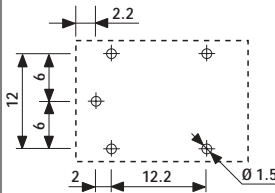
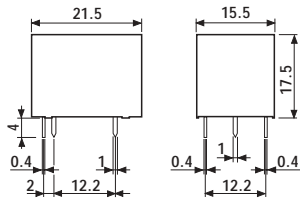
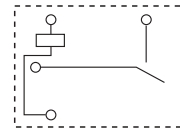
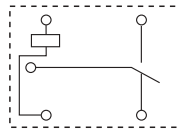

Copper side view

Copper side view

Contact specifications			
Contact configuration		1 CO	1 NO
Rated current/Maximum peak current	A	10/15	10/15
Rated voltage/Maximum switching voltage	V AC	250/250	250/250
Rated load in AC1	VA	2,500	2,500
Rated load in AC15 (230 VAC)	VA	500	500
Single phase motor rating (230 VAC)	kW	0.37	0.37
Breaking capacity in DC1: 30/110/220V	A	10/0.3/0.12	10/0.3/0.12
Minimum switching load	mW (V/mA)	500 (5/100)	500 (5/100)
Standard contact material		AgCdO	AgCdO
Coil specifications			
Nominal voltage (U _N)	V AC (50/60 Hz)	—	—
	V DC	3 - 5 - 6 - 9 - 12 - 24 - 48	3 - 5 - 6 - 9 - 12 - 24 - 48
Rated power AC/sens. DC	VA (50 Hz)/W	—/0.36	—/0.36
Operating range	AC	—	—
	DC	(0.75...1.5)U _N	(0.75...1.5)U _N
Holding voltage	AC/DC	—/0.4 U _N	—/0.4 U _N
Must drop-out voltage	AC/DC	—/0.1 U _N	—/0.1 U _N
Technical data			
Mechanical life AC/DC	cycles	—/10 · 10 ⁶	—/10 · 10 ⁶
Electrical life at rated load AC1	cycles	100 · 10 ³	100 · 10 ³
Operate/release time	ms	7/3	7/2
Insulation according to EN 61810-5		2.5 kV/2	2.5 kV/2
Insulation between coil and contacts (1.2/50µs)	kV	4	4
Dielectric strength between open contacts	V AC	1,000	1,000
Ambient temperature range	°C	-40...+85	-40...+85
Environmental protection		RT III	RT III
Approvals: (according to type)		GOST	GOST

ORDERING INFORMATION

Example: a 36 series miniature P.C.B. relay, 1 CO - 10 A contacts, with 12 V DC coil.

36

3 6 . 1 1 . 9 . 0 1 2 . 0 0 0 0

Series ————
Type ————
 1 = P.C.B.
No. of poles ————
 1 = 1 pole, 10 A
Coil version ————
 9 = DC
Coil voltage ————
 see coil specifications

A: Contact material
 0 = Standard AgCdO
B: Contact circuit
 0 = CO
 3 = NO

D: Special versions
 0 = Wash tight (RT III)
C: Options
 0 = None

TECHNICAL DATA

INSULATION

INSULATION according to EN 61810-5	insulation rated voltage	V	250
	rated impulse withstand voltage	kV	2.5
	pollution degree		2
	overvoltage category		II

OTHER DATA

BOUNCE TIME: NO/NC	ms	1/6 (CO version)	1/- (NO version)
--------------------	----	------------------	------------------

CONTACT SPECIFICATIONS

F 36

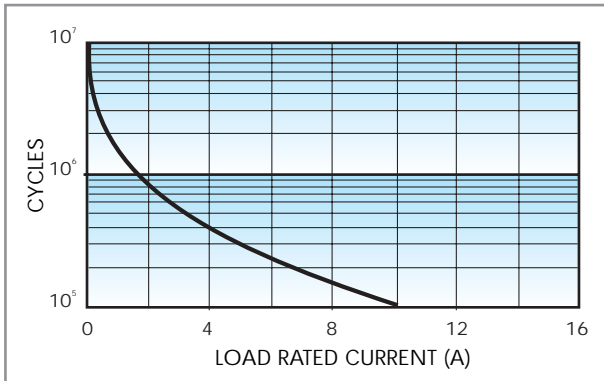

Electrical life vs AC1 load.

H 36

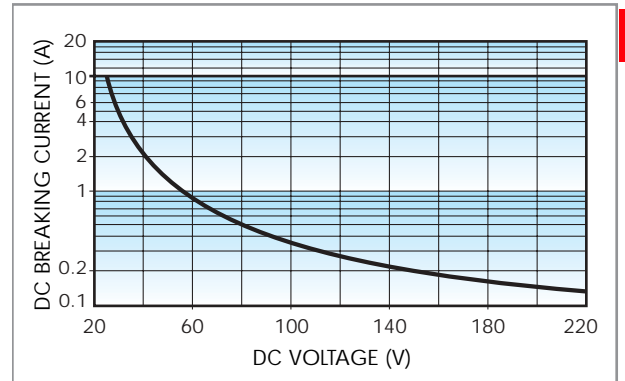

Breaking capacity in DC1 load.

- When switching a resistive load (DC1) having voltage and current values under the curve the expected electrical life is $\approx 100 \cdot 10^3$ cycles.
- In case of DC13 loads the connection of a diode in parallel with the load will permit the same electrical life as for a DC1 load.

Note: the release time of load will be increase.

COIL SPECIFICATIONS

DC VERSION DATA

Nominal voltage U_N V	Coil code	Operating range		Resistance R Ω	Rated coil consumption I at U_N mA
		U_{min} V	U_{max} V		
3	9.003	2.2	4.5	25	120
5	9.005	3.7	7.5	70	72
6	9.006	4.5	9	100	60
9	9.009	6.7	13.5	225	40
12	9.012	9	18	400	30
24	9.024	18	36	1,600	15
48	9.048	36	72	6,400	7.5

R 36

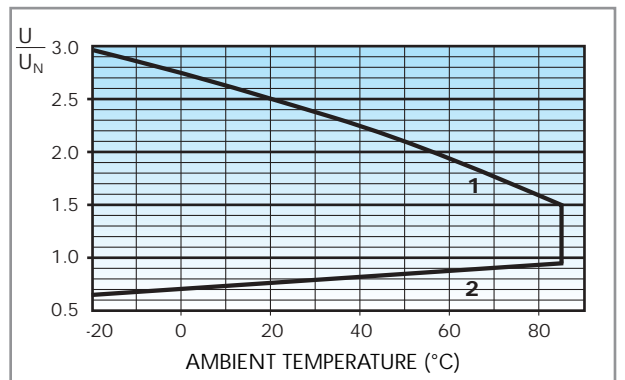

Operating range vs ambient temperature.

1 - Max coil voltage permitted.

2 - Min pick-up voltage with coil at ambient temperature.

- P.C.B. or plug-in mount
- AC, DC, sensitive DC or single bistable coil versions available
- 8 mm, 6 kV (1.2/50 μs) between coil and contacts
- Ambient temperature +85°C
- Sockets and accessories: see 95, 99 and 86 series
- RT III (wash tight) version available

40

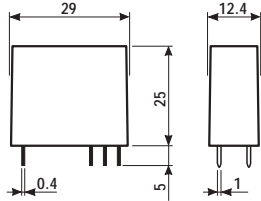

* For 400 V applications, where requirements for pollution degree 2 are met.

40.31

40.51

40.52



- 1 pole, 10 A
- 3.5 mm pinning
- P.C.B. / for use with 95 series sockets

- 1 pole, 10 A
- 5 mm pinning
- P.C.B. / for use with 95 series sockets

- 2 pole, 8 A
- 5 mm pinning
- P.C.B. / for use with 95 series sockets

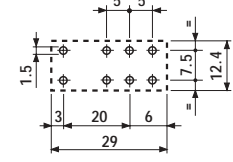
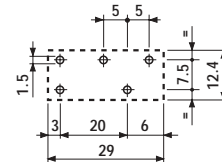
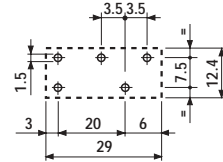
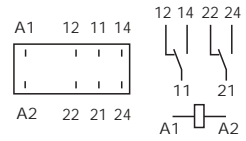
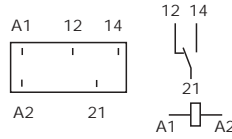
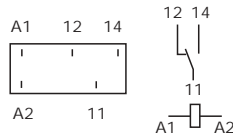

Copper side view

Copper side view

Copper side view

Contact specifications				
Contact configuration		1 CO	1 CO	2 CO
Rated current/Maximum peak current	A	10/20	10/20	8/15
Rated voltage/Maximum switching voltage	V AC	250/400*	250/400*	250/250
Rated load in AC1	VA	2,500	2,500	2,000
Rated load in AC15 (230 VAC)	VA	500	500	400
Single phase motor rating (230 VAC)	kW	0.37	0.37	0.3
Breaking capacity in DC1: 30/110/220V	A	10/0.3/0.12	10/0.3/0.12	8/0.3/0.12
Minimum switching load	mW (V/mA)	300 (5/5)	300 (5/5)	300 (5/5)
Standard contact material		AgNi	AgNi	AgNi
Coil specifications				
Nominal voltage (U _N)	V AC (50/60 Hz)	6 - 12 - 24 - 48 - 60 - 110 - 120 - 230 - 240		
	V DC	5 - 6 - 7 - 9 - 12 - 14 - 18 - 21 - 24 - 28 - 36 - 48 - 60 - 90 - 110 - 125		
Rated power AC/DC/sens. DC	VA (50 Hz)/W/W	1.2/0.65/0.5	1.2/0.65/0.5	1.2/0.65/0.5
Operating range	AC	(0.8...1.1)U _N		
	DC/sens. DC	(0.73...1.5)U _N /(0.73...1.75)U _N		
Holding voltage	AC/DC	0.8 U _N / 0.4 U _N		
Must drop-out voltage	AC/DC	0.2 U _N / 0.1 U _N		
Technical data				
Mechanical life AC/DC	cycles	10 · 10 ⁶ /20 · 10 ⁶		
Electrical life at rated load AC1	cycles	200 · 10 ³		
Operate/release time	ms	7/3 - (12/4 sens.)		
Insulation according to EN 61810-5		4 kV/3		
Insulation between coil and contacts (1.2/50μs)	kV	6 (8mm)		
Dielectric strength between open contacts	V AC	1,000		
Ambient temperature range	°C	-40...+85		
Environmental protection		RT I		

Approvals: (according to type)



- P.C.B. or plug-in mount
- AC, DC, sensitive DC or single bistable coil versions available
- 8 mm, 6 kV (1.2/50 μs) between coil and contacts
- Ambient temperature +85°C
- Sockets and accessories: see 95, 99 and 86 series
- RT III (wash tight) version available

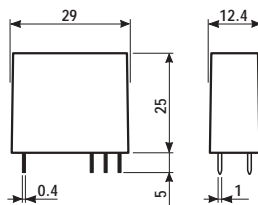

* For 400 V applications, where requirements for pollution degree 2 are met.
 ** With the AgSnO₂ material the maximum peak current is 100 A · 5 ms. on NO contact

	40.61	40.xx.6
	- 1 pole, 16 A - 5 mm pinning - P.C.B. / for use with 95 series sockets	- Bistable version (1 coil) - P.C.B. / for use with 95 series sockets
	<p style="text-align: center;">Copper side view</p>	Bistable version (1 coil) types: 40.31.6... 40.51.6... 40.52.6... 40.61.6... For wiring diagrams see page 22
Contact specifications		
Contact configuration	1 CO	
Rated current/Maximum peak current A	16/30**	
Rated voltage/Maximum switching voltage V AC	250/400*	See relays
Rated load in AC1 VA	4,000	40.31
Rated load in AC15 (230 VAC) VA	750	40.51
Single phase motor rating (230 VAC) kW	0.55	40.52
Breaking capacity in DC1: 30/110/220V A	16/0.3/0.12	40.61
Minimum switching load mW (V/mA)	500 (10/5)	
Standard contact material	AgCdO	
Coil specifications		
Nominal voltage (U _N) V AC (50/60 Hz)	6 · 12 · 24 · 48 · 60 · 110 · 120 · 230 · 240	5 · 6 · 12 · 24 · 48 · 110
	V DC	***See below
Rated power AC/DC/sens. DC VA (50 Hz)/W/W	1.2/0.65/0.5	1.0/1.0/—
Operating range AC	(0.8...1.1)U _N	(0.8...1.1)U _N
	DC/sens. DC	(0.73...1.5)U _N /(0.8...1.5)U _N
Holding voltage AC/DC	0.8 U _N /0.4 U _N	—
Must drop-out voltage AC/DC	0.2 U _N /0.1 U _N	—
Technical data		
Mechanical life AC/DC cycles	10 · 10 ⁶ /20 · 10 ⁶	See relays
Electrical life at rated load AC1 cycles	100 · 10 ³	40.31
Operate/release time ms	7/3 - (12/4 sens.)	40.51
Insulation according to EN 61810-5	4 kV/3	40.52
Insulation between coil and contacts (1.2/50μs) kV	6 (8mm)	40.61
Dielectric strength between open contacts V AC	1,000	
Ambient temperature range °C	-40...+85	Min. impulse duration ≥ 20 ms
Environmental protection	RT I	

*** Nominal voltage (U_N):
 5 · 6 · 7 · 9 · 12 · 14 · 18 · 21 ·
 24 · 28 · 36 · 48 · 60 · 90 ·
 110 · 125 V DC

- Plug-in or P.C.B. versions
- Sensitive DC version available
- 8 mm, 6 kV (1.2/50 μs) between coil and contacts
- Sockets and accessories: see 95 series

40

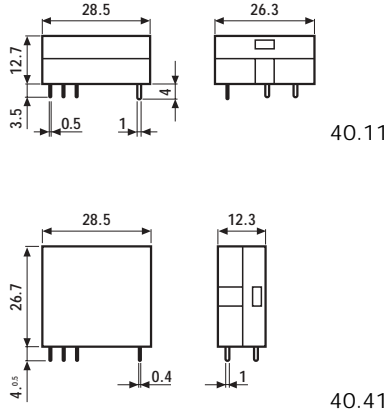

40.11

40.41



- | | |
|---|---|
| <ul style="list-style-type: none"> - 1 pole, 10 A - 3.5 mm pinning - P.C.B. mounting | <ul style="list-style-type: none"> - 1 pole, 10 A - 3.5 mm pinning - P.C.B./for use with 95 Series Sockets |
|---|---|

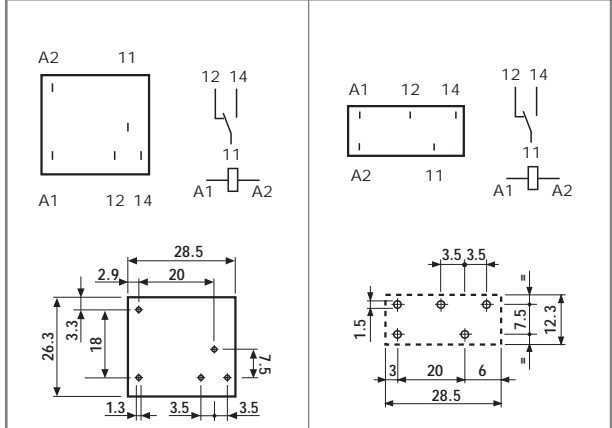

Copper side view

Copper side view

* For 400 V applications, where requirements for pollution degree 2 are met.

Contact specifications			
Contact configuration		1 CO	1 CO
Rated current/Maximum peak current	A	10/20	10/20
Rated voltage/Maximum switching voltage	V AC	250/400*	250/400*
Rated load in AC1	VA	2,500	2,500
Rated load in AC15 (230 VAC)	VA	500	500
Single phase motor rating (230 VAC)	kW	0.37	0.37
Breaking capacity in DC1: 30/110/220V	A	10/0.3/0.12	10/0.3/0.12
Minimum switching load	mW (V/mA)	300 (5/5)	300 (5/5)
Standard contact material		AgCdO	AgCdO
Coil specifications			
Nominal voltage (U _N)	V AC (50/60 Hz)	—	
	V DC	6 - 12 - 24 - 48 - 60	
Rated power AC/DC/sens. DC	VA (50 Hz)/W/W	—/—/0.5	—/—/0.5
Operating range	AC	—	
	DC/sens. DC	—/(0.73...1.75)U _N	—/(0.73...1.75)U _N
Holding voltage	AC/DC	—/0.4 U _N	—/0.4 U _N
Must drop-out voltage	AC/DC	—/0.1 U _N	—/0.1 U _N
Technical data			
Mechanical life AC/DC	cycles	—/20 · 10 ⁶	—/20 · 10 ⁶
Electrical life at rated load AC1	cycles	200 · 10 ³	200 · 10 ³
Operate/release time	ms	12/4	12/4
Insulation according to EN 61810-5		4 kV/3	4 kV/3
Insulation between coil and contacts (1.2/50μs)	kV	6 (8 mm)	6 (8 mm)
Dielectric strength between open contacts	V AC	1,000	1,000
Ambient temperature range	°C	-40...+70	-40...+70
Environmental protection		RT I	RT I
Approvals: (according to type)		GOST	

ORDERING INFORMATION

Example: a 40 series P.C.B. relay with 2 CO contacts, with coil rated at 230 V AC.

4 0 . 5 2 . 8 . 2 3 0 . 0 0 0 0

Series

Type

- 1 = P.C.B. - 3.5 mm pinning, flat
- 3 = P.C.B. - 3.5 mm pinning
- 4 = P.C.B. - 3.5 mm pinning
- 5 = P.C.B. - 5 mm pinning
- 6 = P.C.B. - 5 mm pinning

No. of poles

- 1 = 1 pole
 - for: 40.11, 10 A
 - 40.31, 10 A
 - 40.41, 10 A
 - 40.51, 10 A
 - 40.61, 16 A
- 2 = 2 pole
 - for 40.52, 8 A

Coil version

- 6 = AC/DC bistable
- 7 = Sensitive DC
- 8 = AC (50/60 Hz)
- 9 = DC

Coil voltage

see coil specifications

A: Contact material

- 0 = Standard AgNi
for: 40.31/51/52
AgCdO for 40.61
- 2 = AgCdO (standard
for 40.11/41)
- 4 = AgSnO₂
- 5 = AgNi + Au (5µm)

B: Contact circuit

- 0 = CO
- 3 = NO

D: Special versions

- 0 = Standard
- 1 = Wash tight (RT III)
- 3 = High temperature (+125°C)
wash tight

C: Options

- 0 = None

Only combinations in the same row are possible

Preferred versions

	coil version	A	B	C	D
40.11/41	sens.DC	2	0	0	0
40.31/51	AC/DC/sens.DC	0	0	0	0
40.52	AC/DC/sens.DC	0	0	0	0
40.61	AC/DC/sens.DC	0	0	0	0

All versions

	coil version	A	B	C	D
40.11	sens.DC	2	0	0	0
40.41	sens.DC	2	0 - 3	0	0
40.31/51	AC/sens.DC	0 - 2 - 5	0 - 3	0	0 - 1
40.31/51	DC	0 - 2 - 5	0 - 3	0	0 - 1 - 3
40.52	AC/sens.DC	0 - 2 - 5	0 - 3	0	0 - 1
40.52	DC	0 - 2 - 5	0 - 3	0	0 - 1 - 3
40.61	AC/sens.DC	0 - 4	0 - 3	0	0 - 1
40.61	DC	0 - 4	0 - 3	0	0 - 1 - 3
40.31/51/ 52/61	bistable	0	0	0	0

TECHNICAL DATA

INSULATION

INSULATION according to EN 61810-5	insulation rated voltage	V	250	
	rated impulse withstand voltage	kV	4	
	pollution degree		3 (1 CO)	2 (2 CO)
	overvoltage category		III	

IMMUNITY

CONDUCTED DISTURBANCE IMMUNITY	BURST (according to EN 61000-4-4) level 4 (4kV)
	SURGE (according to EN 61000-4-5) level 3 (2kV)

OTHER DATA

BOUNCE TIME: NO/NC	ms	2/5
VIBRATION RESISTANCE (10...55Hz): NO/NC	g/g	10/4 (1 CO) 3/3 (2 CO)
POWER LOST TO THE ENVIRONMENT	without contact current	W
	with rated current	W
	1.2 (40.11/31/41/51)	2 (40.61/52)
RECOMMENDED DISTANCE between RELAYS mounted on P.C.B.s	mm	≥5

CONTACT SPECIFICATIONS

F 40

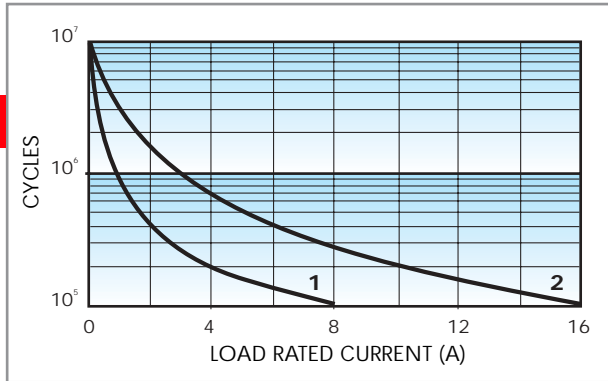

Electrical life vs AC1 load.

- 1** - Type 40.52 (8 A)
- 2** - Types 40.11, 40.31, 40.41, 40.51 (10 A)
Type 40.61 (16 A)

H 40

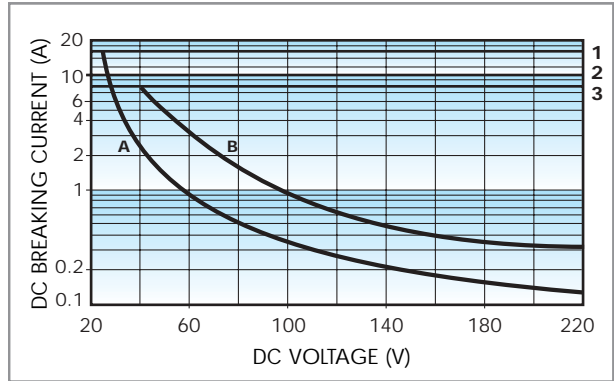

Breaking capacity for DC1 load.

- 1** - Type 40.61
- 2** - Types 40.11, 40.31, 40.41, 40.51
- 3** - Type 40.52
- A** - Load applied to 1 contact
- B** - Load applied to 2 contacts in series

- When switching a resistive load (DC1) having voltage and current values under the curve the expected electrical life is $\geq 100 \cdot 10^3$ cycles.

- In case of DC13 loads the connection of a diode in parallel with the load will permit the same electrical life as for a DC1 load.

Note: the release time of load will be increase.

COIL SPECIFICATIONS

DC VERSION DATA (0.65 W standard - Types 40.31/51/52/61)

Nominal voltage U_N	Coil code	Operating range		Resistance R	Rated coil consumption I at U_N
		U_{min}	U_{max}		
V		V	V	Ω	mA
5	9.005	3.65	7.5	38	130
6	9.006	4.4	9	55	109
7	9.007	5.1	10.5	75	94
9	9.009	6.6	13.5	125	72
12	9.012	8.8	18	220	55
14	9.014	10.2	21	300	47
18	9.018	13.1	27	500	36
21	9.021	15.3	31.5	700	30
24	9.024	17.5	36	900	27
28	9.028	20.5	42	1,200	23
36	9.036	26.3	54	2,000	18
48	9.048	35	72	3,500	14
60	9.060	43.8	90	5,500	11
90	9.090	65.7	135	12,500	7.2
110	9.110	80.3	165	18,000	6.2
125	9.125	91.2	187.5	23,500	5.3

DC VERSION DATA (0.5 W standard - Types 40.31/51/52/61)

Nominal voltage U_N	Coil code	Operating range		Resistance R	Rated coil consumption I at U_N
		U_{min}^*	U_{max}^{**}		
V		V	V	Ω	mA
5	7.005	3.7	8.8	50	100
6	7.006	4.4	10.5	75	80
7	7.007	5.1	12.2	100	70
9	7.009	6.6	15.8	160	56
12	7.012	8.8	21	300	40
14	7.014	10.2	24.5	400	35
18	7.018	13.2	31.5	650	27.7
21	7.021	15.4	36.9	900	23.4
24	7.024	17.5	42	1,200	20
28	7.028	20.5	49	1,600	17.5
36	7.036	26.3	63	2,600	13.8
48	7.048	35	84	4,800	10
60	7.060	43.8	105	7,200	8.4
90	7.090	65.7	157	16,200	5.6
110	7.110	80.3	192	23,500	4.7
125	7.125	91.2	218.7	32,000	3.9

40

* $U_{min} = 0.8 U_N$ for 40.61 ** $U_{max} = 1.5 U_N$ for 40.61

DC VERSION DATA (0.5 W sensitive - Types 40.11/41)

Nominal voltage U_N	Coil code	Operating range		Resistance R	Rated coil consumption I at U_N
		U_{min}	U_{max}		
V		V	V	Ω	mA
6	7.006	4.4	10.5	75	80
12	7.012	8.8	21	300	40
24	7.024	17.5	42	1,200	20
48	7.048	35	84	4,600	10.4
60	7.060	43.8	105	7,200	8.3

AC VERSION DATA (Types 40.31/51/52/61)

Nominal voltage U_N	Coil code	Operating range		Resistance R	Rated coil consumption I at U_N (50Hz)
		U_{min}	U_{max}		
V		V	V	Ω	mA
6	8.006	4.8	6.6	21	168
12	8.012	9.6	13.2	80	90
24	8.024	19.2	26.4	320	45
48	8.048	38.4	52.8	1,350	21
60	8.060	48	66	2,100	16.8
110	8.110	88	121	6,900	9.4
120	8.120	96	132	9,000	8.4
230	8.230	184	253	28,000	5
240	8.240	192	264	31,500	4.1

AC/DC VERSION DATA (bistable - Types 40.31/51/52/61)

Nominal voltage U_N	Coil code	Operating range		Resistance R	Rated coil consumption I at U_N	DC: Release resistance** R_{DC}
		U_{min}	U_{max}			
V		V	V	Ω	mA	Ω
5	6.005	4	5.5	23	215	37
6	6.006	4.8	6.6	33	165	62
12	6.012	9.6	13.2	130	83	220
24	6.024	19.2	26.4	520	40	910
48	6.048	38.4	52.8	2,100	21	3,600
110	6.110	88	121	11,000	10	16,500

** R_{DC} = Resistance in DC, $R_{AC} = 1.3 \times R_{DC}$, 1W

COIL SPECIFICATIONS

R 40 DC

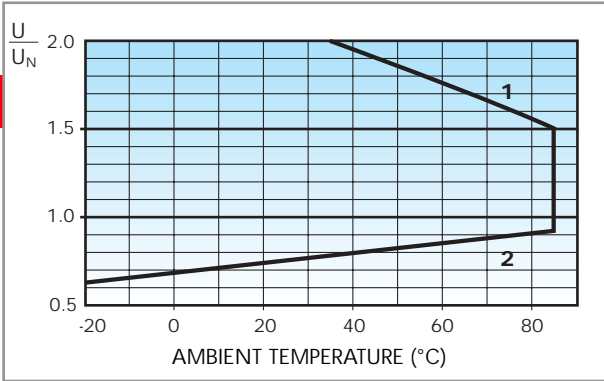

R 40 sens. DC (types 40.31/51/52/61)

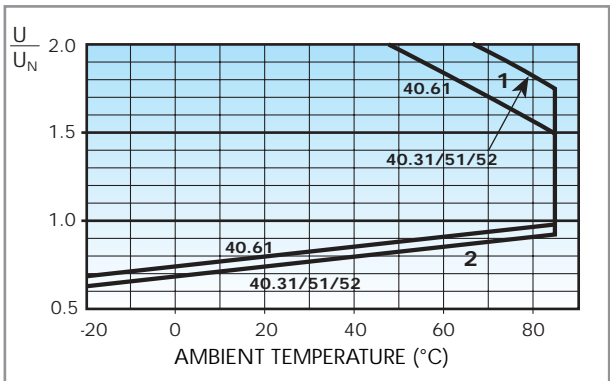

R 40 AC

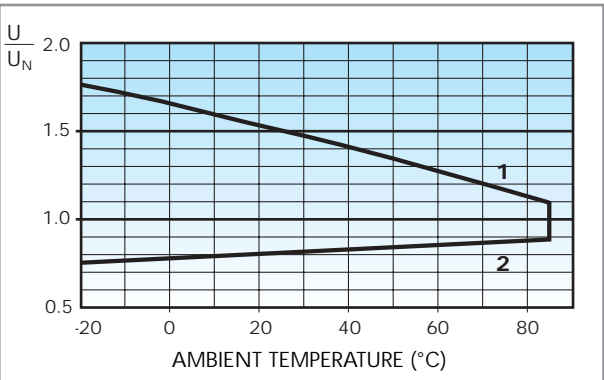

R 40 sens. DC (types 40.11/41)

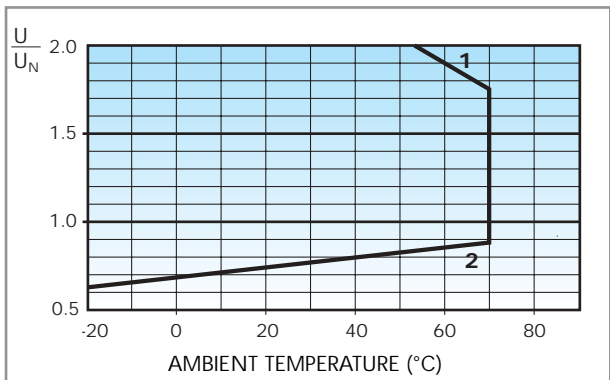

Operating range vs ambient temperature.

- 1 - Max coil voltage permitted.
- 2 - Min pick-up voltage with coil at ambient temperature.

Operating range vs ambient temperature.

- 1 - Max coil voltage permitted.
- 2 - Min pick-up voltage with coil at ambient temperature.

Wiring Diagram for 40 Series bistable coil version

AC Operation

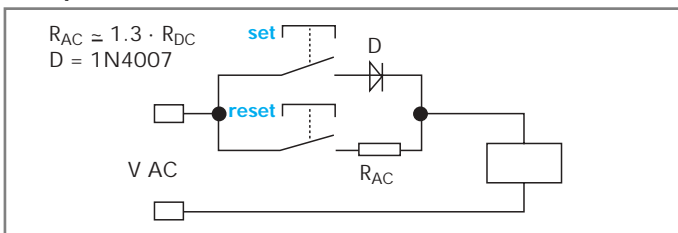

DC Operation

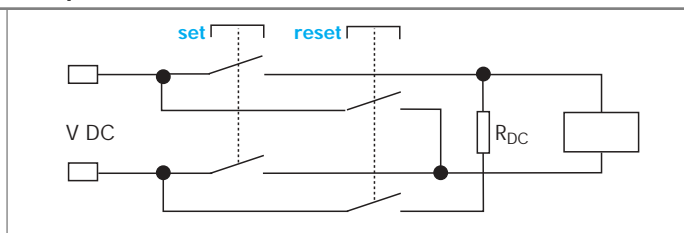

On momentary closure of the SET switch the relay is magnetised through the diode and the relay contacts transfer to the set position and remain in this position.

On momentary closure of the RESET switch the relay is demagnetised through limiting resistor (R_{AC}) and the contacts return to the reset position.

On momentary closure of the SET switch the relay is magnetised and the relay contacts transfer to the set position and remain in this position.

On momentary closure of the RESET switch the relay is demagnetised through limiting resistor (R_{DC}) and the contacts return to the reset position.

Notes: The minimum SET or RESET impulse time is 20 ms. The maximum time can be continuous. In practice, always ensure that the SET and RESET contacts cannot be operated simultaneously.



95.05

Approvals
(according to type):



GOST cRU[®] US



095.01

- RATED VALUES: 10 A - 250 V
with a current >10 A, the contact terminal must be connected in parallel (21 with 11, 24 with 14, 22 with 12)
- INSULATION: ≥ 6 kV (1.2/50 μ s) between coil and contacts
- PROTECTION CATEGORY: IP 20
- AMBIENT TEMPERATURE: (-40...+70) °C
- \oplus SCREW TORQUE: 0.5 Nm
- WIRE STRIP LENGTH: 8 mm
- MAX WIRE SIZE:

	solid wire	stranded wire
mm ²	1x6 / 2x2.5	1x4 / 2x2.5
AWG	1x10 / 2x14	1x12 / 2x14

Relay type	40.31		40.51/ 52/ 61	
	BLUE	BLACK	BLUE	BLACK
Colour	BLUE	BLACK	BLUE	BLACK
Clamp terminal socket: panel or 35 mm rail (EN 50022) mount, retaining clip 095.01 supplied with socket packaging code SPA	95.03	95.03.0	95.05	95.05.0
Plastic retaining and release clip	095.01	095.01.0	095.01	095.01.0
Metal retaining clip	095.71			
8-way jumper link for 95.03 and 95.05 sockets	095.18	095.18.0	095.18	095.18.0
Identification tag	095.00.4			
Modules (see table below)	99.02			

40

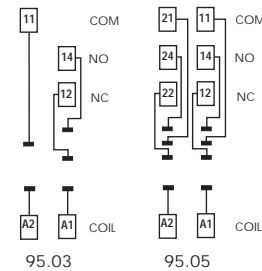
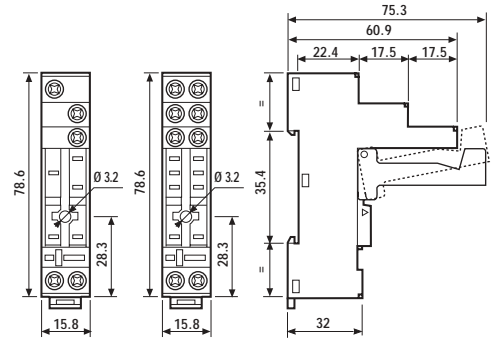

FOR 95.03 AND 95.05 SOCKETS:



095.18

8-way jumper link	095.18
--------------------------	--------

- RATED VALUES: 10 A - 250 V

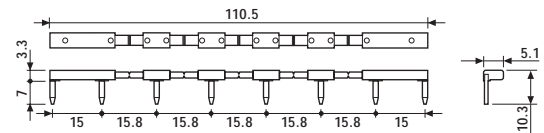

86.10

86 Series Module Timers (see technical data pages 126/131)	BLUE
Mono-function: 12...24 V AC/DC; function AI; (1.5s...60min)	86.10.0.024.0000
Mono-function: 12...24 V AC/DC; function DI; (1.5s...60min)	86.20.0.024.0000



99.02

99.02 coil indication and EMC suppression modules (see technical data page 179)		BLUE*
Diode** (+A1, standard polarity)	(6...220) V DC	99.02.3.000.00
LED	(6...24) V DC/AC	99.02.0.024.59
LED	(28...60) V DC/AC	99.02.0.060.59
LED	(110...240) V DC/AC	99.02.0.230.59
LED + Diode** (+A1, standard polarity)	(6...24) V DC	99.02.9.024.99
LED + Diode** (+A1, standard polarity)	(28...60) V DC	99.02.9.060.99
LED + Diode** (+A1, standard polarity)	(110...220) V DC	99.02.9.220.99
LED + Varistor	(6...24) V DC/AC	99.02.0.024.98
LED + Varistor	(28...60) V DC/AC	99.02.0.060.98
LED + Varistor	(110...240) V DC/AC	99.02.0.230.98
RC	(6...24) V DC/AC	99.02.0.024.09
RC	(28...60) V DC/AC	99.02.0.060.09
RC	(110...240) V DC/AC	99.02.0.230.09
Residual current by-pass (62 k Ω /1W)	(110...240) V AC	99.02.8.230.07

Approvals
(according to type):

cRU[®] US GOST

* Modules in Black housing are available on request.

** For DC supply, apply the positive to terminal A1.



95.85.3

Relay type	40.31		40.51, 40.52, 40.61	
Colour	BLUE	BLACK	BLUE	BLACK
Clamp terminal socket: panel or 35 mm rail (EN 50022) mount retaining clip 095.92 supplied with socket packaging code SPA	95.83.3	95.83.30	95.85.3	95.85.30
Metal retaining clip	095.71			
Plastic retaining clip	095.92.3			
8-way jumper link for 95.83.3 and 95.85.3 sockets	095.08	095.08.0	095.08	095.08.0
Modules (see table below)	99.80			

40 Approvals (according to type):



- RATED VALUES: 10 A - 250 V
with a current > 10 A, the contact terminal must be connected in parallel (21 with 11, 24 with 14, 22 with 12)
- INSULATION: ≥ 6 kV (1.2/50 μ s) between coil and contacts
- PROTECTION CATEGORY: IP 20
- AMBIENT TEMPERATURE: (-40...+70) °C
- SCREW TORQUE: 0.5 Nm
- WIRE STRIP LENGTH: 7 mm
- MAX WIRE SIZE:

	solid wire	stranded wire
mm ²	1x6 / 2x2.5	1x4 / 2x2.5
AWG	1x10 / 2x14	1x12 / 2x14

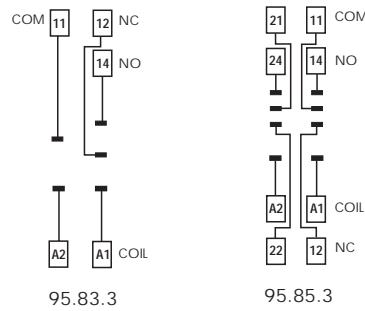
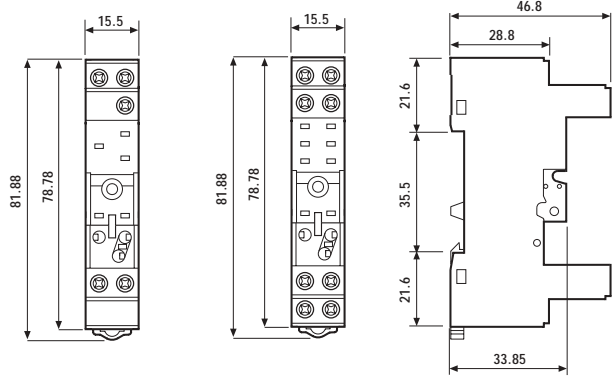

FOR 95.83.3 AND 95.85.3 SOCKETS:



095.08

8-way jumper link	095.08
--------------------------	--------

- RATED VALUES: 10 A - 250 V

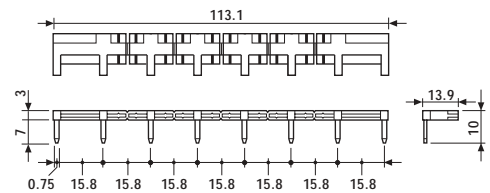

99.80

Approvals (according to type):

GOST

* Modules in Black housing are available on request.

** For DC supply, apply the positive to terminal A1.

Green LED is standard. Red LED available on request.

99.80 coil indication and EMC suppression modules (see technical data page 179)		BLUE*
Diode** (+A1, standard polarity)	(6...220) V DC	99.80.3.000.00
LED	(6...24) V DC/AC	99.80.0.024.59
LED	(28...60) V DC/AC	99.80.0.060.59
LED	(110...240) V DC/AC	99.80.0.230.59
LED + Diode** (+A1, standard polarity)	(6...24) V DC	99.80.9.024.99
LED + Diode** (+A1, standard polarity)	(28...60) V DC	99.80.9.060.99
LED + Diode** (+A1, standard polarity)	(110...220) V DC	99.80.9.220.99
LED + Varistor	(6...24) V DC/AC	99.80.0.024.98
LED + Varistor	(28...60) V DC/AC	99.80.0.060.98
LED + Varistor	(110...240) V DC/AC	99.80.0.230.98
RC circuit	(6...24) V DC/AC	99.80.0.024.09
RC circuit	(28...60) V DC/AC	99.80.0.060.09
RC circuit	(110...240) V DC/AC	99.80.0.230.09
Residual current by-pass (62 k Ω /1W)	(110...240) V AC	99.80.8.230.07



Approvals
(according to type):



- RATED VALUES: 10 A - 250 V
- INSULATION: ≥ 6 kV (1.2/50 μ s) between coil and contacts
- PROTECTION CATEGORY: IP 20
- AMBIENT TEMPERATURE: (-40...+70) °C

Relay type	40.31, 40.41		40.51, 40.52, 40.61	
Colour	BLUE	BLACK	BLUE	BLACK
P.C.B. socket	95.13.2	95.13.20	95.15.2	95.15.20
retaining clip 095.51 supplied with socket packaging code SMA				
Metal retaining clip	095.51			
Plastic retaining clip	095.52			

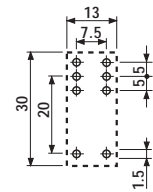
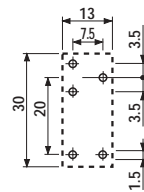
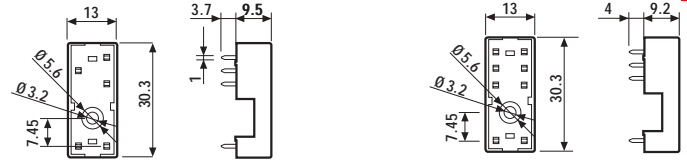

95.13.2

95.15.2

Copper side view

PACKAGING CODES

How to code and identify retaining clip and packaging options for sockets.

Code options according to the last three letters:



A Standard packaging

SM Metal retaining clip
SP Plastic retaining clip
SX No retaining clip

- Low-profile, only 15.7 mm high
- DC coil versions 0.4 W
- 8 mm, 6 kV(1.2/50 μs) between coil and contacts
- Ambient temperature +85°C
- Sockets and accessories: see 95 and 99 series

41

41.31

41.52

41.61



- 1 pole, 12 A
- low profile, 3.5 mm pinning
- P.C.B. / for use with 95 series sockets

- 2 pole, 8 A
- low profile, 5 mm pinning
- P.C.B. / for use with 95 series sockets

- 1 pole, 16 A
- low profile, 5 mm pinning
- P.C.B. / for use with 95 series sockets

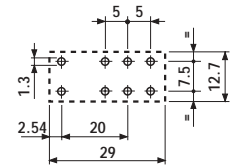
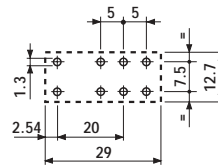
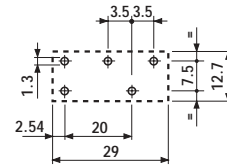
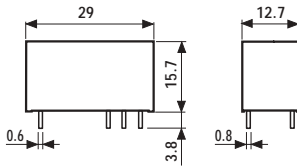
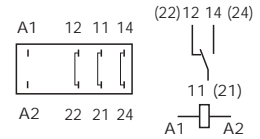
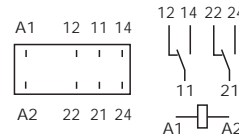
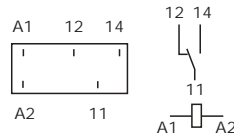

* For 400 V applications, where requirements for pollution degree 2 are met.

Contact specifications				
Contact configuration			1 CO	2 CO
Rated current/Maximum peak current		A	12/25	8/15
Rated voltage/Maximum switching voltage		V AC	250/400*	250/400*
Rated load in AC1		VA	3,000	2,000
Rated load in AC15 (230 VAC)		VA	600	400
Single phase motor rating (230 VAC)		kW	0.5	0.3
Breaking capacity in DC1: 30/110/220V		A	12/0.3/0.12	8/0.3/0.12
Minimum switching load		mW (V/mA)	300 (5/5)	300 (5/5)
Standard contact material			AgNi	AgNi
Coil specifications				
Nominal voltage (U _N)	V AC (50/60 Hz)		—	—
	V DC		12 · 24 · 48 · 60 · 110	12 · 24 · 48 · 60 · 110
Rated power AC/DC	VA (50 Hz)/W		—/0.4	—/0.4
Operating range	AC		—	—
	DC		(0.7...1.5)U _N	(0.7...1.5)U _N
Holding voltage	AC/DC		—/0.4 U _N	—/0.4 U _N
Must drop-out voltage	AC/DC		—/0.1 U _N	—/0.1 U _N
Technical data				
Mechanical life AC/DC	cycles		—/30 · 10 ⁶	—/30 · 10 ⁶
Electrical life at rated load AC1	cycles		150 · 10 ³	80 · 10 ³
Operate/release time	ms		5/4	5/4
Insulation according to EN 61810-5			4 kV/3	4 kV/3
Insulation between coil and contacts (1.2/50μs)		kV	6 (8mm)	6 (8mm)
Dielectric strength between open contacts		V AC	1,000	1,000
Ambient temperature range		°C	−40...+85	−40...+85
Environmental protection			RT II	RT II

Approvals: (according to type)



ORDERING INFORMATION

Example: a 41 series low-profile P.C.B. relay with 2 CO contacts, with coil rated 24 V DC.

4
1
.
5
2
.
9
.
0
2
4
.
0
0
1
0

Series

Type

3 = P.C.B. - 3.5 mm pinning
 5 = P.C.B. - 5 mm pinning
 6 = P.C.B. - 5 mm pinning

No. of poles

1 = 1 pole for
 41.31, 12 A
 41.61, 16 A
 2 = 2 pole for
 41.52, 8 A

Coil version

9 = DC

Coil voltage

see coil specifications

A: Contact material

0 = Standard AgNi
 4 = AgSnO₂
 5 = AgNi + Au

B: Contact circuit

0 = CO
 3 = NO

D: Special versions

0 = Flux proof (RT II)
 1 = Wash tight (RT III)

C: Options

1 = None

Only combinations in the same row are possible

Preferred versions

	coil version	A	B	C	D
41.31/52/ 61	DC	0	0	1	0

All versions

	coil version	A	B	C	D
41.31	DC	0 - 4 - 5	0 - 3	1	0 - 1
41.52	DC	0 - 5	0 - 3	1	0 - 1
41.61	DC	0 - 4	0 - 3	1	0 - 1

TECHNICAL DATA

INSULATION

INSULATION according to EN 61810-5	insulation rated voltage	V	250
	rated impulse withstand voltage	kV	4
	pollution degree		3
	overvoltage category		III

OTHER DATA

BOUNCE TIME: NO/NC	ms	2/5		
VIBRATION RESISTANCE (10...55Hz): NO/NC	g/g	20/5		
POWER LOST TO THE ENVIRONMENT	without contact current	W	0.4	
	with rated current	W	1.7 (41.31)	1.2 (41.52) 1.8 (41.61)
RECOMMENDED DISTANCE between RELAYS mounted on P.C.B.s	mm	≥5		

CONTACT SPECIFICATIONS

F 41

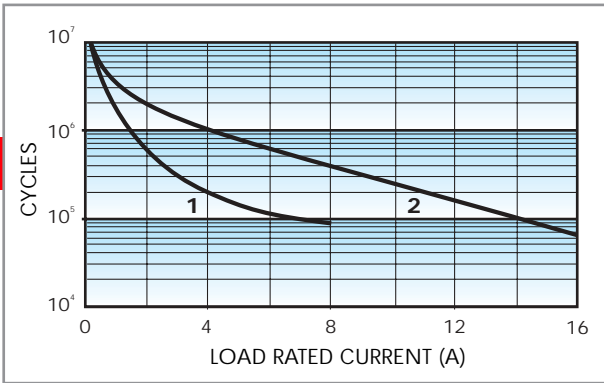

Contact life vs AC1 load.

- 1** - Type 41.52 (8 A) at 360 cycles/h.
- 2** - Type 41.31 (12 A) at 360 cycles/h.
- Type 41.61 (16 A) at 360 cycles/h.

H 41

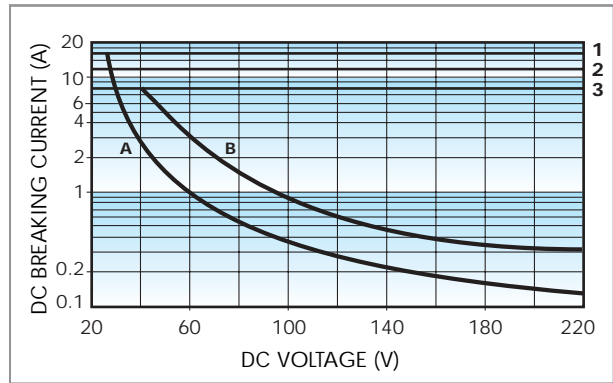

Breaking capacity for DC1 load.

- 1** - Type 41.61
- 2** - Type 41.31
- 3** - Type 41.52
- A** - Load applied to 1 contact
- B** - Load applied to 2 contacts in series

- When switching a resistive load (DC1) having voltage and current values under the curve the expected electrical life is $\geq 100 \cdot 10^3$ cycles.
 - In case of DC13 loads the connection of a diode in parallel with the load will permit the same electrical life as for a DC1 load.
- Note:** the release time of load will be increase.

COIL SPECIFICATIONS

DC VERSION DATA

Nominal voltage U_N V	Coil code	Operating range		Resistance R Ω	Rated coil consumption I at U_N mA
		U_{min} V	U_{max} V		
12	9.012	8.4	18	360	33.3
24	9.024	16.8	36	1,440	19.7
48	9.048	33.6	72	5,760	8.3
60	9.060	42	90	9,000	6.6
110	9.110	77	165	24,200	4.5

R 41 DC

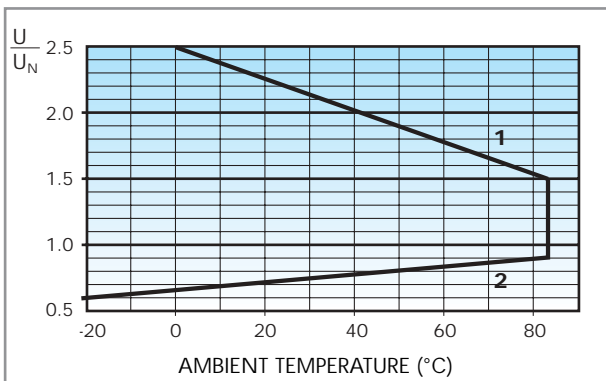

Operating range vs ambient temperature.

- 1** - Max coil voltage permitted.
- 2** - Min pick-up voltage with coil at ambient temperature.



Approvals
(according to type):



- RATED VALUES: 10 A - 250 V
- INSULATION: ≥ 6 kV (1.2/50 μ s) between coil and contacts
- PROTECTION CATEGORY: IP 20
- AMBIENT TEMPERATURE: (-40...+70) °C

Relay type	41.31		41.52, 41.61	
	BLUE	BLACK	BLUE	BLACK
P.C.B. socket	95.13.2	95.13.20	95.15.2	95.15.20
retaining clip 095.41 supplied with socket packaging code SNA				
Metal retaining clip	095.41			
Plastic retaining clip	095.42			

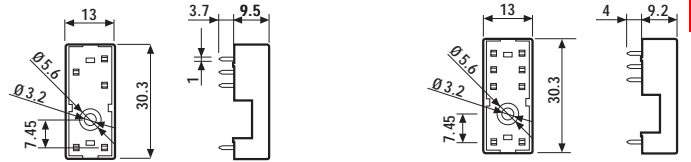

Copper side view

PACKAGING CODES

How to code and identify retaining clip and packaging options for sockets.

Code options according to the last three letters:

9 5 . 1 3 . 2 S N A

A Standard packaging

SN Low profile metal retaining clip
SL Low profile plastic retaining clip
SX No retaining clip

- 15.4 mm high
- Very low coil consumption, only 250 mW
- 10 mm, 6 kV (1.2/50 μs) between coil and contacts
- Ambient temperature +85°C
- Sockets: see Type 95.23

43

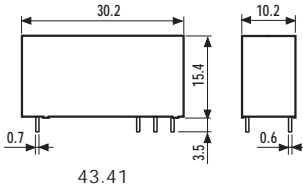

43.41

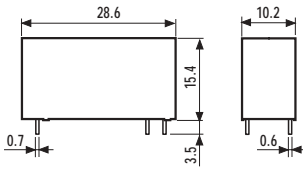

43.41-0300

* For 400 V applications, where requirements for pollution degree 2 are met.

43.41

43.41...0300



- 1 CO, 10 A
- 3.2 mm pinning
- P.C.B. mounting or sockets 95 series

- 1 NO, 10 A
- 5 mm pinning
- P.C.B. mounting

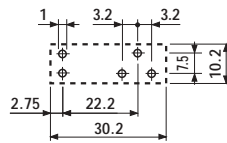
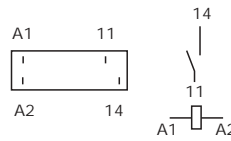
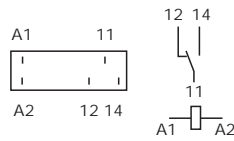

Copper side view

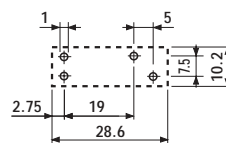

Copper side view

Contact specifications			
Contact configuration		1 CO	1 NO
Rated current/Maximum peak current	A	10/15	10/15
Rated voltage/Maximum switching voltage	V AC	250/400*	250/400*
Rated load in AC1	VA	2,500	2,500
Rated load in AC15 (230 VAC)	VA	500	500
Single phase motor rating (230 VAC)	kW	—	—
Breaking capacity in DC1: 30/110/220V	A	10/0.3/0.12	10/0.3/0.12
Minimum switching load	mW (V/mA)	300 (5/5)	300 (5/5)
Standard contact material		AgCdO	AgCdO
Coil specifications			
Nominal voltage (U _N)	V AC (50/60 Hz)	—	—
	V DC	3 · 6 · 9 · 12 · 18 · 24 · 36 · 48	3 · 6 · 9 · 12 · 18 · 24 · 36 · 48
Rated power AC/DC	VA (50 Hz)/W	—/0.25	—/0.25
Operating range	AC	—	—
	DC	(0.7...1.5)U _N	(0.7...1.5)U _N
Holding voltage	AC/DC	—/0.4 U _N	—/0.4 U _N
Must drop-out voltage	AC/DC	—/0.05 U _N	—/0.05 U _N
Technical data			
Mechanical life AC/DC	cycles	—/10 · 10 ⁶	—/10 · 10 ⁶
Electrical life at rated load AC1	cycles	100 · 10 ³	100 · 10 ³
Operate/release time	ms	6/4	6/2
Insulation according to EN 61810-5		4 kV/3	4 kV/3
Insulation between coil and contacts (1.2/50μs)	kV	6 (10mm)	6 (10mm)
Dielectric strength between open contacts	V AC	1,000	1,000
Ambient temperature range	°C	−40...+85	−40...+85
Environmental protection		RT II	RT II
Approvals: (according to type)		GOST	

ORDERING INFORMATION

Example: a 43 series low-profile P.C.B. relay with 1 CO contact, with coil rated 24 V DC.

	4	3	.	4	1	.	7	.	0	2	4	.	A	2	B	0	C	0	D	0
Series	43			4	1		7		024				A	2	B	0	C	0	D	0
Type	43			4	1		7		024				A	2	B	0	C	0	D	0
No. of poles	43			4	1		7		024				A	2	B	0	C	0	D	0
Coil version	43			4	1		7		024				A	2	B	0	C	0	D	0
Coil voltage	43			4	1		7		024				A	2	B	0	C	0	D	0

Series
 4 = P.C.B. - 3.2 mm pinning (for CO)
 P.C.B. - 5 mm pinning (for NO)

No. of poles
 1 = 1 pole, 10 A

Coil version
 7 = Sensitive DC

Coil voltage
 see coil specifications

A: Contact material
 2 = Standard AgCdO
 4 = AgSnO₂
 5 = AgNi + Au

B: Contact circuit
 0 = CO
 3 = NO

C: Options
 0 = None

D: Special versions
 0 = Flux proof (RT II)
 1 = Wash tight (RT III)

Only combinations in the same row are possible

Preferred versions

	coil version	A	B	C	D
43.41	sens. DC	2	0	0	0

All versions

	coil version	A	B	C	D
43.41	sens. DC	2 - 4 - 5	0 - 3	0	0 - 1

TECHNICAL DATA

INSULATION

INSULATION according to EN 61810-5	insulation rated voltage	V	250
	rated impulse withstand voltage	kV	4
	pollution degree		3
	overvoltage category		III

OTHER DATA

BOUNCE TIME: NO/NC	ms	3/6
VIBRATION RESISTANCE (10...55Hz): NO/NC	g/g	10/10
POWER LOST TO THE ENVIRONMENT	without contact current W	0.25
	with rated current W	1.3
RECOMMENDED DISTANCE between RELAYS mounted on P.C.B.s	mm	≥5

CONTACT SPECIFICATIONS

F 43

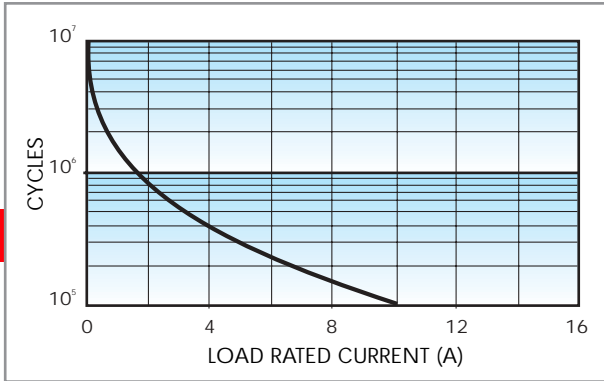

Electrical life vs AC1 load.

H 43

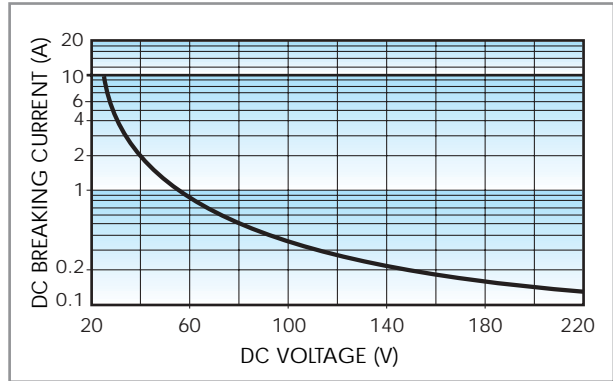

Breaking capacity in DC1 load.

- When switching a resistive load (DC1) having voltage and current values under the curve the expected electrical life is $\geq 100 \cdot 10^3$ cycles.
 - In case of DC13 loads the connection of a diode in parallel with the load will permit the same electrical life as for a DC1 load.
- Note:** the release time of load will be increase.

COIL SPECIFICATIONS

DC VERSION DATA

Nominal voltage U_N V	Coil code	Operating range		Resistance R Ω	Rated coil consumption I at U_N mA
		U_{min} V	U_{max} V		
3	7.003	2.2	4.5	36	83.5
6	7.006	4.2	9	150	40
9	7.009	6.5	13.5	324	27.7
12	7.012	8.4	18	580	20.7
18	7.018	13	27	1,296	13.8
24	7.024	16.8	36	2,200	10.9
36	7.036	25.2	54	5,184	6.9
48	7.048	33.6	72	9,200	5.2

R 43 DC

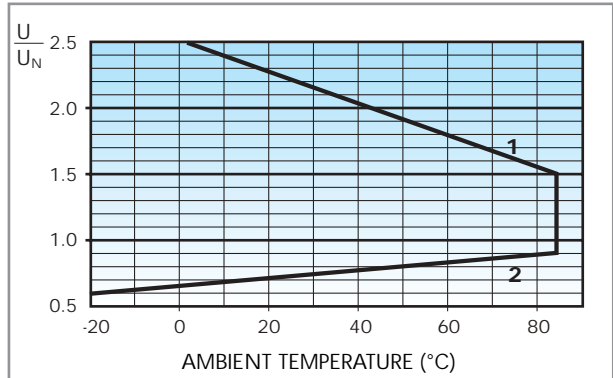

Operating range vs ambient temperature.

- 1 - Max coil voltage permitted.
- 2 - Min pick-up voltage with coil at ambient temperature.



Relay type	43.41	
Colour	BLUE	BLACK
P.C.B. socket (only for CO version)	95.23	95.23.0
retaining clip 095.43 supplied with socket packaging code SNA		
Metal retaining clip	095.43	

Approvals
(according to type):



- RATED VALUES: 10 A - 250 V
- INSULATION: ≥ 6 kV (1.2/50 μ s) between coil and contacts
- PROTECTION CATEGORY: IP 20
- AMBIENT TEMPERATURE: (-40...+70) $^{\circ}$ C

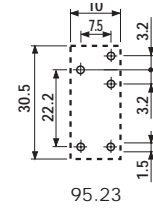
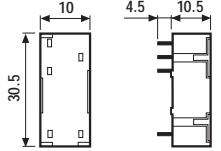

Copper side view

43

PACKAGING CODES

How to code and identify retaining clip and packaging options for sockets.

Code options according to the last three letters:

9 5 . 2 3 S N A

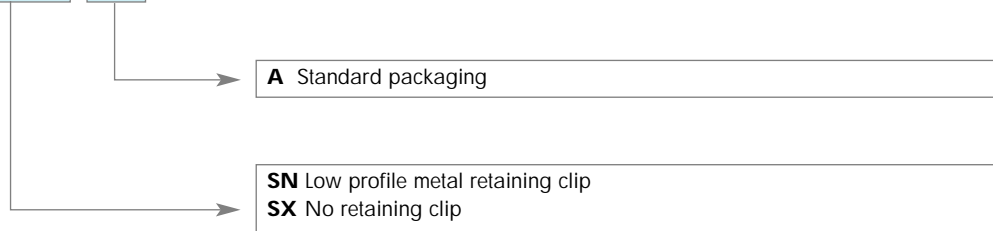

- DC and sensitive DC available
- 8 mm, 6 kV (1.2/50 μs) between coil and contacts
- Ambient temperature +85°C
- Sockets and accessories: see 95, 99 and 86 series

44

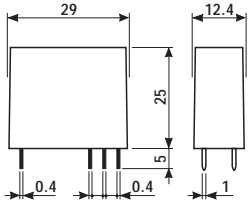

* For 400 V applications, where requirements for pollution degree 2 are met.

44.52

44.62



- 2 pole, 6 A
- 5 mm pinning
- P.C.B./ for use with 95 series sockets

- 2 pole, 10 A
- 5 mm pinning
- P.C.B./ for use with 95 series sockets

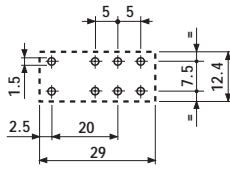
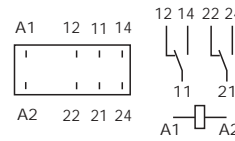
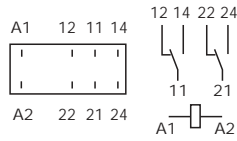

Copper side view

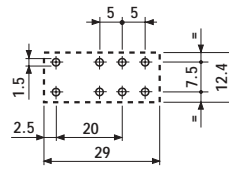

Copper side view

Contact specifications			
Contact configuration		2 CO	2 CO
Rated current/Maximum peak current	A	6/10	10/20
Rated voltage/Maximum switching voltage	V AC	250/400*	250/400*
Rated load in AC1	VA	1,500	2,500
Rated load in AC15 (230 VAC)	VA	250	500
Single phase motor rating (230 VAC)	kW	0.185	0.37
Breaking capacity in DC1: 30/110/220V	A	6/0.3/0.13	10/0.3/0.13
Minimum switching load	mW (V/mA)	300 (5/5)	300 (5/5)
Standard contact material		AgNi	AgNi
Coil specifications			
Nominal voltage (U _N)	V AC (50/60 Hz)	—	—
	V DC	6 · 9 · 12 · 14 · 24 · 28 · 48 · 60 · 110 · 125	
Rated power AC/DC/sens. DC	VA (50 Hz)/W	—/0.65/0.5	—/0.65/0.5
Operating range	AC	—	—
	DC/sens. DC	(0.73...1.5)U _N /(0.73...1.7)U _N	(0.73...1.5)U _N /(0.8...1.7)U _N
Holding voltage	AC/DC	—/0.4 U _N	—/0.4 U _N
Must drop-out voltage	AC/DC	—/0.1 U _N	—/0.1 U _N
Technical data			
Mechanical life AC/DC	cycles	—/20 · 10 ⁶	—/20 · 10 ⁶
Electrical life at rated load AC1	cycles	150 · 10 ³	100 · 10 ³
Operate/release time	ms	8/5 · (12/5 sens)	8/5 · (12/5 sens)
Insulation according to EN 61810-5		4 kV/3	4 kV/3
Insulation between coil and contacts (1.2/50μs)	kV	6 (8mm)	6 (8mm)
Dielectric strength between open contacts	V AC	1,000	1,000
Ambient temperature range	°C	-40...+85	-40...+85
Environmental protection		RT II	RT II
Approvals: (according to type)			

ORDERING INFORMATION

Example: a 44 series P.C.B. relay with 2 CO 10 A contacts, coil rated 24 V DC.

4	4	.	6	.	2	.	9	.	0	2	4	.	0	0	.	0	0	.	0	0
---	---	---	---	---	---	---	---	---	---	---	---	---	---	---	---	---	---	---	---	---

	A	B	C	D
--	----------	----------	----------	----------

Series ————

Type ————
 5 = P.C.B. - 5 mm pinning
 6 = P.C.B. - 5 mm pinning

No. of poles ————
 2 = 2 pole for
 44.52, 6 A
 44.62, 10 A

Coil version ————
 7 = Sensitive DC
 9 = DC

Coil voltage ————
 see coil specifications

A: Contact material
 0 = Standard AgNi
 4 = AgSnO₂
 for 44.62 only

B: Contact circuit
 0 = CO

C: Options
 0 = None

D: Special versions
 0 = Flux proof (RT II)

Only combinations in the same row are possible

Preferred versions

	coil version	A	B	C	D
44.52	DC - sens. DC	0	0	0	0
44.62	DC - sens. DC	0	0	0	0

All versions

	coil version	A	B	C	D
44.62	DC - sens. DC	0 - 4	0	0	0

TECHNICAL DATA

INSULATION

INSULATION according to EN 61810-5	insulation rated voltage	V	250
	rated impulse withstand voltage	kV	4
	pollution degree		3
	overvoltage category		III

IMMUNITY

CONDUCTED DISTURBANCE IMMUNITY	BURST (according to EN 61000-4-4) level 4 (4kV)
	SURGE (according to EN 61000-4-5) level 3 (2kV)

OTHER DATA

BOUNCE TIME: NO/NC	ms	4/4
VIBRATION RESISTANCE (10...55Hz): NO/NC	g/g	3/3
POWER LOST TO THE ENVIRONMENT	without contact current	W
	with rated current	W
	1.2 (44.52)	2.7 (44.62)
RECOMMENDED DISTANCE between RELAYS mounted on P.C.B.s	mm	≥5

CONTACT SPECIFICATIONS

F 44

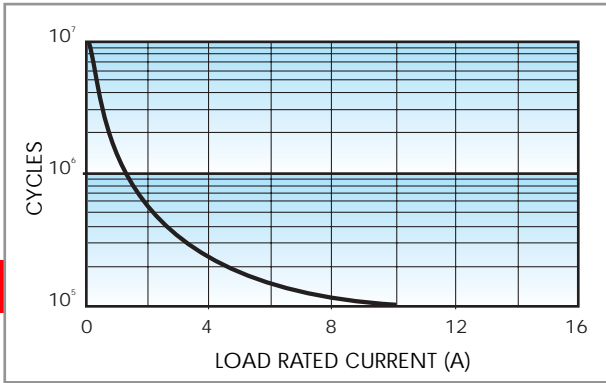

Electrical life vs AC1 load.

H 44

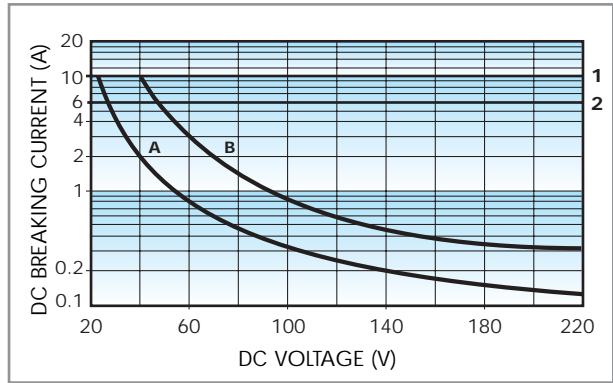

Breaking capacity for DC1 load.

- 1** - Type 44.62
- 2** - Type 44.52
- A** - Load applied to 1 contact
- B** - Load applied to 2 contacts in series

- When switching a resistive load (DC1) having voltage and current values under the curve the expected electrical life is $\geq 100 \cdot 10^3$ cycles.
- In case of DC13 loads the connection of a diode in parallel with the load will permit the same electrical life as for a DC1 load.
- Note:** the release time of load will be increase.

COIL SPECIFICATIONS

DC VERSION DATA (0.65 W standard)

Nominal voltage U_N V	Coil code	Operating range		Resistance R Ω	Rated coil consumption I at U_N mA
		U_{min} V	U_{max} V		
6	9.006	4.4	9	55	109
9	9.009	6.6	13.5	125	72
12	9.012	8.8	18	220	55
14	9.014	10.2	21	300	47
24	9.024	17.5	36	900	27
28	9.028	20.5	42	1,200	23
48	9.048	35	72	3,500	14
60	9.060	43.8	90	5,500	11
110	9.110	80.3	165	18,000	6.2
125	9.125	91.2	187.5	23,500	5.3

DC VERSION DATA (0.5 W sensitive)

Nominal voltage U_N V	Coil code	Operating range		Resistance R Ω	Rated coil consumption I at U_N mA
		U_{min}^* V	U_{max} V		
6	7.006	4.4	10.2	75	80
9	7.009	6.6	15.3	160	56
12	7.012	8.8	20.4	300	40
14	7.014	10.2	23.8	400	35
24	7.024	17.5	40.8	1,200	20
28	7.028	20.5	47.6	1,600	17.5
48	7.048	35	81.6	4,800	10
60	7.060	43.8	102	7,200	8.4
110	7.110	80.3	187	23,500	4.7
125	7.125	100	218.7	32,000	3.9

* $U_{min} = 0.8 U_N$ for 44.62

R 44 DC

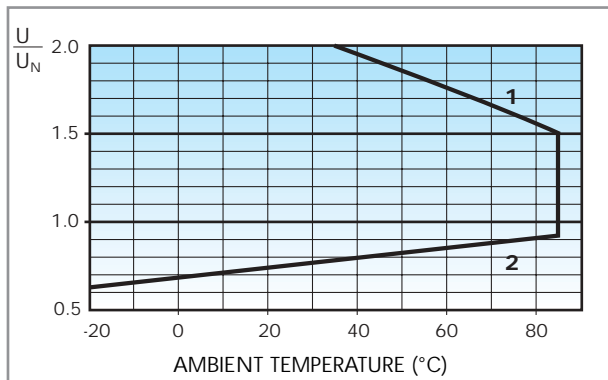

- Operating range (DC version) vs ambient temperature.
- 1** - Max coil voltage permitted.
 - 2** - Min pick-up voltage with coil at ambient temperature.

R 44 sens. DC

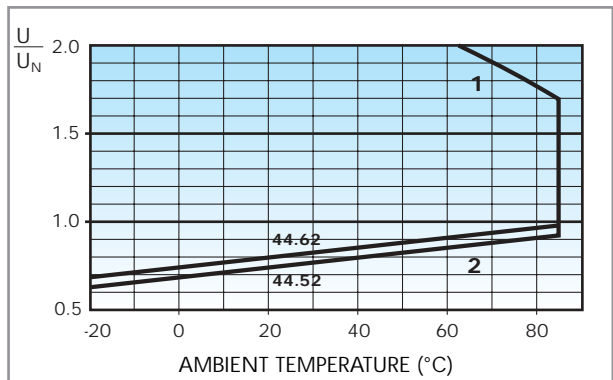

- Operating range (sensitive DC version) vs ambient temperature.
- 1** - Max coil voltage permitted.
 - 2** - Min pick-up voltage with coil at ambient temperature.



95.05

Approvals
(according to type):



095.01

- RATED VALUES: 10 A - 250 V
- INSULATION: ≥ 6 kV (1.2/50 μ s) between coil and contacts
- PROTECTION CATEGORY: IP 20
- AMBIENT TEMPERATURE: (-40...+70) °C
- SCREW TORQUE: 0.5 Nm
- WIRE STRIP LENGTH: 8 mm
- MAX WIRE SIZE:

	solid wire	stranded wire
mm ²	1x6 / 2x2.5	1x4 / 2x2.5
AWG	1x10 / 2x14	1x12 / 2x14

Relay type	44.52, 44.62	
Colour	BLUE	BLACK
Clamp terminal socket: panel or 35 mm rail (EN 50022) mount retaining clip 095.01 supplied with socket packaging code SPA	95.05	95.05.0
Retaining and release clip	095.01	095.01.0
Metal retaining clip	095.71	
8-way jumper link for 95.03 and 95.05 sockets	095.18	095.18.0
Identification tag	095.00.4	
Modules (see table below)	99.02	
Timer modules	86.10, 86.20	

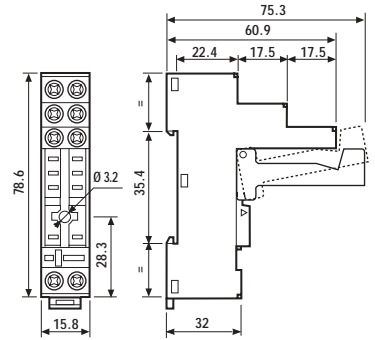

95.05

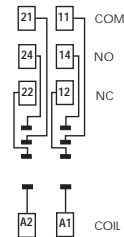

95.05

FOR 95.05 SOCKET:



095.18

8-way jumper link	095.18
--------------------------	--------

- RATED VALUES: 10 A - 250 V

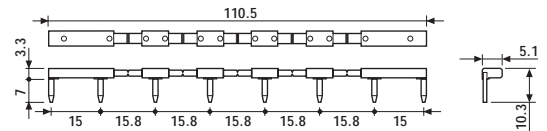

86.10

86 Series Module Timers (see technical data pages 126/131)	BLUE
Mono-function: 12...24 V AC/DC; function AI; (1.5s...60min)	86.10.0.024.0000
Mono-function: 12...24 V AC/DC; function DI; (1.5s...60min)	86.20.0.024.0000



99.02

Approvals
(according to type):



* Modules in Black housing are available on request.

**For DC supply, apply the positive to terminal A1.

99.02 coil indication and EMC suppression modules (see technical data page 179)		BLUE*
Diode** (+A1, standard polarity)	(6...220) V DC	99.02.3.000.00
LED	(6...24) V DC/AC	99.02.0.024.59
LED	(28...60) V DC/AC	99.02.0.060.59
LED	(110...240) V DC/AC	99.02.0.230.59
LED + Diode** (+A1, standard polarity)	(6...24) V DC	99.02.9.024.99
LED + Diode** (+A1, standard polarity)	(28...60) V DC	99.02.9.060.99
LED + Diode** (+A1, standard polarity)	(110...220) V DC	99.02.9.220.99
LED + Varistor	(6...24) V DC/AC	99.02.0.024.98
LED + Varistor	(28...60) V DC/AC	99.02.0.060.98
LED + Varistor	(110...240) V DC/AC	99.02.0.230.98
RC circuit	(6...24) V DC/AC	99.02.0.024.09
RC circuit	(28...60) V DC/AC	99.02.0.060.09
RC circuit	(110...240) V DC/AC	99.02.0.230.09
Residual current by-pass (62 k Ω /1W)	(110...240) V AC	99.02.8.230.07



95.85.3

Approvals
(according to type):



- RATED VALUES: 10 A - 250 V
with a current > 10 A, the contact terminal must be connected in parallel (21 with 11, 24 with 14, 22 with 12)
- INSULATION: ≥ 6 kV (1.2/50 μ s)
between coil and contacts
- PROTECTION CATEGORY: IP 20
- AMBIENT TEMPERATURE: (-40...+70) °C
- SCREW TORQUE: 0.5 Nm
- WIRE STRIP LENGTH: 7 mm
- MAX WIRE SIZE:

Relay type	44.52, 44.62	
Colour	BLUE	BLACK
Clamp terminal socket: panel or 35 mm rail (EN 50022) mount retaining clip 095.92 supplied with socket packaging code SPA	95.85.3	95.85.30
Metal retaining clip	095.71	
Plastic retaining clip	095.92	
8-way jumper link for 95.85.3 sockets	095.08	095.08.0
Modules (see table below)	99.80	

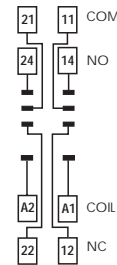
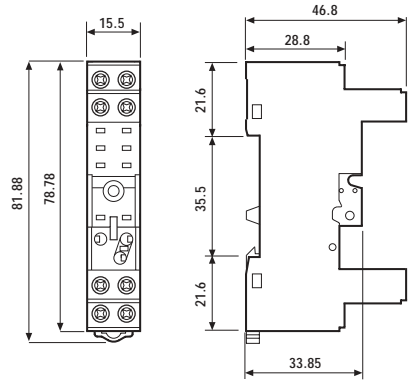

95.85.3

44

FOR 95.85.3 SOCKET:



095.08

8-way jumper link	095.08
--------------------------	--------

- RATED VALUES: 10 A - 250 V

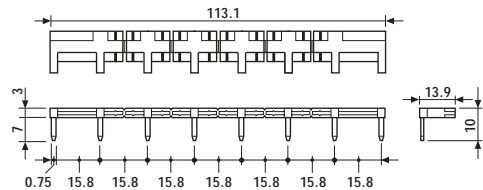

99.80

Approvals
(according to type):

GOST

* Modules in Black housing are available on request.

**For DC supply, apply the positive to terminal A1.

Green LED is standard.
Red LED available on request.

99.80 coil indication and EMC suppression modules (see technical data page 179)		BLUE*
Diode** (+A1, standard polarity)	(6...220) V DC	99.80.3.000.00
LED	(6...24) V DC/AC	99.80.0.024.59
LED	(28...60) V DC/AC	99.80.0.060.59
LED	(110...240) V DC/AC	99.80.0.230.59
LED + Diode** (+A1, standard polarity)	(6...24) V DC	99.80.9.024.99
LED + Diode** (+A1, standard polarity)	(28...60) V DC	99.80.9.060.99
LED + Diode** (+A1, standard polarity)	(110...220) V DC	99.80.9.220.99
LED + Varistor	(6...24) V DC/AC	99.80.0.024.98
LED + Varistor	(28...60) V DC/AC	99.80.0.060.98
LED + Varistor	(110...240) V DC/AC	99.80.0.230.98
RC circuit	(6...24) V DC/AC	99.80.0.024.09
RC circuit	(28...60) V DC/AC	99.80.0.060.09
RC circuit	(110...240) V DC/AC	99.80.0.230.09
No - remanence (62 k Ω /1W)	(110...240) V AC	99.80.8.230.07



95.15.2

Approvals
(according to type):



- RATED VALUES: 10 A - 250 V
- INSULATION: ≥ 6 kV (1.2/50 μ s) between coil and contacts
- PROTECTION CATEGORY: IP 20
- AMBIENT TEMPERATURE: (-40...+70) $^{\circ}$ C

Relay type	44.52, 44.62	
Colour	BLUE	BLACK
P.C.B. socket	95.15.2	95.15.20
retaining clip 095.51 supplied with socket with packaging code SMA		
Retaining clip		095.51
Plastic retaining clip		095.52

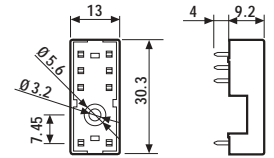

44

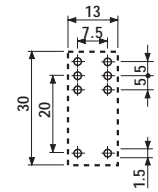

95.15.2

Copper side view

PACKAGING CODES

How to code and identify retaining clip and packaging options for sockets.

Code options according to the last three letters:

9 5 . 0 5 S P A

A Standard packaging

SM Metal retaining clip
SP Plastic retaining clip
SX No retaining clip

45.71

- Miniature P.C.B. Faston 250 connect relay
- Sensitive DC coil
- 8 mm, 6 kV (1.2/50 μs) between coil and contacts
- Ambient temperature +125°C
- NO contact or NC contact version



- 1 NO or 1 NC
- Max ambient temperature +125°C
- P.C.B. mounting + Faston 250

45

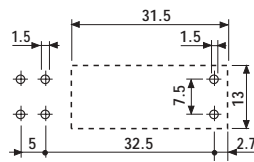
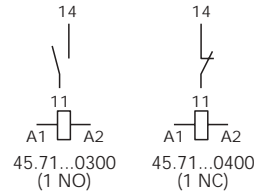
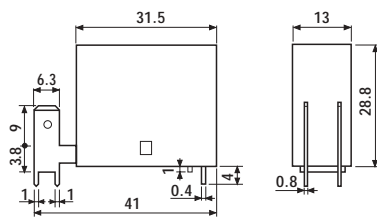

Copper side view

* For 400 V applications, where requirements for pollution degree 2 are met.

Contact specifications		
Contact configuration		1 NO or 1 NC
Rated current/Maximum peak current	A	16/30
Rated voltage/Maximum switching voltage	V AC	250/400*
Rated load in AC1	VA	4,000
Rated load in AC15 (230 VAC)	VA	750
Single phase motor rating (230 VAC)	kW	0.55
Breaking capacity in DC1: 30/110/220V	A	16/0.3/0.13
Minimum switching load	mW (V/mA)	500 (10/5)
Standard contact material		AgCdO
Coil specifications		
Nominal voltage (U _N)	V AC (50/60 Hz)	—
	V DC	6 · 12 · 24 · 48 · 60
Rated power AC/DC	VA (50 Hz)/W	—/0.36
Operating range	AC	—
	DC	(0.7...1.2)U _N
Holding voltage	AC/DC	—/0.4 U _N
Must drop-out voltage	AC/DC	—/0.1 U _N
Technical data		
Mechanical life AC/DC	cycles	—/30 · 10 ⁶
Electrical life at rated load AC1	cycles	100 · 10 ³
Operate/release time	ms	10/2
Insulation according to EN 61810-5		4 kV/3
Insulation between coil and contacts (1.2/50μs)	kV	6 (8mm)
Dielectric strength between open contacts	V AC	1,000
Ambient temperature range	°C	-40...+125
Environmental protection		RT II
Approvals: (according to type)		GOST

ORDERING INFORMATION

Example: a 45 series for P.C.B. relay + Faston 250, 1 NO contact, coil rated 12 V DC.

4

5

.

7

.

1

.

7

.

0

1

2

.

0

3

0

0

Series ————

Type ————
7 = P.C.B.

No. of poles ————
1 = 1 pole, 16 A

Coil version ————
7 = Sensitive DC

Coil voltage ————
see coil specifications

A: Contact material
0 = Standard AgCdO

B: Contact circuit
3 = NO
4 = NC

C: Options
0 = None

D: Special versions
0 = Flux proof (RT II)

Only combinations in the same row are possible

All versions

	coil version	A	B	C	D
45.71	sens. DC	0	3 - 4	0	0

TECHNICAL DATA

INSULATION

INSULATION according to EN 61810-5	insulation rated voltage	V	250
	rated impulse withstand voltage	kV	4
	pollution degree		3
	overvoltage category		III

OTHER DATA

BOUNCE TIME: NO/NC	ms	3/- (1 NO version)	-/-3 (1 NC version)
VIBRATION RESISTANCE (10...55Hz): NO/NC	g/g	10/10	
POWER LOST TO THE ENVIRONMENT	without contact current	W	0.4
	with rated current	W	1.8
RECOMMENDED DISTANCE between RELAYS mounted on P.C.B.s	mm	!5	

CONTACT SPECIFICATIONS

F 45

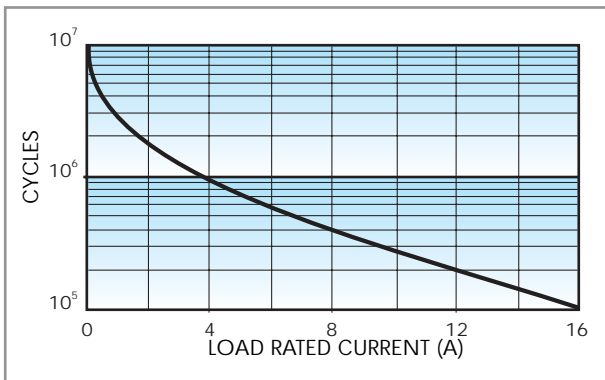

Electrical life AC1 load (+85°C)

H 45

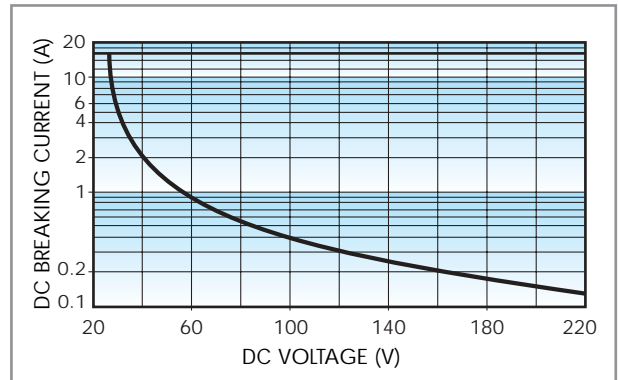

Breaking capacity for DC1 load.

- When switching a resistive load (DC1) having voltage and current values under the curve the expected electrical life is ! 100·10³ cycles.
 - In case of DC13 loads the connection of a diode in parallel with the load will permit the same electrical life as for a DC1 load.
- Note:** the release time of load will be increase.

COIL SPECIFICATIONS

DC VERSION DATA (0.36 W sensitive)

Nominal voltage U_N V	Coil code	Operating range		Resistance R Ω	Rated coil consumption I at U_N mA
		U_{min} V	U_{max} V		
6	7.006	4.2	7.2	100	60
12	7.012	8.4	14.4	400	30
24	7.024	16.8	28.8	1,600	15
48	7.048	33.6	57.6	6,400	7.5
60	7.060	42	72	10,000	6

45

R 45.71 DC

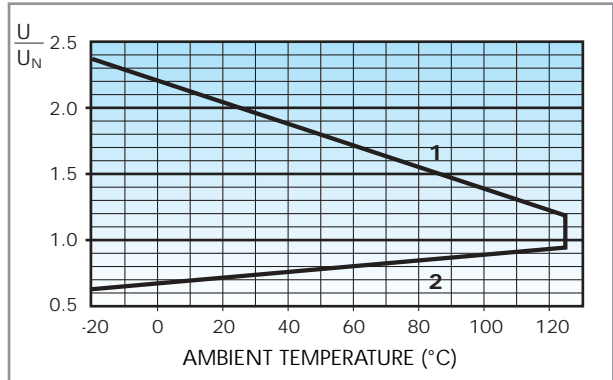

Operating range vs ambient temperature.

1 - Max coil voltage permitted.





2 - Min pick-up voltage with coil at ambient temperature.

- P.C.B. versions
- AC or DC coils
- Lockable test button and mechanical flag indicator as standard on 2 and 4 CO relays types
- Sockets and accessories: see 94, 99 and 86 series
- RT III (wash tight) version available

	55.12	55.13	55.14
	- 2 pole, 10 A - P.C.B. mounting	- 3 pole, 10 A - P.C.B. mounting	- 4 pole, 7 A - P.C.B. mounting
	Copper side view h = 35.8 mm	Copper side view h = 35.8 mm	Copper side view h = 35.8 mm
Contact specifications			
Contact configuration	2 CO	3 CO	4 CO
Rated current/Maximum peak current A	10/20	10/20	7/15
Rated voltage/Maximum switching voltage V AC	250/400	250/400	250/250
Rated load in AC1 VA	2,500	2,500	1,750
Rated load in AC15 (230 VAC) VA	500	500	350
Single phase motor rating (230 VAC) kW	0.37	0.37	0.125
Breaking capacity in DC1: 30/110/220V A	10/0.25/0.12	10/0.25/0.12	7/0.25/0.12
Minimum switching load mW (V/mA)	300 (5/5)	300 (5/5)	300 (5/5)
Standard contact material	AgNi	AgNi	AgNi
Coil specifications			
Nominal voltage (U _N) V AC (50/60 Hz)	6 - 12 - 24 - 48 - 60 - 110 - 120 - 230 - 240		
V DC	6 - 12 - 24 - 48 - 60 - 110 - 125 - 220		
Rated power AC/DC VA (50 Hz)/W	1.5/1	1.5/1	1.5/1
Operating range AC	(0.8...1.1)U _N	(0.8...1.1)U _N	(0.8...1.1)U _N
DC	(0.8...1.1)U _N	(0.8...1.1)U _N	(0.8...1.1)U _N
Holding voltage AC/DC	0.8 U _N /0.5 U _N	0.8 U _N /0.5 U _N	0.8 U _N /0.5 U _N
Must drop-out voltage AC/DC	0.2 U _N /0.1 U _N	0.2 U _N /0.1 U _N	0.2 U _N /0.1 U _N
Technical data			
Mechanical life AC/DC cycles	20 · 10 ⁶ /50 · 10 ⁶	20 · 10 ⁶ /50 · 10 ⁶	20 · 10 ⁶ /50 · 10 ⁶
Electrical life at rated load AC1 cycles	200 · 10 ³	200 · 10 ³	150 · 10 ³
Operate/release time ms	9/3	9/3	9/3
Insulation according to EN 61810-5	3.6 kV/2	3.6 kV/2	2.5 kV/2
Insulation between coil and contacts (1.2/50µs) kV	3.6	3.6	3.6
Dielectric strength between open contacts V AC	1,000	1,000	1,000
Ambient temperature range °C	-40...+85	-40...+85	-40...+85
Environmental protection	RT I	RT I	RT I
Approvals: (according to type)			

- Plug-in versions
- AC or DC coils
- Lockable test button and mechanical flag indicator as standard on 2 and 4 CO relays types
- Sockets and accessories: see 94, 99 and 86 series

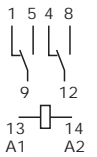
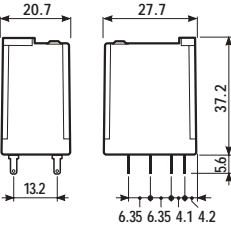
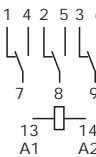
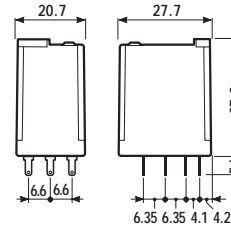
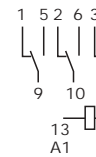
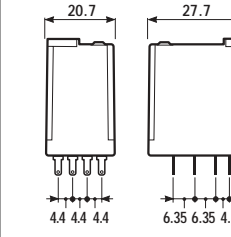
55

	55.32	55.33	55.34
			
	- 2 pole, 10 A - Plug-in for use with 94 Series sockets	- 3 pole, 10 A - Plug-in for use with 94 Series sockets	- 4 pole, 7 A - Plug-in for use with 94 Series sockets
	 	 	 
Contact specifications			
Contact configuration	2 CO	3 CO	4 CO
Rated current/Maximum peak current	A 10/20	A 10/20	A 7/15
Rated voltage/Maximum switching voltage	V AC 250/400	V AC 250/400	V AC 250/250
Rated load in AC1	VA 2,500	VA 2,500	VA 1,750
Rated load in AC15 (230 VAC)	VA 500	VA 500	VA 350
Single phase motor rating (230 VAC)	kW 0.37	kW 0.37	kW 0.125
Breaking capacity in DC1: 30/110/220V	A 10/0.25/0.12	A 10/0.25/0.12	A 7/0.25/0.12
Minimum switching load	mW (V/mA) 300 (5/5)	mW (V/mA) 300 (5/5)	mW (V/mA) 300 (5/5)
Standard contact material	AgNi	AgNi	AgNi
Coil specifications			
Nominal voltage (U _N)	V AC (50/60 Hz)	6 - 12 - 24 - 48 - 60 - 110 - 120 - 230 - 240	
	V DC	6 - 12 - 24 - 48 - 60 - 110 - 125 - 220	
Rated power AC/DC	VA (50 Hz)/W 1.5/1	VA (50 Hz)/W 1.5/1	VA (50 Hz)/W 1.5/1
Operating range	AC	(0.8...1.1)U _N	(0.8...1.1)U _N
	DC	(0.8...1.1)U _N	(0.8...1.1)U _N
Holding voltage	AC/DC 0.8 U _N /0.5 U _N	AC/DC 0.8 U _N /0.5 U _N	AC/DC 0.8 U _N /0.5 U _N
Must drop-out voltage	AC/DC 0.2 U _N /0.1 U _N	AC/DC 0.2 U _N /0.1 U _N	AC/DC 0.2 U _N /0.1 U _N
Technical data			
Mechanical life AC/DC	cycles 20 · 10 ⁶ /50 · 10 ⁶	cycles 20 · 10 ⁶ /50 · 10 ⁶	cycles 20 · 10 ⁶ /50 · 10 ⁶
Electrical life at rated load AC1	cycles 200 · 10 ³	cycles 200 · 10 ³	cycles 150 · 10 ³
Operate/release time	ms 9/3	ms 9/3	ms 9/3
Insulation according to EN 61810-5	3.6 kV/2	3.6 kV/2	2.5 kV/2
Insulation between coil and contacts (1.2/50μs)	kV 3.6	kV 3.6	kV 3.6
Dielectric strength between open contacts	V AC 1,000	V AC 1,000	V AC 1,000
Ambient temperature range	°C -40...+85	°C -40...+85	°C -40...+85
Environmental protection	RT I	RT I	RT I
Approvals: (according to type)			

ORDERING INFORMATION

Example: a 55 series plug-in relay, 4 CO contacts, coil rated 12 V DC with a lockable test button and mechanical indicator.

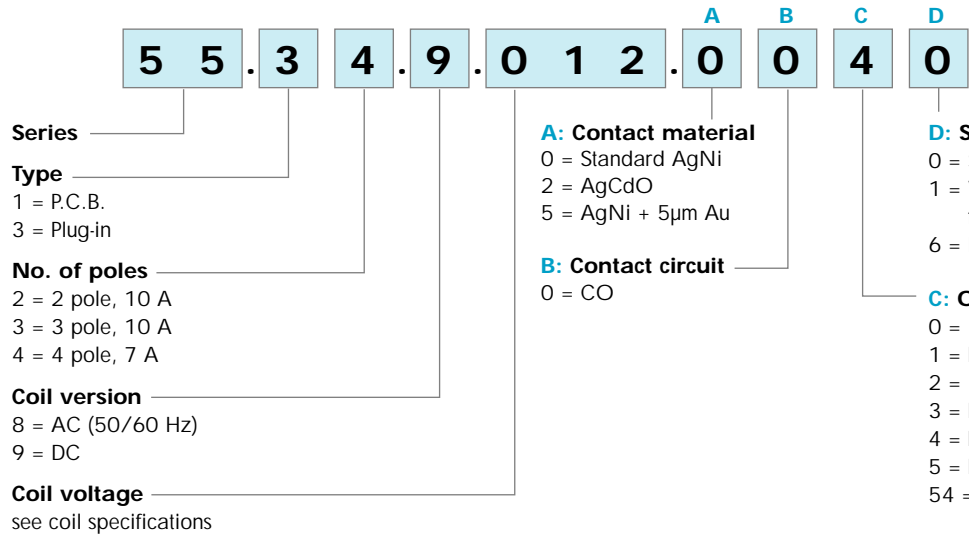

Only combinations in the same row are possible

Preferred versions

	coil version	A	B	C	D
55.32/34	AC/DC	0	0	4	0
55.12/13/14	AC/DC	0	0	0	0
55.33	AC/DC	0	0	0	0

All versions

	coil version	A	B	C	D
55.32/34	AC/DC	0 - 2 - 5	0	0	0 - 6
	AC	0 - 2 - 5	0	2 - 3 - 4 - 5	0 - 6
	AC	0 - 2 - 5	0	54	/
	DC	0 - 2 - 5	0	2 - 4 - 6 - 7 - 8 - 9	0 - 6
	DC	0 - 2 - 5	0	74 - 94	/
55.33	AC/DC	0 - 2 - 5	0	0	0 - 6
	AC	0 - 2 - 5	0	1 - 3 - 5	0 - 6
	DC	0 - 2 - 5	0	1 - 6 - 7 - 8 - 9	0 - 6
55.12/13/14	AC/DC	0 - 2 - 5	0	0	0 - 1

POSSIBLE OPTIONS

AC

Option = 0030
0050
0054

DC - Not polarized

Option = 0060
0070
0074

DC - Standard polarity

Option = 0080
0090
0094

Option = 0006
REAR FLANGE MOUNT



LOCKABLE TEST BUTTON AND MECHANICAL FLAG INDICATOR (0040)

The dual-purpose Finder test button can be used in two ways:

Case 1) The plastic pip (located directly above the test button) remains intact. In this case, when the test button is pushed, the contacts operate. When the test button is released the contacts return to their former state.

Case 2) The plastic pip is broken-off (using an appropriate cutting tool). In this case, (in addition to the above function), when the test button is pushed and rotated, the contacts are latched in the operating state, and remain so until the test button is rotated back to its former position.

In both cases ensure that the test button actuation is swift and decisive.

ACCESSORIES



Adaptor with top mount flange (for 55.32/33/34)	055.05
--	--------

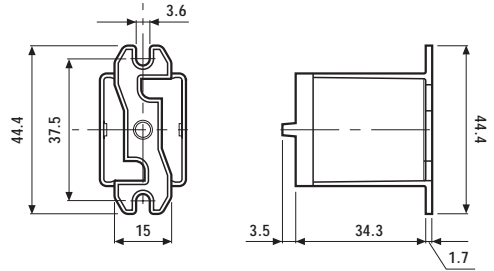

TECHNICAL DATA

55

INSULATION

INSULATION according to EN 61810-5	insulation rated voltage	V	400 (2-3 pole)	250 (4 pole)
	rated impulse withstand voltage	kV	3.6 (2-3 pole)	2.5 (4 pole)
	pollution degree		2	
	overvoltage category		III	

IMMUNITY

CONDUCTED DISTURBANCE IMMUNITY	BURST (according to EN 61000-4-4) level 4 (4 kV)
	SURGE (according to EN 61000-4-5) level 4 (4 kV)

OTHER DATA

BOUNCE TIME: NO/NC	ms	1/4		
VIBRATION RESISTANCE (10...55Hz): NO/NC	g/g	6/6		
POWER LOST TO THE ENVIRONMENT		2 CO	3 CO	4 CO
	- without contact current W	1	1	1
	- with rated current W	3	4	3
RECOMMENDED DISTANCE between RELAYS mounted on P.C.B.s	mm	≥5		

CONTACT SPECIFICATIONS

F 55

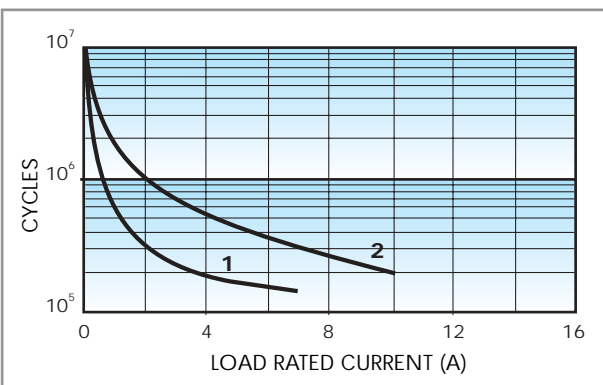

Electrical life vs AC1 load.

1 = 4 CO relay type (7 A).

2 = 2 - 3 CO relay type (10 A).

H 55

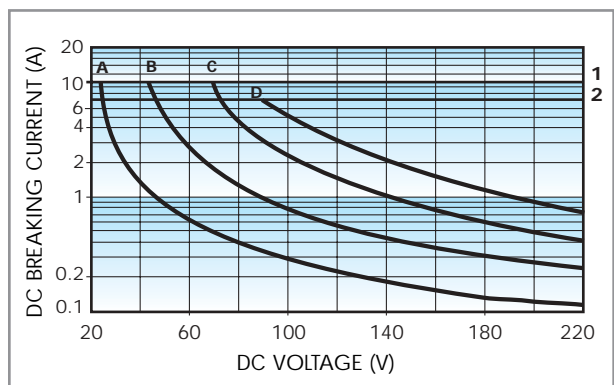

Breaking capacity for DC1 load.

1 = 2 - 3 CO type.

2 = 4 CO type.

A = Load applied to 1 contact

B = Load applied to 2 contacts in series

C = Load applied to 3 contacts in series

D = Load applied to 4 contacts in series

- When switching a resistive load (DC1) having voltage and current values under the curve the expected electrical life is $\geq 100 \cdot 10^3$ cycles.

- In case of DC13 loads the connection of a diode in parallel with the load will permit the same electrical life as for a DC1 load.

Note: the release time of load will be increase.

COIL SPECIFICATIONS

DC VERSION DATA

Nominal voltage U_N V	Coil code	Operating range		Resistance R Ω	Rated coil consumption I at U_N mA
		U_{min} V	U_{max} V		
6	9.006	4.8	6.6	40	150
12	9.012	9.6	13.2	140	86
24	9.024	19.2	26.4	600	40
48	9.048	38.4	52.8	2,400	20
60	9.060	48	66	4,000	15
110	9.110	88	121	12,500	8.8
125	9.125	100	137.5	17,300	7.2
220	9.220	176	242	54,000	4

AC VERSION DATA

Nominal voltage U_N V	Coil code	Operating range		Resistance R Ω	Rated coil consumption I at U_N (50Hz) mA
		U_{min} V	U_{max} V		
6	8.006	4.8	6.6	12	200
12	8.012	9.6	13.2	50	97
24	8.024	19.2	26.4	190	53
48	8.048	38.4	52.8	770	25
60	8.060	48	66	1,200	21
110	8.110	88	121	4,000	12.5
120	8.120	96	132	4,700	12
230	8.230	184	253	17,000	6
240	8.240	192	264	19,100	5.3

R 55 DC

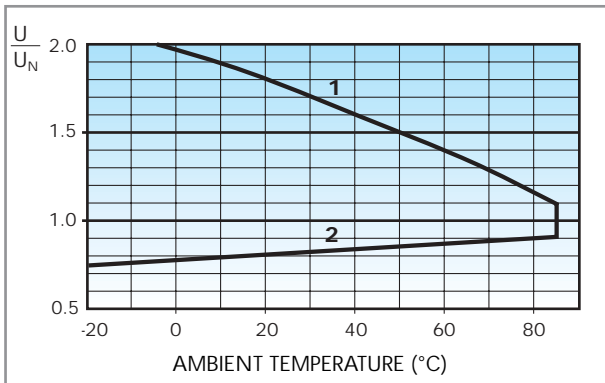

Operating range (DC type) vs ambient temperature.

- 1 - Max coil voltage permitted.
- 2 - Min pick-up voltage with coil at ambient temperature.

R 55 AC

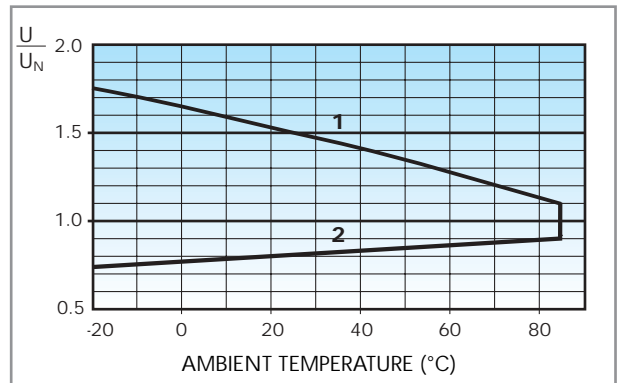

Operating range (AC type) vs ambient temperature.

- 1 - Max coil voltage permitted.
- 2 - Min pick-up voltage with coil at ambient temperature.



94.04

Approvals
(according to type):



- RATED VALUES: 10 A - 250 V
- DIELECTRIC STRENGTH: ≥ 2 kV AC
- PROTECTION CATEGORY: IP 20
- AMBIENT TEMPERATURE: (-40...+70)°C
- SCREW TORQUE: 0.5 Nm
- WIRE STRIP LENGTH: 8 mm
- MAX WIRE SIZE:

Relay type	55.32		55.33		55.32, 55.34	
Colour	BLUE	BLACK	BLUE	BLACK	BLUE	BLACK
Clamp terminal socket: panel or 35 mm rail (EN 50022) mount retaining clip 094.71 supplied with socket packaging code SMA	94.02	94.02.0	94.03	94.03.0	94.04	94.04.0
Metal retaining clip	094.71					
Plastic retaining and release clip	094.01					
6-way jumper link for 94.02, 94.03 and 94.04 sockets	094.06	094.06.0	094.06	094.06.0	094.06	094.06.0
Identification tag	094.00.4					
Modules (see table below)	99.02					
Timer modules	86.10, 86.20					
Sheet of marker tags for retaining and release clip 094.01	060.72					

	solid wire	stranded wire
mm ²	1x6 / 2x2.5	1x4 / 2x2.5
AWG	1x10 / 2x14	1x12 / 2x14

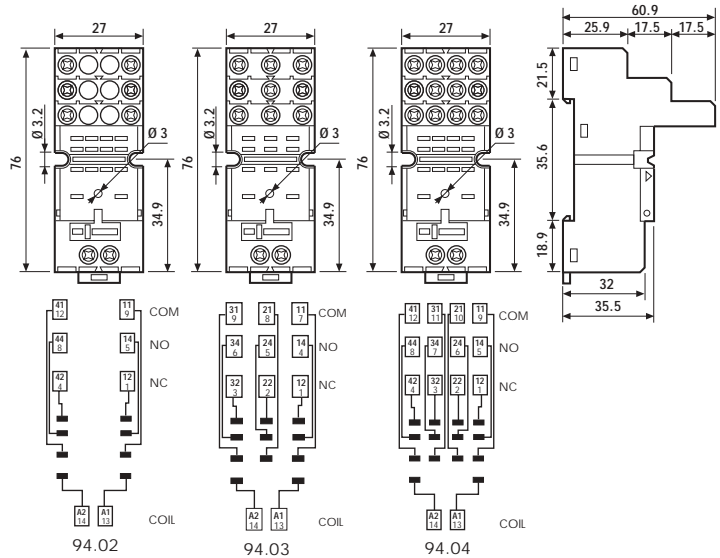

094.01

FOR 94.02, 94.03 AND 94.04 SOCKETS:



094.06

6-way jumper link	094.06
--------------------------	--------

- RATED VALUES: 10 A - 250 V

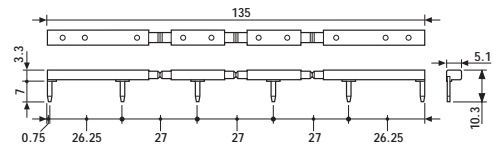

86.10

86 Series Module Timers (see technical data pages 126/131)	BLUE
Mono-function: 12...24 V AC/DC; function AI; (1.5s...60min)	86.10.0.024.0000
Mono-function: 12...24 V AC/DC; function DI; (1.5s...60min)	86.20.0.024.0000



99.02

99.02 coil indication and EMC suppression modules (see technical data page 179)		BLUE*
Diode** (+A1, standard polarity)	(6...220) V DC	99.02.3.000.00
Diode (+A2, non standard polarity)	(6...220) V DC	99.02.2.000.00
LED	(6...24) V DC/AC	99.02.0.024.59
LED	(28...60) V DC/AC	99.02.0.060.59
LED	(110...240) V DC/AC	99.02.0.230.59
LED + Diode** (+A1, standard polarity)	(6...24) V DC	99.02.9.024.99
LED + Diode** (+A1, standard polarity)	(28...60) V DC	99.02.9.060.99
LED + Diode** (+A1, standard polarity)	(110...220) V DC	99.02.9.220.99
LED + Diode (+A2, non standard polarity)	(6...24) V DC	99.02.9.024.79
LED + Diode (+A2, non standard polarity)	(28...60) V DC	99.02.9.060.79
LED + Diode (+A2, non standard polarity)	(110...220) V DC	99.02.9.220.79
LED + Varistor	(6...24) V DC/AC	99.02.0.024.98
LED + Varistor	(28...60) V DC/AC	99.02.0.060.98
LED + Varistor	(110...240) V DC/AC	99.02.0.230.98
RC circuit	(6...24) V DC/AC	99.02.0.024.09
RC circuit	(28...60) V DC/AC	99.02.0.060.09
RC circuit	(110...240) V DC/AC	99.02.0.230.09
Residual current by-pass (62 kΩ/1W)	(110...240) V AC	99.02.8.230.07

Approvals
(according to type):

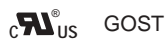

* Modules in Black housing are available on request.

**For DC supply, apply the positive to terminal A1.



94.74

Relay type	55.32		55.33		55.32, 55.34	
	BLUE	BLACK	BLUE	BLACK	BLUE	BLACK
Colour	BLUE	BLACK	BLUE	BLACK	BLUE	BLACK
Screw terminal socket: panel or 35 mm rail (EN 50022) mount retaining clip 094.71 supplied with socket packaging code SMA	94.72	94.72.0	94.73	94.73.0	94.74	94.74.0
Retaining clip	094.71					
Modules (see table below)	99.01					

Approvals
(according to type):



- RATED VALUES: 10 A - 250 V
- DIELECTRIC STRENGTH: ≥ 2 kV AC
- PROTECTION CATEGORY: IP 20
- AMBIENT TEMPERATURE: (-40...+70)°C
- SCREW TORQUE: 0.5 Nm
- WIRE STRIP LENGTH: 8 mm
- MAX WIRE SIZE:

	solid wire	stranded wire
mm ²	1x2.5 / 2x1.5	1x2.5 / 2x1.5
AWG	1x14 / 2x16	1x14 / 2x16

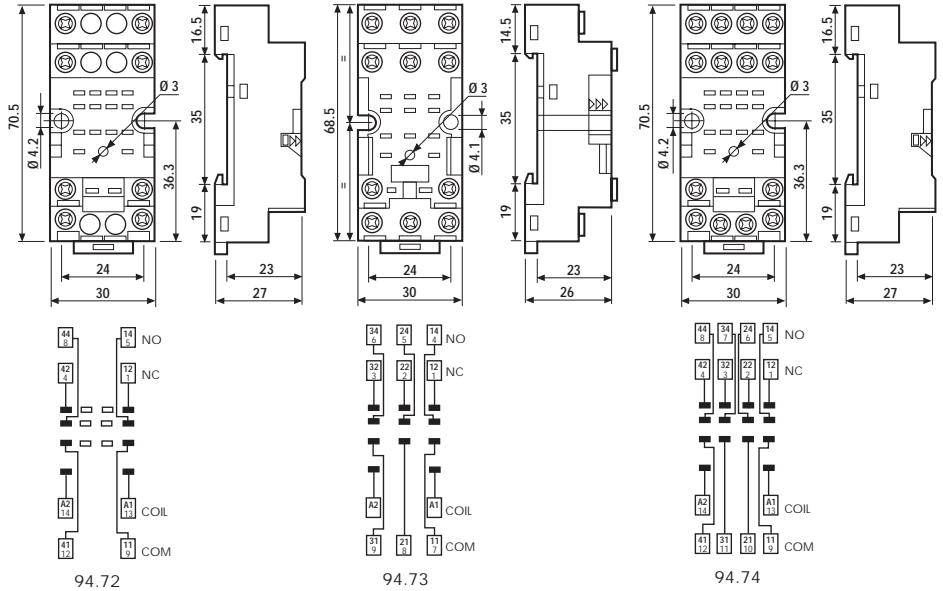

94.82

Relay type	55.32	
	BLUE	BLACK
Colour	BLUE	BLACK
Screw terminal socket: panel or 35 mm rail (EN 50022) mount retaining clip 094.71 supplied with socket packaging code SMA	94.82	94.82.0
Retaining clip	094.71	
Modules (see table below)	99.01	

Approvals
(according to type):



- RATED VALUES: 10 A - 250 V
- DIELECTRIC STRENGTH: ≥ 2 kV AC
- PROTECTION CATEGORY: IP 20
- AMBIENT TEMPERATURE: (-40...+70)°C
- SCREW TORQUE: 0.5 Nm
- WIRE STRIP LENGTH: 9 mm
- MAX WIRE SIZE:

	solid wire	stranded wire
mm ²	1x2.5 / 2x1.5	1x2.5 / 2x1.5
AWG	1x14 / 2x16	1x14 / 2x16

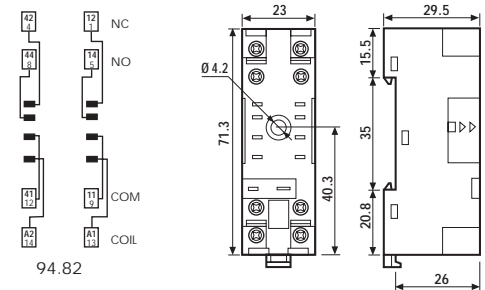

FOR 94.72, 94.73, 94.74 AND 94.82 SOCKETS:



99.01

Approvals
(according to type):

GOST

* Modules in Black housing are available on request.

** For DC supply, apply the positive to terminal A1.

Green LED is standard. Red LED available on request.

99.01 coil indication and EMC suppression modules (see technical data pag. 179)		BLUE*
Diode** (+A1, standard polarity)	(6...220) V DC	99.01.3.000.00
Diode (+A2, non standard polarity)	(6...220) V DC	99.01.2.000.00
LED	(6...24) V DC/AC	99.01.0.024.59
LED	(28...60) V DC/AC	99.01.0.060.59
LED	(110...240) V DC/AC	99.01.0.230.59
LED + Diode** (+A1, standard polarity)	(6...24) V DC	99.01.9.024.99
LED + Diode** (+A1, standard polarity)	(28...60) V DC	99.01.9.060.99
LED + Diode** (+A1, standard polarity)	(110...220) V DC	99.01.9.220.99
LED + Diode (+A2, non standard polarity)	(6...24) V DC	99.01.9.024.79
LED + Diode (+A2, non standard polarity)	(28...60) V DC	99.01.9.060.79
LED + Diode (+A2, non standard polarity)	(110...220) V DC	99.01.9.220.79
LED + Varistor	(6...24) V DC/AC	99.01.0.024.98
LED + Varistor	(28...60) V DC/AC	99.01.0.060.98
LED + Varistor	(110...240) V DC/AC	99.01.0.230.98
RC circuit	(6...24) V DC/AC	99.01.0.024.09
RC circuit	(28...60) V DC/AC	99.01.0.060.09
RC circuit	(110...240) V DC/AC	99.01.0.230.09
Residual current by-pass (62 k Ω /1W)	(110...240) V AC	99.01.8.230.07



94.84.3

Approvals
(according to type):



- RATED VALUES: 10 A - 250 V
- DIELECTRIC STRENGTH: ≥ 2 kV AC
- PROTECTION CATEGORY: IP 20
- AMBIENT TEMPERATURE: (-40...+70)°C
- SCREW TORQUE: 0.5 Nm
- WIRE STRIP LENGTH: 7 mm
- MAX WIRE SIZE:

Relay type	55.32		55.32, 55.34	
	BLUE	BLACK	BLUE	BLACK
Colour	BLUE	BLACK	BLUE	BLACK
Clamp terminal socket: panel or 35 mm rail (EN 50022) mount retaining clip 094.71 supplied with socket packaging code SMA	94.82.3	94.82.30	94.84.3	94.84.30
Retaining clip	094.71			
Plastic retaining and release clip	094.91.3			
Identification tag	094.80.2			
Modules (see table below)	99.80			

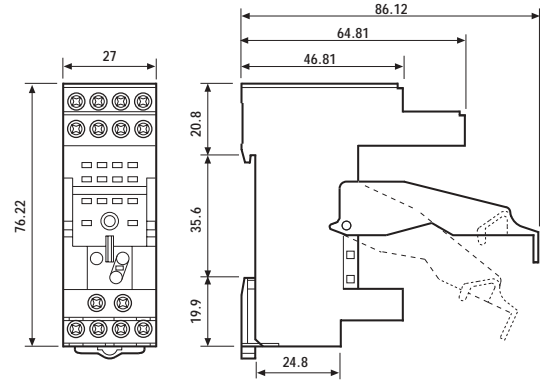
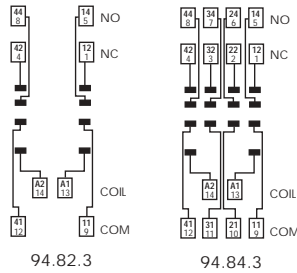

55

	solid wire	stranded wire
mm ²	1x6 / 2x2.5	1x4 / 2x2.5
AWG	1x10 / 2x14	1x12 / 2x14



94.54.1

Approvals
(according to type):



- RATED VALUES: 10 A - 250 V
- DIELECTRIC STRENGTH: ≥ 2 kV AC
- PROTECTION CATEGORY: IP 20
- AMBIENT TEMPERATURE: (-25...+70)°C
- WIRE STRIP LENGTH: 7 mm
- MAX WIRE SIZE:

Relay type	55.32, 55.34	
	BLUE	BLACK
Colour	BLUE	BLACK
Screwless terminal socket: 35 mm rail (EN 50022) mount retaining clip 094.91 supplied with socket packaging code SPA	94.54.1	94.54.10
Retaining clip	094.71	
Plastic retaining and release clip	094.91	
Identification tag	—	
Modules (see table below)	99.80	

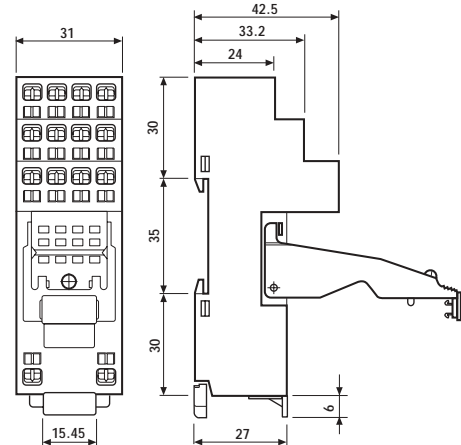
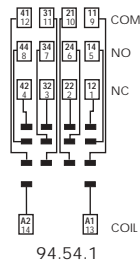

	solid wire	stranded wire
mm ²	2x(0.2...1.5)	2x(0.2...1.5)
AWG	2x(24...18)	2x(24...18)

FOR 94.82.3, 94.84.3 AND 94.54.1 SOCKETS:



99.80

Approvals
(according to type):

GOST

* Modules in Black housing are available on request.

**For DC supply, apply the positive to terminal A1.

Green LED is standard.
Red LED available on request.

99.80 coil indication and EMC suppression modules (see technical data page 179)		BLUE*
Diode** (+A1, standard polarity)	(6...220) V DC	99.80.3.000.00
LED	(6...24) V DC/AC	99.80.0.024.59
LED	(28...60) V DC/AC	99.80.0.060.59
LED	(110...240) V DC/AC	99.80.0.230.59
LED + Diode** (+A1, standard polarity)	(6...24) V DC	99.80.9.024.99
LED + Diode** (+A1, standard polarity)	(28...60) V DC	99.80.9.060.99
LED + Diode** (+A1, standard polarity)	(110...220) V DC	99.80.9.220.99
LED + Varistor	(6...24) V DC/AC	99.80.0.024.98
LED + Varistor	(28...60) V DC/AC	99.80.0.060.98
LED + Varistor	(110...240) V DC/AC	99.80.0.230.98
RC circuit	(6...24) V DC/AC	99.80.0.024.09
RC circuit	(28...60) V DC/AC	99.80.0.060.09
RC circuit	(110...240) V DC/AC	99.80.0.230.09
Residual current by-pass (62 kΩ/1W)	(110...240) V AC	99.80.8.230.07



Relay type	55.32		55.33		55.32, 55.34	
Colour	BLUE	BLACK	BLUE	BLACK	BLUE	BLACK
P.C.B. socket	94.12	94.12.0	94.13	94.13.0	94.14	94.14.0
retaining clip 094.51 supplied with socket packaging code SMA						
Metal retaining clip	094.51					

Approvals
(according to type):



- RATED VALUES: 10 A - 250 V
- DIELECTRIC STRENGTH: ≥ 2 kV AC
- AMBIENT TEMPERATURE: (-40...+70)°C

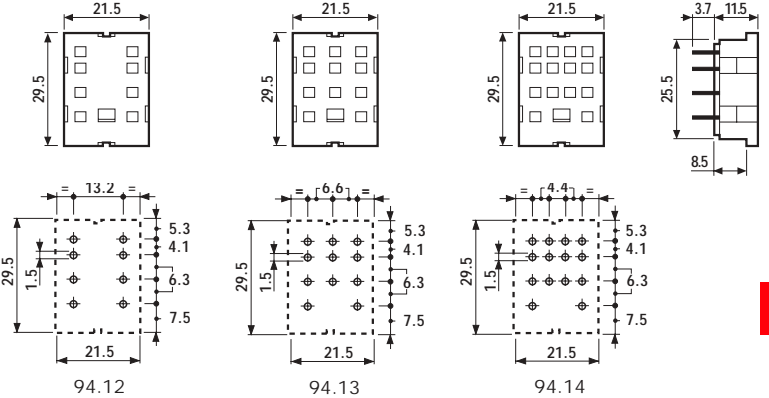

Copper side view

55



Relay type	55.32		55.33		55.32, 55.34	
Colour	BLUE	BLACK	BLUE	BLACK	BLUE	BLACK
Panel mount solder socket: 1 mm thick panel	94.22	94.22.0	94.23	94.23.0	94.24	94.24.0
retaining clip 094.51 supplied with socket packaging code SMA						
Metal retaining clip	094.51					

Approvals
(according to type):



- RATED VALUES: 10 A - 250 V
- DIELECTRIC STRENGTH: ≥ 2 kV AC
- AMBIENT TEMPERATURE: (-40...+70)°C

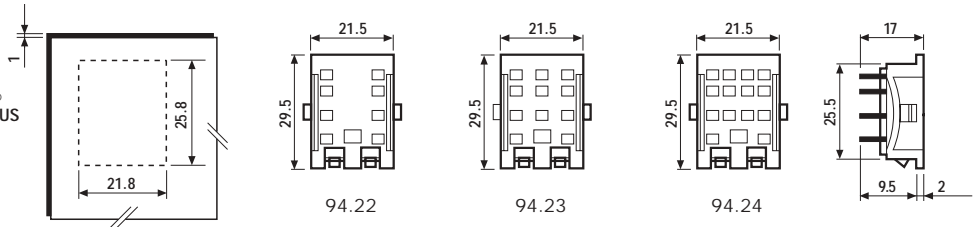

Relay type	55.32		55.33		55.32, 55.34	
Colour	BLUE	BLACK	BLUE	BLACK	BLUE	BLACK
Panel mount socket: M3 screw mount - solder connections	94.32	94.32.0	94.33	94.33.0	94.34	94.34.0
retaining clip 094.51 supplied with socket packaging code SMA						
Metal retaining clip	094.51					

Approvals
(according to type):



- RATED VALUES: 10 A - 250 V
- DIELECTRIC STRENGTH: ≥ 2 kV AC
- AMBIENT TEMPERATURE: (-40...+70)°C

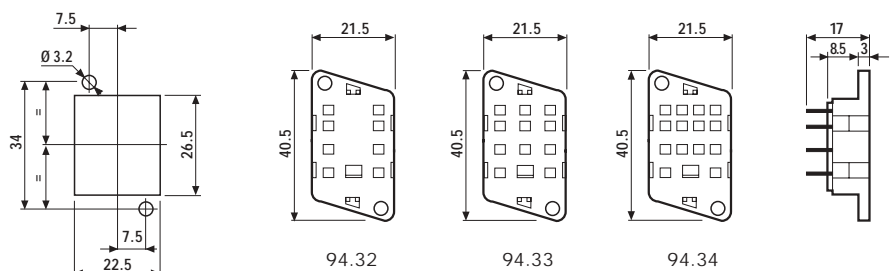

ACCESSORIES



Sheet of marker tags for retaining clip 094.01 (72 tags): 6x12mm	060.72
--	--------

PACKAGING CODES

How to code and identify retaining clip and packaging options for sockets.

Code options according to the last three letters:

55

9 4 . 0 4 S M A

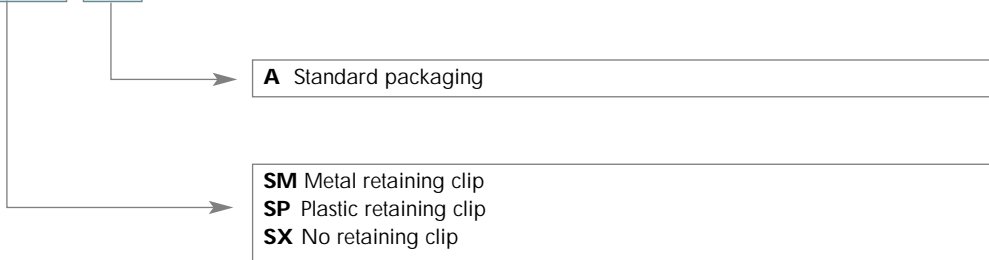

- P.C.B. version
- AC or DC coils
- Lockable test button and mechanical flag indicator as standard on 2 CO relay type

56

56.42

56.42 - 0300

56.44



- 2 pole
- P.C.B. mounting

- 2 NO (1.5 mm gap)
- P.C.B. mounting

- 4 pole
- P.C.B. mounting

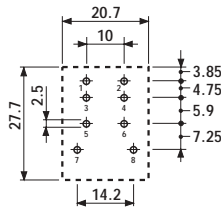
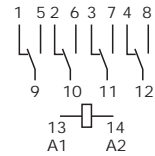
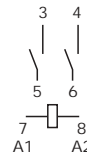
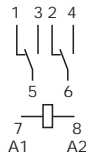

Copper side view
h = 37.7 mm

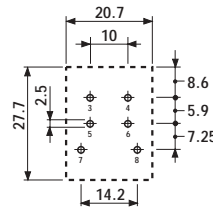

Copper side view
h = 36.3 mm

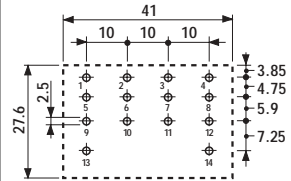

Copper side view
h = 35.2 mm

*For 400 V applications, requirements for pollution degree 2 are met.

**For 4 CO only

Contact specifications				
Contact configuration		2 CO	2 NO 1.5 mm	4 CO
Rated current/Maximum peak current	A	12/20	12/2	12/20
Rated voltage/Maximum switching voltage	V AC	250/400*	250/400*	250/400*
Rated load in AC1	VA	3,000	3,000	3,000
Rated load in AC15 (230 VAC)	VA	500	500	500
Single phase motor rating (230 VAC)	kW	0.55	0.55	0.55
Breaking capacity in DC1: 30/110/220V	A	12/0.25/0.12	12/0.6/0.3	12/0.25/0.12
Minimum switching load	mW (V/mA)	500 (10/5)	500 (10/5)	500 (10/5)
Standard contact material		AgNi	AgNi	AgNi
Coil specifications				
Nominal voltage (U _N)	V AC (50/60 Hz)	6 · 12 · 24 · 48 · 60 · 110 · 120 · 230 · 240 · 400**		
	V DC	6 · 12 · 24 · 48 · 60 · 110 · 125 · 220	—	6 · 12 · 24 · 48 · 60 · 110 · 125 · 220
Rated power AC/DC	VA (50 Hz)/W	1.5/1	1.5/—	2/1.3
Operating range	AC	(0.8...1.1)U _N	(0.8...1.1)U _N	(0.8...1.1)U _N
	DC	(0.85...1.1)U _N	—	(0.85...1.1)U _N
Holding voltage	AC/DC	0.8 U _N /0.6 U _N	0.8 U _N /—	0.8 U _N /0.6 U _N
Must drop-out voltage	AC/DC	0.2 U _N /0.1 U _N	0.2 U _N /0.1 U _N	0.2 U _N /0.1 U _N
Technical data				
Mechanical life AC/DC	cycles	20 · 10 ⁶ /50 · 10 ⁶	20 · 10 ⁶ /—	20 · 10 ⁶ /50 · 10 ⁶
Electrical life at rated load AC1	cycles	200 · 10 ³	200 · 10 ³	150 · 10 ³
Operate/release time	ms	8/8	8/4	8/8
Insulation according to EN 61810-5		4 kV/3	4 kV/3	4 kV/3
Insulation between coil and contacts (1.2/50μs)	kV	4	4	4
Dielectric strength between open contacts	V AC	1,000	2,000	1,000
Ambient temperature range	°C	-40...+70	-40...+70	-40...+70
Environmental protection		RT I	RT I	RT I
Approvals: (according to type)				

ORDERING INFORMATION

Example: a 56 series plug-in relay with 2 CO contacts, coil rated 12 V DC with a lockable test button and mechanical indicator.

	5 6	3	2	9	0 1 2	A 0 0	B 0 0	C 4	D 0
Series					A: Contact material				D: Special versions
Type					0 = Standard AgNi				0 = Standard
3 = Plug-in					2 = AgCdO				5 = Top flange mount (56.34 only)
4 = P.C.B.					4 = AgSnO ₂				6 = Rear flange mount
No. of poles					B: Contact circuit				7 = Top 35mm rail mount (56.34 only)
2 = 2 pole, 12 A					0 = CO				8 = Rear 35mm rail mount (56.34 only)
4 = 4 pole, 12 A					3 = NO (1.5 mm gap)				C: Options
Coil version									0 = None
8 = AC (50/60 Hz)									1 = Test button
9 = DC									2 = Mechanical indicator
Coil voltage									3 = LED (AC only)
see coil specifications									4 = Lockable test button + mechanical indicator
									5 = Lockable test button + LED (AC only)
									54 = Lockable test button + LED (AC only)
									+ mechanical indicator
									6 = Double LED (DC not polarized)
									7 = Lockable test button + double LED
									(DC not polarized)
									74 = Lockable test button + double LED
									(DC not polarized)
									+ mechanical indicator
									8 = LED + diode (polarity positive to pin 7, DC)
									9 = Lockable test button + LED + diode
									(polarity positive to pin 7, DC)
									94 = Lockable test button + LED + diode
									+ mechanical indicator (polarity positive
									to pin 7, DC)

Only combinations in the same row are possible

Preferred versions

	coil version	A	B	C	D
56.32	AC/DC	0	0	4	0
56.34	AC/DC	0	0	0	0
56.42	AC/DC	0	0	0	0
56.44	AC/DC	0	0	0	0

All versions

	coil version	A	B	C	D
56.32	AC	0 - 2 - 4	0	0 - 2 - 3 - 4 - 5	0 - 6
	AC	0 - 2 - 4	0	54	/
	AC	0 - 2 - 4	3	0 - 3 - 5	0 - 6
	DC	0 - 2 - 4	0	0 - 2 - 4 - 6 - 7 - 8 - 9	0 - 6
	DC	0 - 2 - 4	0	74 - 94	/
56.34	AC/DC	0 - 2 - 4	0	0 - 1	0 - 5 - 6 - 7 - 8
56.42	AC/DC	0 - 2 - 4	0	0	0
	AC	0 - 2 - 4	3	0	0
56.44	AC/DC	0 - 2 - 4	0	0	0

POSSIBLE OPTIONS

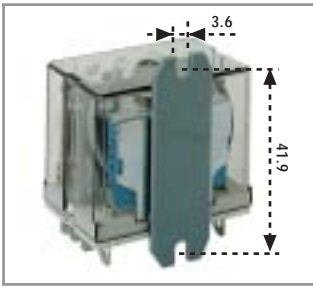
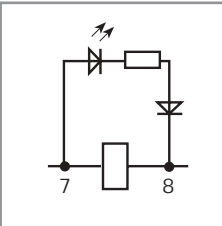
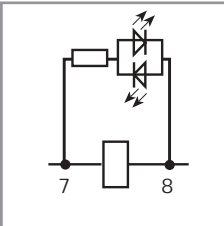
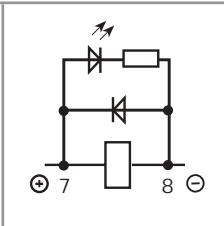
AC	DC - Non polarized	DC - Standard polarity	 <p>Option = 0006 REAR FLANGE MOUNT</p>
			
Option = 0030 0050	Option = 0060 0070 0074	Option = 0080 0090 0094	

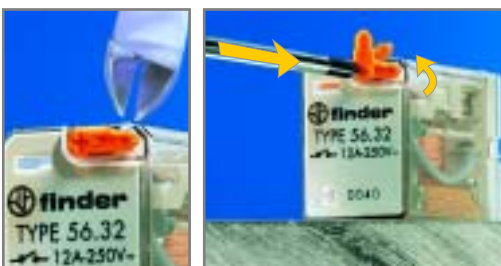

LOCKABLE TEST BUTTON AND MECHANICAL FLAG INDICATOR (0040)

The dual-purpose Finder test button can be used in two ways:

Case 1) The plastic pip (located directly above the test button) remains intact. In this case, when the test button is pushed, the contacts operate. When the test button is released the contacts return to their former state.

Case 2) The plastic pip is broken-off (using an appropriate cutting tool). In this case, (in addition to the above function), when the test button is pushed and rotated, the contacts are latched in the operating state, and remain so until the test button is rotated back to its former position.

In both cases ensure that the test button actuation is swift and decisive.

ACCESSORIES



Adaptor with top mount flange (for 56.32.x.xxx.xx00)	056.05
---	--------

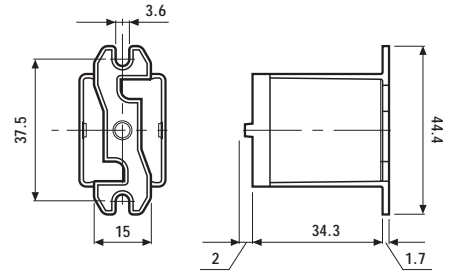

TECHNICAL DATA

INSULATION

56

INSULATION according to EN 61810-5	insulation rated voltage	V	250
	rated impulse withstand voltage	kV	4
	pollution degree		3
	overvoltage category		III

IMMUNITY

CONDUCTED DISTURBANCE IMMUNITY	BURST (according to EN 61000-4-4) level 4 (4 kV)
	SURGE (according to EN 61000-4-5) level 4 (4 kV)

OTHER DATA

BOUNCE TIME: NO/NC	ms	3/- (NO version)	1/3 (CO version)
VIBRATION RESISTANCE (10...55Hz): NO/NC	g/g	8/8	
POWER LOST TO THE ENVIRONMENT		2 CO / 2 NO	4 CO
	without contact current	W	1.3
	with rated current	W	6.9
RECOMMENDED DISTANCE between RELAYS mounted on P.C.B.s	mm	≥5	

CONTACT SPECIFICATIONS

F 56

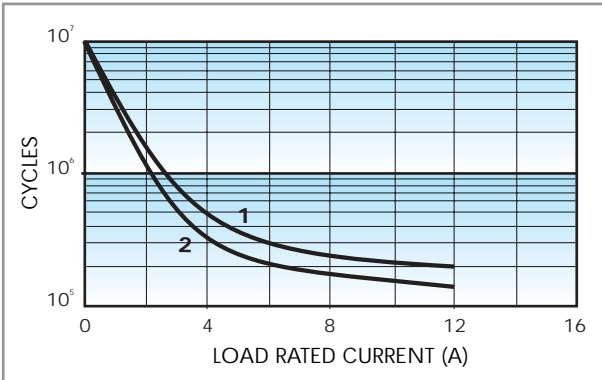

Electrical life vs AC1 load.

1 = Types 56.32/42

2 = Types 56.34/44

H 56 (CO)

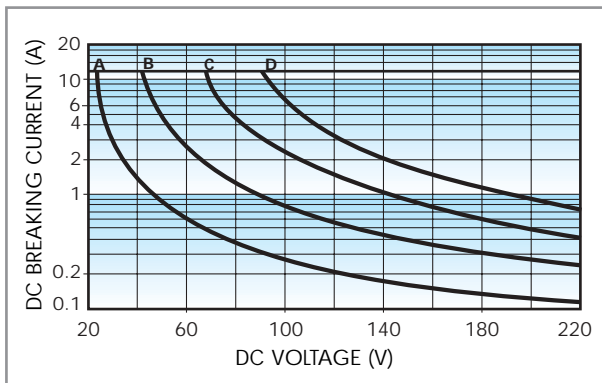

Breaking capacity for DC1 load.

A = Load applied to 1 contact.

B = Load applied to 2 contacts in series.

C = Load applied to 3 contacts in series.

D = Load applied to 4 contacts in series.

- When switching a resistive load (DC1) having voltage and current values under the curve the expected electrical life is $\geq 100 \cdot 10^3$ cycles.

- In case of DC13 loads the connection of a diode in parallel with the load will permit the same electrical life as for a DC1 load.

Note: the release time of load will be increase.

H 56 (NO)

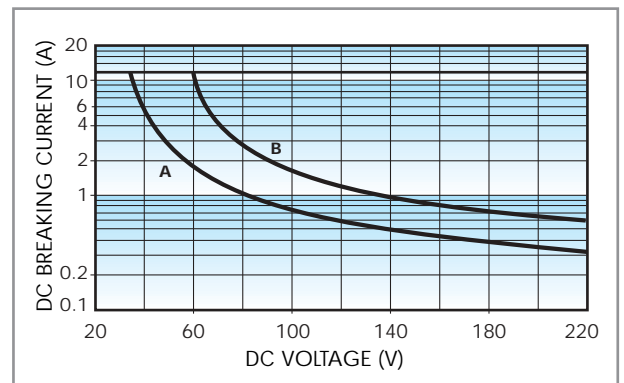

Breaking capacity for DC1 load.

A = Load applied to 1 contact.

B = Load applied to 2 contacts in series.

- When switching a resistive load (DC1) having voltage and current values under the curve the expected electrical life is $\geq 100 \cdot 10^3$ cycles.

- In case of DC13 loads the connection of a diode in parallel with the load will permit the same electrical life as for a DC1 load.

Note: the release time of load will be increase.

COIL SPECIFICATIONS

DC VERSION DATA (2 CO)

Nominal voltage U_N V	Coil code	Operating range		Resistance R Ω	Rated coil consumption I at U_N mA
		U_{min} V	U_{max} V		
6	9.006	5.1	6.6	40	150
12	9.012	10.2	13.2	140	86
24	9.024	20.4	26.4	600	40
48	9.048	40.8	52.8	2,400	20
60	9.060	51	66	4,000	15
110	9.110	93.5	121	12,500	8.8
125	9.125	100	137.5	17,300	7.2
220	9.220	176	242	54,000	4

AC VERSION DATA (2 CO, 2 NO)

Nominal voltage U_N V	Coil code	Operating range		Resistance R Ω	Rated coil consumption I at U_N (50Hz) mA
		U_{min} V	U_{max} V		
6	8.006	4.8	6.6	12	200
12	8.012	9.6	13.2	50	97
24	8.024	19.2	26.4	190	53
48	8.048	38.4	52.8	770	25
60	8.060	48	66	1,200	21
110	8.110	88	121	3,940	12.5
120	8.120	96	132	4,700	12
230	8.230	184	253	17,000	6
240	8.240	192	264	19,100	5.3

DC VERSION DATA (4 CO)

Nominal voltage U_N V	Coil code	Operating range		Resistance R Ω	Rated coil consumption I at U_N mA
		U_{min} V	U_{max} V		
6	9.006	5.1	6.6	32.5	185
12	9.012	10.2	13.2	123	97
24	9.024	20.4	26.4	490	49
48	9.048	40.8	52.8	1,800	27
60	9.060	51	66	3,000	20
110	9.110	93.5	121	10,400	10.5
125	9.125	100	137.5	14,200	8.8
220	9.220	176	242	44,000	5

AC VERSION DATA (4 CO)

Nominal voltage U_N V	Coil code	Operating range		Resistance R Ω	Rated coil consumption I at U_N (50Hz) mA
		U_{min} V	U_{max} V		
6	8.006	4.8	6.6	5.7	300
12	8.012	9.6	13.2	22	150
24	8.024	19.2	26.4	81	90
48	8.048	38.4	52.8	380	37
60	8.060	48	66	600	30
110	8.110	88	121	1,900	16.5
120	8.120	96	132	2,560	13.4
230	8.230	184	253	7,700	9
240	8.240	192	264	10,000	7.5
400	8.400	320	440	26,000	4.9

56

R 56 DC (2 co)

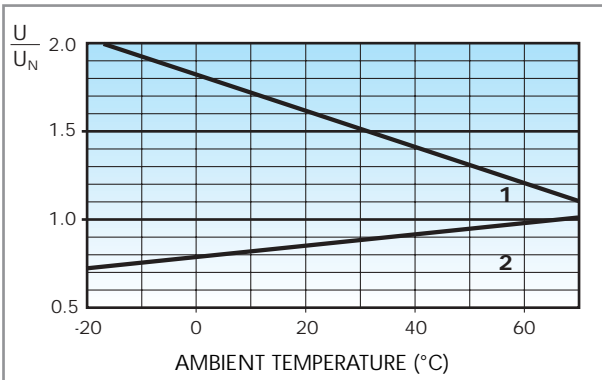

R 56 AC (2 CO, 2 NO)

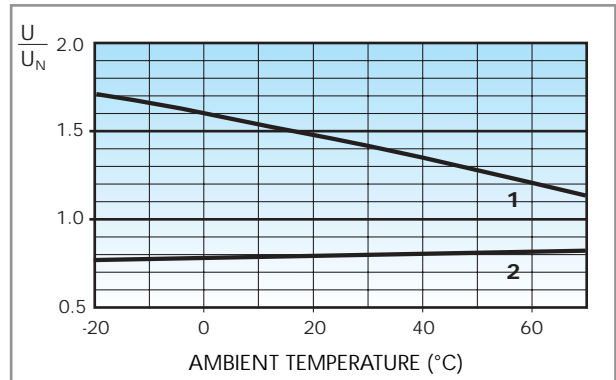

R 56 DC (4 co)

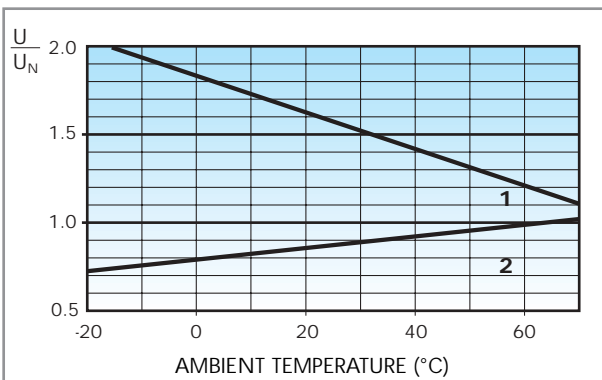

R 56 AC (4 co)

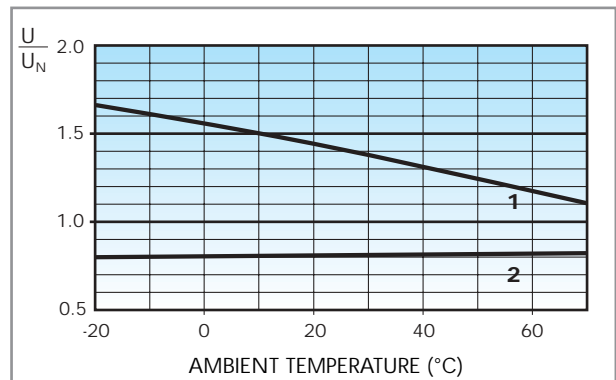

Operating range (DC type) vs ambient temperature.

- 1 - Max coil voltage permitted.
- 2 - Min pick-up voltage with coil at ambient temperature.

Operating range (AC type) vs ambient temperature.

- 1 - Max coil voltage permitted.
- 2 - Min pick-up voltage with coil at ambient temperature.



Relay type	56.32		56.34	
	BLUE	BLACK	BLUE	BLACK
Colour	BLUE	BLACK	BLUE	BLACK
Screw terminal socket: panel or 35 mm rail (EN 50022) mount retaining clip 094.71/096.71 supplied with socket packaging code SMA	96.72	96.72.0	96.74	96.74.0
Retaining clip	094.71		096.71	
Modules (see table below)	99.01			

Approvals
(according to type):



- RATED VALUES: 12 A - 250 V
- DIELECTRIC STRENGTH: ≥ 2 kV AC
- PROTECTION CATEGORY: IP 20
- AMBIENT TEMPERATURE: (-40...+70)°C
- \oplus SCREW TORQUE: 0.8 Nm
- WIRE STRIP LENGTH: 10 mm
- MAX WIRE SIZE:

	solid wire	stranded wire
mm ²	1x4 / 2x4	1x4 / 2x2.5
AWG	1x12 / 2x12	1x12 / 2x14

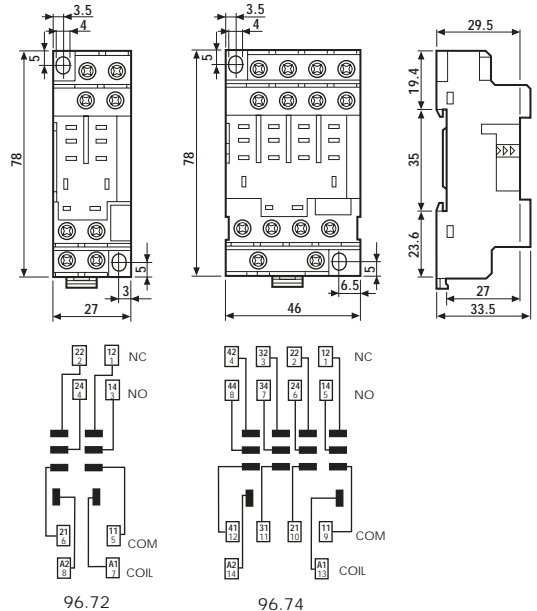

FOR 96.72 AND 96.74 SOCKETS:



Approvals
(according to type):

GOST

* Modules in Black housing are available on request.

** For DC supply, apply the positive to terminal A1.

Green LED is standard.
Red LED available on request.

99.01 coil indication and EMC suppression modules		BLUE*
(see technical data page 179)		
Diode** (+A1, standard polarity)	(6...220) V DC	99.01.3.000.00
Diode (+A2, non standard polarity)	(6...220) V DC	99.01.2.000.00
LED	(6...24) V DC/AC	99.01.0.024.59
LED	(28...60) V DC/AC	99.01.0.060.59
LED	(110...240) V DC/AC	99.01.0.230.59
LED + Diode** (+A1, standard polarity)	(6...24) V DC	99.01.9.024.99
LED + Diode** (+A1, standard polarity)	(28...60) V DC	99.01.9.060.99
LED + Diode** (+A1, standard polarity)	(110...220) V DC	99.01.9.220.99
LED + Diode (+A2, non standard polarity)	(6...24) V DC	99.01.9.024.79
LED + Diode (+A2, non standard polarity)	(28...60) V DC	99.01.9.060.79
LED + Diode (+A2, non standard polarity)	(110...220) V DC	99.01.9.220.79
LED + Varistor	(6...24) V DC/AC	99.01.0.024.98
LED + Varistor	(28...60) V DC/AC	99.01.0.060.98
LED + Varistor	(110...240) V DC/AC	99.01.0.230.98
RC circuit	(6...24) V DC/AC	99.01.0.024.09
RC circuit	(28...60) V DC/AC	99.01.0.060.09
RC circuit	(110...240) V DC/AC	99.01.0.230.09
Residual current by-pass (62 kΩ/1W)	(110...240) V AC	99.01.8.230.07



Relay type	56.32		56.34	
Colour	BLUE	BLACK	BLUE	BLACK
P.C.B. socket	96.12	96.12.0	96.14	96.14.0
retaining clip 094.51 supplied with socket packaging code SMA				
Retaining clip	094.51			

Approvals
(according to type):



- RATED VALUES: 15 A - 250 V (10 A max for each contact circuit)
- DIELECTRIC STRENGTH: ≥ 2 kV AC
- AMBIENT TEMPERATURE: (-40...+70)°C

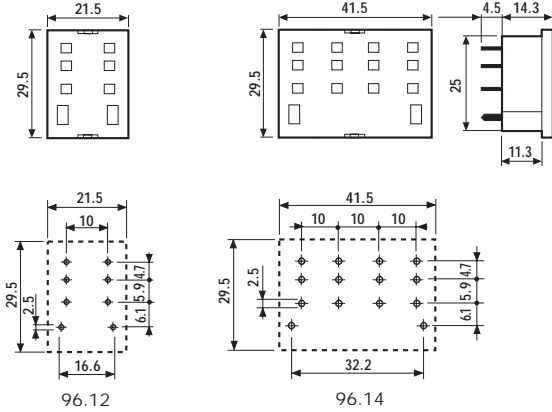

Copper side view

56

PACKAGING CODES

How to code and identify retaining clip and packaging options for sockets.

Code options according to the last three letters:

9 6 . 7 4 S M A

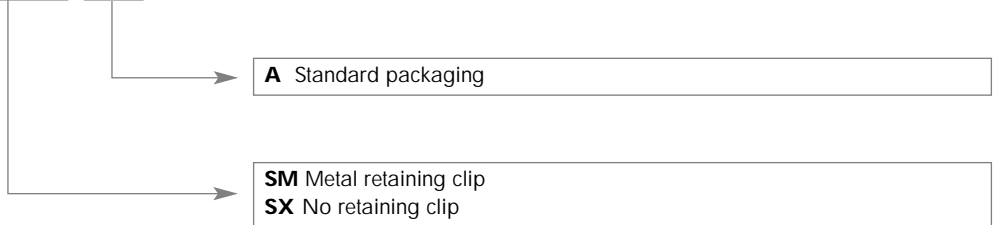

- 8 - 11 pin plug-in
- AC or DC coils
- Lockable test button with mechanical flag indicator
- Bifurcated contact option
- Sockets and accessories: see 90, 99 and 86 series

60.13 - 0200

60.62

60.63



- 3 bifurcated contacts, for low level switching capability
- 11 pin
- Plug-In for use with 90 series sockets

- 2 pole
- Faston 187 (4.8x0.8)mm with flange mount

- 3 pole
- Faston 187 (4.8x0.8)mm with flange mount

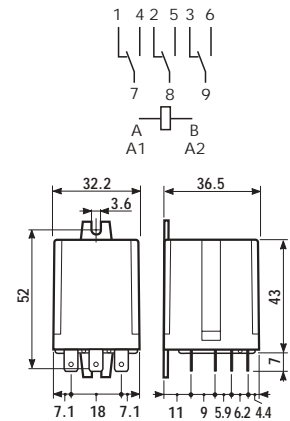
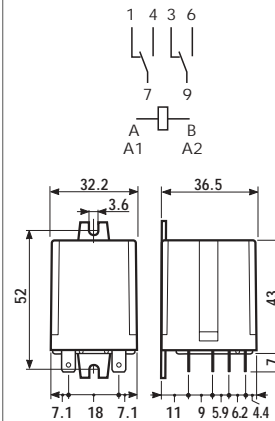
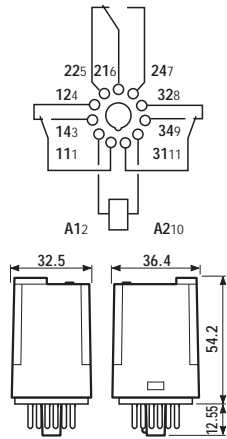

* For 400 V applications, where requirements for pollution degree 2 are met.

Contact specifications				
Contact configuration			3 CO	2 CO
Rated current/Maximum peak current	A		6/10	10/20
Rated voltage/Maximum switching voltage	V AC		250/400*	250/400*
Rated load in AC1	VA		1,500	2,500
Rated load in AC15 (230 VAC)	VA		250	500
Single phase motor rating (230 VAC)	kW		0.185	0.37
Breaking capacity in DC1: 30/110/220V	A		6/0.3/0.12	10/0.4/0.15
Minimum switching load	mW (V/mA)		50 (5/5)	500 (10/5)
Standard contact material			AgNi bifurcated contacts	AgNi
Coil specifications				
Nominal voltage (U _N)	V AC (50/60 Hz)		6 - 12 - 24 - 48 - 60 - 110 - 120 - 230 - 240 - 400	
	V DC		6 - 12 - 24 - 48 - 60 - 110 - 125 - 220	
Rated power AC/DC	VA (50 Hz)/W		2.2/1.3	2.2/1.3
Operating range	AC		(0.8...1.1)U _N	(0.8...1.1)U _N
	DC		(0.8...1.1)U _N	(0.8...1.1)U _N
Holding voltage	AC/DC		0.8 U _N /0.5 U _N	0.8 U _N /0.5 U _N
Must drop-out voltage	AC/DC		0.2 U _N /0.1 U _N	0.2 U _N /0.1 U _N
Technical data				
Mechanical life AC/DC	cycles		20 · 10 ⁶ /50 · 10 ⁶	20 · 10 ⁶ /50 · 10 ⁶
Electrical life at rated load AC1	cycles		250 · 10 ³	200 · 10 ³
Operate/release time	ms		9/9	9/9
Insulation according to EN 61810-5			3.6 kV/3	4 kV/3
Insulation between coil and contacts (1.2/50µs)	kV		3.6	3.6
Dielectric strength between open contacts	V AC		1,000	1,000
Ambient temperature range	°C		-40...+70	-40...+70
Environmental protection			RT I	RT I
Approvals: (according to type)				

ORDERING INFORMATION

Example: a 60 series plug-in relay, 3 CO (3PDT) with coil rated 12 V DC, test button and mechanical indicator.

6 0 . 1 3 . 9 . 0 1 2 . 0 0 4 0

Series — 60

Type — 139
 1 = 8/11 pin plug-in
 6 = Faston 187 (mm 4.8x0.8) with flange mount

No. of poles — 012
 2 = 2 pole
 3 = 3 pole

Coil version — 9
 4 = Current sensing
 8 = AC (50/60 Hz)
 9 = DC

Coil voltage — see coil specifications

A: Contact material
 0 = Standard
 2 = AgCdO
 5 = AgNi + 5µm Au

B: Contact circuit
 0 = CO
 2 = Bifurcated contacts
 60.12/13 - 6A only

C: Options
 0 = None
 2 = Mechanical indicator
 3 = LED (AC)
 4 = Lockable test button + mechanical indicator
 5 = Lockable test button + LED (AC)
 54 = Lockable test button + LED (AC) + mechanical indicator
 6 = LED + diode (positive to pin 2, DC)
 7 = Lockable test button + LED + diode (positive to pin 2)
 74 = Lockable test button + LED + diode (positive to pin 2) + mechanical indicator

D: Special versions
 0 = Standard

Only combinations in the same row are possible

Preferred versions

	coil version	A	B	C	D
60.12/13	AC/DC	0	0	4	0
60.62/63	AC/DC	0	0	0	0

All versions

	coil version	A	B	C	D
60.12/13	AC	0 - 2	0	0 - 2 - 3 - 4 - 5	0
	AC	0 - 2	0	54	/
	AC	5	0 - 2	0 - 2 - 3 - 4 - 5	0
	AC	5	0 - 2	54	/
	DC	0 - 2	0	0 - 2 - 4 - 6 - 7	0
	DC	0 - 2	0	74	/
	DC	5	0 - 2	0 - 2 - 4 - 6 - 7	0
	DC	5	0 - 2	74	/
	current sensing	0	0	4	0
60.62/63	AC/DC	0 - 2 - 5	0	0	0

POSSIBLE OPTIONS

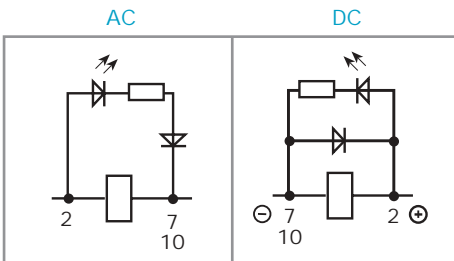

- Option = 0030
 0050
 0054
- Option = 0060
 0070
 0074



LOCKABLE TEST BUTTON AND MECHANICAL FLAG INDICATOR (0040)

The dual-purpose Finder test button can be used in two ways:

Case 1) The plastic pip (located directly above the test button) remains intact. In this case, when the test button is pushed, the contacts operate. When the test button is released the contacts return to their former state.

Case 2) The plastic pip is broken-off (using an appropriate cutting tool). In this case, (in addition to the above function), when the test button is pushed and rotated, the contacts are latched in the operating state, and remain so until the test button is rotated back to its former position. In both cases ensure that the test button actuation is swift and decisive.

ACCESSORIES

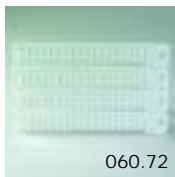

Sheet of marker tags for relay types 60.12 and 60.13 (72 tags):
6x12mm

060.72

TECHNICAL DATA

INSULATION

INSULATION according to EN 61810-5	insulation rated voltage	V	250	
	rated impulse withstand voltage	kV	4 (2 pole)	3.6 (3 pole)
	pollution degree		3	
	overvoltage category		III	

60 IMMUNITY

CONDUCTED DISTURBANCE IMMUNITY	BURST (according to EN 61000-4-4) level 4 (4kV)
	SURGE (according to EN 61000-4-5) level 4 (4kV)

OTHER DATA

BOUNCE TIME: NO/NC	ms	2/4	
VIBRATION RESISTANCE (10...55Hz): NO/NC	g/g	5/3	
POWER LOST TO THE ENVIRONMENT		2 CO	3 CO
	without contact current	W	1.3
	with rated current	W	2.7
			1.3
			3.4

CONTACT SPECIFICATIONS

F 60

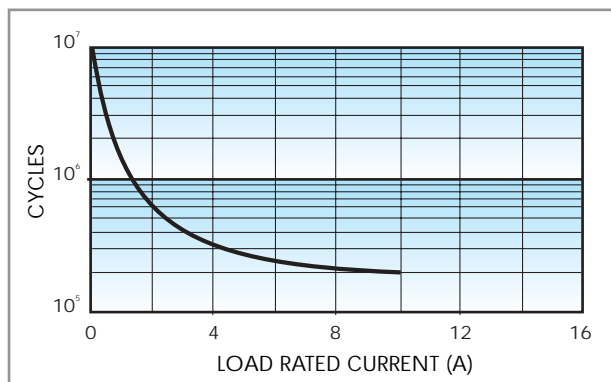

Electrical life vs AC1 load.

H 60

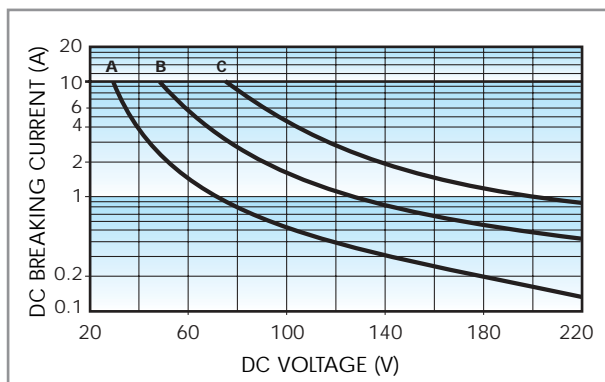

Breaking capacity for DC1 load.

- A** = Load applied to 1 contact
- B** = Load applied to 2 contacts in series
- C** = Load applied to 3 contacts in series

- When switching a resistive load (DC1) having voltage and current values under the curve the expected electrical life is $\geq 100 \cdot 10^3$ cycles.
 - In case of DC13 loads the connection of a diode in parallel with the load will permit the same electrical life as for a DC1 load.
- Note:** the release time of load will be increase.

COIL SPECIFICATIONS

DC VERSION DATA

Nominal voltage U_N V	Coil code	Operating range		Resistance R Ω	Rated coil consumption I at U_N mA
		U_{min} V	U_{max} V		
6	9.006	4.8	6.6	28	214
12	9.012	9.6	13.2	110	109
24	9.024	19.2	26.4	445	53.9
48	9.048	38.4	52.8	1,770	27.1
60	9.060	48	66	2,760	21.7
110	9.110	88	121	9,420	11.7
125	9.125	100	137.5	12,000	10.4
220	9.220	176	242	37,300	5.8

AC VERSION DATA

Nominal voltage U_N V	Coil code	Operating range		Resistance R Ω	Rated coil consumption I at U_N (50Hz) mA
		U_{min} V	U_{max} V		
6	8.006	4.8	6.6	4.6	367
12	8.012	9.6	13.2	19	183
24	8.024	19.2	26.4	74	90
48	8.048	38.4	52.8	290	47
60	8.060	48	66	450	37
110	8.110	88	121	1,600	20
120	8.120	96	132	1,940	18.6
230	8.230	184	253	7,250	10.5
240	8.240	192	264	8,500	9.2
400	8.400	320	440	19,800	6

R 60 DC

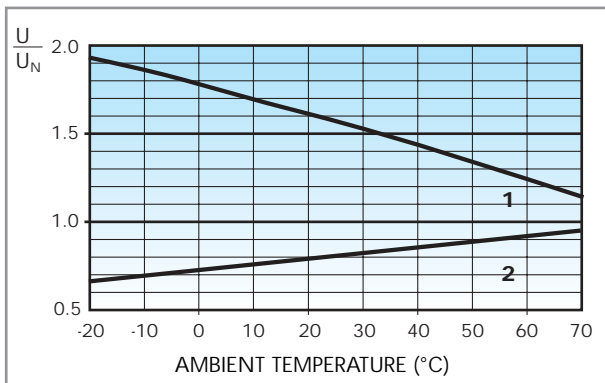

Operating range (DC version) vs ambient temperature.
1 - Max coil voltage permitted.
2 - Min pick-up voltage with coil at ambient temperature.

R 60 AC

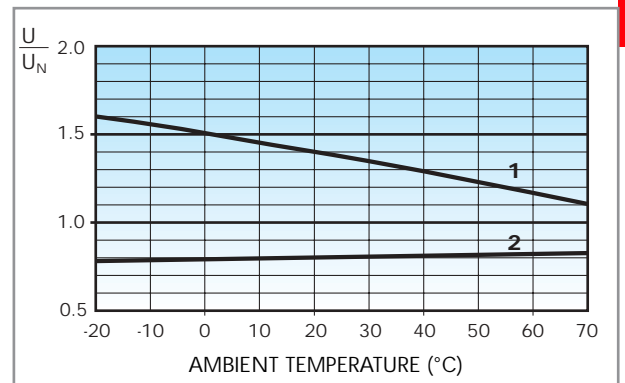

Operating range (AC version) vs ambient temperature.
1 - Max coil voltage permitted.
2 - Min pick-up voltage with coil at ambient temperature.

CURRENT SENSING VERSION

Wiring Diagram

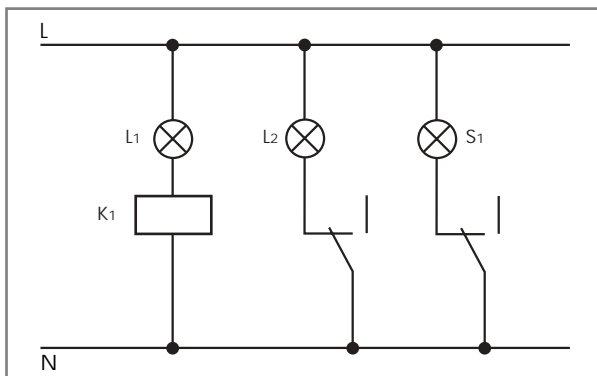

Typical application with current sensing relays.
 An open circuit filament of lamp L1 is detected by the current sensing relay coil (K1) which causes the back-up safety lamp L2 to be energised, and indication of failure at the control panel via lamp S1.

Example: navigation light.

- L1 = Light
- L2 = Safety light
- S1 = Control light
- K1 = Relay

60 Series - CURRENT SENSING AC

Coil code	I_{min} (A)	I_N (A)	I_{max} (A)	R (Ω)
4251	2.1	2.5	3.0	0.05
4181	1.5	1.8	2.2	0.10
4161	1.4	1.6	1.9	0.12
4121	1.0	1.2	1.4	0.22
4101	0.85	1.0	1.2	0.32
4051	0.42	0.5	0.6	1.28
4041	0.34	0.4	0.5	2.00
4031	0.25	0.3	0.4	3.57
4021	0.17	0.2	0.25	8.0
4011	0.085	0.1	0.15	32.1

60 Series - CURRENT SENSING DC

Coil code	I_{min} (A)	I_N (A)	I_{max} (A)	R (Ω)
4202	1.7	2.0	2.4	0.15
4182	1.5	1.8	2.2	0.19
4162	1.4	1.6	1.9	0.24
4142	1.2	1.4	1.7	0.31
4122	1.0	1.2	1.4	0.42
4102	0.85	1.0	1.2	0.61
4092	0.8	0.9	1.1	0.75
4062	0.5	0.6	0.7	1.70
4032	0.25	0.3	0.4	6.70
4012	0.085	0.1	0.15	61

Other types of current sensing relays are available on request.



90.03

Approvals
(according to type):



- Double terminal A1 (for easy start connection).
- RATED VALUES: 10 A - 250 V
- DIELECTRIC STRENGTH: ≥ 2 kV AC
- PROTECTION CATEGORY: IP 20
- AMBIENT TEMPERATURE: (-40...+70)°C
- TORQUE: 0.6 Nm
- WIRE STRIP LENGTH: 10 mm
- MAX WIRE SIZE:

	solid wire	stranded wire
mm ²	1x6 / 2x2.5	1x4 / 2x2.5
AWG	1x10 / 2x14	1x12 / 2x14

Relay type	60.12		60.13	
	BLUE	BLACK	BLUE	BLACK
Colour	BLUE	BLACK	BLUE	BLACK
Clamp terminal socket: panel or 35 mm rail (EN 50022) mount	90.02	90.02.0	90.03	90.03.0
Metal retaining clip	090.33			
Modules (see table below)	99.02			
Timer module	86.00, 86.10, 86.20			
6-way jumper link for 90.02 and 90.03 sockets	090.06			

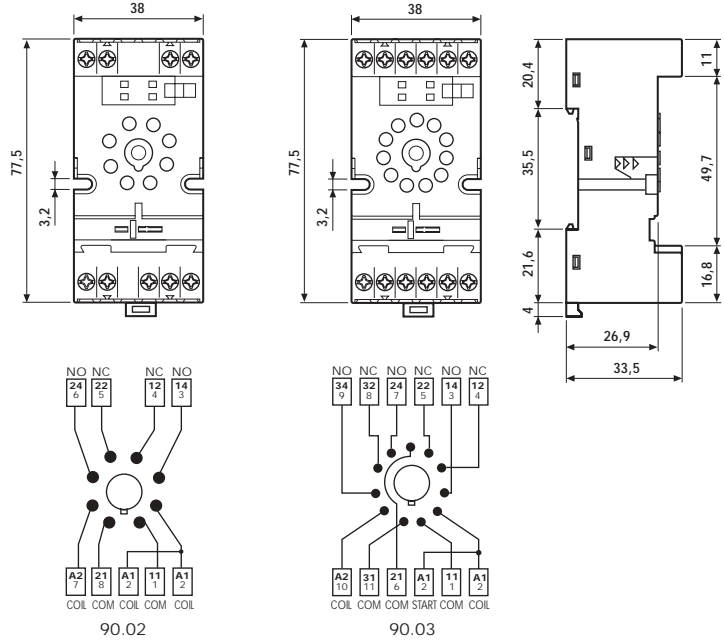

FOR 90.02 AND 90.03 SOCKETS:



090.06

6-way jumper link	090.06
--------------------------	--------

- RATED VALUES: 10 A - 250 V

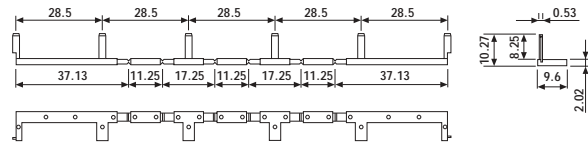

86.00

86 Series Module Timers (see technical data pages 126/131)	
Multi-voltage: 12...240 V AC/DC;	
Multi-functions: AI, DI, SW, BE, CE, DE, EE, FE; (0.05s...100h)	86.00.0.240.0000
Mono-function: 12...24 V AC/DC; function AI; (1.5s...60min)	86.10.0.024.0000
Mono-function: 12...24 V AC/DC; function DI; (1.5s...60min)	86.20.0.024.0000



99.02

99.02 coil indication and EMC suppression modules (see technical data page 179)		BLUE*
Diode** (+A1, standard polarity)	(6...220) V DC	99.02.3.000.00
Diode (+A2, non standard polarity)	(6...220) V DC	99.02.2.000.00
LED	(6...24) V DC/AC	99.02.0.024.59
LED	(28...60) V DC/AC	99.02.0.060.59
LED	(110...240) V DC/AC	99.02.0.230.59
LED + Diode** (+A1, standard polarity)	(6...24) V DC	99.02.9.024.99
LED + Diode** (+A1, standard polarity)	(28...60) V DC	99.02.9.060.99
LED + Diode** (+A1, standard polarity)	(110...220) V DC	99.02.9.220.99
LED + Diode (+A2, non standard polarity)	(6...24) V DC	99.02.9.024.79
LED + Diode (+A2, non standard polarity)	(28...60) V DC	99.02.9.060.79
LED + Diode (+A2, non standard polarity)	(110...220) V DC	99.02.9.220.79
LED + Varistor	(6...24) V DC/AC	99.02.0.024.98
LED + Varistor	(28...60) V DC/AC	99.02.0.060.98
LED + Varistor	(110...240) V DC/AC	99.02.0.230.98
RC circuit	(6...24) V DC/AC	99.02.0.024.09
RC circuit	(28...60) V DC/AC	99.02.0.060.09
RC circuit	(110...240) V DC/AC	99.02.0.230.09
Residual current by-pass (62 kΩ/1W)	(110...240) V AC	99.02.8.230.07

Approvals
(according to type):



* Modules in Black housing are available on request.

**For DC supply, apply the positive to terminal A1.



90.21

Approvals
(according to type):



- RATED VALUES: 10 A - 250 V
- DIELECTRIC STRENGTH: ≥ 2 kV AC
- PROTECTION CATEGORY: IP 20
- AMBIENT TEMPERATURE: (-40...+70)°C
- SCREW TORQUE: 0.5 Nm
- WIRE STRIP LENGTH: 10 mm
- MAX WIRE SIZE:

	solid wire	stranded wire
mm ²	1x6 / 2x2.5	1x6 / 2x2.5
AWG	1x10 / 2x14	1x10 / 2x14

Relay type	60.12		60.13	
	BLUE	BLACK	BLUE	BLACK
Colour	BLUE	BLACK	BLUE	BLACK
Clamp terminal socket: panel or 35 mm rail (EN 50022) mount retaining clip 090.33 supplied with socket packaging code SMA	90.20	90.20.0	90.21	90.21.0
Retaining clip	090.33			
Modules (see table below)	99.01			

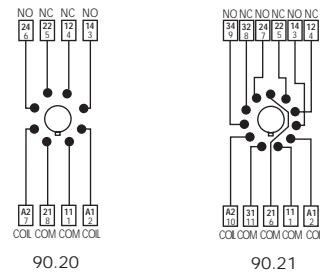
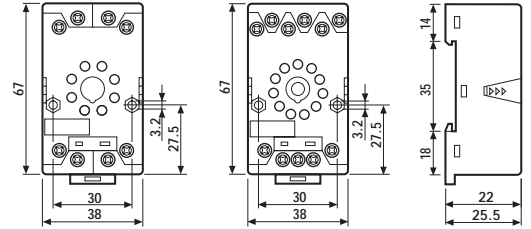

FOR 90.20 AND 90.21 SOCKETS:



99.01

Approvals
(according to type):

GOST

* Modules in Black housing are available on request.

**For DC supply, apply the positive to terminal A1.

Green LED is standard. Red LED available on request.

99.01 coil indication and EMC suppression modules (see technical data page 179)		BLUE*
Diode** (+A1, standard polarity)	(6...220) V DC	99.01.3.000.00
Diode (+A2, non standard polarity)	(6...220) V DC	99.01.2.000.00
LED	(6...24) V DC/AC	99.01.0.024.59
LED	(28...60) V DC/AC	99.01.0.060.59
LED	(110...240) V DC/AC	99.01.0.230.59
LED + Diode** (+A1, standard polarity)	(6...24) V DC	99.01.9.024.99
LED + Diode** (+A1, standard polarity)	(28...60) V DC	99.01.9.060.99
LED + Diode** (+A1, standard polarity)	(110...220) V DC	99.01.9.220.99
LED + Diode (+A2, non standard polarity)	(6...24) V DC	99.01.9.024.79
LED + Diode (+A2, non standard polarity)	(28...60) V DC	99.01.9.060.79
LED + Diode (+A2, non standard polarity)	(110...220) V DC	99.01.9.220.79
LED + Varistor	(6...24) V DC/AC	99.01.0.024.98
LED + Varistor	(28...60) V DC/AC	99.01.0.060.98
LED + Varistor	(110...240) V DC/AC	99.01.0.230.98
RC circuit	(6...24) V DC/AC	99.01.0.024.09
RC circuit	(28...60) V DC/AC	99.01.0.060.09
RC circuit	(110...240) V DC/AC	99.01.0.230.09
Residual current by-pass (62 kΩ/1W)	(110...240) V AC	99.01.8.230.07



90.23

Relay type	60.12	60.13
Colour	BLUE	BLUE
Clamp terminal socket: panel or 35 mm rail (EN 50022) mount (retaining clip 090.33 supplied with socket packaging code SMA)	90.22	90.23
Metal retaining clip	090.33	

Homologations
(suivant les types):



- RATED VALUES: 10 A - 250 V
- DIELECTRIC STRENGTH: ≥ 2 kV AC
- PROTECTION CATEGORY: IP 20
- AMBIENT TEMPERATURE: (-40...+70)°C
- SCREW TORQUE: 0.5 Nm
- WIRE STRIP LENGTH: 7 mm
- MAX WIRE SIZE:

	fil rigide	fil flexible
mm ²	1x6 / 2x2.5	1x6 / 2x2.5
AWG	1x10 / 2x14	1x10 / 2x14

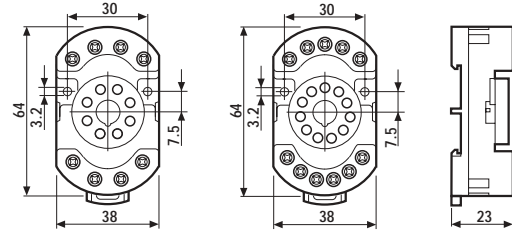

90.22

90.23

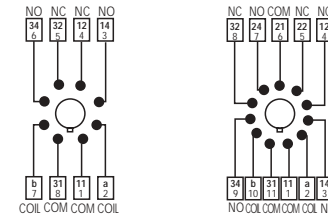

90.22

90.23



90.26

Relay type	60.12		60.13	
Colour	BLUE	BLACK	BLUE	BLACK
Screw terminal socket: panel or 35 mm rail (EN 50022) mount retaining clip 090.33 supplied with socket packaging code SMA	90.26	90.26.0	90.27	90.27.0
Metal retaining clip	090.33			

Approvals
(according to type):



- RATED VALUES: 10 A - 250 V
- DIELECTRIC STRENGTH: ≥ 2 kV AC
- PROTECTION CATEGORY: IP 20
- AMBIENT TEMPERATURE: (-40...+70)°C
- SCREW TORQUE: 0.8 Nm
- WIRE STRIP LENGTH: 10 mm
- MAX WIRE SIZE:

	solid wire	stranded wire
mm ²	1x4 / 2x2.5	1x4 / 2x2.5
AWG	1x12 / 2x14	1x12 / 2x14

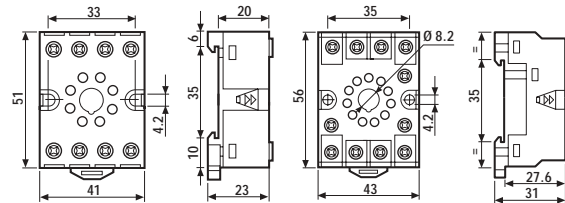

90.26

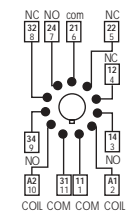

90.27



90.12

Relay type	60.12	60.13
Colour	BLACK	BLACK
Flange mount solder socket mount with M3 screw	90.12	90.13

Approvals
(according to type):



- RATED VALUES: 10 A - 250 V
- DIELECTRIC STRENGTH: ≥ 2 kV AC
- AMBIENT TEMPERATURE: (-40...+70)°C

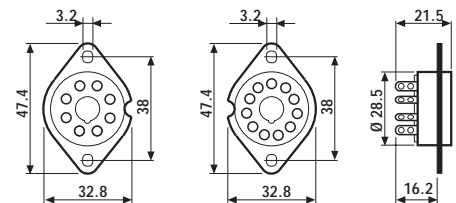

90.12

90.13



Relay type	60.12	60.13
P.C.B. socket	BLUE 90.14	90.15
	BLUE 90.14.1 (Ø 17.5mm)	90.15.1 (Ø 19mm)

Approvals
(according to type):



- RATED VALUES: 10 A - 250 V
- DIELECTRIC STRENGTH: ≥ 2 kV AC
- AMBIENT TEMPERATURE: (-40...+70)°C

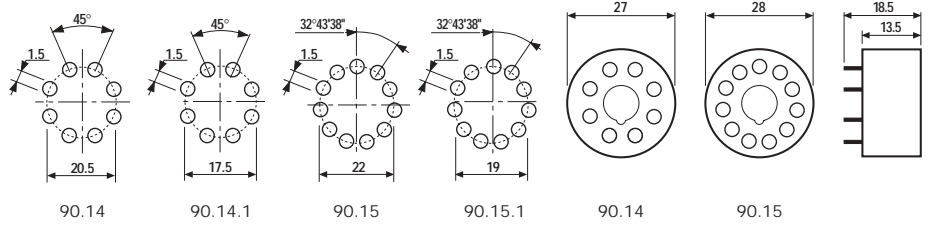

PACKAGING CODES

How to code and identify retaining clip and packaging options for sockets.

Code options according to the last three letters:

9	0	.	2	1	S	M	A
---	---	---	---	---	---	---	---

A → Standard packaging
 SM → Metal retaining clip
 SX → No retaining clip

- Plug-in or P.C.B. versions
- AC or DC coils
- 3 mm gap between open contacts on NO option
- 8 mm, 6 kV (1.2/50 μs) between coil and contacts (internal distance)
- Option with coil to contacts SELV insulations
- Sockets and accessories see 92, 99 and 86 series

62.22

62.23

62.32

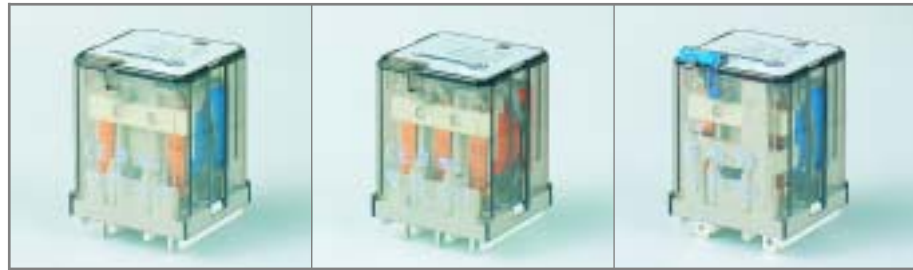

- 2 pole
- P.C.B. mounting

- 3 pole
- P.C.B. mounting

- 2 pole
- Faston 187 (4.8x0.5)mm
- Plug-in use 92 Series socket

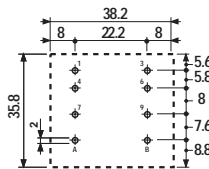
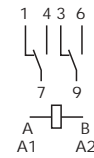
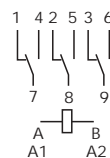
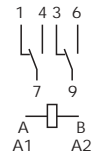

Copper side view

h = 49.1 mm

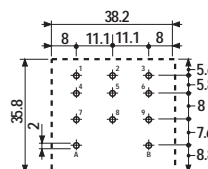

Copper side view

h = 49.1 mm

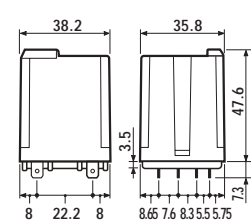

62

* With the AgSnO₂ material the maximum peak current is 150A - 5ms on NO contact

Contact specifications				
Contact configuration		2 CO	3 CO	2 CO
Rated current/Maximum peak current	A	16/30*	16/30*	16/30
Rated voltage/Maximum switching voltage	V AC	250/400	250/400	250/400
Rated load in AC1	VA	4,000	4,000	4,000
Rated load in AC15 (230 VAC)	VA	750	750	750
Single phase motor rating (230 VAC)	kW	0.8	0.8	0.8
Breaking capacity in DC1: 30/110/220V	A	16/0.6/0.4	16/0.6/0.4	16/0.6/0.4
Minimum switching load	mW (V/mA)	1,000 (10/10)	1,000 (10/10)	1,000 (10/10)
Standard contact material		AgCdO	AgCdO	AgCdO
Coil specifications				
Nominal voltage (U _N)	V AC (50/60 Hz)	6 - 12 - 24 - 48 - 60 - 110 - 120 - 230 - 240 - 400		
	V DC	6 - 12 - 24 - 48 - 60 - 110 - 125 - 220		
Rated power AC/DC	VA (50 Hz)/W	2.2/1.3	2.2/1.3	2.2/1.3
Operating range	AC	(0.8...1.1)U _N	(0.8...1.1)U _N	(0.8...1.1)U _N
	DC	(0.8...1.1)U _N	(0.8...1.1)U _N	(0.8...1.1)U _N
Holding voltage	AC/DC	0.8 U _N /0.6 U _N	0.8 U _N /0.6 U _N	0.8 U _N /0.6 U _N
Must drop-out voltage	AC/DC	0.2 U _N /0.1 U _N	0.2 U _N /0.1 U _N	0.2 U _N /0.1 U _N
Technical data				
Mechanical life AC/DC	cycles	10 · 10 ⁶ /30 · 10 ⁶	10 · 10 ⁶ /30 · 10 ⁶	10 · 10 ⁶ /30 · 10 ⁶
Electrical life at rated load AC1	cycles	100 · 10 ³	100 · 10 ³	100 · 10 ³
Operate/release time	ms	10/10	10/10	10/10
Insulation according to EN 61810-5		4kV/3	4kV/3	4kV/3
Insulation between coil and contacts (1.2/50μs)	kV	6	6	6
Dielectric strength between open contacts	V AC	1,500	1,500	1,500
Ambient temperature range	°C	-40...+70	-40...+70	-40...+70
Environmental protection		RT I	RT I	RT I
Approvals: (according to type)				

- Plug-in or P.C.B. versions
- AC or DC coils
- 3 mm gap between open contacts on NO option
- 8 mm, 6 kV (1.2/50 μs) between coil and contacts (internal distance)
- Option with coil to contacts SELV insulations
- Sockets and accessories see 92, 99 and 86 series

62.33

62.82

62.83



- 3 pole
- Faston 187 (4.8x0.5)mm
- Plug-in use 92 Series socket

- 2 pole
- Faston 250 (6.3x0.8)mm with flange mount

- 3 pole
- Faston 250 (6.3x0.8)mm with flange mount

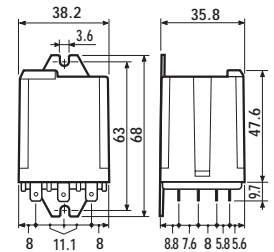
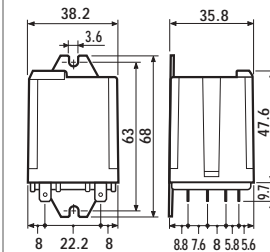
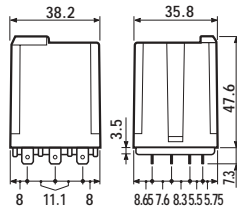
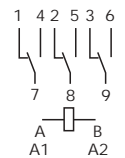
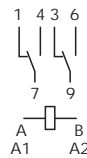
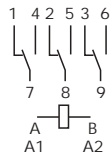

* With the AgSnO₂ material the maximum peak current is 150A - 5ms on NO contact

Contact specifications		62.33	62.82	62.83
Contact configuration		3 CO	2 CO	3 CO
Rated current/Maximum peak current	A	16/30*	16/30*	16/30*
Rated voltage/Maximum switching voltage	V AC	250/400	250/400	250/400
Rated load in AC1	VA	4,000	4,000	4,000
Rated load in AC15 (230 VAC)	VA	750	750	750
Single phase motor rating (230 VAC)	kW	0.8	0.8	0.8
Breaking capacity in DC1: 30/110/220V	A	16/0.6/0.4	16/0.6/0.4	16/0.6/0.4
Minimum switching load	mW (V/mA)	1,000 (10/10)	1,000 (10/10)	1,000 (10/10)
Standard contact material		AgCdO	AgCdO	AgCdO
Coil specifications				
Nominal voltage (U _N)	V AC (50/60 Hz)	6 · 12 · 24 · 48 · 60 · 110 · 120 · 230 · 240 · 400		
	V DC	6 · 12 · 24 · 48 · 60 · 110 · 125 · 220		
Rated power AC/DC	VA (50 Hz)/W	2.2/1.3	2.2/1.3	2.2/1.3
Operating range	AC	(0.8...1.1)U _N	(0.8...1.1)U _N	(0.8...1.1)U _N
	DC	(0.8...1.1)U _N	(0.8...1.1)U _N	(0.8...1.1)U _N
Holding voltage	AC/DC	0.8 U _N /0.6 U _N	0.8 U _N /0.6 U _N	0.8 U _N /0.6 U _N
Must drop-out voltage	AC/DC	0.2 U _N /0.1 U _N	0.2 U _N /0.1 U _N	0.2 U _N /0.1 U _N
Technical data				
Mechanical life AC/DC	cycles	10 · 10 ⁶ /30 · 10 ⁶	10 · 10 ⁶ /30 · 10 ⁶	10 · 10 ⁶ /30 · 10 ⁶
Electrical life at rated load AC1	cycles	100 · 10 ³	100 · 10 ³	100 · 10 ³
Operate/release time	ms	10/10	10/10	10/10
Insulation according to EN 61810-5		4 kV/3	4 kV/3	4 kV/3
Insulation between coil and contacts (1.2/50μs)	kV	6	6	6
Dielectric strength between open contacts	V AC	1,500	1,500	1,500
Ambient temperature range	°C	-40...+70	-40...+70	-40...+70
Environmental protection		RT I	RT I	RT I
Approvals: (according to type)				

- Plug-in or P.C.B. versions
- AC or DC coils
- 3 mm gap between open contacts on NO option
- 8 mm, 6 kV (1.2/50 μs) between coil and contacts (internal distance)
- Option with coil to contacts SELV insulations
- Sockets and accessories see 92, 99 and 86 series

62.22 - 0300

62.23 - 0300

62.32 - 0300



- 2 NO (3mm contact gap)
- P.C.B. mounting

- 3 NO (3mm contact gap)
- P.C.B. mounting

- 2 NO (3mm contact gap)
- Faston 187 (4.8x0.5)mm
- Plug-in use 92 Series socket

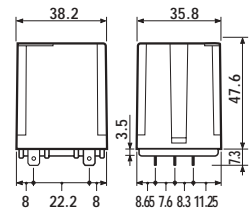
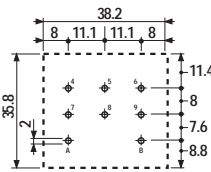
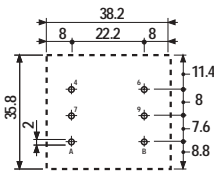
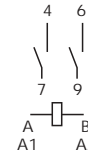
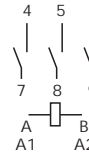
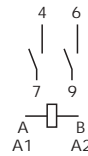

Copper side view

Copper side view

h = 51.1 mm

h = 51.1 mm

62

* Distance between contacts $\geq 3\text{mm}$
(EN 60335-1)

**With the AgSnO_2 material the maximum peak current is 150A - 5ms on NO contact

Contact specifications				
Contact configuration		2 NO 3 mm*	3 NO 3 mm*	2 NO 3 mm*
Rated current/Maximum peak current	A	16/30**	16/30**	16/30**
Rated voltage/Maximum switching voltage	V AC	250/400	250/400	250/400
Rated load in AC1	VA	4,000	4,000	4,000
Rated load in AC15 (230 VAC)	VA	750	750	750
Single phase motor rating (230 VAC)	kW	0.8	0.8	0.8
Breaking capacity in DC1: 30/110/220V	A	16/1.1/0.7	16/1.1/0.7	16/1.1/0.7
Minimum switching load	mW (V/mA)	1,000 (10/10)	1,000 (10/10)	1,000 (10/10)
Standard contact material		AgCdO	AgCdO	AgCdO
Coil specifications				
Nominal voltage (U_N)	V AC (50/60 Hz)	6 - 12 - 24 - 48 - 60 - 110 - 120 - 230 - 240 - 400		
	V DC	6 - 12 - 24 - 48 - 60 - 110 - 125 - 220		
Rated power AC/DC	VA (50 Hz)/W	3/3	3/3	3/3
Operating range	AC	$(0.85 \dots 1.1)U_N$	$(0.85 \dots 1.1)U_N$	$(0.85 \dots 1.1)U_N$
	DC	$(0.85 \dots 1.1)U_N$	$(0.85 \dots 1.1)U_N$	$(0.85 \dots 1.1)U_N$
Holding voltage	AC/DC	$0.8 U_N / 0.6 U_N$	$0.8 U_N / 0.6 U_N$	$0.8 U_N / 0.6 U_N$
Must drop-out voltage	AC/DC	$0.2 U_N / 0.1 U_N$	$0.2 U_N / 0.1 U_N$	$0.2 U_N / 0.1 U_N$
Technical data				
Mechanical life AC/DC	cycles	$10 \cdot 10^6 / 30 \cdot 10^6$	$10 \cdot 10^6 / 30 \cdot 10^6$	$10 \cdot 10^6 / 30 \cdot 10^6$
Electrical life at rated load AC1	cycles	$100 \cdot 10^3$	$100 \cdot 10^3$	$100 \cdot 10^3$
Operate/release time	ms	20/4	20/4	20/4
Insulation according to EN 61810-5		4kV/3	4kV/3	4kV/3
Insulation between coil and contacts (1.2/50μs)	kV	6	6	6
Dielectric strength between open contacts	V AC	2,500	2,500	2,500
Ambient temperature range	°C	-40...+50	-40...+50	-40...+50
Environmental protection		RT I	RT I	RT I

Approvals: (according to type)



- Plug-in or P.C.B. versions
- AC or DC coils
- 3 mm gap between open contacts on NO option
- 8 mm, 6 kV (1.2/50 μs) between coil and contacts (internal distance)
- Option with coil to contacts SELV insulations
- Sockets and accessories see 92, 99 and 86 series

62.33 - 0300

62.82 - 0300

62.83 - 0300



- 3 NO (3mm contact gap)
- Faston 187 (4.8x0.5)mm
- Plug-in use 92 Series socket

- 2 NO (3mm contact gap)
- Faston 250 (6.3x0.8)mm with flange mount

- 3 NO (3mm contact gap)
- Faston 250 (6.3x0.8)mm with flange mount

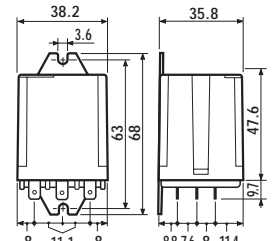
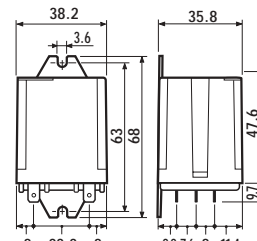
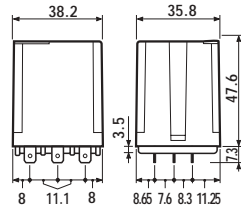
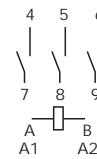
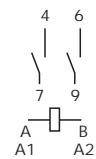
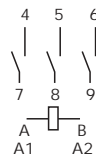

* Distance between contacts ≥ 3 mm (EN 60335-1)

**With the AgSnO₂ material the maximum peak current is 150A - 5ms on NO contact

Contact specifications		62.33 - 0300	62.82 - 0300	62.83 - 0300
Contact configuration		3 NO 3 mm*	2 NO 3 mm*	3 NO 3 mm*
Rated current/Maximum peak current	A	16/30**	16/30**	16/30**
Rated voltage/Maximum switching voltage	V AC	250/400	250/400	250/400
Rated load in AC1	VA	4,000	4,000	4,000
Rated load in AC15 (230 VAC)	VA	750	750	750
Single phase motor rating (230 VAC)	kW	0.8	0.8	0.8
Breaking capacity in DC1: 30/110/220V	A	16/1.1/0.7	16/1.1/0.7	16/1.1/0.7
Minimum switching load	mW (V/mA)	1,000 (10/10)	1,000 (10/10)	1,000 (10/10)
Standard contact material		AgCdO	AgCdO	AgCdO
Coil specifications		6 - 12 - 24 - 48 - 60 - 110 - 120 - 230 - 240 - 400		
Nominal voltage (U _N)	V AC (50/60 Hz)			
	V DC	6 - 12 - 24 - 48 - 60 - 110 - 125 - 220		
Rated power AC/DC	VA (50 Hz)/W	3/3	3/3	3/3
Operating range	AC (50 Hz)	(0.85...1.1)U _N	(0.85...1.1)U _N	(0.85...1.1)U _N
	DC	(0.85...1.1)U _N	(0.85...1.1)U _N	(0.85...1.1)U _N
Holding voltage	AC/DC	0.8 U _N /0.6 U _N	0.8 U _N /0.6 U _N	0.8 U _N /0.6 U _N
Must drop-out voltage	AC/DC	0.2 U _N /0.1 U _N	0.2 U _N /0.1 U _N	0.2 U _N /0.1 U _N
Technical data				
Mechanical life AC/DC	cycles	10 · 10 ⁶ /30 · 10 ⁶	10 · 10 ⁶ /30 · 10 ⁶	10 · 10 ⁶ /30 · 10 ⁶
Electrical life at rated load AC1	cycles	100 · 10 ³	100 · 10 ³	100 · 10 ³
Operate/release time	ms	20/4	20/4	20/4
Insulation according to EN 61810-5		4 kV/3	4 kV/3	4 kV/3
Insulation between coil and contacts (1.2/50μs)	kV	6	6	6
Dielectric strength between open contacts	V AC	2,500	2,500	2,500
Ambient temperature range	°C	-40...+50	-40...+50	-40...+50
Environmental protection		RT I	RT I	RT I
Approvals: (according to type)				

ORDERING INFORMATION

Example: a 62 series power relay + FASTON 250 rear flange mount (6.3 x 0.8 mm) with 2 NO contacts, coil rated at 12 V DC.

	6 2	.	8	.	2	.	9	.	0 1 2	.	A	0	B	3	C	0	D	0
Series																		
Type																		
2 = P.C.B.																		
3 = Plug-in																		
8 = Faston 250 (6.3x0.8 mm) with rear flange mount																		
No. of poles																		
2 = 2 pole																		
3 = 3 pole																		
Coil version																		
8 = AC (50/60 Hz)																		
9 = DC																		
Coil voltage																		
see coil specifications																		
	<p>A: Contact material 0 = Standard AgCdO 4 = AgSnO₂</p> <p>B: Contact circuit 0 = CO 3 = NO (≥ 3 mm contact gap) 5 = CO version with coil to contacts SELV insulation 6 = NO (≥ 3 mm contact gap) version with coil to contacts SELV insulation</p> <p>D: Special versions 0 = Standard 5 = Top flange mount 6 = Rear flange mount 7 = Top 35 mm rail mount 8 = Rear 35 mm rail mount 9 = Type 62.82/83 without rear flange mount</p> <p>C: Options 0 = None 2 = Mechanical indicator 3 = LED (AC) 4 = Lockable test button + mechanical indicator 5 = Lockable test button + LED (AC) 54 = Lockable test button + LED (AC) + mechanical indicator 6 = LED + diode (DC polarity positive to pin A/A1) 7 = Lockable test button + LED + diode (DC polarity positive to pin A/A1) 74 = Lockable test button + LED + diode (DC polarity positive to pin A/A1) + mechanical indicator</p>																	

62

Only combinations in the same row are possible

Preferred versions

	coil version	A	B	C	D
62.22/23	AC-DC	0	0	0	0
62.32/33	AC-DC	0	0	4	0
62.82/83	AC-DC	0	0	0	0

All versions

	coil version	A	B	C	D
62.22/23	AC-DC	0 - 4	0 - 3 - 5 - 6	0	0
62.32/33	AC-DC	0 - 4	0 - 3 - 5 - 6	0	0 - 5 - 6 - 7 - 8
	AC-DC	0 - 4	5	2 - 4	0 - 6 - 8
	AC	0 - 4	0	2 - 3 - 4 - 5	0 - 6 - 8
	AC	0 - 4	3	3	0 - 6 - 8
	AC	0 - 4	0	54	/
	DC	0 - 4	0	4 - 6 - 7	0 - 6 - 8
	DC	0 - 4	3	6	0 - 6 - 8
	DC	0 - 4	0	74	/
62.82/83	AC-DC	0 - 4	0 - 3 - 5 - 6	0	0 - 5 - 7 - 8 - 9
	AC-DC	0 - 4	5	2 - 4	0 - 8
	AC	0 - 4	0	2 - 3 - 4 - 5	0 - 8
	AC	0 - 4	3	3	0 - 8
	DC	0 - 4	0	4 - 6 - 7	0 - 8
	DC	0 - 4	3	6	0 - 8

POSSIBLE OPTIONS

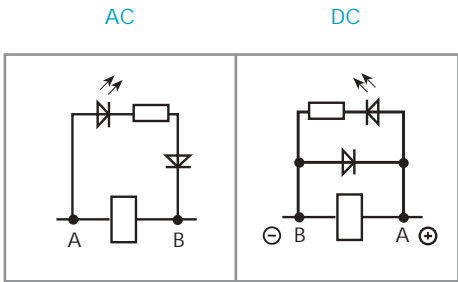

Option = 0030
0050

Option = 0060
0070

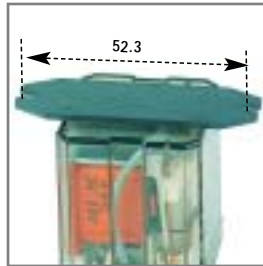

Option = 0005
TOP MOUNT FLANGE



Option = 0500 and 0600
COIL TO CONTACTS
PHYSICAL SEPARATOR FOR
SELV APPLICATIONS



Option = 0007
TOP 35mm RAIL MOUNT

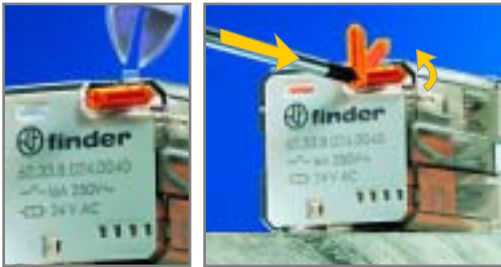

LOCKABLE TEST BUTTON AND MECHANICAL FLAG INDICATOR (0040)

The dual-purpose Finder test button can be used in two ways:

Case 1) The plastic pip (located directly above the test button) remains intact. In this case, when the test button is pushed, the contacts operate. When the test button is released the contacts return to their former state.

Case 2) The plastic pip is broken-off (using an appropriate cutting tool). In this case, (in addition to the above function), when the test button is pushed and rotated, the contacts are latched in the operating state, and remain so until the test button is rotated back to its former position.

In both cases ensure that the test button actuation is swift and decisive.

ACCESSORIES



Mounting adaptor for types 62.3x and 62.8x (M4)	062.10
--	--------

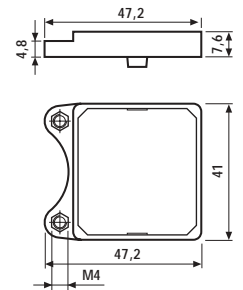

Flange mounting adaptor for types 62.3x and 62.8x	062.60
--	--------

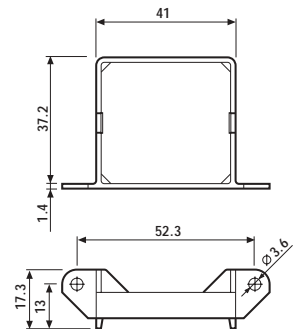

Sheet of marker tags for 62 series relays (72 tags): 6x12mm	060.72
--	--------

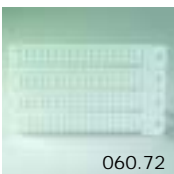

TECHNICAL DATA

INSULATION

INSULATION according to EN 61810-5	insulation rated voltage	V	400
	rated impulse withstand voltage	kV	4
	pollution degree		3
	overvoltage category		III

IMMUNITY

CONDUCTED DISTURBANCE IMMUNITY	BURST (according to EN 61000-4-4) level 4 (4 kV)
	SURGE (according to EN 61000-4-5) level 4 (4kV)

OTHER DATA

BOUNCE TIME: NO/NC	ms	3/6 (CO versions)	3/- (NO versions)		
VIBRATION RESISTANCE (10...55Hz): NO/NC	g/g	5/3			
POWER LOST TO THE ENVIRONMENT		2 CO	3 CO	2 NO	3 NO
	without contact current W	1.3	1.3	3	3
	with rated current W	3.3	4.3	5	6
RECOMMENDED DISTANCE between RELAYS mounted on P.C.B.s	mm	≥5			

62

CONTACT SPECIFICATIONS

F 62

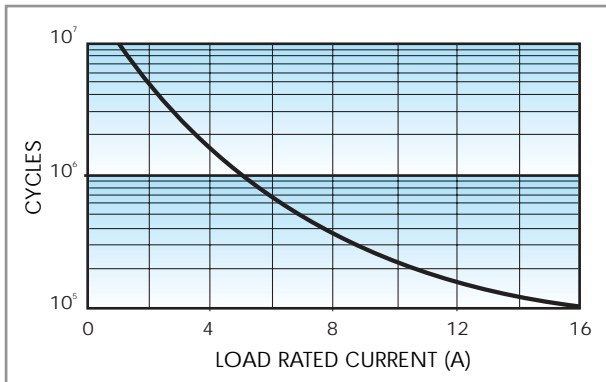

Electrical life vs AC1 load.

H 62 (CO)

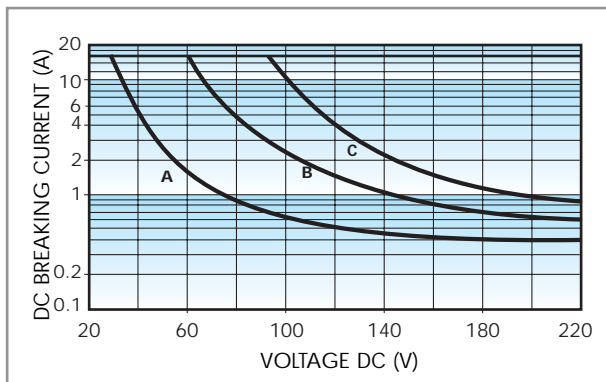

Breaking capacity for DC1 load.

- A** = Load applied to 1 contact.
- B** = Load applied to 2 contacts in series.
- C** = Load applied to 3 contacts in series.

- When switching a resistive load (DC1) having voltage and current values under the curve the expected electrical life is $\geq 100 \cdot 10^3$ cycles.
- In case of DC13 loads the connection of a diode in parallel with the load will permit the same electrical life as for a DC1 load.

Note: the release time of load will be increase.

H 62 (NO)

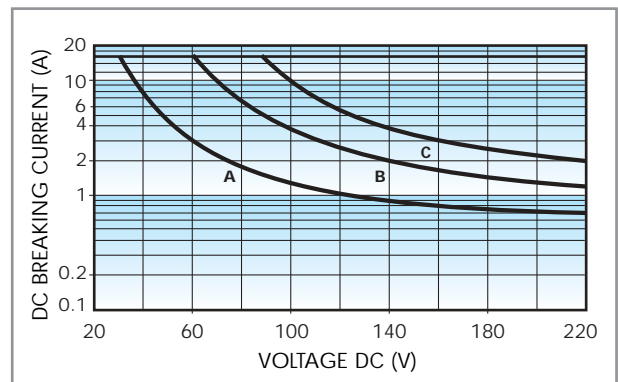

Breaking capacity for DC1 load.

- A** = Load applied to 1 contact.
- B** = Load applied to 2 contacts in series.
- C** = Load applied to 3 contacts in series.

- When switching a resistive load (DC1) having voltage and current values under the curve the expected electrical life is $\geq 100 \cdot 10^3$ cycles.
- In case of DC13 loads the connection of a diode in parallel with the load will permit the same electrical life as for a DC1 load.

Note: the release time of load will be increase.

COIL SPECIFICATIONS

DC VERSION DATA

Nominal voltage U_N V	Coil code	Operating range		Resistance R Ω	Rated coil consumption I at U_N mA
		U_{min} V	U_{max} V		
6	9.006	4.8	6.6	28	214
12	9.012	9.6	13.2	110	109
24	9.024	19.2	26.4	445	54
48	9.048	38.4	52.8	1,770	27
60	9.060	48	66	2,760	21.7
110	9.110	88	121	9,420	11.7
125	9.125	100	137.5	12,000	10.4
220	9.220	176	242	37,300	5.8

AC VERSION DATA

Nominal voltage U_N V	Coil code	Operating range		Resistance R Ω	Rated coil consumption I at U_N (50Hz) mA
		U_{min} V	U_{max} V		
6	8.006	4.8	6.6	4.6	367
12	8.012	9.6	13.2	19	183
24	8.024	19.2	26.4	74	90
48	8.048	38.4	52.8	290	47
60	8.060	48	66	450	37
110	8.110	88	121	1,600	20
120	8.120	96	132	1,940	18.6
230	8.230	184	253	7,250	10.5
240	8.240	192	264	8,500	9.2
400	8.400	320	440	19,800	6

DC (NO) VERSION DATA (≥ 3 mm)

Nominal voltage U_N V	Coil code	Operating range		Resistance R Ω	Rated coil consumption I at U_N mA
		U_{min} V	U_{max} V		
6	9.006	5.1	6.6	12	500
12	9.012	10.2	13.2	48	250
24	9.024	20.4	26.4	192	125
48	9.048	40.8	52.8	770	63
60	9.060	51	66	1,200	50
110	9.110	93.5	121	4,200	26
125	9.125	106.2	137.5	5,200	24
220	9.220	187	242	17,600	12.5

AC (NO) VERSION DATA (≥ 3 mm)

Nominal voltage U_N V	Coil code	Operating range		Resistance R Ω	Rated coil consumption I at U_N (50Hz) mA
		U_{min} V	U_{max} V		
6	8.006	5.1	6.6	4	540
12	8.012	10.2	13.2	14	275
24	8.024	20.4	26.4	62	130
48	8.048	40.8	52.8	220	70
60	8.060	51	66	348	55
110	8.110	93.5	121	1,200	30
120	8.120	106	137	1,350	24
230	8.230	196	253	5,000	14
240	8.240	204	264	6,300	12.5
400	8.400	340	440	14,700	7.8

R 62 DC

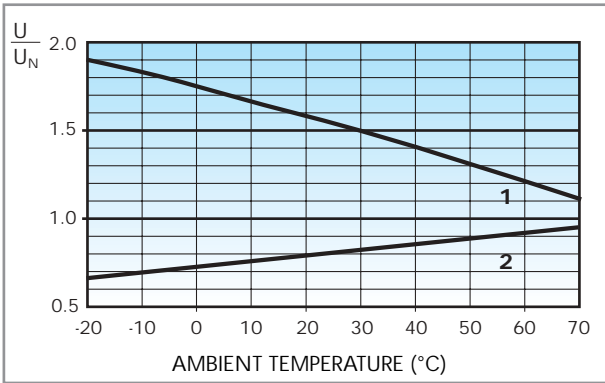

R 62 AC

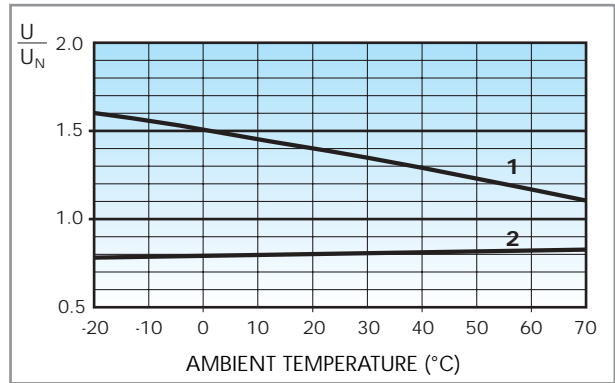

R 62 DC (NO)

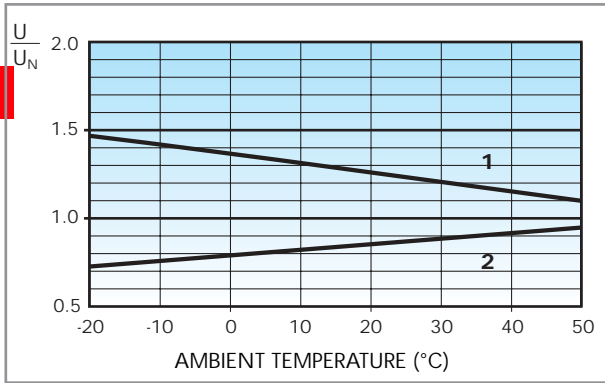

R 62 AC (NO)

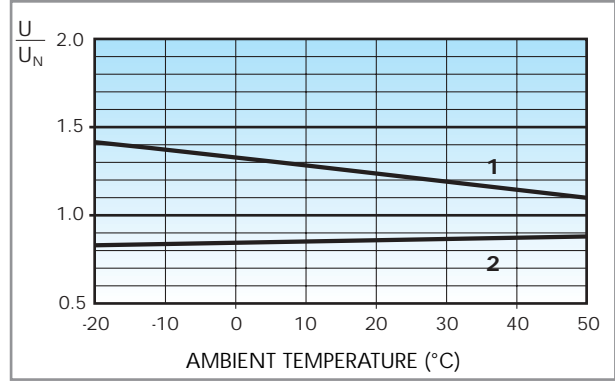

Operating range (DC type) vs ambient temperature.

1 - Max coil voltage permitted.

2 - Min pick-up voltage with coil at ambient temperature.

Operating range (AC type) vs ambient temperature.

1 - Max coil voltage permitted.

2 - Min pick-up voltage with coil at ambient temperature.



92.03

Approvals
(according to type):



- RATED VALUES: 16 A - 250 V
- INSULATION: ≥ 6 kV (1.2/50 μ s) between coil and contacts
- PROTECTION CATEGORY: IP 20
- AMBIENT TEMPERATURE: (-40...+70) $^{\circ}$ C
- \oplus SCREW TORQUE: 0.8 Nm
- WIRE STRIP LENGTH: 10 mm
- MAX WIRE SIZE:

	solid wire	stranded wire
mm ²	1x10 / 2x4	1x6 / 2x4
AWG	1x8 / 2x12	1x10 / 2x12

Relay type	62.32, 62.33	
Colour	BLUE	BLACK
Clamp terminal socket: panel or 35 mm rail (EN 50022) mount retaining clip 092.71 supplied with socket packaging code SMA	92.03	92.03.0
Metal retaining clip	092.71	
Modules (see table below)	99.02	
Timer modules	86.00, 86.10, 86.20	

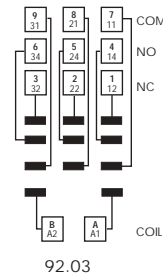
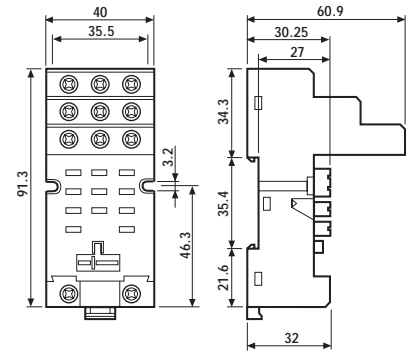

92.03

FOR 92.03 SOCKET:



86.00

86 Series Module Timers (see technical data pages 126/131)	
Multi-voltage: 12...240 V AC/DC;	
Multi-functions: AI, DI, SW, BE, CE, DE, EE, FE; (0.05s...100h)	86.00.0.240.0000
Mono-function: 12...24 V AC/DC; function AI; (1.5s...60min)	86.10.0.024.0000
Mono-function: 12...24 V AC/DC; function DI; (1.5s...60min)	86.20.0.024.0000



99.02

Approvals
(according to type):



* Modules in Black housing are available on request.

**For DC supply, apply the positive to terminal A1.

99.02 coil indication and EMC suppression modules (see technical data page 179)		BLUE*
Diode** (+A1, standard polarity)	(6...220) V DC	99.02.3.000.00
Diode (+A2, non standard polarity)	(6...220) V DC	99.02.2.000.00
LED	(6...24) V DC/AC	99.02.0.024.59
LED	(28...60) V DC/AC	99.02.0.060.59
LED	(110...240) V DC/AC	99.02.0.230.59
LED + Diode** (+A1, standard polarity)	(6...24) V DC	99.02.9.024.99
LED + Diode** (+A1, standard polarity)	(28...60) V DC	99.02.9.060.99
LED + Diode** (+A1, standard polarity)	(110...220) V DC	99.02.9.220.99
LED + Diode (+A2, non standard polarity)	(6...24) V DC	99.02.9.024.79
LED + Diode (+A2, non standard polarity)	(28...60) V DC	99.02.9.060.79
LED + Diode (+A2, non standard polarity)	(110...220) V DC	99.02.9.220.79
LED + Varistor	(6...24) V DC/AC	99.02.0.024.98
LED + Varistor	(28...60) V DC/AC	99.02.0.060.98
LED + Varistor	(110...240) V DC/AC	99.02.0.230.98
RC circuit	(6...24) V DC/AC	99.02.0.024.09
RC circuit	(28...60) V DC/AC	99.02.0.060.09
RC circuit	(110...240) V DC/AC	99.02.0.230.09
Retaining current by-pass (62 k Ω /1W)	(110...240) V AC	99.02.8.230.07



92.13

Relay type	62.32, 62.33	
Colour	BLUE	BLACK
P.C.B. socket	92.13	92.13.0
retaining clip 092.54 supplied with socket packaging code SMA		
Metal retaining clip	092.54	

Approvals
(according to type):



- RATED VALUES: 16 A - 250 V (10 A max for each contact circuit)
- DIELECTRIC STRENGTH: ≥ 2.5 kV AC
- AMBIENT TEMPERATURE: (-40...+70) $^{\circ}$ C

- 62.3X plug on 92.13 is 63.3 mm high

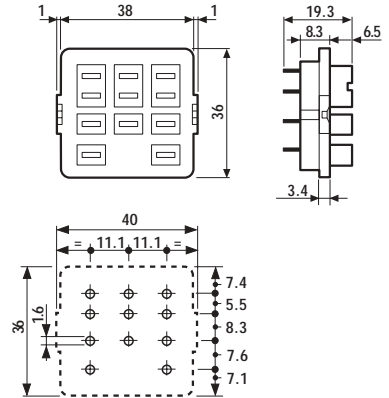

62



92.33

Relay type	62.32, 62.33	
Colour	BLUE	
Panel mount solder socket: mounted with M3 screw	92.33	
retaining clip 092.54 supplied with socket packaging code SMA		
Metal retaining clip	092.54	

Approvals
(according to type):



- RATED VALUES: 16 A - 250 V (10 A max for each contact circuit)
- DIELECTRIC STRENGTH: ≥ 2.5 kV AC
- AMBIENT TEMPERATURE: (-40...+70) $^{\circ}$ C

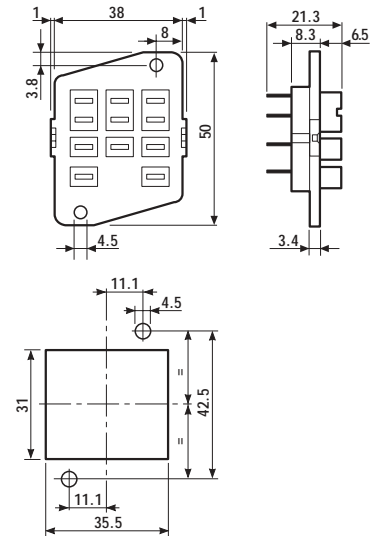

PACKAGING CODES

How to code and identify retaining clip and packaging options for sockets.

Code options according to the last three letters:



A Standard packaging

SM Metal retaining clip
SX No retaining clip

- P.C.B. or Flange mount
- AC or DC coils

65.31

65.61

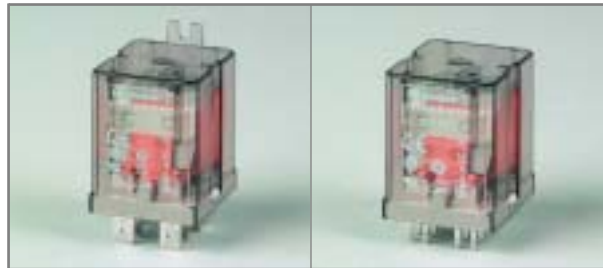

- 1 NO + 1NC
- Flange mount
- Faston 250 (6.3 x 0.8 mm)

- 1 NO + 1NC
- P.C.B. mounting
- Bifurcated terminals

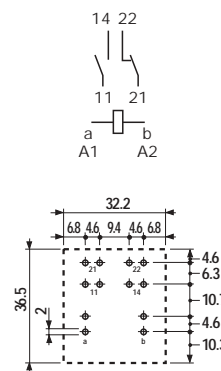
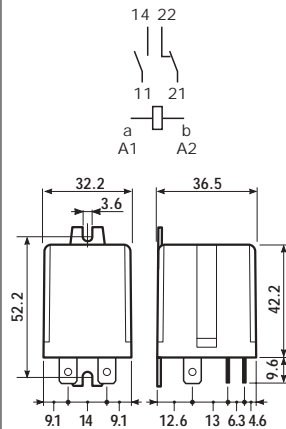

Copper side view
h = 46 mm

* For 400 V applications, where requirements for pollution degree 2 are met.

Contact specifications			
Contact configuration		1 NO + 1 NC	1 NO + 1 NC
Rated current/Maximum peak current	A	20/40	20/40
Rated voltage/Maximum switching voltage	V AC	250/400*	250/400*
Rated load in AC1	VA	5,000	5,000
Rated load in AC15 (230 VAC)	VA	1,000	1,000
Single phase motor rating (230 VAC)	kW	1.1	1.1
Breaking capacity in DC1: 30/110/220V	A	20/0.8/0.5	20/0.8/0.5
Minimum switching load	mW (V/mA)	1,000 (10/10)	1,000 (10/10)
Standard contact material		AgCdO	AgCdO
Coil specifications			
Nominal voltage (U _N)	V AC (50/60 Hz)	6 - 12 - 24 - 48 - 60 - 110 - 120 - 230 - 240 - 400	
	V DC	6 - 12 - 24 - 48 - 60 - 110 - 125 - 220	
Rated power AC/DC	VA (50 Hz)/W	2.2/1.3	2.2/1.3
Operating range	AC	(0.8...1.1)U _N	
	DC	(0.85...1.1)U _N	
Holding voltage	AC/DC	0.8 U _N /0.6 U _N	0.8 U _N /0.6 U _N
Must drop-out voltage	AC/DC	0.2 U _N /0.1 U _N	0.2 U _N /0.1 U _N
Technical data			
Mechanical life AC/DC	cycles	10 · 10 ⁶ /30 · 10 ⁶	10 · 10 ⁶ /30 · 10 ⁶
Electrical life at rated load AC1	cycles	80 · 10 ³	80 · 10 ³
Operate/release time	ms	10/12	10/12
Insulation according to EN 61810-5		4 kV/3	4 kV/3
Insulation between coil and contacts (1.2/50µs)		4	4
Dielectric strength between open contacts		1,500	1,500
Ambient temperature range		-40...+75	-40...+75
Environmental protection		RT I	RT I
Approvals: (according to type)			

P.C.B. or Flange mount

- AC or DC coils
- 3 mm gap between open contacts on NO version

65.31 - 0300

65.61 - 0300



- 1 NO (3mm contact gap)
- Flange mount
- Faston 250 (6.3 x 0.8 mm)

- 1 NO (3mm contact gap)
- P.C.B. mounting
- Bifurcated terminals

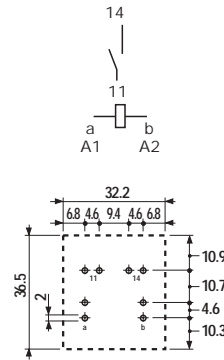
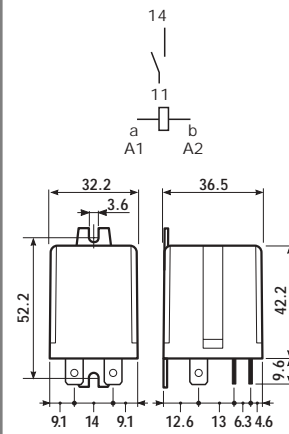

Copper side view

h = 42 mm

65

* For 400 V applications, where requirements for pollution degree 2 are met.

** Distance between contacts >3mm (EN 60335-1)

Contact specifications			
Contact configuration			1 NO 3 mm**
Rated current/Maximum peak current	A	30/50	30/50
Rated voltage/Maximum switching voltage	V AC	250/400*	250/400*
Rated load in AC1	VA	7,500	7,500
Rated load in AC15 (230 VAC)	VA	1,250	1,250
Single phase motor rating (230 VAC)	kW	1.5	1.5
Breaking capacity in DC1: 30/110/220V	A	30/1.1/0.7	30/1.1/0.7
Minimum switching load	mW (V/mA)	1,000 (10/10)	1,000 (10/10)
Standard contact material		AgCdO	AgCdO
Coil specifications			
Nominal voltage (U _N)	V AC (50/60 Hz)	6 - 12 - 24 - 48 - 60 - 110 - 120 - 230 - 240 - 400	
	V DC	6 - 12 - 24 - 48 - 60 - 110 - 125 - 220	
Rated power AC/DC	VA (50 Hz)/W	2.2/1.3	2.2/1.3
Operating range	AC	(0.8...1.1)U _N	
	DC	(0.85...1.1)U _N	
Holding voltage	AC/DC	0.8 U _N /0.6 U _N	
Must drop-out voltage	AC/DC	0.2 U _N /0.1 U _N	
Technical data			
Mechanical life AC/DC	cycles	10 · 10 ⁶ /30 · 10 ⁶	
Electrical life at rated load AC1	cycles	50 · 10 ³	
Operate/release time	ms	15/4	
Insulation according to EN 61810-5		4 kV/3	
Insulation between coil and contacts (1.2/50μs)		4	
Dielectric strength between open contacts		2,500 V AC	
Ambient temperature range		-40...+75 °C	
Environmental protection		RT I	
Approvals: (according to type)			

ORDERING INFORMATION

Example: a 65 series power relay, for P.C.B. with bifurcated terminals, 1 NC + 1 NO contact with a 12 V DC coil.

6
5
.
6
1
.
9
.
0
1
2
.
0
0
0
0

Series _____

Type _____
 3 = Faston 250 (6.3x0.8 mm) with rear flange mount
 6 = P.C.B. with bifurcated terminals

No. of poles _____
 1 = 1 NC + 1 NO

Coil version _____
 8 = AC (50/60 Hz)
 9 = DC

Coil voltage _____
 see coil specifications

A: Contact material
 0 = Standard AgCdO

B: Contact circuit
 0 = 1 NO + 1 NC
 3 = NO (≥ 3 mm contact gap)

D: Special versions
 0 = Standard
 5 = Top flange mount
 7 = Top 35 mm rail (EN 50022) mount
 8 = Rear 35 mm rail (EN 50022) mount

C: Options
 0 = None

Only combinations in the same row are possible

Preferred versions

	coil version	A	B	C	D
65.31	AC-DC	0	0	0	0
65.61	AC-DC	0	0	0	0

All versions

	coil version	A	B	C	D
65.31	AC-DC	0	0 - 3	0	0 - 5 - 7 - 8
65.61	AC-DC	0	0 - 3	0	0

POSSIBLE OPTIONS

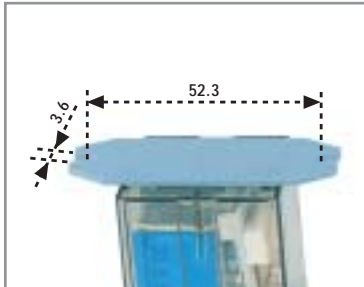

Option = 0005
TOP FLANGE MOUNT



Option = 0008
REAR 35 mm RAIL MOUNT

TECHNICAL DATA

INSULATION

INSULATION according to EN 61810-5	insulation rated voltage	V	250
	rated impulse withstand voltage	kV	4
	pollution degree		3
	overvoltage category		III

IMMUNITY

CONDUCTED DISTURBANCE IMMUNITY	BURST (according to EN 61000-4-4) level 4 (4kV)
	SURGE (according to EN 61000-4-5) level 4 (4kV)

OTHER DATA

BOUNCE TIME: NO/NC	ms	5/6 (1 NO + 1 NC version)	7/- (NO version)
VIBRATION RESISTANCE (10...55Hz): NO/NC	g/g	10/4	
POWER LOST TO THE ENVIRONMENT		1 NO + 1 NC	1 NO
	-without contact current	W	1.3
	-with rated current	W	2.1
RECOMMENDED DISTANCE between RELAYS mounted on P.C.B.s	mm	≥5	

CONTACT SPECIFICATIONS

F 65

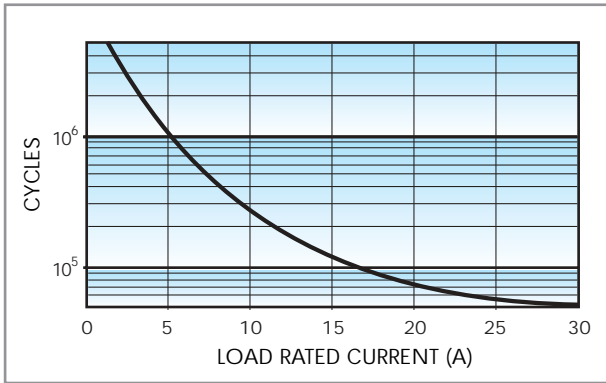

Electrical life vs AC1 load.

H 65

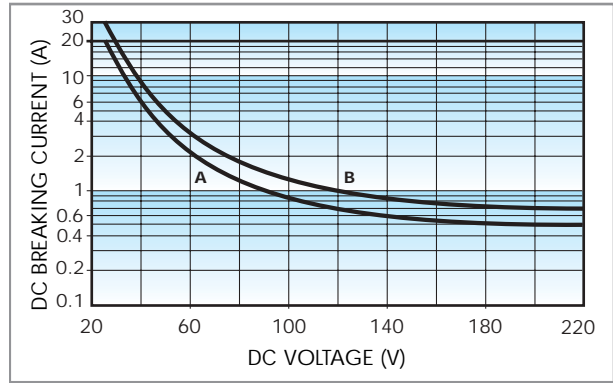

Breaking capacity for DC1 load.

Load applied to 1 contact

A - 1 NO + 1 NC type

B - 1 NO type

- When switching a resistive load (DC1) having voltage and current values under the curve the expected electrical life is $\geq 100 \cdot 10^3$ cycles.

- In case of DC13 loads the connection of a diode in parallel with the load will permit the same electrical life as for a DC1 load.

Note: the release time of load will be increase.

65

COIL SPECIFICATIONS

DC VERSION DATA

Nominal voltage U_N V	Coil code	Operating range		Resistance R Ω	Rated coil consumption I at U_N mA
		U_{min} V	U_{max} V		
6	9.006	5.1	6.6	28	214
12	9.012	10.2	13.2	110	109
24	9.024	8.8	26.4	445	54
48	9.048	40.8	52.8	1,770	27.1
60	9.060	51	66	2,760	21.7
110	9.110	93.5	121	9,420	11.7
125	9.125	100	137.5	12,000	10.4
220	9.220	176	242	37,300	5.8

AC VERSION DATA

Nominal voltage U_N V	Coil code	Operating range		Resistance R Ω	Rated coil consumption I at U_N (50Hz) mA
		U_{min} V	U_{max} V		
6	8.006	4.8	6.6	4.6	367
12	8.012	9.6	13.2	19	183
24	8.024	19.2	26.4	74	90
48	8.048	38.4	52.8	290	47
60	8.060	48	66	450	37
110	8.110	88	121	1,600	20
120	8.120	96	132	1,940	18.6
230	8.230	184	253	7,250	10.5
240	8.240	192	264	8,500	9.2
400	8.400	320	440	19,800	6

R 65 DC

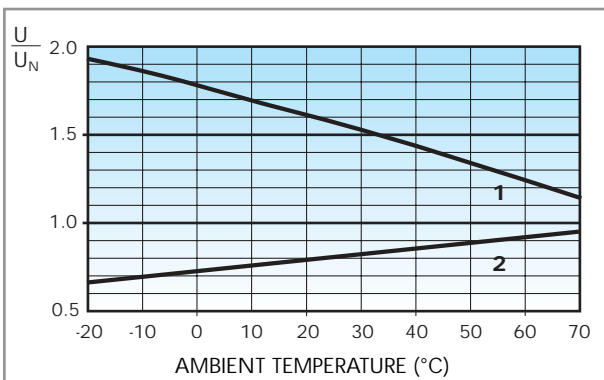

Operating range (DC type) vs ambient temperature.

1 - Max coil voltage permitted.

2 - Min pick-up voltage with coil at ambient temperature.

R 65 AC

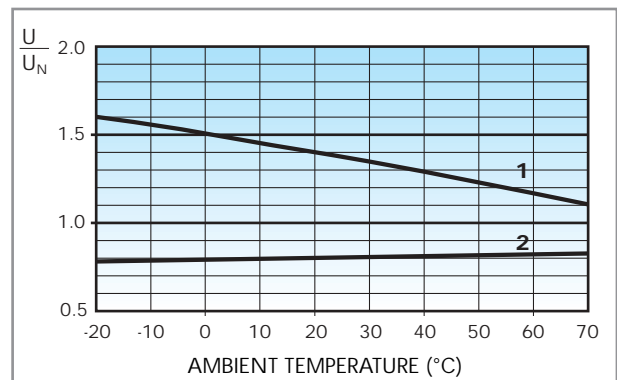

Operating range (AC type) vs ambient temperature.

1 - Max coil voltage permitted.

2 - Min pick-up voltage with coil at ambient temperature.

19.21

- 3 functions selector switch:
 - Auto (works as a monostable relay)
 - Off (relay permanently OFF)
 - On (relay permanently ON)
- LED indicator
- 35 mm rail (EN 50022) mount
- Insulation between supply and contact terminals



- One module (11.2 mm) wide
- 1 pole
- feedback contact

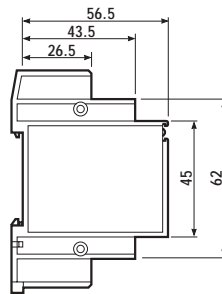

Contact specifications		
Contact configuration		1 CO
Rated current/Max. peak current	A	10/15
Rated voltage/Max. switching voltage	V AC	250/400
Rated load in AC1	VA	2,500
Rated load in AC15 (230 VAC)	VA	500
Single phase motor rating (230 VAC)	kW	0.44
Breaking capacity in DC1: 30/110/220V	A	10/0.3/0.12
Minimum switching load	mW (V/mA)	1,000 (10/10)
Standard contact material		AgCdO
Supply specifications		
Nominal voltage	V AC (50/60Hz)	24
	V DC	24
Rated power AC/DC	VA (50Hz)/W	0.6/0.4
Operating range	V AC	(0.8... 1.1)U _N
	V DC	(0.8... 1.1)U _N
Technical data		
Mechanical life	cycles	10 · 10 ⁶
Electrical life at rated load in AC1	cycles	100 · 10 ³
Insulation between coil and contacts (1.2/50µs)	kV	4
Dielectric strength between open contacts	V AC	1,000
Ambient temperature range	°C	-10...+50
Protection category		IP 20
Approvals: (according to type)		GOST

ORDERING INFORMATION

Example: a 19 series relay modular Auto-Off-On with 1 CO - 10 A contact, rated at 24 V AC/DC supply.

1 9 . 2 1 . 0 . 0 2 4 . 0 0 0 0

Series

Type

2 = 35 mm rail (EN 50022) mount, 11.2 mm

No. of poles

1 = 1 pole

Supply voltage

024 = 24 V

Supply version

0 = AC (50/60 Hz)/DC

TECHNICAL DATA

CONTACT SPECIFICATIONS

NOMINAL RATE LAMPS		
- incandescent (230V)	W	1,000
- compensated fluorescent (230V)	W	350
- uncompensated fluorescent (230V)	W	500
- halogen (230V)	W	1,000

INSULATION

DIELECTRIC STRENGTH		
- between supply and contacts	V AC	3,000
- between open contacts	V AC	1,000

OTHER DATA

POWER LOST TO THE ENVIRONMENT		
- without contact current	W	0.4
- with rated current	W	1.8
MAX WIRE SIZE		
		solid cable
	mm ²	1x6 / 2x2.5
	AWG	1x10 / 2x14
		stranded cable
		1x4 / 2x1.5
		1x12 / 2x16
SCREW TORQUE		
	Nm	0.5

WIRING DIAGRAM

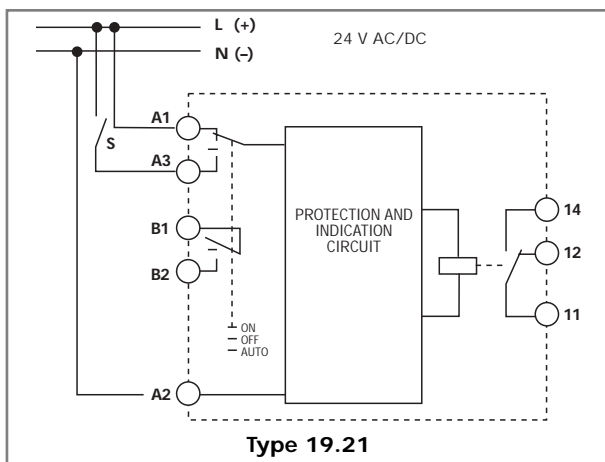

The max switching voltage between B₁ and B₂ terminal is 24 V AC/DC (300mA).

SELECTOR POSITION

Selector switch	Control switch (S)	Output relay	LED	B ₁ -B ₂ contact
AUTO	Closed	ON	ON	Closed
	Open	OFF	OFF	Closed
ON	—	ON	ON	Open
OFF	—	OFF	OFF	Open

The B₁ - B₂ contact signals when the selector switch is in the Auto position. The LED indicates the state of the Modular relay's output contacts.

ACCESSORIES



019.40

Sheet of marker tags (40 tags): 8x10mm

019.40

- Relay interface modules for use with PLC systems, 6.2 mm wide
- Sensitive DC coil or AC/DC coil version
- Supplied with integral coil indication and protection circuit
- Instant removal of relay using plastic retaining clip
- 35 mm rail (EN 50022) mounting

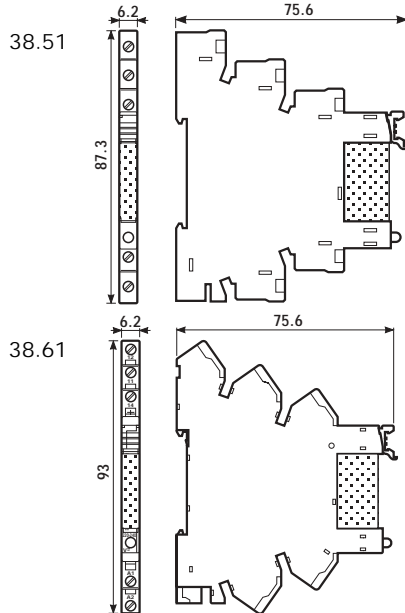

* for 400 V applications, requirements for pollution degree 2 are met.

	38.51	38.61	38.51.3 / 38.61.3
	<ul style="list-style-type: none"> - Screw terminal - Electromechanical relay - 35 mm rail mounting 	<ul style="list-style-type: none"> - Screwless terminal - Electromechanical relay - 35 mm rail mounting 	<ul style="list-style-type: none"> - Leakage current suppression - Electromechanical relay - 35 mm rail mounting
Contact specifications			
Contact configuration	1 CO	1 CO	1 CO
Rated current/Maximum peak current A	6/10	6/10	6/10
Rated voltage/Maximum switching voltage V AC	250/400*	250/400*	250/400*
Rated load in AC1 VA	1,500	1,500	1,500
Rated load in AC15 (230 VAC) VA	300	300	300
Single phase motor rating (230 VAC) kW	—	—	—
Breaking capacity in DC1: 30/110/220V A	6/0.2/0.15	6/0.2/0.15	6/0.2/0.15
Minimum switching load mW (V/mA)	500 (12/10)	500 (12/10)	500 (12/10)
Standard contact material	AgNi	AgNi	AgNi
Coil specifications			
Nominal voltage (U _N) V DC/AC	12 · 24 · 48 · 60 · 110...125 · 220...240	12 · 24 · 48 · 60 · 110...125 · 220...240	110...125 230...240 AC
	V DC	6 · 12 · 24 · 48 · 60	—
Rated power AC/DC VA (50 Hz)/W	see table page 91	see table page 91	see table page 91
Operating range AC/DC	see table page 91	see table page 91	see table page 91
	DC	see table page 91	—
Holding voltage AC/DC	0.6 U _N /0.6 U _N	0.6 U _N /0.6 U _N	0.6 U _N /0.6 U _N
Must drop-out voltage AC/DC	0.1 U _N /0.05 U _N	0.1 U _N /0.05 U _N	see table page 91
Technical data			
Mechanical life AC/DC cycles	—/10 · 10 ⁶	—/10 · 10 ⁶	—/10 · 10 ⁶
Electrical life at rated load AC1 cycles	60 · 10 ³	60 · 10 ³	60 · 10 ³
Operate/release time ms	5/6	5/6	5/6
Insulation according to EN 61810-5	4 kV/3	4 kV/3	4 kV/3
Insulation between coil and contacts (1.2/50µs) kV	6 (8mm)	6 (8mm)	6 (8mm)
Dielectric strength between open contacts V AC	1,000	1,000	1,000
Ambient temperature range (≤60V/>60V) °C	-40...+70/-40...+55	-40...+70/-40...+55	-40...+70/-40...+55
Protection category	IP20	IP20	IP20
Approvals (relay): (according to type)			

- Relay interface modules for use with PLC systems, 6.2 mm wide
- Sensitive DC coil or AC/DC coil version
- Supplied with integral coil indication and protection circuit
- Instant removal of relay using plastic retaining clip
- 35 mm rail (EN 50022) mounting

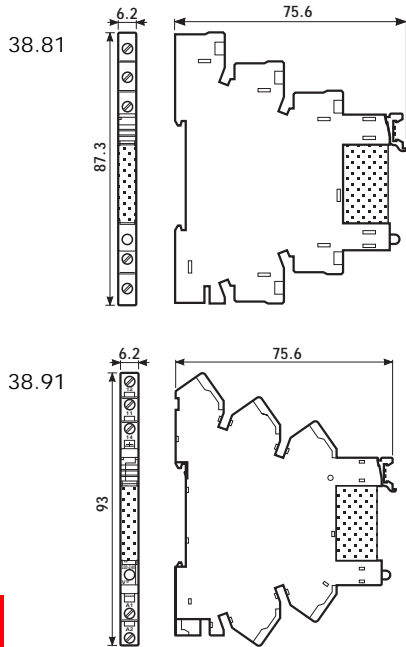
38.81
38.91
38.81.3/38.91.3

- | | | |
|--|--|---|
| <ul style="list-style-type: none"> - Screw terminal - SSR relay - 35 mm rail mounting | <ul style="list-style-type: none"> - Screwless terminal - SSR relay - 35 mm rail mounting | <ul style="list-style-type: none"> - Leakage current suppression - SSR relay - 35 mm rail mounting |
|--|--|---|

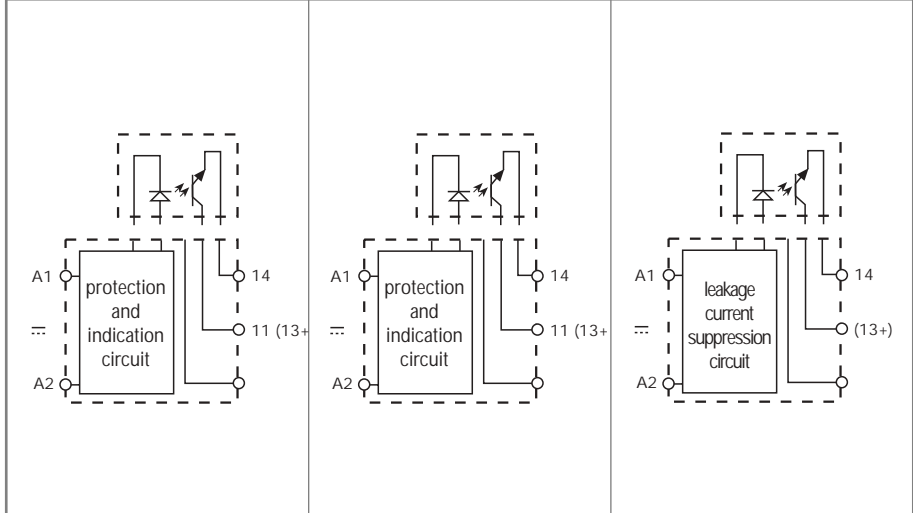

Output circuit							
Rated current/Maximum peak current (10 ms)	A	2/20	0.1/0.5	2/20	0.1/0.5	2/20	0.1/0.5
Rated voltage/Maximum blocking voltage	V DC	24/33	48/60	24/33	48/60	24/33	48/60
Switching voltage range	V DC	1.5...24	1.5...48	1.5...24	1.5...48	1.5...24	1.5...48
Minimum switching current	mA	1	0.05	1	0.05	1	0.05
Max "OFF-state" leakage current	µA	1	1	1	1	1	1
Max "ON-state" voltage drop	V	0.12	1	0.12	1	0.12	1
Input circuit							
Nominal voltage	V	24 - 60 DC		24 - 60 DC		120...125 AC/DC 230...240 AC	
Operating range	V DC	see table page 92		see table page 92		see table page 92	
Control current	mA	see table page 92		see table page 92		see table page 92	
Release voltage	V DC	see table page 92		see table page 92		see table page 92	
Impedance	Ω	3,200	21,300	3,200	21,300	—	
Technical data							
Operate/release time	µs	100/400	20/110	100/400	20/110	100/400	20/110
Dielectric strength between input/output	V	2,500		2,500		2,500	
Ambient temperature range	°C	-20...+55		-20...+55		-20...+55	
Environmental protection		IP20		IP20		IP20	
Approvals: (according to type)		—		—		—	

ORDERING INFORMATION

ELECTROMECHANICAL RELAY (EMR)

Example: a 38 series relay interface module with 1 CO contact, with coil rated at 12 V DC.

3

8

.

5

1

.

7

.

0

1

2

.

0

0

5

0

Series ————

Type ————
 5 = Electromechanical relay, with screw terminal
 6 = Electromechanical relay, with screwless terminal

No. of poles ————
 1 = 1 pole, 6 A

Coil version ————
 0 = AC (50/60 Hz)/ DC
 3 = Leakage current suppression (for 110...125VAC/DC - 230...240VAC only)
 7 = Sensitive DC

Coil voltage ————
 see coil specifications

A: Contact material
 0 = AgNi Standard
 4 = AgSnO₂
 5 = AgNi + Au

B: Contact circuit
 0 = CO

C: Options
 5 = Standard DC
 6 = Standard AC/DC

D: Special versions
 0 = Standard

SOLID STATE RELAY (SSR)

Example: a 38 series SSR relay interface module with 2 A, with 24 V DC supply.

3

8

.

8

1

.

7

.

0

2

4

.

9

0

2

4

Series ————

Type ————
 8 = SSR relay, with screw terminal
 9 = SSR relay, with screwless terminal

Output ————
 1 = 1 NO

Supply version ————
 3 = Leakage current suppression
 7 = DC

Supply voltage ————
 see input specifications

Output circuit
 9024 = 2 A - 24 V DC
 7048 = 0.1A - 48 V DC

The 38 Series interface modules (supply version 3) have built-in leakage current suppression to address industry concerns of the contacts not dropping-out when there is residual current in the circuit; at 110..125VAC and 230..240VAC. This problem can occur, for example, when connecting the interface modules to PLC,s with triac outputs or when connecting via relatively long cables.

ELECTROMECHANICAL RELAY

TECHNICAL DATA

INSULATION

INSULATION according to EN 61810-5	insulation rated voltage	V	250
	rated impulse withstand voltage	kV	4
	pollution degree		3
	overvoltage category		III

IMMUNITY

CONDUCTED DISTURBANCE IMMUNITY	BURST (according to EN 61000-4-4) level 4 (4kV)
	SURGE (according to EN 61000-4-5) level 3 (2kV)

OTHER DATA

BOUNCE TIME: NO/NC	ms	1/6			
VIBRATION RESISTANCE (10...55Hz): NO/NC	g/g	10/5			
POWER LOST TO THE ENVIRONMENT	W	0.2 (12V) - 0.9 (240V)			
	without contact current W	0.5 (12V) - 1.5 (240V)			
WIRE STRIP LENGTH	with rated current mm	10			
		38.51	38.61		
⊖ SCREW TORQUE	Nm	0.5		—	
MAX WIRE SIZE	mm ²	solid cable	stranded cable	solid cable	stranded cable
		1x2.5 / 2x1.5	1x2.5 / 2x1.5	1x2.5	1x2.5
		AWG	1x14 / 2x16	1x14 / 2x16	1x14

38

CONTACT SPECIFICATIONS

F 38

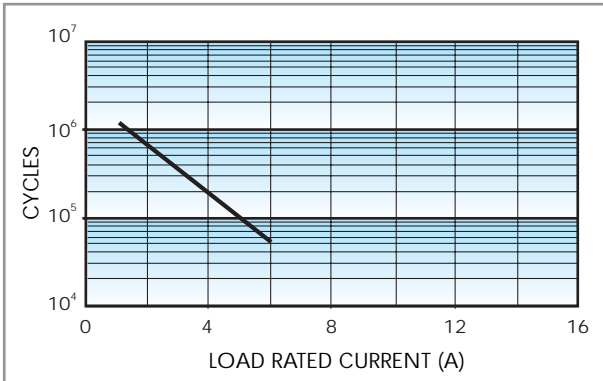

Electrical life vs AC1 load.

H 38

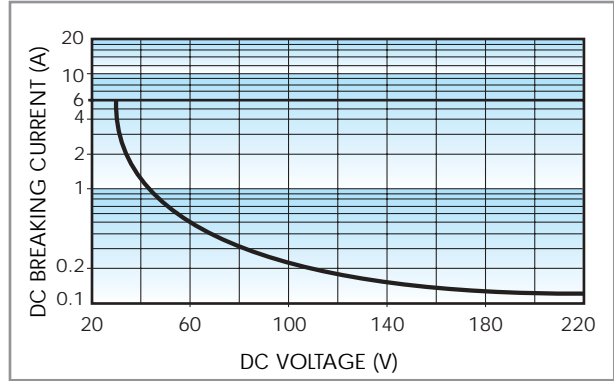

Breaking capacity in DC1 load.

- When switching a resistive load (DC1) having voltage and current values under the curve the expected electrical life is $\geq 100 \cdot 10^3$ cycles.
 - In case of DC13 loads the connection of a diode in parallel with the load will permit the same electrical life as for a DC1 load.
- Note:** the release time of load will be increase.

COIL SPECIFICATIONS

AC/DC VERSION DATA

Nominal voltage U_N V	Coil code	Operating range		Rated coil consumption I at U_N mA	Power consumption P at U_N W
		U_{min} V	U_{max} V		
12	0.012	9.8	13.2	19	0.2
24	0.024	19.2	26.4	12	0.3
48	0.048	38.4	52.8	9	0.4
60	0.060	48	66	7	0.5
110...125	0.125	88	138	5(*)	0.6(*)
220...240	0.240	184	264	4(*)	0.9(*)

DC VERSION DATA (sensitive)

Nominal voltage U_N V	Coil code	Operating range		Rated coil consumption I at U_N mA	Power consumption P at U_N W
		U_{min} V	U_{max} V		
6	7.006	5	7.2	48.1	0.3
12	7.012	9.8	14.4	15.2	0.2
24	7.024	18.2	28.8	9.4	0.2
48	7.048	35	57.6	6.3	0.3
60	7.060	43.5	72	5.2	0.3

(*) Rated coil consumption and power consumption values relate to $U_N = 125$ and 240 V.

TYPE 38.51.3/38.61.3 DATA

Nominal voltage U_N V	Coil code	Operating range		Must drop out U	Rated coil consumption I at U_N mA	Power consumption P at U_N W
		U_{min} V	U_{max} V			
110...125 AC/DC	3.125	94	138	44	8(*)	1(*)
230...240 AC	3.240	184	264	92	7(*)	0.5(*)

(*) Rated coil consumption and power consumption values relate to $U_N = 125$ and 240 V.

R 38

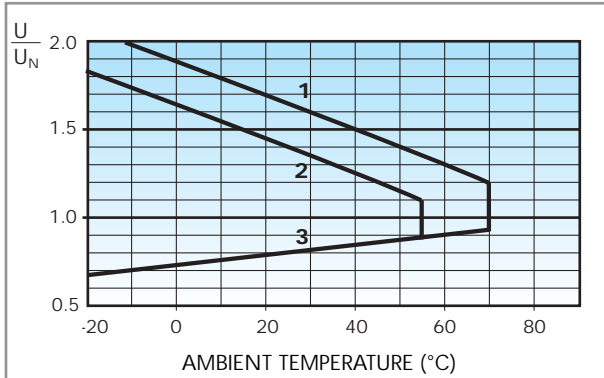

Operating range Vs ambient temperature.

- 1 - Max coil voltage permitted at nominal load (≤ 60 V versions).
- 2 - Max coil voltage permitted at nominal load (> 60 V versions).
- 3 - Min pick-up voltage with coil at ambient temperature.

SOLID STATE RELAY

OTHER DATA

POWER LOST TO THE ENVIRONMENT	without contact current	W	0.17	
	with rated current	W	0.4	
WIRE STRIP LENGTH		mm	10	
			38.81	38.91
⊖ SCREW TORQUE		Nm	0.5	
MAX WIRE SIZE			solid cable	stranded cable
		mm ²	1x2.5 / 2x1.5	1x2.5 / 2x1.5
		AWG	1x14 / 2x16	1x14 / 2x16
			solid cable	stranded cable
			1x2.5	1x2.5
			1x14	1x14

INPUT SPECIFICATION

DC VERSION DATA

Nominal voltage U_N	Supply code	Operating range		Release voltage U	Control current I at U_N
		U_{min}	U_{max}		
V		V	V	V	mA
24	7.024	16.8	30	10	7
60	7.060	35.6	72	20	3

TYPE 38.81.3/38.91.3 DATA

Nominal voltage U_N	Supply code	Operating range		Release voltage U	Rated coil consumption I at U_N	Power consumption P at U_N
		U_{min}	U_{max}			
V		V	V	V	mA	W
110...125 AC/DC	3.125	94	138	44	8(*)	1(*)
230...240 AC	3.240	184	264	72	7(*)	0.5(*)

(*) Rated coil consumption and power consumption values relate to $U_N = 125$ and 240 V.

38

OUTPUT SPECIFICATION

L 38/2A

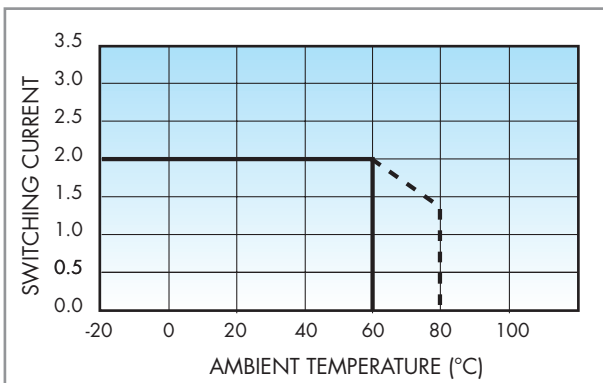

Type 38.81/91 (2A-24VDC)

Switching current vs ambient temperature

L 38/0.1A

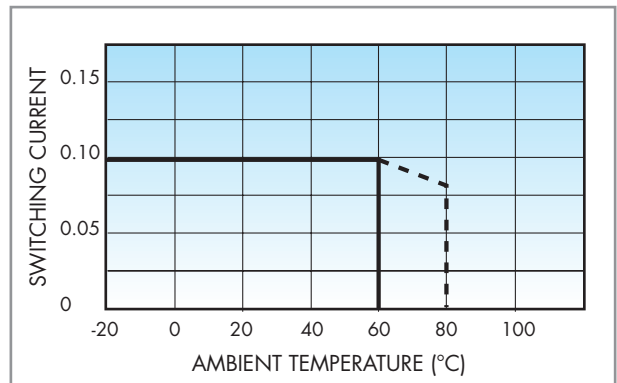

Type 38.81/91 (100mA-48VDC)

Switching current vs ambient temperature

COMBINATIONS



93.01



93.51

Approvals
(according to type):



COMBINATION FOR ELECTROMECHANICAL RELAY			
Code	Supply voltage	Type of relay	Type of socket
38.51.0.012.0060	12 V AC/DC	34.51.7.012.0010	93.01.0.024
38.51.0.024.0060	24 V AC/DC	34.51.7.024.0010	93.01.0.024
38.51.0.048.0060	48 V AC/DC	34.51.7.048.0010	93.01.0.060
38.51.0.060.0060	60 V AC/DC	34.51.7.060.0010	93.01.0.060
38.51.0.125.0060	110...125 V AC/DC	34.51.7.060.0010	93.01.0.125
38.51.0.240.0060	220...240 V AC/DC	34.51.7.060.0010	93.01.0.240
38.51.3.125.0060	110...125 V AC/DC	34.51.7.060.0010	93.01.3.125
38.51.3.240.0060	230...240 V AC	34.51.7.060.0010	93.01.3.240
38.51.7.006.0050	6 V DC	34.51.7.005.0010	93.01.7.024
38.51.7.012.0050	12 V DC	34.51.7.012.0010	93.01.7.024
38.51.7.024.0050	24 V DC	34.51.7.024.0010	93.01.7.024
38.51.7.048.0050	48 V DC	34.51.7.048.0010	93.01.7.060
38.51.7.060.0050	60 V DC	34.51.7.060.0010	93.01.7.060
38.61.0.012.0060	12 V AC/DC	34.51.7.012.0010	93.51.0.024
38.61.0.024.0060	24 V AC/DC	34.51.7.024.0010	93.51.0.024
38.61.0.125.0060	110...125 V AC/DC	34.51.7.060.0010	93.51.0.125
38.61.0.240.0060	220...240 V AC/DC	34.51.7.060.0010	93.51.0.240
38.61.3.125.0060	110...125 V AC/DC	34.51.7.060.0010	93.51.3.125
38.61.3.240.0060	230...240 V AC	34.51.7.060.0010	93.51.3.240
38.61.7.012.0050	12 V DC	34.51.7.012.0010	93.51.7.024
38.61.7.024.0050	24 V DC	34.51.7.024.0010	93.51.7.024
COMBINATION FOR SSR RELAY			
Code	Supply voltage	Type of relay	Type of socket
38.81.7.024.xxxx	24 V DC	34.81.7.024.xxxx	93.01.7.024
38.81.7.060.xxxx	60 V DC	34.81.7.060.xxxx	93.01.7.060
38.81.3.125.xxxx	110...125 V AC/DC	34.81.7.060.xxxx	93.01.3.125
38.81.3.240.xxxx	230...240 V AC	34.81.7.060.xxxx	93.01.3.240
38.91.7.024.xxxx	24 V DC	34.81.7.024.xxxx	93.51.7.024
38.91.7.060.xxxx	60 V DC	34.81.7.060.xxxx	93.51.7.060
38.91.3.125.xxxx	110...125 V AC/DC	34.81.7.060.xxxx	93.51.3.125
38.91.3.240.xxxx	230...240 V AC	34.81.7.060.xxxx	93.51.3.240

ACCESSORIES

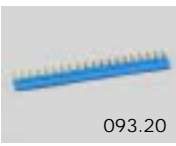

093.20

Approvals
(according to type):



20-way jumper link for 38 series	093.20
---	--------

- RATED VALUES: 36 A - 250 V

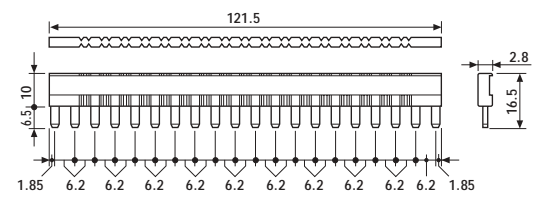

093.01

Plastic separator	093.01
--------------------------	--------

Thickness 2mm, required at the start and the end of a group of interfaces.
Can be used for visual separation group, must be used for:
- protective separation of different voltages of neighbouring PLC interfaces according to VDE 0106-101
- protection of cut jumper links

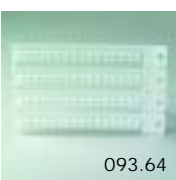

093.64

Sheet of marker tags (64 tags): 6x10mm	093.64
---	--------

- Relay interface modules for use with PLC systems, 15.8 mm wide
- AC or sensitive DC coil versions available
- Instant removal of relay using plastic retaining clip
- Supply status indication or coil suppression module provided
- Identification label
- 35 mm rail (EN 50022) mounting

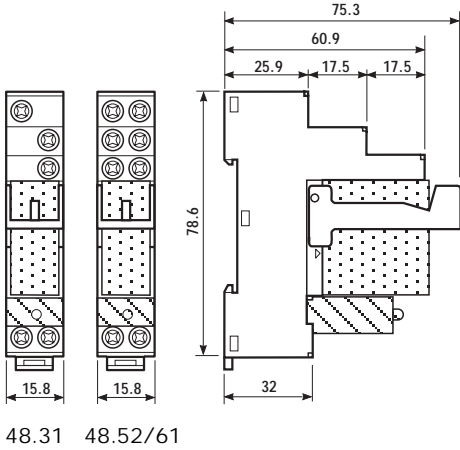

	48.31	48.52	48.61
	- 1 pole, 10 A - 35 mm rail mounting	- 2 pole, 8 A - 35 mm rail mounting	- 1 pole, 16 A - 35 mm rail mounting
48 Contact specifications			
Contact configuration	1 CO	2 CO	1 CO
Rated current/Maximum peak current A	10/20	8/15	16/30
Rated voltage/Maximum switching voltage V AC	250/400*	250/250	250/400*
Rated load in AC1 VA	2,500	2,000	4,000
Rated load in AC15 (230 VAC) VA	500	400	750
Single phase motor rating (230 VAC) kW	0.37	0.3	0.55
Breaking capacity in DC1: 30/110/220V A	10/0.3/0.12	8/0.3/0.12	16/0.3/0.12
Minimum switching load mW (V/mA)	300 (5/5)	300 (5/5)	500 (10/5)
Standard contact material	AgNi	AgNi	AgCdO
Coil specifications			
Nominal voltage (U _N)	V AC (50/60 Hz)	12 - 24 - 110 - 120 - 230	12 - 24 - 110 - 120 - 230
	V DC	12 - 24 - 125	12 - 24 - 125
Rated power AC/sens. DC VA (50 Hz)/W	1.2/0.5	1.2/0.5	1.2/0.5
Operating range	AC	(0.8...1.1)U _N	(0.8...1.1)U _N
	sens. DC	(0.73...1.75)U _N	(0.73...1.75)U _N
Holding voltage AC/DC	0.8 U _N / 0.4 U _N	0.8 U _N / 0.4 U _N	0.8 U _N / 0.4 U _N
Must drop-out voltage AC/DC	0.2 U _N / 0.1 U _N	0.2 U _N / 0.1 U _N	0.2 U _N / 0.1 U _N
Technical data			
Mechanical life AC/DC cycles	10 · 10 ⁶ /20 · 10 ⁶	10 · 10 ⁶ /—	10 · 10 ⁶ /20 · 10 ⁶
Electrical life at rated load AC1 cycles	200 · 10 ³	150 · 10 ³	100 · 10 ³
Operate/release time ms	7/4 (AC) - 12/12 (DC)	7/4 (AC) - 12/12 (DC)	7/4 (AC) - 12/12 (DC)
Insulation according to EN 61810-5	4 kV/3	4 kV/2	4 kV/3
Insulation between coil and contacts (1.2/50µs) kV	6 (8mm)	6 (8mm)	6 (8mm)
Dielectric strength between open contacts V AC	1,000	1,000	1,000
Ambient temperature range °C	-40...+70	-40...+70	-40...+70
Protection category	IP 20	IP 20	IP 20
Approvals (relay): (according to type)			

* For 400 V applications, where requirements for pollution degree 2 are met.

48.62

- Relay interface modules for use with PLC systems, 15.8 mm wide
- AC or sensitive DC coil versions available
- Instant removal of relay using plastic retaining clip
- Supply status indication or coil suppression module provided
- Identification label
- 35 mm rail (EN 50022) mounting



- 2 pole, 10 A
- 35 mm rail mounting

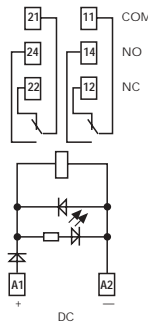
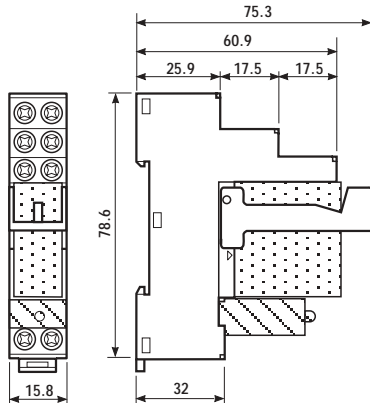

* For 400 V applications, where requirements for pollution degree 2 are met.

Contact specification		
Contact configuration		2 CO
Rated current/Maximum peak current	A	10/20
Rated voltage/Maximum switching voltage	V AC	250/400*
Rated load in AC1	VA	2,500
Rated load in AC15 (230 VAC)	VA	500
Single phase motor rating (230 VAC)	kW	0.37
Breaking capacity in DC1: 30/110/220V	A	10/0.3/0.12
Minimum switching load	mW (V/mA)	300 (5/5)
Standard contact material		AgNi
Coil specifications		
Nominal voltage (U _N)	V AC (50/60 Hz)	—
	V DC	12 · 24 · 125
Rated power AC/sens. DC	VA (50 Hz)/W	—/0.5
Operating range	AC	—
	sens. DC	(0.8...1.5)U _N
Holding voltage	AC/DC	—/0.4 U _N
Must drop-out voltage	AC/DC	—/0.1 U _N
Technical data		
Mechanical life AC/DC	cycles	—/20 · 10 ⁶
Electrical life at rated load AC1	cycles	100 · 10 ³
Operate/release time	ms	12/12 (DC)
Insulation according to EN 61810-5		4 kV/3
Insulation between coil and contacts (1.2/50µs)	kV	6 (8mm)
Dielectric strength between open contacts	V AC	1,000
Ambient temperature range	°C	-40...+70
Protection category		IP 20
Approvals (relay): (according to type)		

ORDERING INFORMATION

Example: a 48 series, 35 mm rail (EN 50022) mount relay interface module, with 2 CO - 6 A, coil rated 24 V sensitive DC, green LED + diode.

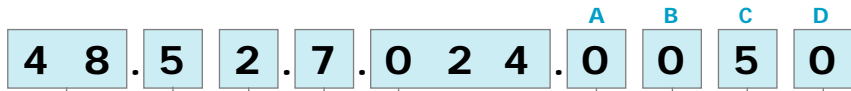

Series —

Type —

- 3 = 35 mm rail mount
- 5 = 35 mm rail mount
- 6 = 35 mm rail mount

No. of poles —

- 1 = 1 pole for 48.31, 10 A
48.61, 16 A
- 2 = 2 pole for 48.52, 8 A
48.62, 10 A, DC only

Coil version —

- 7 = Sensitive DC
- 8 = AC (50/60 Hz)

Coil voltage —

see coil specifications

A: Contact material

0 = Standard

B: Contact circuit

0 = CO

D: Special versions

0 = Standard

C: Options

- 5 = Standard for DC:
green LED + diode (polarity +A1)
- 6 = Standard for AC:
green LED + Varistor

TECHNICAL DATA

INSULATION

48

INSULATION according to EN 61810-5	insulation rated voltage	V	250	
	rated impulse withstand voltage	kV	4	
	pollution degree		3 (48.31/61/62)	2 (48.52)
	overvoltage category		III	

IMMUNITY

CONDUCTED DISTURBANCE IMMUNITY	BURST (according to EN 61000-4-4) level 4 (4kV)
	SURGE (according to EN 61000-4-5) level 3 (2kV)

OTHER DATA

BOUNCE TIME: NO/NC	ms	2/5			
VIBRATION RESISTANCE (10...55Hz): NO/NC	g/g	10/4 (1 CO)		3/3 (2 CO)	
POWER LOST TO THE ENVIRONMENT	without contact current	W			
	with rated current	W	1.2 (48.31)	1.3 (48.52)	1.2 (48.61)
WIRE STRIP LENGTH	mm	8			
SCREW TORQUE	Nm	0.5			
MAX WIRE SIZE		solid cable		stranded cable	
	mm ²	1x6 / 2x2.5		1x4 / 2x2.5	
	AWG	1x10 / 2x14		1x12 / 2x14	

CONTACT SPECIFICATIONS

F 48/1

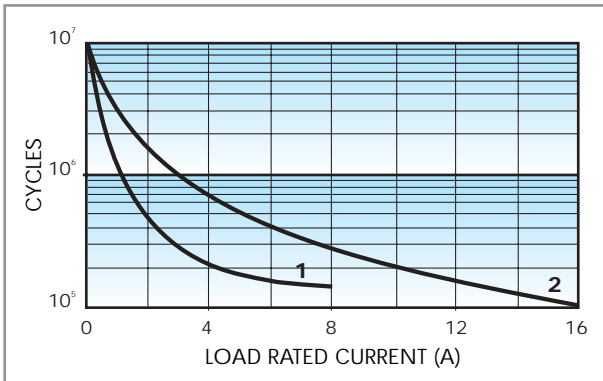

Electrical life vs AC1 load.

- 1** - Type 48.52 (8 A).
- 2** - Type 48.31 (10 A).
- Type 48.61 (16 A).

F 48/2

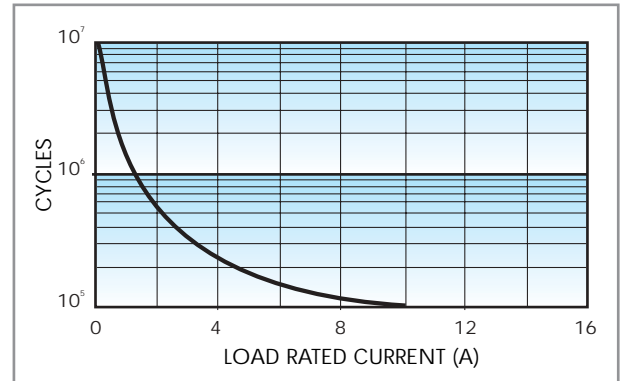

Electrical life vs AC1 load.

- Type 48.62 (10 A).

H 48/1

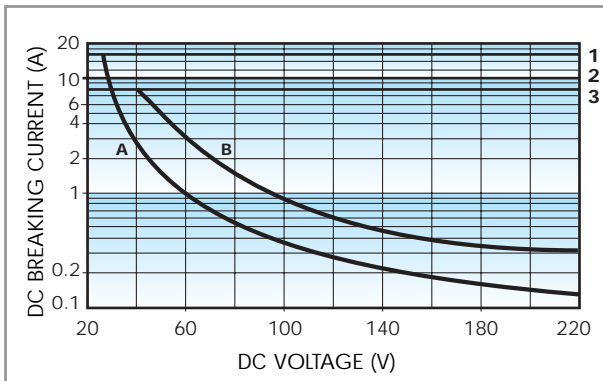

Breaking capacity for DC1 load.

- 1** - Type 48.61.
- 2** - Type 48.31.
- 3** - Type 48.52.
- A** - Load applied to 1 contact
- B** - Load applied to 2 contacts in series

- When switching a resistive load (DC1) having voltage and current values under the curve the expected electrical life is $\geq 100 \cdot 10^3$ cycles.
- In case of DC13 loads the connection of a diode in parallel with the load will permit the same electrical life as for a DC1 load.
- Note:** the release time of load will be increase.

H 48/2

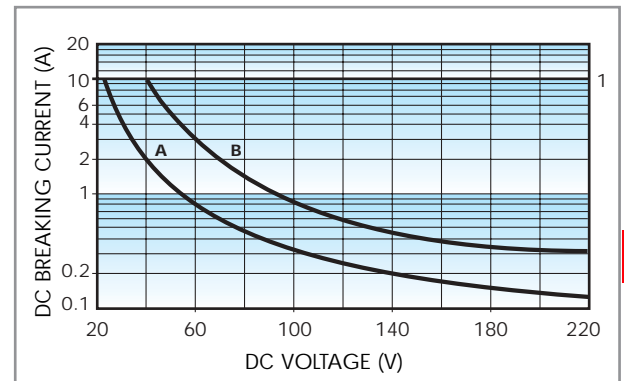

Breaking capacity for DC1 load.

- 1** - Type 48.62.
- A** - Load applied to 1 contact
- B** - Load applied to 2 contacts in series

- When switching a resistive load (DC1) having voltage and current values under the curve the expected electrical life is $\geq 100 \cdot 10^3$ cycles.
- In case of DC13 loads the connection of a diode in parallel with the load will permit the same electrical life as for a DC1 load.
- Note:** the release time of load will be increase.

COIL SPECIFICATIONS

DC VERSION DATA (0.5 W sensitive)

Nominal voltage U_N V	Coil code	Operating range		Rated coil consumption I at U_N mA
		U_{min}^* V	U_{max} V	
12	7.012	8.8	21	41
24	7.024	17.5	42	22.2
125	7.125	92	218	4

* $U_{min} = 0.8 U_N$ for 48.61 and 48.62

AC VERSION DATA

Nominal voltage U_N V	Coil code	Operating range		Rated coil consumption I at U_N (50Hz) mA
		U_{min} V	U_{max} V	
12	8.012	9.6	13.2	90.5
24	8.024	19.2	26.4	46
110	8.110	88	121	10.1
120	8.120	96	132	11.8
230	8.230	184	253	7.0

R 48 sens. DC

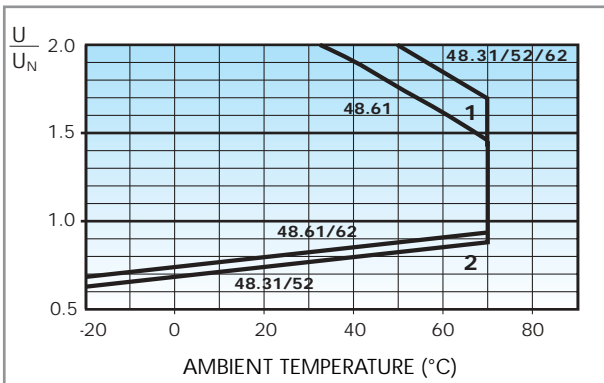

Operating range (sensitive DC version) vs ambient temperature.

- 1 - Max coil voltage permitted.
- 2 - Min pick-up voltage with coil at ambient temperature.

R 48 AC

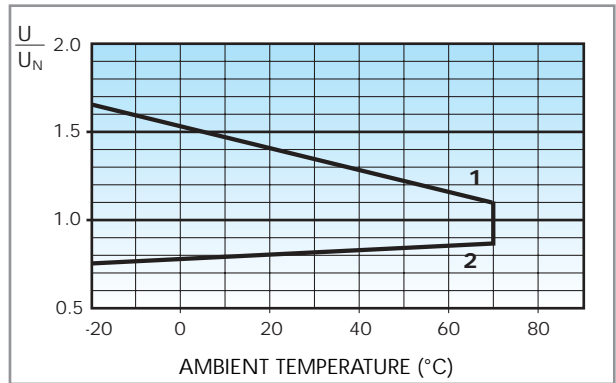

Operating range (AC version) vs ambient temperature.

- 1 - Max coil voltage permitted.
- 2 - Min pick-up voltage with coil at ambient temperature.

48

COMBINATIONS

Code	Type of Socket	Type of Relay	Module	Retaining Clip
48.31	95.03	40.31	99.02	095.01
48.52	95.05	40.52	99.02	095.01
48.61	95.05	40.61	99.02	095.01
48.62	95.05	44.62	99.02	095.01

ACCESSORIES



8-way jumper link for 48 series	095.18
--	--------

- RATED VALUES: 10 A - 250 V

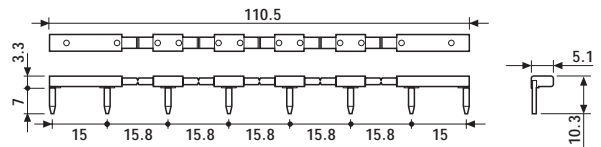

PACKAGING CODES

How to code and identify retaining clip and packaging options for relay interface module.

Code options according to the last three letters:

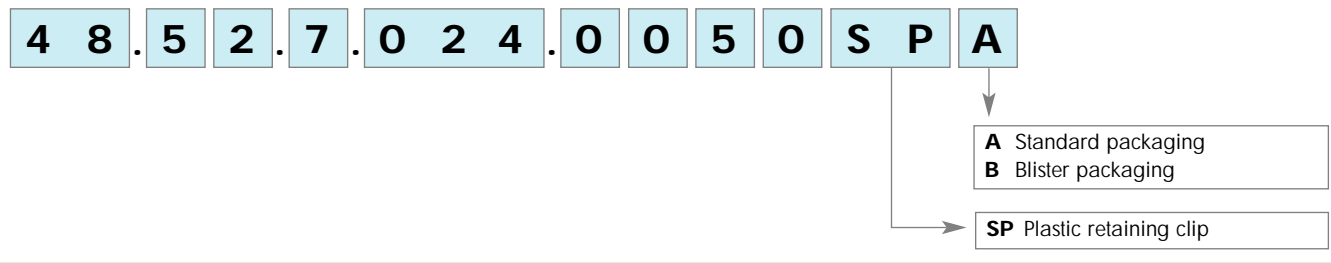

- Relay interface modules for use with PLC systems, 27mm wide
- AC and DC versions available
- Supply status indication and coil suppression module provided
- Identification label
- 35 mm rail (EN 50022) mounting

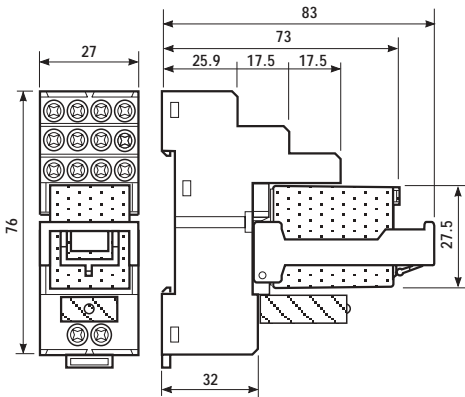

58.32

58.33

58.34



- 2 pole, 10 A
- 35 mm rail mounting

- 3 pole, 10 A
- 35 mm rail mounting

- 4 pole, 7 A
- 35 mm rail mounting

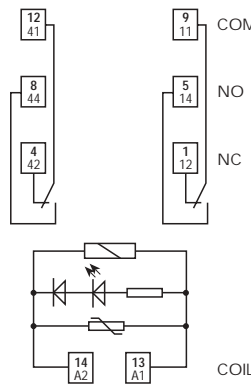

Example: AC

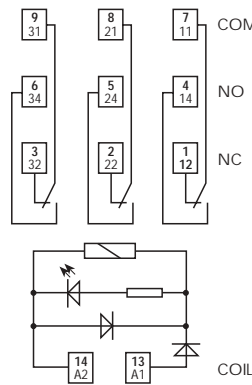

Example: DC

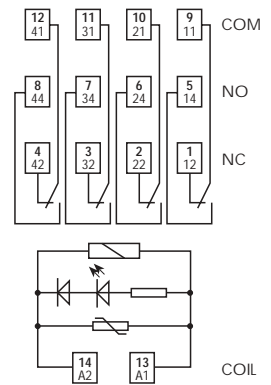

Example: AC

Contact specifications				
Contact configuration		2 CO	3 CO	4 CO
Rated current/Maximum peak current	A	10/20	10/20	7/15
Rated voltage/Maximum switching voltage	V AC	250/400	250/400	250/250
Rated load in AC1	VA	2,500	2,500	1,750
Rated load in AC15 (230 VAC)	VA	500	500	350
Single phase motor rating (230 VAC)	kW	0.37	0.37	0.125
Breaking capacity in DC1: 30/110/220V	A	10/0.25/0.12	10/0.25/0.12	7/0.25/0.12
Minimum switching load	mW (V/mA)	300 (5/5)	300 (5/5)	300 (5/5)
Standard contact material		AgNi	AgNi	AgNi
Coil specifications				
Nominal voltage (U _N)	V AC (50/60 Hz)	12 · 24 · 48 · 110 · 120 · 230		
	V DC	12 · 24 · 48		
Rated power AC/DC	VA (50 Hz)/W	1.5/1	1.5/1	1.5/1
Operating range	AC	(0.8...1.1)U _N	(0.8...1.1)U _N	(0.8...1.1)U _N
	DC	(0.8...1.1)U _N	(0.8...1.1)U _N	(0.8...1.1)U _N
Holding voltage	AC/DC	0.8 U _N /0.5 U _N	0.8 U _N /0.5 U _N	0.8 U _N /0.5 U _N
Must drop-out voltage	AC/DC	0.2 U _N /0.1 U _N	0.2 U _N /0.1 U _N	0.2 U _N /0.1 U _N
Technical data				
Mechanical life AC/DC	cycles	20 · 10 ⁶ /50 · 10 ⁶	20 · 10 ⁶ /50 · 10 ⁶	20 · 10 ⁶ /50 · 10 ⁶
Electrical life at rated load AC1	cycles	200 · 10 ³	200 · 10 ³	150 · 10 ³
Operate/release time	ms	9/3 (AC) · 9/15 (DC)	9/3 (AC) · 9/15 (DC)	9/3 (AC) · 9/15 (DC)
Insulation according to EN 61810-5		3.6 kV/2	3.6 kV/2	2.5 kV/2
Insulation between coil and contacts (1.2/50µs)	kV	3.6	3.6	3.6
Dielectric strength between open contacts	V AC	1,000	1,000	1,000
Ambient temperature range	°C	-40...+70	-40...+70	-40...+70
Protection category		IP 20	IP 20	IP 20

Approvals (relay): (according to type)



ORDERING INFORMATION

Example: a 58 series 35 mm rail (EN 55022) mounting interface module, 4 CO, 24 V DC coil with green LED + diode.

5	8	.	3	.	4	.	9	.	0	2	4	.	A	B	C	D	
Series		Type		No. of poles		Coil version		Coil voltage		A: Contact material		B: Contact circuit		C: Options		D: Special versions	
3 = 35mm rail mount		3 = 35mm rail mount		2 = 2 pole, 10 A 3 = 3 pole, 10 A 4 = 4 pole, 7 A		8 = AC (50/60 Hz) 9 = DC		see coil specifications		0 = AgNi Standard		0 = CO		5 = Standard DC: green LED + diode (polarity +A1) 6 = Standard AC: green LED + varistor		0 = Standard	

TECHNICAL DATA

INSULATION

INSULATION according to EN 61810-5	insulation rated voltage	V	400 (2-3pole)	250 (4 pole)
	rated impulse withstand voltage	kV	3.6 (2, 3 pole)	2.5 (4 pole)
	pollution degree		2	
	overvoltage category		III	

58 IMMUNITY

CONDUCTED DISTURBANCE IMMUNITY	BURST (according to EN 61000-4-4) level 4 (4kV)
	SURGE (according to EN 61000-4-5) level 4 (4kV)

OTHER DATA

BOUNCE TIME: NO/NC	ms	1/4	
VIBRATION RESISTANCE (10...55Hz): NO/NC	g/g	6/6	
POWER LOST TO THE ENVIRONMENT	without contact current	W	
	with rated current	W	3 (58.32, 58.34) 4 (58.33)
WIRE STRIP LENGTH	mm	8	
SCREW TORQUE	Nm	0.5	
MAX WIRE SIZE	mm ²	solid cable	stranded cable
		1x6 / 2x2.5	1x4 / 2x2.5
	AWG	1x10 / 2x14	1x12 / 2x14

CONTACT SPECIFICATIONS

F 58

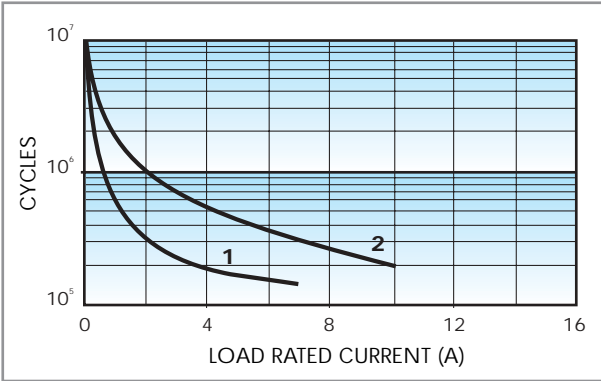

Electrical life vs AC1 load.
1 = 4 CO relay type (7 A).
2 = 2 - 3 CO relay type (10 A).

H 58

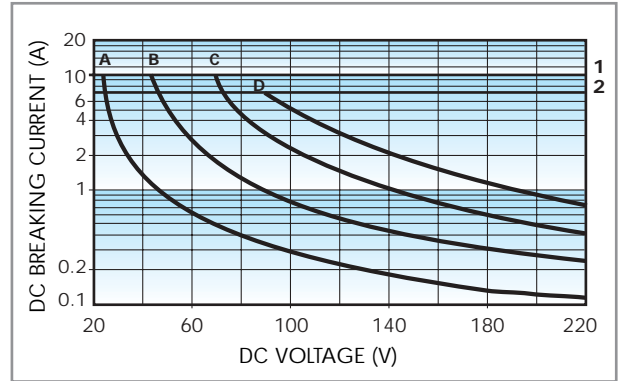

Breaking capacity for DC1 load.
1 = 2 - 3 CO type.
2 = 4 CO type.
A = Load applied to 1 contact
B = Load applied to 2 contacts in series
C = Load applied to 3 contacts in series
D = Load applied to 4 contacts in series

- When switching a resistive load (DC1) having voltage and current values under the curve the expected electrical life is $\geq 100 \cdot 10^3$ cycles.
 - In case of DC13 loads the connection of a diode in parallel with the load will permit the same electrical life as for a DC1 load.
- Note:** the release time of load will be increase.

COIL SPECIFICATIONS

DC VERSION DATA

Nominal voltage U_N V	Coil code	Operating range		Resistance R Ω	Rated coil absorption I at U_N mA
		U_{min} V	U_{max} V		
12	9.012	9.6	13.2	140	86
24	9.024	19.2	26.4	600	40
48	9.048	38.4	52.8	2,400	20

AC VERSION DATA

Nominal voltage U_N V	Coil code	Operating range		Resistance R Ω	Rated coil absorption I at U_N (50Hz) mA
		U_{min} V	U_{max} V		
12	8.012	9.6	13.2	50	97
24	8.024	19.2	26.4	190	53
48	8.048	38.4	52.8	770	25
110	8.110	88	121	4,000	12.5
120	8.120	96	132	4,700	12
230	8.230	184	253	17,000	6

58

R 58 DC

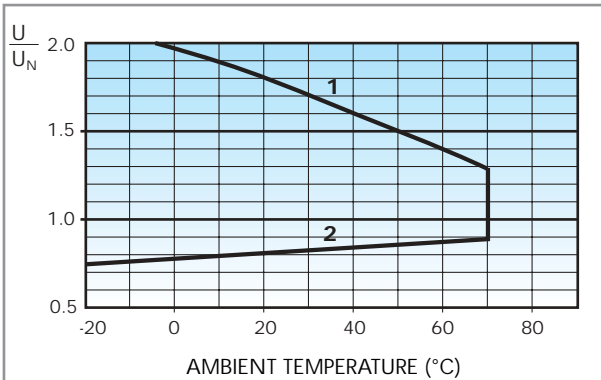

Operating range (DC type) vs ambient temperature.
1 - Max coil voltage permitted.
2 - Min pick-up voltage with coil at ambient temperature.

R 58 AC

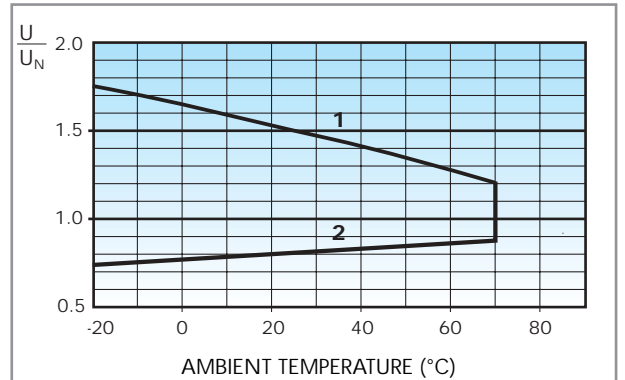

Operating range (AC type) vs ambient temperature.
1 - Max coil voltage permitted.
2 - Min pick-up voltage with coil at ambient temperature.

COMBINATIONS

Code	Type of Socket	Type of Relay	Module	Retaining Clip
58.32	94.02	55.32	99.02	094.01
58.33	94.03	55.33	99.02	094.01
58.34	94.04	55.34	99.02	094.01

ACCESSORIES



094.06

6-way jumper link for 58 series	094.06
--	--------

- RATED VALUES: 10 A - 250 V

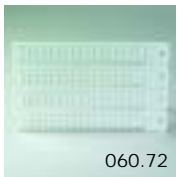
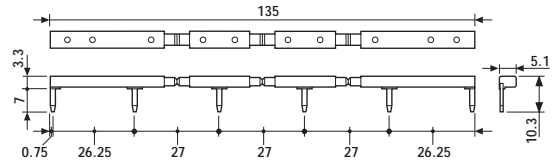

060.72

Sheet of marker tags (72 tags): 6x12mm	060.72
---	--------

PACKAGING CODES

How to code and identify retaining clip and packaging options for relay interface module.

Code options according to the last three letters:

5 8 . 3 4 . 9 . 0 2 4 . 0 0 5 0 S P A

A Standard packaging

B Blister packaging

SP Plastic retaining clip

- Designed for industrial applications
- Positive safety logic - make contact opens if the measured value is outside of the acceptable range
- High precision - measured value based on the average of 500 measurements over a 100ms period
- Industry standard module
- 35 mm rail (EN 50022) mounting
- Switch or link setting of the delay time
- LED status indication

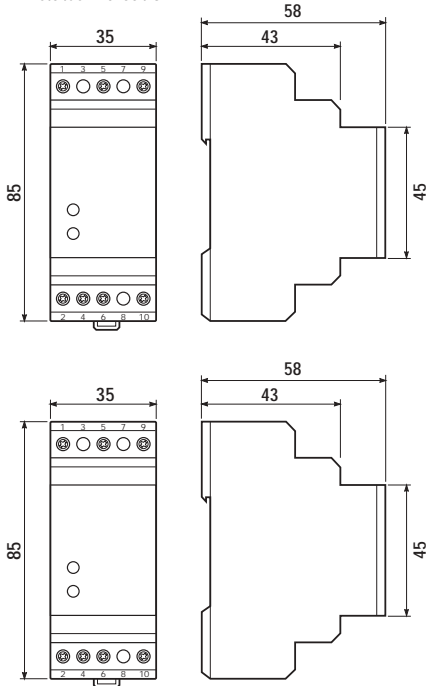

71.11.8.230.0010

71.11.8.230.1010



- 1 phase 230 V - line voltage monitoring
- Detects over and under voltage against fixed limits
- Long switch-on delay, avoiding problems associated with high inrush currents

- 1 phase 230 V - line voltage monitoring
- Detects over and under voltage against adjustable limits
- Long switch-on delay, avoiding problems associated with high inrush currents

- Line voltage detection 230 V AC 50/60 Hz
- Detection levels $(0.75 \dots 1.2) U_N$, fixed
- Delay time 5 min or 10 min - link selectable

- Line voltage detection 230 V AC 50/60 Hz
- Detection levels $(\pm 5 \dots \pm 20) \%$, U_N adjustable
- Delay time 5 min or 10 min - switch selectable

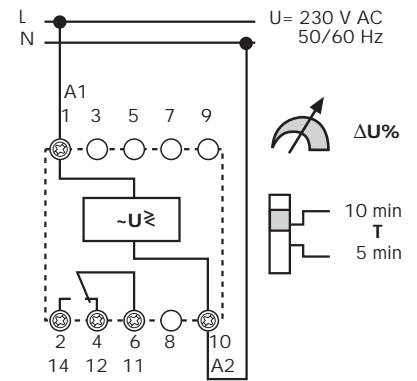
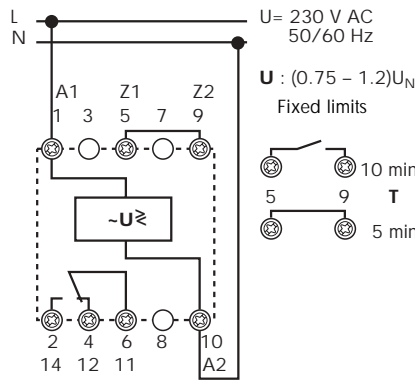

Contact specification			
Contact configuration		1 CO	1 CO
Rated current/Maximum peak current	A	10/15	10/15
Rated voltage/Maximum switching voltage	V AC	250/400	250/400
Rated load in AC1	VA	2,500	2,500
Rated load in AC15 (230 V)	VA	500	500
Single phase motor rating (230 VAC)	kW	0.5	0.5
Breaking capacity in DC1: 30/110/220V	A	10/0.3/0.12	10/0.3/0.12
Minimum switching load	mW/(V/mA)	300 (5/5)	300 (5/5)
Standard contact material		AgCdO	AgCdO
Supply specification			
Nominal voltage	V AC(50/60) Hz	230	230
	V DC	—	—
Rated power AC/DC	VA 50 Hz/ W	4/—	4/—
Operating range	AC	$(0.75 \dots 1.2) U_N$	$(0.8 \dots 1.2) U_N$
	DC	—	—
Technical data			
Electrical life at rated load AC1	cycles	$100 \cdot 10^3$	$100 \cdot 10^3$
Detection levels		$(0.75 \dots 1.2) U_N$	$(\pm 5 \dots \pm 20) \% U_N$
Switch-on delay time/reaction time	s	$(5 - 10) \text{ min} / < 0.5$	$(0.1 \dots 12) / < 0.5$
Fault memory		—	—
Electrical isolation: Supply to Measuring circuits		None - circuits are electrically common	None - circuits are electrically common
Insulation according to EN 61810-5		6 kV	6 kV
Ambient temperature range	°C	-20 ... +55	-20 ... +55
Protection category		IP20	IP20
Approvals: (according to type)		CE	CE

- Designed for industrial applications
- Positive safety logic - make contact opens if the measured value is outside of the acceptable range
- High precision - measured value based on the average of 500 measurements over a 100ms period
- Industry standard module
- 35 mm rail (EN 50022) mounting
- Adjustable setting of the detecting levels
- LED status indication

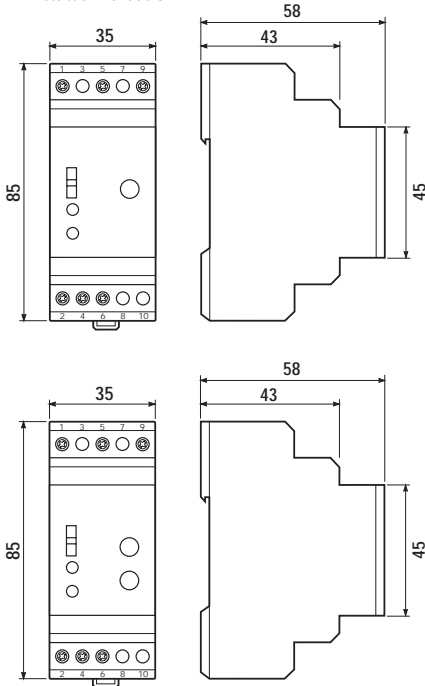
71.31.8.400.1010
71.31.8.400.1021

<ul style="list-style-type: none"> - 3 phase 400 V - line voltage monitoring - Detects over and under voltage against adjustable limits - Long switch-on delay, avoiding problems associated with high inrush currents 	<ul style="list-style-type: none"> - 3 phase 400 V - line voltage monitoring - Detects over and under voltage against adjustable limits - Adjustable switch-on delay - Switch selectable fault memory
<ul style="list-style-type: none"> - Line voltage detection 400 V AC 50/60 Hz - Detecting levels' ($\pm 5 \dots \pm 20$) % U_N, adjustable - Delay time 5 min or 10 min - switch selectable 	<ul style="list-style-type: none"> - Line voltage detection 400 V AC 50/60 Hz - Detecting level (0.8...0.95) U_N > U > 1.15 U_N - Delay time - (0.1...12) s adjustable - Fault memory, switch selectable - Fault acknowledgement by switch manipulation from ON to OFF and back to ON, or power down

Contact specification

71 Contact configuration		1 CO	1 CO
Rated current/Maximum peak current	A	10/15	10/15
Rated voltage/Maximum switching voltage	V AC	250/400	250/400
Rated load in AC1	VA	2,500	2,500
Rated load in AC15 (230 V)	VA	500	500
Single phase motor rating (230 VAC)	kW	0.5	0.5
Breaking capacity in DC1: 30/110/220V	A	10/0.3/0.12	10/0.3/0.12
Minimum switching load	mW/(V/mA)	300 (5/5)	300 (5/5)
Standard contact material		AgCdO	AgCdO

Supply specification

Nominal voltage	V AC(50/60) Hz	400	400
	V DC	—	—
Rated power AC/DC	VA 50 Hz/ W	4/—	4/—
Operating range	AC	(0.8...1.2) U_N	(0.8...1.15) U_N
	DC	—	—

Technical data

Electrical life at rated load AC1	cycles	$100 \cdot 10^3$	$100 \cdot 10^3$
Detection level		($\pm 5 \dots \pm 20$) % U_N	(-5...-20) % U_N ... (1.15) U_N fixed
Switch-on delay/Switch-off delay/reaction time	s	(5 - 10) min / < 0.5	(0.1 ... 12) s / < 0.5
Fault memory - selectable		—	Yes
Electrical isolation: Supply to Measuring circuits		None - circuits are electrically common	None - circuits are electrically common
Insulation according to EN 61810-5		6 kV	6 kV
Ambient temperature range	°C	-20 ... +55	-20 ... +55
Protection category		IP20	IP20

Approvals: (according to type)



71.31.8.400.2000

- Designed for industrial applications
- Positive safety logic - make contact opens if the measured value is outside of the acceptable range
- High precision - measured value based on the average of 500 measurements over a 100ms period
- Industry standard module
- 35 mm rail (EN 50022) mounting
- Adjustable setting of the detecting levels
- LED status indication

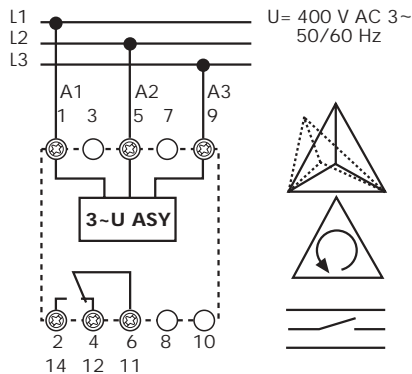
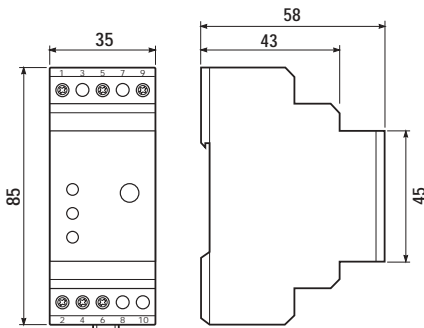

- 3 phase asymmetry monitoring
- Phase rotation monitoring
- Phase loss monitoring

- Line voltage detection 400 V AC 50/60 Hz
- Asymmetry of one or two phases (-5... -20) % U_N adjustable
- Detection of the supply voltage U to A1 (1) and/or A2 (5) $> 1.11 U_N$



Contact specification		
Contact configuration		1 CO
Rated current/Maximum peak current	A	10/15
Rated voltage/Maximum switching voltage	V AC	250/400
Rated load in AC1	VA	2,500
Rated load in AC15 (230 V)	VA	500
Single phase motor rating (230 VAC)	kW	0.5
Breaking capacity in DC1: 30/110/220V	A	10/0.3/0.12
Minimum switching load	mW/(V/mA)	300 (5/5)
Standard contact material		AgCdO
Supply specification		
Nominal voltage	V AC(50/60) Hz	400
	V DC	—
Rated power AC/DC	VA 50 Hz/ W	4/—
Operating range	AC	(0.8 ... 1.15) U_N
	DC	—
Technical data		
Electrical life at rated load AC1		$100 \cdot 10^3$
Detection level: Phase asymmetry: Adjustable		(-5...-20) % U_N
Switch-off delay /activation time	s	— / < 0.5
Fault memory		—
Electrical isolation: Supply to Measuring circuits		None – circuits are electrically common
Insulation according to EN 61810-5		6 kV
Ambient temperature range	°C	-20 ... +55
Protection category		IP20
Approvals: (according to type)		

- Universal voltage or current detecting and monitoring relay
- Programmable for:
 - DC or AC detection level
 - range detecting: upper and lower value
 - upper set point minus hysteresis range (5... 50)% for switch on
 - lower set point plus hysteresis range (5... 50)% for switch on
- Fault memory
- Electrical isolation between measuring and supply circuits
- Immune to supply interruptions of < 200 ms
- Wide detecting range

Voltage: DC (15...700) V, AC (15...480) V

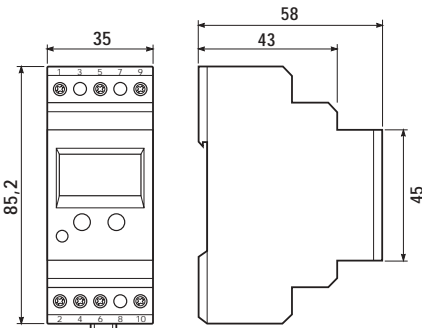

71.41.8.230.1021

71.51.8.230.1021



- Programmable universal voltage detecting module

- Programmable universal current detecting module,
- Usable with current transformer 50/5, 100/5, 150/5, 250/5, 300/5, 400/5 or 600/5

- AC/DC voltage detection - adjustable
- AC 50/60 Hz (15...480) V
- DC (15 ... 700) V
- Switch-on hysteresis (5...50) %
- Switch-off delay (0.1...12) s

- AC/DC current detection - adjustable
- AC 50/60Hz (0.1...10)A with current transformer to 600A
- DC (0.1...10)A
- Switch-on hysteresis - (5 ... 50) %
- Switch-off delay (0.1...12) s
- Switch-on delay (0.1...20) s

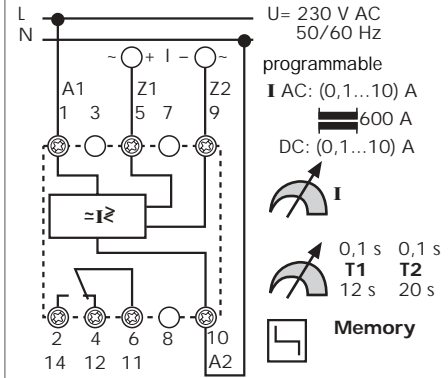
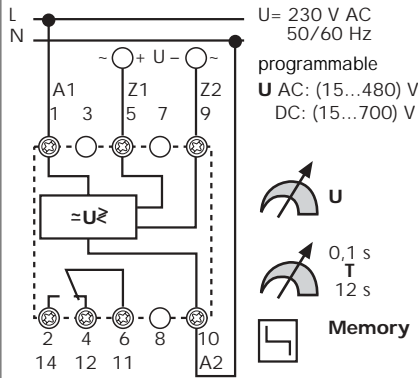

Contact specification

Contact configuration		1 CO	1 CO
Rated current/Maximum peak current	A	10/15	10/15
Rated voltage/Maximum switching voltage	V AC	250/400	250/400
Rated load in AC1	VA	2,500	2,500
Rated load in AC15 (230 V)	VA	500	500
Single phase motor rating (230 VAC)	kW	0.5	0.5
Breaking capacity in DC1: 30/110/220V	A	10/0.3/0.12	10/0.3/0.12
Minimum switching load	mW/(V/mA)	300 (5/5)	300 (5/5)
Standard contact material		AgCdO	AgCdO

Supply specification

Nominal voltage	V AC(50/60) Hz	230	230
	V DC	—	—
Rated power AC/DC	VA 50 Hz/ W	4 / —	4 / —
Operating range	AC	(0.85 - 1.15) U _N	(0.85 - 1.15) U _N
	DC	—	—

Technical data

Electrical life at rated load AC1	cycles	100 · 10 ³	100 · 10 ³
Detection levels	AC 50/60 Hz/DC	(15...480) V/(15...700) V	(0.1...10) A at transducer to 600A / (0.1...10) A
Switch-off/ reaction/ switch on reaction time	s	(0.1...12) / < 0.35 / < 0.5	(0.1...12) / < 0.35 / (0.1...20)
Switch-on level of the detecting level	%	5...50	5...50
Fault memory - programmable		Yes	Yes
Electrical isolation: Supply to Measuring circuits		Yes	Yes
Insulation according to EN 61810-5		6 kV	6 kV
Ambient temperature range	°C	-20...+55	-20...+55
Protection category		IP20	IP20

Approvals: (according to type)



- Designed for industrial applications
- Positive safety logic - make contact opens if the measured value is outside of the acceptable range
- Industry standard module
- 35 mm rail (EN 50022) mounting
- Adjustable setting of the detecting levels
- LED status indication

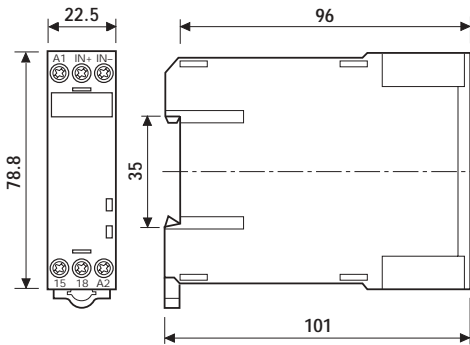

71.91.8.230.0300

71.92.8.230.0401

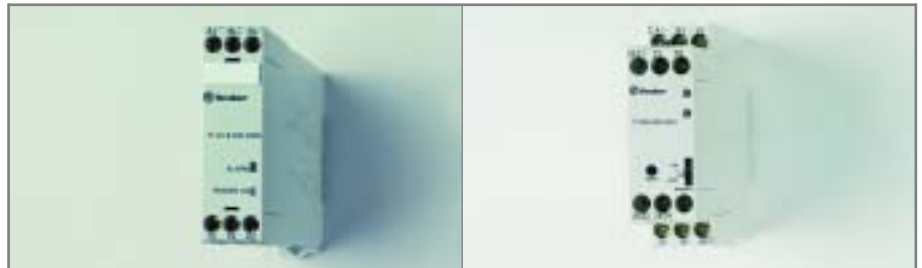

- Thermistor relay

- Thermistor relay with fault memory

- Temperature detection with PTC
- PTC short circuit detecting
- PTC wire breakage detecting
- Supply voltage 230 V AC 50/60 Hz

- Temperature detection with PTC
- Fault memory – switch selectable
- Reset by activity of the Reset button or supply interruption
- PTC short circuit detecting
- PTC wire breakage detecting
- Supply voltage 230 V AC 50/60 Hz

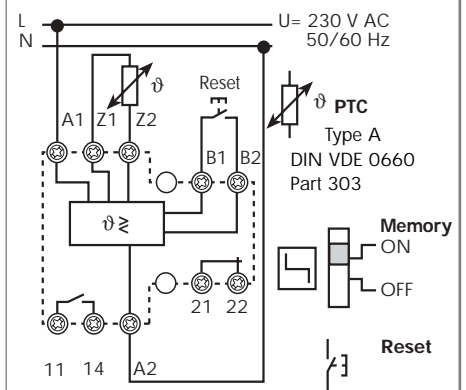
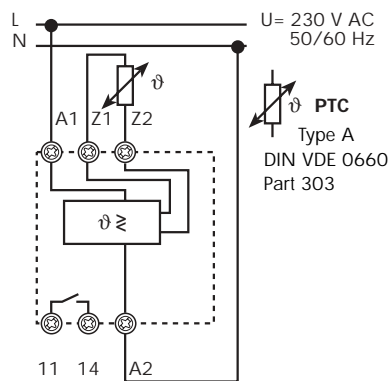

Contact specification			
Contact configuration		1 NO	1 NO + 1 NC
Rated current/Maximum peak current	A	10/15	10/15
Rated voltage/Maximum switching voltage	V AC	250/400	250/400
Rated load in AC1	VA	2,500	2,500
Rated load in AC15 (230 V)	VA	500	500
Single phase motor rating (230 VAC)	kW	0.5	0.5
Breaking capacity in DC1: 30/110/220V	A	10/0.3/0.12	10/0.3/0.12
Minimum switching load	mW/(V/mA)	300 (5/5)	300 (5/5)
Standard contact material		AgCdO	AgCdO
Supply specification			
Nominal voltage	V AC(50/60) Hz	230	230
	V DC	—	—
Rated power AC/DC	VA 50 Hz/ W	1/—	1/—
Operating range	AC	(0.85 ... 1.15) U _N	(0.85 ... 1.15) U _N
	DC	—	—
Technical data			
Electrical life at rated load AC1	cycles	100 · 10 ³	100 · 10 ³
PTC detecting:	Short circuit/Temperature OK	<20 Ω / >20 Ω ... <3 kΩ	<20 Ω / >20 Ω ... <3 kΩ
	Reset/PTC break	<1.3 kΩ / >3 kΩ	<1.3 kΩ / >3 kΩ
Delay time/activation time	s	— / < 0.5	— / < 0.5
Fault memory – switch selectable		—	Yes
Electrical isolation: Supply to Measuring circuits		Yes	Yes
Insulation according to EN 61810-5		6 kV	6 kV
Ambient temperature range	°C	-20...+55	-20...+55
Protection category		IP20	IP20
Approvals: (according to type)		CE	CE

ORDERING INFORMATION

Universal measuring relay with LCD display for AC/DC voltage detecting, with one CO contact for 10 A 250 V-AC1 and 230 V supply voltage, programmable delay time and fault memory.

7 1 . 4 1 . 8 . 2 3 0 . 1 0 2 1

Series

Type

- 1 = 1 phase AC line monitoring
- 3 = 3 phase AC line monitoring
- 4 = AC/DC universal- Voltage detection
- 5 = AC/DC universal- Current detection
- 9 = Thermistor relay (temperature monitoring with PTC thermistor)

No. of poles

- 1 = 1 CO at 71.11, 31, 41 51 81
- 1 = 1 NO at 71.91
- 2 = 1 NO and 1 NC at 71.92

Supply version

- 8 = AC (50/60 Hz)

Supply voltage

- 230 = 230 V
- 400 = 400 V

Additional functions

- 0 = basic function
- 1 = adjustable detection value
- 2 = adjustable: Asymmetry, phase loss, phase rotation

Special versions

- 0 = no fault memory
- 1 = fault memory

Options

- 0 = no delay time
- 1 = two fixed delay times
- 2 = adjustable delay times

Contact circuit

- 0 = 1 CO
- 3 = 1 NO
- 4 = 1 NO + 1 NC

Mounting width

- 71.11.8.230.0010 / 35 mm
- 71.11.8.230.1010 / 35 mm
- 71.31.8.400.1010 / 35 mm
- 71.31.8.400.1021 / 35 mm
- 71.31.8.400.2000 / 35 mm
- 71.41.8.230.1021 / 35 mm
- 71.51.8.230.1021 / 35 mm
- 71.91.8.230.0300 / 22.5 mm
- 71.92.8.230.0401 / 22.5 mm

TECHNICAL DATA

EMC SPECIFICATIONS

ELECTROSTATIC DISCHARGE	- contact discharge	EN 610004-2	8 kV
	- air discharge	EN 610004-2	8 kV
RADIO-FREQUENCY ELECTROMAGNETIC FIELD (80...1,000) MHz		EN 610004-3	3 V/m
FAST TRANSIENTS (burst) (5-50 ns, 5 kHz) on (A1, A2, A3, R1, R2) and (Z1, Z2)		EN 610004-4	2 kV
SURGES (1.2/50 µs) on (A1, A2, A3, R1, R2) and (Z1, Z2)	- common mode	EN 610004-5	4 kV
	- differential mode	EN 610004-5	4 kV
RADIO-FREQUENCY COMMON MODE (0.15 ÷ 80 MHz) to A1 - A2		EN 610004-6	10 V
RADIATED AND CONDUCTED EMISSION		EN 55022	class B

INSULATION

INSULATION according to EN 60810-5	Insulation rated voltage	V	250
	Rated impulse withstand voltage	kV	4
	Pollution degree		3
	Over-voltage category		III
DIELECTRIC STRENGTH (A1, A2, A3, R1, R2), and		V (AC)	2,500
CONTACT TERMINALS (11, 12, 14) and TERMINALS (Z1, Z2)		kV (1,2/50 µs)	6
DIELECTRIC STRENGTH AT OPEN CONTACT		V (AC)	1,000

OTHER DATA

Voltage and current values at terminals Z1 Z2	Type 71.11	Link for time range	V / mA	230 V / —
	Type 71.91, 71.92	PTC temperature measurement	V / mA	24 V / 2,4
Maximum length of wiring to the Supply terminals / Measuring terminals.	Type 71.11, 71.31	Contact bridge for time range	m	150 / —
	Type 71.41	Voltage measurement	m	150 / 50
	Type 71.51	Current measurement	m	150 / 50
(Wiring capacitance no greater than 10 nF/100m)	Type 71.91, 71.92	PTC temperature measurement	m	50 / 50
Measuring principle	Type 71.11, 71.31, 71.41, 71.51, 71.91, 71.92	The measured value is the arithmetical average of 500 individual measurements taken over a 100ms period. interruptions less than 200 ms are ignored.		
Safety logic	Type 71.11, 71.31, 71.41, 71.51, 71.91, 71.92	Positive safety logic - When the value being monitored lie in the acceptable area, the make contact is closed.		
Reaction time (following the application of the supply voltage)	Type 71.11, 71.31, 71.41, 71.51, 71.91, 71.92	≤ 0,5 s		
Power lost to the environment	- without contact load	VA	4	
	- with rated current	VA	5	
Permitted storage temperature range		°C	-40...+85	
Protection category		IP 20		
Max. wire size		solid cable	standed cable	
	mm ²	0.5...(2 x 2,5)	(2 x 1,5)	
	AWG	20...(2 x 14)	(2 x 16)	
Screw torque		Nm	0.8	

FUNCTIONS - Overview

Monitoring Relay - Type	Types										Times		Supply voltage		Module width		Contact conf.			
	1-phase 230V, Under/Over voltage.	3-phase 400V, Under/Over voltage.	3-phase 400V, Phase symmetry.	3-phase 400V, Phase loss.	3-phase 400V, Phase.	DC voltage (15...700) V Under and Over voltage monitoring.	AC voltage (15...484) V Under and Over voltage monitoring.	DC current (0,1 ...10) A Under and Over current monitoring.	AC current (0,1...10) A(or to 600 A with current transformers) Under and Over current monitoring.	Thermistor relay (PTC) + Memory.	Adjustable.	Fault memory for 71.41 and 71.51	Delay time 5 / 10 min.	Delay time (0,1...12) s adjustable.	Power-up activation time delay (0,1 ... 20) s - starting inrush current suppression.	230 V AC.		400 V AC.	35 mm wide.	22.5 mm wide.
71.11.8.230.0010	•											•			•					1 CO
71.11.8.230.1010	•										•	•			•					1 CO
71.31.8.400.1010		•									•	•				•				1 CO
71.31.8.400.1021		•									•	•	•			•				1 CO
71.31.8.400.2000			•	•	•						•					•				1 CO
71.41.8.230.1021	•					•	•				•	•	•			•				1 CO
71.51.8.230.1021								•	•		•	•	•	•		•				1 CO
71.91.8.230.0300									•		•					•			•	1 NO
71.92.8.230.0401									•		•					•			•	1 NO 1 NC
Current transformer	Source as required																			

Explanation of relay marking and LED/LCD display

Monitoring relay without LCD-display			
ON	LED green steady light: Supply voltage is on and measuring system is active.		
DEF	Default: The detected value is outside of the acceptable range. (Asymmetric is shown by the LED ASY) LED red flashing: Delay time is running. See the function diagram. LED red steady light: Output relay is off. Contact 11-14 (6-2) is open.		
ASY	Phase asymmetry is outside of the predefined range. LED steady light: Output relay is turned off. Contact 11-14 (6-2) is open.		
LEVEL	Selected range as % value.		
TIME	Delay time (min = minutes) or (s = seconds).		
MEMORY ON	Fault memory switched on: The state of the output relay after the occurrence of a fault (contact 11-14 (6-2) open) will be maintained, monitored value returns to within acceptable limits. Fault reset is made by switch manipulation from ON to OFF to ON, or by power down (71.31.8.400.1021), or 71.91.8.230.0401 by operating of the "RESET" button (71.91.8.230.0401).		
MEMORY OFF	Fault memory turned off: The state of the output contacts will only remain in the "fault" condition (contact 11-14 (6-2) open) while the monitored value is outside of the acceptable limits. When the monitored value returns within the acceptable limits the contact will revert to the energised state. Monitored equipment will start again automatically.		
Monitoring relay with LCD-display			
SET/RESET	Relay 71.41 and 71.51. Sets and resets the programmable values - see operating instructions in the packing		
SELECT	Relay 71.41 and 71.51. Selects the desired parameter for programming - see operating instructions		
DEF	Default, LED red steady or flashing.		
PROG Modus	Enter the programming mode by simultaneously pressing the buttons "SET/RESET" and "SELECT" for 3 secs. The word "prog" is shown for 1 sec. "SELECT" allows the choice of "AC" or "DC", and is confirmed with "SET/RESET". Successively pressing the button "SELECT" brings up the choices of Up, Lo, or UpLo. The appropriate choice is made by pressing the "SET/RESET" button. The next steps will program the appropriate values and the selection of the fault memory function (which is selected with a "YES" or "NO"). If all programming steps are completed the display will read "end".		
Short programming instruction	After repeatedly pressing the "SET/RESET" button the measured value will be displayed, or "0" appears if nothing is connected to Z1 and Z2 (5 and 9). If the programming is broken off before "end" is shown in the display the previous program will remain unchanged after an interruption of the supply voltage.		
Program query	Pushing the "SELECT" button for at least 1 sec, enters the "program inquiry mode". The programmed mode and the values are shown on the repeated pressing of the "SELECT" button.		
Flashing M (Memory)	Fault memory has had effect (fault acknowledgement and reset is made by a 3 second press of the "SETSET/RESET button")		
LCD-display	V = volt A = amp Up = upper limit (with hysteresis in down direction) Lo = lower limit (with hysteresis in up direction) UpLo = upper and lower limit - range detecting	Level = value Hys = hysteresis M = Memory (fault) Yes = yes - with memory no = no - without memory	t1 = T1 - time during which short-time fluctuations are not taken into account t2 = T2 - (monitoring relay 71.51) the time during which inrush currents are not taken into account.

LED/LCD status announcement/advice

Type	Starting mode	Normal operation	Abnormal mode		Reset
71.11.8.230.0010 71.11.8.230.1010 71.31.8.400.1010	After connecting T = 5 or 10 min 11-14 open	Normal operation Set point is OK 11-14 is closed	Time T runs Set point is immaterial 11-14 is open Will close after T, if set point is OK	After expiry of T Set point is not OK 11-14 is open Will close, if set point is OK	
71.31.8.400.1021 Memory OFF 		Normal operation Set point is OK 11-14 is closed	Time T runs Set point is not OK 11-14 is closed	After expiry of T Set point is not OK 11-14 is open Will close, if set point is OK	
71.31.8.400.1021 Memory ON 		Normal operation Set point is OK 11-14 is closed	Time T runs Set point is not OK 11-14 is closed	After expiry of T Set point is not OK 11-14 is open Will not close at RESET	After expiry of T Set point is OK 11-14 is open Will close at RESET
71.31.8.400.2000		Normal operation Set point is OK 11-14 is closed	Supply voltage to A1 (1) and / or A2 (5) is missing 11-14 is open Will close if supply voltage restored and set point OK Incorrect phase rotation or phase failure or voltage A1 (1) and/or A2 (5) is > 1.11 UN 11-14 is open Will close, if set point is OK	Phase asymmetry 11-14 is open 11-14 is open 11-14 is open Will close, if set point is OK	
71.41.8.230.1021 Memory OFF		Measured value displayed Normal operation Set point is OK 11-14 is closed	Measured value displayed Time T runs Set point is not OK 11-14 is closed	Measured value displayed After expiry of T Set point is not OK 11-14 is open Will close, if set point is OK	
71.41.8.230.1021 Memory ON		Measured value displayed Normal operation Set point is OK 11-14 is closed	Measured value displayed Time T runs Set point is not OK 11-14 is closed	M in the display flashes Measured value displayed After expiry of T Set point is not OK 11-14 is open Will not close at RESET	M in the display - static Measured value displayed After expiry of T Set point is OK 11-14 is open Will close at RESET
71.51.8.230.1021 Memory OFF	Measured value displayed Time T2 runs Set point immaterial 11-14 is closed	Measured value displayed Normal operation Set point is OK 11-14 is closed	Measured value displayed Time T1 runs Set point is not OK 11-14 is closed	Measured value displayed After expiry of T1 Set point is not OK 11-14 is open Will close if set point OK	
71.51.8.230.1021 Memory ON	Measured value displayed Time T2 runs Set point immaterial 11-14 is closed	Measured value displayed Normal operation Set point is OK 11-14 is closed	Measured value displayed Time T1 runs Set point is not OK 11-14 is closed	M in the display flashes Measured value displayed After expiry of T1 Set point is not OK 11-14 is open Will not close at RESET	M in the display - static Measured value displayed After expiry of T1 Set point is OK 11-14 is open Will close at RESET
71.91.8.230.0300		Normal operation Set point is OK 11-14 is closed	Temperature too high or PTC line break or PTC short circuit 11-14 is open Will close if set point OK		
71.92.8.230.0401 Memory OFF 		Normal operation Set point is OK 11-14 is closed	Temperature too high or PTC line break or PTC short circuit 11-14 is open Will close if set point OK		
71.92.8.230.0401 Memory ON 		Normal operation Set point is OK 11-14 is closed	Temperature too high or PTC line break or PTC short circuit 11-14 is open	Temperature is OK 11-14 is open Will close at RESET	

71

FUNCTIONS

<p>Type 71.11.8.230.0010</p> <p>U = 230 V AC 50/60 Hz</p> <p>U : (0.75 - 1.2)U_N Fixed limits</p> <p>10 min T 5 min</p>	<p>Switch off: Immediately if monitored value is outside of the set points.</p> <p>Switch on: After expiry of the time T and if monitored value is within the set points.</p> <p>C = output contact NO 11-14 (6-2) closed</p>
<p>Type 71.11.8.230.1010</p> <p>U = 230 V AC 50/60 Hz</p> <p>ΔU%</p> <p>10 min T 5 min</p>	<p>Switch off: Immediately if monitored value is outside of the set points.</p> <p>Switch on: After expiry of the time T and if monitored value is within the set points.</p> <p>C = output contact NO 11-14 (6-2) closed, all values within the set points</p>
<p>Type 71.31.8.400.1010</p> <p>U = 400 V AC 3~ 50/60 Hz</p> <p>ΔU%</p> <p>10 min T 5 min</p>	<p>Switch off: Immediately if monitored value is outside of the set points.</p> <p>Switch on: After expiry of the time T and if monitored value is within the set points.</p> <p>C = output contact NO 11-14 (6-2) closed</p>
<p>Type 71.31.8.400.1021</p> <p>U = 400 V AC 3~ 50/60 Hz</p> <p>ΔU%</p> <p>0,1 s T 12 s</p> <p>Memory ON OFF</p>	<p>Switch off: If monitored value is outside of the set points and time T has elapsed.</p> <p>Switch on: MEMORY OFF: Immediately monitored value returns within limits (off-set by 1% hysteresis)</p> <p>Switch on: MEMORY ON: As above, but subject to the RESET operation having been actioned.</p> <p>RESET: By Memory switch manipulation from ON to OFF and back to ON, or power down</p> <p>C = output contact NO 11-14 (6-2) closed</p> <p>*RESET MEMORY = By power-down or switch manipulation from ON to OFF to ON</p>

FUNCTIONS

<p>Type 71.31.8.400.2000</p> <p>U = 400 V AC 3~ 50/60 Hz</p> <p>3-U ASY</p>	<p>Switch off: Phase asymmetry Incorrect phase rotation Phase loss</p> <p>LED • ASY yellow Phase asymmetry</p> <p>LED • DEF red Voltage to A1 (1) and/or A2 (5) > 1.11 UN Incorrect phase rotation Phase loss to A3 (9)</p> <p>LED • ON green Monitoring system is active and 400 V supply voltage is connected to 1-5 or A1- A2</p> <p>C = output contact NO 11-14 (6-2) closed</p>
<p>Type 71.41.8.230.1021</p> <p>U = 230 V AC 50/60 Hz</p> <p>Programmable U AC: (15...480) V DC: (15...700) V</p> <p>Memory</p>	<p>Switch off: U_{lo} - mode If the monitored value is less than the lower-limit and, time T has expired</p> <p>U_{up} - mode If the monitored value is higher than the upper limit, and time T has expired</p> <p>U_{lo} U_{up} - mode If the monitored value of voltage is outside of the upper or lower voltage limits, and time T has expired</p> <p>Voltage dips < T do not result in output relay switching off</p> <p>Switch on: U_{lo} or U_{up} - modes When passing the hysteresis value</p> <p>U_{lo} U_{up} mode - When passing the U_{lo} or U_{up} value</p> <p>RESET MEMORY: Pressing "SET/RESET" > 1 sec</p> <p>C = output contact NO 11-14 (6-2) closed</p> <p>RESET MEMORY = Pressing "SET/RESET" > 1 sec</p>

FUNCTIONS

Type 71.51.8.230.1021

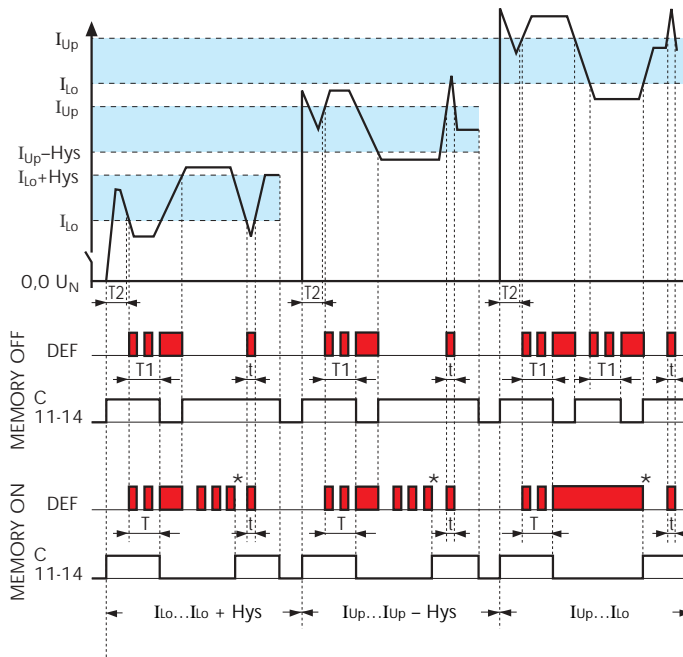
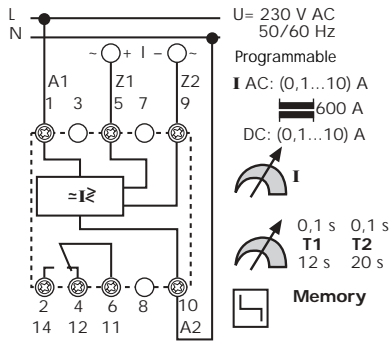

*RESET MEMORY = pressing "SET/RESET" > 1 sec

Switch off:
 I_{Lo} - mode
 If the monitored value is less than the lower-limit and, time T has expired

I_{Up} - mode
 If the monitored value is higher than the upper limit, and time T has expired

$I_{Lo} I_{Up}$ - mode
 If the monitored value of current is outside of the upper or lower limits, and time T has expired

Inrush current < T2 is ignored

Current dips < T1 do not result in output relay switching off

Switch on:
 I_{Lo} or I_{Up} - mode
 When passing the hysteresis value

$I_{Lo} I_{Up}$ - mode
 When passing the I_{Lo} or I_{Up} values

RESET MEMORY:
 Pushing "SET/RESET" > 1 sec

C = output contact
 NO 11-14 (6-2) closed

Type 71.91.8.230.0300

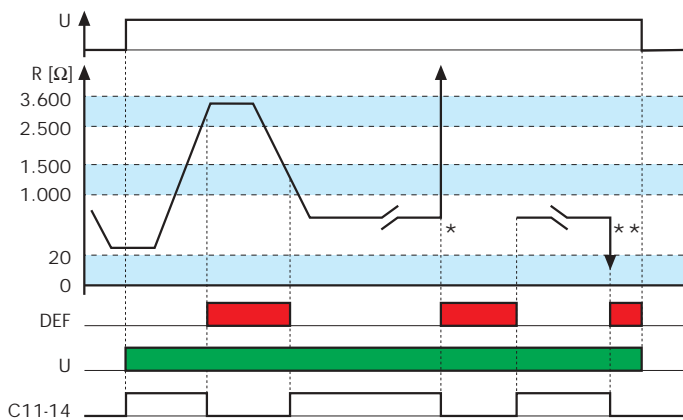
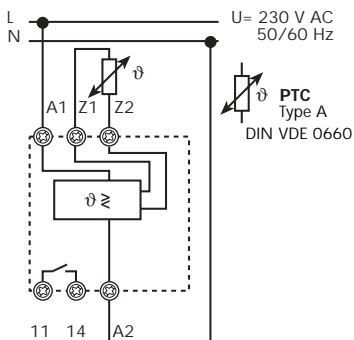

* PTC-Break ** PTC-Short circuit

Switch off:
 - Thermistor line break
 - Over temperature $R_{PTC} > (2,5...3,6)k\Omega$,
 - Thermistor line short circuit ($R_{PTC} < 20\Omega$)
 - Loss of supply

Switch on:
 Temperature within limits $R_{PTC} > (1,0...1,5)k\Omega$ on power-up. ($1k\Omega...1.5k\Omega$) on cooling

C = output contact
 NO (11-14)
 Closed when Temperature within limits

FUNCTIONS

Type 71.92.8.230.0401

U = 230 V AC
50/60 Hz

PTC Type A
DIN VDE 0660

Memory ON
OFF

Reset

Switch off:

- Thermistor line break
- Over temperature $R_{PTC} > (2.5 \dots 3.6)k\Omega$
- Thermistor line short circuit $R_{PTC} < 20\Omega$
- Loss of supply

Switch on:

- Temperature within limits ($20\Omega \dots 2.5k\Omega$) on power-up.
- $R_{PTC} > (1.0 \dots 1.5)k\Omega$ on cooling.

Select MEMORY OFF:

If monitored value is expected to cross the resetting threshold.

Select MEMORY ON:

If monitored value is expected to remain within limits.

RESET MEMORY:

Operate the RESET key, or interrupt the supply.

C = output contacts

NO (11-14)
Closed when Temperature within limits

NC (21-22)
Closed when Temperature outside limits / Power off

* PTC-Break ** PTC-Short circuit
*** RESET MEMORY = Operate the RESET key, or interrupt the supply

- Mono-function and multi-function versions available
- Rotary selector
- 17.5 mm wide
- Six time scales from 0.1s to 20h
- 35 mm rail (EN 50022) mount
- High input/output insulation

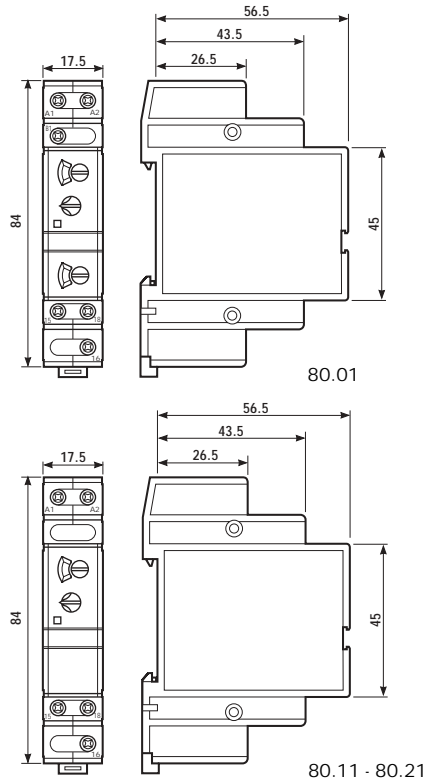

	80.01	80.11	80.21
	- Multi-voltage - Multi-function	- Mono-voltage - Mono-function	- Mono-voltage - Mono-function
	AI: ON delay DI: ON pulse SW: Symmetrical recycler: ON start BE: Signal OFF delay CE: Signal ON and OFF delay DE: Signal ON pulse	AI: ON delay	DI: ON pulse
	 wiring diagram (without signal START) wiring diagram (with signal START)	 wiring diagram (without signal START)	 wiring diagram (without signal START)
Contact specifications			
Contact configuration	1 CO	1 CO	1 CO
Rated current/Maximum peak current	A 16/30	A 16/30	A 16/30
Rated voltage/Maximum switching voltage V AC	250/400	250/400	250/400
Rated load in AC1	VA 4,000	VA 4,000	VA 4,000
Rated load in AC15 (230 VAC)	VA 750	VA 750	VA 750
Single phase motor rating (230 VAC)	kW 0.55	kW 0.55	kW 0.55
Breaking capacity in DC1: 30/110/220V A	16/0.3/0.12	16/0.3/0.12	16/0.3/0.12
Minimum switching load	mW(V/mA) 500 (10/5)	mW(V/mA) 500 (10/5)	mW(V/mA) 500 (10/5)
Standard contact material	AgCdO	AgCdO	AgCdO
Supply specifications			
Nominal voltage	V AC(50/60Hz) 12...240	V AC(50/60Hz) 24 - 230...240	V AC(50/60Hz) 24 - 230...240
	V DC 12...240	V DC 24 (non polarized)	V DC 24 (non polarized)
Rated power AC/DC	VA (50Hz)/W < 1.8/ < 1.4	VA (50Hz)/W < 1.8/ < 0.6	VA (50Hz)/W < 1.8/ < 0.6
Operating range	AC 10.2...265 V	(0.85...1.1)U _N	(0.85...1.1)U _N
	DC 10.2...265 V	(0.85...1.1)U _N	(0.85...1.1)U _N
Technical data			
Specified time range	(0.1...2) s, (1...20) s, (0.1...2) min, (1...20) min, (0.1...2) h, (1...20) h		
Repeatability	% ± 1	% ± 1	% ± 1
Recovery time	ms ≤ 50	ms ≤ 50	ms ≤ 50
Minimum control impulse	ms 50	ms —	ms —
Setting accuracy-full range	% ± 5	% ± 5	% ± 5
Electrical life at rated load in AC1	cycles 100·10 ³	cycles 100·10 ³	cycles 100·10 ³
Ambient temperature range	°C -10...+50	°C -10...+50	°C -10...+50
Protection category	IP 20	IP 20	IP 20
Approvals: (according to type)			GOST

- Mono-function and multi-function versions available
- Rotary selector
- 17.5 mm wide
- Six time scales from 0.1s to 20h
- 35 mm rail (EN 50022) mount
- High input/output insulation

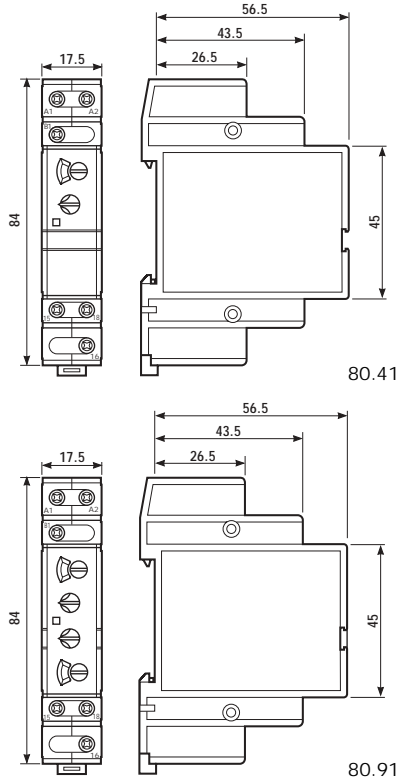

80.41

80.91



- Mono-voltage
- Mono-function

- Multi-voltage
- Mono-function

BE: Signal OFF delay

LI: Asymmetrical recycler (ON starting)
LE: Signal asymmetrical recycler (ON starting)

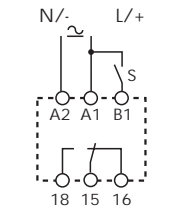

wiring diagram (with signal START)

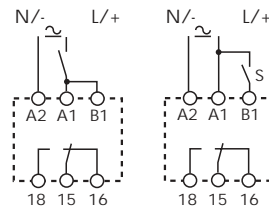

wiring diagram (without signal START) wiring diagram (with signal START)

Contact specifications

Contact configuration		1 CO	1 CO
Rated current/Maximum peak current	A	16/30	16/30
Rated voltage/Maximum switching voltage	V AC	250/400	250/400
Rated load in AC1	VA	4,000	4,000
Rated load in AC15 (230 VAC)	VA	750	750
Single phase motor rating (230 VAC)	kW	0.55	0.55
Breaking capacity in DC1:	30/110/220V A	16/0.3/0.12	16/0.3/0.12
Minimum switching load	mW(V/mA)	500 (10/5)	500 (10/5)
Standard contact material		AgCdO	AgCdO

Supply specifications

Nominal voltage	V AC(50/60Hz)	24 - 230...240	12...240
	V DC	24	12...240
Rated power AC/DC	VA (50Hz)/W	< 1.8/ < 0.6	< 1.8/ < 1.4
Operating range	AC	(0.85...1.1)U _N	10.2...265 V
	DC	(0.85...1.1)U _N	10.2...265 V

Technical data

Specified time range		(0.1...2) s, (1...20) s, (0.1...2) min, (1...20) min, (0.1...2) h, (1...20) h	
Repeatability	%	± 1	± 1
Recovery time	ms	≤ 50	≤ 50
Minimum control impulse	ms	50	50
Setting accuracy-full range	%	± 5	± 5
Electrical life at rated load in AC1	cycles	100·10 ³	100·10 ³
Ambient temperature range	°C	-10...+50	-10...+50
Protection category		IP 20	IP 20

Approvals: (according to type)



ORDERING INFORMATION

Example: a 80 series, modular timers, 1 CO, 16 A, supply rated at 12 ... 240 V AC/DC.

8 0 . 0 1 . 0 2 4 0 . 0 0 0 0

<p>Series ————</p> <p>Type ————</p> <p>0 = Multi-function (AI, DI, SW, BE, CE, DE)</p> <p>1 = ON delay (AI)</p> <p>2 = ON pulse (DI)</p> <p>4 = Signal OFF delay (BE)</p> <p>9 = Asymmetrical recycler ON starting (LI, LE)</p> <p>No. of poles ————</p> <p>1 = 1 CO</p>	<p>Supply voltage</p> <p>024 = 24 V AC/DC</p> <p>240 = 230...240 V AC (80.11, 80.21, 80.41)</p> <p>240 = 12 ... 240 V AC/DC (80.01, 80.91)</p> <p>Supply version</p> <p>0 = AC (50/60 Hz)/DC (80.01, 80.91)</p> <p>8 = AC (50/60 Hz) (80.11, 80.21, 80.41)</p>
---	--

ACCESSORIES

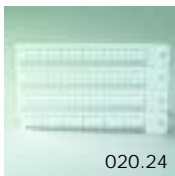

Sheet of marker tags (24 tags) for types 80.01/11/21/41: 9x17mm | 020.24

TECHNICAL DATA

EMC SPECIFICATIONS

TYPE OF TEST		REFERENCE STANDARD	
ELECTROSTATIC DISCHARGE	- contact discharge	EN 61000-4-2	4 kV
	- air discharge	EN 61000-4-2	8 kV
RADIO-FREQUENCY ELECTROMAGNETIC FIELD (80 ÷ 1000 MHz)		EN 61000-4-3	10 V/m
FAST TRANSIENTS (burst) (5-50 ns, 5 kHz) on Supply terminals		EN 61000-4-4	4 kV
SURGES (1.2/50 µs) on Supply terminals	- common mode	EN 61000-4-5	4 kV
	- differential mode	EN 61000-4-5	4 kV
	on start terminal (B1) - common mode	EN 61000-4-5	4 kV
	- differential mode	EN 61000-4-5	4 kV
RADIO-FREQUENCY COMMON MODE (0.15 ÷ 80 MHz) on Supply terminals		EN 61000-4-6	10 V
RADIATED AND CONDUCTED EMISSION		EN 55022	class B

INSULATION

DIELECTRIC STRENGTH	- between input and output circuit	V AC	4,000
	- between open contacts	V AC	1,000
INSULATION (1.2/50 µs) between input and output		kV	6

OTHER DATA

CURRENT ABSORPTION on signal control (B1)		< 1 mA	
POWER LOST TO THE ENVIRONMENT	- without contact current	W	1.3
	- with rated current	W	3.2
MAX WIRE SIZE		solid cable	stranded cable
		mm ²	1x4 / 2x4 1x4 / 2x2.5
		AWG	1x10 / 2x12 1x12 / 2x14
SCREW TORQUE		Nm	0.8

FUNCTIONS

	LED	Supply voltage	NO output contact	Contacts	
				Open	Closed
U = Supply voltage		OFF	Open	15 - 18	15 - 16
S = Signal switch		ON	Open	15 - 18	15 - 16
		ON	Open (Timing in Progress)	15 - 18	15 - 16
		ON	Closed	15 - 16	15 - 18

Without signal Start = Start via contact in supply line (A1).

With signal Start = Start via contact into control terminal (B1).

Wiring diagram

Without signal START

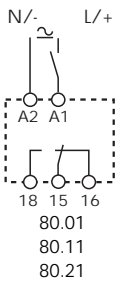

Type 80.01 80.11		(AI) ON delay. Apply power to timer. Output contacts transfer after preset time has elapsed. Reset occurs when power is removed.
80.01 80.21		(DI) ON pulse. Apply power to timer. Output contacts transfer immediately. After the preset time has elapsed, contacts reset.
80.01		(SW) Symmetrical recycler: ON start. Apply power to timer. Output contacts transfer immediately and cycle between ON and OFF for as long as power is applied. The ratio is 1:1 (time on = time off).

With signal START

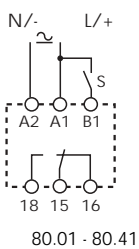

80.01 80.41		(BE) Signal OFF delay. Power is permanently applied to the timer. The output contacts transfer immediately on closure of the Signal Switch (S). Opening the Signal Switch initiates the preset delay, after which time the output contacts reset.
80.01		(CE) Signal ON and OFF delay. Power is permanently applied to the timer. Closing the Signal Switch (S) initiates the preset delay, after which time the output contacts transfer. Opening the Signal switch initiates the same preset delay, after which time the output contacts reset.
80.01		(DE) Signal ON pulse. Power is permanently applied to the timer. On momentary or maintained closure of Signal Switch (S), the output contacts transfer, and remain so for the duration of the preset delay, after which they reset.

Without signal START

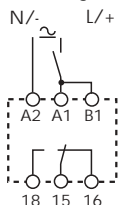

80.91

With signal START

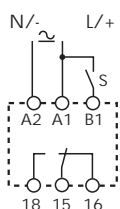

80.91

NOTE: time scales and functions must be set before energising the timer.

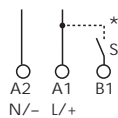

- * - With DC supply, positive polarity has to be connected to B1 terminal (according to EN 60204-1).
- A voltage other than the supply voltage can be applied to the command Start (B1), example:
A1 - A2 = 230 V AC
B1 - A2 = 12 V DC

- Plug-in timer relay
- 2, 3 or 4 CO contact available
- Seven time scales, from 0.05s to 100h
- Multifunctions
- Sockets: see 94 series

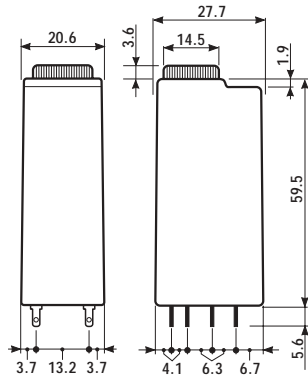

85.02

85.03

85.04



- 2 Pole, 10A
- AC/DC supply non polarized
- Plug-in for use with 94 series sockets

- 3 Pole, 10A
- AC/DC supply non polarized
- Plug-in for use with 94 series sockets

- 4 Pole, 7A
- AC/DC supply non polarized
- Plug-in for use with 94 series sockets

AI: ON delay
DI: ON pulse
SW: Symmetrical recycler: ON start
GI: Fixed pulse (0.5s) delayed

AI: ON delay
DI: ON pulse
SW: Symmetrical recycler: ON start
GI: Fixed pulse (0.5s) delayed

AI: ON delay
DI: ON pulse
SW: Symmetrical recycler: ON start
GI: Fixed pulse (0.5s) delayed

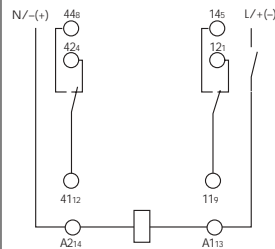

wiring diagram

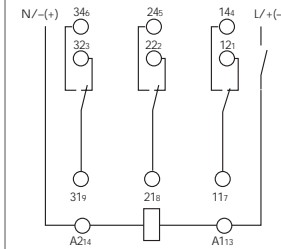

wiring diagram

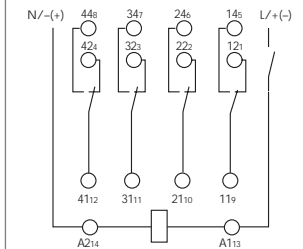

wiring diagram

Contact specifications				
Contact configuration		2 CO	3 CO	4 CO
Rated current/Maximum peak current	A	10/20	10/20	7/15
Rated voltage/Maximum switching voltage V AC		250/400	250/400	250/250
Rated load in AC1	VA	2,500	2,500	1,750
Rated load in AC15 (230 VAC)	VA	500	500	350
Single phase motor rating (230 VAC)	kW	0.37	0.37	0.125
Breaking capacity in DC1:	30/110/220V A	10/0.25/0.1	10/0.25/0.1	7/0.25/0.1
Minimum switching load	mW(V/mA)	300 (5/5)	300 (5/5)	300 (5/5)
Standard contact material		AgNi	AgNi	AgNi
Supply specifications				
Nominal voltage	V AC(50/60Hz)	230...240	230...240	230...240
	V AC/DC	12 - 24 - 48 - 110...125 (non polarized)		
Rated power AC/DC	VA (50Hz)/W	2/2	2/2	2/2
Operating range	AC	(0.85...1.1)U _N	(0.85...1.1)U _N	(0.85...1.1)U _N
	DC	(0.85...1.1)U _N	(0.85...1.1)U _N	(0.85...1.1)U _N
Technical data				
Specified time range		(0.05...1) s, (0.5...10) s, (5...100) s, (0.5...10) min, (5...100) min, (0.5...10) h, (5...100) h		
Repeatability	%	± 2	± 2	± 2
Recovery time	ms	≤ 20	≤ 20	≤ 20
Minimum control impulse	ms	—	—	—
Setting accuracy-full range	%	± 5	± 5	± 5
Electrical life at rated load in AC1	cycles	200 · 10 ³	200 · 10 ³	200 · 10 ³
Ambient temperature range	°C	-20...+60	-20...+60	-20...+60
Protection category		IP 40	IP 40	IP 40
Approvals: (according to type)				

ORDERING INFORMATION

Example: 85 series timer, 4 CO, 24 V AC/DC supply voltage with AI - DI functions.

8 5 . 0 4 . 0 . 0 2 4 . 0 0 0 0

Series

Type

0 = Multifunction (AI, DI, GI, SW)

No. of poles

2 = 2 pole - 10 A

3 = 3 pole - 10 A

4 = 4 pole - 7 A

Supply voltage

012 = 12 V AC/DC

024 = 24 V AC/DC

048 = 48 V AC/DC

125 = 110...125 V AC/DC

240 = 230...240 V AC

Supply version

0 = AC (50/60 Hz)/DC

8 = AC (50/60 Hz) for 240 V only

TECHNICAL DATA

EMC SPECIFICATIONS

TYPE OF TEST	REFERENCE STANDARD	
ELECTROSTATIC DISCHARGE	- contact discharge	EN 61000-4-2
	- air discharge	EN 61000-4-2
RADIO-FREQUENCY ELECTROMAGNETIC FIELD (80 ÷ 1000 MHz)	EN 61000-4-3	15 V/m
FAST TRANSIENTS (burst) (5-50 ns, 5 kHz) on Supply terminals	EN 61000-4-4	4 kV
SURGES (1.2/50 µs) on Supply terminals	- common mode	EN 61000-4-5
	- differential mode	EN 61000-4-5
RADIO-FREQUENCY COMMON MODE (0.15 ÷ 80 MHz) on Supply terminals	EN 61000-4-6	10 V
POWER-FREQUENCY (50 Hz)	EN 61000-4-8	30 A/m
RADIATED AND CONDUCTED EMISSION	EN 55022	class B

OTHER DATA

POWER LOST TO THE ENVIRONMENT	2 pole	3 pole	4 pole
- without contact current	W 1.6	1.6	1.6
- with rated current	W 3.7	4.7	3.6

85

TIME SCALES

(0.05...1) s	(0.5...10) s	(5...100) s	(0.5...10) min	(5...100) min	(0.5...10) h	(5...100) h
1 2 3 4 5	1 2 3 4 5	1 2 3 4 5	1 2 3 4 5	1 2 3 4 5	1 2 3 4 5	1 2 3 4 5

NOTE: time scales and functions must be set before energising the timer.

FUNCTIONS

	LED	Supply voltage	NO output contact	Contacts	
				Open	Closed
U = Supply voltage = Output contact		OFF	Open	x1 - x4	x1 - x2
		ON	Open	x1 - x4	x1 - x2
		ON	Open (Timing in Progress)	x1 - x4	x1 - x2
		ON	Closed	x1 - x2	x1 - x4

Wiring diagram

Types: 85.02, 85.03, 85.04

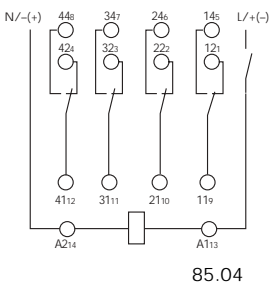
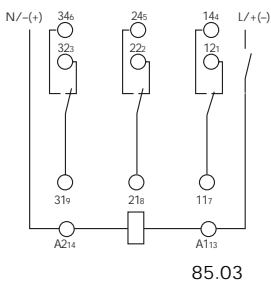
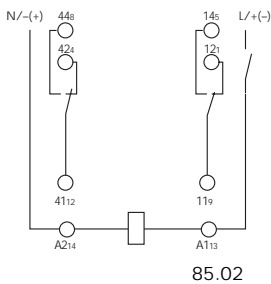

(AI) ON delay.
Apply power to timer. Output contacts transfer after preset time has elapsed. Reset occurs when power is removed.

(DI) ON pulse.
Apply power to timer. Output contacts transfer immediately. After the preset time has elapsed, contacts reset.

(GI) Fixed pulse (0.5s) delayed.
Apply power to timer. Output contacts transfer after preset time has elapsed. Reset occurs after a fixed time of 0.5s. 0.5s.

(SW) Symmetrical recycler: ON start.
Apply power to timer. Output contacts transfer immediately and cycle between ON and OFF for as long as power is applied. The ratio is 1:1 (time on = time off).



94.04

Approvals
(according to type):



- RATED VALUES: 10 A - 250 V
- DIELECTRIC STRENGTH: ≥ 2 kV AC
- PROTECTION CATEGORY: IP 20
- AMBIENT TEMPERATURE: (-40...+70)°C
- TORQUE: 0.5 Nm
- WIRE STRIP LENGTH: 8 mm
- MAX WIRE SIZE:

	solid wire	stranded wire
mm ²	1x6 / 2x2.5	1x4 / 2x2.5
AWG	1x10 / 2x14	1x12 / 2x14

Timer type	85.02		85.03		85.04	
	BLUE	BLACK	BLUE	BLACK	BLUE	BLACK
Colour	BLUE	BLACK	BLUE	BLACK	BLUE	BLACK
Clamp terminal socket: panel or 35 mm rail (EN 50022) mount	94.02	94.02.0	94.03	94.03.0	94.04	94.04.0
Retaining clip (supplied with timer)	094.81					
6-way jumper link for 94.02, 94.03 and 94.04 sockets	094.06	094.06.0	094.06	094.06.0	094.06	094.06.0
Identification tag	094.00.4					

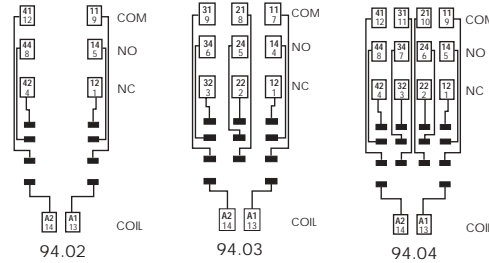
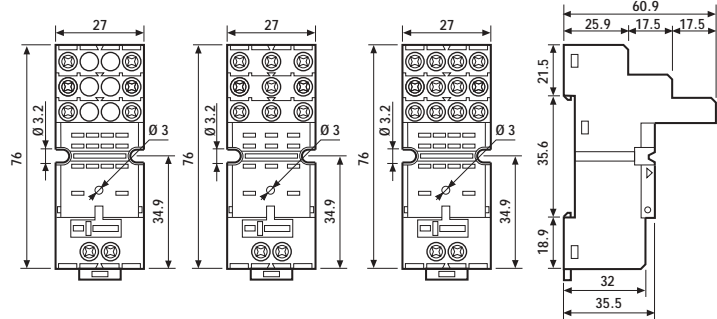

FOR 94.02, 94.03 AND 94.04 SOCKETS:

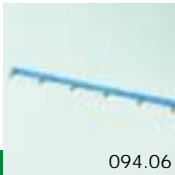

094.06

6-way jumper link for 94.02, 94.03 and 94.04 sockets	094.06
---	--------

- RATED VALUES: 10 A - 250 V

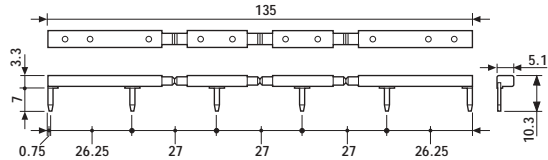



94.74

Approvals
(according to type):



- RADET VALUES: 10 A - 250 V
- DIELECTRIC STRENGTH: ≥ 2 kV AC
- PROTECTION CATEGORY: IP 20
- AMBIENT TEMPERATURE:
(-40...+70)°C
- TORQUE: 0.5 Nm
- WIRE STRIP LENGTH: 8 mm
- MAX WIRE SIZE:

	solid wire	stranded wire
mm ²	1x2.5 / 2x1.5	1x2.5 / 2x1.5
AWG	1x14 / 2x16	1x14 / 2x16

Timer type	85.02		85.03		85.04	
	BLUE	BLACK	BLUE	BLACK	BLUE	BLACK
Colour	BLUE	BLACK	BLUE	BLACK	BLUE	BLACK
Screw terminal socket: panel or 35 mm rail (EN 50022) mount	94.72	94.72.0	94.73	94.73.0	94.74	94.74.0
Retaining clip (supplied with timer)	094.81					

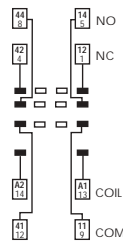
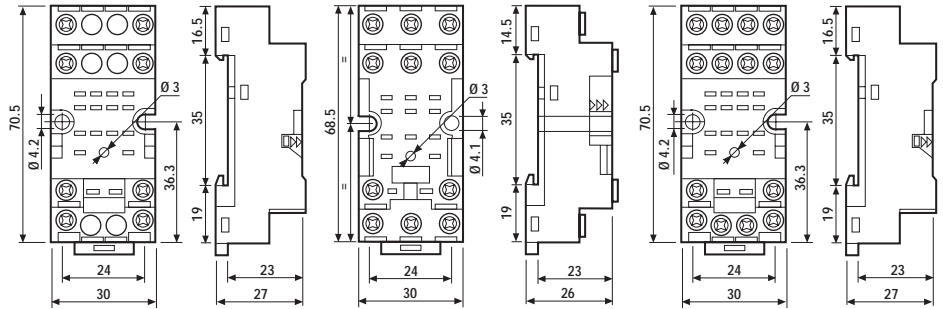

94.72

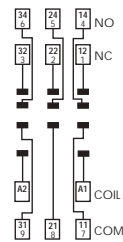

94.73

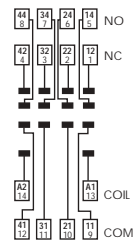

94.74



94.82

Approvals
(according to type):



- RATED VALUES: 10 A - 250 V
- DIELECTRIC STRENGTH: ≥ 2 kV AC
- PROTECTION CATEGORY: IP 20
- AMBIENT TEMPERATURE: (-40...+70)°C
- TORQUE: 0.5 Nm
- WIRE STRIP LENGTH: 9 mm
- MAX WIRE SIZE:

	solid wire	stranded wire
mm ²	1x2.5 / 2x1.5	1x2.5 / 2x1.5
AWG	1x14 / 2x16	1x14 / 2x16

Timer type	85.02	
	BLUE	BLACK
Colour	BLUE	BLACK
Screw terminal socket: panel or 35 mm rail (EN 50022) mount	94.82	94.82.0
Retaining clip (supplied with timer)	094.81	

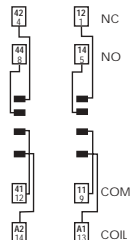
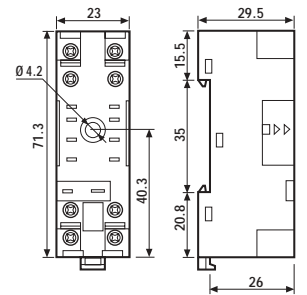

94.82

- Multi-function timer modules
- Timer module for 90 and 92 series sockets
- LED indicator

86.00



- Time scale: from 0.05s to 100 h
- Multi-function
- Plug-in for use with 90.02, 90.03 and 92.03 sockets

AI: ON delay
DI: ON pulse
SW: Symmetrical recycler: ON start

BE: Signal OFF delay
CE: ON delay
DE: Signal ON pulse
EE: Signal OFF pulse
FE: Signal ON delay + OFF pulse

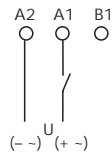
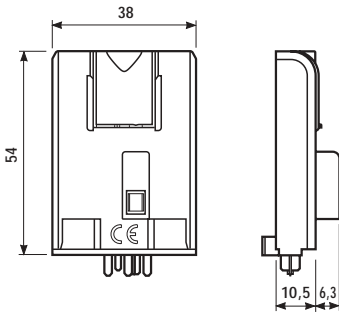

wiring diagram
without signal START

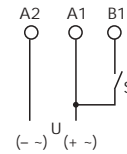

wiring diagram
with signal START

Contact specifications

Contact configuration	
Rated current/Maximum peak current	A
Rated voltage/Maximum switching voltage	V AC
Rated load in AC1	VA
Rated load in AC15 (230 VAC)	VA
Single phase motor rating (230 VAC)	kW
Breaking capacity in DC1:	30/110/220V A
Minimum switching load	mW(V/mA)
Standard contact material	

see 60 and 62 series relays

Note: don't use with relay 62.3x.x012.x300 and 62.3x.x012.x600

Supply specifications

Nominal voltage	V AC(50/60Hz)	12...240
	V DC	12...240
Rated power AC/DC	W	1.2
Operating range	AC	10.2...265
	DC	10.2...265

Technical data

Specified time range		(0.05...1)s, (0.5...10)s, (5...100)s, (0.5...10)min, (5...100)min, (0.5...10)h, (5...100)h
Repeatability	%	± 1
Recovery time	ms	≤ 50
Minimum control impulse	ms	50
Setting accuracy full range	%	± 5
Electrical life at rated load in AC1	cycles	see 60 and 62 series relays
Ambient temperature range	°C	-20...+50
Protection category		IP 20

Approvals: (according to type)



- Mono-function timer modules
- Timer module for 90, 92, 94, 95 series sockets
- LED indicator

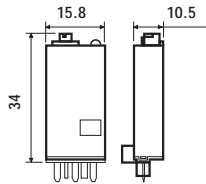

86.10

86.20

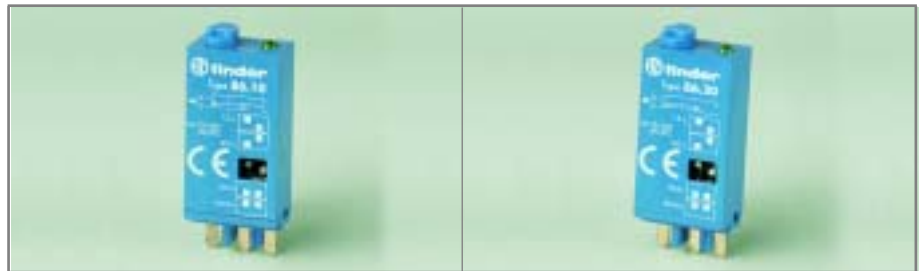

- Mono-function
- Plug-in for use with 90.03 - 92.03 - 94.02 - 94.03 - 94.04 - 95.03 - 95.05 sockets

- Mono-function
- Plug-in for use with 90.03 - 92.03 - 94.02 - 94.03 - 94.04 - 95.03 - 95.05 sockets

AI: ON delay

DI: ON pulse

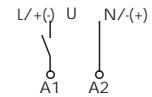
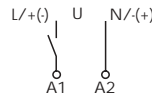

wiring diagram

wiring diagram

wiring diagram
without signal START

wiring diagram
without signal START

Contact specifications			
Contact configuration			
Rated current/Maximum peak current	A		
Rated voltage/Maximum switching voltage	V AC		
Rated load in AC1	VA		
Rated load in AC15 (230 VAC)	VA	see 40, 44, 55, 60 and 62 series relays	see 40, 44, 55, 60 and 62 series relays
Single phase motor rating (230 VAC)	kW		
Breaking capacity in DC1:	30/110/220V A		
Minimum switching load	mW(V/mA)		
Standard contact material			
Supply specifications			
Nominal voltage	V AC(50/60Hz)	12...24	12...24
	V DC	12...24 (non polarized)	12...24 (non polarized)
Rated power AC/DC	mW	150	150
Operating range	AC	$(0.8...1.1)U_N$	$(0.8...1.1)U_N$
	DC	$(0.8...1.1)U_N$	$(0.8...1.1)U_N$
Technical data			
Specified time range		(1.5...15)s,(6...60)s,(0.8...8)min,(6.4...64)min	(1.5...15)s,(6...60)s,(0.8...8)min,(6.4...64)min
Repeatability	%	± 1	± 1
Recovery time	ms	≤ 150	≤ 150
Minimum control impulse	ms	—	—
Setting accuracy-full range	%	± 5	± 5
Electrical life at rated load in AC1	cycles	see 40, 44, 55, 60 and 62 series relays	see 40, 44, 55, 60 and 62 series relays
Ambient temperature range	°C	0...+50	0...+50
Protection category		IP 20	IP 20
Approvals: (according to type)			

ORDERING INFORMATION

Example: a 86 series multi-function timer module with (12 to 240) V AC/DC supply voltage.

8 6 . 0 0 . 0 . 2 4 0 . 0 0 0 0

Series _____

Type _____

0 = Multi-function (AI, DI, SW, BE, CE, DE, EE, FE)
 1 = Mono-function (AI)
 2 = Mono-function (DI)

No. of poles _____

see 40, 44, 55, 60 and 62 series relays

Supply voltage

024 = 12...24 V AC/DC (86.10/20 only)
 240 = 12...240 V AC/DC (86.00 only)

Supply version

0 = AC (50/60 Hz)/DC

COMBINATIONS

Number of poles	Relay type	Socket type	Timer module
1	40.31	95.03	86.10/86.20
1	40.61	95.05	86.10/86.20
2	40.52/44.52/44.62	95.05	86.10/86.20
2	55.32	94.02	86.10/86.20
2	60.12	90.02	86.00/86.10/86.20
2	62.32	92.03	86.00/86.10/86.20
3	55.33	94.03	86.10/86.20
3	60.13	90.03	86.00/86.10/86.20
3	62.33	92.03	86.00/86.10/86.20
4	55.34	94.04	86.10/86.20

TECHNICAL DATA

EMC SPECIFICATIONS

TYPE OF TEST	REFERENCE STANDARD	86.00	86.10/20	
ELECTROSTATIC DISCHARGE	- contact discharge	EN 61000-4-2	4 kV	n.a.
	- air discharge	EN 61000-4-2	8 kV	8 kV
RADIO-FREQUENCY ELECTROMAGNETIC FIELD (80 ÷ 1000 MHz)	EN 61000-4-3	10 V/m	10 V/m	
FAST TRANSIENTS (burst) (5-50 ns, 5 kHz) on Supply terminals	EN 61000-4-4	2 kV	2 kV	
SURGES (1.2/50 µs) on Supply terminals	- common mode	EN 61000-4-5	2 kV	2 kV
	- differential mode	EN 61000-4-5	1 kV	—
RADIO-FREQUENCY COMMON MODE (0.15 ÷ 80 MHz) on Supply terminals	EN 61000-4-6	10 V	10 V	
RADIATED AND CONDUCTED EMISSION	EN 55022	class B	class B	

OTHER DATA

	86.00	86.10, 86.20	
CURRENT ABSORPTION on signal control (B1)	mA	1	—
POWER LOST IN THE ENVIRONMENT			
- without contact current	W	0.1 (12 V) - 1 (230 V)	0.2
- with rated current		see 60 and 62 series relays	see 40, 44, 55, 60, 62 series relays

TIME SCALES

Type 86.00

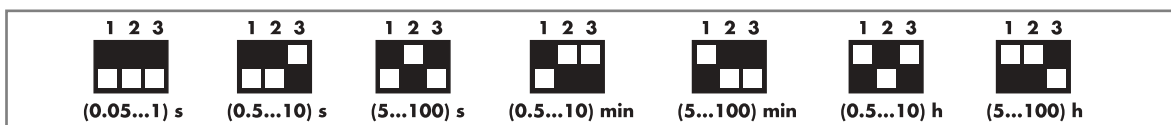

Type 86.10
 Type 86.20

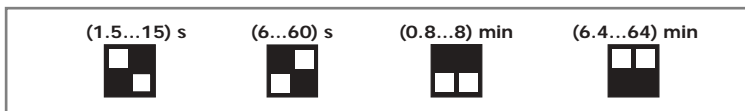

NOTE: time scales and functions must be set before energising the timer.

FUNCTIONS

	LED Type 86.00	LED Type 86.10/20	Supply voltage	NO output contact
U = Supply Voltage			OFF	Open
S = Signal switch			ON	Open
= Output Contact			ON	Open (timing in progress)
			ON	Closed

Without signal Start= Start via contact in supply line (A1).
 With signal Start = Start via contact into control terminal (B1).

Type 86.00

Wiring diagram

without signal START

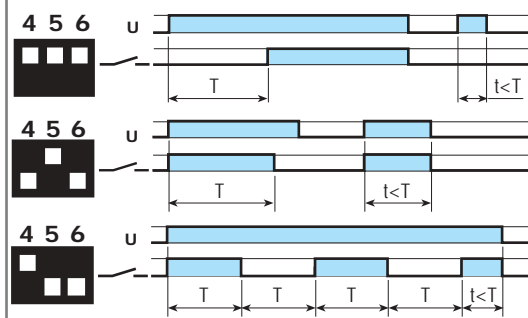
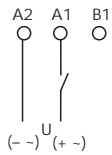

- (AI) ON delay.**
Apply power to timer. Output contacts transfer after preset time has elapsed. Reset occurs when power is removed.
- (DI) ON pulse.**
Apply power to timer. Output contacts transfer immediately. After the preset time has elapsed, contacts reset.
- (SW) Symmetrical recycler: ON start.**
Apply power to timer. Output contacts transfer immediately and cycle between ON and OFF for as long as power is applied. The ratio is 1:1 (time on = time off).

with signal START

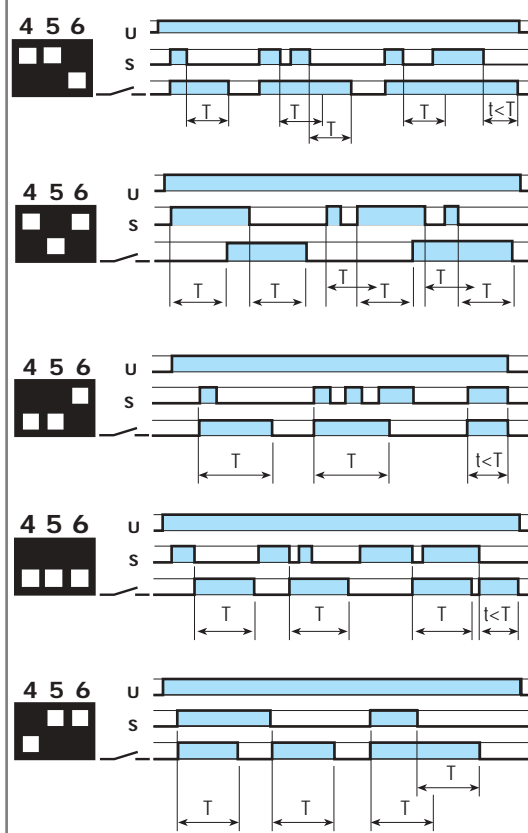
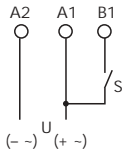

- (BE) Signal OFF delay.**
Power is permanently applied to the timer. The output contacts transfer immediately on closure of the Signal Switch (S). Opening the Signal Switch initiates the preset delay, after which time the output contacts reset.
- (CE) Signal ON and OFF delay.**
Power is permanently applied to the timer. Closing the Signal Switch (S) initiates the preset delay, after which time the output contacts transfer. Opening the Signal switch initiates the same preset delay, after which time the output contacts reset.
- (DE) Signal ON pulse.**
Power is permanently applied to the timer. On momentary or maintained closure of Signal Switch (S), the output contacts transfer, and remain so for the duration of the preset delay, after which they reset.
- (EE) Signal OFF pulse.**
Power is permanently applied to the timer. On opening of the Signal Switch (S) the output contacts transfer, and remain so for the duration of the preset delay, after which they reset.
- (FE) Signal ON pulse + OFF pulse.**
Power is permanently applied to the timer. Both the opening and closing of the Signal Switch (S) initiates the transfer of the output contacts. In both instances the contacts reset after the delay period has elapsed.

Wiring diagram

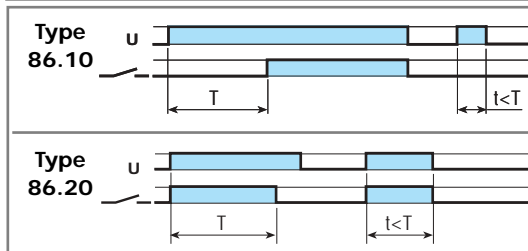
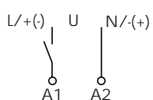

- (AI) ON delay.**
Apply power to timer. Output contacts transfer after preset time has elapsed. Reset occurs when power is removed.
- (DI) ON pulse.**
Apply power to timer. Output contacts transfer immediately. After the preset time has elapsed, contacts reset.



90.03

Relay type	60.12		60.13	
Colour	BLUE	BLACK	BLUE	BLACK
Clamp terminal socket: panel or 35 mm rail (EN 50022) mount	90.02	90.02.0	90.03	90.03.0
Metal retaining clip	090.33			
Timer module	86.00, 86.10, 86.20			
6-way jumper link for 90.02 and 90.03 sockets	090.06			

Approvals
(according to type):



- Double terminal A1 (for easy start connection).
- RATED VALUES: 10 A - 250 V
- DIELECTRIC STRENGTH: ≥ 2 kV AC
- PROTECTION CATEGORY: IP 20
- AMBIENT TEMPERATURE: (-40...+70)°C
- TORQUE: 0.6 Nm
- WIRE STRIP LENGTH: 10 mm
- MAX WIRE SIZE:

	solid wire	stranded wire
mm ²	1x6 / 2x2.5	1x4 / 2x2.5
AWG	1x10 / 2x14	1x12 / 2x14

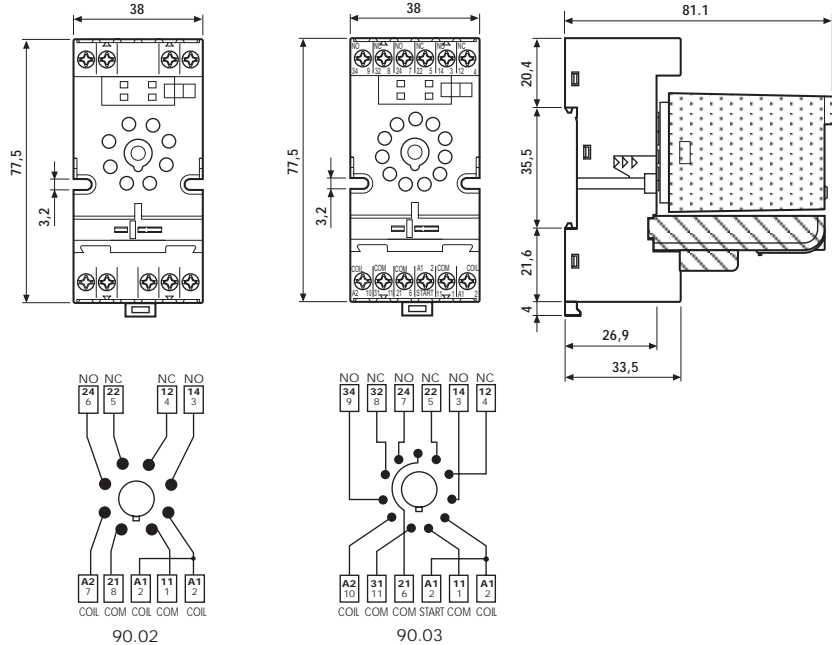

92.03

Relay type	62.32, 62.33	
Colour	BLUE	BLACK
Clamp terminal socket: panel or 35 mm rail (EN 50022) mount retaining clip 092.71 supplied with socket packaging code SMA	92.03	92.03.0
Metal retaining clip	092.71	
Timer modules	86.00, 86.10, 86.20	

Approvals
(according to type):

86



- RATED VALUES: 16 A - 250 V
- INSULATION: ≥ 6 kV (1.2/50 μ s) between coil and contacts
- PROTECTION CATEGORY: IP 20
- AMBIENT TEMPERATURE: (-40...+70)°C
- SCREW TORQUE: 0.8 Nm
- WIRE STRIP LENGTH: 10 mm
- MAX WIRE SIZE:

	solid wire	stranded wire
mm ²	1x10 / 2x4	1x6 / 2x4
AWG	1x8 / 2x12	1x10 / 2x12

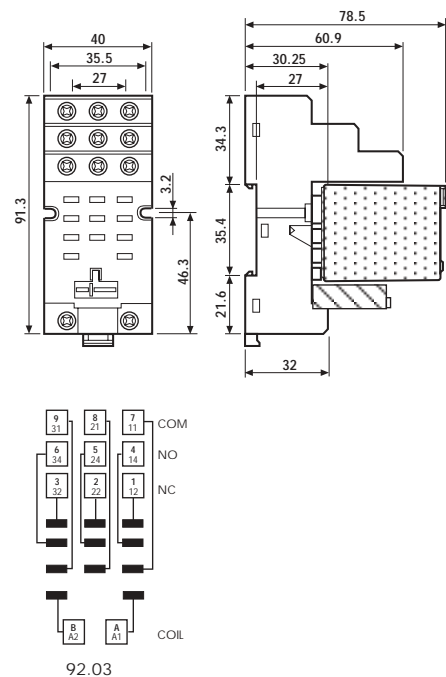



94.04

Approvals
(according to type):



GOST US

Relay type	55.32		55.33		55.32, 55.34	
Colour	BLUE	BLACK	BLUE	BLACK	BLUE	BLACK
Clamp terminal socket: panel or 35 mm rail (EN 50022) mount retaining clip 094.71 supplied with socket packaging code SMA	94.02	94.02.0	94.03	94.03.0	94.04	94.04.0
Metal retaining clip	094.71					
Plastic retaining and release clip	094.01					
6-way jumper link for 94.02, 94.03 and 94.04 sockets	094.06	094.06.0	094.06	094.06.0	094.06	094.06.0
Identification tag	094.00.4					
Timer modules	86.10, 86.20					
Sheet of marker tags for retaining and release clip 094.01	060.72					

- RATED VALUES: 10 A - 250 V
- DIELECTRIC STRENGTH: ≥ 2 kV AC
- PROTECTION CATEGORY: IP 20
- AMBIENT TEMPERATURE: (-40...+70)°C
- SCREW TORQUE: 0.5 Nm
- WIRE STRIP LENGTH: 8 mm
- MAX WIRE SIZE:

	solid wire	stranded wire
mm ²	1x6 / 2x2.5	1x4 / 2x2.5
AWG	1x10 / 2x14	1x12 / 2x14

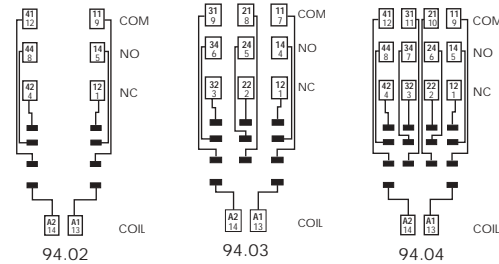
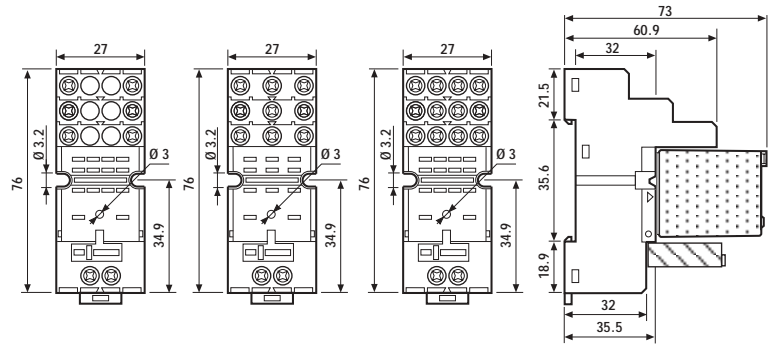

094.01

Relay type	40.31		40.51, 40.52, 40.61	
Colour	BLUE	BLACK	BLUE	BLACK
Clamp terminal socket: panel or 35 mm rail (EN 50022) mount, retaining clip 095.01 supplied with socket packaging code SPA	95.03	95.03.0	95.05	95.05.0
Plastic retaining and release clip	095.01	095.01.0	095.01	095.01.0
Metal retaining clip	095.71			
8-way jumper link for 95.03 and 95.05 sockets	095.18	095.18.0	095.18	095.18.0
Identification tag	095.00.4			
Timer modules	86.10, 86.20			

- RATED VALUES: 10 A - 250 V
with a current >10 A, the contact terminal must be connected in parallel (21 with 11, 24 with 14, 22 with 12)
- INSULATION: ≥ 6 kV (1.2/50 μ s) between coil and contacts
- PROTECTION CATEGORY: IP 20
- AMBIENT TEMPERATURE: (-40...+70) °C
- SCREW TORQUE: 0.5 Nm
- WIRE STRIP LENGTH: 8 mm
- MAX WIRE SIZE:

	solid wire	stranded wire
mm ²	1x6 / 2x2.5	1x4 / 2x2.5
AWG	1x10 / 2x14	1x12 / 2x14

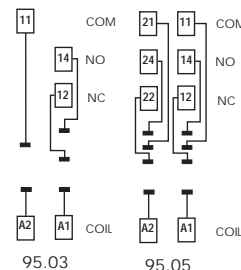
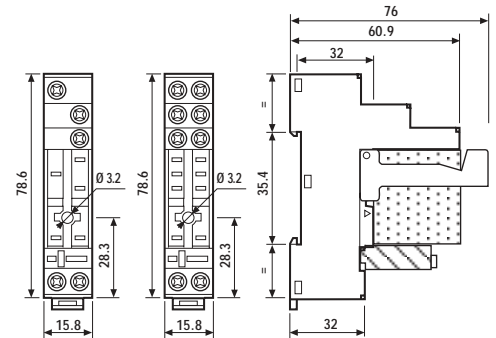

095.01

- 22.5 mm wide
- Mono-function and multi-function versions available
- Time scales from 0.05s to 60h
- "1 delayed contact + 1 instantaneous contact" and remote potentiometer version available (type 87.02)
- True OFF delay version (type 87.61/62)
- LED indicator
- 35 mm rail (EN 50022) mount

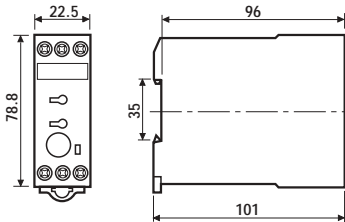

87.01

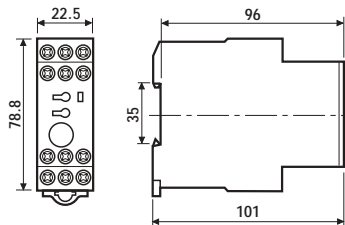

87.02

87.01

87.02



- Multi-function
- 1 pole
- 35 mm rail mounting

- Multi-function
- Timing can be regulated using ext. Potentiometer
- 2 timed contacts or 1 timed + 1 instantaneous contact
- 35 mm rail mounting

- AI:** ON delay
- DI:** ON pulse
- GI:** Fixed pulse delayed
- SW:** Symmetrical recycler: ON start
- BE:** Signal OFF delay
- CE:** Signal ON and OFF Delay
- DE:** Signal ON pulse
- EE:** Signal OFF pulse

- AI:** ON delay
- DI:** ON pulse
- GI:** Fixed pulse delayed
- SW:** Symmetrical recycler: ON start
- BE:** Signal OFF delay
- CE:** Signal ON and OFF Delay
- DE:** Signal ON pulse
- EE:** Signal OFF pulse

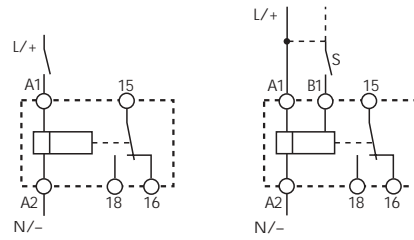

wiring diagram (without signal START)

wiring diagram (with signal START)

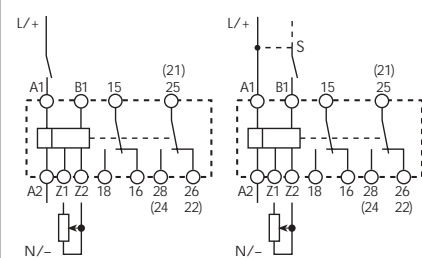

wiring diagram (without signal START)

wiring diagram (with signal START)

Contact specifications			
Contact configuration		1 CO	2 CO
Rated current/Maximum peak current	A	8/30	8/30
Rated voltage/Maximum switching voltage	V AC	250/400	250/400
Rated load in AC1	VA	2,000	2,000
Rated load in AC15 (230 VAC)	VA	400	400
Single phase motor rating (230 VAC)	kW	0.185	0.185
Breaking capacity in DC1:	30/110/220V A	8/0.5/0.2	8/0.5/0.2
Minimum switching load	mW(V/mA)	300 (10/5)	300 (10/5)
Standard contact material		AgCdO	AgCdO
Supply specifications			
Nominal voltage	V AC(50/60Hz)	24...240	24...240
	V DC	24...48	24...48
Rated power AC/DC	VA (50Hz)/W	5/0.5	5/0.5
Operating range	AC	(0.85...1.1)U _N	(0.85...1.1)U _N
	DC	(0.85...1.2) U _N	(0.85...1.2)U _N
Technical data			
Specified time range		See page 137	See page 137
Repeatability	%	± 2	± 2
Recovery time	ms	50	50
Minimum control impulse	ms	50	50
Setting accuracy-full range	%	± 5	± 5
Electrical life at rated load in AC1	cycles	100·10 ³	100·10 ³
Ambient temperature range	°C	-20...+60	-20...+60
Protection category		IP 20	IP 20
Approvals: (according to type)			GOST

- 22.5 mm wide
- Mono-function and multi-function versions available
- Time scales from 0.05s to 60h
- "1 delayed contact + 1 instantaneous contact" and remote potentiometer version available (type 87.02)
- True OFF delay version (type 87.61/62)
- LED indicator
- 35 mm rail (EN 50022) mount

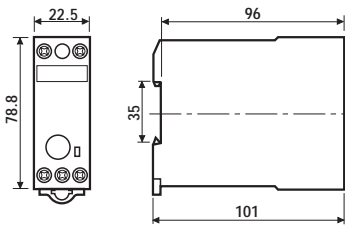

87.31

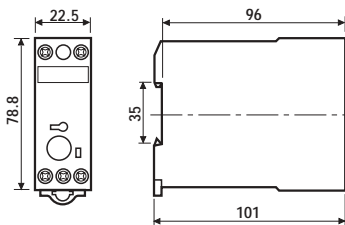

87.11
87.21

87.11

87.21

87.31



- Mono-function
- 35 mm rail mounting

- Mono-function
- 35 mm rail mounting

- Mono-function
- 35 mm rail mounting

AI: ON delay

DI: ON pulse

SW: Symmetrical recycler: ON start

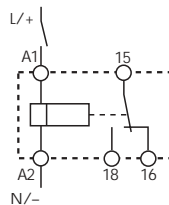

wiring diagram
(without signal START)

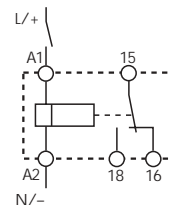

wiring diagram
(without signal START)

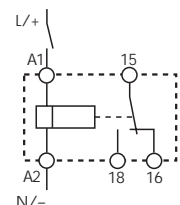

wiring diagram
(without signal START)

Contact specifications				
Contact configuration		1 CO	1 CO	1 CO
Rated current/Maximum peak current	A	8/30	8/30	8/30
Rated voltage/Maximum switching voltage	V AC	250/400	250/400	250/400
Rated load in AC1	VA	2,000	2,000	2,000
Rated load in AC15 (230 VAC)	VA	400	400	400
Single phase motor rating (230 VAC)	kW	0.185	0.185	0.185
Breaking capacity in DC1:	30/110/220V A	8/0.5/0.2	8/0.5/0.2	8/0.5/0.2
Minimum switching load	mW(V/mA)	300 (10/5)	300 (10/5)	300 (10/5)
Standard contact material		AgCdO	AgCdO	AgCdO
Supply specifications				
Nominal voltage	V AC(50/60Hz)	24...240	24...240	24...240
	V DC	24...48	24...48	24...48
Rated power AC/DC	VA (50Hz)/W	5/0.5	5/0.5	5/0.5
Operating range	AC	(0.85...1.1)U _N	(0.85...1.1)U _N	(0.85...1.1)U _N
	DC	(0.85...1.2)U _N	(0.85...1.2)U _N	(0.85...1.2)U _N
Technical data				
Specified time range		See page 137	See page 137	See page 137
Repeatability	%	± 0.2	± 0.2	± 0.2
Recovery time	ms	50	50	50
Minimum control impulse	ms	—	—	—
Setting accuracy-full range	%	± 5	± 5	± 5
Electrical life at rated load in AC1	cycles	100 · 10 ³	100 · 10 ³	100 · 10 ³
Ambient temperature range	°C	-20...+60	-20...+60	-20...+60
Protection category		IP 20	IP 20	IP 20
Approvals: (according to type)				GOST

- 22.5 mm wide
- Mono-function and multi-function versions available
- Time scales from 0.05s to 60h
- "1 delayed contact + 1 instantaneous contact" and remote potentiometer version available (type 87.02)
- True OFF delay version (type 87.61/62)
- LED indicator
- 35 mm rail (EN 50022) mount

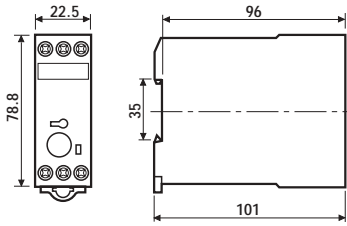

87.41

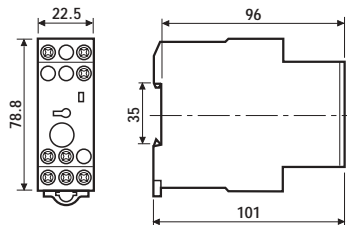

87.61
87.62

87.41



- Mono-function
- 35 mm rail mounting

BE: Signal OFF delay

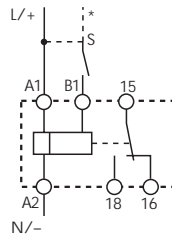

wiring diagram
(with signal START)

87.61



- Mono-function
- 1 pole
- 35 mm rail mounting

BI: True OFF delay

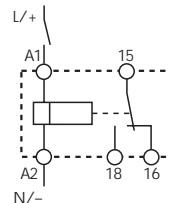

wiring diagram
(without signal START)

87.62



- Mono-function
- 2 pole
- 35 mm rail mounting

BI: True OFF delay

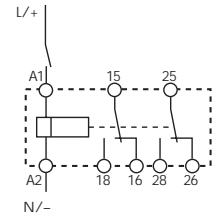

wiring diagram
(without signal START)

Contact specifications				
Contact configuration		1 CO	1 CO	2 CO
Rated current/Maximum peak current	A	8/30	5/10	5/10
Rated voltage/Maximum switching voltage	V AC	250/400	250/400	250/400
Rated load in AC1	VA	2,000	1,250	1,250
Rated load in AC15 (230 VAC)	VA	400	250	250
Single phase motor rating (230 VAC)	kW	0.185	0.125	0.125
Breaking capacity in DC1:	30/110/220V A	8/0.5/0.2	5/0.5/0.2	5/0.5/0.2
Minimum switching load	mW(V/mA)	300 (10/5)	300 (10/5)	300 (10/5)
Standard contact material		AgCdO	AgCdO	AgCdO
Supply specifications				
Nominal voltage	V AC(50/60Hz)	24...240	24...240	24...240
	V DC	24...48	24...240	24...240
Rated power AC/DC	VA (50Hz)/W	5/0.5	1.5/1.5	1.5/1.5
Operating range	AC	(0.85...1.1)U _N	(0.85...1.1)U _N	(0.85...1.1)U _N
	DC	(0.85...1.2)U _N	(0.85...1.2)U _N	(0.85...1.2)U _N
Technical data				
Specified time range		See page 137	See page 137	See page 137
Repeatability	%	± 0.2	± 1	± 1
Recovery time	ms	50	50	50
Minimum control impulse	ms	50	300 ms (A1 - A2)	300 ms (A1 - A2)
Setting accuracy-full range	%	± 5	± 5	± 5
Electrical life at rated load in AC1	cycles	100 · 10 ³	100 · 10 ³	100 · 10 ³
Ambient temperature range	°C	-20...+60	-20...+60	-20...+60
Protection category		IP 20	IP 20	IP 20
Approvals: (according to type)				

- 22.5 mm wide
- Mono-function and multi-function versions available
- Time scales from 0.05s to 60h
- "1 delayed contact + 1 instantaneous contact" and remote potentiometer version available (type 87.02)
- True OFF delay version (type 87.61/62)
- LED indicator
- 35 mm rail (EN 50022) mount

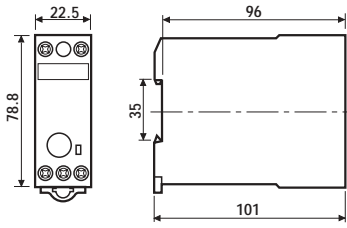

87.82

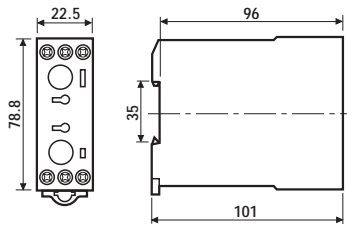

87.91

	87.82	87.91				
	- Mono-function: Star - delta - 2 pole - 35 mm rail mounting	- Multi-function - 35 mm rail mounting				
	SD: Star - delta star - delta wiring diagram (without signal START)	<table style="width: 100%; border: none;"> <tr> <td style="width: 50%; vertical-align: top;"> LI: Asymmetrical recycler (ON starting) PI: Asymmetrical recycler (OFF starting) </td> <td style="width: 50%; vertical-align: top;"> LE: Signal asymmetrical recycler (ON starting) PE: Signal asymmetrical recycler (OFF starting) </td> </tr> </table> <table style="width: 100%; border: none; margin-top: 10px;"> <tr> <td style="width: 50%; text-align: center;"> wiring diagram (without signal START) </td> <td style="width: 50%; text-align: center;"> wiring diagram (with signal START) </td> </tr> </table>	LI: Asymmetrical recycler (ON starting) PI: Asymmetrical recycler (OFF starting)	LE: Signal asymmetrical recycler (ON starting) PE: Signal asymmetrical recycler (OFF starting)	 wiring diagram (without signal START)	 wiring diagram (with signal START)
LI: Asymmetrical recycler (ON starting) PI: Asymmetrical recycler (OFF starting)	LE: Signal asymmetrical recycler (ON starting) PE: Signal asymmetrical recycler (OFF starting)					
 wiring diagram (without signal START)	 wiring diagram (with signal START)					
Contact specifications						
Contact configuration	2 NO	1 CO				
Rated current/Maximum peak current A	8/30	8/30				
Rated voltage/Maximum switching voltage V AC	250/400	250/400				
Rated load in AC1 VA	2,000	2,000				
Rated load in AC15 (230 VAC) VA	400	400				
Single phase motor rating (230 VAC) kW	0.185	0.185				
Breaking capacity in DC1: 30/110/220V A	8/0.5/0.2	8/0.5/0.2				
Minimum switching load mW(V/mA)	300 (10/5)	300 (10/5)				
Standard contact material	AgCdO	AgCdO				
Supply specifications						
Nominal voltage V AC(50/60Hz)	24...240	24...240				
V DC	24...48	24...48				
Rated power AC/DC VA (50Hz)/W	5/0.5	5/0.5				
Operating range AC	(0.85...1.1)U _N	(0.85...1.1)U _N				
DC	(0.85...1.2)U _N	(0.85...1.2)U _N				
Technical data						
Specified time range	See page 137	See page 137				
Repeatability %	± 0.2	± 0.2				
Recovery time ms	50	50				
Minimum control impulse ms	—	50				
Setting accuracy-full range %	± 5	± 5				
Electrical life at rated load in AC1 cycles	100 · 10 ³	100 · 10 ³				
Ambient temperature range °C	-20...+60	-20...+60				
Protection category	IP 20	IP 20				
Approvals: (according to type)						

ORDERING INFORMATION

Example: 87 series 8 A multi-function timer, 1 CO contact, with (24...240) V AC (50/60) Hz and (24...48) V DC supply.

8 7 . 0 1 . 0 . 2 4 0 . 0 0 0 0

Series

Type

- 0 = Multi-function (AI, BE, CE, DI, DE, EE, GI, SW, ON, OFF)
- 1 = ON delay (AI)
- 2 = ON pulse (DI)
- 3 = Symmetrical recycler: ON start (SW)
- 4 = Signal OFF delay (BE)
- 6 = True OFF delay (power OFF) (BI)
- 8 = Star - delta (SD)
- 9 = Asymmetrical recycler (LI, LE, PI, PE)

Supply voltage

- 240 = { 24...48 V DC
- 24...240 V AC
- 240 = 24...240 V AC/DC for 87.61 and 87.62

Supply version

- 0 = AC (50/60 Hz)/DC

No. of poles

- 1 = 1 pole
- 2 = 2 pole for 87.02/62
- 2 = 2 NO for 87.82

TECHNICAL DATA

EMC SPECIFICATIONS

TYPE OF TEST		REFERENCE STANDARD	
ELECTROSTATIC DISCHARGE	- contact discharge	EN 61000-4-2	8 kV
	- air discharge	EN 61000-4-2	8 kV
RADIO-FREQUENCY ELECTROMAGNETIC FIELD (80 ÷ 1000 MHz)		EN 61000-4-3	10 V/m
FAST TRANSIENTS (burst) (5-50 ns, 5 kHz) on Supply terminals		EN 61000-4-4	6 kV
SURGES (1.2/50 µs) on Supply terminals	- common mode	EN 61000-4-5	4 kV
	- differential mode	EN 61000-4-5	—
RADIO-FREQUENCY COMMON MODE (0.15 ÷ 80 MHz) on Supply terminals		EN 61000-4-6	10 V
RADIATED AND CONDUCTED EMISSION		EN 55022	class B

OTHER DATA

SIGNAL CONTROL (B1)	- current absorption	1 mA		
	- max cable length (capacity of ≤ 10 nF / 100 m)	≤ 250 m		
POWER LOST TO THE ENVIRONMENT		87.01/02/11/21/31/41/91	87.61/62	87.82
- without contact current	W	5	1.5	8
- with rated current	W	15	7	18
MAX WIRE SIZE		solid cable		stranded cable
		mm ²	1x4 / 2x2.5	1x4 / 2x1.5
		AWG	1x12 / 2x14	1x12 / 2x16
SCREW TORQUE	Nm	1.2		

TIME SCALES

Type	Function Code	Function	s	s	s	min	min	min	h	h	h	h
			0.05	0.15	0.5	0.05	0.15	0.5	0.05	0.15	0.5	3
			1	3	10	1	3	10	1	3	10	60
87.01/ 87.02	AI	ON delay	•	•	•	•	•	•	•	•	•	•
	BE	Signal OFF delay	•	•	•	•	•	•	•	•	•	•
	CE	Signal ON and OFF delay	•	•	•	•	•	•	•	•	•	•
	DI	ON pulse	•	•	•	•	•	•	•	•	•	•
	DE	Signal ON pulse	•	•	•	•	•	•	•	•	•	•
	EE	Signal OFF pulse	•	•	•	•	•	•	•	•	•	•
	GI	Fixed pulse (0,5s) delayed	•	•	•	•	•	•	•	•	•	•
	SW	Symmetrical recycler: ON start	•	•	•	•	•	•	•	•	•	•
87.11	AI	ON delay	•	•	•	•	•	•	•	•	•	•
87.21	DI	ON pulse	•	•	•	•	•	•	•	•	•	•
87.31	SW	Symmetrical recycler: ON start			•							
87.41	BE	Signal OFF delay	•	•	•	•	•	•	•	•	•	•
87.61/ 87.62	BI	True OFF delay (power OFF)		0.15 2.5	•	0.07 1.3		•				
87.82	SD	Star - delta ($T_{U} = -60$ ms)				•						
87.91	LI	Asymmetrical recycler (ON starting)	•	•	•	•	•	•	•	•	•	•
	LE	Signal asymmetrical recycler (ON starting)	•	•	•	•	•	•	•	•	•	•
	PI	Asymmetrical recycler (OFF starting)	•	•	•	•	•	•	•	•	•	•
	PE	Signal asymmetrical recycler (OFF starting)	•	•	•	•	•	•	•	•	•	•

NOTE: time scales and functions must be set before energising the timer.

FUNCTIONS

	LED** Green	Timing	NO output contact	Timed		Contacts DIP switch	Instantaneous*	
				Open	Closed		Open	Closed
U = Supply Voltage		None	Open	15 - 18 25 - 28*	15 - 16 25 - 26*		21 - 24*	21 - 22*
S = Signal switch		In progress	Open	15 - 18 25 - 28*	15 - 16 25 - 26*		21 - 22*	21 - 24*
C = Output Contact		In progress	Closed	15 - 16 25 - 26*	15 - 18 25 - 28*		21 - 22*	21 - 24*
		None	Closed	15 - 16 25 - 26*	15 - 18 25 - 28*			21 - 22*

* 25-26-28 only for type 87.02 with 2 timed contacts. 21-22-24 only for type 87.02 with 1 instantaneous contact + 1 timed positioning the front DIP switch. ** The LED on types 87.61 and 87.62 is illuminated when supply voltage is supplied to timer.

Without signal Start= Start via contact in supply line (A1). With signal Start = Start via contact into control terminal (B1).

Wiring diagram

Multi-function without signal START

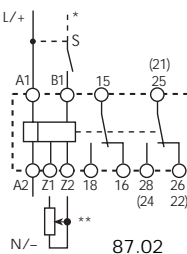
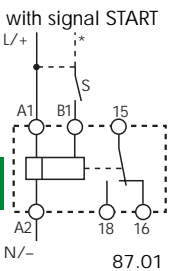
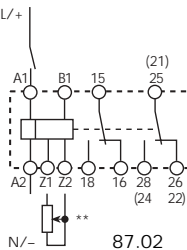
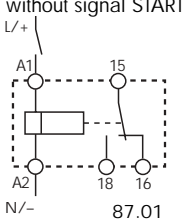

* A voltage other than the supply voltage can be applied to the command START (B1).
Example:
A1 - A2 = 230 V AC
B1 - A2 = 24 V AC

** Type 87.02: regulated using an external potentiometer (10 kΩ - 0.25 W).
NB.: remove link between Z1-Z2 and position the Timer potentiometer on "zero".

Type 87.01 87.02		(AI) ON delay. Apply power to timer. Output contacts transfer after preset time has elapsed. Reset occurs when power is removed.
		(DI) ON pulse. Apply power to timer. Output contacts transfer immediately. After the preset time has elapsed, contacts reset.
		(GI) Fixed pulse (0.5s) delayed. Apply power to timer. Output contacts transfer after preset time has elapsed. Reset occurs after a fixed time of 0.5s. 0.5s.
		(SW) Symmetrical recycler: ON start. Apply power to timer. Output contacts transfer immediately and cycle between ON and OFF for as long as power is applied. The ratio is 1:1 (time on = time off).
		(BE) Signal OFF delay. Power is permanently applied to the timer. The output contacts transfer immediately on closure of the Signal Switch (S). Opening the Signal Switch initiates the preset delay, after which time the output contacts reset.
		(CE) Signal ON and OFF delay. Power is permanently applied to the timer. Closing the Signal Switch (S) initiates the preset delay, after which time the output contacts transfer. Opening the Signal switch initiates the same preset delay, after which time the output contacts reset.
		(DE) Signal ON pulse. Power is permanently applied to the timer. On momentary or maintained closure of Signal Switch (S), the output contacts transfer, and remain so for the duration of the preset delay, after which they reset.
		(EE) Signal OFF pulse. Power is permanently applied to the timer. On opening of the Signal Switch (S) the output contacts transfer, and remain so for the duration of the preset delay, after which they reset.
		Permanently ON. Selecting the function ON when power is applied to the relay the first contact transfers immediately and remains in that position.
		Permanently OFF. The contact returns to the original position when the OFF function is selected.

FUNCTIONS

Wiring diagram

Monofunction

without signal START

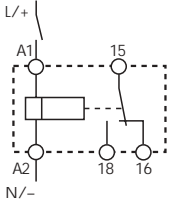

- 87.11
- 87.21
- 87.31
- 87.61

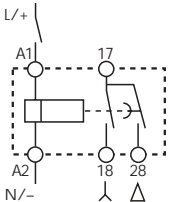

87.62

with signal START (S)

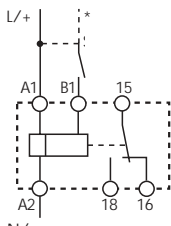

87.41

Asymmetrical recycler

without signal START

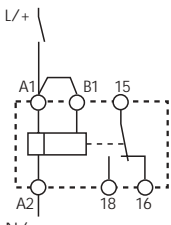

87.91

with signal START (S)

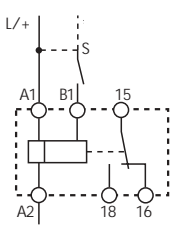

87.91

Type	Timing Diagram	Description
87.11		(AI) ON delay. Apply power to timer. Output contacts transfer after preset time has elapsed. Reset occurs when power is removed.
87.21		(DI) ON pulse. Apply power to timer. Output contacts transfer immediately. After the preset time has elapsed, contacts reset.
87.31		(SW) Symmetrical recycler: ON start. Apply power to timer. Output contacts transfer immediately and cycle between ON and OFF for as long as power is applied. The ratio is 1:1 (time on = time off).
87.61 87.62		(BI) True OFF delay (power OFF). Apply power to timer (minimum 300ms). Output contacts transfer immediately. Removal of power initiates the preset delay, after which time the output contacts reset.
87.82		(SD) Star - delta. Apply power to timer. The star contact (Λ) closes immediately. After preset delay has elapsed the star contact (Λ) resets. After a further fixed time of ~60 ms the delta contact (Δ) closes and remains in that position, until reset on power off.
87.41		(BE) Signal OFF delay. Power is permanently applied to the timer. The output contacts transfer immediately on closure of the Signal Switch (S). Opening the Signal Switch initiates the preset delay, after which time the output contacts reset.

87.91	 	(LI) Asymmetrical recycler (ON starting). Apply power to timer. Output contacts transfer immediately and cycle between ON and OFF for as long as power is applied. The ON and OFF times are independently adjustable.
	 	(PI) Asymmetrical recycler (OFF starting). Apply power to timer. Output contacts transfer after time T1 has elapsed and cycle between OFF and ON for as long as power is applied. The ON and OFF times are independently adjustable.
	 	(LE) Signal asymmetrical recycler (ON starting) Power is permanently applied to the timer. Closing Signal Switch (S) causes the output contacts to transfer immediately and cycle between ON and OFF, until opened.
	 	(PE) Signal asymmetrical recycler (OFF starting). Power is permanently applied to the timer. Closing the Signal Switch (S) initiates delay T1 after which the output contacts transfer and continue to cycle between OFF and ON, until the Signal Switch is opened.

- 8 - 11 pin plug-in version available
- Multi-voltage and multi-function versions available
- Time scales from 0.05s to 100h
- "1 delayed contact + 1 instantaneous contact" version available (type 88.12)
- Front panel mount
- Sockets: 90 series

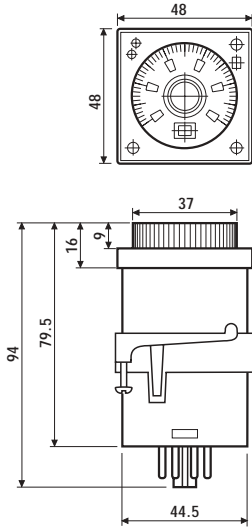

88.02



- Multi-function
- 11 pin
- Plug-in for use with 90 series sockets

AE: Signal ON delay
BE: Signal OFF delay
DE: Signal ON pulse

with signal START

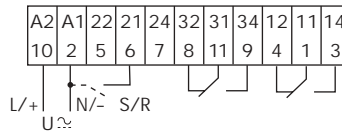

AI: ON delay
HI: ON pulse
SW: Symmetrical recycle: ON start

without signal START

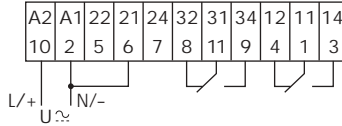

88.12



- Multi-function
- 8 pin, 2 timed contacts or 1 timed + 1 instantaneous contact
- Plug-in for use with 90 series sockets

AI a: ON Delay (2 timed contacts)
AI b: ON Delay (1 timed + 1 instantaneous contact)
DI a: ON Pulse (2 timed contacts)
DI b: ON Pulse (1 timed + 1 instantaneous contact)

without signal START

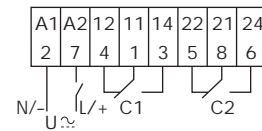

Contact specifications

Contact configuration		2 CO	2 CO
Rated current/Maximum peak current	A	8/15	5/10
Rated voltage/Maximum switching voltage	V AC	250/250	250/400
Rated load in AC1	VA	2,000	1,250
Rated load in AC15 (230 VAC)	VA	400	250
Single phase motor rating (230 VAC)	kW	0.3	0.125
Breaking capacity in DC1:	30/110/220V A	8/0.3/0.12	5/0.3/0.12
Minimum switching load	mW(V/mA)	300 (5/5)	500 (5/5)

88

Standard contact material		AgNi	AgCdO
---------------------------	--	------	-------

Supply specifications

Nominal voltage	V AC(50/60Hz)	24...230	24...230
	V DC	24...230	24...48
Rated power AC/DC	VA (50Hz)/W	3.5 (230 V)/1 (24 V)	9 (230 V)/1 (24 V)
Operating range	AC	20.4...264.5	20.4...264.5
	DC	20.4...264.5	20.4...55.2

Technical data

Specified time range		(0.05s...5h) - (0.05s...10h) - (0.05s...50h) - (0.05s...100h)	
Repeatability	%	± 1	± 1
Recovery time	ms	300	200
Minimum control impulse	ms	50	—
Setting accuracy-full range	%	± 3	± 3
Electrical life at rated load in AC1	cycles	100·10 ³	100·10 ³
Ambient temperature range	°C	-10...+55	-10...+55
Protection category		IP 40	IP 40

Approvals: (according to type)

GOST

ORDERING INFORMATION

Example: 88 series multi-function timer, 2 CO contact 8 A, with (24...230) V AC (50/60) Hz and (24...230) V DC supply.

8 8 . 0 2 . 0 . 2 3 0 . 0 0 0 1

Series

Type

0 = Functions AI, SW, AE, BE, DE, HI
1 = Functions AI a, AI b, DI a, DI b

No. of poles

2 = 2 pole

Supply version

0 = AC (50/60 Hz)/DC

Special versions

0 = Standard for type 88.12
1 = Standard for type 88.02

Supply voltage

230 = $\begin{cases} 24...230 \text{ V AC} \\ 24...48 \text{ V DC} \end{cases}$ (for type 88.12)

230 = 24...230 V AC/DC (for type 88.02)

TECHNICAL DATA

EMC SPECIFICATIONS

TYPE OF TEST	REFERENCE STANDARD	
ELECTROSTATIC DISCHARGE	- contact discharge	EN 61000-4-2
	- air discharge	EN 61000-4-2
RADIO-FREQUENCY ELECTROMAGNETIC FIELD (80 ÷ 1000 MHz)	EN 61000-4-3	10 V/m
FAST TRANSIENTS (burst) (5-50 ns, 5 kHz) on Supply terminals	EN 61000-4-4	2 kV/5 kV
SURGES (1.2/50 µs) on Supply terminals	- common mode	EN 61000-4-5
	- differential mode	EN 61000-4-5
RADIO-FREQUENCY COMMON MODE (0.15 ÷ 80 MHz) on Supply terminals	EN 61000-4-6	3 V

TIME SCALES

END SCALE

	s	min	h	x10 h
0.5	0.5 s	0.5 min	0.5 h	5 h
1	1 s	1 min	1 h	10 h
5	5 s	5 min	5 h	50 h
10	10 s	10 min	10 h	100 h

NOTE: time scales and functions must be set before energising the timer.

TIME SCALES AND FUNCTIONS SELECTION

		88.02	88.12
E	Function selector	AE, AI, BE, DE, HI, SW	AI a, AI b, DI a, DI b
D	Time scale selector	0.5, 1, 5, 10	0.5, 1, 5, 10
H	Unit of time selector	s, min, h, 10h	s, min, h, 10h

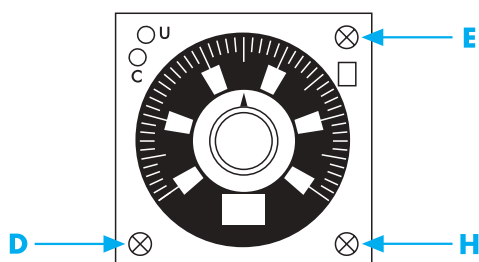

FUNCTIONS

U = Supply Voltage
S = Signal switch
C = Output Contact

Without signal Start= Start via contact in supply line (A1).
 With signal Start = Start via contact into control terminal (6/21).

Wiring diagram

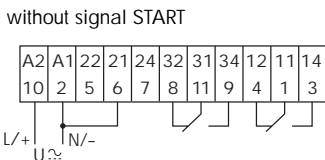
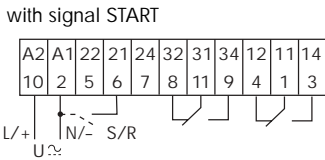
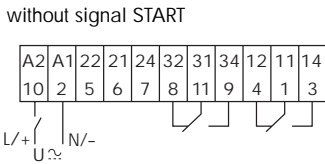

Type 88.02

	<p>(AI) ON delay. Apply power to timer. Output contacts transfer after preset time has elapsed. Reset occurs when power is removed.</p>
	<p>(SW) Symmetrical recycler: ON start. Apply power to timer. Output contacts transfer immediately and cycle between ON and OFF for as long as power is applied. The ratio is 1:1 (time on = time off).</p>
	<p>(AE) ON delay. When power is applied, the timer will function as an ON delay except when the Signal Switch (S) is closed which will force the output and the timing process into the reset condition.</p>
	<p>(BE) Signal OFF delay. Power is permanently applied to the timer. The output contacts transfer immediately on closure of the Signal Switch (S). Opening the Signal Switch initiates the preset delay, after which time the output contacts reset.</p>
	<p>(DE) Signal ON pulse. Power is permanently applied to the timer. On momentary or maintained closure of Signal Switch (S), the output contacts transfer, and remain so for the duration of the preset delay, after which they reset.</p>
	<p>(HI) ON pulse. Apply power to timer. Output contacts transfer immediately After preset time has elapsed, contacts reset.</p> <p>N.B. Ensure a fixed connection between Terminals 2 and 6.</p>

Type 88.12

	<p>(AI a) ON Delay (2 timed contacts). Apply power to timer. Contacts (C₁ and C₂) transfer after preset time has elapsed. Reset occurs when power is removed.</p>
	<p>(AI b) ON Delay (1 timed contact + 1 instantaneous contact). Apply power to timer. Output contact (C₁) transfers immediately. Contact (C₂) transfers after the preset time has elapsed. Reset occurs when power is removed.</p>
	<p>(DI a) ON pulse (2 timed contacts). Apply power to timer. Output contacts (C₁ and C₂) transfer immediately. After preset time has elapsed, the contacts reset.</p>
	<p>(DI b) ON pulse (1 timed contact + 1 instantaneous contact). Apply power to timer. Output contacts (C₁ and C₂) transfer immediately. After preset time has elapsed, the contact (C₂) resets. Contact (C₁) resets when power is removed.</p>



90.21

Approvals
(according to type):



- RATED VALUES: 10 A - 250 V
- DIELECTRIC STRENGTH: ≥ 2 kV AC
- PROTECTION CATEGORY: IP 20
- AMBIENT TEMPERATURE: (-40...+70)°C
- TORQUE: 0.5 Nm
- WIRE STRIP LENGTH: 10 mm
- MAX WIRE SIZE:

	solid wire	stranded wire
mm ²	1x6 / 2x2.5	1x6 / 2x2.5
AWG	1x10 / 2x14	1x10 / 2x14

Timer type	88.12		88.02	
Colour	BLUE	BLACK	BLUE	BLACK
Clamp terminal socket: panel or 35 mm rail (EN 50022) mount	90.20	90.20.0	90.21	90.21.0

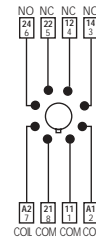
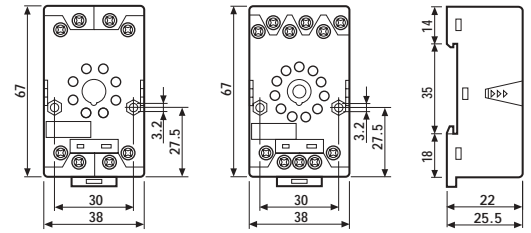

90.20

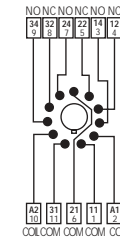

90.21



90.26

Approvals
(according to type):



- RATED VALUES: 10 A - 250 V
- DIELECTRIC STRENGTH: ≥ 2 kV AC
- PROTECTION CATEGORY: IP 20
- AMBIENT TEMPERATURE: (-40...+70)°C
- TORQUE: 0.8 Nm
- WIRE STRIP LENGTH: 11 mm
- MAX WIRE SIZE:

	solid wire	stranded wire
mm ²	1x4 / 2x2.5	1x4 / 2x2.5
AWG	1x12 / 2x14	1x12 / 2x14

Timer type	88.12		88.02	
Colour	BLUE	BLACK	BLUE	BLACK
Screw terminal socket: panel or 35 mm rail (EN 50022) mount	90.26	90.26.0	90.27	90.27.0

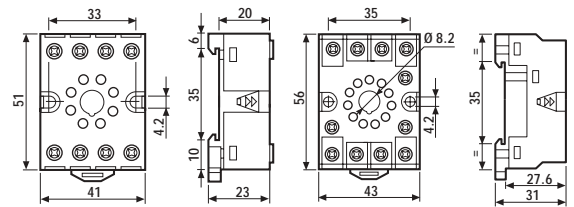

90.26

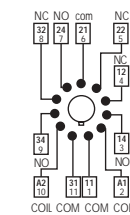

90.27



90.13.4

Approvals
(according to type):



- RATED VALUES: 10 A - 250 V
- DIELECTRIC STRENGTH: ≥ 2 kV AC
- AMBIENT TEMPERATURE: (-40...+70)°C



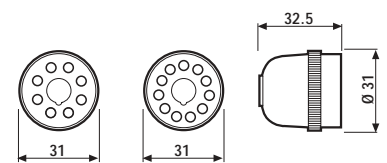



Timer type	88.12		88.02	
Colour	BLUE	BLACK	BLUE	BLACK
Sockets 8-11 pin backwired with solder terminals	—	90.12.4	—	90.13.4

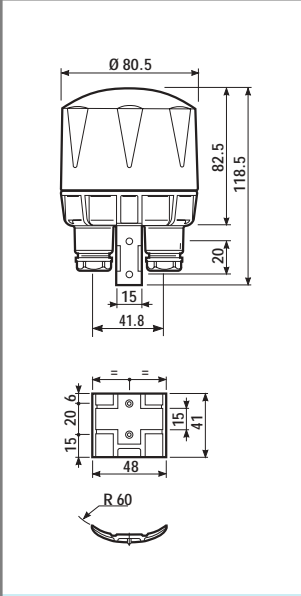
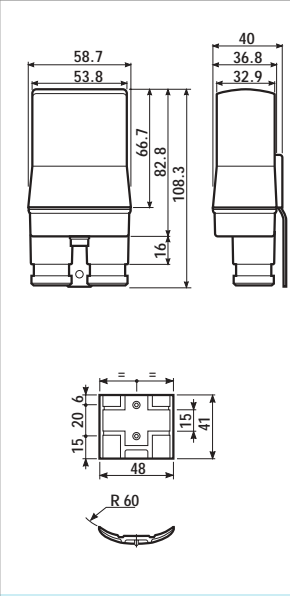

90.12.4

90.13.4

- A range of light dependent relays with 1 or 2 NO contacts
- Pole or flange mounting
- Double break (phase + neutral) type available (type 10.32)
- Sensitivity adjustment from 1 to 150 lux

	10.32	10.41
		
	- 2 NO, 16 A - Pole mount	- 1 NO, 12 A - Pole mount
		
Contact specifications		
Contact configuration	2 NO	1 NO
Rated current/Max. peak current A	16/30 (100 A · 5 ms)	12/25 (100 A · 5 ms)
Rated voltage/Max. switching voltage V AC	230/—	230/—
Rated load in AC1 VA	3,700	2,800
Rated load in AC15 (230 VAC) VA	700	600
Nominal lamp rating: incandescent (230V) W	2,000	1,200
compensated fluorescent (230V) W	750	420
uncompensated fluorescent (230V) W	1,000	600
halogen (230V) W	2,000	1,200
Minimum switching load mW(V/mA)	1,000 (10/10)	1,000 (10/10)
Standard contact material	AgSnO ₂	AgSnO ₂
Supply specifications		
Nominal voltage V AC (50/60Hz)	230	230
V DC	—	—
Rated power AC/DC VA (50Hz)/W	2.5/—	2/—
Operating range AC (50Hz)	(0.85...1.1)U _N	(0.8...1.1)U _N
DC	—	—
Technical data		
Electrical life at rated load in AC1 cycles	100 · 10 ³	100 · 10 ³
Threshold setting lx	1...80 (switching ON)	1...80 (switching ON)
lx	2...150 (switching OFF)	2...150 (switching OFF)
Delay time: switching ON/OFF s	6/25	15/25
Ambient temperature range °C	-30...+70	-30...+70
Protection category	IP 54	IP 54
Approvals: (according to type)	  	

10

ORDERING INFORMATION

Example: a 10 series light dependent relay with 1 NO - 12 A contact and screw terminal connections, with 230 V AC supply.

1 0 . 4 1 . 8 . 2 3 0 . 0 0 0 0

Series _____

Type _____
 3 = Pole mount - 2 NO
 4 = Pole mount - 1 NO

No. of poles _____
 1 = Single phase switch 1 NO, 12 A
 2 = Double phase switch 2 NO, 16 A

Supply voltage
 230 = 230 V

Supply version
 8 = AC (50/60 Hz)

TECHNICAL DATA

INSULATION		10.32		10.41	
DIELECTRIC STRENGTH - between open contacts	V AC	1,000		1,000	
OTHER DATA		10.32		10.41	
CABLE GRIP	Ø mm	(8.9...13)		(8.9...13)	
PRESET THRESHOLD	lx	5 switch ON / 20 switch OFF		3 switch ON / 8 switch OFF	
MAX WIRE SIZE		solid cable	stranded cable	solid cable	stranded cable
	mm ²	1x6 / 2x4	1x6 / 2x2.5	1x6 / 2x4	1x6 / 2x2.5
	AWG	1x10 / 2x12	1x10 / 2x14	1x10 / 2x12	1x10 / 2x14
SCREW TORQUE	Nm	1.2		1.2	

WIRING DIAGRAMS

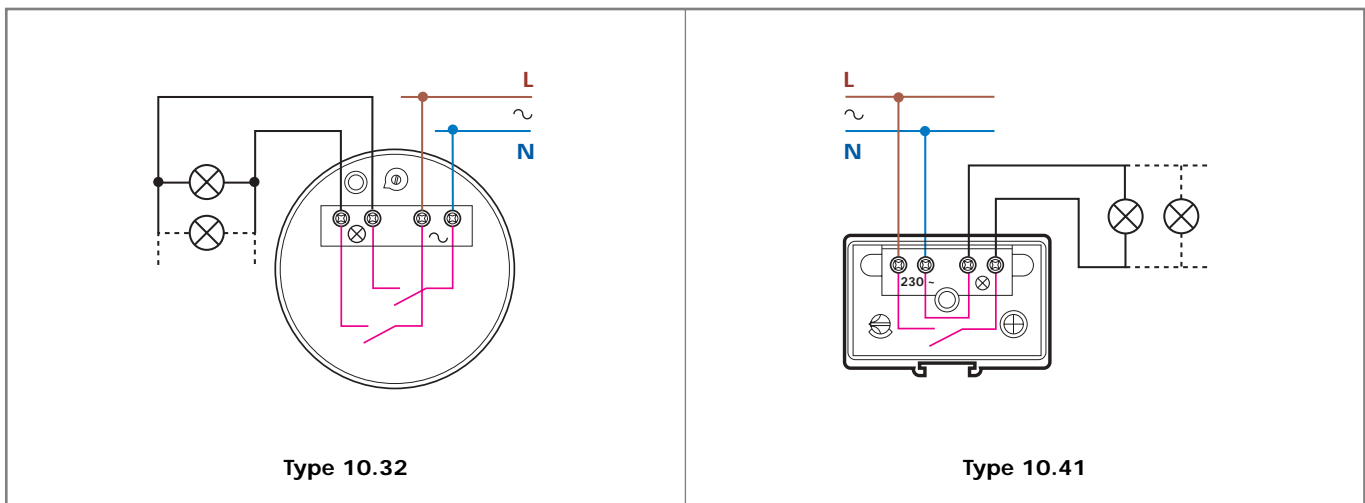

- Type 11.01 is suitable for use on staircases and in entrance halls.
- **Selector with 3 positions:**
 - **high range** (threshold setting 20...1000lx)
 - **low range** (threshold setting 1...30lx)
 - **continuous light** (particularly interesting for the Test at the first installation).
- Type 11.71: with 1 CO contact and with 12...24 VAC/DC voltage supply.
- SELV separation between contact and supply circuit.
- Supplied with separate sensitive photocell.
- LED indication.
- 35 mm rail (EN 50022) mount.

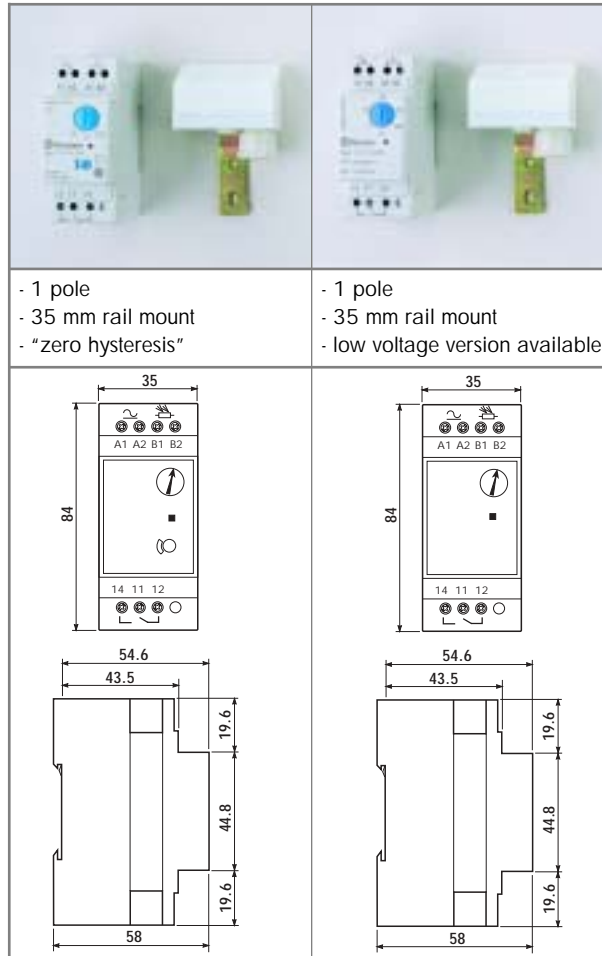
11.01
11.71

- | | |
|---|---|
| <ul style="list-style-type: none"> - 1 pole - 35 mm rail mount - "zero hysteresis" | <ul style="list-style-type: none"> - 1 pole - 35 mm rail mount - low voltage version available |
|---|---|

Contact specifications		11.01	11.71
Contact configuration		1 CO	1 CO
Rated current/Max. peak current	A	16/30 (100 A - 5 ms)	16/30 (100 A - 5 ms)
Rated voltage/Max. switching voltage	V AC	250/400	250/400
Rated load in AC1	VA	4,000	4,000
Rated load in AC15 (230 VAC)	VA	750	750
Nominal lamp rating:			
incandescent (230V)	W	2,000 (NO contact)	2,000 (NO contact)
compensated fluorescent (230V)	W	550 (NO contact)	550 (NO contact)
uncompensated fluorescent (230V)	W	1,000 (NO contact)	1,000 (NO contact)
halogen (230V)	W	2,000 (NO contact)	2,000 (NO contact)
Minimum switching load	mW(V/mA)	1,000 (10/10)	1,000 (10/10)
Standard contact material		AgSnO ₂	AgSnO ₂
Supply specifications		11.01	11.71
Nominal voltage	V DC/AC (50/60Hz)	—	12...24
	V AC (50/60Hz)	230	110...125 230...240
Rated power AC/DC	VA (50Hz)/W	2/—	1.3/0.8
Operating range	DC/AC (50Hz)	—	(9.6...33.6) V
	AC (50Hz)	(0.8...1.1)U _N	(88...137) V (184...264) V
Technical data		11.01	11.71
Electrical life at rated load in AC1	cycles	100 · 10 ³	100 · 10 ³
Threshold setting	lx	1...30 (low range)	1...100 (switching ON)
	lx	20...1,000 (high range)	2...150 (switching OFF)
Delay time: switching ON/OFF	s	15/25	15/25
Ambient temperature range	°C	-20...+50	-20...+60
Protection category: light dependent relay/photocell		IP 20/IP 54	IP 20/IP 54
Approvals: (according to type)			

ORDERING INFORMATION

Example: a 11 series light dependent relay "zero hysteresis" with 1 CO - 16 A contact and 35 mm rail mounting, with 230 V AC supply.

1 1 . 0 1 . 8 . 2 3 0 . 0 0 0 0

Series

Type

0 = 35 mm rail (EN 50022) mounting, "zero hysteresis"
7 = 35 mm rail (EN 50022) mounting

No. of poles

1 = 1 pole

Supply voltage

024 = 12...24 V AC/DC for 11.71 only
125 = 110...125 V AC for 11.71 only
230 = 230...240 V AC for 11.71 only
230 = 230 V AC for 11.01 only

Supply version

0 = AC (50/60 Hz)/DC for 11.71.0.024 only
8 = AC (50/60 Hz)

TECHNICAL DATA

INSULATION

11.01

11.71

DIELECTRIC STRENGTH		
- between supply and contacts V AC	4,000	4,000
- between open contacts V AC	1,000	1,000

OTHER DATA

11.01

11.71

CABLE GRIP of SENSITIVE PHOTOCELL Ø mm	(7.5...9)		(7.5...9)		
CABLE LENGTH	m	50 (2x1.5mm ²)			
PRESET THRESHOLD	lx	10	100		
POWER LOST TO THE ENVIRONMENT					
- without contact current	W	1.3	0.8		
- with rated current	W	3.1	2		
MAX WIRE SIZE		solid cable	stranded cable	solid cable	stranded cable
	mm ²	1x6 / 2x4	1x6 / 2x2.5	1x6 / 2x4	1x6 / 2x2.5
	AWG	1x10 / 2x12	1x10 / 2x14	1x10 / 2x12	1x10 / 2x14
SCREW TORQUE	Nm	0.8		0.8	

WIRING DIAGRAMS

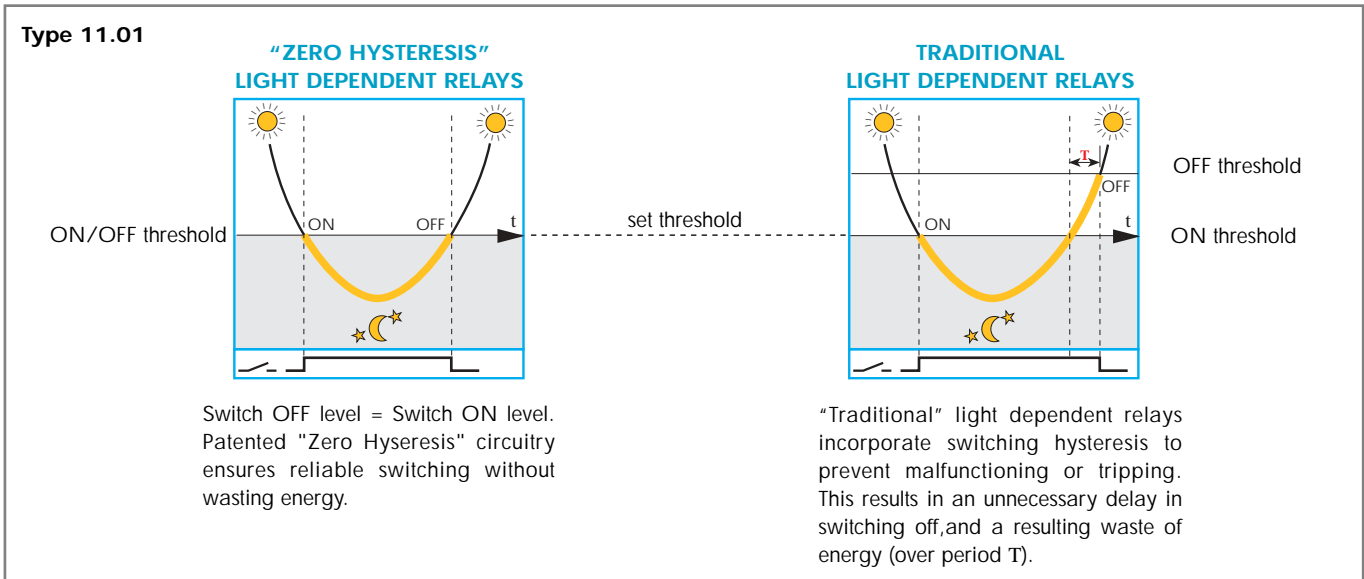
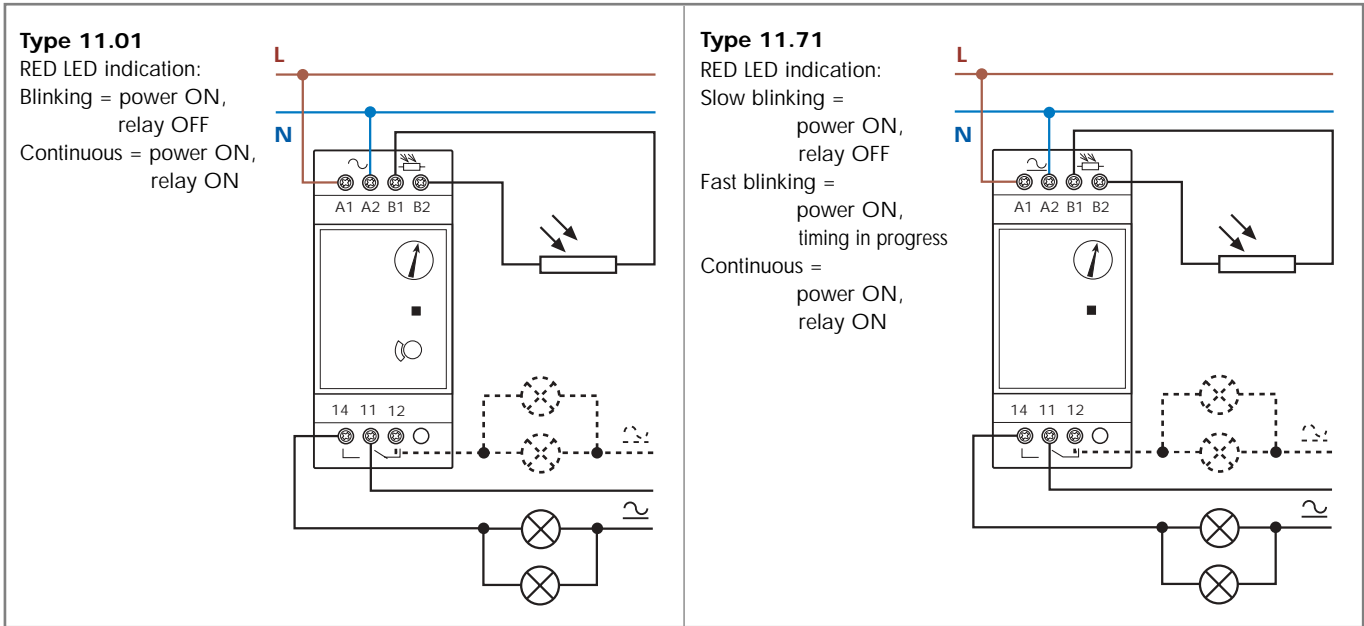

ACCESSORIES

11

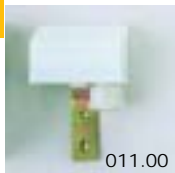

Sensitive photocell (supplied with light dependent relay)	011.00
---	--------

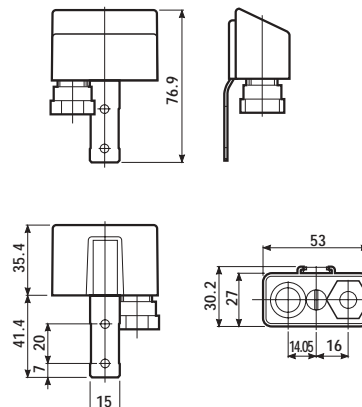

011.00

- Types available:
- type 12.01 - mechanical daily time switch
- type 12.21/22/71 - digital weekly time switch
- 17.5 mm wide (type 12.71)
- 35 mm rail (EN 50022) mount
- Internal battery for the set up without supply (types 12.21/22/71)
- Impulse function (1...59s) (types 12.21/22/71)
- Automatically adjusts for daylight saving (types 12.21/22/71)

	12.01	12.21	12.22
	- mechanical daily time switch - 1 CO - 35 mm rail mount	- digital weekly time switch - 1 CO - 35 mm rail mount	- digital weekly time switch - 2 CO - 35 mm rail mount
Contact specifications			
Contact configuration	1 CO	1 CO	2 CO
Rated current/Max. peak current	A 16/—	A 16/30	A 16/30
Rated voltage/Max. switching voltage	V AC 250/—	V AC 250/—	V AC 250/—
Rated load in AC1	VA 4,000	VA 4,000	VA 4,000
Rated load in AC15 (230 VAC)	VA 750	VA 750	VA 750
Nominal lamp rating:			
incandescent (230V)	W 2,000 (NO contact)	W 2,000 (NO contact)	W 2,000 (NO contact)
compensated fluorescent (230V)	W 750 (NO contact)	W 420 (NO contact)	W 420 (NO contact)
uncompensated fluorescent (230V)	W 1,000 (NO contact)	W 1,000 (NO contact)	W 1,000 (NO contact)
halogen (230V)	W 2,000 (NO contact)	W 2,000 (NO contact)	W 2,000 (NO contact)
Minimum switching load	mW(V/mA) 1,000 (10/10)	mW(V/mA) 1,000 (10/10)	mW(V/mA) 1,000 (10/10)
Standard contact material	AgCdO	AgCdO	AgCdO
Supply specifications			
Nominal voltage	V AC (50/60Hz) 230	V AC (50/60Hz) 24 230	V AC (50/60Hz) 230
	V DC —	V DC 24 —	V DC —
Rated power AC/DC	VA (50Hz)/W 2/—	VA (50Hz)/W 1.4/1.4 2/—	VA (50Hz)/W 2/—
Operating range	AC (50Hz) (0.85...1.1)U _N	AC (50Hz) (0.9...1.1)U _N (0.85...1.1)U _N	AC (50Hz) (0.85...1.1)U _N
	DC —	DC (0.9...1.1)U _N —	DC —
Technical data			
Electrical life at rated load in AC1	cycles 50 · 10 ³	cycles 50 · 10 ³	cycles 50 · 10 ³
Type of time switch	daily	weekly	weekly
Programs	48 switching point	30	30
Minimum interval setting	min 30	min 1	min 1
Accuracy	s/day 1.5	s/day 1.5	s/day 1.5
Ambient temperature range	°C -5...+55	°C -10...+55 -5...+55	°C -5...+55
Protection category	IP 20	IP 20	IP 20
Approvals: (according to type)		GOST	

12.71

- Types available:
 - type 12.01 - mechanical daily time switch
 - type 12.21/22/71 - digital weekly time switch
- 17.5 mm wide (type 12.71)
- 35 mm rail (EN 50022) mount
- Internal battery for the set up without supply (types 12.21/22/71)
- Impulse function (1...59s) (types 12.21/22/71)
- Automatically adjusts for daylight saving (type 12.21/22/71)



- digital weekly time switch
- 1 CO
- 35 mm rail mount

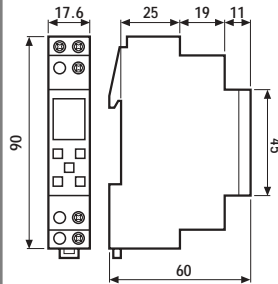
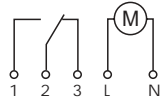

Contact specifications		
Contact configuration		1 CO
Rated current/Max. peak current	A	16/30
Rated voltage/Max. switching voltage	V AC	250/—
Rated load in AC1	VA	4,000
Rated load in AC15 (230 VAC)	VA	420
Nominal lamp rating:		
incandescent (230V)	W	2,000 (NO contact)
compensated fluorescent (230V)	W	750 (NO contact)
uncompensated fluorescent (230V)	W	1,000 (NO contact)
halogen (230V)	W	2,000 (NO contact)
Minimum switching load	mW(V/mA)	1,000 (10/10)
Standard contact material		AgCdO
Supply specifications		
Nominal voltage	V AC (50/60Hz)	230
	V DC	—
Rated power AC/DC	VA (50Hz)/W	2/—
Operating range	AC (50Hz)	(0.85...1.1)U _N
	DC	
Technical data		
Electrical life at rated load in AC1	cycles	50 · 10 ³
Type of time switch		weekly
Programs		30
Minimum interval setting	min	1
Accuracy	s/day	1.5
Ambient temperature range	°C	-10...+55
Protection category		IP 20
Approvals: (according to type)		CE GOST

ORDERING INFORMATION

Example: a 12 series, mechanical daily time switch, 1 CO - 16 A, supply voltage 230 V AC.

1 2 . 0 1 . 8 . 2 3 0 . 0 0 0 0

Series	1 2	Supply voltage	024 = 24 V AC/DC 230 = 230 V
Type	0 = Daily 2 = Weekly, 35.8 mm wide 7 = Weekly, 17.5 mm wide	Supply version	0 = AC (50/60 Hz)/DC (for 12.21.0.024 only) 8 = AC (50/60 Hz)
No. of poles	1 = 1 CO, 16 A 2 = 2 CO, 16 A (for 12.22 only)		

TECHNICAL DATA

INSULATION		12.01	12.21/12.22/12.71		
DIELECTRIC STRENGTH - between open contacts	V	1,000	1,000		
OTHER DATA		12.01	12.21/12.22/12.71		
POWER BACK-UP		70 h after 80 h uninterrupted supply	6 years after the first operation		
POWER LOST TO THE ENVIRONMENT - without contact current	W	1.5	2		
	W	2.5	3 (1 CO)	4 (2 CO)	
MAX WIRE SIZE		solid cable	stranded cable	solid cable	stranded cable
	mm ²	1x6 / 2x4	1x6 / 2x2.5	1x6 / 2x4	1x6 / 2x2.5
	AWG	1x10 / 2x12	1x10 / 2x14	1x10 / 2x12	1x10 / 2x14
SCREW TORQUE	Nm	1.2	1.2		

WIRING DIAGRAMS

Type 12.01
SELECTOR SWITCH:
Permanently OFF (⊖)
Automatic (AUTO)
Permanently ON (I)

Type 12.21
12.22

Type 12.71

ORDERING INFORMATION

Example: a 13 series, electronic step or monostable relay, 35 mm rail mount and 1 NO - 16 A contact, with 230 V AC supply.

1 3 . 0 1 . 8 . 2 3 0 . 0 0 0 0

Series

Type

0 = 35 mm rail (EN 50022) mount
7 = Panel mount

No. of poles

1 = Single phase switch 1 NO

Supply voltage

012 = 12 V AC/DC
024 = 24 V AC/DC
125 = 110...125 V AC
230 = 230...240 V AC (13.71 only)
230 = 230 VAC (13.71 only)

Supply version

0 = AC (50/60 Hz)/DC (for 13.01.0.012 and 13.01.0.024 only)
8 = AC (50/60 Hz)

TECHNICAL DATA

INSULATION

13.01.8

13.01.0

13.71

DIELECTRIC STRENGTH	13.01.8	13.01.0	13.71
- between control circuit and supply V AC	4,000	—	—
- between control circuit and contacts V AC	4,000	4,000	—
- between supply and contacts V AC	4,000	4,000	—
- between open contacts V AC	1,000	1,000	1,000

OTHER DATA

13.01

13.71

POWER LOST TO THE ENVIRONMENT	13.01		13.71		
- without contact current W	2.2		0.5		
- with rated current W	3.5		2.9		
MAX WIRE SIZE	solid cable		stranded cable		
	mm ²	1x6 / 2x4	1x6 / 2x2.5	1x4 / 2x2.5	1x2.5 / 2x2.5
	AWG	1x10 / 2x12	1x10 / 2x14	1x12 / 2x14	1x14 / 2x14
SCREW TORQUE	Nm	0.8	0.8		

WIRING DIAGRAMS

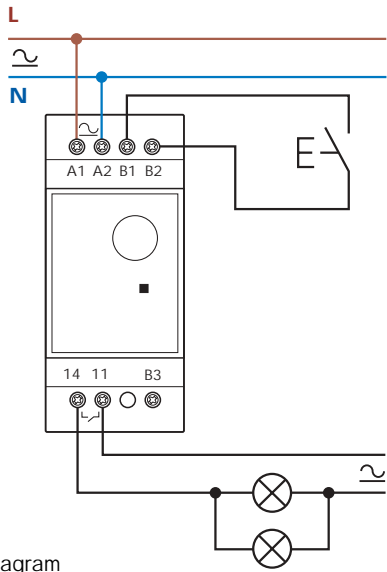

Type 13.01
Bistable (step) wiring diagram

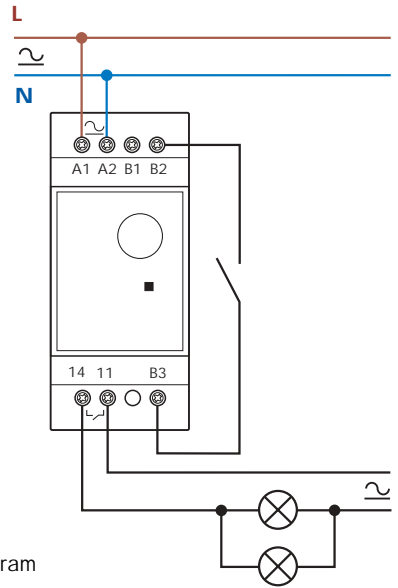

Type 13.01
Monostable wiring diagram

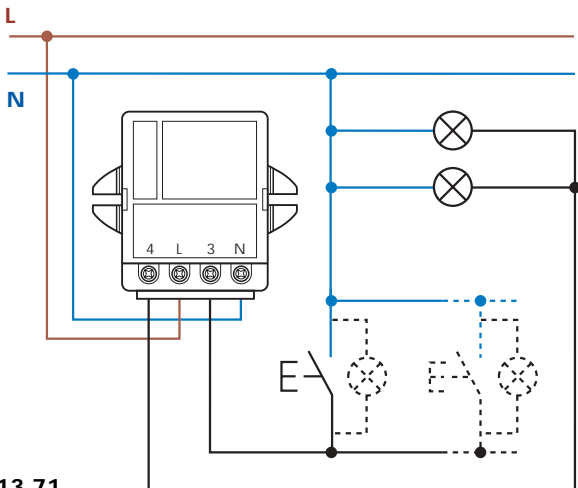

Type 13.71
3 wire connection
Max 15 (\leq 1 mA)
illuminated push buttons

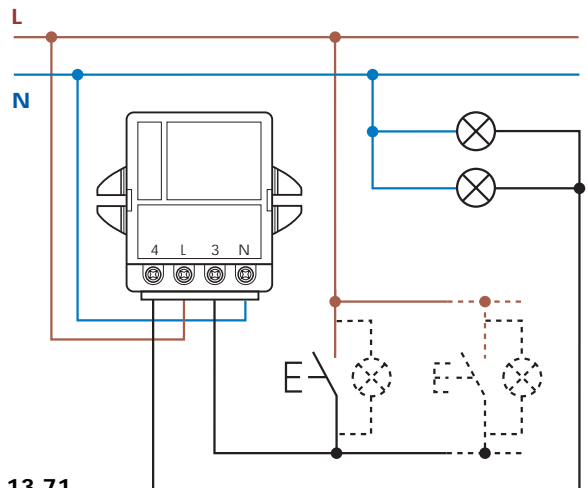

Type 13.71
4 wire connection
Max 15 (\leq 1 mA)
illuminated push buttons

- One module (17.4 mm) wide
- Time range from 30 s to 20 min
- Can be used with illuminated push - buttons
- Suitable for 3 or 4 wiring systems
- LED indicators
- 35 mm rail (EN 50022) mount

14.01

14.71



- Multi-function
- 1 NO
- 35 mm rail mount

- For 3 or 4 wiring system
- 1 NO
- 35 mm rail mount

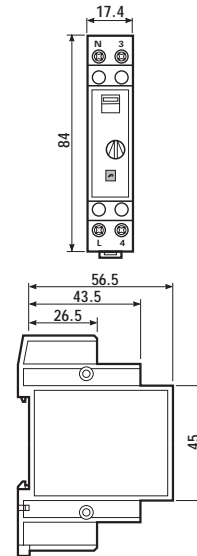
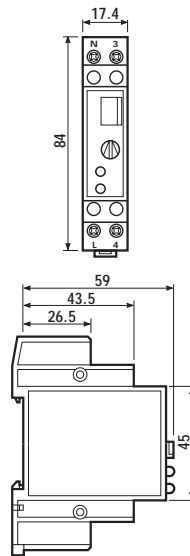

Contact specifications			
Contact configuration		1 NO	1 NO
Rated current/Max. peak current	A	16/30 (100 A · 5 ms)	16/30 (100 A · 5 ms)
Rated voltage/Max. switching voltage	V AC	230/—	230/—
Rated load in AC1	VA	3,700	3,700
Rated load in AC15 (230 VAC)	VA	750	750
Nominal lamp rating:			
incandescent (230V)	W	2,000	2,000
compensated fluorescent (230V)	W	750	750
uncompensated fluorescent (230V)	W	1,000	1,000
halogen (230V)	W	2,000	2,000
Minimum switching load	mW(V/mA)	1,000 (10/10)	1,000 (10/10)
Standard contact material		AgSnO ₂	AgSnO ₂
Supply specifications			
Nominal voltage	V AC (50/60Hz)	230	230
	V DC	—	—
Rated power AC/DC	VA (50Hz)/W	2/—	1.5/—
Operating range	AC (50Hz)	(0.8...1.1)U _N	(0.8...1.1)U _N
	DC	—	—
Technical data			
Electrical life at rated load in AC1	cycles	100 · 10 ³	100 · 10 ³
Delay setting	min	0.5...20	0.5...20
Max no. of illuminated push-button (≤1mA)		15	30
Maximum impulse duration		continuous	continuous
Ambient temperature range	°C	-10...+50	-10...+60
Protection category		IP 20	IP 20
Approvals: (according to type)			

ORDERING INFORMATION

Example: a 14 series single module relay with a single phase switch 1 NO - 16 A contact, with supply rated at 230 V AC.

1 4 . 0 1 . 8 . 2 3 0 . 0 0 0 0

Series

Type

0 = 35 mm rail (EN 50022) mount, multi-function
7 = 35 mm rail (EN 50022) mount

No. of poles

1 = Single phase switch, 16 A

Supply voltage

230 = 230 V

Supply version

8 = AC (50/60 Hz)

TECHNICAL DATA

INSULATION

14.01

14.71

DIELECTRIC STRENGTH				
- between open contacts	V AC	1,000		1,000

OTHER DATA

14.01

14.71

POWER LOST TO THE ENVIRONMENT					
- without contact current	W	1.3		1	
- with rated current	W	3.3		3.3	
MAX WIRE SIZE		solid cable	stranded cable	solid cable	stranded cable
	mm ²	1x6 / 2x4	1x4 / 2x2.5	1x6 / 2x4	1x4 / 2x2.5
	AWG	1x10 / 2x12	1x12 / 2x14	1x10 / 2x12	1x12 / 2x14
SCREW TORQUE	Nm	0.8		0.8	

WIRING DIAGRAMS

Type 14.01

LED indication:
red = relay ON
green = power ON

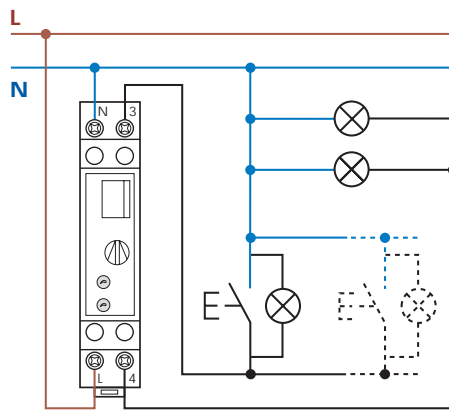

3 wire connection

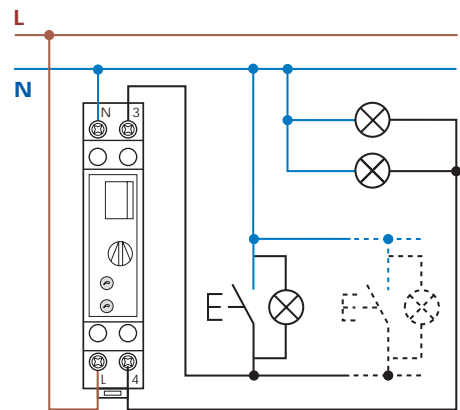

4 wire connection

Type 14.71

LED indication:
red = relay ON

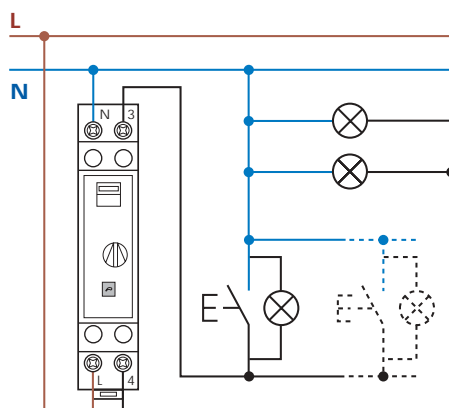

3 wire connection

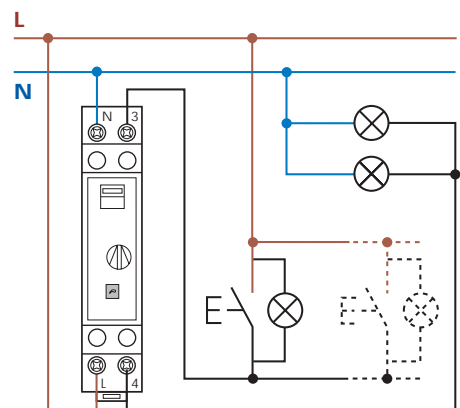

4 wire connection

FUNCTIONS

Type 14.01.8.230 The following functions are selected by means of a DIP SWITCH:

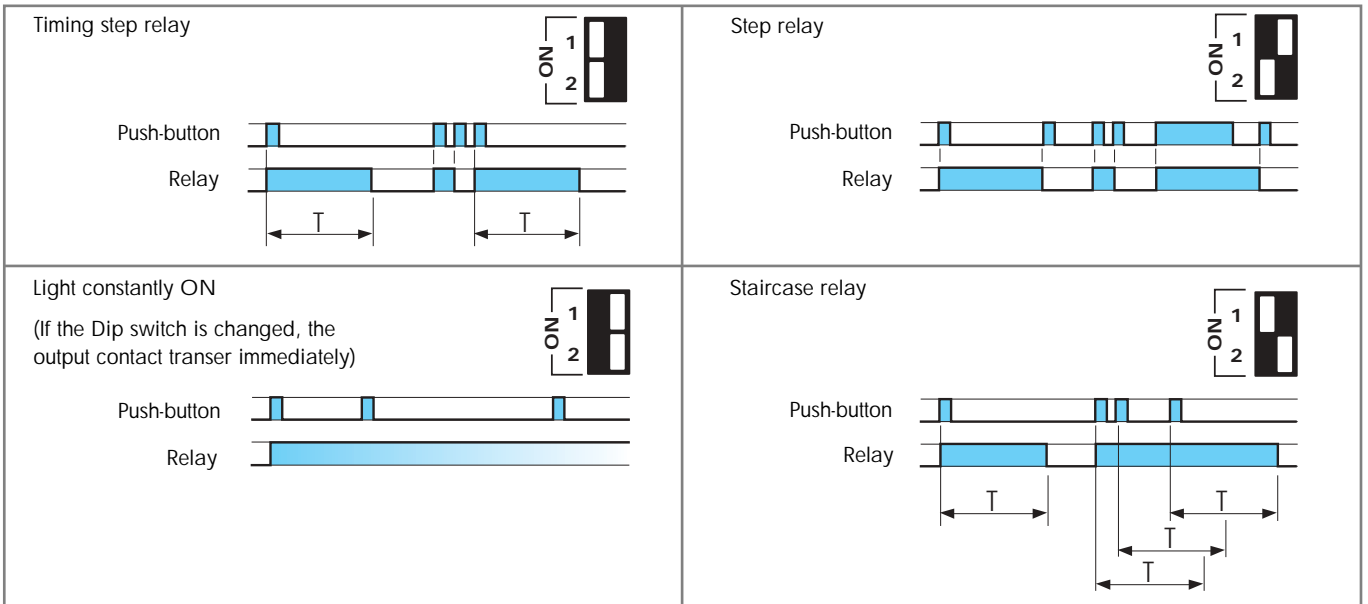

Type 14.71.8.230 The following functions are selected by means of a SELECTOR SWITCH:

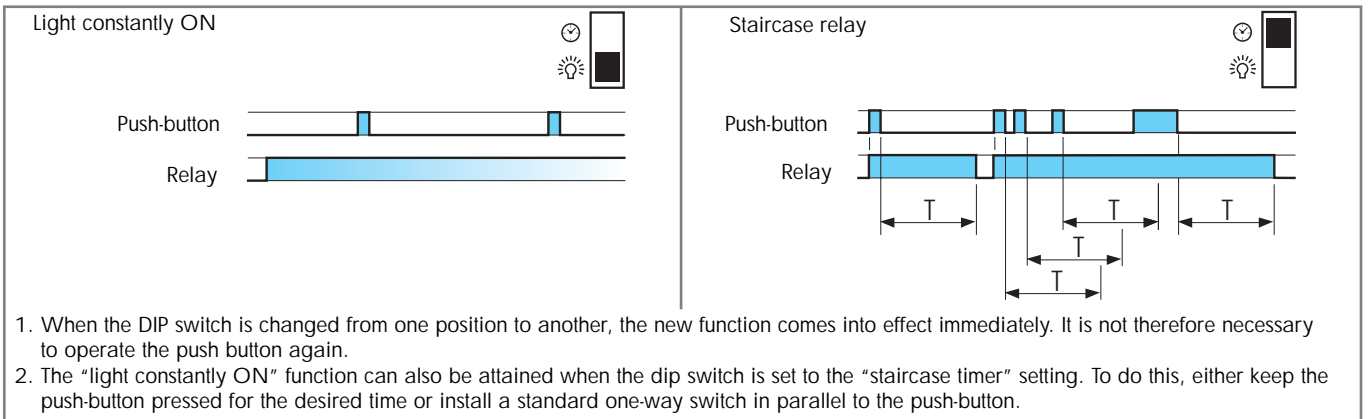

- One module (17.4mm) wide
- Test button with mechanical indicators
- 6 functions available
- AC and DC coils
- Identification label
- Possible to connect illuminated push buttons
- 35 mm rail (EN 50022) mount

	20.21	20.22, 24, 26, 28	20.23
	- Single phase switch 1 NO - 35 mm rail mount	- Double phase switch - 35 mm rail mount	- Double phase switch 1 NC + 1 NO - 35 mm rail mount
Contact specifications			
Number of contacts	1 NO	2 NO	1 NC + 1 NO
Rated current/Max. peak current	A 16/30	A 16/30	A 16/30
Rated voltage/Max. switching voltage	V AC 250/400	V AC 250/400	V AC 250/400
Rated load in AC1	VA 4,000	VA 4,000	VA 4,000
Rated load in AC15 (230 VAC)	VA 750	VA 750	VA 750
Nominal lamp rating:			
incandescent (230V)	W 2,000	W 2,000	W 2,000
compensated fluorescent (230V)	W 750	W 750	W 750
uncompensated fluorescent (230V)	W 1,000	W 1,000	W 1,000
halogen (230V)	W 2,000	W 2,000	W 2,000
Minimum switching load	mW(V/mA) 1,000 (10/10)	mW(V/mA) 1,000 (10/10)	mW(V/mA) 1,000 (10/10)
Standard contact material	AgNi	AgNi	AgNi
Coil specifications			
Nominal voltage	V AC (50/60Hz)	8 - 12 - 24 - 48 - 110 - 120 - 230 - 240	
	V DC	12 - 24 - 48 - 110	12 - 24 - 48 - 110
Rated power AC/DC	VA (50Hz)/W	6.5/5	6.5/5
Operating range	AC	(0.85...1.1)U _N (50Hz)/(0.9...1.1)U _N (60Hz)	
	V DC	(0.9...1.1)U _N	(0.9...1.1)U _N
Technical data			
Mechanical life	cycles	300 · 10 ³	300 · 10 ³
Electrical life at rated load in AC1	cycles	100 · 10 ³	100 · 10 ³
Minimum/Maximum impulse duration		0.1s/1h (according to EN60669)	0.1s/1h (according to EN60669)
Insulation between coil and contacts (1.2/50µs)	kV	4	4
Ambient temperature range	°C	-40...+40	-40...+40
Protection category		IP 20	IP 20
Approvals: (according to type)			

ORDERING INFORMATION

Example: a 20 series 35 mm rail (EN 50022) mount relay with double phase switch, 2 NO - 16 A contacts, coil rated at 12 V DC and with AgSnO₂ contacts.

2 0 . 2 2 . 9 . 0 1 2 . 4 0 0 0

Series

Type

2 = 35 mm rail (EN 50022) mount

No. of poles

1 = Single phase switch 1 NO

2 = Double phase switch 2 NO

3 = Double phase switch 1 NC + 1 NO

4 = 4 sequence double phase switch 2 NO

6 = 3 sequence double phase switch 2 NO

8 = 4 sequence double phase switch 2 NO

Contact material

0 = AgNi standard

4 = AgSnO₂

Coil voltage

see coil specifications

Coil version

8 = AC (50/60 Hz)

9 = DC

TECHNICAL DATA

INSULATION

DIELECTRIC STRENGTH		
- between supply and contacts	V AC	3,500
- between open contacts	V AC	2,000
- between adjacent contacts	V AC	2,000

OTHER DATA

[20.21](#), [20.23](#), [20.28](#)

[20.22](#), [20.24](#), [20.26](#)

POWER LOST TO THE ENVIRONMENT		COIL CLAMPS		CONTACT CLAMPS	
- with rated current	W	1.3		2.6	
MAX WIRE SIZE	mm ²	solid cable	stranded cable	solid cable	stranded cable
		1x4 / 2x2.5	1x2.5 / 2x2.5	1x6 / 2x4	1x4 / 2x2.5
		AWG	1x12 / 2x14	1x14 / 2x14	1x10 / 2x12
SCREW TORQUE	Nm	0.8		0.8	

If the coil is operated for a prolonged period of time, adequate ventilation of the relays must be provided, for example leaving a gap of about 9mm between relays.

COIL SPECIFICATIONS

AC VERSION DATA

Nominal voltage U _N	Coil code	Operating range		Resistance R	Consumption I at U _N (50Hz)
		U _{min}	U _{max}		
V		V	V	Ω	mA
8	8.008	6.8	8.8	4	800
12	8.012	10.2	13.2	7.5	550
24	8.024	20.4	26.4	27	275
48	8.048	40.8	52.8	106	150
110	8.110	93.5	121	590	64
120	8.120	102	132	680	54
230	8.230	195.5	253	2,500	28
240	8.240	204	264	2,700	27.5

DC VERSION DATA

Nominal voltage U _N	Coil code	Operating range		Resistance R	Consumption I at U _N
		U _{min}	U _{max}		
V		V	V	Ω	mA
12	9.012	10.8	13.2	27	440
24	9.024	21.6	26.4	105	230
48	9.048	43.2	52.8	440	110
110	9.110	99	121	2,330	47

TYPE	Number of steps	SEQUENCES			
		1	2	3	4
20.21	2				
20.22	2				
20.23	2				
20.24	4				
20.26	3				
20.28	4				

WIRING DIAGRAMS

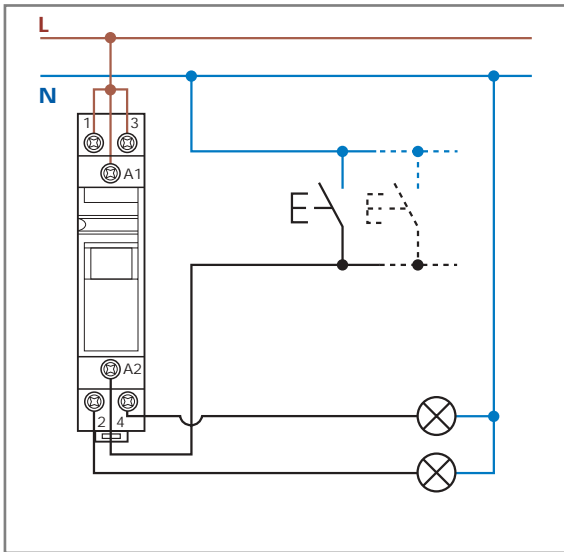

ACCESSORIES

MODULE FOR ILLUMINATED PUSH-BUTTONS

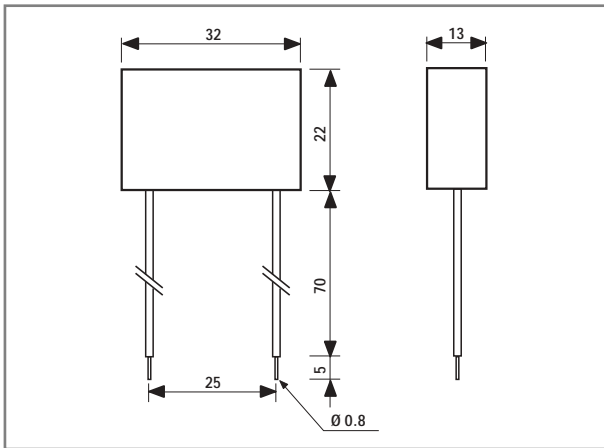

Type 026.00
Sealed version, 7.5 cm insulated and flexible terminals.

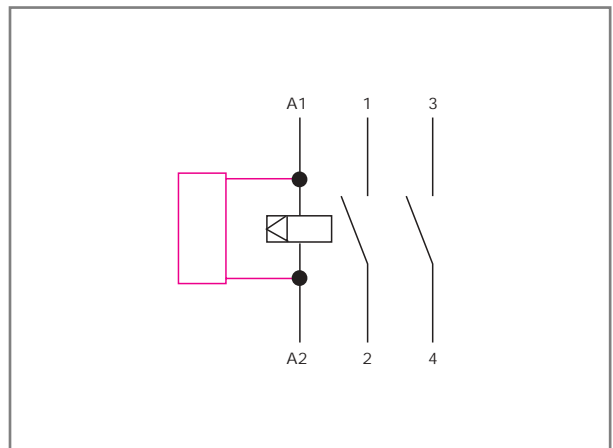

Example of wiring diagram of type 026.00
This module is necessary if using up to a maximum of 15 illuminated pushbuttons (1.5 mA max, 230 V AC) in the switching input circuit. It must be connected in parallel to the coil of the relay (see diagram).

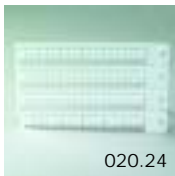

Sheet of marker tags (24 tags): 9x17mm	020.24
--	--------

- One module (17.4mm) wide
- Test button
- Identification label
- AC and DC coils
- 35 mm rail (EN 50022) mount

22.21

22.22



- Single phase switch 1 NO
- 35 mm rail mount

- Double phase switch 2 NO
- 35 mm rail mount

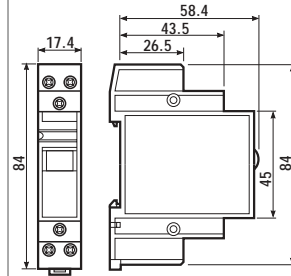
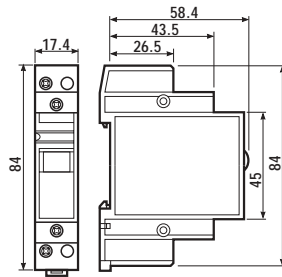
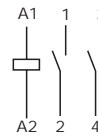

Contact specifications			
Contact configuration		1 NO	2 NO
Rated current/Max. peak current	A	20/30	20/30
Rated voltage/Max. switching voltage	V AC	250/400	250/400
Rated load in AC1	VA	5,000	5,000
Rated load in AC15 (230 VAC)	VA	1,000	1,000
Single phase motor rating (230 VAC)	kW	—	—
Breaking capacity DC1: 30/110/220 V	A	20/0.3/0.12	20/0.3/0.12
Minimum switching load	mW(V/mA)	1,000 (10/10)	1,000 (10/10)
Standard contact material		AgSnO ₂	AgSnO ₂
Coil specifications			
Nominal voltage	V AC (50/60Hz)	8 - 12 - 24 - 48 - 110 - 120 - 230 - 240	
	V DC	12 - 24 - 48 - 110	12 - 24 - 48 - 110
Rated power AC/DC	VA (50Hz)/W	3/1.25	3/1.25
Operating range	AC (50Hz)	(0.85...1.1)U _N	(0.85...1.1)U _N
	DC	(0.9...1.1)U _N	(0.9...1.1)U _N
Technical data			
Mechanical life	cycles	500 · 10 ³	500 · 10 ³
Electrical life at rated load in AC1	cycles	50 · 10 ³	50 · 10 ³
Operate/release time	ms	15/8	15/8
Maximum impulse duration		continuous	continuous
Insulation between coil and contacts (1.2/50µs)	kV	4	4
Ambient temperature range	°C	-40...+40	-40...+40
Protection category		IP 20	IP 20
Approvals: (according to type)		GOST	

- One module (17.4mm) wide
- Test button
- Identification label
- AC and DC coils
- 35 mm rail (EN 50022) mount

22.23

22.24



- Double phase switch
1 NO + 1 NC
- 35 mm rail mount

- Double phase switch 2 NC
- 35 mm rail mount

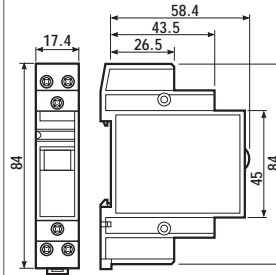
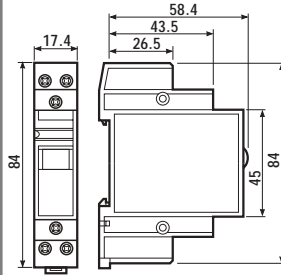
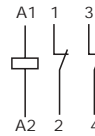
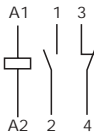

Contact specifications			
Contact configuration		1 NO + 1 NC	2 NC
Rated current/Max. peak current	A	20/30	20/30
Rated voltage/Max. switching voltage	V AC	250/400	250/400
Rated load in AC1	VA	5,000	5,000
Rated load in AC15 (230 VAC)	VA	1,000	1,000
Single phase motor rating (230 VAC)	kW	—	—
Breaking capacity DC1: 30/110/220 V	A	20/0.3/0.12	20/0.3/0.12
Minimum switching load	mW(V/mA)	1,000 (10/10)	1,000 (10/10)
Standard contact material		AgSnO ₂	AgSnO ₂
Coil specifications			
Nominal voltage	V AC (50/60Hz)	8 · 12 · 24 · 48 · 110 · 120 · 230 · 240	
	V DC	12 · 24 · 48 · 110	12 · 24 · 48 · 110
Rated power AC/DC	VA (50Hz)/W	3/1.25	3/1.25
Operating range	AC (50Hz)	(0.85...1.1)U _N	(0.85...1.1)U _N
	DC	(0.9...1.1)U _N	(0.9...1.1)U _N
Technical data			
Mechanical life	cycles	500 · 10 ³	500 · 10 ³
Electrical life at rated load in AC1	cycles	50 · 10 ³	50 · 10 ³
Operate/release time	ms	15/8	15/8
Maximum impulse duration		continuous	continuous
Insulation between coil and contacts (1.2/50μs)	kV	4	4
Ambient temperature range	°C	-40...+40	-40...+40
Protection category		IP 20	IP 20
Approvals: (according to type)		GOST	

ORDERING INFORMATION

Example: a 22 series 35 mm rail mount relay with 1 NO - 20 A contacts, with coil rated at 24 V DC, contact material AgSnO₂.

2 2 . 2 1 . 9 . 0 2 4 . 4 0 0 0

Series	_____	Contact material	4 = AgSnO ₂
Type	_____	Coil voltage	see coil specifications
2 = 35 mm rail (EN 50022) mount		Coil version	8 = AC (50/60 Hz) 9 = DC
No. of poles	_____		
1 = 1 NO			
2 = 2 NO			
3 = 1 NO + 1 NC			
4 = 2 NC			

TECHNICAL DATA

CONTACT SPECIFICATIONS

NOMINAL RATE LAMPS		
- incandescent (230V)	W	1,000
- compensated fluorescent (230V)	W	360

INSULATION

DIELECTRIC STRENGTH		
- between supply and contacts	V AC	3,500
- between open contacts	V AC	2,000
- between adjacent contacts	V AC	2,000

OTHER DATA

BOUNCE TIME: NO/NC	ms	22.21, 22.23	22.22, 22.24
		5/10	5/10
POWER LOST TO THE ENVIRONMENT			
- without contact current	W	1.2	1.2
- with rated current	W	3.2	5.2
MAX WIRE SIZE		COIL CLAMPS	CONTACT CLAMPS
		solid cable	stranded cable
	mm ²	1x4 / 2x2.5	1x2.5 / 2x2.5
	AWG	1x12 / 2x14	1x14 / 2x14
			solid cable
			stranded cable
			1x6 / 2x6
			1x6 / 2x4
SCREW TORQUE	Nm	0.8	0.8

If the coil is operated for a prolonged period of time, adequate ventilation of the relays must be provided, for example leaving a gap of about 9mm between pairs of relays.

COIL SPECIFICATIONS

DC VERSION DATA

Nominal voltage U _N	Coil code	Operating range		Resistance R	Consumption I at U _N
		U _{min}	U _{max}		
V		V	V	Ω	mA
12	9.012	10.8	13.2	115	104.3
24	9.024	21.6	26.4	460	52.2
48	9.048	43.2	52.8	1,850	25.9
110	9.110	99	121	9,700	11.3

AC VERSION DATA

Nominal voltage U _N	Coil code	Operating range		Resistance R	Consumption I at U _N (50Hz)
		U _{min}	U _{max}		
V		V	V	Ω	mA
8	8.008	6.8	8.8	6.5	360
12	8.012	10.2	13.2	13.5	245
24	8.024	20.4	26.4	41	135
48	8.048	40.8	52.8	186	68
110	8.110	93.5	121	970	26
120	8.120	102	132	1,380	24
230	8.230	195.5	253	4,200	12.5
240	8.240	204	264	4,400	12

ACCESSORIES

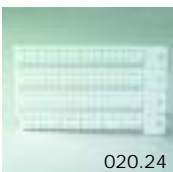

020.24

Sheet of marker tags (24 tags): 9x17mm	020.24
--	--------

ORDERING INFORMATION

Example: a 26 series screw terminal mount relay with double phase switch 2 NO - 10 A contacts, with coil rated at 12 V AC.

2 6 . 0 2 . 8 . 0 1 2 . 0 0 0 0

Series

Type

0 = Screw terminal

No. of poles

- 1 = Single phase switch 1 NO
- 2 = Double phase switch 2 NO
- 3 = Double phase switch 1 NO + 1 NC
- 4 = 4 sequence double phase switch 2 NO
- 6 = 3 sequence double phase switch 2 NO
- 8 = 4 sequence double phase switch 2 NO

Coil voltage

see coil specifications

Coil version

8 = AC (50 Hz)

TECHNICAL DATA

INSULATION

DIELECTRIC STRENGTH		
- between supply and contacts	V AC	3,500
- between open contacts	V AC	2,000
- between adjacent contacts	V AC	2,000

OTHER DATA

26.01, 26.03, 26.08

26.02, 26.04, 26.06

POWER LOST TO THE ENVIRONMENT		26.01, 26.03, 26.08		26.02, 26.04, 26.06	
- with rated current	W	0.9		1.8	
MAX WIRE SIZE		solid cable	stranded cable	solid cable	stranded cable
	mm ²	1x4 / 2x2.5	1x2.5 / 2x2.5	1x4 / 2x2.5	1x2.5 / 2x2.5
	AWG	1x12 / 2x14	1x14 / 2x14	1x12 / 2x14	1x14 / 2x14
SCREW TORQUE	Nm	0.8		0.8	

COIL SPECIFICATIONS

AC VERSION DATA

Nominal voltage U_N V	Coil code	Operating range		Resistance R	Consumption I at U_N (50Hz) mA
		U_{min} V	U_{max} V		
12	8.012	9.6	13.2	17	370
24	8.024	19.2	26.4	70	180
48	8.048	38.4	52.8	290	90
110	8.110	88	121	1,500	40
230	8.230	184	253	6,250	20

TYPE	Number of steps	SEQUENCES			
		1	2	3	4
26.01	2				
26.02	2				
26.03	2				
26.04	4				
26.06	3				
26.08	4				

WIRING DIAGRAMS

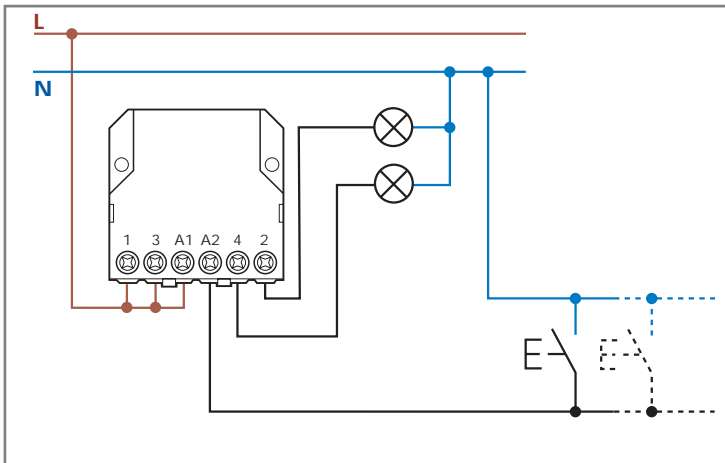

ACCESSORIES

12-24 V DC CONTROL APPLICATIONS

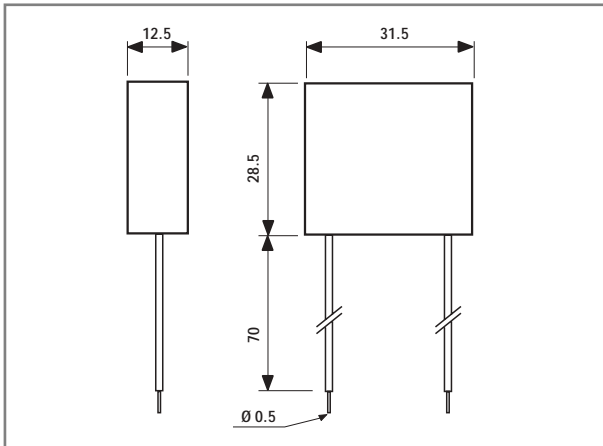

Type: 026.9.012

NOMINAL VOLTAGE: 12 V DC
 MAX TEMPERATURE: + 40 °C
 OPERATING RANGE: (0.9...1.1)U_N

Type: 026.9.024

NOMINAL VOLTAGE: 24 V DC
 MAX TEMPERATURE: + 40 °C
 OPERATING RANGE: (0.9...1.1)U_N

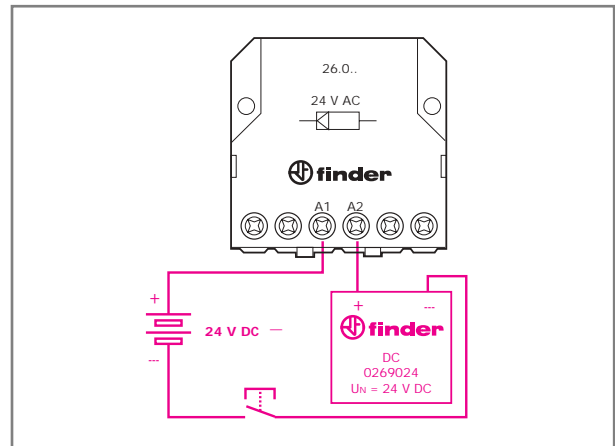

Example of wiring for 24 V DC control application.

MODULE FOR ILLUMINATED PUSH-BUTTONS

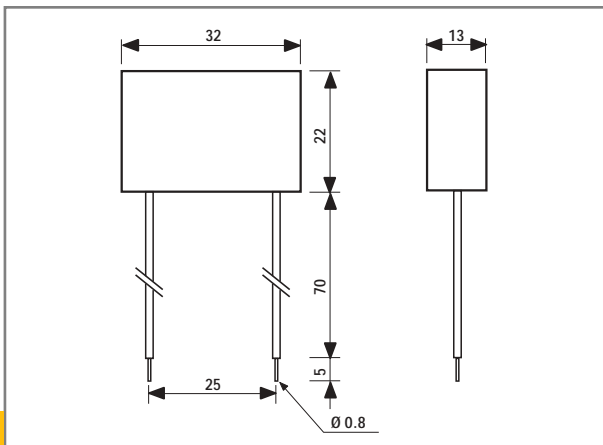

Type 026.00

Sealed version, 7.5 cm insulated and flexible terminals.

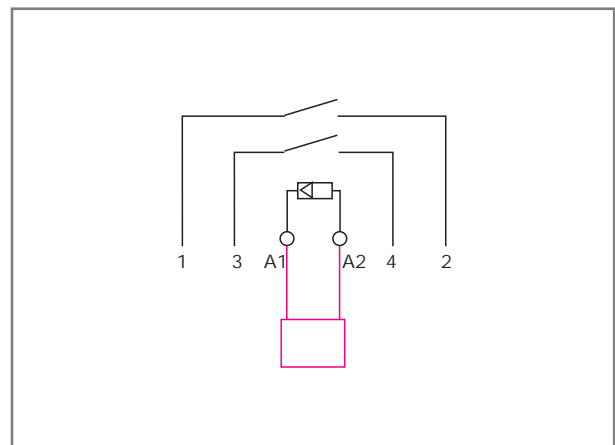

Example of wiring diagram of type 026.00

This module is necessary if using up to a maximum of 15 illuminated pushbuttons (1.5 mA max, 230 V AC) in the switching input circuit. It must be connected in parallel to the coil of the relay (see diagram).

- Screw terminal connections
- AC coil
- Panel mount

27.01

27.05/06



- Single phase switch 1 NO

- Double phase switch

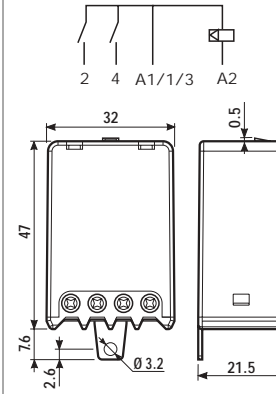
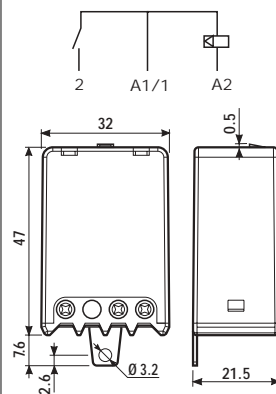

Contact specifications		1		2		
Number of contacts		1		2		
Rated current/Max. peak current	A	10/20		10/20		
Rated voltage/Max. switching voltage	V AC	110/110	230/230	110/110	230/230	
Rated load in AC1	VA	1,100	2,300	1,100	2,300	
Rated load in AC15 (230 VAC)	VA	250	500	250	500	
Nominal lamp rating:	incandescence	W	500	1000	500	1000
	compensated fluorescent	W	180	360	180	360
	uncompensated fluorescent	W	250	500	250	500
	halogens	W	400	800	400	800
Minimum switching current	mA	10		10		
Standard contact material		AgNi		AgNi		
Coil specifications						
Nominal voltage	V AC (50/60Hz)	110	230	110	230	
	V DC	—		—		
Rated power AC/DC	VA (50Hz)/W	4/—		4/—		
Operating range	AC	(0.8...1.1)U _N		(0.8...1.1)U _N		
	DC	—		—		
Technical data						
Mechanical life	cycles	300 · 10 ³		300 · 10 ³		
Electrical life at rated load in AC1	cycles	100 · 10 ³		100 · 10 ³		
Minimum/Maximum impulse duration		0.1s/1h (according to EN 60669)		0.1s/1h (according to EN 60669)		
Insulation between coil and contacts (1.2/50μs)	kV	4		4		
Ambient temperature range	°C	-40...+40		-40...+40		
Protection category		IP 20		IP 20		
Approvals: (according to type)		GOST				

ORDERING INFORMATION

Example: a 27 series clamp terminal mount relay with single phase switch 1 NO - 10 A contacts, with coil rated at 230 V AC.

27.01.8.230.0000

Series

Type

0 = Clamp terminal

No. of poles

1 = Single phase switch 1 NO

5 = 4 sequence double phase switch 2 NO

6 = 3 sequence double phase switch 2 NO

Coil voltage

see coil specifications

Coil version

8 = AC (50 Hz)

TECHNICAL DATA

INSULATION

DIELECTRIC STRENGTH - between open contacts	V AC	1,000
--	------	-------

OTHER DATA

27.01

27.05, 27.06

POWER LOST TO THE ENVIRONMENT - with rated current	W	0.9	1.8		
MAX WIRE SIZE		solid cable	stranded cable	solid cable	stranded cable
	mm ²	2x2.5	1x4 / 2x2.5	2x2.5	1x4 / 2x2.5
	AWG	2x14	1x12 / 2x14	2x14	1x12 / 2x14
SCREW TORQUE	Nm	0.8	0.8		

COIL SPECIFICATIONS

AC VERSION DATA

Nominal voltage U_N V	Coil code	Operating range		Resistance R	Consumption I at U_N (50Hz) mA
		U_{min} V	U_{max} V		
110	8.110	88	121	1,400	42.0
230	8.230	184	253	6,500	17.5

Type	Number of steps	Sequences			
		1	2	3	4
27.01	2				
27.05	4				
27.06	3				

WIRING DIAGRAMS

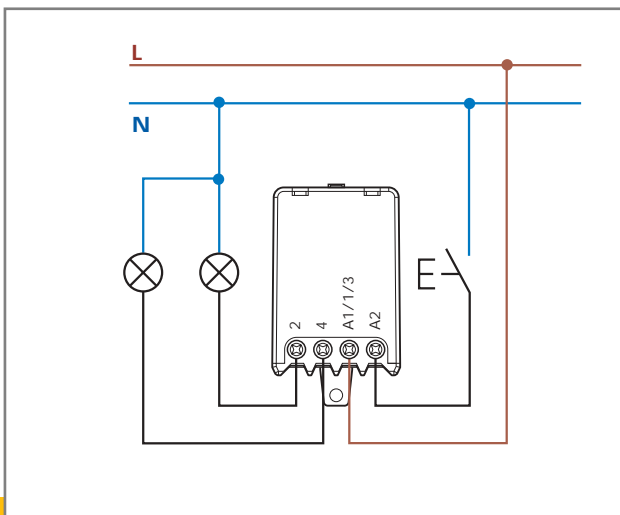

ACCESSORIES

MODULE FOR ILLUMINATED PUSH-BUTTONS

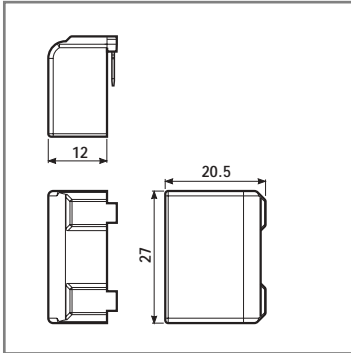

Type O27.00

This module is necessary if using up to a maximum of 15 illuminated push-buttons (1 mA max, 230 V AC) in the switching input circuit.

It must be plugged directly into the relay.

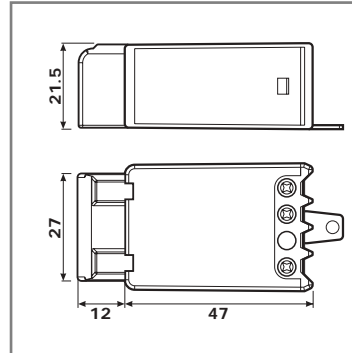

27 series relay with O27.00 module.

REFERENCE STANDARDS AND VALUES

Unless expressly indicated otherwise, the products shown in this catalogue are designed and manufactured according to the requirements of the following European and International Standards:

- EN 61810-1, EN 61810-5, IEC 61810-7, EN 60255-23 for all-or-nothing (elementary) relays
- EN 61812-1 for timers
- EN 60669-1 and EN 60669-2-2 for electromechanical step relays
- EN 60669-1, EN 60669-2-1 and EN 60669-2-3 for electronic step relays, staircase switches and light-dependent relays

Other standards, used as reference for double insulation, are:

- VDE 0106 as basic standard
- EN 60335 (VDE 0700) for domestic appliances, prescribing 8mm creepage and clearance between coil and contacts
- EN 50178 (VDE 0160) for industrial appliances, prescribing 5.5 mm clearance and 6.4...8 mm creepage between coil and contacts

According to EN 61810-1, all technical data is specified under standard conditions of 23°C ambient temperature, 96 kPa pressure, 50% humidity, clean air and 50 Hz frequency. The tolerance for coil resistance, nominal absorption and rated power values is $\pm 10\%$.

WORKING CONDITIONS

- Unless expressly indicated otherwise, all relays are suitable for 100% Duty Cycle and all the AC coil relays are suitable for 50 and 60 Hz frequency.
- Environmental conditions causing condensation or ice formation in the relay are not permitted.
- Overvoltage protection (varistor for AC, diode for DC) is recommended in parallel with the coil for nominal voltages ≥ 110 V for the relays of 40, 41, 44 series.
- When relay coils are controlled via a proximity switch, or via cables having length > 10 m, the use of a "residual current bypass" module in parallel with the coil is recommended.

GUIDELINES FOR AUTOMATIC FLOW SOLDER PROCESSES

In general, an automatic flow solder process consists of the following stages:

RELAY MOUNTING - Ensure that the relay terminals are straight and enter the PC board perpendicular to the PC board. For each relay, the catalogue illustrates the necessary PC board pattern (copper side view).

FLUX APPLICATION - This is a particularly delicate process. If the relay is not sealed, flux may penetrate the relay due to capillary forces changing its performance and functionality.

Whether using foam or spray fluxing methods, ensure that flux is applied sparingly and evenly and does not flood through to the component side of the PC board.

By following the above precautions, and assuming the use of alcohol or water based fluxes, it is possible to satisfactorily use relays with protection category RT II.

PREHEATING - Set the preheat time and heat to just achieve the effective evaporation of the flux, taking care not to exceed a component side temperature of 100°C (212°F).

SOLDERING - Set the height of the molten solder wave such that the PC board is not flooded with solder. Ensure the solder temperature and time are kept to 250°C (482°F) and 3 seconds maximum.



CLEANING - The use of modern "no-clean" flux avoids the necessity of washing the PC board. In special cases where the PC board must be washed the use of wash-tight relays (option 0001 - RT III) is strongly recommended. Even so, avoid washing the relay itself, particularly with aggressive solvents or in cycles using low temperature water, as this may cause thermal shock to the PC board components.

TERMINOLOGY & DEFINITIONS

All the following terms indicated in the catalogue are commonly used in technical language. However, occasionally, National European or International Standards may prescribe the use of different terms, in which case this will be mentioned in the appropriate descriptions that follow.

CONTACT SPECIFICATIONS

CONTACT CONFIGURATION:

Symbol	Configuration	EU	D	GB	USA
	Make contact (Normally Open)	NO	S	A	SPST-NO DPST-NO nPST-NO
	Break contact (Normally Closed)	NC	Ö	B	SPST-NC DPST-NC nPST-NC
	Changeover	CO	W	C	SPDT DPDT nPDT

n = number of poles (3,4,...)

TERMINAL MARKING

The European Standard EN 50005 recommends the following numbering for the marking of relay terminals:

- .1 for common contact terminals (e.g. 11, 21, 31...)
- .2 for NC contact terminals (e.g. 12, 22, 32...)
- .4 for NO contact terminals (e.g. 14, 24, 34...)
- A1 and A2 for coil terminals

For delayed contacts of timers the numbering will be:

- .5 for common contact terminals (e.g. 15, 25,...)
- .6 for NC contact terminals (e.g. 16, 26, ...)
- .8 for NO contact terminals (e.g. 18, 28,...)

IEC 67 and American standards prescribe:

- progressive numbering for terminals (1,2,3,...13,14,..)
- sometimes A and B for coil terminals.

RATED CURRENT - The limiting continuous current, is the highest current that a contact can continuously carry within the prescribed temperature limits. It also coincides with the limiting cycling capacity, i.e. the maximum current that a contact is capable of making and breaking under specified conditions.

MAXIMUM PEAK CURRENT - The highest value of inrush current (≤ 0.5 seconds) that a contact can make and cycle (duty cycle ≤ 0.1) without undergoing any permanent degradation of its characteristics due to generated heat. It also coincides with the limiting making capacity

MAXIMUM BLOCKING VOLTAGE (Solid State Relay) - The maximum level of output voltage at which the output circuit will not be destroyed.

RATED VOLTAGE - The line-to-neutral voltage (derived from nominal voltages of contact loads) used for insulation co-ordination.

MAXIMUM SWITCHING VOLTAGE - The highest voltage level (including tolerances) that the contacts are able to switch according to rated voltage.

RATED LOAD IN AC1 - The maximum AC resistive switching power (in VA) that a contact can make, carry and break repeatedly, according to utilisation category AC1, EN 60947-4-1 (see Table 1). It is the product of rated current and rated voltage. It is used as the reference load for electrical life tests.

RATED LOAD IN AC15 - The maximum AC inductive switching power (in VA) that a contact can make, carry and break repeatedly, according to utilisation category AC15, EN 60947-5-1 (see Table 1).

SINGLE PHASE MOTOR RATING - The nominal value of motor power that a relay can switch according to EN 60947-1, UL 508 and CSA 22.2 n. 14 * The figures are given in kW; the horsepower rating can be calculated by multiplying that value by 1.34 (ie. 0.37 kW = 0.5 HP). If reversing motor direction, always allow an intermediate break > 300 ms, otherwise an excessive inrush peak current (caused from change of polarity of motor capacitor) may occur, causing contact welding.

RATED LAMPS LOAD - Maximum incandescent and fluorescent lamp ratings for 230 V AC supply voltage. Fluorescent lamps compensated to $\cos \phi \geq 0.9$.

BREAKING CAPACITY IN DC1 - The maximum value of DC resistive current that contacts can switch, depending on the value of the load voltage (see table 1).

MINIMUM SWITCHING LOAD - The minimum values of power, voltage and current that a contact can reliably switch. For example, if minimum values are 300mW, 5V/5mA:

- with 5V the current must be at least 60mA;
- with 24V the current must be at least 12.5mA;
- with 5 mA the voltage must be at least 60 V.

For gold contact variants, loads no less than 50mW, 5V/2mA are suggested.

With 2 gold contacts in parallel, it is possible to switch 1mW, 0,1V/1mA.

ELECTRICAL LIFE TEST - An AC resistive load test (AC1 category) conducted with relay coil (both AC and DC) supplied at rated voltage. Load applied between all movable and NO contacts but without any load on the NC contacts, and vice-versa. These load life values are valid for relays with standard contact material.

Switching frequency:

All-or-nothing relays: coil 900 cycles/h - contact 900 cycles/h (2s ON - 2s OFF, 1s ON - 3s OFF for rated current >16 A)
Step relays: coil 900 cycles/h - contact 450 cycles/h (4s ON - 4s OFF)

LOAD REDUCTION FACTOR VERSUS COS ϕ - For AC inductive loads (such as solenoids, contactors coils, etc.) the reduction factor corresponding to $\cos \phi$ shall be multiplied by the rated current in order to define the maximum allowed current. It is not valid for electric motors or fluorescent lamps.

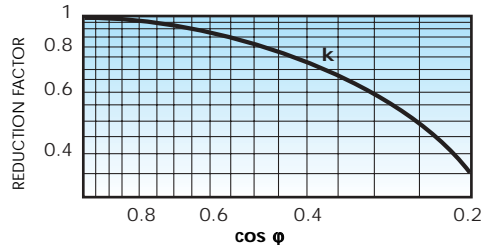

TABLE 1 - Utilisation categories according to EN60947-4-1 and EN 60947-5-1

Load Category	Supply type	Application
AC 1	AC single-phase AC three-phase	Resistive or slightly Inductive AC loads.
AC 3	AC three-phase	Starting and stopping of Squirrel-cage motors. Reversing direction of rotation only after stopping motor.
AC 4	AC three-phase	Starting, Stopping and Reversing direction of rotation of Squirrel cage motors. Jogging (Inching). Regenerative braking (Plugging).
DC 1	DC	Resistive loads or slightly inductive DC loads.*
AC 14	AC single-phase	Control of small electromagnetic loads (<72 VA), power contactors, magnetic solenoid valves, and electromagnets.
AC 15	AC single-phase	Control of small electromagnetic loads (>72 VA), power contactors, magnetic solenoid valves, and electromagnets.
DC 13	DC	Control of electromagnetic loads, power contactors, magnetic solenoid valves, and electromagnets

* The switching voltage at the same current can be doubled by wiring 2 contacts in series.

CONTACT RESISTANCE - Measured, according to contact category (Table 2), at the external terminals of the relay. It is a statistical value, not reproducible. It hasn't any effect on relay reliability on most application. The typical value, measured with 24 V 100 mA, is 50 m Ω .

TABLE 2 - Contact categories according to EN60255-23

The effectiveness with which a relay contact can make an electrical circuit depends on several factors, such as the material used for the contact, its' exposure to environmental pollution and its' design etc.. Therefore, for reliable operation, it is necessary to specify a contact Application Category that will define a particular relay's switching capability in terms of maximum and minimum limits for contact voltage and current. The appropriate Application Category will also define the voltage and current levels used to measure the contact resistance. All Finder relays are category 3, with the exception of 30 series, which is category 2.

Application category	Voltage (V)	Current (A)	Contact Resistance Measurement (IEC 61810-7)	
0	$U < 0,03$	$I < 0.01$	> 30 mV	10 mA
1	$0,03 < U < 60$	$0,01 < I < 0,1$	100 mV	10 mA
2	$5 < U < 250$	$0,1 < I < 1$	24 V	100 mA
3	$5 < U < 600$	$0,1 < I < 100$	24 V	1000 mA

TABLE 3 - Contact materials characteristics

Material	Property	Typical application*
AgNi + Au (Silver Nickel Gold plated)	<ul style="list-style-type: none"> - Silver-nickel base with a galvanic hard gold plating of 5 μm typical thickness - Gold is not attacked by industrial atmospheres - With small loads, contact resistance is lower and more consistent compared to other materials. <p>NOTE: 5 μm hard gold plating is completely different from 0.2 μm gold flashing, which allows only protection in storing, but no better performance in use.</p>	<p>Wide range applications:</p> <ul style="list-style-type: none"> - Small load range (where gold plating erodes very little) from 50 mW (5V 2mA) up to 1.5 W/24 V (resistive load). - Middle load range where gold plating erodes after several operations and the property of basic AgNi becomes dominant. <p>NOTE: for switching lower loads, typically 1mW (0.1V 1mA), (for example in measuring instruments), it is recommended to connect 2 contacts in parallel.</p>
AgNi (Silver Nickel)	<ul style="list-style-type: none"> - Standard contact material for most relay applications. - High wear resistance - Medium resistance to welding 	<ul style="list-style-type: none"> - Resistive and slightly inductive loads - Rated current up to 12 A - Inrush current up to 25 A
AgCdO (Silver Cadmium Oxide)	<ul style="list-style-type: none"> - High wear resistance with higher AC loads - Good resistance to welding 	<ul style="list-style-type: none"> - Inductive and motor loads - Rated current up to 30 A - Inrush current up to 50 A
AgSnO ₂ (Silver Tin Oxide)	<ul style="list-style-type: none"> - Excellent resistance to welding - Low material transfer in DC loads 	<ul style="list-style-type: none"> - Lamp and capacitive loads - Very high Inrush current (up to 120 A) loads

* It is necessary to refer to the maximum current values specified in the catalogue for each relay.

COIL (or INPUT or SUPPLY) SPECIFICATIONS

NOMINAL VOLTAGE - The nominal value of coil (or input or supply) voltage for which the relay has been designed, and for which operation is intended. The operating and use characteristics are referred to the rated voltage.

RATED POWER - The DC power value (W) or the apparent AC power value (VA with closed armature) which is absorbed by the coil at 23°C and at rated voltage. It is a short-time value (not steady-state).

OPERATING RANGE - The range of input voltage, in nominal voltage applications, in which the relay works in the whole range of ambient temperatures, according to operating class:

- class 1: 0.8...1.1 U_N
- class 2: 0.85...1.1 U_N

In application where the coil voltage doesn't meet the tolerances of nominal voltage, the diagrams "R" shows the relation of maximum coil voltage permitted and pick-up voltage (without pre-energisation) versus ambient temperature.

ENERGIZATION VOLTAGE

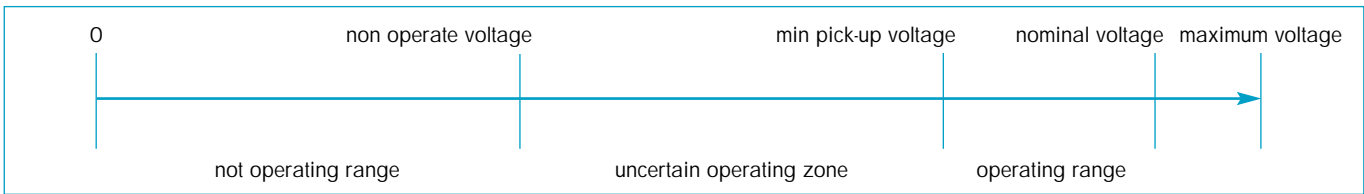

DE-ENERGIZATION VOLTAGE

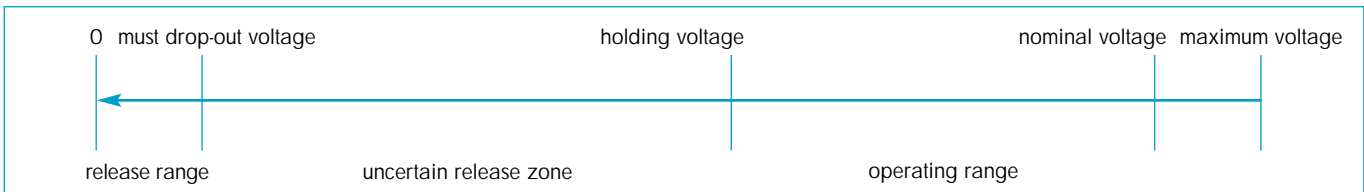

NON-OPERATE VOLTAGE - The value of input voltage at which the relay will not operate (not specified in the catalogue).

MINIMUM PICK-UP VOLTAGE (Operate voltage) - The lowest value of applied voltage at which the relay will operate.

MAXIMUM VOLTAGE - The highest applied voltage that the relay can continuously withstand, dependent on ambient temperature (see "R" diagrams).

HOLDING VOLTAGE (Non-release voltage) - The lowest value of coil voltage at which the relay (which has previously been energised with a voltage within the operating range) will not drop-out.

MUST DROP-OUT VOLTAGE (Release voltage) - The value of coil voltage at which the relay (which had previously been energised with a voltage within the operating range) will definitely drop-out.

RESISTANCE - The average value of the coil resistance under the standard prescribed condition of 23°C ambient.

RATED COIL CONSUMPTION - The average value of coil current, when energised at nominal voltage.

CONTROL CURRENT (Solid State Relays) - The nominal value of current consumption of the input circuit, when supplied at nominal voltage.

THERMAL TESTS - Calculation of the coil temperature rise (ΔT) is made by measuring the coil resistance in a controlled temperature oven (not ventilated) until a stable value is reached (no less than 0.5 K variation in 10 minutes).

That is: $\Delta T = (R_2 - R_1) / R_1 \times (234.5 + t_1) \cdot (t_2 - t_1)$

- where:
- R₁ = initial resistance
 - R₂ = final resistance
 - t₁ = initial temperature
 - t₂ = final temperature

INSULATION DATA

INSULATION COORDINATION (according to EN 61810-5 and IEC 60664-1)

In accordance with to EN 61810-5, the Insulation characteristics achieved by the relay can be described by just two characteristic parameters – the Rated Impulse Voltage and the Degree of Pollution.

To ensure the correct Insulation Coordination between the relay and the application, the equipment designer (relay user) should establish the Rated Impulse Withstand Voltage appropriate to his application, and the Pollution level for the micro environment in which the relay is situated. He should then match (or coordinate) these two figures with the corresponding values given in the appropriate relay data.

To establish the appropriate Pollution degree and Rated impulse withstand voltage refer either to an appropriate Product Standard (which may be mandatory for the particular type of equipment), or consider the tables below. Select the Rated impulse withstand voltage from a knowledge of the Nominal Voltage of the Supply and a knowledge of the Over Voltage Category (as described in IEC60664-1).

Nominal voltage of the supply system (mains) according to IEC 60038		Voltage line-to-neutral (derived from nominal voltages AC or DC, up to and including)	Rated impulse withstand voltage			
V			V			
Three-phase	Single-phase		Overvoltage category			
			I	II	III	IV
	120 to 240	150	800	1500	2500	4000
230/400*		250*	1200*	2200*	3600*	5500*
230/400 277/480		300	1500	2500	4000	6000

* For existing products the interpolated values apply

Pollution degree	Immediate surroundings conditions
1	No pollution or only dry, non-conductive pollution occurs. The pollution has no influence.
2	Only non-conductive pollution occurs, except that occasionally a temporary conductivity caused by condensation is to be expected.
3	Conductive pollution occurs or dry, non-conductive pollution occurs which becomes conductive due to condensation which is to be expected.
4	The pollution generates persistent conductivity caused by conductive dust or by rain or snow.

Dependent on the product standard, pollution degree 2 and 3 are commonly prescribed for equipment. For example, EN 50178 (electronic for use in power installations) prescribes, under normal circumstances, contamination level 2.

Examples of specification of Rated Impulse Voltage and the Degree of Pollution :

4 kV/3 (This relay is designed to withstand a rated impulse voltage of 4 kV and pollution degree 3).

4 - 2,5 kV/3 (This relay is designed to withstand rated impulse voltages of 4 kV and 2.5 kV and pollution degree 3).

If only one rated impulse voltage is given, the value refers to all electrical circuits against each other and against the accessible surfaces. If two values are indicated for the rated impulse voltage, the first value refers to the contacts against each other and against the accessible surfaces as well as other electrical circuits. The second value refers to the coil against accessible surfaces and other electrical circuits.

DIELECTRIC STRENGTH - It can be described in terms of an alternating voltage or in terms of a surge (1.2/50 μ s impulse) voltage. The correspondence between the alternating voltage and surge voltage is listed in IEC 60664-1 Annex A, Table A.1.

For all Finder relays a 100 % test is carried out with a 50 Hz, alternating voltage applied between all contacts and coil, between adjacent contacts and between open contacts. The leakage current must be less than 3 mA.

Type tests are carried out with both alternating voltage and with impulse voltage.

DIELECTRIC STRENGTH BETWEEN OPEN CONTACTS - It far exceeds the maximum switching voltage. Typical contact gaps of 0.3 ~ 0.5 mm result in ultimate dielectric strength values of typically 1300 ~ 1550 V (1.2/50 μ s impulse), but always refer to the relay specification.

INSULATION GROUP - The latest way of specifying insulation properties according to the Insulation Coordination replaces the insulation group classification, such as C 250 according to the older VDE 0110 standard.

SAFE SEPARATION / DOUBLE INSULATION - Isolation Co-ordination as described earlier ensures the isolation of hazardous voltages from other circuits to a safe engineering level. But importantly, not on the basis that there is any intentional direct personal access to the isolated circuits or, where failure of insulation would present a particularly high risk. (Telecoms and medical applications, are good examples).

For high risk / high integrity applications there is a need for a very special and higher level of physical isolation and integrity between circuits, and this is provided by safe separation and double insulation. The regulations for safe separation establish the conditions which must be met for PELV (protected extra low voltage) or SELV (safety extra low voltage) circuits.

Consider the common case, where the mains voltage of 230 V and a low voltage circuit both appear within a relay; all the following requirements for the relay, including its connections and wiring, must in consequence be met.

- The low voltage and the 230 V must be separated by double or reinforced insulation. This means that between the two electrical circuits must be guaranteed a dielectric strength of 6 kV (1.2/50 μ s), an air distance of 5.5 mm and, depending on the pollution degree and on material used, an appropriate tracking distance.
- The electrical circuits within the relay must be protected against any possibility of bridging caused, for instance, by a loose metal part. This is achieved by the physical separation of circuits into isolated chambers within the relay.
- The wires connected to the relay must also be physically separated from each other. This normally is achieved using separate cable channels.
- For relays mounted on printed circuit boards the appropriate distance between the tracks connected to low voltage and the tracks connected to other voltages must be achieved.

Although this appears quite complex, with the SELV insulation options offered on some Finder relays, the user only needs to address the two last points. And with the coil and contact connections on opposite sides of the relays and sockets, the separation of connections into different cable channels is greatly facilitated.

GENERAL TECHNICAL DATA

CYCLE - Operate and subsequent release of a relay. Over a cycle the coil is energised and de-energised and the contact will progress from the point at which it makes a circuit, through to breaking the circuit, to the point at which it re-makes the circuit.

PERIOD - The time covering one cycle.

DUTY FACTOR (DF) - During cyclic operation, DF is the ratio between the energised time and one period. For continuous duty, DF = 1.

MECHANICAL LIFE - This test is performed by energising the coils of several relays at 8 cycles per second without any load applied to the contacts. It establishes the ultimate durability of the relay where electrical wear of the contacts is not an issue. The maximum Electrical Life may therefore approach the Mechanical Life where the electrical loading of the contacts is very small.

ELECTRICAL LIFE - See in CONTACT SPECIFICATIONS.

OPERATE TIME - The typical value of the NO contact closing time with the coil energised at rated voltage. It doesn't include the bounce time (see following pattern).

RELEASE TIME - For CO relays: the typical value of the NC contact closing time with the coil de-energized. It doesn't include the bounce time.
 For NO relays: the typical value of the NO contact opening time with the coil de-energized.
 Note: It will increase if protection (diode or led+diode) modules are connected in parallel to the coil.

BOUNCE TIME - The typical value of duration of bounces, for NO or NC contacts.

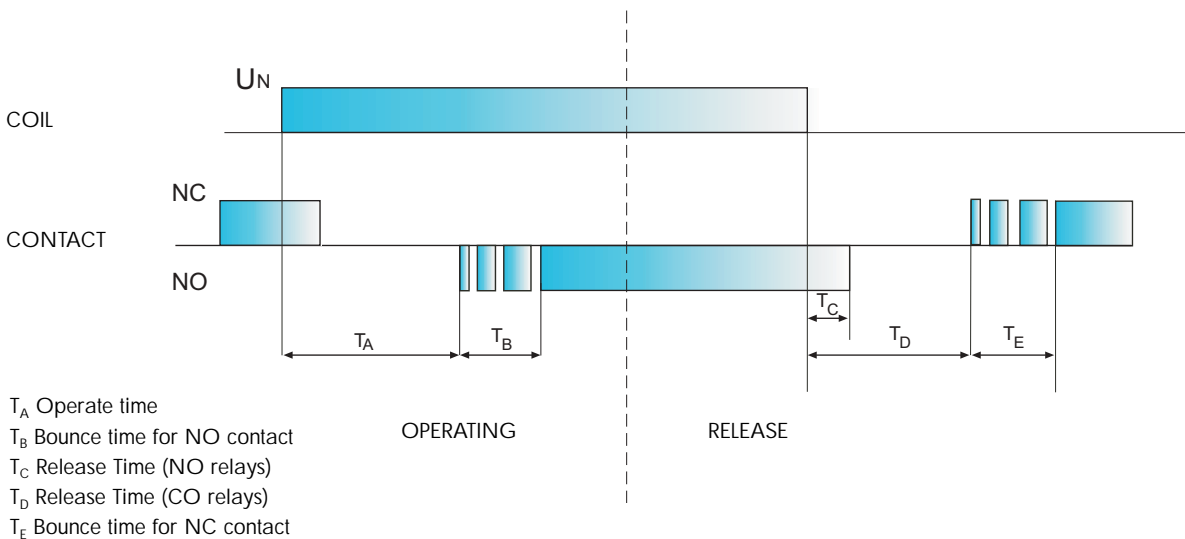

INSULATION COORDINATION according to EN 61810-5 - See in INSULATION DATA.

DIELECTRIC STRENGTH BETWEEN OPEN CONTACTS - See in INSULATION DATA.

AMBIENT TEMPERATURE RANGE - The range of temperatures of the immediate area where the relay is located, and for which operation of the relay is guaranteed (under prescribed conditions).

ENVIRONMENTAL PROTECTION according to IEC 61810-7 - The relay technology categories describe the degree of sealing of the relay case:

Relay technology category	Condition
RT 0 Unenclosed relay	Relay not provided with a protective case.
RT I Dust protected relay	Relay provided with a case which protects its mechanism from dust.
RT II Flux proof relay	Relay capable of being automatically soldered without allowing the migration of solder fluxes beyond the intended areas.
RT III Wash tight relay	Relay capable of being automatically soldered and subsequently undergoing a washing process to remove flux residues without allowing the ingress of flux or washing solvents.
RT IV Sealed relay	Relay provided with a case which has no venting to the outside atmosphere
RT V Hermetically sealed relay	Sealed relay having an enhanced level of sealing.

PROTECTION CATEGORY OF ENCLOSURES - according to EN 60529. The first digit is related to the protection against ingress of solid foreign objects into the relay, and also against access to hazardous parts. The second digit relates to the protection against ingress of water. The IP grade is related to normal use, in relay sockets or PC boards. For sockets, IP20 means that the socket is "finger-safe" (VDE0106).

Examples:

IP 00 = Not protected.

IP 20 = Protected against solid foreign objects of 12.5 mm Ø and greater. Not protected against water.

IP 40 = Protected against solid foreign objects of 1 mm Ø and greater. Not protected against water.

IP 50 = Protected against powder (ingress of dust is not totally prevented, but dust shall not penetrate in a quantity to interfere with satisfactory operation of the relay). Not protected against water.

IP 67 = Totally protected against powder (dust-tight) and protected against the effect of temporary immersion in water.

VIBRATION RESISTANCE - The maximum acceleration value (measured in $g = 9.81 \text{ m/s}^2$) for frequencies in the range 10-55 Hz which can be applied to the relay in any of the 3 axis, without the opening for more than 10 µs of the NO contact (if the coil is energised) or NC contact (if the coil is not energised). In the energised state, the resistance is usually higher than in non-energised state.

POWER LOST TO THE ENVIRONMENT - The value of the power lost from the relay in working conditions (without contact load or at full load) and may be used in the thermal design of panels.

MOUNTING POSITION - If not expressly indicated, any mounting position of the relay is permitted.

RECOMMENDED DISTANCE BETWEEN RELAYS MOUNTED ON PC.Boards - This is the minimum mounting distance suggested when several relays are mounted on the same PC board. Care shall also be taken that other components mounted on the PC board do not heat the relays.

TORQUE - The maximum value of torque that can be used for tightening terminal screws, according to EN 60999, is 0.4 Nm for M2,5 screws, 0.5 Nm for M3 screws, 0.8 Nm for M3, 5 screws, 1.2 Nm for M4 screws.

The test torque is indicated in the catalogue.. Normally a 20% increase of this value is acceptable.

 Both slot-head and cross-head screwdrivers can be used.

MAX WIRE SIZE - Maximum cross-section of cables (solid or stranded wire, without ferrules) that can be connected to each terminal. For use with ferrules, the wire cross-section has to be reduced (e.g. from 4 to 2.5 mm², from 2.5 to 1.5 mm², from 1.5 to 1 mm²).

For any terminals, a minimum cross-section of 0.2 mm² is allowed.

According to EN 60204-1, it is permitted to introduce 2 or more wires into the same terminal. All Finder products are designed in such a way that each terminal can accept 2 or more wires.

SPECIFIED TIME RANGE - Range in which it is possible to set timing using the time scales.

REPEATABILITY - The difference between the upper and lower limits of a range of values taken from several time measurements of a specified time relay under identical stated conditions. Usually repeatability is indicated as a percentage of the mean value of all measured values.

RECOVERY TIME - The time necessary to start the relay again with the defined accuracy after the input energising quantity has been removed.

MINIMUM CONTROL IMPULSE - The shortest duration of a control impulse to fulfil and complete the time function.

SETTING ACCURACY - The difference between the measured value of the specified time and the reference value set on the scale.

THRESHOLD SETTING - For light-dependent relays this is the illumination level (measured in Lux) at which the relay will switch on or off. Pre-set levels and the corresponding range of threshold that can be set using the regulator are indicated in the catalogue.

DELAY TIME - For light-dependent relays this is the delay between the change of state in the electronic circuit sensitive to light variation (usually indicated by change of state of an LED) and the switching of the output relay contact.

CABLE GRIP - Specifies the range of the external diameter of cables that can be reliably gripped.

TYPE - For time switches, this is the type of program (weekly or daily).

PROGRAMS - For time switches, this is the number of different types of programs that can be stored.

MINIMUM INTERVAL SETTING - For time switches, this it is the minimum time interval that can be programmed.

BACK-UP POWER - The time when the switch won't loose neither the programs nor the time.

MAXIMUM IMPULSE DURATION - For step relays and staircase switches, this is the maximum command pulse duration permitted.

MAX NO. OF ILLUMINATED PUSH-BUTTONS - For step relays and staircase switches, this is the maximum number of illuminated push-buttons (having current absorption < 1mA @ 230 V AC) that can be connected without causing problems. If the push-button consumption is higher than 1 mA, the maximum number of push-buttons allowed is proportionally reduced (ie. 15 push-buttons x 1 mA is equivalent to 10 push-buttons x 1.5 mA).

EMC (ElectroMagnetic Compatibility) SPECIFICATIONS

TYPE OF TEST	REFERENCE STANDARD
ELECTROSTATIC DISCHARGE	EN 61000-4-2
RADIO-FREQUENCY ELECTROMAGNETIC FIELD (80 ÷ 1000 MHz)	EN 61000-4-3
FAST TRANSIENTS (burst) (5-50 ns, 5 kHz)	EN 61000-4-4
SURGES (1.2/50 µs)	EN 61000-4-5
RADIO-FREQUENCY COMMON MODE DISTURBANCES (0.15 ÷ 80 MHz)	EN 61000-4-6
POWER-FREQUENCY MAGNETIC FIELD (50 Hz)	EN 61000-4-8
RADIATED AND CONDUCTED EMISSION	EN 55011 / 55014 / 55022

In panel installations, the most frequent and, particularly, more dangerous type of electrical disturbances are the following:

- Burst** (fast transients). These are packets of **5/50ns** pulses, having high peak voltage level but low energy since individual pulses are very short - 5 ns rise time (5×10^{-9} seconds) and 50 ns fall time. They simulate the disturbances that can spread along the cables as a consequence of commutation transients from relays, contactors or motors. Usually they are not destructive, but they can affect the correct working of electronic devices.

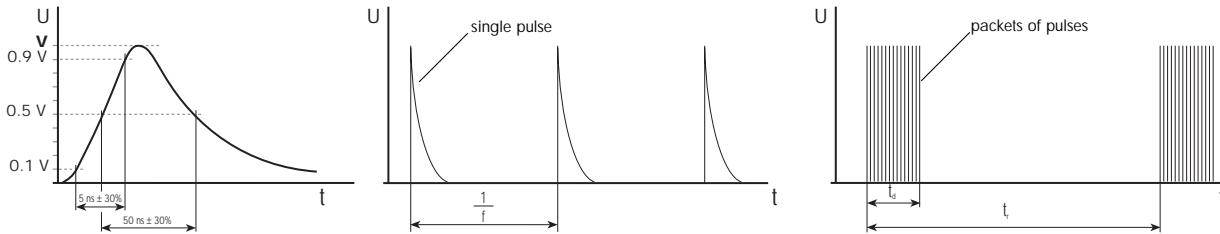

- Surge** (voltage pulses). These are single **1.2/50µs** pulses, with energy much higher than bursts since the duration is considerably longer - 1.2 µs rise time (1.2×10^{-6} seconds) and 50 µs fall time. For this reason they are very often destructive. The Surge test typically simulates disturbances caused by the propagation of atmospheric electrical storm discharges along electrical lines, but often the switching of power contacts (such as the opening of highly inductive loads) can cause disturbances that are very similar, and equally destructive.

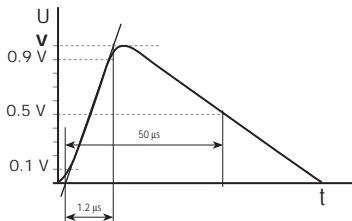

The test levels **V** (peak values of the single pulses) are prescribed in appropriate product standards:

- **EN 61812-1** for electronic timers;
- **EN 60669-2-1** for electronic relays and switches;
- **EN 50082-2** (generic standard for immunity in the industrial environment) for other electronic products for industrial application;
- **EN 50082-1** (generic standard for immunity in the domestic environment) for other electronic products for domestic application;

Finder electronic products are in accordance with European EMC Directives **89/336/EEC** and **93/68/EEC** and indeed, have immunity capabilities often higher than the levels prescribed in the above mentioned standards. Nevertheless, it is not impossible that some working environments may impose levels of disturbances far in excess of the guaranteed levels, such that the product could be immediately destroyed!

It is therefore necessary to consider Finder products as not being indestructible under all circumstances. The user should pay attention to the disturbances in electrical systems and reduce as much as possible these disturbances. For example, employ arc suppression circuits on the contacts of switches, relays or contactors which otherwise might produce over-voltages when opening electrical circuits (particularly highly inductive or DC loads). Attention should also be paid to the placement of components and cables in such a way as to limit disturbances and their propagation.

EMC rules - Require that it is the equipment designer who must ensure that the emissions from panels or equipment does not exceed the limits stated in EN 50081-1 (generic standard for emission in the domestic environment) or 50081-2 (generic standard for emission in the industrial environment) or any product specific harmonised EMC standard.

99.01		99.02		99.80	
Sockets	Relays	Sockets	Relays	Sockets	Relays
90.20	60.12	90.02	60.12	94.54.1	55.32, 55.34
90.21	60.13	90.03	60.13	94.82.3	55.32
94.73	55.33	94.02	55.32	94.84.3	55.32, 55.34
94.74	55.34	94.03	55.33	95.83.3	40.31
94.82	55.32	94.04	55.32, 55.34	95.85.3	40.51/52/61
96.72	56.32	95.03	40.31		44.52/62
96.74	56.34	95.05	40.51/52/61 44.52, 44.62		
		92.03	62.32, 62.33		

FUNCTION/ OPERATING RANGE	CODE	CODE	CODE
GREEN LED + DIODE MODULE (STANDARD POLARITY)			
6 - 24 V DC 28 - 60 V DC 110 - 220 V DC	99.01.9.024.99 99.01.9.060.99 99.01.9.220.99	99.02.9.024.99 99.02.9.060.99 99.02.9.220.99	99.80.9.024.99 99.80.9.060.99 99.80.9.220.99
GREEN LED + DIODE MODULE (NON STANDARD POLARITY)			
6 - 24 V DC 28 - 60 V DC 110 - 220 V DC	99.01.9.024.79 99.01.9.060.79 99.01.9.220.79	99.02.9.024.79 99.02.9.060.79 99.02.9.220.79	
GREEN LED + VARISTOR			
6 - 24 V AC/DC 28 - 60 V AC/DC 110 - 240 V AC/DC	99.01.0.024.98 99.01.0.060.98 99.01.0.230.98	99.02.0.024.98 99.02.0.060.98 99.02.0.230.98	99.80.0.024.98 99.80.0.060.98 99.80.0.230.98
GREEN LED			
6 - 24 V AC/DC 28 - 60 V AC/DC 110 - 240 V AC/DC	99.01.0.024.59 99.01.0.060.59 99.01.0.230.59	99.02.0.024.59 99.02.0.060.59 99.02.0.230.59	99.80.0.024.59 99.80.0.060.59 99.80.0.230.59
DIODE MODULE (STANDARD POLARITY)			
6 - 220 V DC	99.01.3.000.00	99.02.3.000.00	99.80.3.000.00
DIODE MODULE (NON STANDARD POLARITY)			
6 - 220 V DC	99.01.2.000.00	99.02.2.000.00	99.80.2.000.00
RC MODULE			
6 - 24 V AC/DC 28 - 60 V AC/DC 110 - 240 V AC/DC	99.01.0.024.09 99.01.0.060.09 99.01.0.230.09	99.02.0.024.09 99.02.0.060.09 99.02.0.230.09	99.80.0.024.09 99.80.0.060.09 99.80.0.230.09
RESIDUAL CURRENT BYPASS MODULE			
110 - 240 V AC	99.01.8.230.07	99.02.8.230.07	99.80.8.230.07

Voltage-current characteristic when switching an ohmic load (fig. 1).

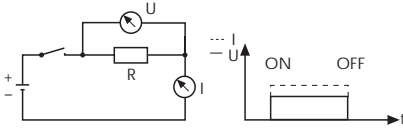

Voltage-current characteristic when switching a relay coil (fig. 2).

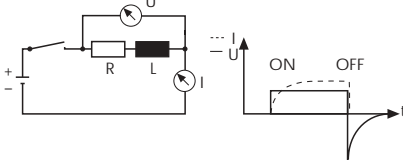

Switching Relay Coils.

When switching a resistive load, the current follows the phase of the voltage directly (Fig 1).

When switching relay coils the current and voltage waveforms are different due to the inductive nature of the coil (Fig 2). A brief explanation of this mechanism is as follows.

On energising the coil, the build up of the magnetic field gives rise to counter electromotive forces which in turn delay the rise in coil current. On de-energisation, the sudden interruption of the coil current causes a sudden collapse of the magnetic field, which in turn induces a high voltage of reverse polarity across the coil. This reverse polarity voltage peak can reach a value typically 15 times higher than the supply voltage, and as a consequence can disturb or destroy electronic devices.

To counteract this potentially damaging effect, relays coils can be suppressed with a Diode, a Varistor (voltage dependent resistor) or a RC (resistor/capacitor) module – dependent on the operating voltage. (See below for descriptions of the various Modules available.)

Whilst the above description is based on the working of a DC coil, the reverse polarity voltage peak on de-energisation applies similarly to AC coils. However, when energising AC coils there will also be a coil inrush current of 1.3 to 1.7 times the nominal coil current – dependent on coil size. If coils are fed via a transformer (and particularly if several are energised at the same time) then this may need to be taken into account when calculating the VA rating of the transformer.

Diagrams		Functions
<p>99.01.9.xxx.99 only 99.80.9.xxx.99 only</p>	<p>99.02.9.xxx.99 only</p>	<p>GREEN LED +DIODE MODULE (STANDARD POLARITY) Recovery diode modules + LED are used for DC only. The reverse voltage peaks of the coil are short circuited by the recovery diode (positive to terminal A1). The release time increases by an approximate factor of 3. If an increase of the release time is undesirable use a Varistor or RC module. The LED indicator lights up when the coil is energized.</p>
<p>99.01.9.xxx.79 only</p>	<p>99.02.9.xxx.79 only</p>	<p>GREEN LED +DIODE MODULE (NON STANDARD POLARITY) Recovery diode modules + LED are used for DC only. The reverse voltage peaks of the coil are short circuited by the recovery diode (positive to terminal A2). The release time increases by an approximate factor of 3. If an increase of the release time is undesirable use a Varistor or RC module. The LED indicator lights up when the coil is energized.</p>
		<p>GREEN LED + VARISTOR LED modules + Varistor are used for both AC and DC coils. The reverse voltage peaks of the relay coil are limited by the Varistor to approximately 2.5 times the nominal voltage of the supply. When using DC coils it is essential that positive is connected to terminal A1. The relay release time increases insignificantly.</p>
		<p>GREEN LED LED modules are used for AC and DC. The LED indicator lights up when the coil is energized. When using DC it is essential that positive is connected to terminal A1.</p>
<p>99.01.3.000.00 only 99.80.3.000.00 only</p>	<p>99.02.3.000.00 only</p>	<p>DIODE MODULE (STANDARD POLARITY) Recovery diode modules are used for DC only. The reverse voltage peaks of the coil are short circuited by the recovery diode (positive to terminal A1). The release time increases by an approximate factor of 3. If an increase of the release time is undesirable use a Varistor or RC module.</p>
<p>99.01.2.000.00 only 99.80.2.000.00 only</p>	<p>99.02.2.000.00 only</p>	<p>DIODE MODULE (NON STANDARD POLARITY) Recovery diode modules are used for DC only. The reverse voltage peaks of the coil are short circuited by the recovery diode (positive to terminal A2). The release time increases by an approximate factor of 3. If an increase of the release time is undesirable use a Varistor or RC module.</p>
		<p>RC MODULE RC circuit modules are used for AC and DC coils. The reverse voltage peaks of the coil are limited by the RC module to approximately 2.5 times the nominal voltage of the supply. The relay release time increases insignificantly.</p>
		<p>RESIDUAL CURRENT BYPASS MODULE Bypass modules are advisable if 110 or 230v AC relays show any tendency to fail to release. Failure to release can be caused by residual currents from AC proximity switches or inductive coupling caused through long parallel lying AC control lines.</p>

A series of 25 horizontal dashed lines spanning the width of the page, intended for writing or drawing.

 **FINDER FRANCE Sarl**
Avenue d'Italie - BP 40
Zone Ind. du Pré de la Garde
F - 73302 ST. JEAN
DE MAURIENNE Cédex
Tel. +33/479/83 27 27
Fax +33/479/59 80 04
Finder.FR@findernet.com

 **S.P.R.L. FINDER BELGIUM B.V.B.A.**
Bloemendaal, 5
B - 1547 BEVER
Tel. +32/54/30 08 68
Fax +32/54/30 08 67
Finder.BE@findernet.com

 **FINDER RELAIS NEDERLAND B.V.**
Dukdalfweg 51
NL - 1041 BC AMSTERDAM
Tel. +31/20/615 65 57
Fax +31/20/617 89 92
Finder.NL@findernet.com

 **FINDER GmbH**
Eisenstrasse 30
D - 65428 RÜSSELSHEIM
Tel. +49/6142/8770
Fax +49/6142/87777
Finder.DE@findernet.com

 **FINDER RELAIS VERTRIEBS GmbH**
Aspangbahnstraße 2
A - 2361 LAXENBURG
Tel. +43/2236/86 41 36 - 0
Fax +43/2236/86 41 36 36
Finder.AT@findernet.com

 **FINDER CZ, s.r.o.**
Střížkovská 110/3
CZ - 180 00 PRAHA 8
Tel. +420/2 8688 9504
Fax +420/2 8688 9505
Finder.CZ@findernet.com

 **FINDER (SCHWEIZ) AG**
Industriestrasse, 1a
Postfach 23
CH - 8157 DIELSDORF (ZH)
Tel. +41/1/885 30 10
Fax +41/1/885 30 20
Finder.CH@finder-relais.ch

 **FINDER PLC**
Opal Way - Stone Business Park
STONE, STAFFORDSHIRE,
ST15 OSS - UK
Tel. +44/1785/818100
Fax +44/1785/815500
Finder.UK@findernet.com

 **FINDER AB**
Stationsvägen, 1
SE - 435 25 MÖLNLYCKE
Tel. +46/31/88 00 99
Fax +46/31/88 06 04
Finder.SE@findernet.com

 **FINDER ELECTRICA**
Poligono la Pobra L'Eliana S/N, parcela N° 4
46185 La Pobra de Vallbona (Valencia)
Dirección Postal Aptdo 197, 46183 La Eliana
Tel. +34-96 272 52 95
Fax +34-96 275 02 50
Ventas.ES@findernet.com

 **FINDER PORTUGAL, LDA**
R. Antero de Quental
Edifício Hermes N° 221 R/C Sala 17
P - 4455 - 586 - PERAFITA
Tel. 00/351/22 99 42 900
Tel. 00/351/22 99 42 901
Fax 00/351/22 99 42 902
Finder.PT@findernet.com

 **FINDER RELAYS, INC.**
4465 Commerce Drive, Suite: 103
Buford, GA 30518 - U.S.A.
Tel. +1/770/271-4431
Fax +1/770/271-7530
Finder.US@findernet.com

 **FINDER COMPONENTES LTDA.**
Rua Olavo Bilac, 315
Bairro Santo Antônio
São Caetano do Sul - São Paulo
CEP 09530-260 - BRASIL
Tel. +55/11/4227 1550
Fax +55/11/4227 4313
Finder.BR@findernet.com

 **finder®**
www.findernet.com



ISO 9001



ISO 14001

 **FINDER SpA**
Via Drubiaglio, 14
I - 10040 ALMESE (TO)
Tel. +39/011.9346211
Fax +39/011.9359079
Export@findernet.com

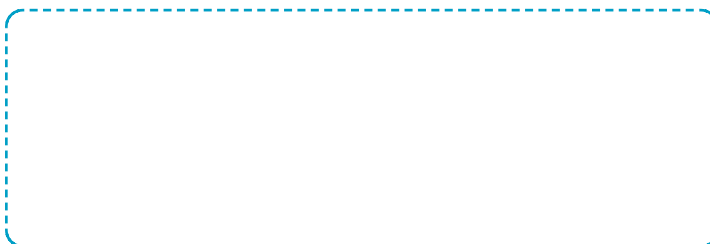

FINDER reserves the right to alter characteristics at any time without notice.
FINDER assumes no liability for damage to people or things, caused as a result
of the wrong use or application of its products.