

Circuit Breakers M4



D795E121

Page



Circuit-Breakers M4
for motor protection

2



Auxiliary contacts
Signalling switch
Auxiliary releases

3



Insulated 3-pole busbar system
Terminal block

4



DIN-rail adapters
Busbar adapters
Link modules
Contactors for Circuit-Breakers M4

5



Technical Data

6-11



Characteristics
Installation Accessories

12

13-14



Dimensions

15-20

Circuit Breakers M4 for Motor Control

Rated Current I_n	Suitable for motors ¹⁾ 3~400V kW	Setting range Thermal Overload Release	Instantaneous Short Circuit Release	Short Circuit Breaking Capacity at 3~400V kA (I_{cu})	Type	Pack pcs.	Weight approx. kg/pc.
A		A	A				

Circuit Breaker M4-32T-..



switch type

0,16	-	0,10 – 0,16	2,1	100	M4-32T-0,16	1	0,32
0,25	0,06	0,16 – 0,25	3,3	100	M4-32T-0,25	1	0,32
0,4	0,09	0,25 – 0,4	5,2	100	M4-32T-0,4	1	0,32
0,63	0,18	0,4 – 0,63	8,2	100	M4-32T-0,63	1	0,32
1	0,25	0,63 – 1	13	100	M4-32T-1	1	0,32
1,6	0,55	1 – 1,6	20,8	100	M4-32T-1,6	1	0,32
2,5	0,75	1,6 – 2,5	32,5	100	M4-32T-2,5	1	0,32
4	1,5	2,5 – 4	52	100	M4-32T-4	1	0,32
6	2,2	4 – 6	78	100	M4-32T-6	1	0,32
8	3	5 – 8	104	100	M4-32T-8	1	0,32
10	4	6 – 10	130	50	M4-32T-10	1	0,32
13	5,5	9 – 13	169	50	M4-32T-13	1	0,32
17	7,5	11 – 17	221	20	M4-32T-17	1	0,32
22	7,5	14 – 22	286	15	M4-32T-22	1	0,32
26	11	18 – 26	338	15	M4-32T-26	1	0,32
32	15	22 – 32	416	15	M4-32T-32	1	0,32

Circuit Breaker M4-32R-..



rotary type

0,16	-	0,10 – 0,16	2,1	100	M4-32R-0,16	1	0,36
0,25	0,06	0,16 – 0,25	3,3	100	M4-32R-0,25	1	0,36
0,4	0,09	0,25 – 0,4	5,2	100	M4-32R-0,4	1	0,36
0,63	0,18	0,4 – 0,63	8,2	100	M4-32R-0,63	1	0,36
1	0,25	0,63 – 1	13	100	M4-32R-1	1	0,36
1,6	0,55	1 – 1,6	20,8	100	M4-32R-1,6	1	0,36
2,5	0,75	1,6 – 2,5	32,5	100	M4-32R-2,5	1	0,36
4	1,5	2,5 – 4	52	100	M4-32R-4	1	0,36
6	2,2	4 – 6	78	100	M4-32R-6	1	0,36
8	3	5 – 8	104	100	M4-32R-8	1	0,36
10	4	6 – 10	130	100	M4-32R-10	1	0,36
13	5,5	9 – 13	169	100	M4-32R-13	1	0,36
17	7,5	11 – 17	221	50	M4-32R-17	1	0,36
22	7,5	14 – 22	286	50	M4-32R-22	1	0,36
26	11	18 – 26	338	50	M4-32R-26	1	0,36
32	15	22 – 32	416	50	M4-32R-32	1	0,36

Circuit Breaker M4-63R-..



rotary type

26	12,5	18 – 26	338	50	M4-63R-26	1	1,0
32	15	22 – 32	416	50	M4-63R-32	1	1,0
40	18,5	28 – 40	520	50	M4-63R-40	1	1,0
50	22	34 – 50	650	50	M4-63R-50	1	1,0
63	30	45 – 63	819	50	M4-63R-63	1	1,0

Circuit Breaker M4-100R-..



rotary type

63	30	45 – 63	819	50	M4-100R-63	1	2,2
75	37	55 – 75	975	50	M4-100R-75	1	2,2
90	45	70 – 90	1170	50	M4-100R-90	1	2,2
100	-	80 – 100	1300	50	M4-100R-100	1	2,2

1) Approximate values of standard motors

Accessories

Contacts	Rated Operational Current			Type	Pack	Weight approx.
	NO	NC	AC15 24V A			

Transverse Auxiliary Contact Block, max. 1 pc. per circuit-breaker ¹⁾



1	1		3	2	5	M4 HQ11	1	0,02
2	-		3	2	5	M4 HQ20	1	0,02
-	2		3	2	5	M4 HQ02	1	0,02

Auxiliary Contact Block for left hand side mounting, 1 or 2 pcs. per circuit-breaker ¹⁾



1	1		6	4	10	M4 HS11	1	0,03
2	-		6	4	10	M4 HS20	1	0,03
-	2		6	4	10	M4 HS02	1	0,03

Alarm Switch (any tripping) for left hand side mounting, max. 1 pc. per circuit-breaker ¹⁾



1	1		6	4	10	M4 MA11	1	0,04
---	---	--	---	---	----	---------	---	------

Alarm Switch (short circuit) for left hand side mounting, max. 1 pc. per circuit-breaker ¹⁾



1	1		6	4	10	M4 M11	1	0,04
---	---	--	---	---	----	--------	---	------

Undervoltage Releases for right hand side mounting, max. 1 pc. per circuit-breaker ¹⁾

Trips the circuit-breaker when the voltage is interrupted. Prevents the motor from being restarted accidentally when the voltage is restored, suitable for EMERGENCY STOP acc. to IEC 60204



24V 50Hz, 28V 60Hz		M4 U24	1	0,11
110-127V 50Hz, 120V 60Hz		M4 U110	1	0,11
220-230V 50Hz, 240-260V 60Hz		M4 U230	1	0,11
240V 50Hz, 277V 60Hz		M4 U240	1	0,11
380-400V 50Hz, 440-460V 60Hz		M4 U400	1	0,11
415-440V 50Hz, 460-480V 60Hz		M4 U415	1	0,11

Shunt Releases for right hand side mounting, max. 1 pc. per circuit-breaker ¹⁾

Trips the circuit-breaker when the release coil energized.

100% ON max. 5sec. ON



24V 50Hz, 28V 60Hz	20-70V 50/60Hz DC	M4 A24	1	0,12
110-127V 50Hz, 120V 60Hz		M4 A110	1	0,12
220-230V 50Hz, 240-260V 60Hz		M4 A230	1	0,12
240V 50Hz, 277V 60Hz		M4 A240	1	0,12
380-400V 50Hz, 440-460V 60Hz		M4 A400	1	0,12
415-440V 50Hz, 460-480V 60Hz		M4 A415	1	0,12





Enclosure for circuit breaker M4 32R protection degree IP65



Plastic enclose with rotary operating mechanism black-grey lockable, with N- and PE-terminal space for 1 transverse and side aux. contact + release	M4 32R PFH4	1	0,53
Enclose with rotary operating mechanism yellow - red, lockable with N- and PE-terminal space for 1 transverse and side aux. contact + release	M4 32R PFHN4	1	0,53

1) Number and position see page14

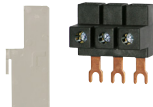
Accessories and Busbars

			for circuit- breaker	Type	Pack pcs.	Weight approx. kg/pc.
	Scale cover sealable	for covering the current setting scale	M4-32...100	M4 K	10	0,003
	Push-in lugs	for screwing the circuit-breaker onto mounting plates. 2 units required (1 bag with 10 units)	M4-32	M4 32 L	10	0,01
	Spade terminal block	up to 600V acc.UL 489	M4-32R	M4 32R E	on request	
	Pin terminal block	up to 600V acc.UL 489	M4-32R	M4 32R EV	on request	
	Insulation barriers	up to 600V acc.UL 489 for increased distances and clearances acc. to UL Type "E", 4 pcs per device (2 pcs on each side)	M4-100	M4 100 E	2	0,01

Door-coupling rotary mechanisms IP65



The door locking device prevents accidental opening of the cubicle door in the ON position of the circuit-breaker. The OFF position can be locked with up to 3 padlocks.

	Door-coupling rotary mechanism black	extension shaft 115mm	M4-32R	M4 32R EH1 115	1	0,1
		extension shaft 315mm	M4-32R	M4 32R EH1 315	1	0,2
		extension shaft 115mm	M4-63R	M4 63R EH1 115	1	0,1
		extension shaft 315mm	M4-63R	M4 63R EH1 315	1	0,2
		extension shaft 115mm	M4-100R	M4 100R EH1 115	1	0,1
		extension shaft 315mm	M4-100R	M4 100R EH1 315	1	0,2
	Emergency-Stop Door-coupling rotary mechanism; red/yellow	extension shaft 115mm	M4-32R	M4 32R EHN1 115	1	0,1
		extension shaft 315mm	M4-32R	M4 32R EHN1 315	1	0,2
		extension shaft 115mm	M4-63R	M4 63R EHN1 115	1	0,1
		extension shaft 315mm	M4-63R	M4 63R EHN1 315	1	0,2
		extension shaft 115mm	M4-100R	M4 100R EHN1 115	1	0,1
		extension shaft 315mm	M4-100R	M4 100R EHN1 315	1	0,2

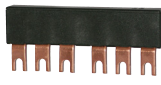

			Protection degree	Type	Pack pcs.	Weight kg/pc.
--	--	--	----------------------	------	--------------	------------------

Insulated 3-phase busbar system

For feeding several modular circuit-breakers M4-32. on standard mounting rails, insulated
Rated operational voltage max. 690 V, 63 A, with **spade connection**, modular spacing 45mm (54mm on request)

	3-phase busbars	for 2 circuit-breakers	IP20	M4 32 S2	1	0,03
		for 3 circuit-breakers	IP10	M4 32 S3	1	0,05
		for 4 circuit-breakers	IP10	M4 32 S4	1	0,07
		for 5 circuit-breakers	IP10	M4 32 S5	1	0,10
	Line side terminal	Conductor cross-section solid or stranded 6-25mm ² with end sleeve 4-16mm ²	IP10	M4 32 SE	1	0,04
	Cover for tags	Touch guard for emptyspaces		M4 32 SF	1	0,003

For feeding several modular circuit-breakers M4-32. on standard mounting rails, insulated
Rated operational voltage max. 690 V, 63 A, with **pin connection**, modular spacing 45mm (54mm on request)

	3-phase busbars	for 2 circuit-breakers	IP20	M4 32 S2V	1	0,03
		for 3 circuit-breakers	IP20	M4 32 S3V	1	0,05
		for 4 circuit-breakers	IP20	M4 32 S4V	1	0,07
		for 5 circuit-breakers	IP20	M4 32 S5V	1	0,10
	Line side terminal	Conductor cross-section solid or stranded 6-25mm ² with end sleeve 4-16mm ²	IP20	M4 32 SEV	1	0,04
	Cover for tags	Touch guard for emptyspaces		M4 32 SFV	1	0,003

For feeding several modular circuit-breakers M4-63. on standard mounting rails, insulated
Rated operational voltage max. 690 V, with **pin connection**, modular spacing 55mm

	3-phase busbars	for 2 circuit-breakers	IP20	M4 63 S2	1	0,15
--	-----------------	------------------------	------	----------	---	------

Mounting Parts for Fuseless Load Feeders

	Type	Pack pcs.	Weight approx. kg/pc.
DIN-rail adapters with DIN-rail for contactor			
	for M4-32.. DIN-rails moveable for easy mounting and replacing can be connected on one 35 mm DIN-rail (high 15mm) or two 35 mm-DIN-rails (125mm distance) suitable for contactors K1-..., K(G)3-10 to K(G)3-40	M4 32 HU1	1 0,1
	Adapter, for M4-63.. can be connected on two 35 mm DIN-rails (125mm distance) or one 75 mm DIN-rail, or screw mounting suitable for contactors K(G)3-24 to K(G)3-40, K3-50 to K3-74	M4 63 HU1	1 0,2
	Adapter, for M4-100.. can be connected on two 35 mm DIN-rails (125mm distance) or one 75 mm DIN-rail, or screw mounting suitable for contactors K3-50 to K3-74	M4 100 HU1	1 0,2

Busbar adapters for 60-mm-system, 3 copper busbars acc. to DIN 46433

	for M4-32 up to 32A, 690V 45mm width, 182mm long bar width: 12 und 15mm bar thickness: 5 and 10mm	M4 32 SA60	1 0,18
--	---	------------	--------

Link modules, for mechanical and electrical connection between circuit-breaker and contactor

	for M4-32.. with contactors K1-..	max. 32A	M4 32 VK1	1 0,015
	for M4-32.. with contactors K3-10 to K3-22	max. 32A	M4 32 VK3	1 0,02
	for M4-32.. with contactors KG3-10 to KG3-22	max. 32A	M4 32 VKG3	1 0,02

Link modules, for electrical connection between circuit-breaker and contactor

for M4-32.. with contactors K(G)3-24to K(G)3-40	max. 32A	M4 32 VD	1 0,01
for M4-63R. with contactors K3-24 to K3-74	max. 63A	M4 63 VD	1 0,02
for M4-63R. with contactors KG3-24 to KG3-40	max. 63A	M4 63 VDG	1 0,02
for M4-100R. with contactors K3-50 to K3-74	max. 100A	M4 100 VD	1 0,02

Components for Fuseless Load Feeders, DIN-Rail Mounting

Type of coordination "1" 3x415V 10kA¹⁾



Motor 3~400V kW	Setting range A	Circuit-breaker page 2 Type	Link module Type	Contactor ²⁾ 220-230V 50Hz Type	DIN-rail adapter Type
-	0,10 – 0,16	M4-32T-0,16	M4 32 VK1	K1-09D10 230	-
0,06	0,16 – 0,25	M4-32T-0,25	M4 32 VK1	K1-09D10 230	-
0,09	0,25 – 0,4	M4-32T-0,4	M4 32 VK1	K1-09D10 230	-
0,18	0,4 – 0,63	M4-32T-0,63	M4 32 VK1	K1-09D10 230	-
0,25	0,63 – 1	M4-32T-1	M4 32 VK1	K1-09D10 230	-
0,55	1,0 – 1,6	M4-32T-1,6	M4 32 VK1	K1-09D10 230	-
0,75	1,6 – 2,5	M4-32T-2,5	M4 32 VK1	K1-09D10 230	-
1,5	2,5 – 4	M4-32T-4	M4 32 VK1	K1-09D10 230	-
2,2	4 – 6	M4-32T-6	M4 32 VK1	K1-09D10 230	-
3	5 – 8	M4-32T-8	M4 32 VK1	K1-09D10 230	-
4	6 – 10	M4-32T-10	M4 32 VK1	K1-09D10 230	-
5,5	9 – 13	M4-32T-13	M4 32 VK1	K1-12D10 230	-
7,5	11 – 17	M4-32T-17	M4 32 VK3	K3-18ND10 230EUR	-
7,5	14 – 22	M4-32T-22	M4 32 VK3	K3-22ND10 230EUR	-
11	18 – 26	M4-32T-26	M4 32 VK3	K3-22ND10 230EUR	-
15	22 – 32	M4-32T-32	M4 32 VD	K3-32A00 230	M4 32 HU1
-	0,10 – 0,16	M4-32R-0,16	M4 32 VK3	K3-10ND10 230EUR	-
0,06	0,16 – 0,25	M4-32R-0,25	M4 32 VK3	K3-10ND10 230EUR	-
0,09	0,25 – 0,4	M4-32R-0,4	M4 32 VK3	K3-10ND10 230EUR	-
0,18	0,4 – 0,63	M4-32R-0,63	M4 32 VK3	K3-10ND10 230EUR	-
0,25	0,63 – 1	M4-32R-1	M4 32 VK3	K3-10ND10 230EUR	-
0,55	1,0 – 1,6	M4-32R-1,6	M4 32 VK3	K3-10ND10 230EUR	-
0,75	1,6 – 2,5	M4-32R-2,5	M4 32 VK3	K3-10ND10 230EUR	-
1,5	2,5 – 4	M4-32R-4	M4 32 VK3	K3-10ND10 230EUR	-
2,2	4 – 6	M4-32R-6	M4 32 VK3	K3-10ND10 230EUR	-
3	5 – 8	M4-32R-8	M4 32 VK3	K3-10ND10 230EUR	-
4	6 – 10	M4-32R-10	M4 32 VK3	K3-10ND10 230EUR	-
5,5	9 – 13	M4-32R-13	M4 32 VK3	K3-14ND10 230EUR	-
7,5	11 – 17	M4-32R-17	M4 32 VK3	K3-18ND10 230EUR	-
7,5	14 – 22	M4-32R-22	M4 32 VK3	K3-22ND10 230EUR	-
11	18 – 26	M4-32R-26	M4 32 VK3	K3-22ND10 230EUR	-
15	22 – 32	M4-32R-32	M4 32 VD	K3-32A00 230	M4 32 HU1
12,5	18 – 26	M4-63R-26	M4 63 VD	K3-32A00 230	M4 63 HU1
15	22 – 32	M4-63R-32	M4 63 VD	K3-32A00 230	M4 63 HU1
18,5	28 – 40	M4-63R-40	M4 63 VD	K3-40A00 230	M4 63 HU1
22	34 – 50	M4-63R-50	M4 63 VD	K3-50A00 230	M4 63 HU1
30	45 – 63	M4-63R-63	M4 63 VD	K3-62A00 230	M4 63 HU1
30	45 – 63	M4-100R-63	M4 100 VD	K3-62A00 230	M4 100 HU1
37	55 – 75	M4-100R-75	M4 100 VD	K3-74A00 230	M4 100 HU1
45	70 – 90	M4-100R-90	-	K3-90A00 230	-
-	80 – 100	M4-100R-100	-	K3-115A00 230	-

1) Other conditions on request

2) Contactors K1.. 220-230V 50Hz, Contactors K3.. 220-240V 50Hz, further technical data see Catalog D677..

Technical Data according to IEC/EN 60947-1, 60947-2, 60947-4-1 and VDE 0660

This table shows the rated ultimate short-circuit breaking capacity I_{cu} and the rated service short-circuit breaking capacity I_{cs} of the M4 circuit-breakers with different operational voltages as a function of the rated current I_n of the circuit-breakers. The circuit-breakers can be fed at the top or bottom supply terminals without any reduction of the rated data.

If the short-circuit current exceeds the rated short-circuit breaking capacity of the circuit-breaker specified in the tables at the installation point, a back-up fuse is to be used. The maximum rated current for the back-up fuse is specified in the tables. These fuses are only suitable for the short-circuit-currents as indicated on the fuses.

Circuit-breaker	Rated current I_n	up to AC 240V ²⁾			up to AC 400V ²⁾ up to AC 415V ³⁾			up to AC 440V ²⁾ up to AC 460V ³⁾			up to AC 500V ²⁾ up to AC 525V ³⁾			up to AC 690V ²⁾			
		I_{cu}	I_{cs}	max. fuse ¹⁾ (gL/gG)	I_{cu}	I_{cs}	max. fuse ¹⁾ (gL/gG)	I_{cu}	I_{cs}	max. fuse ¹⁾ (gL/gG)	I_{cu}	I_{cs}	max. fuse ¹⁾ (gL/gG)	I_{cu}	I_{cs}	max. fuse ¹⁾ (gL/gG)	
Type	A	kA	kA	A	kA	kA	A	kA	kA	A	kA	kA	A	kA	kA	A	
M4-32T	0,16 ... 0,63	100	100	--	100	100	--	100	100	--	100	100	--	100	100	--	
	1	100	100	--	100	100	--	100	100	--	100	100	--	100	100	--	
	1,6	100	100	--	100	100	--	100	100	--	100	100	--	3	3	20	
	2,5	100	100	--	100	100	--	100	100	--	50	38	50	3	3	35	
	4	100	100	--	100	100	--	50	38	50	15	11	40	3	3	40	
	6	100	100	--	100	100	--	15	11	50	10	8	40	3	3	50	
	8	100	100	--	100	100	--	15	11	63	10	8	63	3	3	63	
	10	100	100	--	50	38	80	15	11	63	6	5	63	3	3	63	
	13	100	100	--	50	38	80	10	8	80	6	5	80	3	3	63	
	17	50	38	--	20	15	100	10	8	80	6	5	80	3	3	63	
	22	40	30	125	15	11	100	8	6	100	6	5	80	3	3	63	
	26	40	30	125	15	11	100	8	6	100	6	5	80	3	3	63	
	32	30	22	125	15	11	100	6	4	100	5	4	80	3	3	63	
	M4-32R	0,16 ... 1,0	100	100	--	100	100	--	100	100	--	100	100	--	100	100	--
1,6		100	100	--	100	100	--	100	100	--	100	100	--	100	100	--	
2,5		100	100	--	100	100	--	100	100	--	100	100	--	8	8	35	
4		100	100	--	100	100	--	100	100	--	100	100	--	8	8	40	
6		100	100	--	100	100	--	100	100	--	100	100	--	6	6	50	
8		100	100	--	100	100	--	50	38	80	50	38	63	6	6	63	
10		100	100	--	100	100	--	50	38	80	50	38	80	6	6	63	
13		100	100	--	100	100	--	50	38	80	42	32	80	6	6	63	
17		100	100	--	50	38	100	20	15	80	10	8	80	4	4	63	
22		100	100	--	50	38	125	20	15	100	10	8	80	4	4	63	
26		100	100	--	50	38	125	20	15	100	10	8	80	4	4	63	
32		100	100	--	50	38	125	20	15	100	10	8	80	4	4	63	
M4-63R		26	100	100	--	50	50	125	35	27	125	12	9	100	5	5	80
		32	100	100	--	50	50	125	35	27	125	10	8	100	5	5	80
	40	100	100	--	50	50	160	35	27	125	10	8	100	5	5	80	
	50	100	100	--	50	50	160	35	27	125	10	8	100	5	5	80	
	63	100	100	--	50	50	160	35	27	160	10	8	100	5	5	80	
	M4-100R	63	100	100	--	50	38	160	40	30	160	12	9	100	6	5	80
75		100	100	--	50	38	160	40	30	160	8	6	125	5	4	100	
90		100	100	--	50	38	160	40	30	160	8	6	125	5	4	125	
100		100	100	--	50	38	160	40	30	160	8	6	125	5	4	125	

-- No back-up fuse required

1) Back up fuse required if short-circuit current at installation point > I_{cu}

2) 10 % overvoltage



3) 5 % overvoltage

Technical Data according to IEC/EN 60947-1, 60947-2, 60947-4-1 and VDE 0660

Main Circuit

Type		M4-32T	M4-32R	M4-63R	M4-100R
Number of poles		3	3	3	3
Max. rated current I_{nmax} (=max. rated operational current I_e)	A	32	32	63	100
Permissible ambient temperature					
Storage/transport	°C	-50 to +80	-50 to +80	-50 to +80	-50 to +80
Operation	°C	-20 to +60	-20 to +60	-20 to +60	-20 to +60
Storage/transport	°F	-58 to +176	-58 to +176	-58 to +176	-58 to +176
Operation	°F	-4 to +140	-4 to +140	-4 to +140	-4 to +140
Rated insulation voltage U_i	V	690 ¹⁾	690 ¹⁾	1000 ²⁾	1000 ²⁾
Rated impulse withstand voltage U_{imp}	kV	6	6	8	8
Rated operational voltage U_e	V	690	690	690	690
Rated frequency	Hz	50/60	50/60	50/60	50/60
Utilization category					
IEC 60947-2 (circuit-breaker)		A	A	A	A
IEC 60947-4-1 (motor starter)		AC3	AC3	AC3	AC3
Class	acc. to IEC 60947-4-1	10	10	10	10
Power loss P_V per circuit-breaker	$I_n \rightarrow$ up to 4 A	W	9,8	9,8	-
dependent on rated current I_n	$I_n \rightarrow$ 6 up to 26 A	W	8	8	-
(upper setting range)	$I_n \rightarrow$ 32 A	W	3,9	3,9	-
R per conducting path = $P/I^2 \times 3$	$I_n \rightarrow$ 26 up to 63 A	W	-	-	12,6
	$I_n \rightarrow$ up to 63 A	W	-	-	11,9
	$I_n \rightarrow$ 75 up to 100 A	W	-	-	15
Shock resistance	acc. to IEC 60068 Part 2-27	g	25	25	25
Degree of protection	acc. to IEC 60529		IP 20	IP 20	IP 20
Shock hazard protection	acc. to DIN VDE 0106 Part 100		safe against finger touch	safe against finger touch	safe against finger touch
Temperature compensation	acc. to IEC 60947-4-1	°C	-20 to +60	-20 to +60	-20 to +60
Mechanical endurance	operating cycles		100 000	100 000	50 000
Electrical endurance			100 000	100 000	25 000
Max. operating frequency per hour (motor starts) 1/h		25	25	25	25

Approvals





Country	USA, Canada UL	Switzerland SEV	Europe	CB/CCA- Certificates
Type				
M4-32T	o	o	/	o
M4-32R	o	o	/	o
M4-63R	o	o	/	o
M4-100R	o	o	/	o
M4 H..	o	-	/	-
M4 M..	o	-	/	-
M4 U..	o	-	/	-
M4 A..	o	-	/	-

o In standard version approved / No testing required CE x In test
 - Not provided for test till now

1) Suitable at 690V for: earthed-neutral systems, overvoltage category I to IV, pollution degree 3 (standard-industry): $U_{imp} = 6kV$.
 2) Suitable at 1000V for: earthed-neutral systems, overvoltage category I to IV, pollution degree 3 (standard-industry): $U_{imp} = 8kV$.
 Data for other conditions on request.

Technical Data according to IEC/EN 60947-1, 60947-2, 60947-4-1 and VDE 0660

Conductor cross-sections for main circuit

Type		M4-32T	M4-32R	M4-63R	M4-100R
Terminal type, screw type		Pz2 	Pz2 	Pz2 	4mm hexagon socket screw 
Tightening torque	Nm lb-in	0,8 to 2,5 7 to 22	0,8 to 2,5 7 to 22	3 to 4,5 26 to 39	4 to 6 35 to 53
Conductor cross-sections solid	mm ²	1 x (1 to 10)	1 x (1 to 10)	1 x (0,75 to 35)	1 x (2,5 to 70)
	mm ²	2 x (1 to 6)	2 x (1 to 6)	2 x (0,75 to 25)	2 x (2,5 to 50)
	AWG	1 x (18 to 8)	1 x (18 to 8)	1 x (18 to 2)	1 x (12 to 2/0)
	AWG	2 x (18 to 10)	2 x (18 to 10)	2 x (18 to 4)	2 x (12 to 1/0)
stranded	mm ²	1 x (1 to 6)	1 x (1 to 6)	1 x (0,75 to 35)	1 x (2,5 to 70)
	mm ²	2 x (1 to 6)	2 x (1 to 6)	2 x (0,75 to 25)	2 x (2,5 to 50)
	AWG	1 x (18 to 10)	1 x (18 to 10)	1 x (18 to 2)	1 x (12 to 2/0)
	AWG	2 x (18 to 10)	2 x (18 to 10)	2 x (18 to 4)	2 x (12 to 1/0)
flexible	mm ²	1 x (1 to 6)	1 x (1 to 6)	1 x (0,75 to 25)	1 x (2,5 to 50)
	mm ²	2 x (0,75 to 4)	2 x (0,75 to 4)	2 x (0,75 to 16)	2 x (2,5 to 35)
	AWG	1 x (18 to 10)	1 x (18 to 10)	1 x (18 to 4)	1 x (12 to 1/0)
	AWG	2 x (18 to 10)	2 x (18 to 10)	2 x (18 to 6)	2 x (10 to 2)

Auxiliary switches

Aux. Type	Switching capacity			Control voltage			
M4 HQ..	Front transverse auxiliary switch						
	Rated operational voltage Ue	AC	V	24	240		
	Rated operational current Ie/AC-15		A	3	3		
	Rated operational current Ie/AC-12 Ith		A	5	5		
	Rated operational voltage Ue	DC L/R 200 ms	V	24	220		
	Rated operational current Ie/DC-13		A	1	0,1		
M4 HS..	Lateral auxiliary switch and signalling switch						
M4 M..	Rated operational voltage Ue			AC	V	24	240
	Rated operational current Ie/AC-15				A	6	4
	Rated operational current Ie/AC-12 Ith				A	10	10
	Rated operational voltage Ue			DC L/R 200 ms	V	24	220
Rated operational current Ie/DC-13				A	2	0,25	
M4 U..	Undervoltage release	Power consumption	during pick-up	V/A/W	8,5/6		
			uninterrupted duty	V/A/W	3/1,2		
		Response voltage	trip	V	0,7 to 0,35 × Us		
			pick-up	V	0,85 to 1,1 × Us		
M4 A..	Shunt release	Power consumption during pick-up		V/A/W	8,5/6		
				V/A/W	3/1,2		
		Response voltage acc. to IEC 60947-1, trip		V	0,7 to 1,1 × Us		
Short-circuit protection for auxiliary and control circuits							
		Fuse	gL/gG	A	10		
		Miniature circuit breaker C-characteristic		A	6		
Conductor cross-sections for auxiliary and control circuits							
		solid	mm ²	1 x (0,5 bis 2,5) / 2x (0,5 bis 2,5) ¹⁾			
		flexible	mm ²	1 x (0,5 to 4) / 2 x (0,75 to 2,5)			
		AWG-wires, solid	AWG	1 x (20 bis 14) / 2 x (20 bis 14) ¹⁾			
		flexible	AWG	1 x (20 to 10) / 2 x (18 to 14)			

1) M4 HQ.. 1 solid conductor only

Permissible ratings of devices approved for North America

Circuit breakers M4 as „Manual Motor Starter“

If used as „Manual Motor Starter“ the circuit breaker is always operated in combination with a short circuit device. For use with approbated fuses or circuit breakers according to UL489 or CSA22.2 No. 5 only. The sizes are selected according to National Electrical Code (UL), or Canadian Electrical Code (CSA).

M4-32T

Rated operational current le	A	0.16	0.25	0.4	0.63	1	1.6	2.5	4	6	8	10	13	17	22	26	32
Max. short-circuit current																	
240V	kA	100	100	100	100	100	100	100	100	100	100	50	50	40	30	30	20
480V	kA	50	50	50	50	50	50	50	50	25	25	10	10	10	10	7,5	7,5
600V	kA	10	10	10	10	10	10	10	5	5	5	5	5	5	5	5	5
Motor load																	
1-phase																	
115V	HP	-	-	-	-	-	-	-	1/8	1/4	1/3	1/2	1/2	1	1 1/2	2	2
230V	HP	-	-	-	-	-	1/10	1/6	1/3	1/2	1	1 1/2	2	3	3	3	5
3-phase																	
200V	HP	-	-	-	-	-	-	1/2	3/4	1	2	2	3	3	5	7 1/2	7 1/2
230V	HP	-	-	-	-	-	-	1/2	3/4	1 1/2	2	3	3	5	7 1/2	7 1/2	10
460V	HP	-	-	-	-	-	3/4	1	2	3	5	5	7 1/2	10	15	15	20
600V	HP	-	-	-	-	1/2	3/4	1 1/2	3	5	5	7 1/2	10	15	20	20	30
Max. rated fuse	A	1	1	1	1	3	6	10	15	20	30	40	50	60	80	100	125
Max. breaker size	A	15	15	15	15	15	15	15	15	20	30	40	50	60	80	100	125

M4-32R

Rated operational current le	A	0.16	0.25	0.4	0.63	1	1.6	2.5	4	6	8	10	13	17	22	26	32
Max. short-circuit current																	
240V	kA	100	100	100	100	100	100	100	100	100	100	100	100	100	100	100	100
480V	kA	50	50	50	50	50	50	50	50	50	50	50	50	30	30	30	30
600V	kA	10	10	10	10	10	10	10	10	10	10	10	10	10	10	10	10
Motor load																	
1-phase																	
115V	HP	-	-	-	-	-	-	-	1/8	1/4	1/3	1/2	1/2	1	1 1/2	2	2
230V	HP	-	-	-	-	-	1/10	1/6	1/3	1/2	1	1 1/2	2	3	3	3	5
3-phase																	
200V	HP	-	-	-	-	-	-	1/2	3/4	1	2	2	3	3	5	7 1/2	7 1/2
230V	HP	-	-	-	-	-	-	1/2	3/4	1 1/2	2	3	3	5	7 1/2	7 1/2	10
460V	HP	-	-	-	-	-	3/4	1	2	3	5	5	7 1/2	10	15	15	20
600V	HP	-	-	-	-	1/2	3/4	1 1/2	3	5	5	7 1/2	10	15	20	20	30
Max. rated fuse	A	1	1	1	1	3	6	10	15	20	30	40	50	60	80	100	125
Max. breaker size	A	15	15	15	15	15	15	15	15	20	30	40	50	60	80	100	125

M4-63R

Rated operational current le	A	26	32	40	50	63
Max. short-circuit current						
240V	kA	100	100	100	100	100
480V	kA	50	50	50	50	50
600V	kA	10	10	10	10	10
Motor load						
1-phase						
115V	HP	2	2	3	5	5
230V	HP	3	5	7 1/2	10	10
3-phase						
200V	HP	7 1/2	7 1/2	10	15	20
230V	HP	7 1/2	10	10	15	20
460V	HP	15	20	30	30	40
600V	HP	20	30	30	40	60
Max. rated fuse	A	100	125	150	200	250
Max. breaker size	A	100	125	150	200	250

M4-100R

Rated operational current le	A	63	75	90	100
Max. short-circuit current					
240V	kA	100	100	100	100
480V	kA	25	25	25	25
600V	kA	10	10	10	10
Motor load					
1-phase					
115V	HP	5	5	7 1/2	10
230V	HP	10	15	20	20
3-phase					
200V	HP	20	20	25	30
230V	HP	20	25	30	30
460V	HP	40	50	60	75
600V	HP	60	60	75	100
Max. rated fuse	A	250	300	350	400
Max. breaker size	A	250	300	350	400

Permissible ratings of devices approved for North America

Circuit breakers M4 as „Combination Motor Controller Type E“ and "Suitable for Group Installation"

Acc to UL508 demands a line-side 1 inch air and 2 inch creepage distance for „Combination Motor Controller Type E“ is necessary. Therefor circuit-breaker M4-32R is approved to UL 508 in combination with the Terminal block M4 32R E. Circuit-breakers M4-100 are approved to UL 508 in combination with the insulation barriers M4 100 E. According to CSA these terminal blocks can be omitted when the device is used as „Combination Motor Controller Type E“.

M4-32R (+M4 32R E)

Rated operational current I _e	A	0.16	0.25	0.4	0.63	1	1.6	2.5	4	6	8	10	13	17	22	26	32
Max. short-circuit current																	
240V	kA	100	100	100	100	100	100	100	100	100	100	100	100	100	100	100	100
480V	kA	50	50	50	50	50	50	50	50	50	50	50	50	30	30	30	30
600V	kA	25	25	25	25	25	25	25	25	25	25	25	25	10	10	10	10
Motor load																	
1-phase																	
115V	HP	-	-	-	-	-	-	-	1/8	1/4	1/3	1/2	1/2	1	1 1/2	2	2
230V	HP	-	-	-	-	-	1/10	1/6	1/3	1/2	1	1 1/2	2	3	3	5	5
Motor load																	
3-phase																	
200V	HP	-	-	-	-	-	-	1/2	3/4	1	2	2	3	3	5	7 1/2	7 1/2
230V	HP	-	-	-	-	-	-	1/2	3/4	1 1/2	2	3	3	5	7 1/2	7 1/2	10
460V	HP	-	-	-	-	-	3/4	1	2	3	5	5	7 1/2	10	15	15	20
600V	HP	-	-	-	-	1/2	3/4	1 1/2	3	5	5	7 1/2	10	15	20	20	30
Max. rated fuse or breaker																	
	A	500	500	500	500	500	500	500	500	500	500	500	500	500	500	500	500

M4-63R

Rated operational current I _e	A	26	32	40	50	63
Max. short-circuit current						
240V	kA	100	100	100	100	100
480V	kA	50	50	50	50	50
600V	kA	10	10	10	10	10
Motor load						
1-phase						
115V	HP	2	2	3	5	5
230V	HP	3	5	7 1/2	10	10
Motor load						
3-phase						
200V	HP	7 1/2	7 1/2	10	15	20
230V	HP	7 1/2	10	10	15	20
460V	HP	15	20	30	30	40
600V	HP	20	30	30	40	60
Max. rated fuse or breaker						
	A	600	600	600	600	600

M4-100R (+M4 100 E)

Rated operational current I _e	A	63	75	90	100
Max. short-circuit current					
240V	kA	100	100	100	100
480V	kA	40	40	40	40
600V	kA	10	10	10	10
Motor load					
1-phase					
115V	HP	5	5	7 1/2	10
230V	HP	10	15	20	20
Motor load					
3-phase					
200V	HP	20	20	25	30
230V	HP	20	25	30	30
460V	HP	40	50	60	75
600V	HP	60	60	75	100
Max. rated fuse or breaker					
	A	1000	1000	1000	1000

Ratings of auxiliary switches and alarm switches

		Lateral auxiliary switch M4 HS.. and signalling switch M4 M..	Transversal auxiliary switch M4 HQ..
Breaking capacity	AC	A600	A300
	DC	Q300	R300
Rated operational voltage	max.V AC	600	240
Rated operational current	A	10	5

Description

Releases

Circuit-breakers M4 are equipped with bimetallic-based, inverse-time delayed overload releases and with instantaneous overcurrent releases (electromagnetic short-circuit releases). The overload releases can be set in accordance with the load current. The overcurrent releases are permanently set to a value 13 times the rated current and thus enable trouble-free start-up of motors. The scale cover can be sealed to prevent unauthorized adjustments to the set current.

Operating mechanisms

Circuit-breakers M4-32T are actuated via a rocker operating mechanism and circuit-breakers M4-32R, M4-63R and M4-100R via a rotary operating mechanism. An electrical signal can be output, at all Circuit-breakers, via a signalling switch to indicate that the Circuit-breaker has tripped. All operating mechanisms can be locked in the 0 position with a padlock (shackle diameter 3.5 to 4.5 mm). The M4 Circuit-breakers fulfil the isolation characteristics specified in IEC 60947-2.

Operating conditions

Circuit-breakers M4 are suitable for use in any climate. To avoid error tripping we recommend to protect the Circuit Breakers M4 against fresh and cold air (caused by air condition etc.) They are designed for operation in enclosed rooms under normal conditions (e. g. no dust, corrosive vapours or harmful gases). Suitable enclosures must be provided for installation in dusty or damp rooms. Circuit-breakers M4 can also be fed from below. In order to prevent premature tripping due to phase failure sensitivity, the three conducting paths must always be uniformly loaded. The conducting paths must be connected in series in the case of single-phase loads.

Short-circuit protection

The short-circuit releases of M4 circuit-breakers disconnect the faulty load feeder from the system in the event of a short circuit and thus prevent any further damage from being caused. Circuit-breakers with a short-circuit breaking capacity of 50 kA or 100 kA at a voltage of 400 V AC are practically short-circuit-proof at this voltage, as higher short-circuit currents are not usually encountered at the installation point. Back-up fuses are only necessary if the short-circuit current at the installation point exceeds the rated ultimate short-circuit breaking capacity of the circuit-breakers.

Motor protection

The tripping characteristics of M4 circuit-breakers are designed mainly to protect three-phase induction motors. The circuit-breakers are therefore also referred to as Manual Motor Starters. The current of the motor to be protected is set with the aid of the scale.

Line protection

M4 Circuit-breakers for motor protection are also suitable for line protection. The M4 Circuit-breakers fulfil the isolation conditions of IEC 60 947-3 as well as the additional test conditions for circuit-breakers with isolation characteristics specified in IEC 60947-2.

Taking IEC 60 204-1 into consideration, they can thus be implemented as main and EMERGENCY STOP switches. Door-coupling rotary operating mechanism do not fulfil the isolation characteristics.

Tripping-Characteristics

M4-32

M4-63R, M4-100R

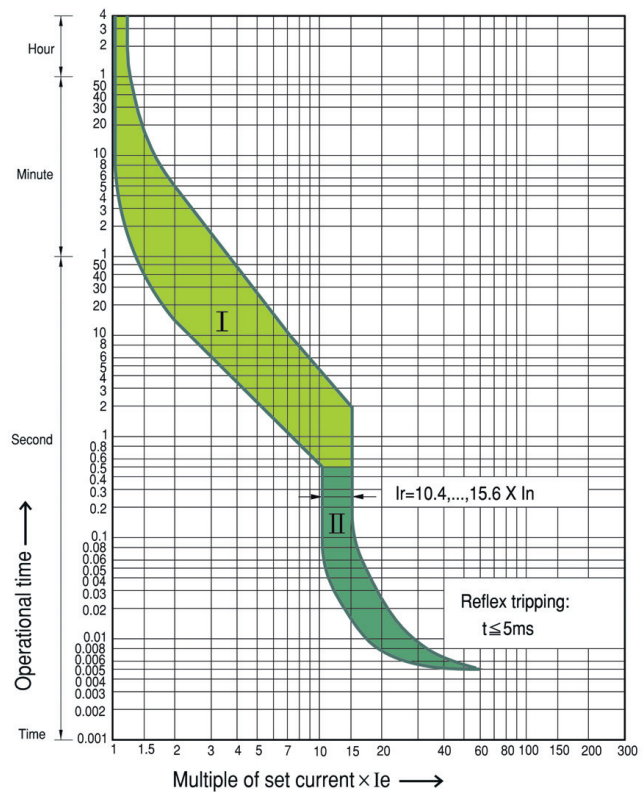
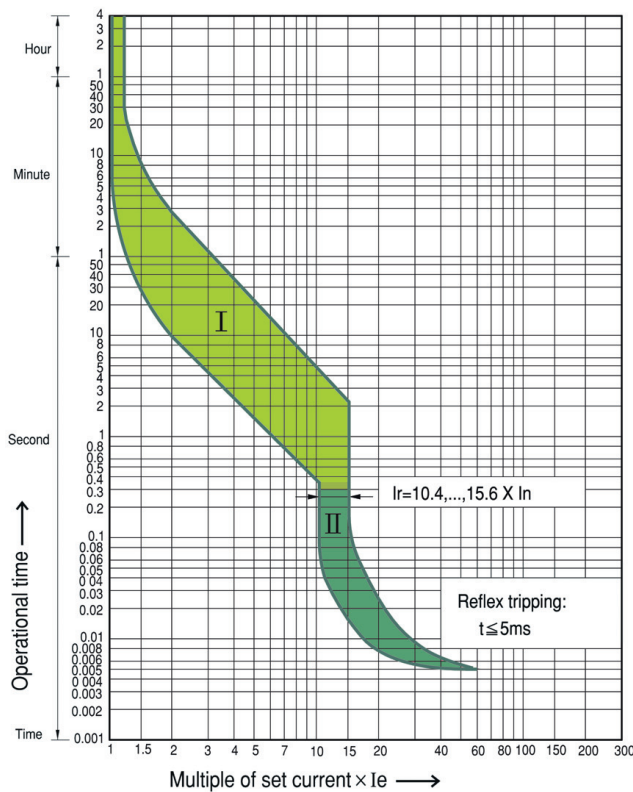

- I The curve shows the mean operating current at an ambient temperature of 20°C starting from cold.
- II The tripping characteristic of electromagnetic overcurrent releases (short-circuit releases)

The tripping characteristic of the inverse-time delayed overload releases apply for DC and AC with a frequency of 0 to 400 Hz. At operating temperature, the tripping times of the thermal releases are reduced to approximately 25 %.

The characteristic shown here is a schematic representation of circuit-breakers for all ranges. Current limiting characteristics and I²t characteristics are available on request.

Mounting

DIN-rail mounting

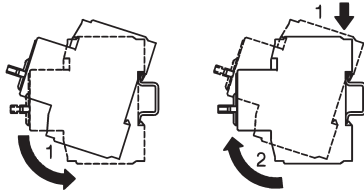

Operating positions

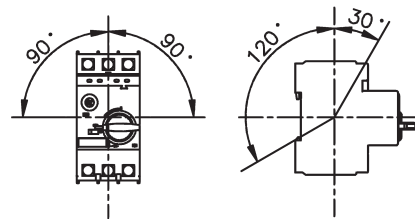

Current setting (dont rotate the dial out of the shown range)

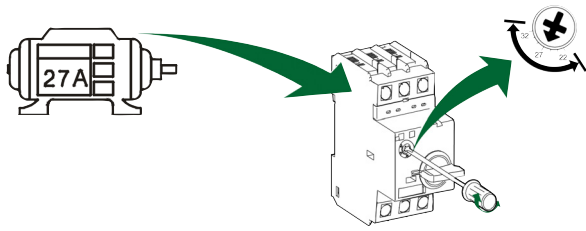

Connection of 1-phase motor

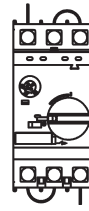

Wiring diagrams

Circuit breaker

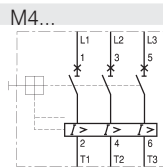

Traverse Aux. Contact Block

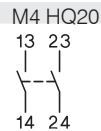
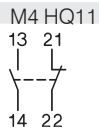

Aux. Contact Block (side mounted)

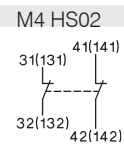
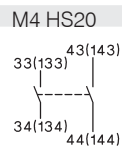
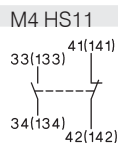

Alarm Switch

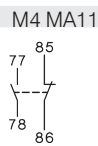
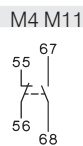

Undervoltage Release

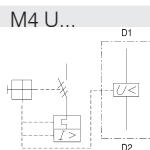

Shunt Release

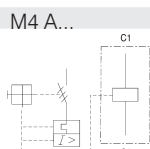

Installation of Accessories

- M4-32T
- M4-32R

Summary of Side-mounting

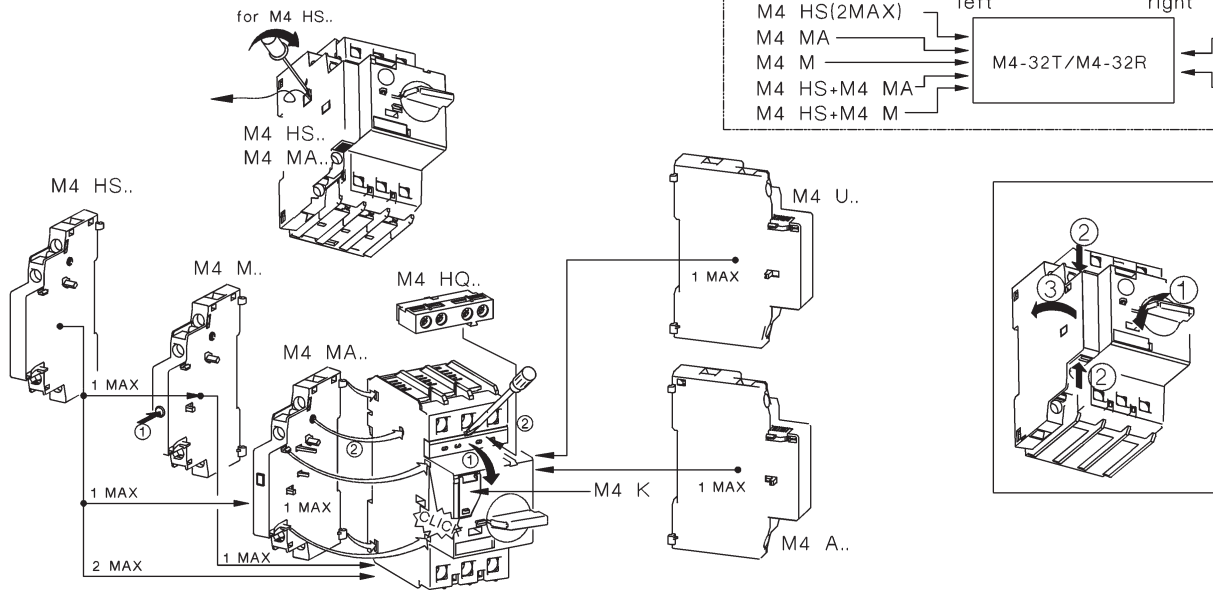
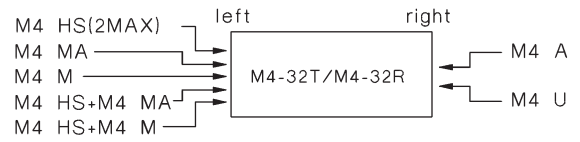

- M4-63R
- M4-100R

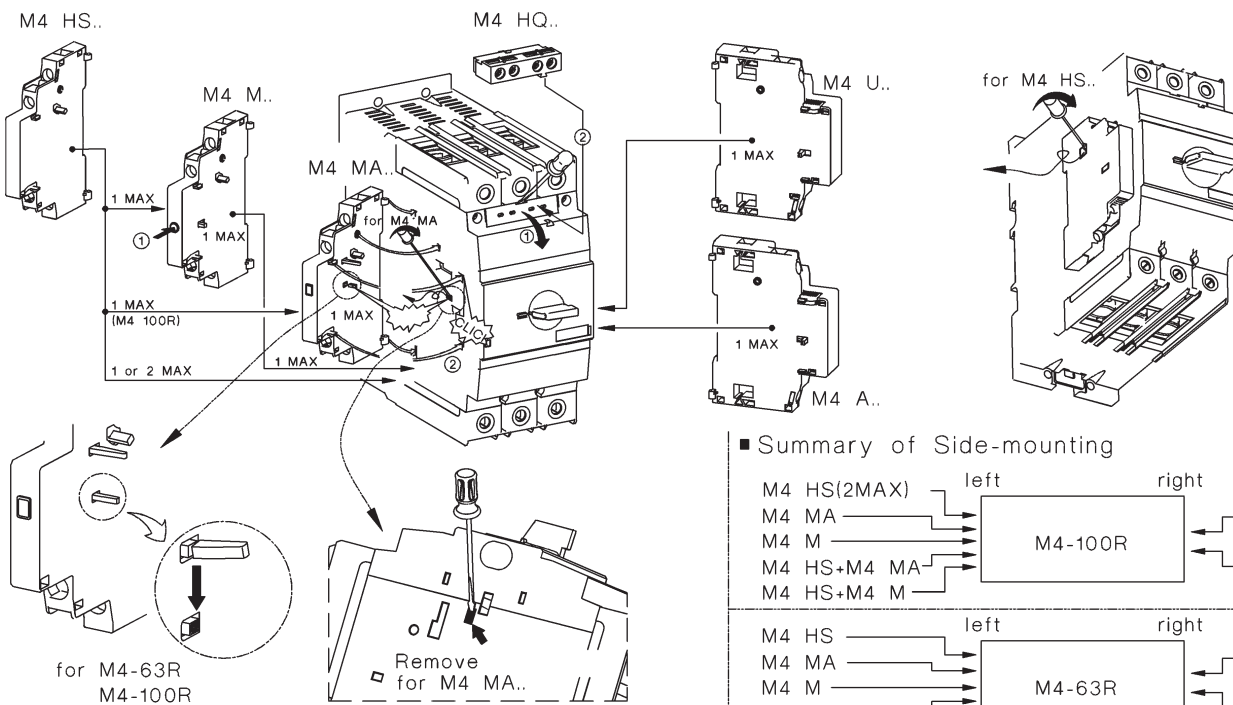

Summary of Side-mounting

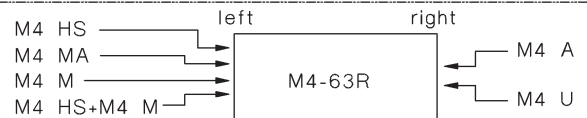
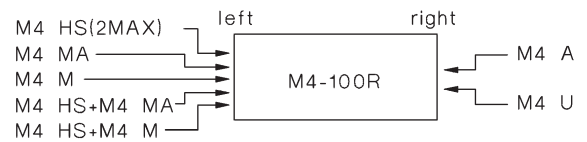

Dimensions

Circuit-breaker M4-32T

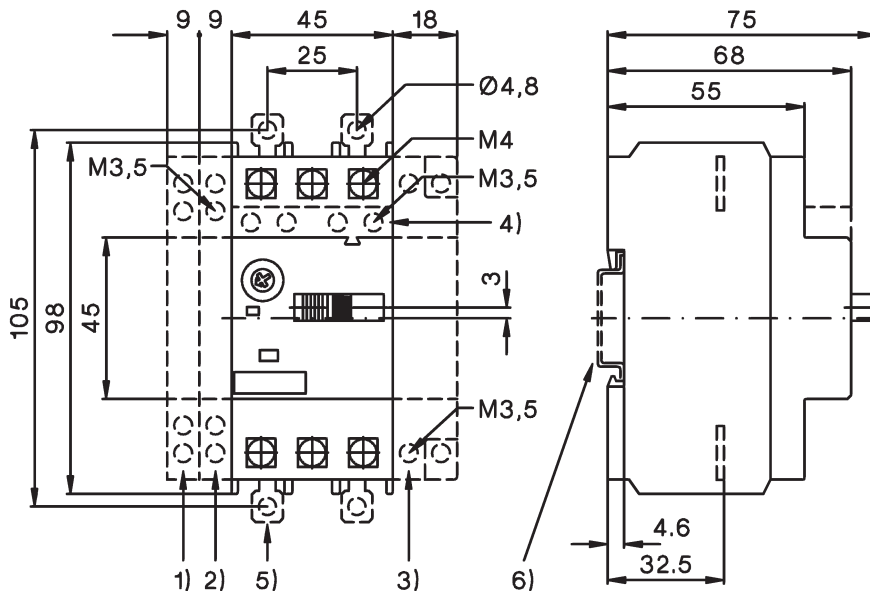

- 1) Side aux. contact
- 2) Magnetic trip alarm
- 3) Shunt or undervoltage release of arcing
- 4) Transverse aux. contact
- 5) Push-in Lugs for screw mounting
- 6) 35mm DIN-rail acc. to EN 50022

Height of arcing spaces (clearance from earthed parts)

at U _e (V)	240	415	460	525	690
mm	20	20	20	20	20
inch	0,8	0,8	0,8	0,8	0,8

Circuit-breaker M4-32R

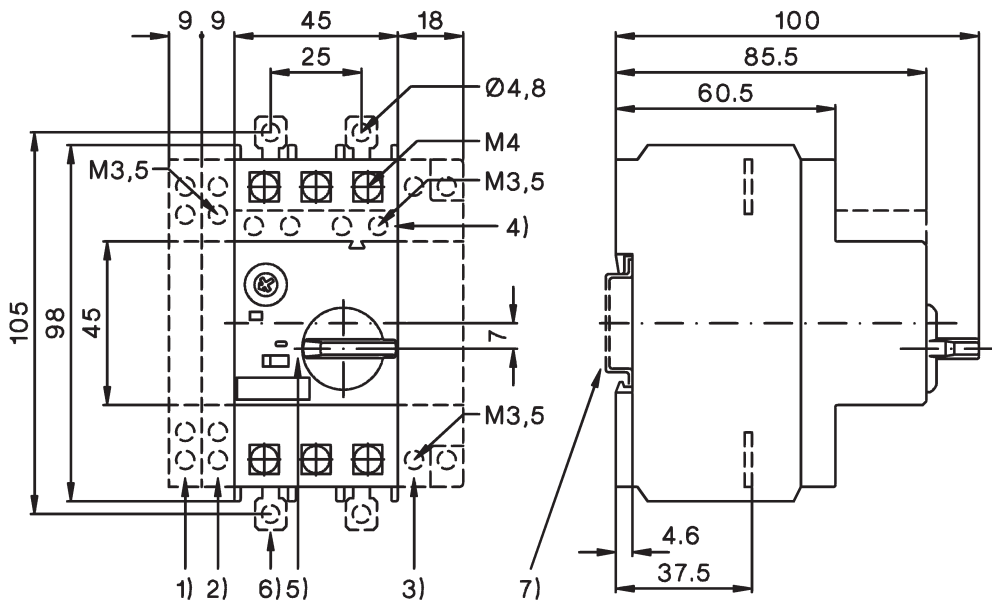

- 1) Side aux. contact
- 2) Magnetic trip alarm
- 3) Shunt or undervoltage release of arcing
- 4) Transverse aux. contact
- 5) Handle lock in OFF-position (Ø 5mm)
- 6) Push-in Lugs for screw mounting
- 7) 35mm DIN-rail acc. to EN 50022

Height of arcing spaces (clearance from earthed parts)

at U _e (V)	240	415	460	525	690
mm	30	30	30	30	50
inch	1,18	1,18	1,18	1,18	2

Dimensions

Circuit-breaker M4-63R

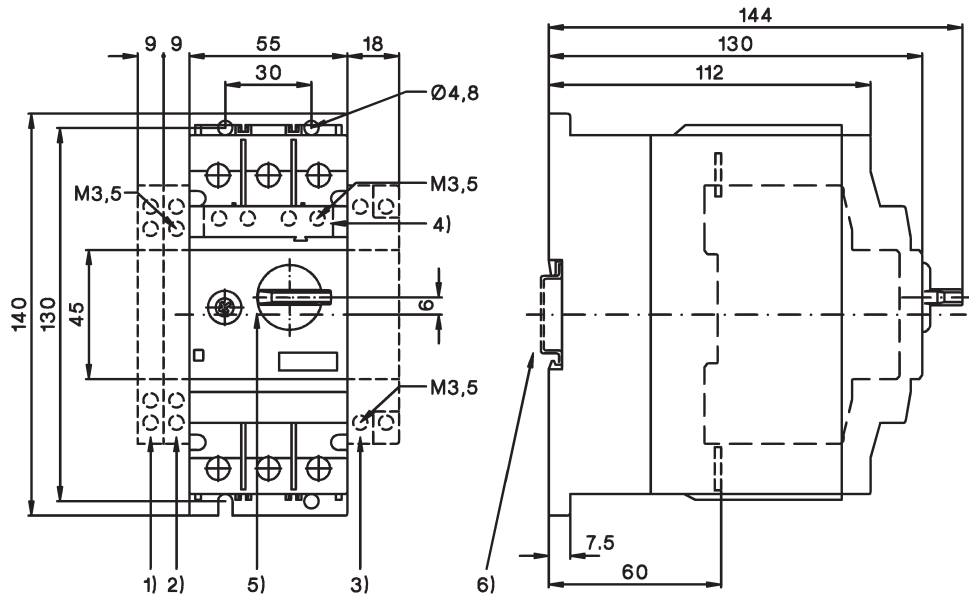

Height of arcing spaces (clearance from earthed parts)

at U _e (V)	240	415	460	525	690
mm	50	50	50	50	50
inch	2	2	2	2	2

- 1) Side aux. contact
- 2) Magnetic trip alarm
- 3) Shunt or undervoltage release
- 4) Transverse aux. contact
- 5) Handle lock in OFF-position (Ø 5mm)
- 6) 35mm DIN-rail acc. to EN 50022

Circuit-breaker M4-100R

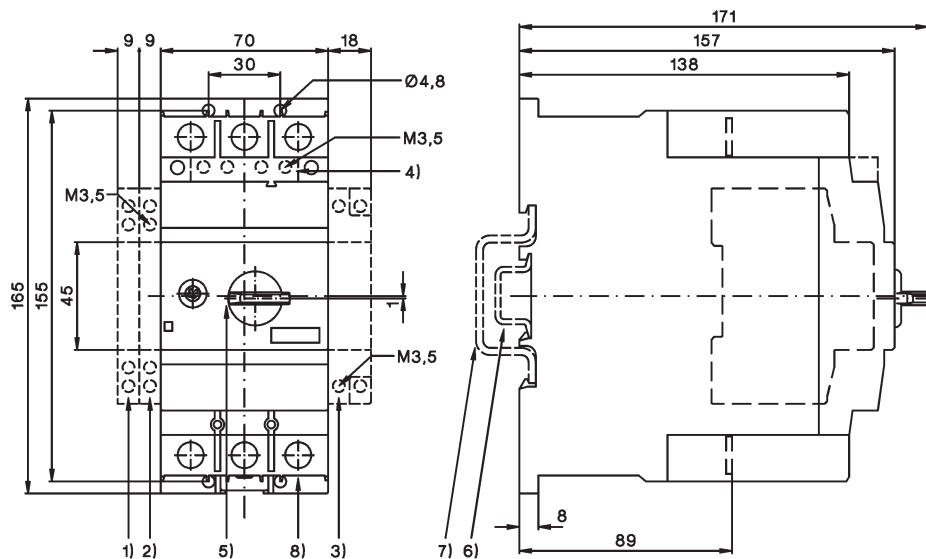

Height of arcing spaces (clearance from earthed parts)

at U _e (V)	240	415	460	525	690
mm	50	70	70	110	150
inch	2	2¾	2¾	4,33	6

- 1) Side aux. contact
- 2) Magnetic trip alarm
- 3) Shunt or undervoltage release
- 4) Transverse aux. contact
- 5) Handle lock in OFF-position (Ø 5mm)
- 6) 35mm DIN-rail acc. to EN 50022
- 7) 70mm DIN-rail acc. to EN 50023
- 8) 4mm hexagon socket screw

Dimensions

Link Module M4 32 VK1

M4-32T + K1-..

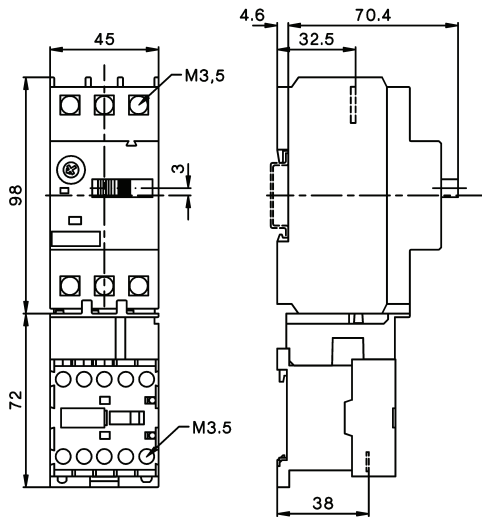

M4-32R + K1-..

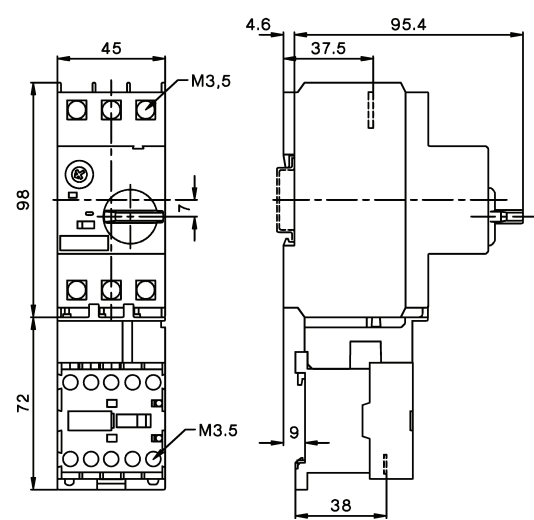

Link Module M4 32 VK3

M4-32T + K3-10ND.
M4-32T + K3-18ND..

M4-32T + K3-14ND.
M4-32T + K3-22ND..

M4-32R + K3-10ND.
M4-32R + K3-18ND..

M4-32R + K3-14ND.
M4-32R + K3-22ND..

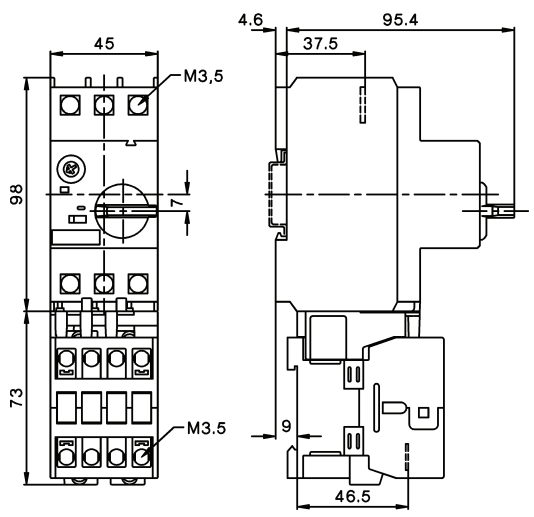
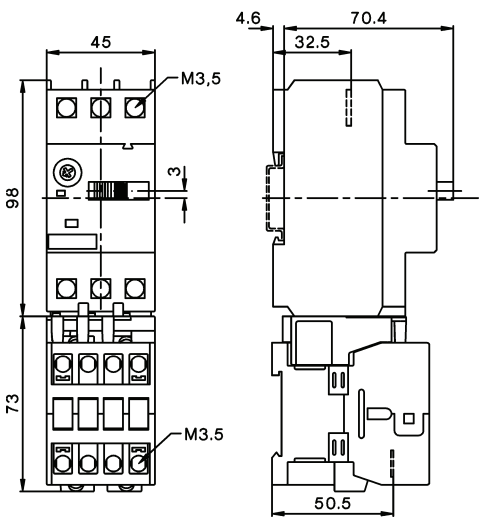

Link Module M4 32 VKG3

M4-32T + KG3-10..
M4-32T + KG3-18..

M4-32T + KG3-14..
M4-32T + KG3-22..

M4-32R + KG3-10..
M4-32R + KG3-18..

M4-32R + KG3-14..
M4-32R + KG3-22..

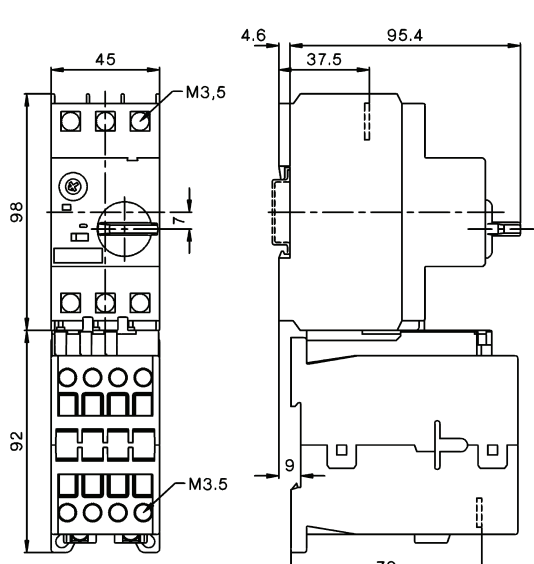
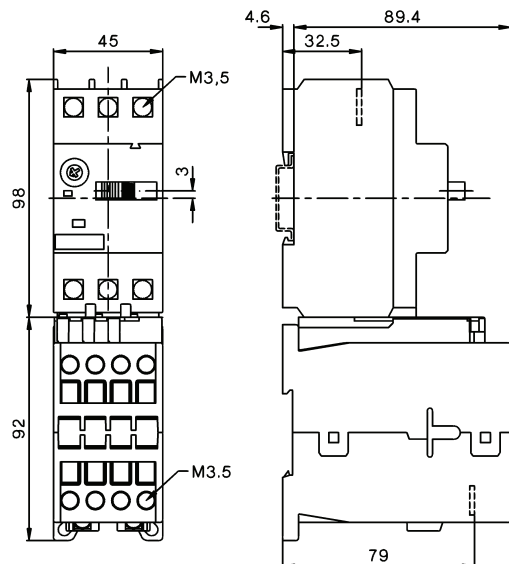

Dimensions

DIN-rail adapter M4 32 HU1

M4-32T + K3-24 + M4 32VD
 M4-32T + K3-32 + M4 32VD

M4-32R + K3-24 + M4 32VD
 M4-32R + K3-32 + M4 32VD

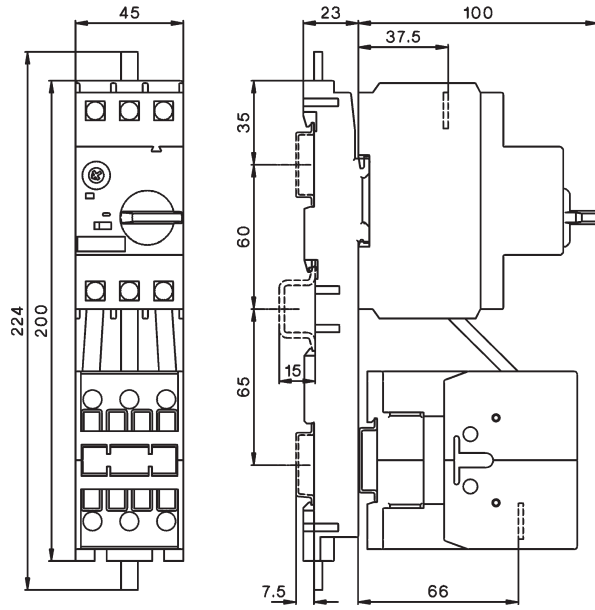
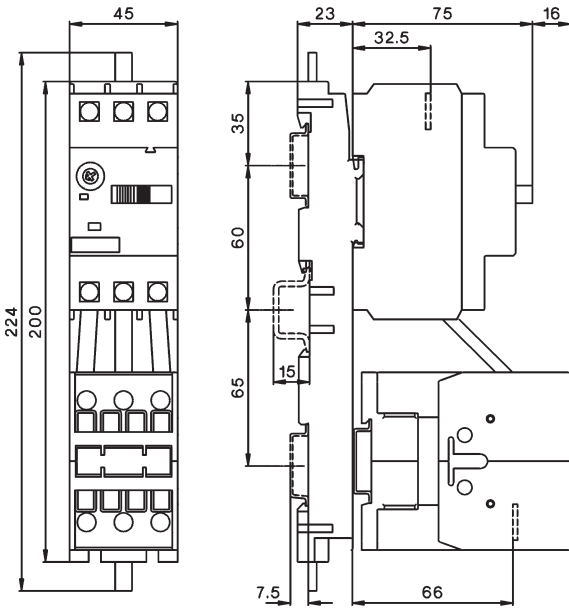

DIN-rail adapter M4 32 HU1

M4-32T + KG3-24 + M4 32 VD
 M4-32T + KG3-32 + M4 32 VD

M4-32R + KG3-24 + M4 32 VD
 M4-32R + KG3-32 + M4 32 VD

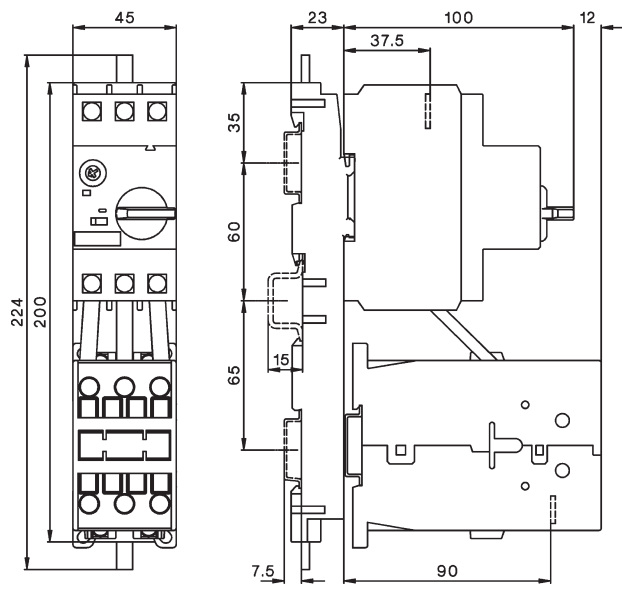
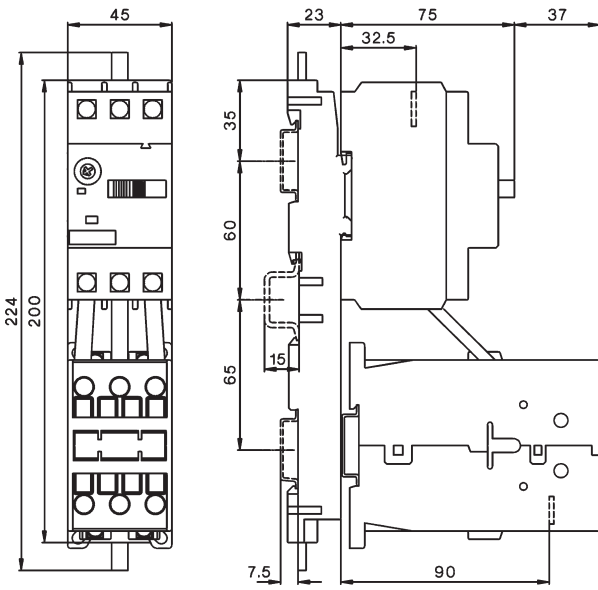

Dimensions

DIN-rail adapter M4 63 HU1

M4-63T + K3-32 + M4 63 VD
 M4-63T + K3-40 + M4 63 VD

M4-63T + KG3-32 + M4 63 VDG
 M4-63T + KG3-40 + M4 63 VDG

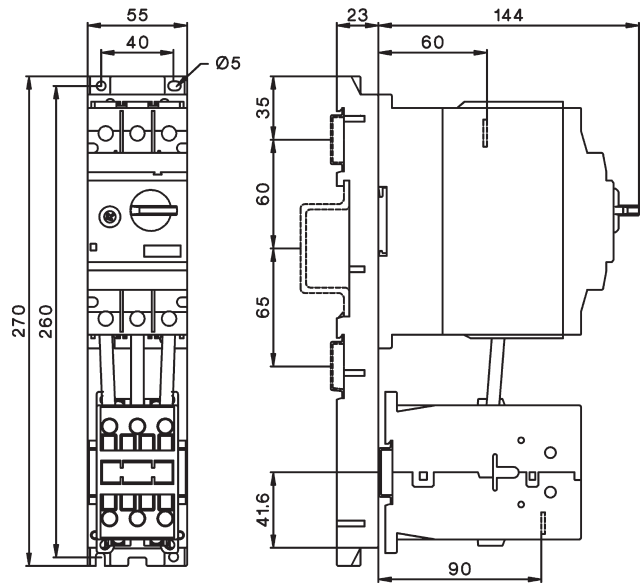
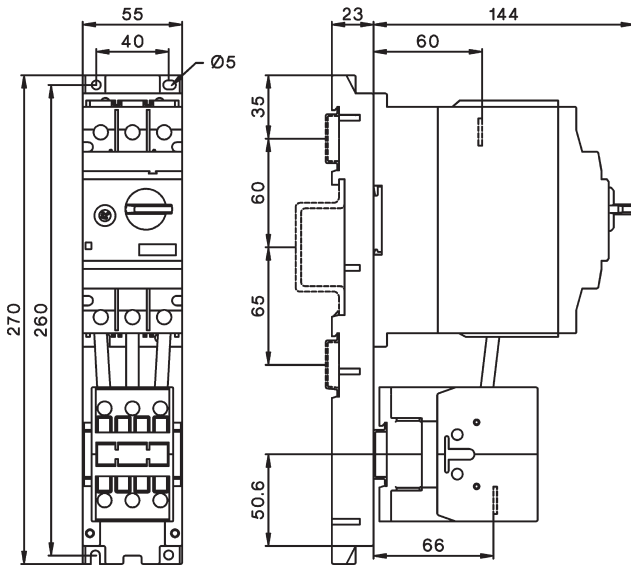

DIN-rail adapter M4 63 HU1

M4-63T + K3-50 + M4 63 VD
 M4-63T + K3-62 + M4 63 VD

DIN-rail adapter M4 100 HU1

M4-100R + K3-62 + M4 100 VD
 M4-100R + K3-74 + M4 100 VD

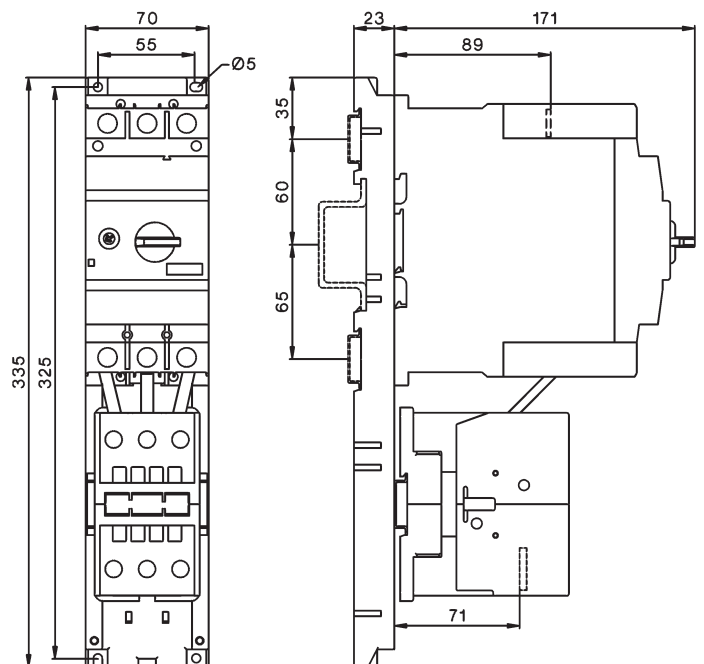
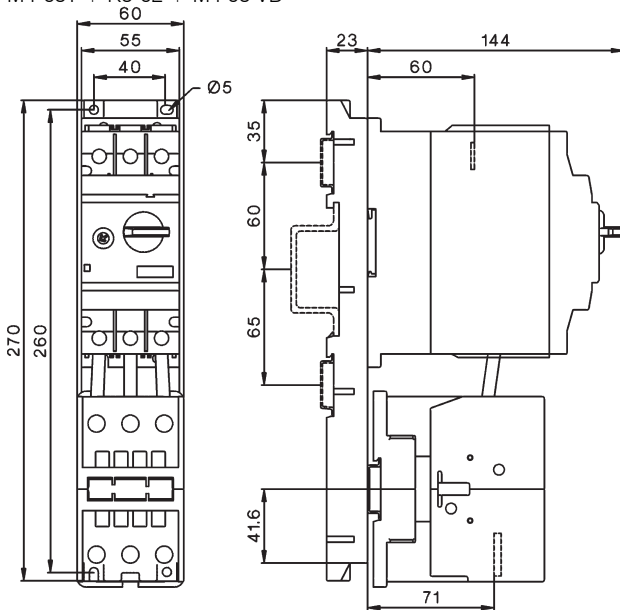

Dimensions

Enclosures

M4 32R PFH4
M4 32R PFHN4

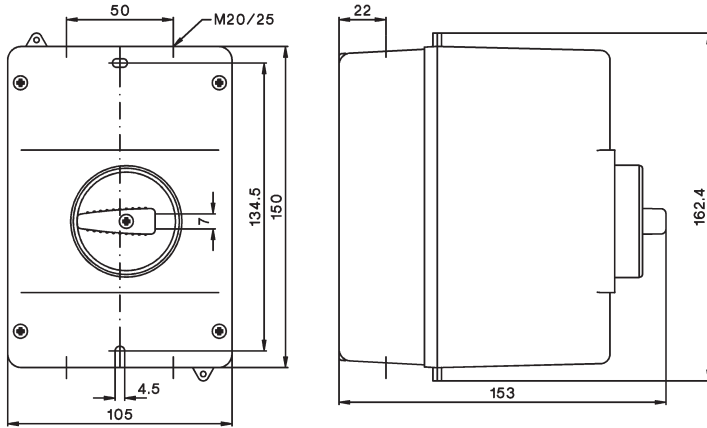

Door-coupling rotary mechanisms

Mounting holes

Type	A
M4 32R EH1 115	149 - 210
M4 32R EHN1 115	149 - 210
M4 32R EH1 315	149 - 410
M4 32R EHN1 315	149 - 410

Type	A
M4 63R EH1 115	194 - 255
M4 63R EHN1 115	194 - 255
M4 63R EH1 315	194 - 455
M4 63R EHN1 315	194 - 455

Type	A
M4 100R EH1 115	220 - 282
M4 100R EHN1 115	220 - 282
M4 100R EH1 315	220 - 482
M4 100R EHN1 315	220 - 482

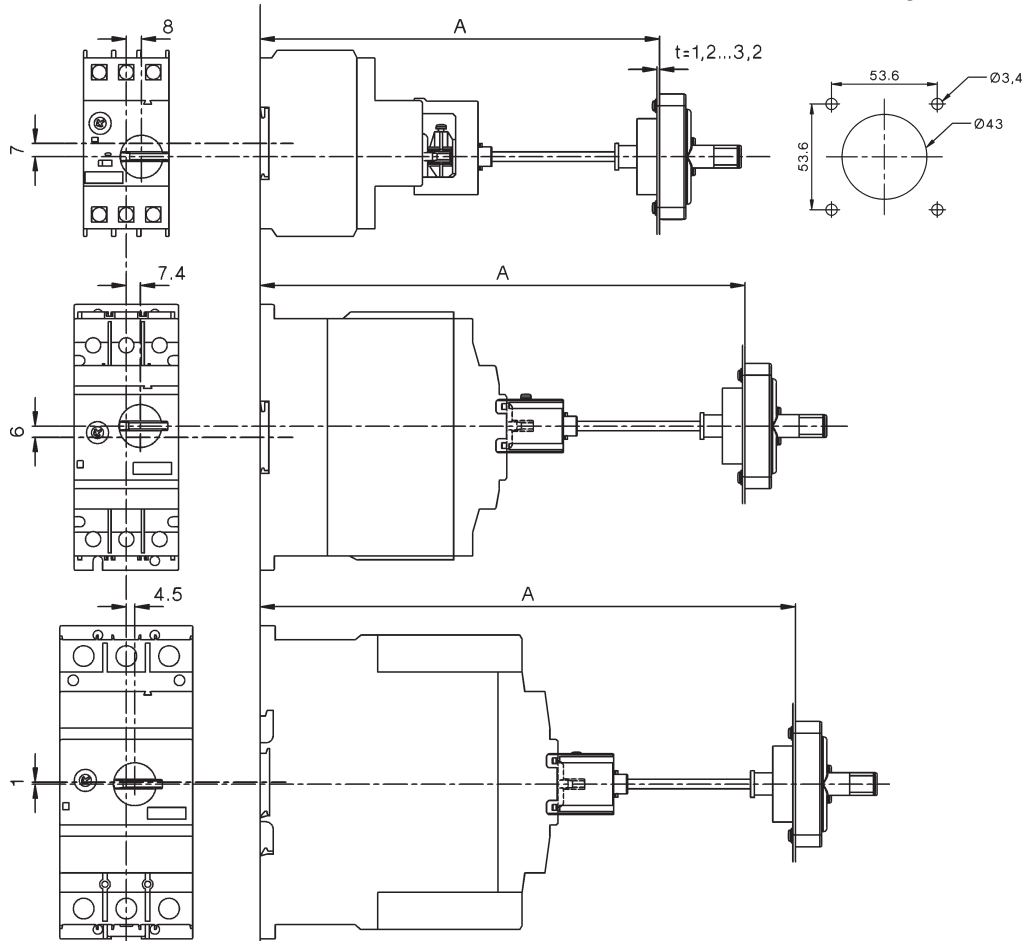

Insulated 3-phase busbar system

M4 32 S..

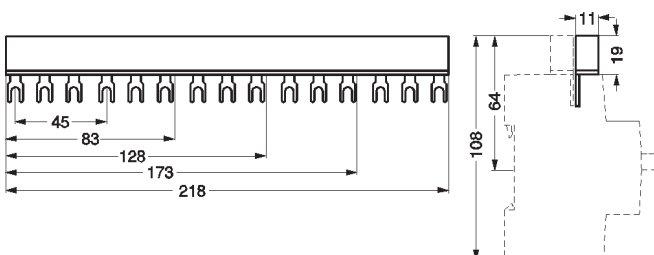

M4 32 SE

