

Suitable for  
**LED**  
**NEXT**  
GENERATION



**ADSONE 2.0** - Automatic wiring of  
standard components and LED connectors.  
Broaden your horizon and connect with BJB

**BJB**  
Automation



# ADS ONE 2.0: Progress that is taking place

## **New features, new possibilities, new design.**

Our little one has been doing quite well, which is due to continuous advancements and detailed improvements. Another big step forward after two years of further technical development. As a result the configuration and the design changed. The variety of colours and material was optimised, edges trimmed and

subassemblies re-arranged. Now, the ADS ONE 2.0 has the confident appearance that is reflected in the technical details inside the robot.

In addition, the controls are now ergonomically designed, integrated into the metal body. The light barrier is now behind the framework as well as the trunking. Using less single components mean an

increase in safety and the circular safety fence make it a harmonious whole.

One more detail, the new ADS ONE 2.0 is 40 mm narrower and therefore fits into a standard 20 foot container. Bon voyage.

Our little one has  
been doing quite well





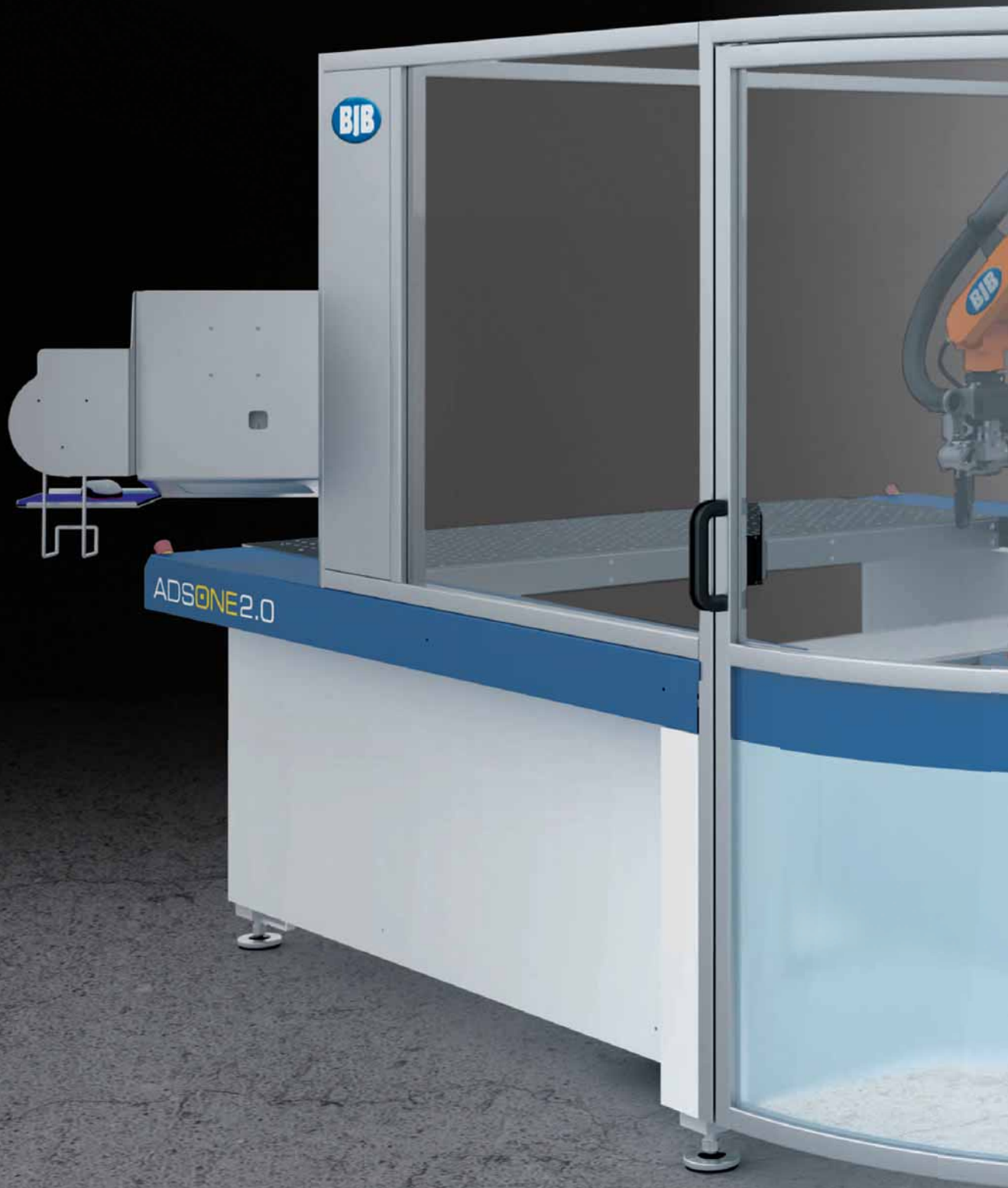

ADSONE 2.0

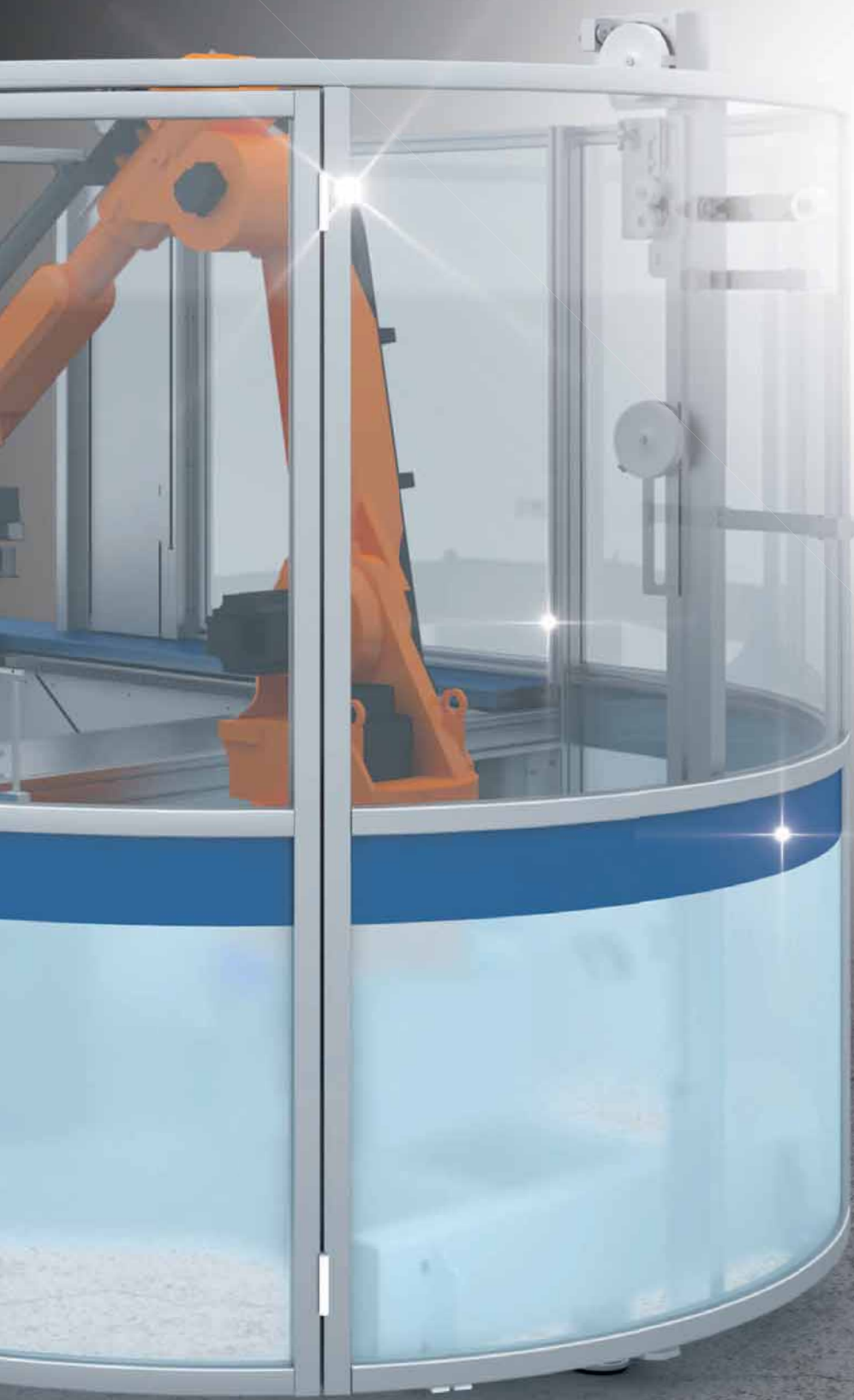

Luminaire manufacturing, the next generation

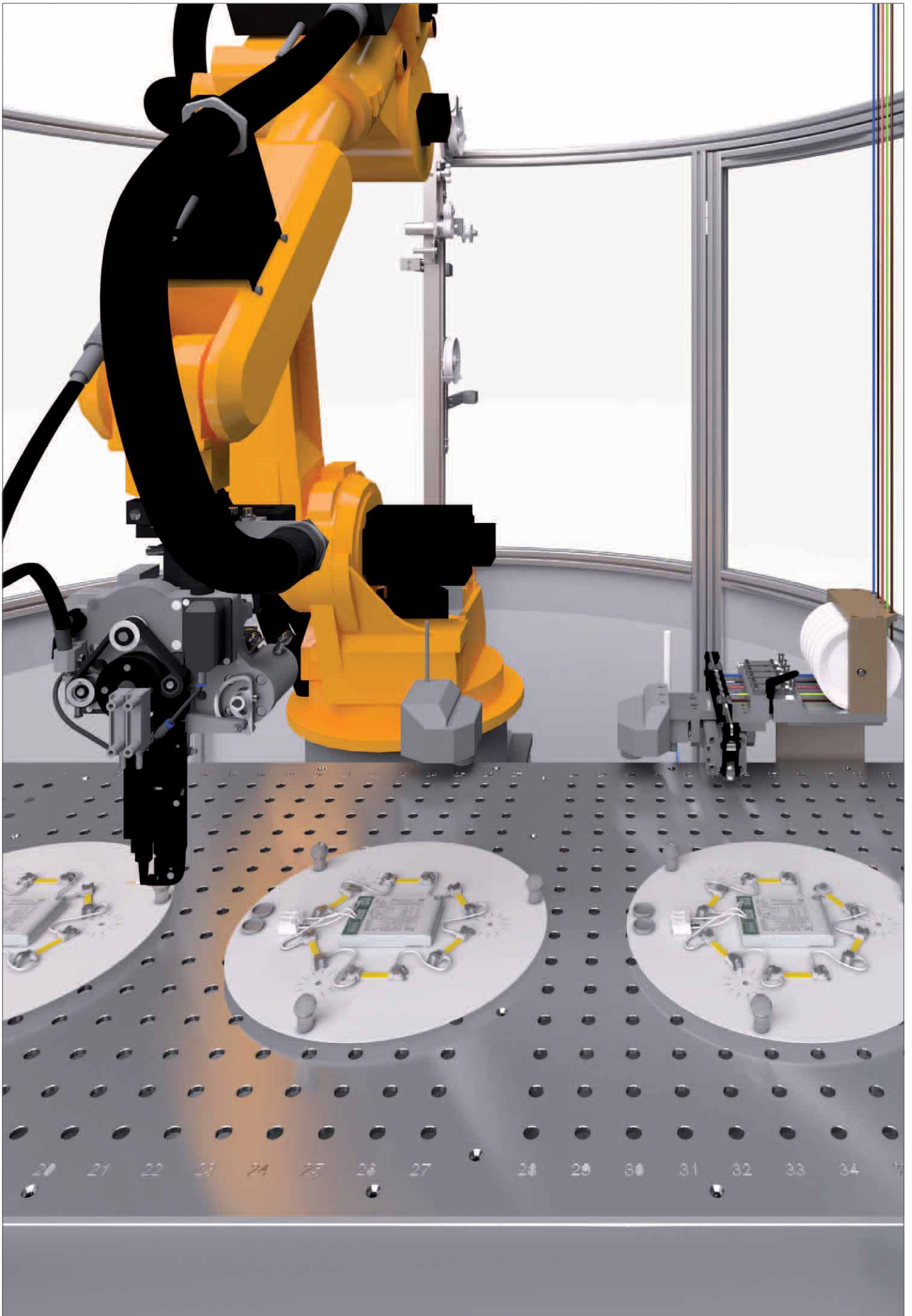



# The future is now: Automatic wiring of LED luminaires with ADS robots from BJB

The use of LEDs in the lighting industry is on the rise and the push wire technology proves to be an excellent connecting technology for various LED components. The programming of our robots is based on the components and can be transferred onto any lamp. For virtually every LED manufacturer, BJB have a push wire LED connector that is suitable for automatic wiring.

To avoid electrostatic discharge, production lines have to be altered to accommodate the new technology. We have allowed for this and our ADS ONE 2.0 is certified by an independent body. Consequently, with our ADS ONE 2.0, the production of LED luminaires can continue without interruptions.

Already installed ADS systems can be upgraded to qualify for the production of LED luminaires.

**ADS ONE 2.0. Great performance on only 7 m<sup>2</sup>**

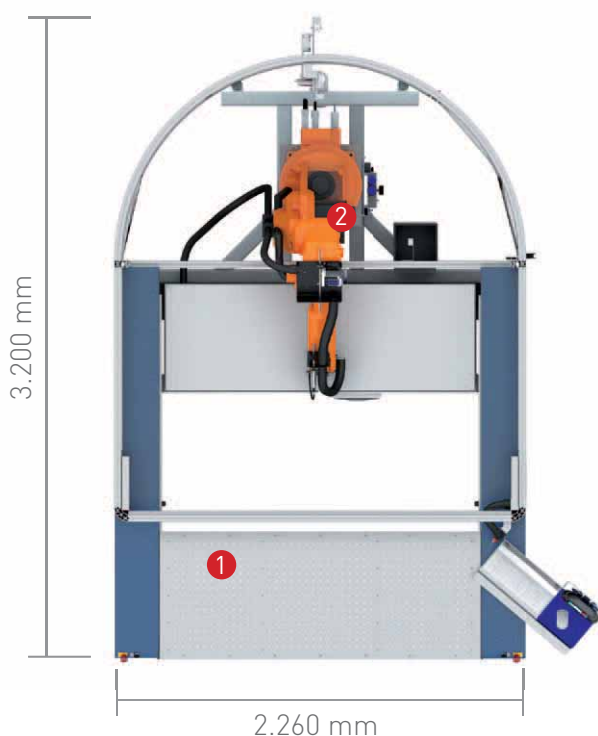

## LED & ADS

LED components from BJB are almost always ADS-compatible. Like all other components, they can be wired automatically with ADS systems.

# ADS ONE 2.0: Quick and exact

## Key features

Two years after we launched ADS ONE we present the next generation ADS ONE 2.0. Various detailed improvements result in an overall greater efficiency. Key features:

- Quick programme change
- Optimised wiring tool to handle halogen free wire
- Greater wear resistance means less maintenance and less spare parts
- Electrical connection outside of the control cabinet
- Optimised user interface
- Operation terminal with USB port
- New standardised magnets for manual and automatic set up

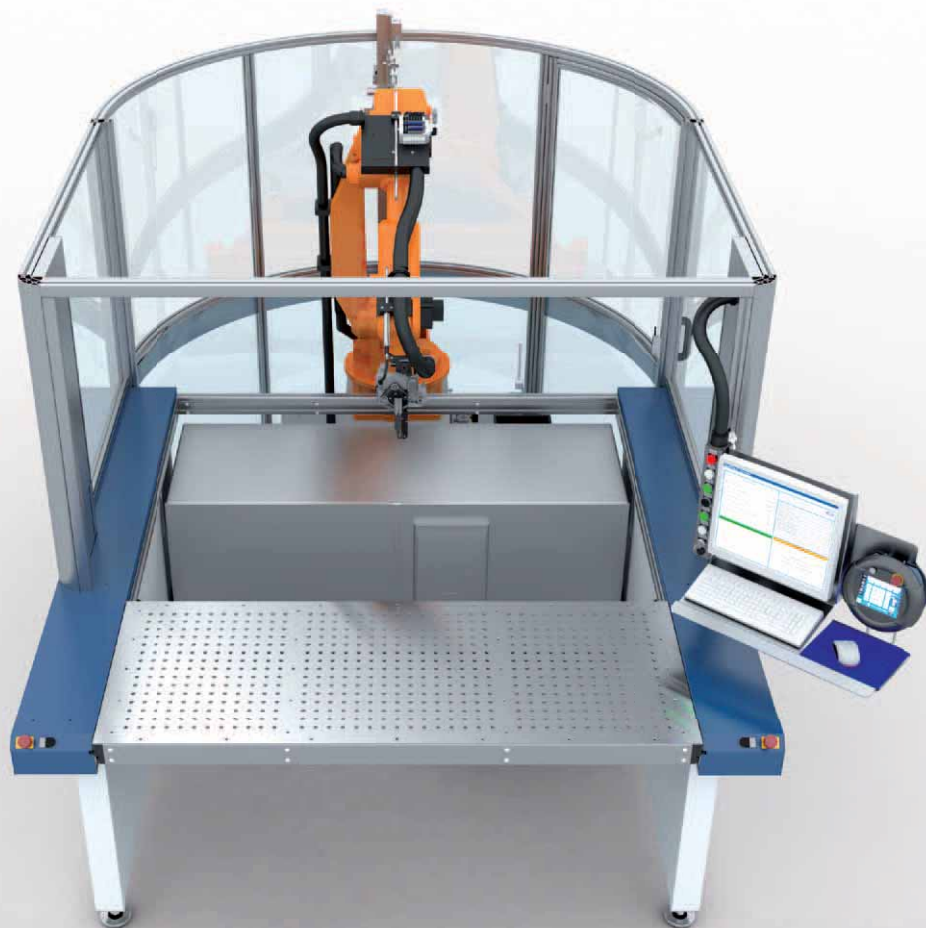



## New option in the ADS product range: Module for through wiring

With the additional module for through wiring, we offer the possibility to automate the luminaire production further. This enables the flexible installation of up to five wires with cross section of 1.5 – 2.5 mm<sup>2</sup> to be carried out during the standard wiring process.

For example, power supply cables in various colours as well as cables for lighting control systems. To grip and insert the wires, the robot automatically

picks an additional unit. The cable is then stripped and pushed into the relevant component. The robot repeats this process until all wires are inserted.

The system is controlled via an intuitive user interface. The parameters for through wiring are stored in the actual wiring program and can be switched on and off, as required.

The additional through wiring module can be integrated into the ADS ONE, ADS Basic 2 and 3, as well as into the ADS Master L. Naturally, existing systems can be upgraded.



Up to five different cables can be wired at a time.

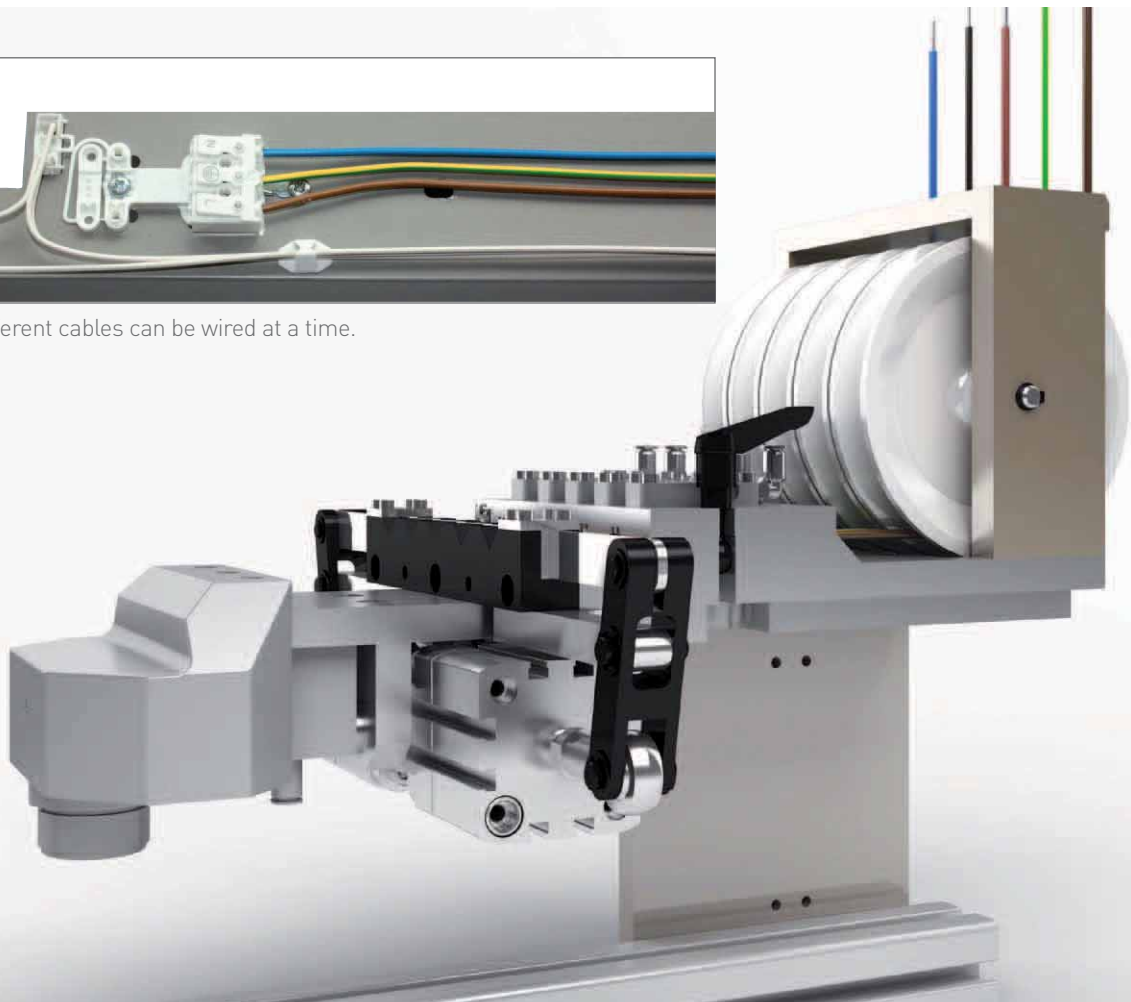

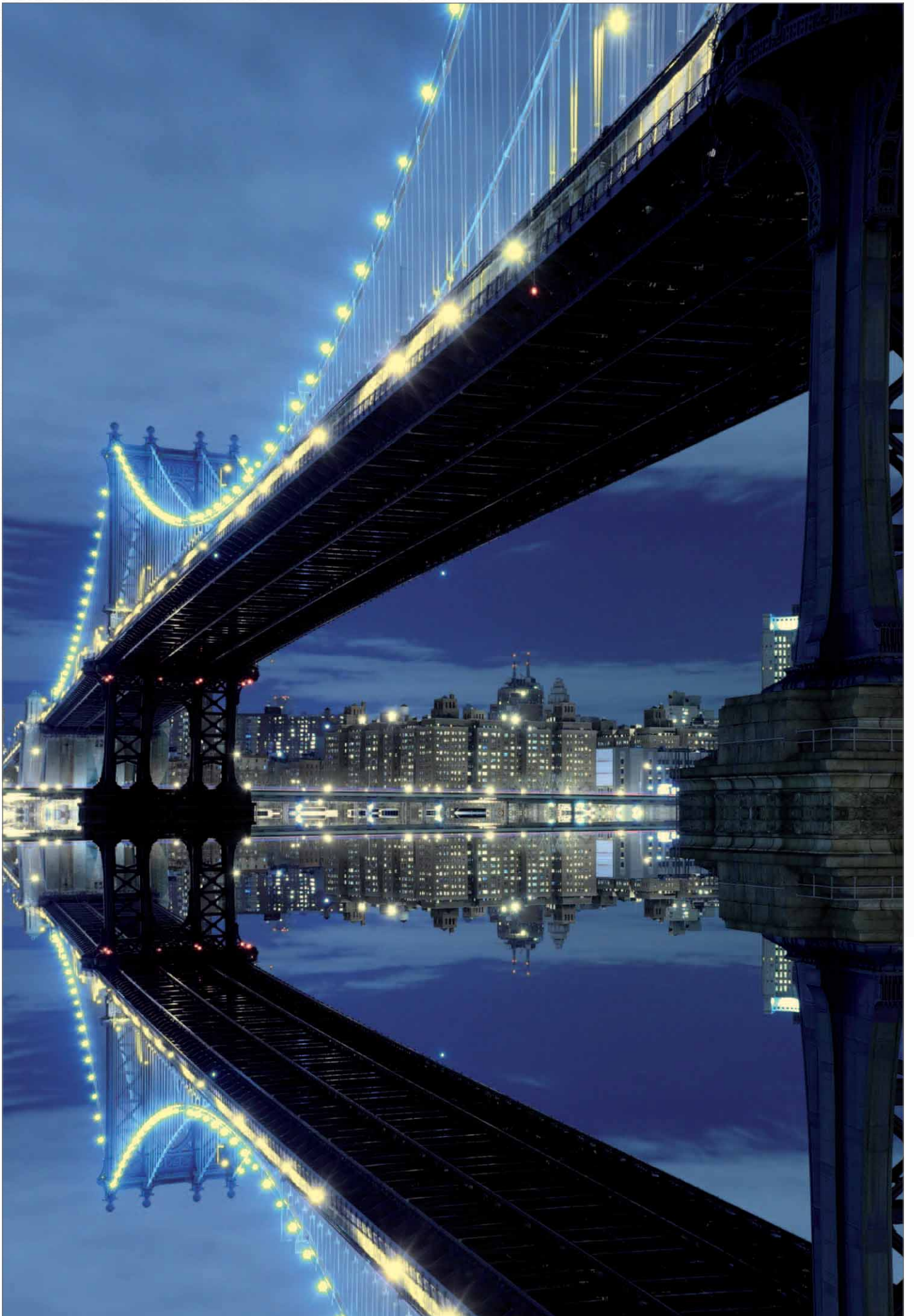

# BJB and BJB automation: The world of Lamp and LED connection technology

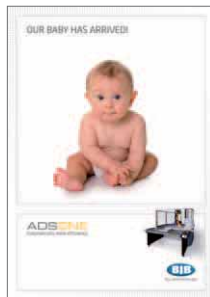

BJB Automation



[www.bjb-automation.com](http://www.bjb-automation.com)



[www.bjb.com](http://www.bjb.com)



BJB catalogue

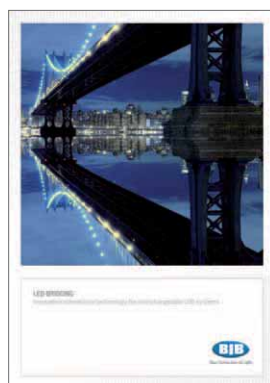

LED catalogue

You can find this and further information on [www.bjb.com/downloads](http://www.bjb.com/downloads)



## ADSONE 2.0

Automatically more efficiency



BJB GmbH & Co. KG · Werler Str. 1 · 59755 Arnsberg  
Telefon +49 29 32.9 82-0 · Telefax +49 29 32.9 82-82 01  
info@bjb.com · www.bjb.com

  
Automation