

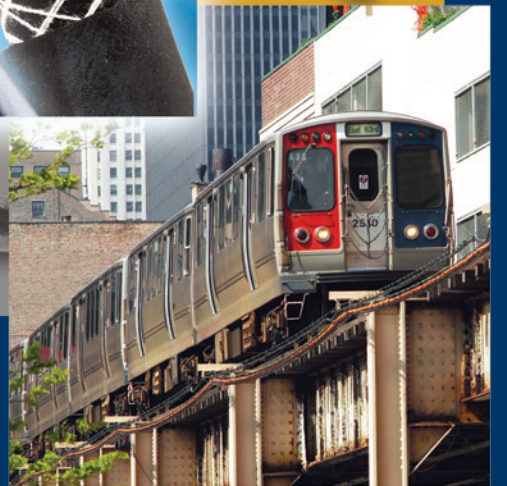

POLYRAD®



RAPID TRANSIT & LOCOMOTIVE
WIRE AND CABLE
OCTOBER 2011

Join the Wire Wizard for a quick, informative tour showing the interactive features of our catalogs



WELCOME

On-Line Catalog Features

- View the catalog in full screen mode by using the far left expansion logo on the menu bar. (Keyboard input may not work in full screen mode, which means you must leave the full screen mode in order to utilize the email function.)
- Click the “General Cable” logo on the left side of the menu bar to go to General Cable’s Web site.
- The “Table of Contents” button in the center of the menu bar takes you to a fully interactive page. Click on any product category or listing to take you to the appropriate page. (All other page references throughout the catalog are also fully interactive.)
- The entire catalog’s contents can be searched using the Search button located in the upper right of the menu bar.
- Turn catalog pages by clicking your mouse on the top or bottom corner of the page or by using the forward or back arrows on the side of the page or on the bottom bar.
- Zoom to details on each page by clicking when the magnifying glass pointer is active. Click again to return to full view.
- Share the complete interactive catalog by selecting the “Share this Publication” icon located in the lower right on the bottom bar.
- Print all or selected pages using the Print icon located in the lower right on the bottom bar.
- The entire interactive catalog or individual pages can be downloaded as a PDF using the PDF icon located in the lower right on the bottom bar.
- Use “Crop part of page” icon located in the lower right on the bottom bar to take a snapshot of any part of a page and save as a jpg.

TRANSIT



POLYRAD®

Servicing the Rapid Transit & Locomotive Markets

This catalog contains in-depth information on the most comprehensive line of transit and locomotive wire and cable available today. It features the latest information on products, along with detailed technical and specification data in indexed sections — with an easy-to-use “spec-on-a-page” format.

The “spec-on-a-page” format was developed to meet your needs. It features up-to-the-minute product information, from applications and constructions to detailed technical and specification data. There’s also a technical information section for additional assistance.

And, of course, if you need any further data, General Cable’s Customer Service staff provides the answers you need quickly and efficiently.



All information in this catalog is presented solely as a guide to product selection and is believed to be reliable. All printing errors are subject to correction in subsequent releases of this catalog. Although General Cable has taken precautions to ensure the accuracy of the product specifications at the time of publication, the specifications of all products contained herein are subject to change without notice.

GENERAL CABLE, DURALOX, POLYRAD, UNIBLEND and UNISHIELD are trademarks of General Cable Technologies Corporation.

© 2011. General Cable Technologies Corporation.
Highland Heights, KY 41076
All rights reserved. Printed in USA.

What's New?

IRIS CERTIFICATION



General Cable's transit wire and cable facility is now IRIS Certified. Recognized globally within the railway sector for the evaluation of management systems, IRIS (International Railway Industry Standard) certification demonstrates General Cable's value as a quality supplier and ongoing commitment to excellence, sustainability and reliability. It ensures improved product quality and efficient procedures throughout the whole supply chain. This significant certification is a powerful addition to General Cable's already wide breadth of quality standards, setting it apart as the only wire and cable company in North America to be both ISO 9001:2008 and IRIS Certified.

TRANSIT DATA COMMUNICATIONS CABLES



General Cable offers a wide variety of transit communications cables that meet UL 1581 VW-1 flammability requirements, ASTM E662 smoke density, and Boeing BSS 7239 and Bombardier SMP 800-C toxicity standards. A significant component to monitoring and managing modern-day transit and locomotive systems, General Cable's transit data communications cables are produced in multi-conductors, coaxial, and shielded twisted pairs. These high-quality products are engineered with outstanding thermal stability at elevated temperatures, as well as excellent performance in sub-zero conditions. General Cable also has the ability to design products specifically catered to individual customer needs and requirements, including copper, optical fiber and hybrid cables.

EN STANDARDS COMPLIANCE



In an industry that moves people as well as goods, safety is paramount. Developed to limit risk in case of fire, EN standards are European-adopted transit industry specifications for wire and cable that demand special Low-Smoke and Halogen-Free cable designs. General Cable offers European standard specifications to meet the needs of major multinational OEM requirements. Product expansion to support EN specification emphasizes General Cable's continued commitment to the global transit industry.

POLYRAD® XT-TX

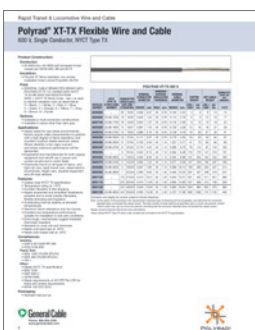

Having obtained approval for MTA New York City Transit's (NYCT) TX cable specification with Polyrad® XT-TX, General Cable now is a qualified supplier for NYCT capital programs and maintenance, repair and operational (MRO) requirements. When it comes to specifying cables that can handle extreme conditions in more environments and places, General Cable offers a comprehensive selection of quality, high-performance Polyrad® XT cables.

General Cable – Your Transit Partner

For rapid transit, locomotive applications and rolling stock, General Cable provides the toughest cables to meet the most demanding requirements for long-term performance and reliability. As an industry leader in a challenging marketplace, General Cable has the expertise, facilities and structure to deliver results:

- Leadership in Material Development
- Dedicated Engineering Expertise
- ISO 9001 Quality Assurance Program
- Advanced Customer eBusiness Tools

A Wide Range of Products

- Car/Locomotive Wiring
- Power Cables
- Control Cables
- Instrumentations Cables
- Coupler Cables
- Electronically Controlled Pneumatic Brake (ECP) Cables
- Data Communications Cables
- Diesel-Electric Locomotive (DLO) Cables
- 2 HR Fire-Rated Circuit Integrity Cables
- Head-End Power Cables
- Heating & Lighting Cables
- Propulsion/Traction Motor Lead Cables
- Off-Road Equipment Cables

Major End-Users Supplied

- Original Equipment Manufacturers (OEM)
 - Car Builders & Rebuilders
 - Locomotive Builders & Rebuilders
- Transit Agencies
- Distributors
- Subcontractors to Original Equipment Manufacturers (OEM)
- System Integrators



General Cable's Willimantic, Connecticut plant is one of the most diverse manufacturing facilities of its kind. More than 600,000 square feet of modern manufacturing space is dedicated to design, development, engineering and manufacturing, as well as a wide range of in-house testing and technical support. General Cable's Industrial & Specialty facility has the expertise to design and develop an extensive variety of materials into thousands of cable constructions for sustained and continuous operations in challenging environments. Focused on providing outstanding quality, service and technical support on behalf of our customers, General Cable is the best partner for current and next-generation transit cabling systems.



Phone: 888-593-3355
www.generalcable.com

Quality is Number One

General Cable is always committed to exceeding our customers' expectations for quality and performance. We strive to ensure quality through extensive in-house and third-party testing with strict adherence to specifications and industry standards, as demonstrated by the following certifications and compliances.

IRIS Certification

General Cable's transit wire and cable facility is now IRIS (International Railway Industry Standard) Certified. UNIFE, the Association of the European Rail Industry, was created in 1991 in anticipation of the creation of the European Union. In 2005, UNIFE established IRIS with the goal of securing higher quality in the railway industry. This recognized industry certification enables railway component suppliers to meet globally recognized levels of quality for its railway components. General Cable is the first wire and cable manufacturer in the Americas to achieve IRIS Certification*. Combined with IRIS Certification in our Barcelona, Spain facility, General Cable meets the transit sector's needs throughout the Americas and Europe. General Cable's IRIS Certification ensures improved product quality and efficient procedures throughout the whole supply chain.



ISO 9001/2008 Compliance

ISO 9001 is the world's most established quality framework to demonstrate the ability to consistently provide product that meets applicable requirements and enhances customer satisfaction through processes that ensure quality. General Cable is the only wire and cable company in North America to be both ISO 9001:2008 and IRIS Certified.



UL and CSA Approved Laboratories

General Cable's Willimantic, CT facility has a laboratory quality system based on ISO/IEC 17025:2005, encompassing proper test equipment, test environment, personnel qualifications, test standards and procedures, and data recording and reporting procedures. Accordingly, the Willimantic lab is approved by Underwriters Laboratories (UL) as a testing facility. In fact, the facility is audited and approved by UL for their Client Test Data Program (CTDP), demonstrating a level of performance that does not require UL to witness on-site testing. UL assesses the lab's quality systems and testing methods on an annual basis.



The Willimantic lab is also approved by CSA International (CSA). The CSA Category Program Certification (CPC) is based on ISO/IEC 17025:2005, which provides more repeatable and reliable test results to bring innovative products to market quicker. The General Cable Willimantic facility is certified by CSA to conduct our own testing in a product category. CSA certification requires General Cable to have thorough knowledge of the applicable product standards, access to suitable test facilities and a demonstrated ability to design, manufacture and test products that consistently comply with the standards.



* IRIS Certifications are for Product Category 12, Cabling and Cabinets (design, development and production of electric special cables [power and instrumentation] for the railway industry).

“Quality is not something that is achieved and then forgotten but something that we work to improve every day by continuously focusing on design, technology, and control. Improved product designs and investment in people and equipment are all part of our quality commitment to you.”

Greg Lampert
President and CEO
General Cable
North America



Phone: 888-593-3355
www.generalcable.com

Customer Service and Satisfaction

General Cable's **Brand Rex Brand** Transit Team is strategically positioned to provide the mass transit market with the best service and products available. Our resources are focused on providing outstanding quality, exceptional technical support and customer service, and competitive pricing while driving "value" on behalf of our key customers. **Brand Rex Brand** cables are the industry standard and the preferred choice for the rapid transit and locomotive markets.



General Cable is dedicated to customer service and satisfaction. Call our team of professionally trained sales associates with any questions to meet your application needs.

888-593-3355



Phone: 888-593-3355
www.generalcable.com

PRODUCT SELECTION LOCATOR

SECTION		PAGES
1	Polyrad® XT, Polyrad® ULTRA and Polyrad® XT-TX Wire and Cable Products	1-9
2	Transit Data Communications Cables	10-13
3	Transit Specialty Cables	14-17
4	Technical Information	18-31

Serving the Rapid Transit & Locomotive Markets

TABLE OF CONTENTS

Section 1	Polyrad® XT, Polyrad® ULTRA and Polyrad® XT-TX Wire and Cable Products	1-9
	Polyrad® XT Flexible Wire and Cable 600 V, Single Conductor, Dual Rated – 125°C/110°C	2
	Polyrad® XT Flexible Wire and Cable 2000 V, Single Conductor, Dual Rated – 125°C/110°C	3
	Polyrad® XT Multi-Conductor Cable 600 V and 2000 V, 125°C, Shielded and Non-Shielded	4-5
	Polyrad® ULTRA Wire 600 V, Single Conductor, 125°C, Reduced Weight, Smaller Diameter, Dual Wall	6
	Polyrad® ULTRA Multi-Conductor Cable 600 V, 125°C, Shielded and Non-Shielded	7
	Polyrad® XT-TX Flexible Wire and Cable 600 V, Single Conductor, NYCT Type TX	8
	Polyrad® XT-TX Flexible Wire and Cable 2000 V, Single Conductor, NYCT Type TX	9
Section 2	Transit Data Communications Cables	10-13
	Category 5 Shielded Cable 4 Pair, 24 AWG, TIA/EIA-568-B.2 Patch	11
	Polyrad® XT Transit Data Communications Cables	12-13
Section 3	Transit Specialty Cables	14-17
	Diesel Locomotive Cable 2000 Volts (EPR/XL-CPE) - SPEC 5310 UL RHH/RHW-2, 2000 V and c(UL) RW90, 1000 V Flexible, Oil-, Sunlight- and Ozone-Resistant, Flame-Retardant, -40°C to 90°C	15
	Electronically Controlled Pneumatic (ECP) Brake Cable 600 V, Two Conductor, Unarmored and Armored	16
	TRANSPower Head-End Power (HEP) 600 V Cables Single Conductor, 4/0 AWG or Three Conductor, 10 AWG	17

Serving the Rapid Transit & Locomotive Markets

TABLE OF CONTENTS

Section 4	Technical Information	18-31
General Technical Information		
	SPEC A100 Common Color Sequence	19
	SPEC A125 Temperature Conversion Table	20
	SPEC A150 Metric Conversion Factors	21
	SPEC A186 AWG (American Wire Gauge) to MM ² (Millimeters Squared) Conversion	22
	SPEC A200 Reel Capacity Chart	23
	SPEC A210 Flame Test Comparison	24
Conductor Data		
	SPEC B040 Class I Conductors for General Wiring	25
	SPEC B045 Class K Conductors for General Wiring	26
Handling and Storage Recommendations		
	SPEC D001 Minimum Bend Radius	27
	SPEC D005 Recommended Reel Handling Practices	28
	SPEC D025 Recommended Cable Handling Practices	29
	SPEC D050 Recommended Cable Storage Practices	30
Part Number Index		31



Our Green Initiative symbol recognizes our role and responsibility in promoting sustainability.

The symbol also reflects our commitment to achieving industry-leading standards and responding proactively to environmental global issues.

Look for our products with the RoHS symbol for your green building initiatives.



Visit www.generalcable.com
Select "company", then select "environmental"





General Cable is a leader in the development, design, manufacture, marketing and distribution of copper, aluminum and fiber optic wire and cable for the energy, industrial, specialty and communications markets.

Our products inspire progress worldwide ... customers use our value-added products to create global infrastructure that improves the standard of living for people everywhere.

Each day we're building business momentum — developing ideas into innovative solutions and industry-leading products, expanding geographic access and furthering our investment in highly capable associates, Lean Manufacturing, material science and technology resources.

General Cable is influencing the world ... with more than two-thirds of our sales generated outside North America and more than 11,000 associates in 47 manufacturing facilities throughout 25 countries. As one of the largest wire and cable manufacturers, we are the *One Company Connecting the World*.

Energy Cables

Our cables carry energy across the world — through the air, underground and under the sea. Increasing demand for energy is accelerating investment in exploration, extraction, power generation, transmission and distribution — whether based on coal, natural gas, oil, nuclear, wind, solar or water.

Industrial & Specialty Cables

Our cables channel the power and signals that make equipment hum and engines run. From oil rigs and broadcast studios to cars and trains, and in commercial buildings, public venues, factory floors and special applications such as military, nuclear, marine and mining — we serve an extensive range of markets.

Communications Cables

Our cables keep information flowing — facilitating a non-stop stream of words and images around the world. We meet the high-speed bandwidth needs of global communications networks from fiber optic submarine communications cables, copper and fiber aerial and underground cables to copper and fiber optic enterprise cables and system solutions.

World Headquarters

General Cable
4 Tesseneer Drive
Highland Heights, KY
41076-9753 U.S.A.



Polyrad® XT Flexible Rapid Transit & Locomotive Wire and Cable



POLYRAD®

General Cable's Brand Rex Brand Polyrad® XT rapid transit and locomotive wire and cable is the chosen solution for demanding environments throughout North America and the world. Polyrad® XT is used extensively on all types of rapid transit and freight cars, heavy- and light-rail cars, diesel-electric locomotives, wayside equipment and off-road vehicles.

Polyrad® XT transit cables are specifically designed for original equipment and retrofit use in power and control circuits and in motor leads. Polyrad® XT's superior heat, flexibility and abrasion resistance, combined with its reduced size, simplifies cable installation and permits higher ampacities. Fully tested to meet all applicable specifications, Brand Rex Brand Polyrad® XT cables ensure lifelong dependable service for transit, off-road and diesel-powered locomotives.

Unlike conventional insulating systems, Polyrad® XT offers a better balance of electrical properties for superior stability and performance. Available in both 600 Volt and 2000 Volt constructions, Polyrad® XT single conductor rapid transit and locomotive car cables are dual-rated at 125°C and 110°C. Available in 600 Volt and 2000 Volt construction, Polyrad® XT multi-conductor shielded and non-shielded rapid transit and locomotive car cables are rated at 125°C.

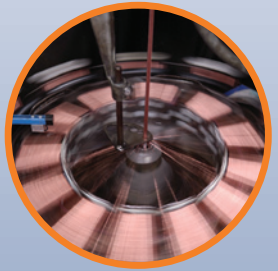
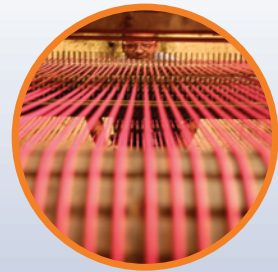

Insulation System and Construction

Brand Rex Brand Polyrad® XT insulation features a highly engineered and refined low-smoke polyolefin formulation used in conjunction with soft annealed tinned copper conductors per ASTM B33. This innovative insulation technology combines **outstanding flame retardance with excellent moisture-stable electrical values**. The construction is further enhanced by radiation cross-linking, which transforms the original thermoplastic into a rugged thermosetting material. The end result is a compound with **excellent thermal stability – it will not soften or flow at elevated temperatures**.

- Increased durability
- Greater resistance to cut-through
- Superior oil resistance
- Excellent low-temperature performance
- Maximum flexibility

Product Features and Benefits

Polyrad® XT wire and cables combine **superior electrical properties and performance** for advanced rapid transit, locomotive and off-road equipment applications.

- Dual 125°C/110°C temperature rating for long life, higher ampacities and protection from thermal overloads (single wires)
- Maximum flame retardance as demonstrated by VW-1 and, for multi-conductor cables, IEEE 383 (70,000 BTU/hr.) and IEEE 1202 (70,000 BTU/hr.)
- Excellent oil and chemical resistance
- Maximum dependability and mechanical toughness
- Smaller outside diameter and flexible stranding and insulation simplify installation

Polyrad® XT – The Trusted Name in Transit Wire and Cable

For more than 30 years, General Cable's Polyrad® XT has been the most respected name in transit wire and cable. First introduced to the marine market for offshore oil rigs, ships and mobile land rigs, Polyrad® XT was developed to perform in the most rugged conditions, passing a wide range of stringent test procedures and standards. Since its introduction to the transit and locomotive markets, Polyrad® XT has been the leading wire and cable choice for rapid transit and freight cars, heavy- and light-rail cars, diesel-electric locomotives, wayside equipment and off-road vehicles.

Polyrad® XT's Dual Rating

As the industry's first transit and locomotive wire and cable with a dual 125°C/110°C temperature rating, Polyrad® XT combines the superior properties and performance of a 125°C product while meeting all industry requirements for traditional 110°C transit wire. For distributors, this unique dual rating practically reduces inventory by half. Polyrad® XT meets all performance requirements of AAR RP-585 and ICEA S-95-658, as well as transit industry specifications.



Polyrad® XT Wire & Cable Testing

General Cable has perfected the technique of radiation processing. Cross-linking the insulation and jacket using our unique radiation process creates a more flexible product. In radiation cross-linking, a scanner accurately and uniformly directs a high-energy electron beam from a power source over the wire insulation, resulting in a precise degree of cross-linking. This technique enables General Cable to effectively process smaller wires with thin insulation walls to meet the transit market's critical demand for high-density cabling.

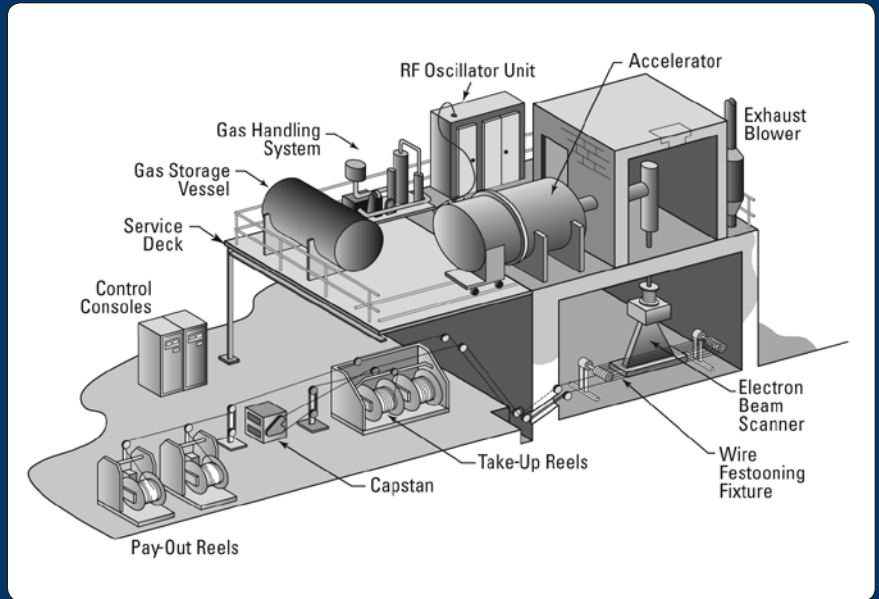

Electrical Properties

Requirement ICEA S-95-658		Typical General Cable*
Insulation Resistance @ 125°C (megohms-Mft)	2.0 Min.	8.3
Insulation Resistance Constant (K)	10,000 Min.	30,600
Long-Term Insulation Resistance 26 Weeks @ 90°C in water (megohms-Mft)	10 Min.	15
Accelerated Water Absorption Electrical SIC 24 hours @ 75°C	6.0 Max.	4.9
Increase in Capacitance, Percent		
1-14 Days	3.0 Max.	2.5
7-14 Days	1.5 Max.	1.3
Stability Factor after 14 days	1.0 Max.	0.18

Physical Properties

Requirement AAR RP-585 (S-501)		Typical General Cable*
Unaged Requirement		
Tensile Strength, Min. PSI	1,400 Min.	2,710
Elongation at Rupture, Min. %	200 Min.	260
Aged Requirement		
After Air Oven 7 days @ 158°C ± 2°C		
Tensile Strength (% of original)	90 Min.	100
Elongation (% of original)	50 Min.	69
Oil Immersion Aging – ASTM #2 18 hours @ 120°C		
Tensile Strength (% of original)	50 Min.	69
Elongation (% of original)	50 Min.	65
7 days @ 70°C		
Tensile Strength (% of original)	70 Min.	76
Elongation (% of original)	70 Min.	74
Hot Oil Resistance, % Swell 100 hours @ 150°C	60 Max.	32
Cold Bend @ -55°C	No Cracks	No Cracks
Cold Shock 1 hour @ -40°C	No Cracks	No Cracks
Cut-Through Penetration 10 minutes @ 125°C	No Failure	Pass

* Typical values are from various General Cable and independent laboratory testing.

Important Advantages of Radiation Cross-Linking

Advantage	Reason
More flexible cable	Pressure-applied insulation and jacket are not required
No separator tapes	Less pressure is applied during the radiation process
Free stripping	Insulation is not driven into the conductor stranding
Better electrical properties	No chemical catalyst required. No residues which lower electrical properties and corrode copper
Cables and interstices kept free of water	Water is not used in the radiation cure operation
Range of insulation thickness	Radiation process can economically cross-link thin or heavy walls
Permanent colors	Radiation does not change or fade colors. Tracer colors remain vivid

Standards

Polyrad® XT cables are manufactured, tested and inspected in accordance with the latest issue of the following standards:

AAR RP-585	Wiring and Cable Specification
ASTM B33	Tinned Soft or Annealed Copper Wire
ASTM D149	Test for Dielectric Breakdown Voltage and Dielectric Strength of Electrical Insulating Materials at Commercial Power Frequencies
ICEA S-95-658	Standard for Non-Shielded Power Cables Rated 2000 V or Less for the Distribution of Electrical Energy
UL 44	Standard for Rubber Insulated Wire and Cable
IEEE 1202	Standard for Flame Testing of cables for use in cable tray within Industrial and Commercial occupancies
NFPA® 130	Standard for Fixed Guideway Transit and Passenger Rail Systems

Brand Rex
BRAND

General Cable

Polyrad® XT, Polyrad® ULTRA and Polyrad® XT-TX Wire and Cable Products

1

PRODUCT DESCRIPTION	PAGE
Polyrad® XT Flexible Wire and Cable 600 V, Single Conductor, Dual Rated – 125°C/110°C	2
Polyrad® XT Flexible Wire and Cable 2000 V, Single Conductor, Dual Rated – 125°C/110°C	3
Polyrad® XT Multi-Conductor Cable 600 V and 2000 V, 125°C, Shielded and Non-Shielded	4-5
Polyrad® ULTRA Wire 600 V, Single Conductor, 125°C, Reduced Weight, Smaller Diameter, Dual Wall	6
Polyrad® ULTRA Multi-Conductor Cable 600 V, 125°C, Shielded and Non-Shielded	7
Polyrad® XT-TX Flexible Wire and Cable 600 V, Single Conductor, NYCT Type TX	8
Polyrad® XT-TX Flexible Wire and Cable 2000 V, Single Conductor, NYCT Type TX	9



Polyrad® XT Flexible Wire and Cable

600 V, Single Conductor, Dual Rated – 125°C/110°C

Product Construction:

Conductor:

- 20 AWG thru 1111 kcmil soft annealed tinned copper per ASTM B33, B8 and B172

Insulation:

- Polyrad® XT flame-retardant, low-smoke irradiated Cross-Linked Polyolefin (XLPO)

Print:

- GENERAL CABLE® BRAND REX BRAND (WC) POLYRAD® XT 125C/110C XXAWG 600V YEAR/MONTH

Options:

- Available in multi-conductor constructions
- Class K stranding
- Available in colors other than dark gray
- Cables meeting NYCT TX Specification available upon request

Applications:

- Ideally suited for use where environmental factors require cable characteristics to perform with a high degree of flame retardancy and excellent moisture-stable electrical values. Where reliability is the major concern and where maximum performance will be demanded
- Engineered and manufactured for both original equipment and retrofit use in power and control circuits and in motor leads
- Extensively found on all types of heavy- and light-rail cars, rapid transit cars, diesel-electric locomotives, freight cars, wayside equipment and off-road vehicles

Features:

- Dual temperature rating at 125°C/110°C for long life, higher ampacities and protection from thermal overloads
- Excellent flexibility & free stripping
- Higher ampacities and simplified installations possible due to small outside diameters, flexible stranding and insulation
- Outstanding thermal stability at elevated temperatures
- Maximum flame retardance and low toxicity
- Excellent low-temperature performance; suitable for installation in sub-zero conditions
- Extra-tough, mechanically rugged irradiated thermoset insulation
- Resistant to most oils and chemicals
- Meets cold bend test at -55°C
- Meets cold impact test at -40°C

Compliances:

Industry:

- AAR S-501/AAR RP-585
- ICEA S-95-658

Flame Test:

- IEEE 1202 (70,000 BTU/hr)
- IEEE 383 (70,000 BTU/hr)
- VW-1

Other:

- BSS 7239
- SMP 800-C
- ASTM E662
- NFPA 130 STD 2010

Packaging:

- Standard reel put-up

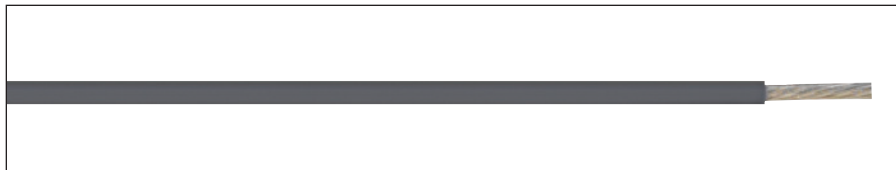

POLYRAD® XT 600 V

CATALOG NUMBER STOCK*	CONDUCTOR (AWG/kcmil) SIZE AND STRANDING		NOMINAL CONDUCTOR DIAMETER		NOMINAL INSULATION THICKNESS		NOMINAL CABLE DIAMETER		COPPER WEIGHT		NET CABLE WEIGHT		AMPACITY (FREE AIR 40°C AMBIENT)	
			INCHES	mm	MILS	mm	INCHES	mm	LBS./1000'	kg/km	LBS./1000'	kg/km	110°C	125°C
315130	20	19/32	0.038	0.97	30	0.76	0.098	2.49	4	6	8	12	15	17
280710*	18	19/30	0.048	1.21	30	0.76	0.108	2.74	6	9	11	16	17	19
280720*	16	19/29	0.054	1.37	30	0.76	0.114	2.90	8	12	13	19	23	25
280700*	14	19/27	0.067	1.70	30	0.76	0.127	3.23	12	18	17	25	39	42
296420*	12	19/25	0.086	2.18	30	0.76	0.146	3.71	19	28	26	39	51	55
303910*	10	27/24	0.117	2.97	30	0.76	0.177	4.50	34	50	42	63	67	79
296490	8	37/24	0.135	3.43	45	1.14	0.225	5.72	47	70	61	91	85	92
330230*	6	61/24	0.174	4.42	45	1.14	0.264	6.71	76	114	95	142	120	130
355320	5	91/24	0.242	6.15	45	1.14	0.332	8.43	116	173	139	211	151	163
318420	4	105/24	0.262	6.68	45	1.14	0.352	8.94	137	204	162	241	160	173
355330	3	125/24	0.285	7.24	45	1.14	0.375	9.53	167	284	191	284	199	215
355340	2	150/24	0.307	7.80	45	1.14	0.397	10.08	190	283	218	325	214	231
355350	1	225/24	0.380	9.65	55	1.40	0.490	12.45	287	427	346	515	247	267
355360	1/0	275/24	0.410	10.41	55	1.40	0.520	13.21	351	522	414	616	286	309
355370	2/0	325/24	0.470	11.94	55	1.40	0.580	14.73	407	606	471	701	329	355
355380	3/0	450/24	0.549	13.94	55	1.40	0.659	16.74	594	884	652	970	380	410
355390	4/0	550/24	0.593	15.06	55	1.40	0.703	17.86	696	1036	771	1147	446	482
355400	262	650/24	0.630	16.00	65	1.65	0.760	19.30	820	1220	913	1359	524	566
355410	313	775/24	0.685	17.40	65	1.65	0.815	20.70	987	1469	1089	1621	590	637
355420	373	925/24	0.750	19.05	65	1.65	0.880	22.35	1176	1750	1289	1918	657	710
355430	444	1100/24	0.820	20.83	65	1.65	0.950	24.13	1413	2207	1537	2287	734	793
355440	535	1325/24	0.895	22.73	80	2.03	1.055	26.80	1697	2525	1862	2771	828	894
355450	646	1600/24	0.980	24.89	80	2.03	1.140	28.96	2020	3006	2202	3277	931	1005
355460	777	1925/24	1.075	27.31	80	2.03	1.235	31.37	2435	3624	2564	3816	1047	1130
355470	929	2300/24	1.230	31.24	80	2.03	1.390	35.31	3117	4638	3401	5061	1168	1260
355480	1111	2750/24	1.328	33.73	95	2.41	1.518	38.56	3400	5060	3915	5826	1254	1354

Dimensions and weights are nominal; subject to industry tolerances.

Note: At the option of the purchaser, the manufacturer's standard type of stranding will be acceptable, providing that the conductor diameter does not exceed the values shown. The total number of wires shall be as specified, plus or minus one percent, except 150/24 which may vary by minus two percent, providing that the conductor diameter does not exceed the values shown.

*Standard stock items

Polyrad® XT Flexible Wire and Cable

2000 V, Single Conductor, Dual Rated – 125°C/110°C



POLYRAD® XT 2000 V – STANDARD INSULATION THICKNESS

CATALOG NUMBER STOCK*	CONDUCTOR (AWG/kcmil) SIZE AND STRANDING		NOMINAL CONDUCTOR DIAMETER		NOMINAL INSULATION THICKNESS		NOMINAL CABLE DIAMETER		COPPER WEIGHT		NET CABLE WEIGHT		AMPACITY (FREE AIR 40°C AMBIENT)	
			INCHES	mm	MILS	mm	INCHES	mm	LBS./1000'	kg/km	LBS./1000'	kg/km	110°C	125°C
364980	20	19/32	0.038	0.97	45	1.14	0.128	3.25	4	6	10	15	15	17
300620*	18	19/30	0.048	1.21	45	1.14	0.138	3.51	6	9	14	21	17	19
300890*	16	19/29	0.054	1.37	45	1.14	0.144	3.66	8	12	16	24	23	25
280740*	14	19/27	0.067	1.70	45	1.14	0.157	3.99	12	18	22	33	39	42
303480*	12	19/25	0.086	2.18	45	1.14	0.176	4.47	19	28	31	46	51	55
301260*	10	27/24	0.117	2.97	45	1.14	0.207	5.26	34	50	47	70	67	79
269970*	8	37/24	0.135	3.43	55	1.40	0.245	6.22	47	70	66	98	85	92
297970*	6	61/24	0.174	4.42	55	1.40	0.284	6.96	76	114	100	149	120	130
355490*	5	91/24	0.242	6.15	55	1.40	0.352	8.94	116	173	149	222	151	163
301270*	4	105/24	0.262	6.68	55	1.40	0.372	9.45	137	204	169	252	160	173
325290*	3	125/24	0.285	7.24	55	1.40	0.395	10.03	167	284	197	293	199	215
302440*	2	150/24	0.307	7.80	55	1.40	0.417	10.59	190	283	226	336	214	231
355500*	1	225/24	0.380	9.65	65	1.65	0.510	12.95	287	427	353	525	247	267
296500*	1/0	275/24	0.410	10.41	65	1.65	0.540	13.72	351	522	420	625	286	309
301280*	2/0	325/24	0.470	11.94	65	1.65	0.600	15.24	407	606	481	716	329	355
300900*	3/0	450/24	0.549	13.94	65	1.65	0.679	17.25	594	884	663	987	380	410
296510*	4/0	550/24	0.593	15.06	65	1.65	0.723	18.36	696	1036	792	1179	446	482
267040*	262	650/24	0.630	16.00	75	1.91	0.780	19.81	820	1220	931	1386	524	566
296520*	313	775/24	0.685	17.40	75	1.91	0.835	21.21	987	1469	1108	1649	590	637
304020*	373	925/24	0.750	19.05	75	1.91	0.900	22.86	1176	1750	1310	1950	657	710
300180	444	1100/24	0.820	20.83	75	1.91	0.970	24.64	1413	2207	1561	2323	734	793
263400*	535	1325/24	0.895	22.73	90	2.29	1.075	27.31	1697	2525	1888	2810	828	894
355570	646	1600/24	0.980	24.89	90	2.29	1.160	29.46	2020	3006	2231	3320	931	1005
260080	777	1925/24	1.075	27.31	90	2.29	1.255	31.88	2435	3624	2681	3990	1047	1130
355600	929	2300/24	1.230	31.24	90	2.29	1.410	35.81	3117	4638	3431	5106	1168	1260
355620	1111	2750/24	1.328	33.73	110	2.79	1.548	39.32	3400	5060	3972	5911	1254	1354

POLYRAD® XT 2000 V – HEAVY WALL INSULATION THICKNESS

355510	4/0	550/24	0.593	15.06	105	2.67	0.803	20.40	696	1036	837	1246	446	482
355520	262	650/24	0.630	16.00	105	2.67	0.840	21.34	820	1220	969	1442	524	566
355530	313	775/24	0.685	17.40	105	2.67	0.895	22.73	987	1469	1149	1710	590	637
355540	373	925/24	0.750	19.05	105	2.67	0.960	24.38	1176	1750	1353	2013	657	710
355550	444	1100/24	0.820	20.83	105	2.67	1.030	26.16	1413	2207	1607	2392	734	793
355560*	535	1325/24	0.895	22.73	120	3.05	1.135	28.83	1697	2525	1946	2896	828	894
355580	646	1600/24	0.980	24.89	120	3.05	1.220	30.99	2020	3006	2285	3400	931	1005
355590	777	1925/24	1.075	27.31	120	3.05	1.315	33.40	2435	3624	2727	4058	1047	1130
355610	929	2300/24	1.230	31.24	120	3.05	1.470	37.34	3117	4638	3539	5267	1168	1260
355630	1111	2750/24	1.328	33.73	120	3.05	1.568	39.83	3400	5060	4011	5969	1254	1354

Dimensions and weights are nominal; subject to industry tolerances.

Note #1: Where additional insulation thickness is desired for added mechanical protection, these values are noted in the second chart.

Note #2: At the option of the purchaser, the manufacturer's standard type of stranding will be acceptable providing that the conductor diameter does not exceed the values shown. The total number of wires shall be as specified, plus or minus one percent, except 150/24 which may vary by minus two percent, providing that the conductor diameter does not exceed the values shown.

*Standard stock items

Product Construction:

Conductor:

- 20 AWG thru 1111 kcmil soft annealed tinned copper per ASTM B33, B8 and B172

Insulation:

- Polyrad® XT flame-retardant, low-smoke irradiated Cross-Linked Polyolefin (XLPO)

Print:

- GENERAL CABLE® BRAND REX BRAND (WC) POLYRAD® XT 125C/110C XXAWG 2000V YEAR/MONTH

Options:

- Class K stranding
- Available in colors other than dark gray
- Cable meeting NYCT TX specification available upon request

Applications:

- Ideally suited for use where environmental factors require cable characteristics to perform with a high degree of flame retardancy and excellent moisture-stable electrical values. Where reliability is the major concern and where maximum performance will be demanded
- Engineered and manufactured for both original equipment and retrofit use in power and control circuits and in motor leads
- Extensively found on all types of heavy- and light-rail cars, rapid transit cars, diesel-electric locomotives, freight cars, wayside equipment and off-road vehicles

Features:

- Dual temperature rating at 125°C/110°C for long life, higher ampacities and protection from thermal overloads
- Excellent flexibility and free stripping
- Higher ampacities and simplified installations possible due to small outside diameters, flexible stranding and insulation
- Outstanding thermal stability at elevated temperatures
- Maximum flame retardance and low toxicity
- Excellent low-temperature performance; suitable for installation in sub-zero conditions
- Extra-tough, mechanically rugged irradiated thermoset insulation
- Resistant to most oils and chemicals
- Meets cold bend test at -55°C
- Meets cold impact test at -40°C

Compliances:

Industry:

- AAR S-501/AAR RP-585
- ICEA S-95-658

Flame Test:

- IEEE 1202 (70,000 BTU/hr)
- IEEE 383 (70,000 BTU/hr)
- VW-1

Other:

- BSS 7239
- SMP 800-C
- ASTM E662
- NFPA 130 STD 2010

Packaging:

- Standard reel put-up



Polyrad® XT Multi-Conductor Cable

600 V and 2000 V, 125°C, Shielded and Non-Shielded

General Cable manufactures an extensive array of cables to support the many and diverse applications of transit infrastructures. To meet the needs of the evolving transit and locomotive industry, General Cable consistently brings new innovative cabling concepts to market with better technology, superior safety, easier and faster installation and extended performance. Polyrad® XT multi-conductor shielded and non-shielded rapid transit and locomotive car cables are rated at 125°C and supplied in both 600 and 2000 Volt constructions.

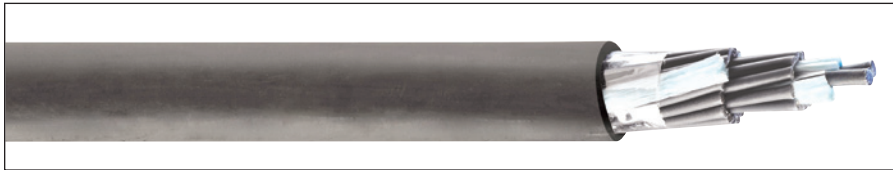

Product Construction:

Conductor:

- 20 AWG thru 4/0 AWG soft annealed tinned copper per ASTM B33, B8 and B172

Insulation:

- Polyrad® XT flame-retardant, low-smoke irradiated Cross-Linked Polyolefin (XLPO)
- Color code: black, white, red, green

Shield:

- Tinned copper braid
- Foil with drain wire

Jacket:

- Polyrad® XT flame-retardant, low-smoke irradiated Cross-Linked Polyolefin (XLPO)

Print (Including but not limited to):

- GENERAL CABLE® BRAND REX BRAND (WC) POLYRAD® XT XX/COND XXAWG SHIELDED 125C 600V YEAR/MONTH

Options:

- Available in shielded or non-shielded constructions
- Available in E1 or E2 colors

Applications:

- Ideally suited for use where environmental factors require cable characteristics to perform with a high degree of flame retardancy and excellent moisture-stable electrical values. Where reliability is the major concern and where maximum performance will be demanded
- Engineered and manufactured for both original equipment and retrofit use in electronic equipment
- Extensively found on all types of heavy- and light-rail cars, rapid transit cars, diesel-electric locomotives, freight cars, wayside equipment and off-road vehicles

Features:

- Temperature rating at 125°C for long life, higher ampacities and protection from thermal overloads
- Excellent flexibility and free stripping
- Outstanding thermal stability at elevated temperatures
- Maximum flame retardance
- Excellent low-temperature performance; suitable for installation in sub-zero conditions
- Extra-tough, mechanically rugged irradiated thermoset insulation and jacket
- Resistant to most oils and chemicals

Compliances:

Industry:

- ICEA S-95-658
- UL 44

Flame Test:

- IEEE 1202 (70,000 BTU/hr)
- IEEE 383 (70,000 BTU/hr)
- VW-1

Other:

- BSS 7239
- SMP 800-C
- ASTM E662
- NFPA 130 STD 2010

Packaging

- Standard reel put-up

Polyrad® XT Multi-Conductor Cable

600 V and 2000 V, 125°C, Shielded and Non-Shielded

The multi-conductor cables shown in the following tables are merely a sampling of General Cable's wide range of products. Other conductor sizes, designs and/or specific installation requirements are available to meet virtually all the cabling needs of the transit and locomotive industry. For more information, contact General Cable's Transit inside sales at info@generalcable.com.

TWO CONDUCTOR POLYRAD® XT SHIELDED - 36 AWG TINNED COPPER BRAID - 85% MINIMUM COVERAGE

CATALOG NUMBER	AWG		INSULATED DIAMETER		JACKET THICKNESS		CABLE DIAMETER		NET CABLE WEIGHT	
	SIZE	STRANDING	INCHES	mm	MILS	mm	INCHES	mm	LBS./1000'	kg/km
324680	20	19/32	0.098	2.49	45	1.14	0.315	8.0	59	88
376760	18	19/30	0.108	2.74	45	1.14	0.330	8.4	63	94
373770	16	19/29	0.114	2.90	45	1.14	0.345	8.8	73	109
412170	14	19/27	0.127	3.23	45	1.14	0.370	9.4	86	130
373750	12	19/25	0.146	3.71	45	1.14	0.410	10.4	109	162

THREE CONDUCTOR POLYRAD® XT SHIELDED - 36 AWG TINNED COPPER BRAID - 85% MINIMUM COVERAGE

374360	20	19/32	0.098	2.49	45	1.14	0.325	8.3	68	88
387460	18	19/30	0.108	2.74	45	1.14	0.345	8.8	72	94
373780	16	19/29	0.114	2.90	45	1.14	0.360	9.2	87	130
412180	14	19/27	0.127	3.23	45	1.14	0.390	9.7	108	161
373760	12	19/25	0.146	3.71	45	1.14	0.430	10.9	139	162

FOUR CONDUCTOR POLYRAD® XT SHIELDED - 36 AWG TINNED COPPER BRAID - 85% MINIMUM COVERAGE

412190	20	19/32	0.098	2.49	45	1.14	0.350	8.9	81	121
387570	18	19/30	0.108	2.74	45	1.14	0.380	9.7	85	127
387070	16	19/29	0.114	2.90	45	1.14	0.390	9.9	106	158
412200	14	19/27	0.127	3.23	45	1.14	0.420	10.7	131	195
412210	12	19/25	0.146	3.71	45	1.14	0.465	11.8	176	262



Polyrad® ULTRA Wire

600 V, Single Conductor, 125°C, Reduced Weight, Smaller Diameter, Dual Wall

Through our wealth of experience in providing effective cabling solutions for challenging and hazardous environments, General Cable responds to yet another industry demand. As developments and opportunities in transit technology drive the adoption of more sophisticated train networks, available space decreases and becomes more costly. As a result, the transit industry is experiencing an increasing demand for the reduction of both size and weight of cabling systems. Polyrad® ULTRA wire offers better performance, reduced weight and smaller diameters, defining the next generation of cable, ideal where high-density cabling is required. Polyrad® ULTRA singles can be designed into multi-conductor constructions that are 600 Volt and rated 125°C, ideal for high-density cabling applications.

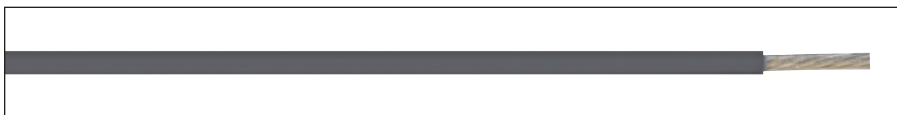

UP TO 33% WEIGHT & SPACE SAVINGS

Product Construction:

Conductor:

- 22 AWG thru 10 AWG soft annealed tinned copper per ASTM B33, B8 and B172

Dual Insulation:

- Polyrad® ULTRA flame-retardant, low-smoke irradiated Cross-Linked Polyolefin (XLPO)
- Cross-linked fluoropolymer

Print:

- GENERAL CABLE® BRAND REX BRAND (WC) POLYRAD® ULTRA 125C XXAWG 600V

Options:

- Available in multi-conductor constructions
- Available in colors other than dark gray

Applications:

- Ideally suited for use where high-density cabling is required, as this wire offers both size and weight advantages
- Engineered and manufactured for both original equipment and retrofit use in electronics equipment

Applications (cont'd):

- Utilized where environmental factors require wire characteristics to perform with a high degree of flame retardancy and excellent moisture-stable electrical values. Where reliability is the major concern and where maximum performance will be demanded
- For use on all types of heavy- and light-rail cars, rapid transit cars and diesel-electric locomotives

Features:

- Reduced diameter and lighter-weight transit wire — up to 33% smaller in diameter and lighter in weight than conventional Polyrad® XT 600 V
- Temperature rating at 125°C for long life, higher ampacities and protection from thermal overloads
- Higher ampacities and simplified installations possible due to small outside diameters, flexible stranding and insulation
- Outstanding thermal stability at elevated temperatures
- Maximum flame retardance

Features (cont'd):

- Excellent low-temperature performance; suitable for installation in sub-zero conditions
- Extra-tough, mechanically rugged irradiated thermoset insulation
- Resistant to most oils and chemicals
- Meets cold bend test at -55°C

Compliances:

- Industry:**
- ICEA S-95-658
- UL 44

Flame Test:

- IEEE 1202 (70,000 BTU/hr)
- IEEE 383 (70,000 BTU/hr)
- VW-1

Other:

- BSS 7239
- SMP 800-C
- ASTM E662
- NFPA 130 STD 2010

Packaging:

- Standard reel put-up

POLYRAD® ULTRA 600 V

CATALOG NUMBER	CONDUCTOR (AWG) SIZE AND STRANDING		NOMINAL CONDUCTOR DIAMETER		NOMINAL INSULATION THICKNESS		NOMINAL JACKET THICKNESS		COPPER WEIGHT		NOMINAL CABLE DIAMETER		NET CABLE WEIGHT		AMPACITY (FREE AIR 40°C AMBIENT)
			INCHES	mm	MILS	mm	MILS	mm	LBS./1000'	kg/km	INCHES	mm	LBS./1000'	kg/km	125°C
369550	22	19/34	0.030	0.76	10	0.254	5	0.127	2	3	0.060	1.53	4	6	14
369560	20	19/32	0.038	0.97	10	0.254	5	0.127	4	6	0.068	1.73	6	9	17
369570	18	19/30	0.048	1.22	10	0.254	5	0.127	6	9	0.078	1.98	8	12	19
369580	16	19/29	0.054	1.37	10	0.254	5	0.127	8	12	0.084	2.13	10	15	25
369590	14	19/27	0.067	1.70	10	0.254	5	0.127	12	18	0.097	2.46	15	22	42
369600	12	19/25	0.086	2.18	10	0.254	5	0.127	19	28	0.116	2.95	23	34	55
369610	10	27/24	0.117	3.05	10	0.254	5	0.127	34	50	0.147	3.73	38	57	79

Dimensions and weights are nominal; subject to industry tolerances.

Polyrad® ULTRA Multi-Conductor Cable

600 V, 125°C, Shielded and Non-Shielded

Through a wealth of experience providing effective cabling solutions for challenging and hazardous environments, General Cable responds to yet another industry demand by defining the next generation of cable — Polyrad® ULTRA. As developments and opportunities in transit technology drive the adoption of more sophisticated transit infrastructures, available space decreases. Consequently, the transit industry is experiencing an increasing demand for reduced size and weight of cabling systems. Ideal wherever space is at a premium and high-density cabling is required, Polyrad® ULTRA cables offer better performance, reduced weight and smaller diameters. Polyrad® ULTRA singles are designed into multi-conductor 600 Volt constructions rated at 125°C to meet a variety of high-density cabling applications.



Product Construction:

Conductor:

- 22 AWG thru 10 AWG soft annealed tinned copper per ASTM B33, B8 and B172

Insulation:

- Polyrad® ULTRA flame-retardant, low-smoke irradiated Cross-Linked Polyolefin (XLPO)
- Cross-linked fluoropolymer

Shield:

- Tinned copper braid
- Foil with drain wire

Jacket:

- Polyrad® XT flame-retardant, low-smoke irradiated Cross-Linked Polyolefin (XLPO)

Print (Including but not limited to):

- GENERAL CABLE® BRAND REX BRAND (WC) POLYRAD® ULTRA XX/COND XXAWG SHIELDED 125C 600V YEAR/MONTH

Options:

- Available in shielded or non-shielded constructions
- Available in E1 or E2 colors

Applications:

- Ideally suited for use where high-density cabling is required, as these cables offer both size and weight advantages
- Engineered and manufactured for both original equipment and retrofit use in electronic equipment
- Utilized where environmental factors require cable characteristics to perform with a high degree of flame retardancy and excellent moisture-stable electrical values. Where reliability is the major concern and where maximum performance will be demanded
- For use on all types of heavy- and light-rail cars, rapid transit cars, and diesel-electric locomotives

The multi-conductor cables shown in the following tables are merely a sampling of General Cable's wide range of products. Other conductor sizes, designs and/or specific installation requirements are available to meet virtually all the cabling needs of the transit and locomotive industry. For more information, contact General Cable's Transit inside sales at info@generalcable.com.

Features:

- Reduced diameter and lighter-weight transit cable - 25% smaller in diameter and lighter in weight than conventional Polyrad® XT 600 V
- Temperature rating at 125°C for long life, higher ampacities and protection from terminal overloads
- Higher ampacities and simplified installations possible due to small outside diameters, flexible stranding and insulation
- Outstanding thermal stability at elevated temperatures
- Maximum flame retardance

Features (cont'd):

- Excellent low-temperature performance; suitable for installation in sub-zero conditions
- Extra-tough, mechanically rugged irradiated thermoset insulation and jacket
- Resistant to most oils and chemicals

Compliances:

Industry:

- ICEA S-95-658
- UL 44

Flame Test:

- IEEE 1202 (70,000 BTU/hr)
- IEEE 383 (70,000 BTU/hr)
- VW-1

Other:

- BSS 7239
- SMP 800-C
- ASTM E662
- NFPA 130 STD 2010

Packaging:

- Standard reel put-up

TWO CONDUCTOR POLYRAD® ULTRA NON-SHIELDED

CATALOG NUMBER	AWG		INSULATED DIAMETER		JACKET THICKNESS		CABLE DIAMETER		NET CABLE WEIGHT	
	SIZE	STRANDING	INCHES	mm	MILS	mm	INCHES	mm	LBS./1000'	kg/km
398540	22	19/34	0.060	1.53	20	0.51	0.165	4.2	14	21
398550	20	19/32	0.068	1.73	20	0.51	0.180	4.6	18	27
398560	18	19/30	0.078	1.98	20	0.51	0.200	5.1	23	34
387700	16	19/29	0.084	2.13	20	0.51	0.215	5.5	28	42
398570	14	19/27	0.097	2.46	20	0.51	0.240	6.1	39	58
398580	12	19/25	0.116	2.95	20	0.51	0.275	7.0	56	83
398590	10	27/24	0.147	3.81	20	0.51	0.345	8.8	88	131

TWO CONDUCTOR POLYRAD® ULTRA SHIELDED - 36 AWG TINNED COPPER BRAID - 85% MINIMUM COVERAGE

398600	22	19/34	0.060	1.53	20	0.51	0.185	4.7	23	34
398610	20	19/32	0.068	1.73	20	0.51	0.200	5.1	30	45
398620	18	19/30	0.078	1.98	20	0.51	0.220	5.6	36	54
387710	16	19/29	0.084	2.13	20	0.51	0.235	6.0	42	61
398630	14	19/27	0.097	2.46	20	0.51	0.260	6.6	54	80
398640	12	19/25	0.116	2.95	20	0.51	0.300	7.6	73	109
398650	10	27/24	0.147	3.81	20	0.51	0.365	9.3	112	167

THREE CONDUCTOR POLYRAD® ULTRA NON-SHIELDED

398660	22	19/34	0.060	1.53	20	0.51	0.175	4.5	19	28
398670	20	19/32	0.068	1.73	20	0.51	0.190	4.8	25	37
398680	18	19/30	0.078	1.98	20	0.51	0.210	5.3	32	48
398690	16	19/29	0.084	2.13	20	0.51	0.225	5.7	38	57
398700	14	19/27	0.097	2.46	20	0.51	0.250	6.4	52	77
398710	12	19/25	0.116	2.95	20	0.51	0.290	7.4	78	116
398720	10	27/24	0.147	3.81	20	0.51	0.360	9.2	127	189

THREE CONDUCTOR POLYRAD® ULTRA SHIELDED - 36 AWG TINNED COPPER BRAID - 85% MINIMUM COVERAGE

398730	22	19/34	0.060	1.53	20	0.51	0.195	5.0	29	43
398740	20	19/32	0.068	1.73	20	0.51	0.210	5.3	37	55
387730	18	19/30	0.078	1.98	20	0.51	0.235	6.0	45	67
398750	16	19/29	0.084	2.13	20	0.51	0.245	6.2	52	77
398760	14	19/27	0.097	2.46	20	0.51	0.275	7.0	69	103
398770	12	19/25	0.116	2.95	20	0.51	0.315	8.0	96	143
398780	10	27/24	0.147	3.81	20	0.51	0.385	9.8	149	222



Polyrad® XT-TX Flexible Wire and Cable

600 V, Single Conductor, NYCT Type TX

Product Construction:

Conductor:

- 20 AWG thru 4/0 AWG soft annealed tinned copper per ASTM B33, B8 and B172

Insulation:

- Polyrad® XT flame-retardant, low-smoke irradiated Cross-Linked Polyolefin (XLPO)

Print:

- GENERAL CABLE® BRAND REX BRAND (WC) POLYRAD® XT-TX 1/C XXAWG 600V NYCT TX 20-88-XXXX DAY/MONTH/YEAR
XXXX = NYCT TX Stock Code - last x is used to identify insulation color as listed below:
0 = Black, 1 = White, 2 = Red, 3 = Blue, 4 = Green, 5 = Orange, 6 = Yellow, 7 = Gray, 8 = Brown, 9 = Purple

Options:

- Available in multi-conductor constructions
- Available in colors other than dark gray

Applications:

- Ideally suited for use where environmental factors require cable characteristics to perform with a high degree of flame retardancy and excellent moisture-stable electrical values. Where reliability is the major concern and where maximum performance will be demanded
- Engineered and manufactured for both original equipment and retrofit use in power and control circuits and in motor leads
- Extensively found on all types of heavy- and light-rail cars, rapid transit cars, diesel-electric locomotives, freight cars, wayside equipment and off-road vehicles

Features:

- Cables meet NYCT TX specification
- Temperature rating at 110°C
- Excellent flexibility & free stripping
- Higher ampacities and simplified installations possible due to small outside diameters, flexible stranding and insulation
- Outstanding thermal stability at elevated temperatures
- Maximum flame retardance and low toxicity
- Excellent low-temperature performance; suitable for installation in sub-zero conditions
- Extra-tough, mechanically rugged irradiated thermoset insulation
- Resistant to most oils and chemicals
- Meets cold bend test at -55°C
- Meets cold impact test at -40°C

Compliances:

Industry:

- AAR S-501/AAR RP-585
- ICEA S-95-658

Flame Test:

- IEEE 1202 (70,000 BTU/hr)
- IEEE 383 (70,000 BTU/hr)
- VW-1

Other:

- Meets NYCT TX specification
- BSS 7239
- SMP 800-C
- ASTM E662
- NFPA 130 STD 2010

Packaging:

- Standard reel put-up



POLYRAD® XT-TX 600 V

CATALOG NUMBER	NYCT TYPE TX STOCK CODE NUMBER	CONDUCTOR (AWG/kcmil) SIZE AND STRANDING		NOMINAL CONDUCTOR DIAMETER			MINIMUM AVERAGE INSULATION THICKNESS		NOMINAL CABLE DIAMETER		COPPER WEIGHT		NET CABLE WEIGHT		AMPACITY (FREE AIR 40°C AMBIENT) 110°C
				INCHES	mm	MILS	mm	INCHES	mm	LBS./1000'	kg/km	LBS./1000'	kg/km		
389980	*	20	19/32	0.038	0.97	30	0.76	0.100	2.54	4	6	9	13	15	
389990	20-88-150X	18	19/30	0.048	1.22	30	0.76	0.110	2.79	6	9	12	18	17	
389740	20-88-170X	16	19/29	0.054	1.37	30	0.76	0.116	2.95	8	13	13	19	23	
390000	20-88-190X	14	19/27	0.067	1.70	30	0.76	0.129	3.28	12	18	18	27	39	
390010	20-88-210X	12	19/25	0.086	2.18	30	0.76	0.148	3.76	19	28	27	40	51	
390020	20-88-230X	10	27/24	0.117	2.97	30	0.76	0.179	4.55	34	50	43	64	67	
390030	20-88-250X	8	37/24	0.135	3.43	45	1.14	1.227	5.77	47	70	63	94	85	
390040	20-88-270X	6	61/24	0.174	4.42	45	1.14	0.266	6.75	76	114	97	144	120	
390050	*	5	91/24	0.242	6.15	45	1.14	0.334	8.48	116	173	141	210	151	
390060	20-88-290X	4	105/24	0.262	6.65	45	1.14	0.354	8.99	137	204	164	244	160	
390070	20-88-310X	3	125/24	0.285	7.24	45	1.14	0.377	9.58	167	249	193	287	199	
390080	20-88-330X	2	150/24	0.307	7.80	45	1.14	0.399	10.14	190	283	220	327	214	
390090	20-88-380X	1	225/24	0.380	9.65	55	1.40	0.494	12.55	287	427	349	519	247	
390100	*	1/0	275/24	0.410	10.41	55	1.40	0.524	13.31	351	522	417	621	286	
390110	*	2/0	325/24	0.470	11.94	55	1.40	0.584	14.83	407	606	474	705	329	
390120	*	3/0	450/24	0.549	13.94	55	1.40	0.663	16.84	594	884	655	975	380	
390130	20-88-460X	4/0	550/24	0.593	15.06	55	1.40	0.707	17.96	696	1036	774	1152	446	

Dimensions and weights are nominal; subject to industry tolerances.

Note: At the option of the purchaser, the manufacturer's standard type of stranding will be acceptable, providing that the conductor diameter does not exceed the values shown. The total number of wires shall be as specified, plus or minus one percent, except 150/24 which may vary by minus two percent, providing that the conductor diameter does not exceed the values shown.

Please consult Customer Service for price and delivery.

*Sizes without NYCT Type TX stock code numbers are not listed in the NYCT TX specification.

Polyrad® XT-TX Flexible Wire and Cable

2000 V, Single Conductor, NYCT Type TX

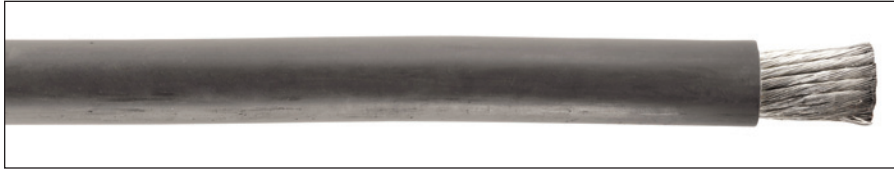

POLYRAD® XT-TX 2000 V

CATALOG NUMBER	NYCT TYPE TX STOCK CODE NUMBER	CONDUCTOR (AWG/kcmil) SIZE AND STRANDING		NOMINAL CONDUCTOR DIAMETER		MINIMUM AVERAGE INSULATION THICKNESS		NOMINAL CABLE DIAMETER		COPPER WEIGHT		NET CABLE WEIGHT		AMPACITY (FREE AIR 40°C AMBIENT)
				INCHES	mm	MILS	mm	INCHES	mm	LBS./1000'	kg/km	LBS./1000'	kg/km	
390500	*	20	19/32	0.038	0.97	45	1.14	0.130	3.30	4	6	11	16	15
390140	20-90-160X	18	19/30	0.048	1.22	45	1.14	0.140	3.56	6	9	15	22	17
390150	20-90-180X	16	19/29	0.054	1.37	45	1.14	0.146	3.71	8	13	17	25	23
390160	20-90-200X	14	19/27	0.067	1.70	45	1.14	0.159	4.04	12	18	23	34	39
390170	20-90-220X	12	19/25	0.086	2.18	45	1.14	0.178	4.52	19	28	32	48	51
390180	20-90-240X	10	27/24	0.117	2.97	45	1.14	0.209	5.31	34	50	49	73	67
390190	20-90-260X	8	37/24	0.135	3.43	55	1.40	0.249	6.33	47	70	68	101	85
390200	20-90-280X	6	61/24	0.174	4.60	55	1.40	0.288	7.32	76	114	104	155	120
390210	*	5	91/24	0.242	6.15	55	1.40	0.356	9.04	116	173	149	222	151
390220	20-90-320X	4	105/24	0.262	6.65	55	1.40	0.376	9.55	137	204	172	256	160
390230	20-90-340X	3	125/24	0.285	7.24	55	1.40	0.399	10.14	167	249	201	299	199
390240	20-90-360X	2	150/24	0.307	7.80	55	1.40	0.421	10.69	190	283	230	343	214
390250	20-90-380X	1	225/24	0.380	9.65	65	1.65	0.514	13.06	287	427	357	531	247
390260	20-90-400X	1/0	275/24	0.410	10.41	65	1.65	0.544	13.82	351	522	424	631	286
389730	20-90-420X	2/0	325/24	0.470	11.94	65	1.65	0.604	15.34	407	606	485	722	329
390270	20-90-440X	3/0	450/24	0.549	13.94	65	1.65	0.683	17.35	594	884	667	993	380
390280	20-90-460X	4/0	550/24	0.593	15.06	65	1.65	0.727	18.47	696	1036	796	1185	446
390290	20-90-480X	262	650/24	0.630	16.00	105	2.67	0.844	21.44	820	1220	936	1393	524
389750	20-90-500X	313	775/24	0.685	17.40	105	2.67	0.899	26.30	987	1469	1113	1656	590
390300	20-90-520X	373	925/24	0.750	19.05	105	2.67	0.964	24.49	1176	1750	1315	1957	657
390310	20-90-540X	444	1100/24	0.820	20.83	105	2.67	1.034	26.26	1413	2103	1566	2330	734
390320	20-90-560X	535	1325/24	0.895	22.73	105	2.67	1.109	28.17	1697	2525	1894	2819	828

Dimensions and weights are nominal; subject to industry tolerances.

Note: At the option of the purchaser, the manufacturer's standard type of stranding will be acceptable, providing that the conductor diameter does not exceed the values shown. The total number of wires shall be as specified, plus or minus one percent, except 150/24 which may vary by minus two percent, providing that the conductor diameter does not exceed the values shown.

Please consult Customer Service for price and delivery.

*Sizes without NYCT Type TX stock code numbers are not listed in the NYCT TX specification.

Product Construction:

Conductor:

- 20 AWG thru 535 kcmil soft annealed tinned copper per ASTM B33, B8 and B172

Insulation:

- Polyrad® XT flame-retardant, low-smoke irradiated Cross-Linked Polyolefin (XLPO)

Print:

- GENERAL CABLE® BRAND REX BRAND (WC) POLYRAD® XT-TX 1/C XXAWG 2000V NYCT TX 20-90-XXXX DAY/MONTH/YEAR
XXXX = NYCT TX Stock Code - last x is used to identify insulation color as listed below:
0 = Black, 1 = White, 2 = Red, 3 = Blue, 4 = Green, 5 = Orange, 6 = Yellow, 7 = Gray, 8 = Brown, 9 = Purple

Options:

- Available in colors other than dark gray

Applications:

- Ideally suited for use where environmental factors require cable characteristics to perform with a high degree of flame retardancy and excellent moisture-stable electrical values. Where reliability is the major concern and where maximum performance will be demanded
- Engineered and manufactured for both original equipment and retrofit use in power and control circuits and in motor leads
- Extensively found on all types of heavy- and light-rail cars, rapid transit cars, diesel-electric locomotives, freight cars, wayside equipment and off-road vehicles

Features:

- Cables meet NYCT TX specification
- Temperature rating at 110°C
- Excellent flexibility and free stripping
- Higher ampacities and simplified installations possible due to small outside diameters, flexible stranding and insulation
- Outstanding thermal stability at elevated temperatures
- Maximum flame retardance and low toxicity
- Excellent low-temperature performance; suitable for installation in sub-zero conditions
- Extra-tough, mechanically rugged irradiated thermoset insulation
- Resistant to most oils and chemicals
- Meets cold bend test at -55°C
- Meets cold impact test at -40°C

Compliances:

Industry:

- AAR S-501/AAR RP-585
- ICEA S-95-658

Flame Test:

- IEEE 1202 (70,000 BTU/hr)
- IEEE 383 (70,000 BTU/hr)
- VW-1

Other:

- Meets NYCT TX specification
- BSS 7239
- SMP 800-C
- ASTM E662
- NFPA 130 STD 2010

Packaging:

- Standard reel put-up



Transit Data Communications Cables

PRODUCT DESCRIPTION	PAGE
Category 5 Shielded Cable 4 Pair, 24 AWG, TIA/EIA-568-B.2 Patch	11
Polyrad® XT Transit Data Communications Cables	12-13

Category 5 Shielded Cable

4 Pair, 24 AWG, TIA/EIA-568-B.2 Patch

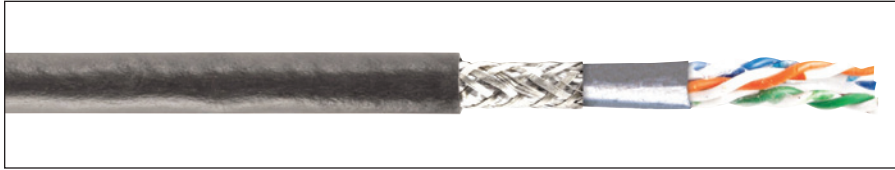

TRANSIT, 4 PAIR/24 AWG, SHIELDED FOIL TWISTED PAIR (SFTP) CAT 5, LOW SMOKE

CATALOG NUMBER	# OF PAIRS	CONDUCTOR SIZE	NOMINAL INSULATION O.D.	NOMINAL JACKET THICKNESS	NOMINAL CABLE DIAMETER
		AWG	INCHES	INCHES	INCHES
LO24P0045664	4	24 AWG 7/32	0.047	0.025	0.300

Product Construction:

Conductor:

- 4 pair, 24 AWG 7/32 tinned copper: Diameter: .024"

Insulation:

- Polyolefin: Diameter: .047"

Pairs:

- Two conductors twisted together (each pair twisted with a different lay length)
- Color code:
 - P1: White/Blue, Blue
 - P3: White/Green, Green
 - P2: White/Orange, Orange
 - P4: White/Brown, Brown

Binding:

- Polyester tape, 25% min. lap.

Inner Shield:

- Aluminum/polyester tape, 100% coverage

Outer Shield:

- Tinned copper braid, 65% coverage

Jacket:

- Polyrad® XT flame-retardant, low-smoke, irradiated Cross-Linked Polyolefin (XLPO), .025" wall, Dark Gray: Diameter: .300"

Print (Including but not limited to):

- GENERAL CABLE® (F) LO24P0045664 4PR/24 AWG SFTP CAT5 PATCH AAAAA* MO/YR** XXXXXX FT***
- *Order Number
- **Date
- ***Footage Markings every 2 ft

Applications:

- For high-speed data transmission. Tested to 100 MHz
- Category 5 construction is suitable for use in transit applications with flexible stranding, overall shield and a Polyrad® XT jacket

Features:

- Meets Category 5 electricals

Compliances:

Industry:

- TIA/EIA-568-B.2 Patch

Flame Test:

- 49 CFR Part 238 Appendix B for low-voltage wire and cable

Other:

- BSS 7239
- ASTM E662

Catalog Number:

- LO24P0045664



Polyrad® XT Transit Data Communications Cables

General Cable offers a wide variety of transit data communications cables that meet UL 1581 VW-1 flammability requirements, ASTM E662 smoke density, and Boeing BSS 7239 and Bombardier SMP 800-C toxicity standards. Transit data communications cables are produced in multi-conductors, coaxial, and shielded twisted pairs. Our high-quality products are engineered with outstanding thermal stability at elevated temperatures as well as excellent performance in sub-zero conditions. An extra-tough irradiated thermoset jacket provides resistance to most oils, chemicals, and moisture but still allows for flexibility and free stripping. General Cable also has the ability to design products specifically catered to individual customer needs and requirements.



Product Construction:

Conductor:

- 20 AWG thru 12 AWG soft annealed tinned copper per ASTM B33, B8 and B172

Insulation:

- Low-smoke irradiated Cross-Linked Polyolefin (XLPO)

Jacket

- Polyrad® XT flame-retardant, low-smoke irradiated Cross-Linked Polyolefin (XLPO)

Print (Including but not limited to):

- GENERAL CABLE® BRAND REX BRAND (WC)
POLYRAD® XT XX/COND XXAWG SHIELDED
XXX OHM 110C 600V YEAR/MONTH

Options:

- Other data communications cables available upon request

Applications:

- Ideally suited for use where specific and stable electrical values are required
- Engineered and manufactured for both original equipment and retrofit use in electronic equipment

Features:

- Excellent flexibility and free stripping
- Outstanding thermal stability at elevated temperatures
- Excellent low-temperature performance; suitable for installation in sub-zero conditions
- Extra-tough, mechanically rugged irradiated thermoset jacket
- Resistant to most oils and chemicals

Compliances:

Flame Test:

- VW-1

Other:

- BSS 7239
- SMP 800-C
- ASTM E662

Packaging:

- Standard reel put-up

Polyrad® XT Transit Data Communications Cables

The data communications cables shown in the following tables are merely a sampling of General Cable's wide range of products. Other conductor sizes, designs and/or specific installation requirements are available to meet virtually all the cabling needs of the transit and locomotive industry. For more information, contact General Cable's Transit inside sales at info@generalcable.com.

100 OHM SHIELDED DATA CABLE

CATALOG NUMBER	AWG		NUMBER OF CONDUCTORS	INSULATED DIAMETER		JACKET THICKNESS		CABLE DIAMETER		NET CABLE WEIGHT	
	SIZE	STRANDING		INCHES	mm	MILS	mm	INCHES	mm	LBS./1000'	kg/km
387090	20	19/32	2	0.092	2.34	45	1.14	0.305	8.0	55	82

Shield: 36 AWG Tinned Copper Braid - 95% Minimum Coverage Color Code: Yellow, White

387550	16	19/29	2	0.154	3.91	45	1.14	0.425	10.8	63	150
---------------	----	-------	---	-------	------	----	------	-------	------	----	-----

Shield: 36 AWG Tinned Copper Braid - 95% Minimum Coverage + Aluminum/Mylar Tape Color Code: Yellow, White

120 OHM SHIELDED DATA CABLE

329960	20	19/32	2	0.114	2.90	45	1.14	0.342	8.7	62	92
---------------	----	-------	---	-------	------	----	------	-------	-----	----	----

Shield: 36 AWG Tinned Copper Braid - 90% Minimum Coverage Color Code: Black, White

387540	18	19/30	2	0.173	4.40	45	1.14	0.460	11.7	99	147
---------------	----	-------	---	-------	------	----	------	-------	------	----	-----

Shield: 36 AWG Tinned Copper Braid - 95% Minimum Coverage + Aluminum/Mylar Tape Color Code: Yellow, White

388500	18	19/30	3	0.173	4.40	45	1.14	0.470	11.9	83	124
---------------	----	-------	---	-------	------	----	------	-------	------	----	-----

Shield: Aluminum/Mylar Tape + 22 AWG 7/30 Tinned Copper Drain Wire Color Code: White, Red, Green

329950	16	19/29	2	0.164	4.17	45	1.14	0.446	11.3	92	137
---------------	----	-------	---	-------	------	----	------	-------	------	----	-----

Shield: 36 AWG Tinned Copper Braid - 95% Minimum Coverage + Aluminum/Mylar Tape Color Code: Yellow, White

388610	20	19/32	2/Pair	0.108	2.74	45	1.14	0.510	13.0	111	165
---------------	----	-------	--------	-------	------	----	------	-------	------	-----	-----

Shield: 36 AWG Tinned Copper Braid - 90% Minimum Coverage + Aluminum/Mylar Tape Color Code: White, Blue + Red, Black

75 OHM RG 59 TYPE COAXIAL CABLE

387530	23	Solid*	1	0.147	3.73	34	0.86	0.242	6.20	38	57
---------------	----	--------	---	-------	------	----	------	-------	------	----	----

*Bare Copperweld - 40% Conductivity Shield: 34 AWG Bare Copper Braid - 90% Minimum Coverage

75 OHM RG 59 TYPE COAXIAL CABLE PLUS ONE POWER PAIR 18 AWG

Coax	23	Solid	1	0.147	3.73	34	0.86	0.242	6.20	38	57
Pair*	18	19/30	2	0.108	2.74	N/A	N/A	0.216	5.49	22	33

*Twisted together with a 3.25" lay *Color Code: Black, Red

388160	See Above		3	See Above		45	1.14	0.550	13.97	122	183
---------------	-----------	--	---	-----------	--	----	------	-------	-------	-----	-----



Transit Specialty Cables

3

PRODUCT DESCRIPTION	PAGE
Diesel Locomotive Cable 2000 Volts (EPR/XL-CPE) - SPEC 5310 UL RHH/RHW-2, 2000 V and c(UL) RW90, 1000 V Flexible, Oil-, Sunlight- and Ozone-Resistant, Flame-Retardant, -40°C to 90°C	15
Electronically Controlled Pneumatic (ECP) Brake Cable 600 V, Two Conductor, Unarmored and Armored	16
TRANSPOWER Head-End Power (HEP) 600 V Cables Single Conductor, 4/0 AWG or Three Conductor, 10 AWG	17

Diesel Locomotive Cable 2000 Volts (EPR/XL-CPE)

SPEC 5310
May, 2012

UL RHH/RHW-2 2000 V and C(UL) RW90 1000 V

Flexible, Oil-, Sunlight- and Ozone-Resistant, Flame-Retardant, -40°C to 90°C



Product Construction:

Conductor:

- 14 AWG (2.08 mm) thru 1111.1 kcmil (562 mm) Class I fully annealed flexible stranded tin coated copper per AAR 589

Insulation:

- Flame-retardant, lead-free cross-linked Ethylene Propylene (EP) with separator tape over the conductor to facilitate stripping

Jacket:

- Black, flame-retardant, sunlight-, ozone- and oil-resistant, lead-free Cross-linked Chlorinated Polyethylene (XL-CPE)

Notes:

- GENERAL CABLE® (MFG LOCATION) DIESEL LOCOMOTIVE 2000 V P-07-KA120005-MSHA C(UL)US TYPE RHH OR RHW-2 VW-1 (SIZE) AWG/kcmil (MM²) EP FOR CT USE* SR -40°C FT4 OR RW90 EP 1000 V ROHS MONTH/YEAR OF MFG SEQUENTIAL FOOTAGE MARK

*Applicable for sizes 1/0 AWG and larger only

Options:

- Fully annealed, flexible bare copper stranding per AAR 589
- Other jacket colors available upon request

Applications:

- For use up to 2000 V as power cables in wind turbine generator applications per UL Subject 6140
- Diesel electric locomotives
- Mining and earth-moving equipment
- General purpose use as flexible power leads
- Flexible power leads in cable trays in sizes 1/0 AWG and larger
- Accepted for listing as flame-resistant by MSHA

Features:

- Rated 90°C wet or dry per UL 44/CSA C.22.2-38
- Flexible tinned copper stranding
- Excellent resistance to oils, gear lubricants, ozone, sunlight, heat and flame
- Designed to withstand continuous flexing

Minimum Bend Radius:

- 8X O.D. for fixed installations or mobile applications

Torsion Requirements:

- +/-180° twists per meter for 5,000 cycles at -40°C with cable weight compensated to 18 meters

Compliances:

Industry Compliances:

- Type RHH/RHW-2 per UL 44, UL File # E90494
- c(UL)US Type RW90 per CSA C.22.2-38, UL File # E90494
- National Electrical Code (NEC)
- ICEA S-95-658/NEMA WC70
- "For CT Use" on 1/0 AWG and larger in accordance with NEC®
- Accepted for listing as flame resistant by MSHA
- RoHS Compliant

Flame Test Compliances:

- UL 2556 VW-1
- IEEE 1202/CSA FT4 for sizes 1/0 AWG and larger

AC Withstand Voltage Testing requirements per UL 44:

14 - 10 AWG	6000 V
8 - 2 AWG	7500 V
1 - 4/0 AWG	9000 V
262.6 kcmil - 444 kcmil	10000 V
535.3 kcmil - 929.9 kcmil	11000 V
1111.1 kcmil	13500 V

CATALOG NUMBER	COND. SIZE		COND. STRAND	NOMINAL COND. O.D.		NOM. INS. THICKNESS		JACKET THICKNESS		NOMINAL O.D.		APPROX. NET WEIGHT	
	AWG/kcmil	mm ²		INCHES	mm	INCHES	mm	INCHES	mm	INCHES	mm	LBS/1000 FT	kg/km
5310.01014	14	2.08	19/0147	0.070	1.8	0.045	1.1	0.015	0.4	0.20	5.1	30	45
5310.01012	12	3.31	19/0185	0.088	2.2	0.045	1.1	0.015	0.4	0.22	5.6	39	58
5310.01010	10	5.26	27/24	0.117	3.0	0.045	1.1	0.015	0.4	0.25	6.4	56	83
5310.01008	8	8.36	37/24	0.144	3.7	0.055	1.4	0.030	0.8	0.33	8.3	87	129
5310.01006	6	13.3	61/24	0.190	4.8	0.060	1.5	0.030	0.8	0.38	9.7	131	195
5310.01004	4	21.1	105/24	0.262	6.7	0.060	1.5	0.030	0.8	0.46	11.7	202	301
5310.01002	2	33.6	158/24	0.315	8.0	0.060	1.5	0.030	0.8	0.51	13.0	285	424
5310.01001	1	42.4	224/24	0.375	9.5	0.080	2.0	0.045	1.1	0.64	16.3	417	621
5310.01110	1/0	53.5	280/24	0.435	11.0	0.080	2.0	0.045	1.1	0.70	17.8	494	735
5310.01210	2/0	67.4	329/24	0.465	11.8	0.080	2.0	0.045	1.1	0.73	18.5	587	874
5310.01310	3/0	85	456/24	0.535	13.6	0.080	2.0	0.045	1.1	0.80	20.3	718	1069
5310.01410	4/0	107	551/24	0.581	14.8	0.080	2.0	0.045	1.1	0.84	21.3	845	1258
5310.01262	262.6	133	650/24	0.617	15.7	0.090	2.3	0.065	1.7	0.94	23.9	1050	1563
5310.01313	313.3	158	777/24	0.671	17.0	0.090	2.3	0.065	1.7	1.00	25.3	1195	1778
5310.01373	373.7	189	925/24	0.735	18.7	0.090	2.3	0.065	1.7	1.06	26.9	1384	2060
5310.01444	444.4	225	1110/24	0.786	20.0	0.090	2.3	0.065	1.7	1.11	28.2	1634	2432
5310.01535	535.3	271	1332/24	0.877	22.3	0.090	2.3	0.065	1.7	1.20	30.5	1925	2865
5310.01646	646.4	327	1609/24	0.960	24.4	0.090	2.3	0.065	1.7	1.29	32.8	2307	3433
5310.01777	777.7	394	1924/24	1.054	26.8	0.090	2.3	0.065	1.7	1.38	35.1	2728	4060
5310.01929*	929.9	475	2318/24	1.230	31.2	0.090	2.3	0.065	1.7	1.56	39.6	3570	5313
5310.01111*	1111.1	562	2745/24	1.328	33.7	0.115	2.9	0.095	2.4	1.77	44.9	4232	6298

* Non-stock item; minimum runs apply. Please consult Customer Service for price and delivery.



Electronically Controlled Pneumatic (ECP) Brake Cable

600 V, Two Conductor, Unarmored and Armored

Product Construction:

Conductor:

- 8 AWG soft annealed tinned copper per ASTM B33

Insulation:

- Cross-Linked Polyolefin (XLPO) - 125°C

Shield:

- 34 AWG tinned copper braid with drain wire

Jacket:

- Arctic-grade, heavy-duty reinforced Neoprene

Optional Armor:

- Galvanized steel or aluminum

Print:

- AAR ECP BRAKE CABLE S-4210 GENERAL CABLE® BRAND REX BRAND (WC) T-75128 2/C 8 AWG 600V

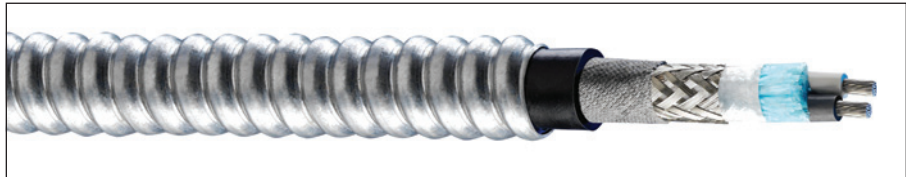
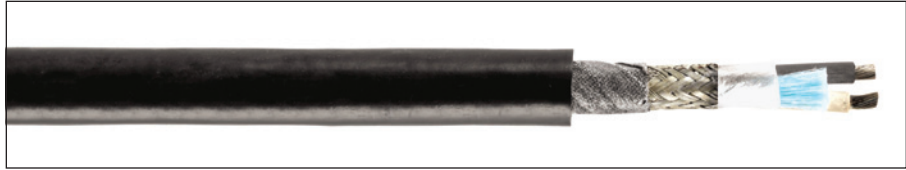

Applications:

- Designed specifically for installation both under and between freight cars
- Meets all AAR specification S-4210 requirements

Features:

- 125°C rated cross-linked polyolefin (XLPO) insulation allows for routing through higher temperature areas. Insulation is also flexible and free stripping
- Tinned copper braided shield designed for significant EMI/RFI reduction
- Arctic-grade, heavy-duty reinforced neoprene jacket offers the lowest diameter for easier conduit pull and can be used in a 3/4" conduit in lieu of 1". Excellent low-temperature performance suitable for installation in sub-zero conditions. Tough mechanical properties
- Optional galvanized or aluminum armor over the cable jacket allows for conduit-free installations providing significant installed cost savings
- Temperature range of -45°C to +100°C
- Available in assemblies/cut-to-lengths/termination

Compliances:

Industry:

- AAR S-4210

Flame Test:

- IEEE 1202 (70,000 BTU/hr)
- IEEE 383 (70,000 BTU/hr)
- VW-1

Packaging:

- Material cut to length and shipped out on non-returnable wooden reels

ECP BRAKE CABLE

CATALOG NUMBER	NUMBER OF CONDUCTORS	CONDUCTOR (AWG) SIZE AND STRANDING		NOMINAL INSULATION THICKNESS		NOMINAL JACKET THICKNESS		NOMINAL CABLE DIAMETER		NET CABLE WEIGHT		AMPACITY (FREE AIR 40°C AMBIENT) 125°C
				MILS	mm	MILS	mm	INCHES	mm	LBS./1000'	kg/km	
282400	2	8	37/24	40	1.02	100	2.54	0.725	18.42	334	497	69
287940 (ARMORED)	2	8	37/24	40	1.02	100	2.54	0.960	24.38	730	1086	69

TRANSPOWER Head-End Power (HEP) 600 V Cables

Single Conductor, 4/0 AWG or Three Conductor, 10 AWG



Product Construction

Single Conductor:

- 4/0 AWG 5320/34 Rope Bare Copper

Insulation:

- Thermoplastic Elastomer (TPE)

Jacket:

- Reinforced Neoprene – Black

Ampacity:

- 400 amps @ 30°C

Print:

- GENERAL CABLE® BRAND REX BRAND (WC)
600 VOLT 4/0 AWG

Applications:

- Head-End Power cable used in jumper assemblies locomotive-to-locomotive, locomotive-to-car and car-to-car for transmission of 480 V, 3 phase 50/60 Hz
- Designed for heavy-duty service where severe flexing is encountered

Features:

- Rated at 600 V
- Normal operating temperature: -55°C to +90°C
- Extreme temperature resistance during molding operation: 375°F
- Excellent flexibility; withstands continuous vibrations
- Outstanding resistance to moisture, oils and fluids, abrasion, tearing, compression, ozone, sunlight, flame, and heat
- Bend radius:
1/C 4/0 AWG: 3.5" minimum
3/C 10 AWG: 2.75" minimum

Industry Compliances:

- Amtrak Specification: D-77-24
- ASTM B3
- ASTM B172
- UL Standard 62
- ICEA S-95-658/NEMA WC 70



Product Construction

Three Conductors:

- 10 AWG 259/34 Tinned Copper

Insulation:

- Thermoplastic Elastomer (TPE)

Jacket:

- Neoprene – Black

Color Code:

- Black, White, Red

Print:

- GENERAL CABLE® BRAND REX BRAND (WC)
600 VOLT TRANSPower 3/C 10 AWG

TRANSPOWER HEAD-END POWER (HEP) 600 V CABLES

CATALOG NUMBER	NUMBER OF CONDUCTORS	CONDUCTOR (AWG) SIZE AND STRANDING		NOMINAL INSULATION THICKNESS		NOMINAL JACKET THICKNESS		NOMINAL CABLE DIAMETER		NET CABLE WEIGHT		AMPACITY (FREE AIR 30°C AMBIENT)
				MILS	mm	MILS	mm	INCHES	mm	LBS./1000'	kg/km	
650870.00.77	1	4/0	5320/34	60	1.52	85	2.16	0.885	22.5	872	1298	400
696420.00.77	3	10	259/34	47	1.19	93	2.36	0.685	17.4	338	503	40

GENERAL TECHNICAL INFORMATION	PAGE
SPEC A100 Common Color Sequence	19
SPEC A125 Temperature Conversion Table	20
SPEC A150 Metric Conversion Factors	21
SPEC A186 AWG (American Wire Gauge) to MM ² (Millimeters Squared) Conversion	22
SPEC A200 Reel Capacity Chart	23
SPEC A210 Flame Test Comparison	24
CONDUCTOR DATA	
SPEC B040 Class I Conductors for General Wiring	25
SPEC B045 Class K Conductors for General Wiring	26
HANDLING AND STORAGE RECOMMENDATIONS	
SPEC D001 Minimum Bend Radius	27
SPEC D005 Recommended Reel Handling Practices	28
SPEC D025 Recommended Cable Handling Practices	29
SPEC D050 Recommended Cable Storage Practices	30
PART NUMBER INDEX	31

Common Color Sequence

SPEC A100
April, 2011

Table E1 Color Sequence

COND. NO.	BACKGROUND OR BASE COLOR	FIRST TRACER COLOR	SECOND TRACER COLOR	COND. NO.	BACKGROUND OR BASE COLOR	FIRST TRACER COLOR	SECOND TRACER COLOR
1	Black	-	-	20	Red	Green	-
2	White	-	-	21	Orange	Green	-
3	Red	-	-	22	Black	White	Red
4	Green	-	-	23	White	Black	Red
5	Orange	-	-	24	Red	Black	White
6	Blue	-	-	25	Green	Black	White
7	White	Black	-	26	Orange	Black	White
8	Red	Black	-	27	Blue	Black	White
9	Green	Black	-	28	Black	Red	Green
10	Orange	Black	-	29	White	Red	Green
11	Blue	Black	-	30	Red	Black	Green
12	Black	White	-	31	Green	Black	Orange
13	Red	White	-	32	Orange	Black	Green
14	Green	White	-	33	Blue	White	Orange
15	Blue	White	-	34	Black	White	Orange
16	Black	Red	-	35	White	Red	Orange
17	White	Red	-	36	Orange	White	Blue
18	Orange	Red	-	37	White	Red	Blue
19	Blue	Red	-				

Pair cables are Black, White and numbered. Triad cables are Black, White, Red and numbered.

**Method 4 -
All Conductors Black**

COND.	CONDUCTOR PRINTING
1st	"1-One"
2nd	"2-Two"
3rd	"3-Three"
4th	"4-Four"
5th	"5-Five"

Table E2 Color Sequence

COND. NO.	BACKGROUND OR BASE COLOR	TRACER COLOR	COND. NO.	BACKGROUND OR BASE COLOR	TRACER COLOR
1	Black	-	19	Orange	Blue
2	Red	-	20	Yellow	Blue
3	Blue	-	21	Brown	Blue
4	Orange	-	22	Black	Orange
5	Yellow	-	23	Red	Orange
6	Brown	-	24	Blue	Orange
7	Red	Black	25	Yellow	Orange
8	Blue	Black	26	Brown	Orange
9	Orange	Black	27	Black	Yellow
10	Yellow	Black	28	Red	Yellow
11	Brown	Black	29	Blue	Yellow
12	Black	Red	30	Orange	Yellow
13	Blue	Red	31	Brown	Yellow
14	Orange	Red	32	Black	Brown
15	Yellow	Red	33	Red	Brown
16	Brown	Red	34	Blue	Brown
17	Black	Blue	35	Orange	Brown
18	Red	Blue	36	Yellow	Brown

Pair cables are Black, Red and numbered. Triad cables are Black, Red, Blue and numbered. Colors repeat after 36 conductors. There are no Green or White conductors or stripes.

ANSI MC 96.1 Conductor Alloy and Color Code

COND. TYPE	POSITIVE WIRE		NEGATIVE WIRE		OUTER JACKET
	ALLOY	COLOR	ALLOY	COLOR	
EX	Chromel	Purple	Constantan	Red	Purple
JX	Iron	White	Constantan	Red	Black
KX	Chromel	Yellow	Alumel	Red	Yellow
TX	Copper	Blue	Constantan	Red	Blue

Temperature Conversion Table

SPEC A125
October, 2011

Known temperature is in boldface type-**Temp (°F or °C)**. Corresponding temperature in degrees Fahrenheit will be found in the column to the right. Corresponding temperature in degrees Centigrade will be found in the column to the left.

-5 TO -100			0 TO 100					100 TO 500			
°C	Temp (°F or °C)	°F	°C	Temp (°F or °C)	°F	°C	Temp (°F or °C)	°F	°C	Temp (°F or °C)	°F
-73.3	-100	-148	-17.8	0	32.0	10.0	50	122.0	38	100	212
-70.5	-95	-139	-17.2	1	33.8	10.6	51	123.8	43	110	230
-67.8	-90	-130	-16.7	2	35.6	11.1	52	125.6	49	120	248
-65.0	-85	-121	-16.1	3	37.4	11.7	53	127.4	54	130	266
-62.2	-80	-112	-15.6	4	39.2	12.2	54	129.2	60	140	284
-59.5	-75	-103	-15.0	5	41.0	12.8	55	131.0	66	150	302
-56.7	-70	-94	-14.4	6	42.8	13.3	56	132.8	71	160	320
-53.9	-65	-85	-13.9	7	44.6	13.9	57	134.6	77	170	338
-51.1	-60	-76	-13.3	8	46.4	14.4	58	136.4	82	180	356
-48.3	-55	-67	-12.8	9	48.2	15.0	59	138.2	88	190	374
-45.6	-50	-58	-12.2	10	50.0	15.6	60	140.0	93	200	392
-42.8	-45	-49	-11.7	11	51.8	16.1	61	141.8	99	210	410
-40.0	-40	-40	-11.1	12	53.6	16.7	62	143.6	100	212	413
-37.2	-35	-31	-10.6	13	55.4	17.2	63	145.4	104	220	428
-34.4	-30	-22	-10.0	14	57.2	17.8	64	147.2	110	230	446
-31.6	-25	-13	-9.44	15	59.0	18.3	65	149.0	116	240	464
-28.9	-20	-4	-8.89	16	60.8	18.9	66	150.8	121	250	482
-26.1	-15	5	-8.33	17	62.6	19.4	67	152.6	127	260	500
-23.3	-10	14	-7.78	18	64.4	20.0	68	154.4	132	270	518
-20.5	-5	23	-7.22	19	66.2	20.6	69	156.2	138	280	536
			-6.67	20	68.0	21.1	70	158.0	143	290	554
			-6.11	21	69.8	21.7	71	159.8	149	300	572
			-5.56	22	71.6	22.2	72	161.6	154	310	590
			-5.00	23	73.4	22.8	73	163.4	160	320	608
			-4.44	24	75.2	23.3	74	165.2	166	330	626
			-3.89	25	77.0	23.9	75	167.0	171	340	644
			-3.33	26	78.8	24.4	76	168.8	177	350	662
			-2.78	27	80.6	25.0	77	170.6	182	360	680
			-2.22	28	82.4	25.6	78	172.4	188	370	698
			-1.67	29	84.2	26.1	79	174.2	193	380	716
			-1.11	30	86.0	26.7	80	176.0	199	390	734
			-0.56	31	87.7	27.2	81	177.8	204	400	752
			0	32	89.6	27.8	82	179.6	210	410	770
			0.56	33	91.4	28.3	83	181.4	216	420	788
			1.11	34	93.2	28.9	84	183.2	221	430	806
			1.67	35	95.0	29.4	85	185.0	227	440	824
			2.22	36	96.8	30.0	86	186.8	232	450	842
			2.78	37	98.6	30.6	87	188.6	238	460	860
			3.33	38	100.4	31.1	88	190.4	243	470	878
			3.89	39	102.2	31.7	89	192.2	249	480	896
			4.44	40	104.0	32.2	90	194.0	254	490	914
			5.00	41	105.8	32.8	91	195.8	260	500	932
			5.56	42	107.6	33.3	92	197.6			
			6.11	43	109.4	33.9	93	199.4			
			6.67	44	111.2	34.4	94	201.2			
			7.22	45	113.0	35.0	95	203.0			
			7.78	46	114.8	35.6	96	204.8			
			8.33	47	116.6	36.1	97	206.6			
			8.89	48	118.4	36.7	98	208.4			
			9.44	49	120.2	37.2	99	210.2			
						37.8	100	212.0			

Interpolation Factors

°C	Temp (°F or °C)	°F	°C	Temp (°F or °C)	°F	°C	Temp (°F or °C)	°F
0.56	1	1.8	2.22	4	7.2	3.89	7	12.6
1.11	2	3.6	2.78	5	9.0	4.44	8	14.4
1.67	3	5.4	3.33	6	10.8	5.00	9	16.2

Metric Conversion Factors

SPEC A150
January, 2010

	To Convert From	To	Multiply By	
Length	Inches	Millimeters	25.4	
	Millimeters	Inches	0.03937	
	Inches	Centimeters	2.54	
	Centimeters	Inches	0.3937	
	Feet	Meters	0.3048	
	Meters	Feet	3.2808	
	kilofeet (1000 ft)	kilometers	0.3048	
	kilometers	kilofeet (1000 ft)	3.2808	
Area	Square Inches	Square Millimeters	645.16	
	Square Millimeters	Square Inches	0.00155	
	Square Inches	Square Centimeters	6.4516	
	Square Centimeters	Square Inches	0.155	
	Square Inches	Circular Mils	1,273,240	
	Circular Mils	Square Inches	7.854×10^{-7}	
	Circular Mils	Square Millimeters	5.066×10^4	
	Square Millimeters	Circular Mils	1973.51	
Weight	Square Feet	Square Meters	0.0929	
	Square Meters	Square Feet	10.764	
	Pounds	Kilograms	0.4536	
	Kilograms	Pounds	2.2046	
	Pound/Kilofeet	Kilograms/Kilometer	1.4882	
	Kilograms/Kilometer	Pounds/Kilofeet	0.6720	
	Electrical	Ohms/Kilofeet	Ohms/Kilometer	3.2808
		Ohms/Kilometer	Ohms/Kilofeet	0.3048
Microfarads/Kilofeet		Microfarads/Kilometer	3.2808	
Microfarads/Kilometer		Microfarads/Kilofeet	0.3048	
Insulation Resistance:				
Megohms—Kilofeet		Megohms—Kilometer	0.3048	
Megohms—Kilometer		Megohms—Kilofeet	3.2808	
Mechanical		Pounds/Square Inch	Kilo Pascal*	6.895
	Kilo Pascal*	Pounds/Square Inch	0.1432	
	Pounds (force)	Newtons	4.448	

* 1 Pascal = 1 newton/m²

AWG (American Wire Gauge) to MM² (Millimeters Squared) Conversion

SPEC A186
October, 2011

AWG/KCMIL	Circ. Mils ¹	Cross-Sectional Area (mm ²)
929	929,200	471
	789,410	400
777	777,700	394
750	750,000	380
646	646,400	327
600	600,000	304
	592,058	300
535	535,300	271
500	500,000	253
	473,646	240
444	444,400	225
400	400,000	203
373	373,700	187
	365,102	185
350	350,000	177
313	313,100	159
300	300,000	152
	296,029	150
262	262,600	133
250	250,000	127
	236,823	120
4/0	216,900	110
	187,485	95
3/0	174,800	89
	138,147	70

AWG/KCMIL	Circ. Mils ¹	Cross-Sectional Area (mm ²)
2/0	134,200	68
1/0	108,350	55
	98,676	50
1	87,295	44
	69,073	35
2	63,480	32
	49,338	25
4	42,080	21
	31,576	16
6	25,440	12.9
	19,735	10.0
8	15,730	8.0
	11,841	6.0
10	10,645	5.4
	7,894	4.0
12	6,309	3.2
	4,934	2.50
14	3,970	2.04
	2,960	1.50
16	2,503	1.31
	1,974	1.00
18	1,760	0.82
	1,480	0.75
20	1,118	0.52
	987	0.50

¹ Circular Mil Area values are approximate and are provided as a reference guide.

Reel Capacity Chart

SPEC A200
October, 2011



WOOD REELS

Reel (FxB)	30x18x12	36x24x17	40x24x17	45x28x21	50x32x24	58x32x28	72x36x36	84x36x48	90x36x48
RM Code	61-1215	61-1659	61-1808	61-2056	61-2253	61-2764	61-3655	61-4265	61-4366
Arbor Hole	2.75	3.06	3.06	3.06	3.06	3.06	3.06	3.5	3.5
Drive Hole	1	1	1	1.5	1.5	1.5	1.5	1.5	1.5
Drive Hole Radius	4.5	6	6	8.5	10	10	10	10	10
Clearance	1.5	2	2	2	2	2	2	2	3
Factor	509.3	1155.4	1582.8	2274.2	3227.7	4468.6	7847.4	9658.4	11205.2
Max Weight	750	1500	2000	3000	4800	6500	8000	9000	10,000
Net Weight	47	91	110	142	208	271	513	744	821
Cable OD									
.241 - .250	11040								
.251 - .260	10200								
.261 - .270	9460								
.271 - .280	8800								
.281 - .290	8200								
.291 - .300	7660								
.301 - .310	7180								
.311 - .320	6740	10790							
.321 - .330	6330	10110							
.331 - .340	5970	9610							
.341 - .350	5630	9030							
.351 - .360	6320	8490							
.361 - .370	5040	8100							
.371 - .380	4780	7620	10520						
.381 - .390	4530	7300	9940						
.391 - .400	4310	6880	9540						
.401 - .410	4100	6600	9030						
.411 - .420	3910	6230	8550	12580					
.421 - .430	3730	6000	8220	11940					
.431 - .440	3560	5660	7790	11330					
.441 - .450	3410	5450	7510	10910					
.451 - .460	3260	5250	7120	10370	15010				
.461 - .470	3120	4970	6880	10000	14290				
.471 - .480	2990	4700	6530	9510	13790				
.481 - .490	2870	4630	6310	9180	13150				
.491 - .500	2760	4390	6110	8880	12700				
.501 - .525	2500	4040	5530	8050	11540				
.526 - .550	2280	3650	5030	7330	10510				
.551 - .575	2090	3310	4580	6680	9610				
.576 - .600	1920	3080	4180	6110	8800				
.601 - .625	1770	2810	3910	5590	8050				
.626 - .650	1630	2630	3580	5240	7430	10420			
.651 - .675	1510	2400	3280	4820	6970	9630			
.676 - .700	1410	2260	3090	4530	6430	8900			
.701 - .725	1310	2070	2840	4180	5940	8260			
.726 - .750	1230	1950	2690	3950	5610	7800			
.751 - .775	1150	1840	2480	3650	5190	7250			
.776 - .800	1080	1690	2350	3460	4920	6870			
.801 - .825	1010	1610	2230	3200	4670	6400	11530		
.826 - .850	950	1530	2060	3040	4340	6090	10860		
.851 - .875	900	1450	1970	2900	4130	5680	10250		
.876 - .900	850	1340	1880	2690	3850	5420	9690		
.901 - .925	810	1280	1735	2570	3670	5060	9170	11290	
.926 - .950	760	1220	1660	2460	3510	4840	8700	10700	
.951 - .975	730	1170	1590	2280	3270	4630	8250	10160	
.976 - 1.000	690	1075	1525	2190	3130	4340	7850	9660	11210
1.001 - 1.050	630	990	1360	2010	2880	3990	7120	8760	10160
1.051 - 1.100	570	910	1260	1800	2590	3600	6490	7980	9260
1.101 - 1.150	520	810	1120	1670	2400	3250	5930	7300	8470
1.151 - 1.200	480	750	1040	1500	2160	3030	5450	6710	7780
1.201 - 1.250	440	700	980	1400	2020	2740	5020	6180	7170
1.251 - 1.300	410	650	870	1310	1820	2570	4640	5720	6630
1.301 - 1.350	380	580	820	1180	1710	2410	4320	5300	6150
1.351 - 1.400	350	550	770	1110	1610	2190	4000	4930	5720
1.401 - 1.450	330	520	690	1040	1460	2070	3730	4590	5330
1.451 - 1.500	310	490	650	990	1370	1950	3490	4290	4980
1.501 - 1.600	270	410	590	840	1230	1690	3070	3770	4380
1.601 - 1.700	240	370	500	760	1060	1520	2720	3340	3880
1.701 - 1.800		330	450	650	960	1325	2420	2980	3460
1.801 - 1.900			420	600	880	1210	2170	2680	3100
1.901 - 2.000				540	760	1060	1960	2410	2800
2.001 - 2.100				500	700	970	1740	2190	2540
2.101 - 2.200					650	900	1620	2000	2320
2.201 - 2.300					600	790	1480	1830	2120
2.301 - 2.400					520	740	1360	1680	1950
2.401 - 2.500					490	690	1260	1550	1790
2.501 - 2.600					460	640	1160	1430	1660
2.601 - 2.700					430	600	1080	1320	1540
2.701 - 2.800						530	1000	1230	1430
2.801 - 2.900						500	930	1150	1330
2.901 - 3.000						470	870	1070	1250
3.001 - 3.100						440	820	1010	1170
3.101 - 3.200						420	770	940	1090
3.201 - 3.300						400	720	890	1030
3.301 - 3.400						380	680	840	970
3.401 - 3.500							640	790	910

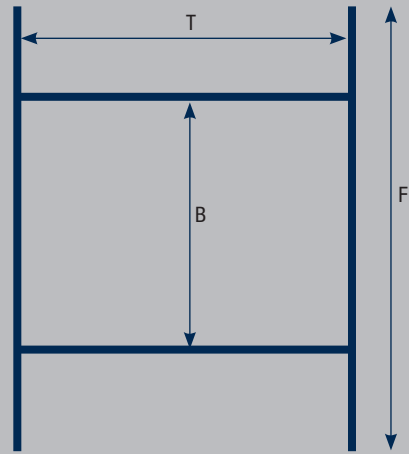

F = Flange Diameter
T = Traverse Width
B = Drum Diameter

Flame Test Comparison

The flammability of a cable is normally the ability of the material to cease burning once the source of heat is removed. Several tests have been formulated to measure this requirement.

UL FLAME TESTS

UL 1581 Vertical Tray Flame Test:

This test is conducted on cables lashed to a vertical metal ladder tray 8 feet in height. The combustion source is a ribbon burner with a flame temperature of approximately 1500°F which supplies 70,000 BTU of heat per hour. The flame application time is 20 minutes. This test requires the cable to self-extinguish prior to reaching the top of the tray which is 8 feet in height. A UL Type TC (Tray-Rated) cable must meet this test. UL 1581 is an equivalent test for IEEE 383-1974.

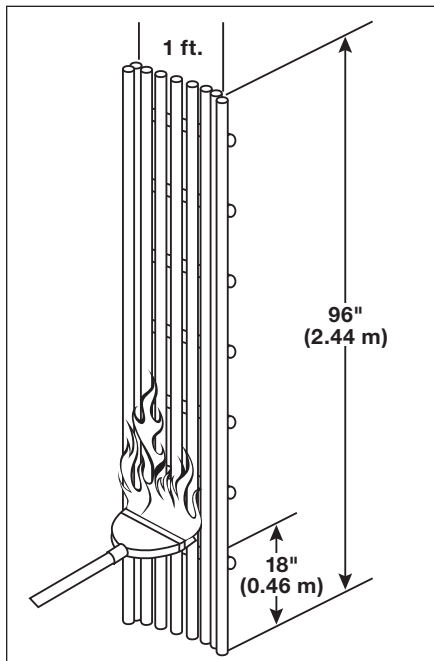

UL 1581 Vertical Tray Flame Test

UL 1581 VW-1 Vertical Wire Flame Test:

This is a small-scale test conducted on a single 24" length of wire. The flame source is a Tirrill burner (similar to a Bunsen burner) with a heat output of approximately 3,000 BTU per hour. The flame is applied for 15 seconds and then is reapplied four more times. If the sample burns longer than 60 seconds after any application, or if the indicator flag or the cotton laid below the wire is ignited during the test, the cable fails the test.

Per AAR RP-585 – Application of the flame shall be 5 times with 15-second rest periods with 10 seconds maximum burn after each flame application.

Per NYCT - Application of the flame shall be 5 times with 15-second rest periods with 3 seconds maximum burn after each flame application.

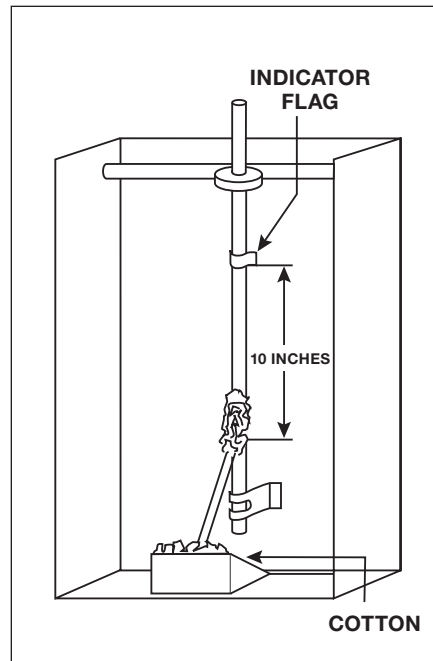

UL 1581 VW-1 Flame Test

IEEE FLAME TESTS

IEEE 1202

This test is conducted on cables lashed to a vertical metal ladder tray 8 feet in height. The combustion source is a ribbon burner with a flame temperature of approximately 1500°F which supplies 70,000 BTU of heat per hour. The flame application time is 20 minutes. To pass this test, the resulting char distance must not be greater than 1.5 meters (4.92 feet) from the point of flame application. This test is very similar to the CSA FT4 flame test. It is also similar to but more severe than the UL 1581 Vertical Tray Flame Test.

[See *UL 1581 Vertical Flame Test*]

CSA FLAME TESTS

CSA FT4 Vertical Tray Flame Test (CSA C22.2 No. 03):

This test is conducted on cables lashed to a vertical metal ladder tray 8 feet in height. The combustion source is a ribbon burner with a flame temperature of approximately 1500°F which supplies 70,000 BTU of heat per hour. The flame application time is 20 minutes. To pass this test, the resulting char distance must not be greater than 1.5 meters (4.92 feet) from the point of flame application. This test is very similar to the IEEE 1202 flame test. It is also similar to, but more severe than the UL 1581 Vertical Tray Flame Test.

[See *UL 1581 Vertical Flame Test*]

Class I Conductors for General Wiring

SPEC B040
October, 2011

Copper Conductor

ASTM CLASS I

SIZE	STRANDING	NOMINAL AREA		NOMINAL DIAMETER		NOMINAL WEIGHT	
		AWG/kcmil	INCHES	CIRCULAR MILS	mm ²	INCHES	mm
10	27/24	10,910	5.53	0.117	2.97	34	51
9	—	—	—	—	—	—	—
8	37/24	14,950	7.57	0.135	3.43	46	68
7	—	—	—	—	—	—	—
6	61/24	24,640	12.50	0.174	4.42	77	114
5	91/24	36,760	19	0.242	6.15	116	173
4	105/24	42,420	21	0.262	6.60	137	204
3	126/24	50,500	25	0.285	7.24	167	249
2	147/24	60,600	31	0.307	7.80	190	283
1	224/24	90,900	46	0.380	9.65	287	427
1/0	273/24	111,100	56	0.410	10.41	351	522
2/0	323/24	131,300	66	0.470	11.90	407	606
3/0	456/24	184,200	92	0.549	13.94	594	884
4/0	551/24	222,600	112	0.593	14.70	696	1035
250	—	—	—	—	—	—	—
262.6	646/24	261,000	133	0.630	16	820	1220
300	—	—	—	—	—	—	—
313.1	777/24	313,900	159	0.685	17.40	987	1469
350	—	—	—	—	—	—	—
373.7	925/24	373,700	189	0.750	19	1176	1750
400	—	—	—	—	—	—	—
444.4	1110/24	448,400	225	0.820	20.80	1413	2103
500	—	—	—	—	—	—	—
535.3	1332/24	538,100	271	0.895	22.70	1697	2525
592	1480/24	597,900	303	0.972	24.70	1858	2765
600	—	—	—	—	—	—	—
646.4	1591/24	642,800	327	0.980	24.90	2020	3006
750	—	—	—	—	—	—	—
777.7	1924/24	777,700	394	1.075	27.30	2435	3624
1000	—	—	—	—	—	—	—
1111	2745/24	1,111,000	563	1.328	33.70	3400	5059

Dimensions and weights are nominal; subject to industry tolerances.

Class K Conductors for General Wiring

SPEC B045
October, 2011

Copper Conductor

ASTM CLASS K

SIZE AWG/kcmil	STRANDING INCHES	NOMINAL AREA		NOMINAL DIAMETER		NOMINAL WEIGHT	
		CIRCULAR MILS	mm ²	INCHES	mm	LBS/KFT	kg/km
22	—	—	—	—	—	—	—
20	10/30	1,020	0.52	0.036	0.91	3.2	4.8
18	16/30	1,620	0.82	0.046	1.20	5	7.4
16	26/30	2,580	1.31	0.057	1.40	7.97	12
14	41/30	4,110	2.08	0.071	1.80	12.8	19
12	65/30	6,530	3.31	0.088	2.20	20.3	30.2
10	105/30	10,380	5.26	0.112	2.80	33.3	49.6
9	133/30	13,090	6.63	0.150	3.80	42.4	63.1
8	168/30	16,510	8.37	0.164	4	53.2	80.8
7	210/30	20,820	10.50	0.175	4.40	66.8	99.4
6	266/30	26,240	13.30	0.198	5.00	84.2	125
5	336/30	33,090	16.80	0.261	6.60	106	158
4	420/30	41,740	21.20	0.249	6.30	132	196
3	532/30	52,620	26.70	0.298	7.60	169	251
2	665/30	66,360	33.60	0.317	8.10	211	314
1	836/30	83,690	42.40	0.356	9	266	396
1/0	1064/30	105,600	53.50	0.401	10	338	503
2/0	1323/30	133,100	67.40	0.501	13	425	632
3/0	1666/30	167,800	85	0.562	14	535	796
4/0	2107/30	211,600	107	0.627	15.93	676	1006
250	2499/30	250,000	127	0.688	17	802	1193
262.6	2220/30	222,000	112	0.680	17	824	1226
300	2989/30	300,000	152	0.753	19	960	1428
313.1	3136/30	313,600	159	0.750	19	969	1442
350	3458/30	350,000	177	0.818	21	1120	1667
373.7	3737/30	373,700	189	0.790	20	1210	1800
400	3990/30	400,000	203	0.878	22	1290	1920
444.4	—	—	—	—	—	—	—
500	5054/30	500,000	253	0.990	25	1635	2433
535.3	5320/30	532,000	270	0.950	24	1641	2442
592	—	—	—	—	—	—	—
600	5985/30	600,000	340	1.125	29	1950	2902
646.4	6466/30	646,600	328	1.040	26	1987	2957
750	7448/30	750,000	380	1.276	32	2427	3611
777.7	—	—	—	—	—	—	—
1000	9975/30	1,000,000	507	1.498	38	3250	4769
1111	—	—	—	—	—	—	—

Dimensions and weights are nominal; subject to industry tolerances.

Minimum Bend Radius

SPEC D001
October, 2011

Standard Thermosetting (XLP, Rubber) and Thermoplastic (PE, PVC, etc.) Insulated and Jacketed Single and Multi-Conductor Cables	Permanent Training After Installation (Static)	Pulling/Flexing (Dynamic)
a. Without Shield or Armor, O.D. Less Than 1.0"	4	10
b. Without Shield or Armor, O.D. Greater Than 1.0"	5	12
c. With Overall Braided Copper Shield	5	12
d. With Aluminum/Polyester Shield	5	12
e. With 26 AWG or Smaller Braided Steel or Alloy Armor	6	14
f. With Solid Overall Flat Metallic Copper Tape Shield	10	20
g. With Solid Overall Flat Metallic Tape Armor	12	24
h. With Interlocked Armor ("S" Profile)	7	14
i. With Components Individually Shielded with Copper Braids or Laminated Copper or Aluminum/Polyester Tapes	5	12
j. With Corrugated Armor or Shield Tape	8	16
k. Coax & Triax	4	20

Multiply the ratio in this table times the nominal (calculated) overall cable diameter to obtain the minimum bending radius.

Recommended Reel Handling Practices

SPEC D005
January, 2010

How to Handle Cable Reels

YES

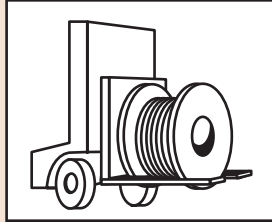

Cradle both reel flanges between forks.

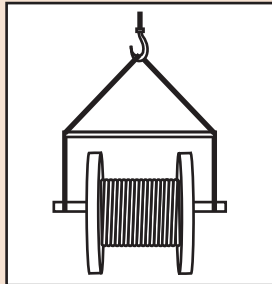

Reels can be hoisted with a shaft extended through both flanges.

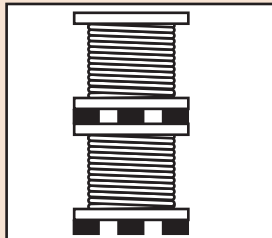

Place spacers under the bottom flange and between reels to create a space to insert the forks.

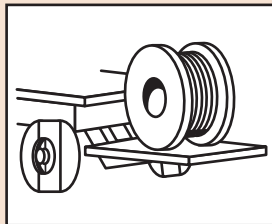

Lower reels from truck using hydraulic gate, hoist or fork lift. LOWER CAREFULLY.

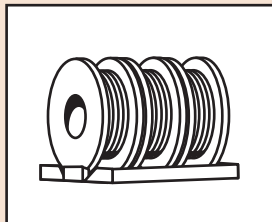

Always load with flanges on edge and chock and block securely.

NO

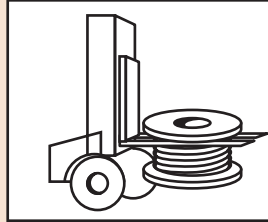

Do not lift by top flange. Cable or reel will be damaged.

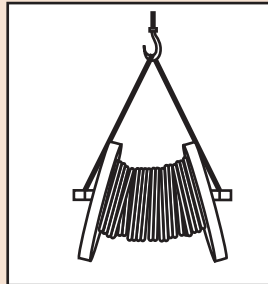

Use a spreader bar to prevent bending the reel flanges and mashing the cable.

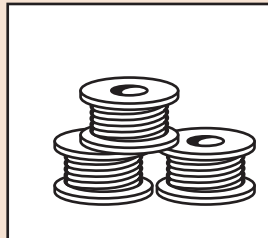

Upended heavy reels will often arrive damaged. Refuse or receive subject to inspection for hidden damage.

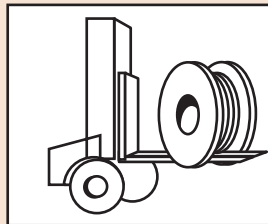

Never allow forks to touch cable surface or reel wrap.

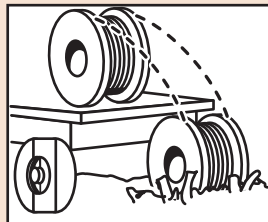

Never drop reels.

Recommended Cable Handling Practices

SPEC D025
October, 2011

Unloading and Moving of Reels:

Cable reels are never shipped upended (flat side down). Cable reels that arrive in this manner should be rejected or received only after a thorough inspection for damage.

See "Recommended Reel Handling Practices" page.

Upon receipt, a cable's protective covering and/or lagging should be inspected for evidence of damage during shipment. If evidence of damage is found, a report should immediately be made to the carrier.

Under no circumstances should reels be dropped from the delivering vehicle to the ground.

Unloading and reel handling should be accomplished so that the equipment used does not contact the cable surface, and in the case of protective wrap, that the equipment does not contact the protective wrap.

If unloading and reel handling is accomplished by crane, either a cradle supporting the reel flanges or a shaft through the arbor hole should be used. If a fork lift is utilized, the forks must lift the reel at 90° to the flanges and the forks must be long enough to make complete lifting contact with both flanges. Under no circumstances should the forks come into contact with the cable surface or the protective wraps.

When a reel of cable is rolled from one point to another, care must be taken to see that there are no objects on the surface area which could contact or damage the cable surface or protective wrap.

If an inclined ramp is used for unloading, the ramp must be wide enough to contact both flanges completely. The stopping of the reels at the bottom shall be accomplished by using the reel flanges and not the surface of the cable.

Minimum Drum Diameters for Packaging Cables	
Type of Cable	Minimum Drum Diameter as a Multiple of Outside Diameter of Cable
1. Single and multiple conductor cable - unshielded 0-2000 V	10
2. Single and multiple conductor cable - unshielded 2400 V	12
3. Single and multiple conductor cable - wire shield (UniShield®) 5-35 kV	12
4. Single and multiple conductor cable - helically applied tape shield (Uniblend®) 5-35 kV	14
5. Single and multiple conductor cable - longitudinally applied flat tape shield (Type TC)	20
6. Single and multiple conductor cable - Interlocked Armor (Duralox®) 600 V-35 kV	14
7. Triplexed single conductors cabled together. The circumscribing overall diameter* shall be multiplied by the factor in 1 - 6 and then by the reduction factor.	.75

*Single conductor times 2.155 times
NEMA WC26 EEMAC201-2007 Binational Wire and Cable Packaging Standard

Recommended Cable Storage Practices

SPEC D050
October, 2011

Storage and Storage Maintenance:

Finished cables have no established shelf-life. Moisture and atmospheric conditions can cause exposed conductors to oxidize and discolor. Uncovered/unsheltered cable will degrade due to exposure to direct sunlight and/or the elements. If the cables are protected, there should be no degradation of the insulation.

In general, any cable for use indoors should be stored indoors. Any cable suitable for installation outdoors is suitable for storage outdoors. Cables stored outdoors should have the ends sealed to prevent moisture ingress into the cable.

Cables with a cold temperature marking, i.e., -10°C , -25°C , or -40°C , may be stored outdoors. Cables without a cold temperature marking must be stored indoors.

Cable reels must remain in the upright position. Cable reels must not be stored on their sides. Reels must not be stacked.

Cable reels should be stored with the protective covering or lagging in place. If a length of cable has been cut from the reel, the cable end should be immediately resealed to prevent the entrance of moisture. If a part length is returned to storage, the reel's protective covering should be restored.

Wooden reels should be stored off the ground to prevent rotting. Reels should be stored on a flat, hard surface so that flanges do not sink into the earth. The weight of the reel and cable must be carried at all times by the reel flanges.

Cable reels and lagging must not be stored for an extended time period sitting in direct contact with water or dampness. Timbers or metal supports must be placed under the reel flanges to provide elevated storage of the reels away from the direct contact with water or damp soil.

Reels should be stored in an area where construction equipment, falling or flying objects or other materials will not contact the cable.

Cable should be stored in an area where chemicals or petroleum products will not be spilled or sprayed on the cable.

Cable should be stored in an area away from open fires or sources of high heat.

If the reels are relocated, they should be handled as suggested in the "Recommended Reel Handling Practices" section, and inspection made on each reel during the relocation.

If the cables are stored in a secure area and not exposed to the effects of the weather, an annual inspection should be satisfactory.

Where the reels are exposed to the weather, a bimonthly inspection should be performed to observe any sign of deterioration.

If the reels are exposed in a non-secure area, policing of the area at frequent intervals may be required depending on circumstances.

Records of delivery date, manufacturer, installation date, any extenuating circumstances, along with all test reports should be kept on file.

Catalog Number Index

NUMBER	PAGE	NUMBER	PAGE	NUMBER	PAGE	NUMBER	PAGE
5310.01001	15	304020	3	369610	6	390220	9
5310.01002	15	315130	2	373750	5	390230	9
5310.01004	15	318420	2	373760	5	390240	9
5310.01006	15	324680	5	373770	5	390250	9
5310.01008	15	325290	3	373780	5	390260	9
5310.01010	15	329950	13	374360	5	390270	9
5310.01012	15	329960	13	376760	5	390280	9
5310.01014	15	330230	2	387070	5	390290	9
5310.01110	15	355320	2	387090	13	390300	9
5310.01111	15	355330	2	387460	5	390310	9
5310.01210	15	355340	2	387530	13	390320	9
5310.01262	15	355350	2	387540	13	390500	9
5310.01310	15	355360	2	387550	13	398540	7
5310.01313	15	355370	2	387570	5	398550	7
5310.01373	15	355380	2	387700	7	398560	7
5310.01410	15	355390	2	387710	7	398570	7
5310.01444	15	355400	2	387730	7	398580	7
5310.01535	15	355410	2	388160	13	398590	7
5310.01646	15	355420	2	388500	13	398600	7
5310.01777	15	355430	2	388610	13	398610	7
5310.01929	15	355440	2	389730	9	398620	7
260080	3	355450	2	389740	8	398630	7
263400	3	355460	2	389750	9	398640	7
267040	3	355470	2	389980	8	398650	7
269970	3	355480	2	389990	8	398660	7
280700	2	355490	3	390000	8	398670	7
280710	2	355500	3	390010	8	398680	7
280720	2	355510	3	390020	8	398690	7
280740	3	355520	3	390030	8	398700	7
282400	16	355530	3	390040	8	398710	7
287940	16	355540	3	390050	8	398720	7
296420	2	355550	3	390060	8	398730	7
296490	2	355560	3	390070	8	398740	7
296500	3	355570	3	390080	8	398750	7
296510	3	355580	3	390090	8	398760	7
296520	3	355590	3	390100	8	398770	7
297970	3	355600	3	390110	8	398780	7
300180	3	355610	3	390120	8	412170	5
300620	3	355620	3	390130	8	412180	5
300890	3	355630	3	390140	9	412190	5
300900	3	364980	3	390150	9	412200	5
301260	3	369550	6	390160	9	412210	5
301270	3	369560	6	390170	9	650870.00.77	17
301280	3	369570	6	390180	9	696420.00.77	17
302440	3	369580	6	390190	9	LO24P0045664	11
303480	3	369590	6	390200	9		
303910	2	369600	6	390210	9		

POWERING YOUR MASS TRANSIT

CABLING CONNECTIONS



As developments in the transit industry continue to increase the demand for safety, instantaneous response to commands and the significant reduction of braking distances at higher speeds, General Cable continues to respond with the latest engineered designs.

General Cable's years of dedicated material development, engineering expertise and advanced manufacturing processes were called upon by the transit industry to engineer Electronically Controlled Pneumatic (ECP) brake cables that would meet the stringent standards of AAR S-4210 and be designed specifically for installation both under and between cars.

General Cable's Brand Rex Brand ECP brake cables are the chosen solution for demanding environments, thanks to an engineered construction.

- Unique insulation system utilizing 125°C thermosetting polyolefin cross-linked compound for high-temperature areas
- The reduction of EMI/RFI interference with a tinned copper braided shield
- Arctic-grade, heavy-duty reinforced Neoprene jacket that provides excellent low-temperature performance and tough mechanical properties
- Optional galvanized or aluminum armor over the cable jacket allows for conduit-free installations, providing significant installed cost savings



Brand Rex
BRAND

 **General Cable**

www.generalcable.com

General Cable ... Powering Your Mass Transit Cabling Connection.

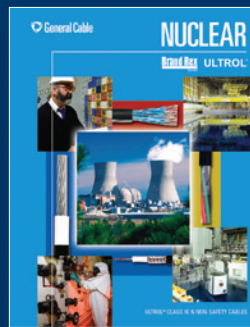
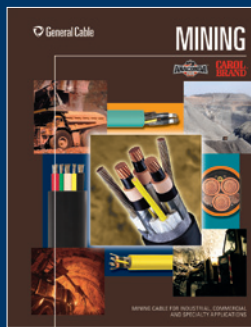
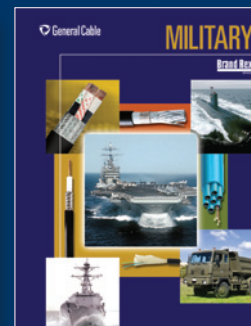
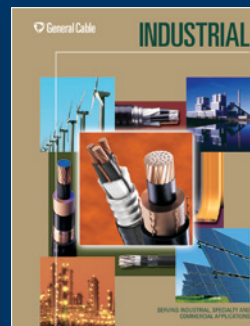
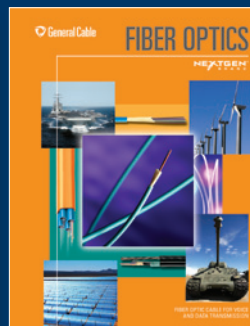
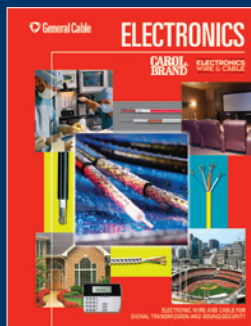
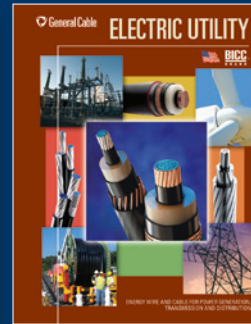
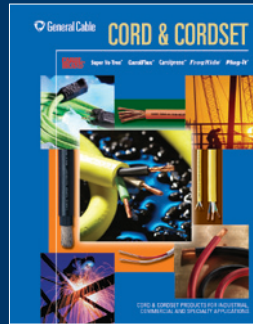

Other General Cable Products Offered

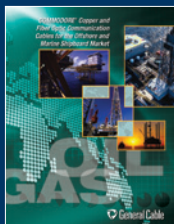

**COMMODORE®
CATALOG**

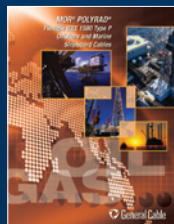

**MOR® POLYRAD®
CATALOG**

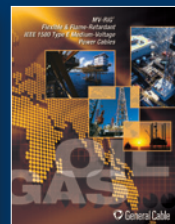

**MV-RIG®
CATALOG**

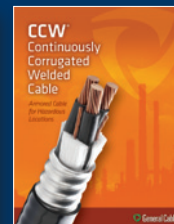

**CCW®
CATALOG**



**X-TRACT® ESP
CATALOG**



**GEPCO®
CATALOG**



**SHEERWIRE™
CATALOG**

General Cable

4 Tesseneer Drive
Highland Heights,
Kentucky 41076-9753
U.S.A.
info@generalcable.com

Telephone (888) 593-3355
Fax (800) 335-1270
International Telephone +1 859 572 8000
International Fax +1 859 572 8058
www.generalcable.com

General Cable Canada

590 Barmac Drive
North York, Ontario M9L 2X8
Telephone (800) 561-0649
Fax (800) 565-2529
info@generalcable.com