

LIGHT IS OUTSIDE[®]

11

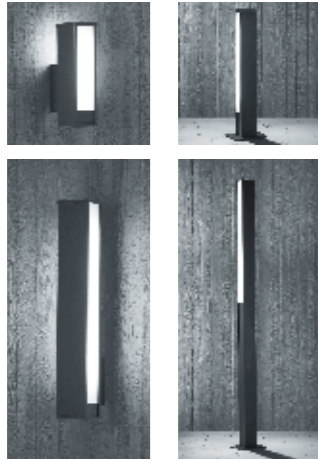

TENDO 44
4 – 7



NORDIC 2
8 – 11



ALASKA
12 – 13



FJORD 1
14 – 15



FJORD 2
16 – 17



FJORD 3
18 – 19



MONTANA
20 – 21



ICELAND44
22 – 25



BASALT 44
26 – 27



HUSKY
28 – 29



NARVIK
30 – 31



SKAGEN 1
32 – 33



TAIGA 1
34



SCALA 44
35

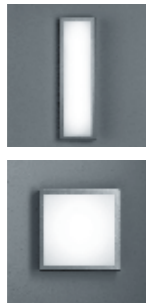

SLIM 44
36 – 37

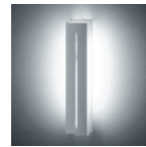

YUKON 44
38 – 39

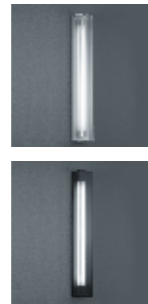

SINCE 44
40 – 41

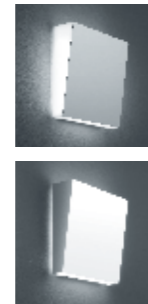

ATLANTIC
42 – 43



ARGOS44
44



HL-15
45 – 47



HL-20
48 – 49



HL-25
50 – 51



HL-35
52 – 53



HL-40
54 – 55

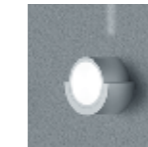

HL-60
56 – 57



HL-65
58 – 59



HL-70
60 – 61



HL-75
62 – 63



**Leuchtenübersicht
Lamp summary**

ALASKA	12 – 13	HL-40	54 – 55	NORDIC 2	8 – 11
ATLANTIC	42 – 43	HL-60	56 – 57	SCALA 44	35
ARGOS 44	44	HL-65	58 – 59	SINCE 44	40 – 41
BASALT 44	26 – 27	HL-70	60 – 61	SKAGEN 1	32 – 33
FJORD 1 – 3	14 – 19	HL-75	62 – 63	SLIM 44	36 – 37
HL-15	45 – 47	HUSKY	28 – 29	TAIGA 1	34
HL-20	48 – 49	ICELAND 44	22 – 25	TENDO 44	4 – 7
HL-25	50 – 51	MONTANA	20 – 21	YUKON 44	38 – 39
HL-35	52 – 53	NARVIK	30 – 31		

INDEX

TENDO 44

TENDO 44

aluminium
Farbe graphit, ähnlich DB 703
Acryl satiniert
mit EVG

aluminium
colour graphite, similar to DB 703
acrylic satinised
with electronic ballast

E für Energiesparlampen
for energy saving lamps

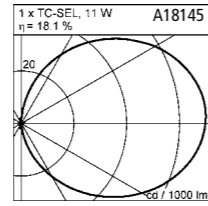
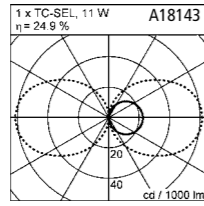

1 x T16, 14 W, G5
A18146.93

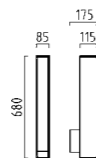

1 x TC-SEL, 5/7/9/11 W, 2G7
A18145.93

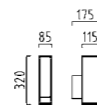

1 x TC-SEL, 5/7/9/11 W, 2G7
A18143.93

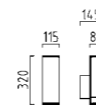

1 x T16, 14 W, G5
A18144.93

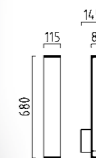

TENDO 44

TENDO 44

aluminium
Farbe graphit, ähnlich DB 703
Acryl satiniert
mit EVG

aluminium
colour graphite, similar to DB 703
acrylic satinised
with electronic ballast

E für Energiesparlampen
for energy saving lamps

T16 IP55

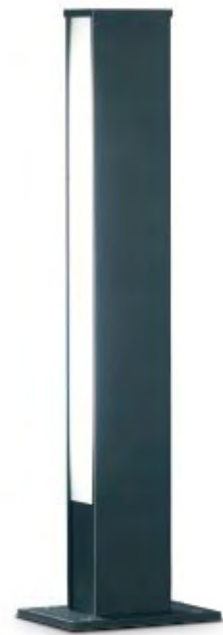

1 x T16, 14 W, G5
Lichtaustritt einseitig
light emission on one-side
A19230.93
Lichtaustritt beidseitig
light emission on two-side
A19115.93

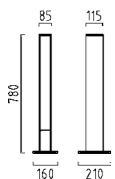

1 x T16, 21 W, G5
Lichtaustritt einseitig
light emission on one-side
A19231.93
Lichtaustritt beidseitig
light emission on two-side
A19116.93

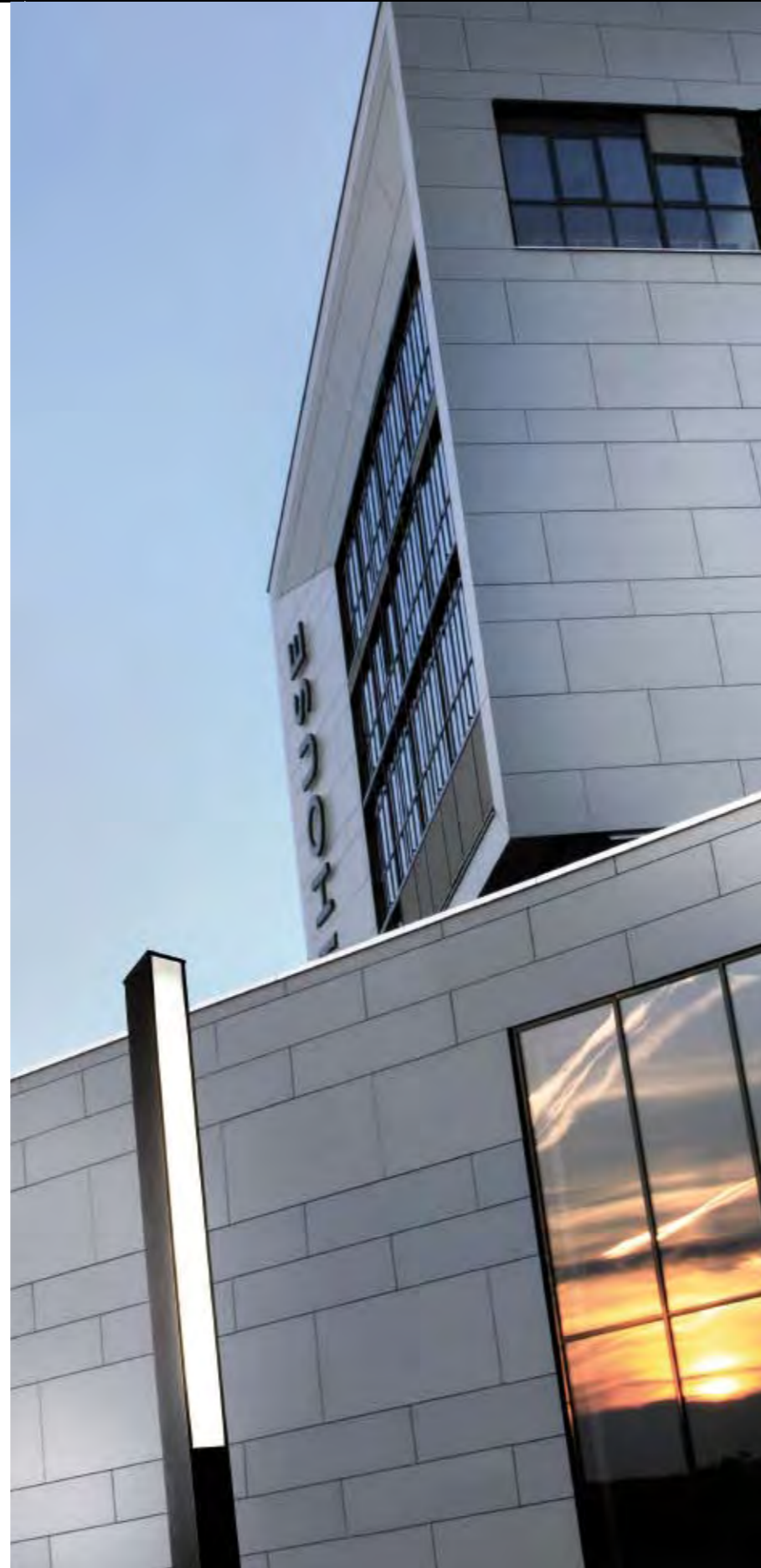
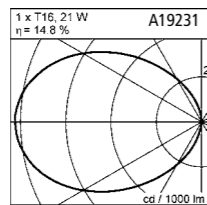
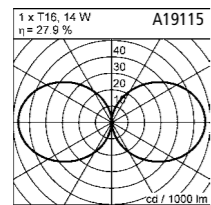
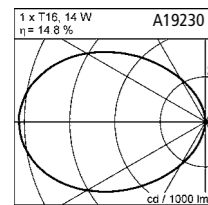
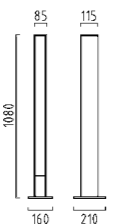

1 x T16, 28 W, G5
Lichtaustritt einseitig
light emission on one-side
A19232.93
Lichtaustritt beidseitig
light emission on two-side
A19117.93

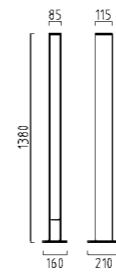

1 x T16, 21 W, G5
Lichtaustritt einseitig
light emission on one-side
A19233.93
Lichtaustritt beidseitig
light emission on two-side
A19118.93

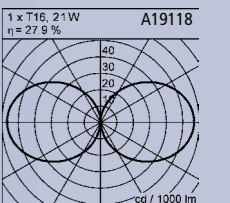
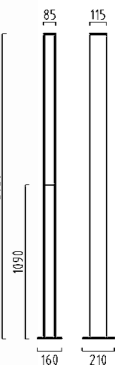

Zubehör für Bodenbefestigung
(Seite 64)
accessories for floor assembly
(page 64)

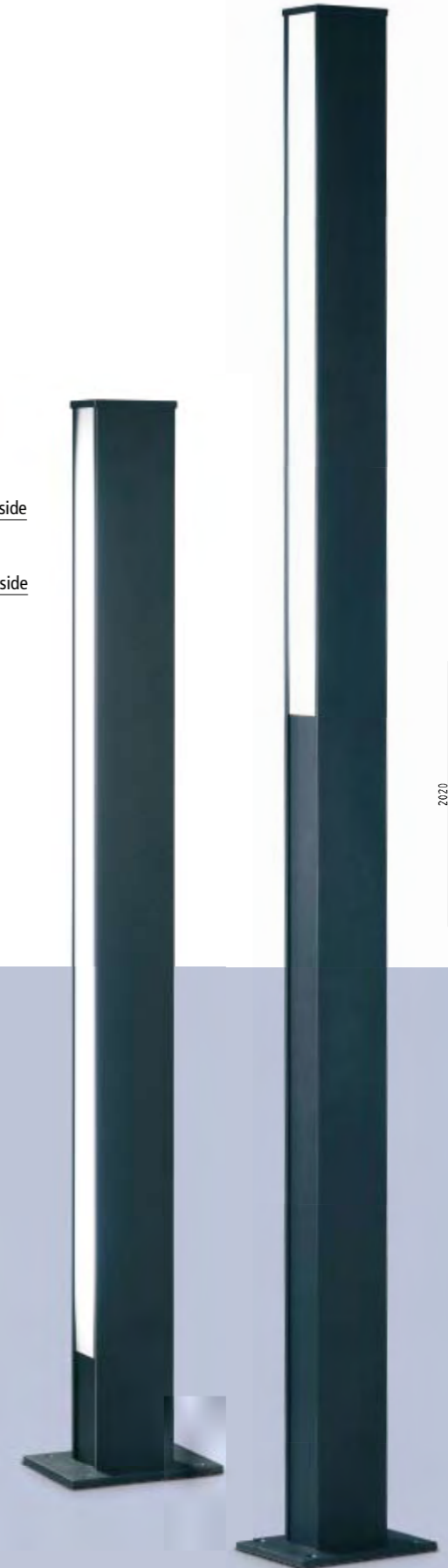



NORDIC 2

aluminium
Farbe graphit, ähnlich DB 703
Acryl satiniert
mit EVG

aluminium
colour graphite, similar to DB 703
acrylic satinised
with electronic ballast

E für Energiesparlampen
for energy saving lamps

T16 IP44

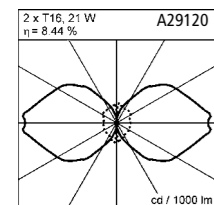

2 x T16, 14 W, G5
A29119.93

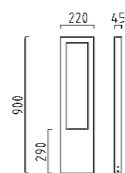

Zubehör für Bodenbefestigung
(Seite 64)
accessories for floor assembly
(page 64)



2 x T16, 21 W, G5
A29120.93

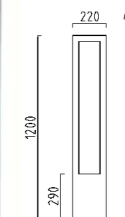

NORDIC 2

NORDIC 2

NORDIC 2

aluminium
Farbe graphit, ähnlich DB 703
Acryl satiniert
mit EVG

aluminium
colour graphite, similar to DB 703
acrylic satinised
with electronic ballast

E für Energiesparlampen
for energy saving lamps

T16 IP44

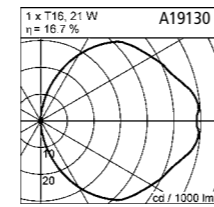

1 x T16, 14 W, G5
A19129.93

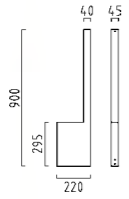

1 x T16, 21 W, G5
A19130.93

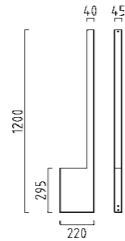

Zubehör für Bodenbefestigung (Seite 64)
accessories for floor assembly (page 64)



1 x T16, 14 W, G5
A18147.93

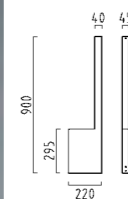

1 x T16, 21 W, G5
A18148.93

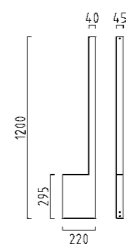

Nur zur senkrechten Montage
only for vertical assembly

ALASKA

ALASKA
 aluminium
 Acryl satiniert
 mit Betriebsgerät

aluminium
 acrylic satinised
 with electronic control gear

4 x 1,5 W, LED
 warm weiß / warm white ca. 3000 K

E für Energiesparlampen
 for energy saving lamps

LED IP44 

Farbe silbergrau
 colour silver grey
A19225.46

Farbe graphit, ähnlich DB 703
 colour graphite, similar to DB 703
A19225.93

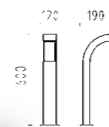

Zubehör für Bodenbefestigung
 (Seite 64)
 accessories for floor assembly
 (page 64)



Farbe silbergrau
 colour silver grey
A18225.46

Farbe graphit, ähnlich DB 703
 colour graphite, similar to DB 703
A18225.93

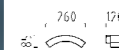

FJORD 1

FJORD 1

Aluminiumguss, aluminium
Farbe graphit, ähnlich DB 703
Acryl satiniert
mit Betriebsgerät

aluminium casting, aluminium
colour graphite, similar to DB 703
acrylic satinised
with electronic control gear

8 x 1 W, LED weiß / white ca. 4000 K



A88141.93



IP44



A88140.93

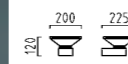

IP44

A89108.93

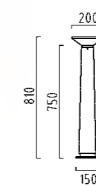

IP55



Zubehör für Bodenbefestigung
(Seite 64)
accessories for floor assembly
(page 64)



A89107.93



IP55

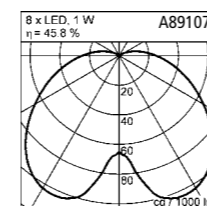

FJORD 2

FJORD 2

Aluminiumguss, aluminium
Farbe graphit, ähnlich DB 703
Acryl satiniert
mit Betriebsgerät

aluminium casting, aluminium
colour graphite, similar to DB 703
acrylic satinised
with electronic control gear

8 x 1 W, LED weiß / white ca. 4000 K

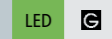

A88142.93

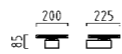

IP44

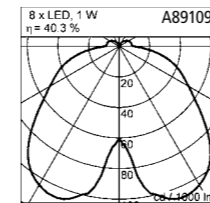

IP55



A89109.93

Zubehör für Bodenbefestigung
(Seite 64)
accessories for floor assembly
(page 64)

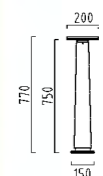
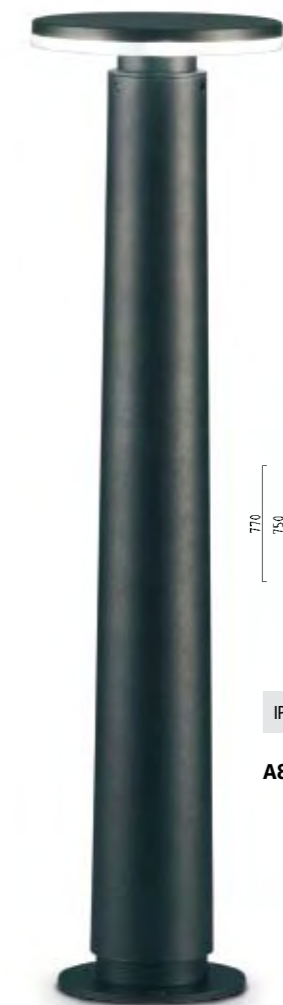

IP55

A89110.93

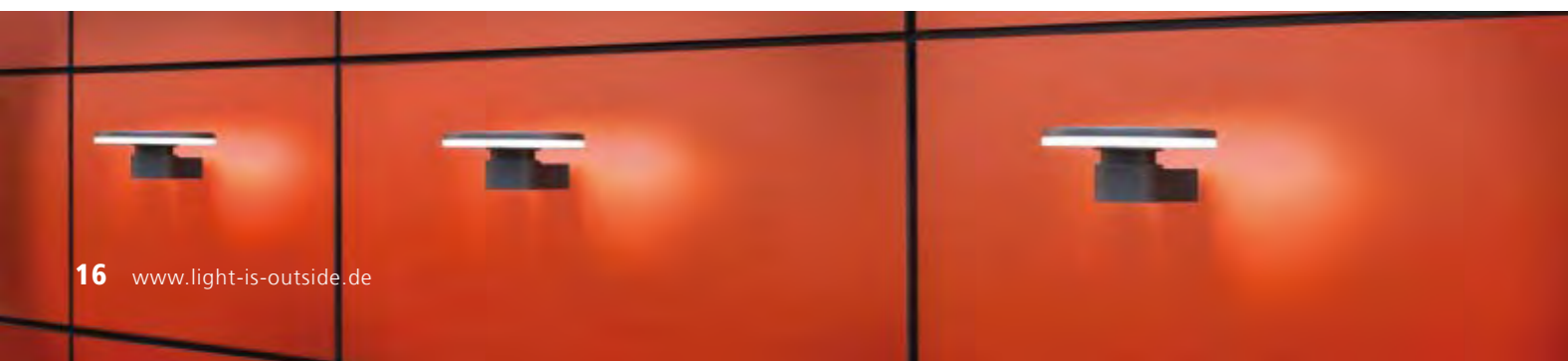

FJORD 3



FJORD 3

Aluminiumguss, aluminium
Farbe graphit, ähnlich DB 703
Acryl satiniert
mit EVG

aluminium casting, aluminium
colour graphite, similar to DB 703
acrylic satinised
with electronic ballast

E für Energiesparlampen
for energy saving lamps

T16 IP44

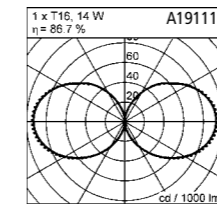

1 x T16, 14 W, G5
A19111.93

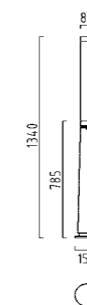

1 x T16, 21 W, G5
A19112.93

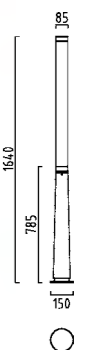

Zubehör für Bodenbefestigung
(Seite 64)
accessories for floor assembly
(page 64)



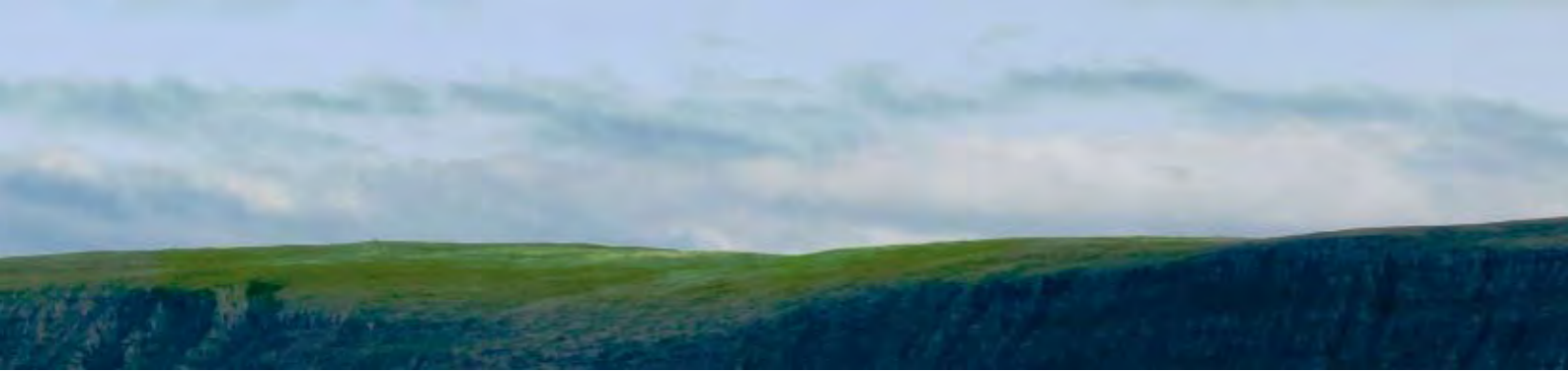

MONTANA



TC-F IP45 E

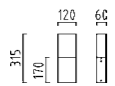

Farbe silbergrau / colour silver grey
A19032.46
Farbe schwarz matt / colour black mat
A19032.98

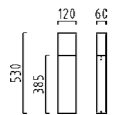
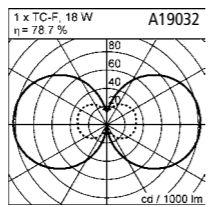

Farbe silbergrau / colour silver grey
A19035.46
Farbe schwarz matt / colour black mat
A19035.98

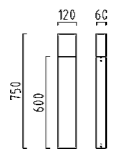

Farbe silbergrau / colour silver grey
A19038.46
Farbe schwarz matt / colour black mat
A19038.98

Zubehör für Bodenbefestigung
(Seite 64)
accessories for floor assembly
(page 64)



MONTANA
aluminium
Acryl opal
mit EVG

aluminium
acrylic opal
with electronic ballast

1 x TC-F, 18 W, 2G10

E für Energiesparlampen
for energy saving lamps

TC-F IP44 E

Farbe silbergrau / colour silver grey
A18032.46
Farbe schwarz matt / colour black mat
A18032.98

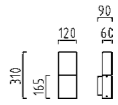

ICELAND 44

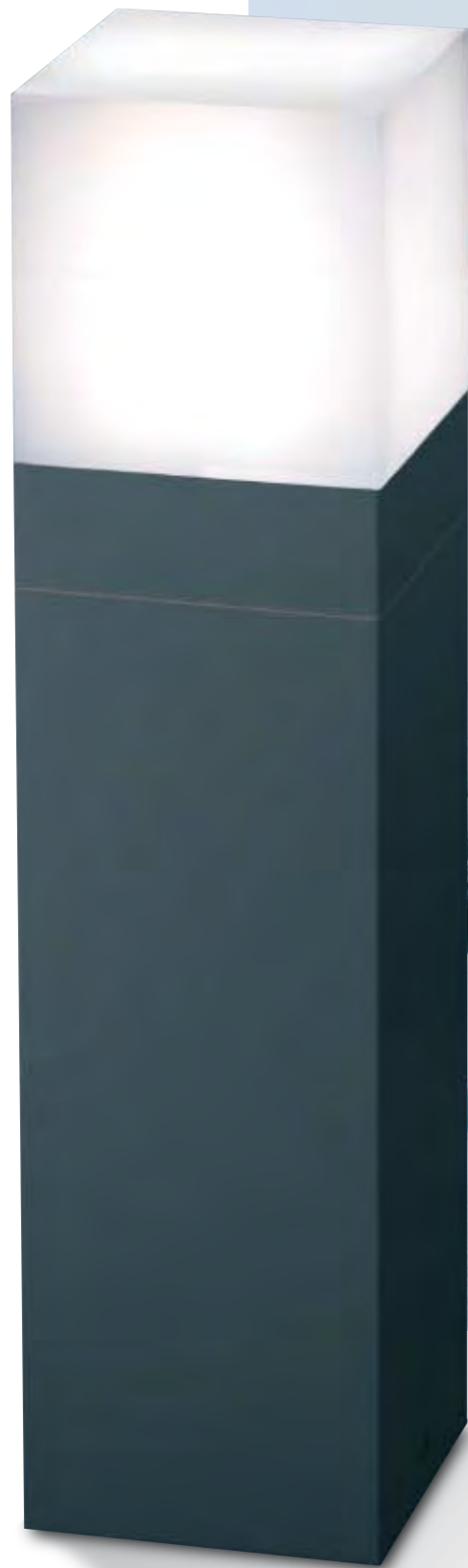

Zubehör für Bodenbefestigung
(Seite 64)
accessories for floor assembly
(page 64)

ICELAND 44

aluminium
Acryl opal
mit EVG

aluminium
acrylic opal
with electronic ballast

1 x TC-TEL, 13 W, GX24q-1

E für Energiesparlampen
for energy saving lamps

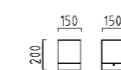

Farbe silbergrau / colour silver grey
A19234.46

Farbe schwarz matt / colour black mat
A19234.98

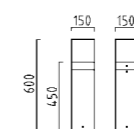

Farbe silbergrau / colour silver grey
A19235.46

Farbe schwarz matt / colour black mat
A19235.98

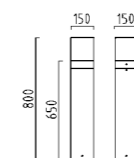

Farbe silbergrau / colour silver grey
A19236.46

Farbe schwarz matt / colour black mat
A19236.98

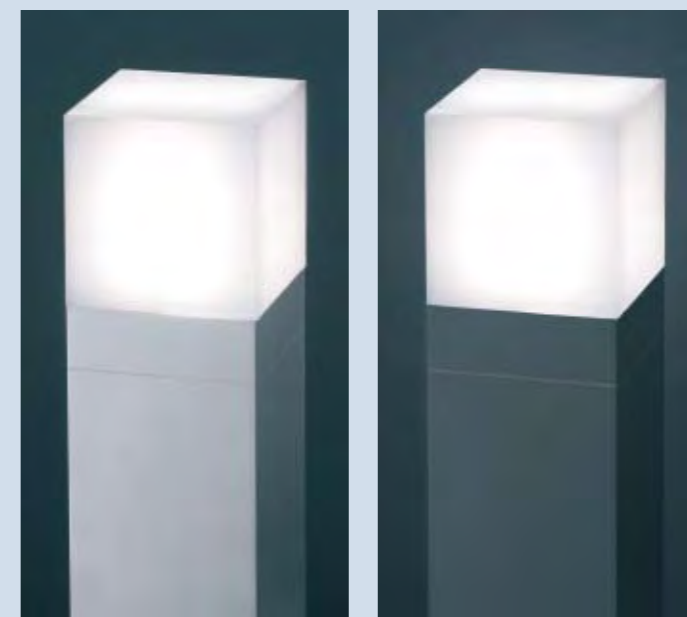
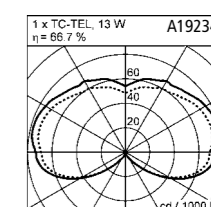

ICELAND 44



ICELAND 44

aluminium
Acryl opal
mit EVG

aluminium
acrylic opal
with electronic ballast

1 x TC-TEL, 13 W, GX24q-1

E für Energiesparlampen
for energy saving lamps



ICELAND 44

aluminium
Acryl opal
mit EVG

aluminium
acrylic opal
with electronic ballast

1 x TC-TEL, 13 W, GX24q-1

E für Energiesparlampen
for energy saving lamps



Farbe silbergrau / colour silver grey

A18234.46

Farbe schwarz matt / colour black mat

A18234.98

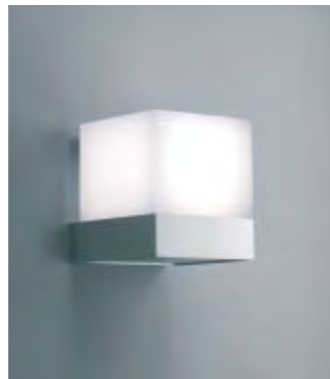
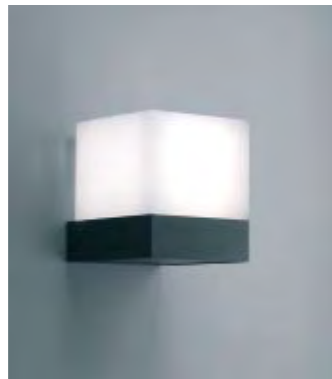
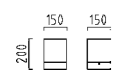

Farbe silbergrau / colour silver grey

A18237.46

Farbe schwarz matt / colour black mat

A18237.98

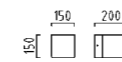



BASALT 44



Zubehör für Bodenbefestigung
(Seite 64)
accessories for floor assembly
(page 64)

*Wir empfehlen:
Philips MASTER PL-L Polar
*we suggest:
Philips MASTER PL-L Polar

BASALT 44

edelstahl
Acryl weiß
mit EVG

stainless steel
acrylic white
with electronic ballast

E für Energiesparlampen
for energy saving lamps

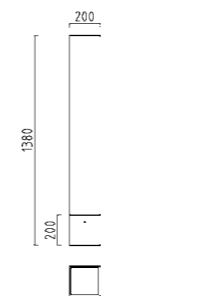
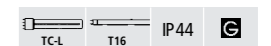

2 x T16, 28/54 W, G5
A29101.86

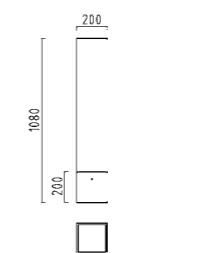

2 x T16, 21/39 W, G5
A29100.86

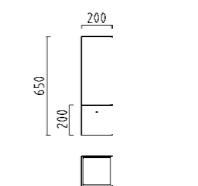

2 x TC-L, 36 W, 2G11*
A29102.86

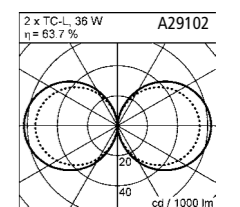

HUSKY



HUSKY

aluminium
Farbe graphit, ähnlich DB 703
Acryl opal
mit EVG

aluminium
colour graphite, similar to DB 703
acrylic opal
with electronic ballast

E für Energiesparlampen
for energy saving lamps



1 x TC-TEL, 13 W, GX24q-1
A19127.93

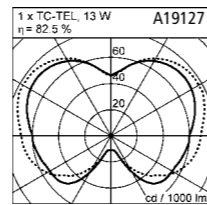
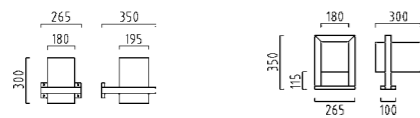

1 x TC-TEL, 13 W, GX24q-1
A19128.93

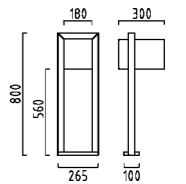

Zubehör für Bodenbefestigung
(Seite 64)
accessories for floor assembly
(page 64)





1 x T16-R, 22 W, 2GX13
A18151.93

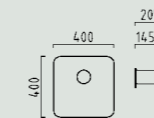

1 x T16-R, 22W, 2GX13
A19126.93

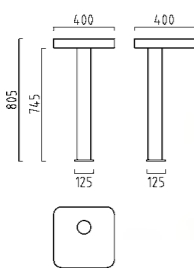

1 x T16-R, 22 W, 2GX13
A19125.93

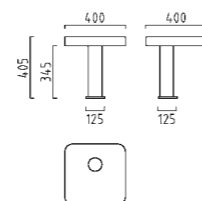

Zubehör für Bodenbefestigung
(Seite 64)
accessories for floor assembly
(page 64)



NARVIK

NARVIK

Aluminiumguss, aluminium
Farbe graphit, ähnlich DB 703
Acryl opal
mit EVG

aluminium casting, aluminium
colour graphite, similar to DB 703
acrylic opal
with electronic ballast

E für Energiesparlampen
for energy saving lamps

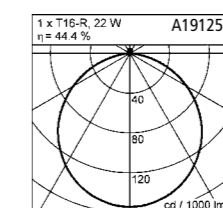

SKAGEN 1

Aluminiumguss, aluminium
Farbe graphit, ähnlich DB 703
Acryl opal
mit EVG

aluminium casting, aluminium
colour graphite, similar to DB 703
acrylic opal
with electronic ballast

E für Energiesparlampen
for energy saving lamps

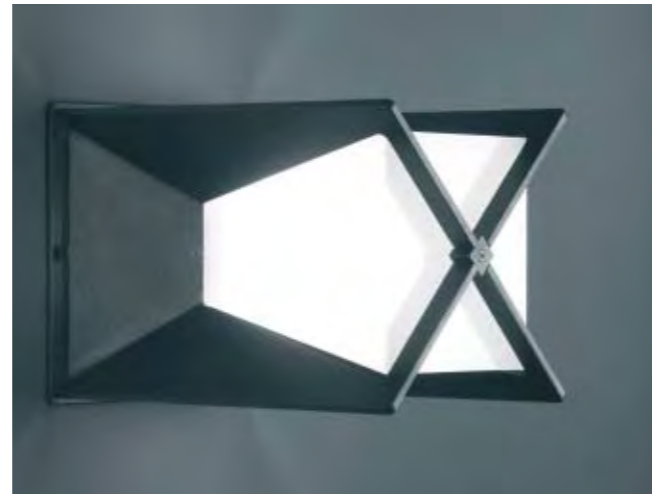

1 x TC-L, 36 W, 2G11
A19122.93

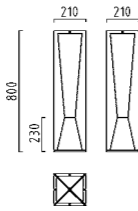

1 x TC-DEL, 18 W, G24q-2
A19121.93

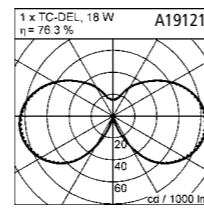
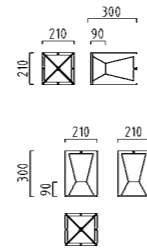

Zubehör für Bodenbefestigung
(Seite 64)
accessories for floor assembly
(page 64)



SKAGEN 1



TAIGA 1



TAIGA 1
edelstahl
Acryl weiß
mit EVG
stainless steel
acrylic white
with electronic ballast
E für Energiesparlampen
for energy saving lamps



SCALA 44



SCALA 44
edelstahl
Acrylscheibe weiß
mit EVG
stainless steel
acrylic plate white
with electronic ballast
E für Energiesparlampen
for energy saving lamps

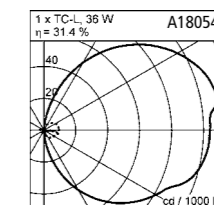
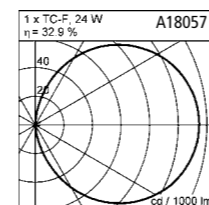
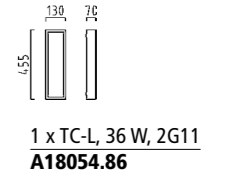
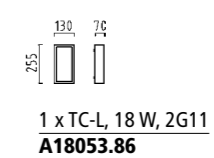
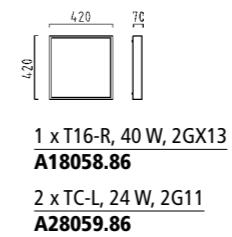
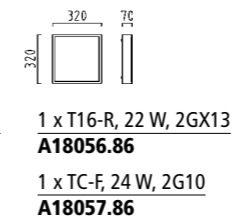
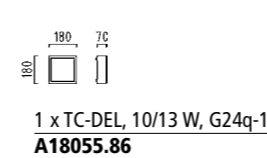
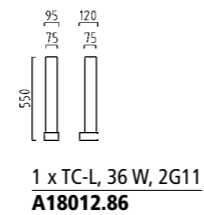
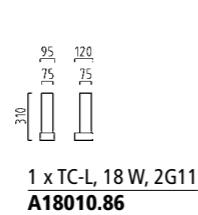



reddot



DESIGNPREIS
2009
NOMINIERT

DESIGN PLUS



DESIGNPREIS
2009
NOMINIERT

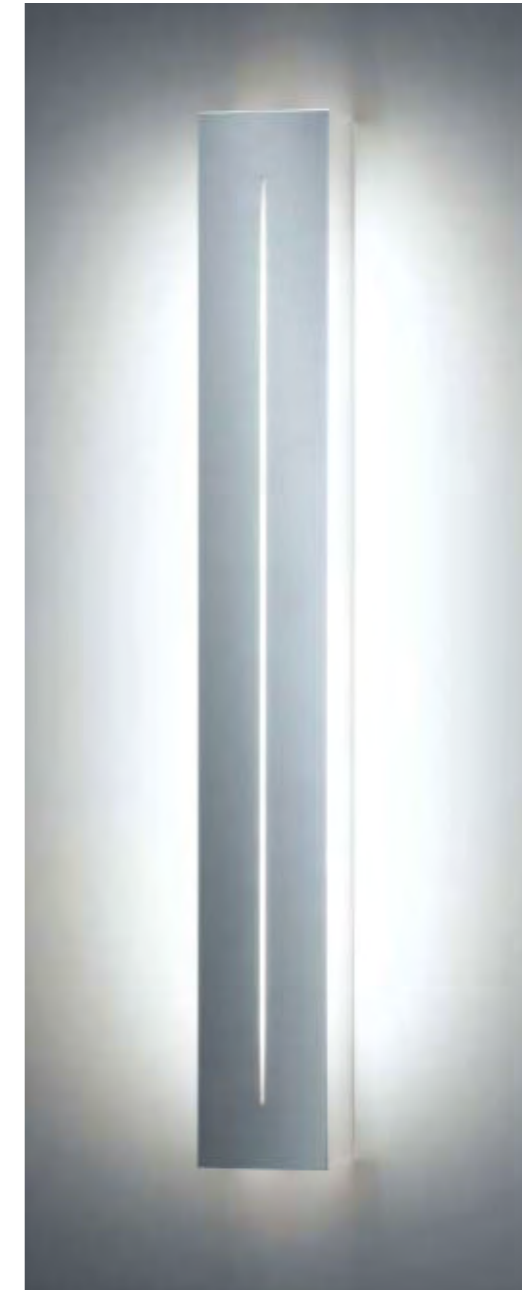
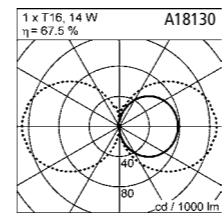

SLIM 44
aluminium
Farbe silbergrau
Acryl satiniert
mit EVG

aluminium
colour silver grey
acrylic satinised
with electronic ballast

E für Energiesparlampen
for energy saving lamps

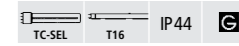

1 x T16, 14 W, G5
A18130.25

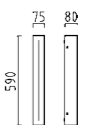

1 x TC-SEL, 11 W, 2G7
A18129.25



SLIM 44



YUKON 44
 edelstahl
 mit EVG
 stainless steel
 with electronic ballast

E für Energiesparlampen
 for energy saving lamps

T16 IP44

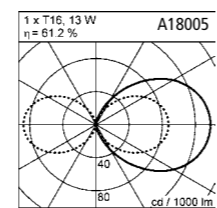

Nur zur senkrechten Montage
 only for vertical assembly



1 x T16, 8 W, G5
 Acryl klar / acrylic clear
A18003.86
 Acryl grau / acrylic grey
A18009.86



1 x T16, 13 W, G5
 Acryl klar / acrylic clear
A18005.86
 Acryl grau / acrylic grey
A18011.86



1 x T16, 21 W, G5
 Acryl klar / acrylic clear
A18007.86
 Acryl grau / acrylic grey
A18013.86

YUKON 44

SINCE 44

aluminium
Farbe silbergrau
Acryl satiniert
mit EVG

aluminium
colour silver grey
acrylic satinised
with electronic ballast

1 x T16-R, 22 W, 2GX13

E für Energiesparlampen
for energy saving lamps



A18131.25

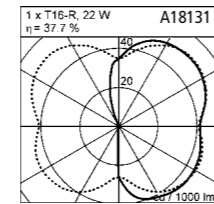
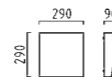

A18132.25

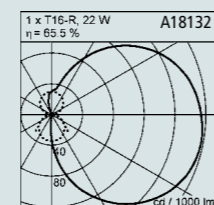
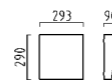

reddot



DESIGNPREIS
2008
NOMINIERT

SINCE 44

ATLANTIC



ATLANTIC

aluminium eloxiert
Acryl weiß
mit EVG

aluminium anodised
acrylic white
with electronic ballast

1 x T16-R, 22 W, 2GX13

E für Energiesparlampen
for energy saving lamps

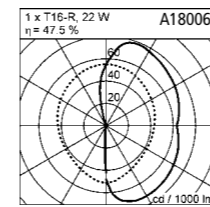

A18006.25

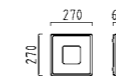

A18004.25

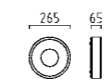

ARGOS 44



ARGOS 44
 Aluminiumguss
 Farbe graphit, ähnlich DB 703
 Acryl satiniert
 mit EVG

aluminium casting
 colour graphite, similar to DB 703
 acrylic satinised
 with electronic ballast

E für Energiesparlampen
 for energy saving lamps

TC-F IP44

1 x TC-F, 24 W, 2G10
A18133.93



Nur zur senkrechten Montage
 only for vertical assembly

HL-15



HL-15
 massiv aluminium, eloxiert
 Abdeckglas klar
 inkl. Leuchtmittel
 solid aluminium, anodised
 protective glass clear
 incl. lamp

QPAR 51 IP54

1 x QPAR 51, 35 W, GU10
A18162.25

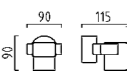

HL-15

HL-15

massiv aluminium, eloxiert
Acryl satiniert
mit Betriebsgerät

solid aluminium, anodised
acrylic satinised
with electronic control gear

LED IP54



2 x 1 W, LED warm weiß / warm white ca. 3300 K
A28159.25

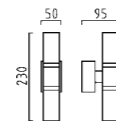

1 x 1 W, LED warm weiß / warm white ca. 3300 K
A18159.25

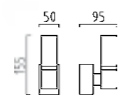

HL-15

massiv aluminium, eloxiert
Abdeckglas klar
mit Betriebsgerät

solid aluminium, anodised
protective glass clear
with electronic control gear

LED IP54



2 x 1 W, LED warm weiß / warm white ca. 3300 K
A28160.25

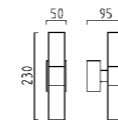

HL-20

HL-20

massiv aluminium, eloxiert
Acryl satiniert

solid aluminium, anodised
acrylic satinised

E für Energiesparlampen
for energy saving lamps

 IP54



1 x GX53, 9 W
A18156.25

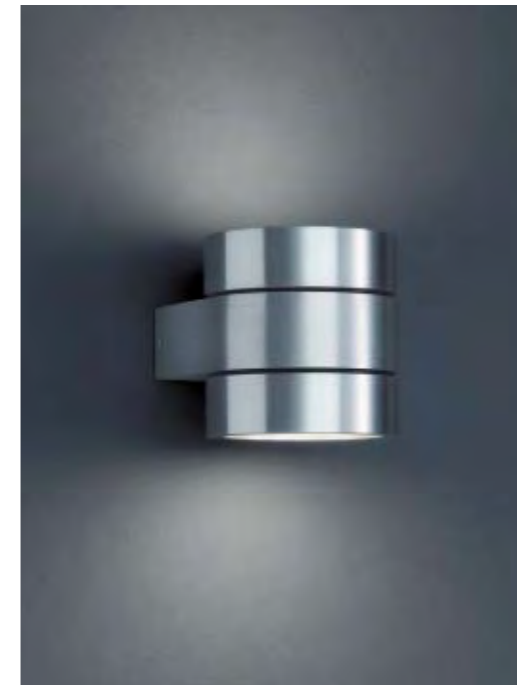
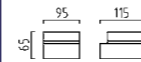

HL-20
massiv aluminium, eloxiert
Abdeckglas opal
solid aluminium, anodised
protective glass opal

E für Energiesparlampen
for energy saving lamps

 IP54

2 x GX53, 9 W
A28158.25

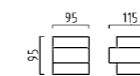

2 x GX53, 9 W
A28157.25



HL-20

HL-25

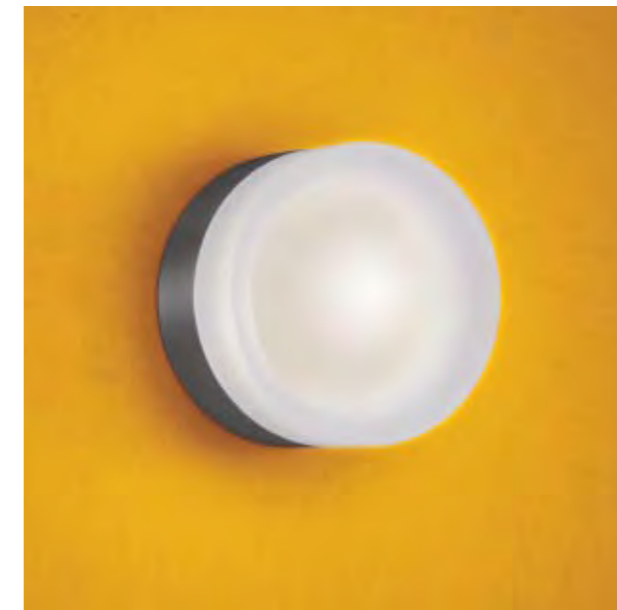

HL-25
massiv aluminium, eloxiert
Acryl satiniert
solid aluminium, anodised
acrylic satinised

E für Energiesparlampen
for energy saving lamps

 IP54

1 x GX53, 9 W
A18166.25

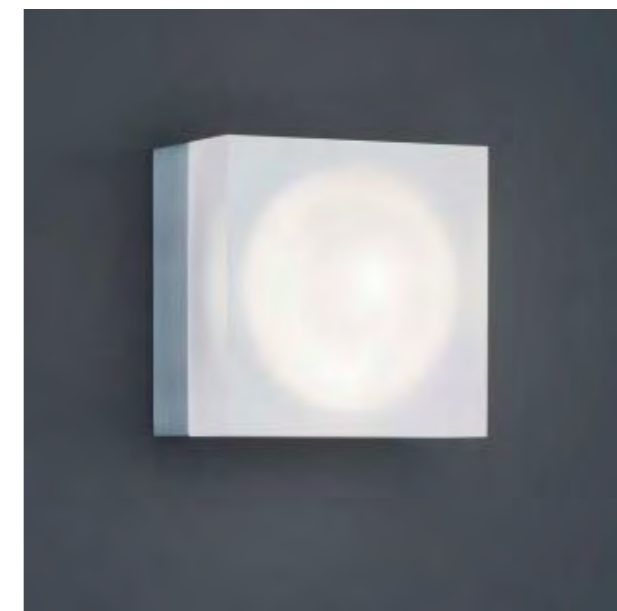
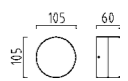

1 x GX53, 9 W
A18165.25

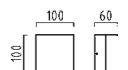



HL-35

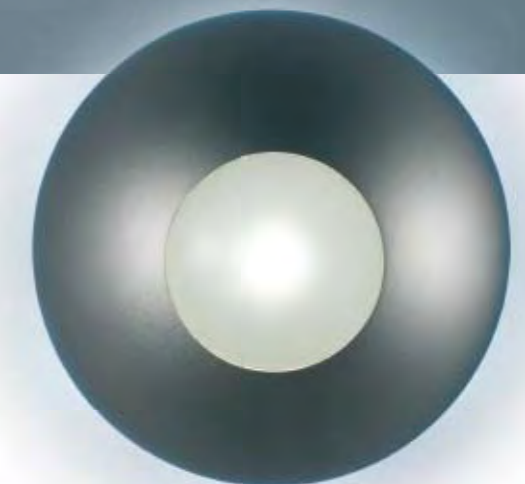
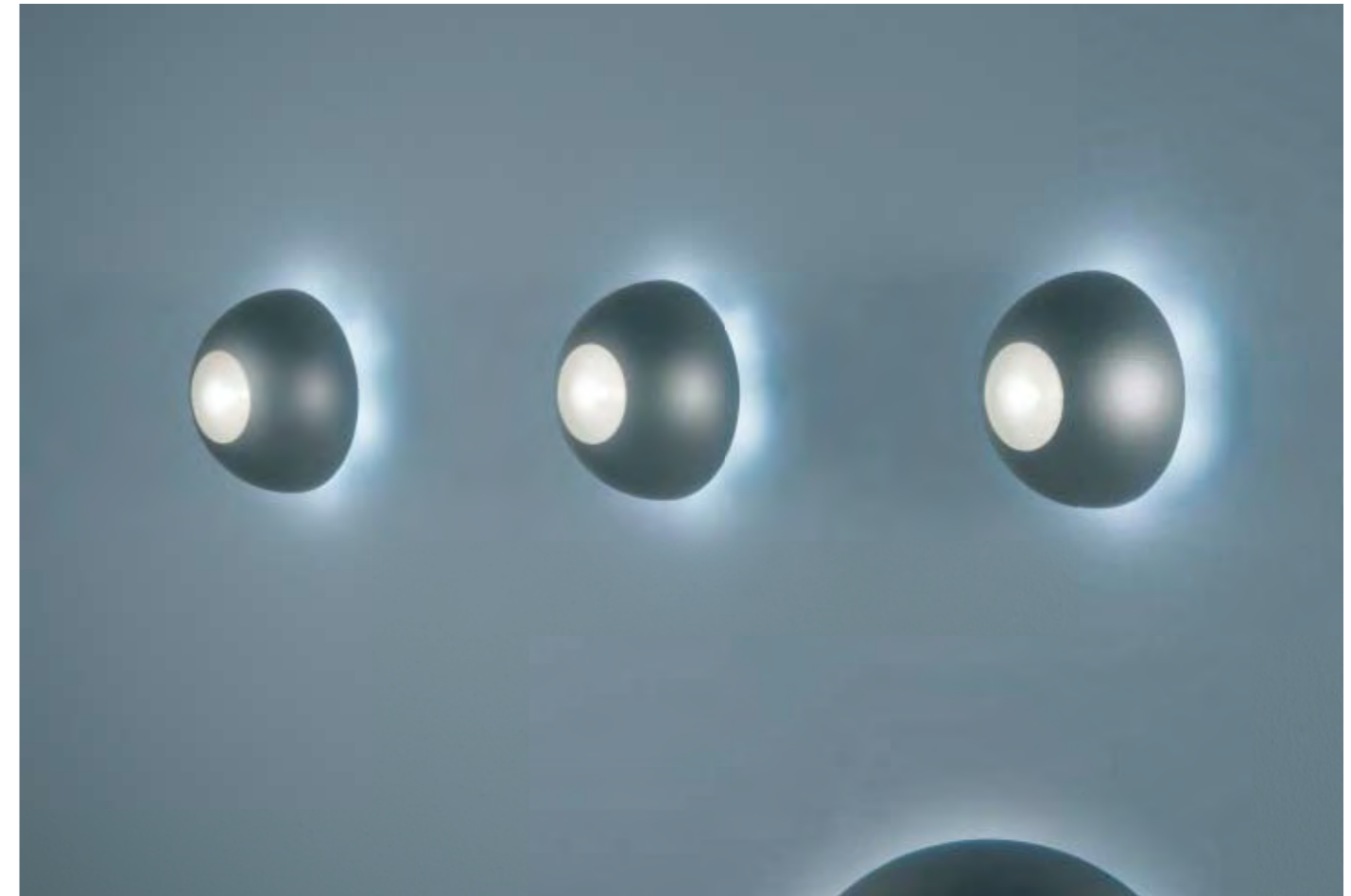

HL-35

aluminium
Farbe silbergrau
Acryl satiniert
mit Betriebsgerät

aluminium
colour silver grey
acrylic satinised
with electronic control gear

LED IP65

6 x 1 W, LED kalt weiß - indirekt / cool white - indirect ca. 6000 K
1 x 1 W, LED warm weiß - direkt / warm white - direct ca. 3300 K
A28203.06

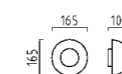

HL-40

HL-40

massiv aluminium
Farbe silbergrau
Glas satiniert
solid aluminium
colour silver grey
glass satinised

QT14 IP65



1 x QT14, max. 60 W, G9
A18204.46

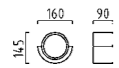

Durchgangsverdrahtung möglich
feed-through wiring possible





HL-60
 massiv aluminium, eloxiert
 Streulinse
 mit Betriebsgerät
 solid aluminium, anodised
 diffuser lens
 with electronic control gear

LED IP54

Außenmontage nur wie abgebildet möglich
 exterior installation only as shown in the picture

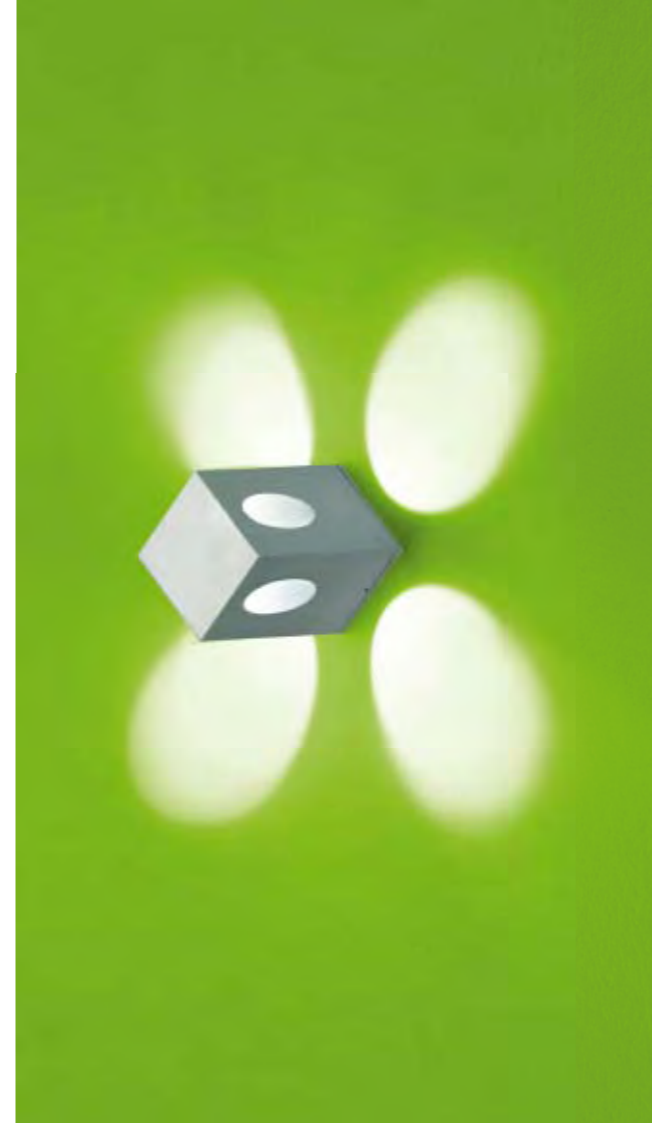

4 x 1 W, LED warm weiß / warm white ca. 3300 K
A48212.25

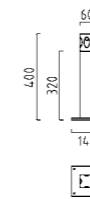
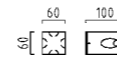

4 x 1 W, LED warm weiß / warm white ca. 3300 K
A49216.25

HL-60



HL-65

HL-65
massiv aluminium, eloxiert
Streulinse
mit Betriebsgerät
solid aluminium, anodised
diffuser lens
with electronic control gear

LED IP65

3 x 1 W, LED warm weiß / warm white ca. 3300 K
A39217.25

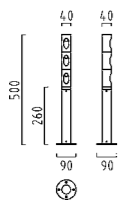



HL-70



HL-70
 massiv aluminium, eloxiert
 Streulinse
 mit Betriebsgerät
 solid aluminium, anodised
 diffuser lens
 with electronic control gear

LED IP54

2 x 1 W, LED warm weiß / warm white ca. 3300 K
A28215.25

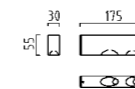

Außenmontage nur wie abgebildet möglich
 exterior installation only as shown in the picture

HL-75

massiv aluminium, eloxiert
Acryl satiniert
mit Betriebsgerät

solid aluminium, anodised
acrylic satinised
with electronic control gear

LED IP54

4 x 1 W, LED warm weiß / warm white ca. 3300 K
A49220.25

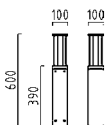

Zubehör für Bodenbefestigung
(Seite 64)
accessories for floor assembly
(page 64)



HL-75



ZUBEHÖR / ACCESSORIES

Befestigung auf einem Fundament
Alle Poller/Standleuchten können ohne Zubehör auf einem Fundament befestigt werden.

Mounting on a firm ground
All floor lights can be mounted on a firm ground without accessories.

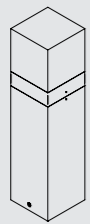

Einbau im Boden
Für den Bodeneinbau von Poller/Standleuchten bitte das Erdstück mit (oder ohne) Montageplatte separat bestellen (siehe Tabelle).

Mounting on a soft ground
For assembling in soft ground, please order the separate anchorage unit with (or without) mounting plate (see table).

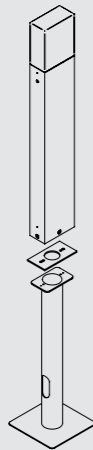

Erdstück / anchorage unit
Stahl verzinkt / steel zinc-plated

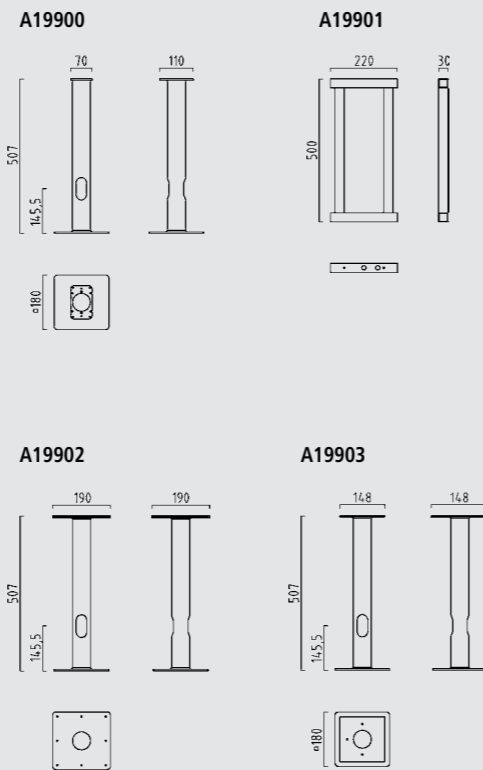

Serie	Erdstück Anchorage unit	Montageplatte Mounting plate
ALASKA	A19900	*
BASALT 44	A19902	*
FJORD 1-3	A19900	9006
HL-75	A19900	9010
HUSKY	A19900	9008
ICELAND	A19903	*
MONTANA	A19900	9000
NARVIK	A19900	9005
NORDIC 2	A19901	*
SKAGEN 1	A19902	*
TENDO 44	A19900	9007

*Montageplatte nicht erforderlich
mounting plate not necessary

Art.-Nr. / Art. no.	Seite / Page	Art.-Nr. / Art. no.	Seite / Page	Art.-Nr. / Art. no.	Seite / Page	Art.-Nr. / Art. no.	Seite / Page
9000		A18147.93	11	A19130.93	10	A48000	
9000	64	A18148.93	11	A19225.46	12	A48212.25	57
9005	64	A18151.93	31	A19225.93	12		
9006	64	A18156.25	48	A19230.93	6	A49000	
9007	64	A18159.25	46	A19231.93	6	A49216.25	57
9008	64	A18162.25	45	A19232.93	7	A49220.25	62
9010	64	A18165.25	51	A19233.93	7		
		A18166.25	51	A19234.46	23	A88000	
A18000		A18204.46	54	A19234.98	23	A88140.93	15
A18003.86	38	A18225.46	13	A19235.46	23	A88141.93	14
A18004.25	43	A18225.93	13	A19235.98	23	A88142.93	16
A18005.86	38	A18234.46	24	A19236.46	23		
A18006.25	43	A18234.98	24	A19236.98	23	A89000	
A18007.86	38	A18237.46	25	A19900	64	A89107.93	15
A18009.86	38	A18237.98	25	A19901	64	A89108.93	15
A18010.86	34			A19902	64	A89109.93	17
A18011.86	38	A19000		A19903	64	A89110.93	17
A18012.86	34	A19032.46	20				
A18013.86	38	A19032.98	20	A28000			
A18032.46	21	A19035.46	20	A28059.86	35		
A18032.98	21	A19035.98	20	A28157.25	48		
A18053.86	35	A19038.46	20	A28158.25	49		
A18054.86	35	A19038.98	20	A28159.25	46		
A18055.86	35	A19111.93	19	A28160.25	47		
A18056.86	35	A19112.93	19	A28203.06	53		
A18057.86	35	A19115.93	6	A28215.25	61		
A18058.86	35	A19116.93	6				
A18129.25	37	A19117.93	7	A29000			
A18130.25	37	A19118.93	7	A29100.86	27		
A18131.25	40	A19121.93	32	A29101.86	27		
A18132.25	40	A19122.93	32	A29102.86	27		
A18133.93	44	A19125.93	30	A29119.93	8		
A18143.93	5	A19126.93	30	A29120.93	9		
A18144.93	5	A19127.93	28				
A18145.93	4	A19128.93	29	A39000			
A18146.93	4	A19129.93	10	A39217.25	58		

G
Geschmacksmusterschutz
Protection of designs

⏚
Schutzklasse
Protective class

LED
E für Energiesparlampen
for energy saving lamps



light+building
Frankfurt, Germany
15. – 20. April 2012

licht.de
Fördergemeinschaft Gutes Licht
Association for the Promotion of Good Light

ZVEI:
Zentralverband Elektrotechnik-
und Elektronikindustrie e. V.
German Electrical and Electronic
Manufacturers' Association

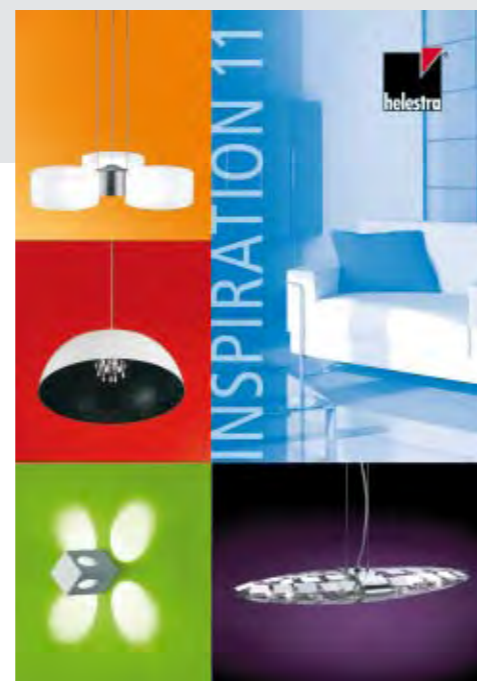

Katalog Innenleuchten
bitte anfordern
Catalogue interior lights
please request

Art.-Nr. Index
Art. no. index

INDEX



TENDO 44

Seite / Page 4 - 7

Bitte beachten Sie:

Alle Leuchten sind als Geschmacksmuster  geschützt, Nachahmungen werden gerichtlich verfolgt. Erfüllungsort und Gerichtsstand für beide Teile ist Dresden. Es gelten grundsätzlich nur unsere Verkaufs- und Lieferbedingungen. Das Eigentumsrecht dieses Kataloges behalten wir uns vor. Lieferung erfolgt ab Fabrik.

Produktinformation

Helestra Leuchten sind nach den Bestimmungen VDE 0711/EN 60598 gefertigt.

Bitte beachten Sie zusätzlich die der Leuchte beigefügten Gebrauchs- und Montageanleitungen.

Konstruktionsänderungen behalten wir uns vor.

Bei den Maßangaben handelt es sich um ca.-Abmessungen.

Please note:

The lamps are registered as protected designs , imitations will be prosecuted. Place of delivery and jurisdiction for both parties is Dresden. As a rule, only our sales and supply conditions apply. We reserve ownership rights to this catalogue. Delivery is ex works.

Product information:

Helestra lamps have been manufactured in accordance with the provisions of VDE 0711/EN 60598.

Please also read the instructions of use and assembly supplied with the lamps.

We reserve the right to design modifications.

The measurement specifications refer to approximate dimensions.

Copyright

Helestra Leuchten GmbH

Konzeption und Gestaltung
Conception and design
Weispfennig Werbeagentur GmbH
D-42329 Wuppertal

Fotografie
Photography

Klaus Stoll GmbH
D-59759 Arnsberg

Printed in Germany
11/2010

Helestra Leuchten GmbH
An den Breiten 7
D-01454 Leppersdorf
P.O. Box 01 01 41
D-01446 Radeberg
Tel. +49 (0) 35 28 / 43 83-0
Fax +49 (0) 35 28 / 43 83-44
www.light-is-outside.de
www.helestra-leuchten.de
info@helestra-leuchten.de

