



Kraus & Naimer

BLUE LINE switchgear

since 1907

Catalog 500

02/2010

Main Switches and Maintenance Switches

Switch Disconnectors of the KG and KH series

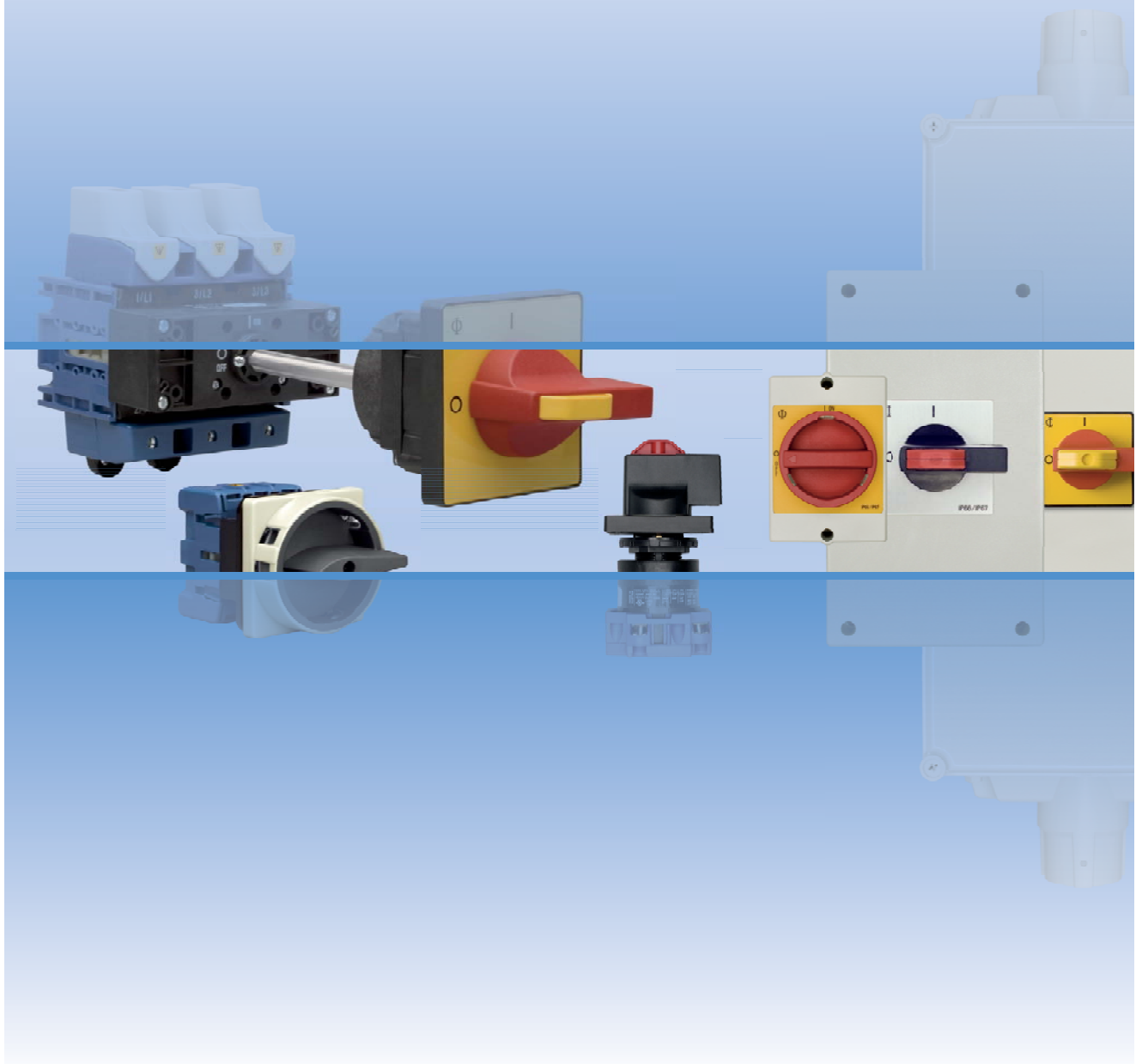

Kraus & Naimer

The development of the Blue Line rotary switch, contactor and motor starter product ranges is based on more than hundred years experience by Kraus & Naimer in the design and manufacture of electrical switchgear. Kraus & Naimer pioneered the introduction of the cam operated rotary switch and continues to be recognized as the world leader in that product field.

BLUE LINE

Blue Line products are protected by numerous patents throughout the industrial world. They are built to national and international standards and designed to withstand adverse temperatures and climates.

Blue Line products are accepted and universally recognized for their quality and workmanship. They are supported by a worldwide sales and service organization.

The Kraus & Naimer Registered Trademark



WORLDWIDE SYMBOL
FOR QUALITY SWITCHGEAR

Contents	Page
<hr/>	
Miscellaneous	
Construction Data	2
Selection of the Main Switches	2
Standard Equipment	2
Mounting Units	3
Technical Data	4, 5
Lateral mounted Auxiliary Contacts, Protective Covers	34
Add-on Escutcheon Plates	35
Terminals for Control Circuit, Unlock Insert, Mounting Key	36
Connecting Diagrams	37
<hr/>	
Main Switches and Main Switches with Emergency Function	
2 and 3 pole	6-9
4 pole	10-13
3 pole with Ground and Neutral Terminal	14-17
3 pole and Auxiliary Contact	18-21
<hr/>	
Maintenance and Safety Switches	
(Main Switches and Main Switches with Emergency Function in Plastic Enclosure)	
3 pole	22
3 pole and Auxiliary Contacts	23
4 pole	24
4 pole and Auxiliary Contacts	25
6 pole	26
6 pole and Auxiliary Contacts	27
<hr/>	
Switch Disconnectors	
3 pole	28, 29
3 pole with Ground Terminal	29
3 pole with Neutral Terminal	29
4 pole	30
6 pole	31
8 pole	31
2 pole (Double-throw Switches)	32
3 pole (Double-throw Switches)	32
4 pole (Double-throw Switches)	32
<hr/>	
Switch Disconnectors in Plastic Enclosure	
3, 4, and 6 pole	33
<hr/>	
Dimensions	
Switches for Panel Mounting	38
Switches for Base Mounting	39
Switches in Plastic Enclosure	40
<hr/>	
Blue Line Switchgear:	
Summary	44
<hr/>	
Main Switches with 4 poles and also Maintenance Switches with 6 poles and more on request.	
<hr/>	

Switch disconnectors of the KG-series



Switch disconnectors of the KH-series



Main switches of the KG- and KH-series
2 designs



Main switches C316



Maintenance and safety switches
2 designs



Construction Data

The switches described in this catalog exceed the requirements of IEC 60947-3, EN 60947-3, VDE 0660 part 107, IEC 60204, EN 60204 and VDE 0113 and meet the standard on switch disconnectors, main switches and maintenance switches.

Common characteristics of the modular switch line KG and KH are:

High circuit withstand capability and greater air and creepage distances for circuits up to 1000 V resp. 690 V. Positive contact movement during making and breaking operations.

Base mounted switches up to 100 A are designed for standard rail mounting in accordance with EN 50022. For ease of installation, switch terminations are on the same plane as the power conductors and are supplied with open terminals. Captive plus-minus terminal screws and integrated screwdriver guides also reduce wiring time.

Terminals on the KG10 through KG160 and the KH-series are all finger-proof in accordance with EN 50274, VDE 0660 part 514 and BGV A3, with additional protection IP 20 (all-around finger-proof) on the KG10 through KG64 resp. KH40.

The switches of the KH-series are also available with adjustable length through shaft and for connecting with ring type terminals. KG125, KG160, KG210, KG250 and KG315 can be supplied with bolt terminals either on top or with terminals on the top and bottom.

C type switches used as main switches require a protective cover for the outgoing and incoming terminals.

Enclosures for the C and KG type switches are made of a strong durable plastic with high UV-resistance and are designed with extra space for easy wiring. A special enclosure series which is suitable for applications in an aggressive environment, such as oil, chemical substances and grease is also available.

Selection of the Main Switches

The regulations of VDE 0113 part 1 resp. EN 60204-1 indicate a difference between switch disconnectors and disconnectors when selecting the main switch.

Switch disconnectors have to conform to category AC-23B. The disconnector must have an auxiliary contact which ensures the load interruption by means of contactor. The disconnector, therefore, should be selected according to the thermal current of the load. The auxiliary contact must have a sufficient AC-15 switching capacity to operate the contactor.

When using the switch disconnector as a main switch the breaking capacity of the switch has to be considered. The interruption capacity of the switch must equal or exceed the locked rotor current of the machine's largest motor plus the total current of all other electrical equipment in the circuit. In addition, the total nominal current of all electrical equipment may not exceed the rated thermal current of the switch.

Standard Equipment

Main Switches and Main Switches with Emergency Function:

Are supplied with a padlockable handle and protective cover for all the incoming terminals for switch types C316, KG80 through KG315, KH63 and KH80. Switch types C316, KG210, KG250 and KG315 are also supplied with protective covers on the outgoing terminals.

Main switches are fitted with black handles. Main switches with emergency function are supplied with red handles and contrasting yellow escutcheon plate.

Switches with door clutches are also supplied with a padlock device.

Maintenance and Safety Switches (Main Switches and Main Switches with Emergency Function in Enclosure):

High strength durable plastic enclosures are designed with extra space for easy wiring (see Construction Data), totally insulated acc. to IEC 364-4-41, HD 384.4.41 S2 and VDE 0100-410. Main switches are fitted with electro-gray or black handles. Main switches with emergency function are supplied with red handles and contrasting yellow escutcheon plate.

Ground terminal.

Special safety interlocked covers supplied with enclosures.

Switches with code numbers ending with STM are supplied with conduit entries.



Notes:

Auxiliary contacts close after the main contacts close and open before main contacts open. A selection of padlock devices are shown on page 3.

Main switches with 4 poles and also maintenance switches with 6 poles and more on request.

Ordering Information

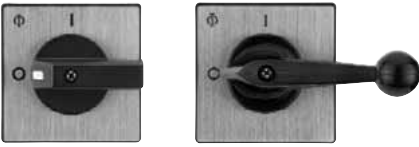
Ordering information is shown in blue on pages 6-35.

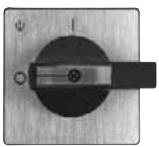
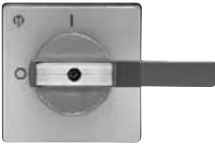
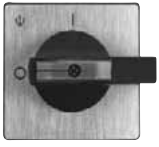

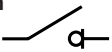
Mounting Units Switch disconnectors Main switches and main switches with emergency function with padlock device	Size in mm	Padlocks Max. Pad-lock Shackle in mm		Standard for Switch Types Further variations on request.
 <p style="text-align: center;">KG210, KG250, KG315</p>	48 x 48 64 x 64 88 x 88 130 x 130	– – – – – – – –	<p><u>Four hole panel mounting, base mounting</u> KG10A, KG 20A, KG32A, KG41, KG64, KH16, KH20, KH25 <u>Single hole mounting 22 mm</u> KG10A, KG20A, KG32A, KH16, KH20, KH25 <u>Direct-mounting on printed circuit board</u> KG21A, KG33A</p> <p><u>Four hole panel mounting, base mounting</u> KG10B, KG20B, KG32B, KG41B, KG64B, KG80, KG100, KH16B, KH20B, KH25B, KH32, KH40, KH63, KH80 KG80C, KG100C, KG125, KG160, KG210, KG250, KG315 C316</p>	
	74 x 74	3 9	<p><u>In enclosure</u> KG10, KG20, KG20B, KG32, KG32B, KG41, KG41B, KG64, KG64B, KG80, KG100 KH16, KH20, KH25, KH32, KH40, KH63, KH80</p>	
	64 x 64 88 x 88	3 9 3 10	<p><u>Four hole panel mounting, base mounting</u> KG10B, KG20B, KG32B, KG41B, KG64B, KG80, KG100, KH16B, KH20B, KH25B, KH32, KH40, KH63, KH80 <u>Single hole mounting 22 mm</u> KG10B, KG20B, KG32B, KH16, KH20, KH25, KH32, KH40</p> <p><u>Four hole panel mounting</u> KG80C, KG100C, KG125, KG160 <u>Base mounting</u> KG125, KG160 <u>In enclosure</u> KG80C, KG100C, KG125, KG160</p>	
	48 x 48 64 x 64 88 x 88 130 x 130	3 7 or 4 5 3 8 or 4 5 4 9 4 9	<p><u>Four hole panel mounting, base mounting</u> KG10A, KG20A, KG32A, KG41, KG64, KH16, KH20, KH25 <u>Single hole mounting 22 mm</u> KG10A, KG20A, KG32A, KH16, KH20, KH25</p> <p><u>Four hole panel mounting or</u> <u>Single hole mounting 22 mm, base mounting</u> KG10B, KG20B, KG32B, KG41B, KG64B, KG80, KG100, KH16B, KH20B, KH25B, KH32, KH40, KH63, KH80 <u>In enclosure</u> KG10, KG20, KG20B, KG32, KG32B, KG41, KG41B, KG64, KG64B, KG80, KG100</p> <p><u>Four hole panel mounting</u> KG80C, KG100C, KG125, KG160, KG210, KG250, KG315 KG41B T..3/81 E, KG64B T..3/81 E <u>In enclosure</u> KG80C, KG100C, KG125, KG160, KG250, KG315 <u>Four hole panel mounting and in enclosure</u> C316</p>	
	88 x 88	4 9	<p><u>Four hole panel mounting</u> KG250, KG315</p>	
	88 x 88	3 9	<p><u>Base mounting</u> KG20B, KG32B, KG41B, KG64B, KG80, KG100, KG125, KG160, KG210, KG250, KG315, KH32, KH40, KH63, KH80, C316</p> <p>With integrated door clutch. Using the device the electrical panel may be opened only when the switch is in the OFF position and no padlock is fitted. Note: Only in the ON position can knowledgeable personnel using a simple tool to defeat the interlock. The M700's flexibility allows for successful installation with as much as + or – 5 mm of misalignment between the shaft and door.</p>	

Technical Data in accordance with IEC 60947, EN 60947, VDE 0660, IEC 60204, EN 60204, VDE 0113 			KG10	KH16	KG20	KH20	KH25	KG32	KG41	
Nominal ratings for North America (UL) see Catalog 150 ⁵ .			KG10A KG10B	KH16B	KG20A KG20B	KH20B	KH25B	KG32A KG32B	KH32 KG41B	
Rated Values										
Insulation voltage U_i^1	V	690	800 ²	690	800 ²	800 ²	690	800 ²	690	
min. voltage	V				on request					
Impulse withstand voltage U_{imp}^1	kV	4	6	6	6	6	6	6	6	
Thermal current	$I_{u\ open} = I_{th}$	A	20	16	25	20	25	32	32	40
	$I_{the\ enclosed}$	A	20	16	25	20	25	32	32	40
Breaking capacity	220 V/240 V	A	120	160	180	200	250	220	300	300
	380 V/440 V	A	120	160	180	200	250	220	300	300
	660 V/690 V	A	80	160	125	160	180	135	210	150
Main Switch Voltage Rating										
Disconnection property up to ¹	V	690	690	690	690	690	690	690	690	
Utilization Category										
AC-21A Switch disconnectors for resistive load I_e	A	20	16	25	20	25	32	32	40	
AC-3 Direct switching of single motors	3 phase, 3 pole 220 V/240 V	kW	2,2	3	4	3,5	4	5,5	5,5	7,5
	380 V/440 V	kW	3,7	5,5	5,5	6,5	7,5	7,5	11	11
	660 V/690 V	kW	3,7	5,5	5,5	6,5	7,5	7,5	11	11
AC-23A, Switch disconnectors for motor circuits, main switches etc.	1 phase, 2 pole 220 V/240 V	kW	1,1	1,5		2	2,5		3	
	380 V/440 V	kW	1,5	2,5		3,2	5		5,5	
AC-23B connectors for motor circuits, main switches etc.	3 phase, 3 pole 220 V/240 V	kW	3	4,5	5,5	5,5	7	5,5	9	7,5
	380 V/440 V	kW	5,5	7,5	7,5	10	12	11	16	15
	660 V/690 V	kW	5,5	13	7,5	15	17	11	22	15
AC-23B connectors for motor circuits, main switches etc.	1 phase, 2 pole 220 V/240 V	kW	1,5	2		2,5	3,3		4,2	
	380 V/440 V	kW	2,2	3,7		4,5	5,5		7,5	
Power loss per contact at I_u	W	0,9	0,2	0,7	0,3	0,3	1,1	0,4	1	
Resistance to vibration ⁷	C	C	C	A	C	C	A	C	A	
Resistance to shock ⁷	C	C	C	B	C	C	B	C	B	
Short Circuit Protection										
Max. fuse size (gL-characteristic)	A	20	25	35	35	35	35	35	50	
Rated short-time withstand current (1s-current)	A	130	400	350	450	500	430	850	500	
Max. Permissible Wire Gage⁶										
Single-core or stranded wire	mm ²	2,5	6	6	6	6	6	10	16	
	AWG	12	10	10	10	10	10	8	6	
	MCM	–	–	–	–	–	–	–	–	
Flexible wire with sleeve	mm ²	2,5	4	4	4	4	4	6	10	
	AWG	12	12	10	12	12	10	10	6	
Flexible AWG wires (without sleeve)	MCM	–	–	–	–	–	–	–	–	
	mm	–	–	–	–	–	–	–	–	
Connecting bolts	mm	–	–	–	–	–	–	–	–	
Flat copper busbar	mm	–	–	–	–	–	–	–	–	
Auxiliary Contacts Rated Values										
Insulation voltage U_i^1	V	690	440	500	440	440	500	440	690	
Impulse withstand voltage U_{imp}^1	kV	4	4	6	4	4	6	4	6	
Thermal current	$I_{u\ open} = I_{th}$	A	20	10	10	10	10	10	16	
	$I_{the\ enclosed}$	A	20	10	10	10	10	10	16	
AC-15 Operational current I_e	220 V/240 V	A	6	2,5	2,5	2,5	2,5	2,5	6	
	380 V/440 V	A	4	1,5	1,5	1,5	1,5	1,5	3	
Short Circuit Protection										
Max. fuse size (gL-characteristic)	A	20	10	10	10	10	10	10	16	
Max. Permissible Wire Gage⁶										
Single-core or stranded wire	mm ²	2,5	1,5	1,5	1,5	1,5	1,5	1,5	2,5	
	AWG	12	14	14	14	14	14	14	12	
Flexible wire with sleeve	mm ²	2,5	1,5	1,5	1,5	1,5	1,5	1,5	2,5	
	AWG	12	16	16	16	16	16	16	14	

KH40	KG64 KG64B	KH63	KG80 KG80C	KH80	KG100 KG100C	KG125	KG160	KG210	KG250	KG315	C316
800 ²	690	1000 ²	690	1000 ²	690	1000 ²	1000 ²	1000 ²	1000 ²	1000 ²	1000
6	6	8	6	8	6	8	8	8	8	8	8
40	63	63	80	80	100	125	160	200	250	315	315
40	63	63	80	80	100	125	160	200	250	315	315/275 ³
380	350	550	560	650	700	800	900	1300	1600	1800	2000
380	350	500	560	630	650	750	850	1100	1380	1650	2000
230	190	280	200	340	280	340	340	400	400	400	335
690	690	1000 ²	690	1000 ²	690	1000 ²	1000 ²	1000 ²	1000 ²	1000 ²	1000
40	63	63	80	80	100	125	160	200	250	315	315
7,5	11	11	15	15	18,5	22	30	37	37	45	37
15	18,5	22	22	30	30	37	45	55	55	75	55
15	15	18,5	18,5	22	22	30	37	40	40	45	37
4,5		7,5		10							
9		11		15							
11	11	18,5	18,5	23	22	30	30	37	37	55	75
20	22	30	30	40	37	45	55	75	90	110	132
25	18,5	30	22	37	30	37	37	45	45	45	37
5,5		8,5		11							
11		15		18,5							
0,6	2,2	1,5	1,7	2,7	2,4	3,1	5	5	8	12,7	17
C	A	C	A	C	A	C	C	C	C	C	C
C	B	C	B	C	B	C	C	C	C	C	C
50	63	80	80	100	100	125	160	200	250	315	315
950	580	1200	1600	1600	1850	2500	3000	4000	4600	5800	4200
10	16	35	50	35	50	95	95	185	185	185	185 ⁴
8	6	2	1/0	2	1/0	3/0	3/0	–	–	–	–
–	–	–	–	–	–	–	–	350	350	350	350
6	10	25	35	25	35	70	70	120	120	120	150 ⁴
10	6	4	2	4	2	1/0	1/0	–	–	–	–
–	–	–	–	–	–	–	–	250	250	250	300
–	–	–	–	–	–	–	–	–	–	–	M12
–	–	–	–	–	–	–	–	–	–	–	–
440	690	440	690	440	690	690	690	690	690	690	690
4	6	4	6	4	6	6	6	6	6	6	6
10	16	10	16	10	16	16	16	16	16	16	16
10	16	10	16	10	16	16	16	16	16	16	16
2,5	6	2,5	6	2,5	6	6	6	6	6	6	6
1,5	3	1,5	3	1,5	3	3	3	3	3	3	4
10	16	10	16	10	16	16	16	16	16	16	16
1,5	2,5	1,5	2,5	1,5	2,5	2,5	2,5	2,5	2,5	2,5	4
14	12	14	12	14	12	12	12	12	12	12	12
1,5	2,5	1,5	2,5	1,5	2,5	2,5	2,5	2,5	2,5	2,5	2,5
16	14	16	14	16	14	14	14	14	14	14	14

⁵The switches of the KG- and KH-series shown in this catalog are approved by UL and CSA as „disconnect switches for use in motor circuits“. Exception: Switches in enclosure. ⁶Use copper wire only. ⁷A: min. 4 g, 2-100 Hz, 1,6 mm. B: min. 5 g, 6 ms. C: on request. Storage temperature for all switch types: -40 °C to 85 °C (in case of temperature below -5 °C no shock load permissible).

Main Switches and Main Switches with Emergency Function 2 and 3 pole, for Four Hole Panel Mounting

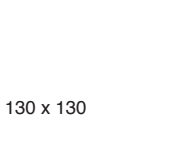

Version	Thermal Current I_U/I_{th}	Ratings AC-23A, AC-23B Breaking Capacity	Main Switches Handle black	EAN-Code 9004257	Main Switches with Emergency Function Handle red Contrasting yellow plate	EAN-Code 9004257	
IP 66 64 x 64 	20 A	220 V/240 V 1,5 kW / 120 A	2 pole KG10B T102/01 E	01367 8	2 pole KG10B T202/01 E	01375 3	
	20 A	3 x 380 V/440 V 5,5 kW / 120 A	3 pole KG10B T103/01 E	01044 8	3 pole KG10B T203/01 E	01049 3	
	25 A	7,5 kW / 180 A	KG20B T103/01 E	00001 2	KG20B T203/01 E	00043 2	
	32 A	11 kW / 220 A	KG32B T103/01 E	00002 9	KG32B T203/01 E	00044 9	
	40 A	15 kW / 300 A	KG41B T103/01 E	00003 6	KG41B T203/01 E	00045 6	
	63 A	22 kW / 350 A	KG64B T103/01 E	00004 3	KG64B T203/01 E	00046 3	
	80 A	30 kW / 560 A	KG80 T103/01 E	00005 0	KG80 T203/01 E	00047 0	
	100 A	37 kW / 650 A	KG100 T103/01 E	00006 7	KG100 T203/01 E	00048 7	
	80 A	30 kW / 560 A	KG80C T103/01 E	01383 8	KG80C T203/01 E	01389 0	
	100 A	37 kW / 650 A	KG100C T103/01 E	01384 5	KG100C T203/01 E	01390 6	
	125 A	45 kW / 750 A	KG125 T103/01 E	00008 1	KG125 T203/01 E	00050 0	
	160 A	55 kW / 850 A	KG160 T103/01 E	00009 8	KG160 T203/01 E	00051 7	
	IP 66 ¹ 48 x 48 	20 A	220 V/240 V 1,5 kW / 120 A	2 pole KG10A T102/04 E	01368 5	2 pole KG10A T202/04 E	01376 0
		20 A	3 x 380 V/440 V 5,5 kW / 120 A	3 pole KG10A T103/04 E	01046 2	3 pole KG10A T203/04 E	01051 6
25 A		7,5 kW / 180 A	KG20A T103/04 E	01110 0	KG20A T203/04 E	01132 2	
32 A		11 kW / 220 A	KG32A T103/04 E	01111 7	KG32A T203/04 E	01133 9	
40 A		15 kW / 300 A	KG41 T103/04 E	01112 4	KG41 T203/04 E	01134 6	
63 A		22 kW / 350 A	KG64 T103/04 E	01113 1	KG64 T203/04 E	01135 3	
20 A		220 V/240 V 1,5 kW / 120 A	2 pole KG10B T102/04 E	01369 2	2 pole KG10B T202/04 E	01377 7	
20 A		3 x 380 V/440 V 5,5 kW / 120 A	3 pole KG10B T103/04 E	01047 9	3 pole KG10B T203/04 E	01052 3	
25 A		7,5 kW / 180 A	KG20B T103/04 E	01114 8	KG20B T203/04 E	01136 0	
32 A		11 kW / 220 A	KG32B T103/04 E	01115 5	KG32B T203/04 E	01137 7	
40 A		15 kW / 300 A	KG41B T103/04 E	01116 2	KG41B T203/04 E	01138 4	
63 A		22 kW / 350 A	KG64B T103/04 E	01117 9	KG64B T203/04 E	01139 1	
80 A		30 kW / 560 A	KG80 T103/04 E	01118 6	KG80 T203/04 E	01140 7	
100 A		37 kW / 650 A	KG100 T103/04 E	01119 3	KG100 T203/04 E	01141 4	
88 x 88 	40 A	15 kW / 300 A	KG41B T103/81 E	03170 2	KG41B T203/81 E	03172 6	
	63 A	22 kW / 350 A	KG64B T103/81 E	03171 9	KG64B T203/81 E	03173 3	
	80 A	30 kW / 560 A	KG80C T103/04 E	00021 0	KG80C T203/04 E	00063 0	
	100 A	37 kW / 650 A	KG100C T103/04 E	00022 7	KG100C T203/04 E	00064 7	
	125 A	45 kW / 750 A	KG125 T103/04 E	00024 1	KG125 T203/04 E	00066 1	
	160 A	55 kW / 850 A	KG160 T103/04 E	00025 8	KG160 T203/04 E	00067 8	
	200 A	75 kW / 1100 A	KG210 T103/05 E	07491 4	KG210 T203/05 E	07484 6	
	250 A	90 kW / 1380 A	KG250 T103/05 E	00027 2	KG250 T203/05 E	00069 2	
	315 A	110 kW / 1650 A	KG315 T103/05 E	00028 9	KG315 T203/05 E	00070 8	
	315 A	132 kW / 2000 A	C316 T103/05 E	00029 6	C316 T203/05 E	00071 5	
130 x 130	315 A	132 kW / 2000 A	C316 T103/05 E	00029 6	C316 T203/05 E	00071 5	

¹C316 protection IP 40. Higher protection available on request.

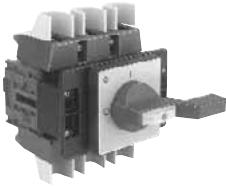

Main Switches and Main Switches with Emergency Function 3 pole, for Four Hole Panel Mounting

Version	Thermal Current I_u/I_{th}	Ratings AC-23A, AC-23B Breaking Capacity 3 x 380 V/440 V	Main Switches Handle black	EAN-Code 9004257	Main Switches with Emergency Function Handle red Contrasting yellow plate	EAN-Code 9004257
IP 66 88 x 88 	250 A 315 A	90 kW / 1380 A 110 kW / 1650 A	KG250 T103/66 E KG315 T103/66 E	01276 3 01277 0	KG250 T203/66 E KG315 T203/66 E	01278 7 01279 4

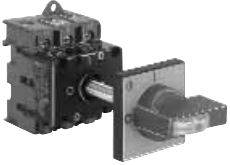

Main Switches and Main Switches with Emergency Function 2 and 3 pole, for Single Hole Mounting 22 mm

Version	Thermal Current I_u/I_{th}	Ratings AC-23A, AC-23B Breaking Capacity	Main Switches Handle black	EAN-Code 9004257	Main Switches with Emergency Function Handle red Contrasting yellow plate	EAN-Code 9004257
IP 66 64 x 64 	20 A 20 A 25 A 32 A	220 V/240 V 1,5 kW / 120 A 3 x 380 V/440 V 5,5 kW / 120 A 7,5 kW / 180 A 11 kW / 220 A	2 pole KG10B T102/01 FT2 3 pole KG10B T103/01 FT2 KG20B T103/01 FT2 KG32B T103/01 FT2	01372 2 01048 6 00085 2 00086 9	2 pole KG10B T202/01 FT2 3 pole KG10B T203/01 FT2 KG20B T203/01 FT2 KG32B T203/01 FT2	01380 7 01053 0 00089 0 00090 6
IP 66 48 x 48 	20 A 20 A 25 A 32 A	220 V/240 V 1,5 kW / 120 A 3 x 380 V/440 V 5,5 kW / 120 A 7,5 kW / 180 A 11 kW / 220 A	2 pole KG10A T102/04 FT2 3 pole KG10A T103/04 FT2 KG20A T103/04 FT2 KG32A T103/04 FT2	01370 8 01054 7 01130 8 01131 5	2 pole KG10A T202/04 FT2 3 pole KG10A T203/04 FT2 KG20A T203/04 FT2 KG32A T203/04 FT2	01378 4 01072 1 01152 0 01153 7
64 x 64	20 A	220 V/240 V 1,5 kW / 120 A	2 pole KG10B T102/04 FT2	01371 5	2 pole KG10B T202/04 FT2	01379 1
	20 A 25 A 32 A	3 x 380 V/440 V 5,5 kW / 120 A 7,5 kW / 180 A 11 kW / 220 A	3 pole KG10B T103/04 FT2 KG20B T103/04 FT2 KG32B T103/04 FT2	01055 4 01056 1 01057 8	3 pole KG10B T203/04 FT2 KG20B T203/04 FT2 KG32B T203/04 FT2	01073 8 01074 5 01075 2

**Main Switches and Main Switches with Emergency Function
2 and 3 pole, for Base Mounting
with Simplified Door Clutch, Padlock Device and Single Hole Mounting 22 mm**

Version	Thermal Current I_U/I_{th}	Ratings AC-23A, AC-23B Breaking Capacity	Main Switches	EAN-Code 9004257	Main Switches with Emergency Function	EAN-Code 9004257
IP 66 48 x 48 	20 A	220 V/240 V 1,5 kW / 120 A	2 pole KG10A T102/68 VE	01373 9	2 pole KG10A T202/68 VE	01381 4
	20 A	3 x 380 V/440 V 5,5 kW / 120 A	3 pole KG10A T103/68 VE	01060 8	3 pole KG10A T203/68 VE	01078 3
	25 A	7,5 kW / 180 A	KG20A T103/68 VE	01061 5	KG20A T203/68 VE	01079 0
	32 A	11 kW / 220 A	KG32A T103/68 VE	01062 2	KG32A T203/68 VE	01080 6
	40 A	15 kW / 300 A	KG41 T103/68 VE	01063 9	KG41 T203/68 VE	01081 3
	63 A	22 kW / 350 A	KG64 T103/68 VE	01064 6	KG64 T203/68 VE	01082 0
64 x 64	20 A	220 V/240 V 1,5 kW / 120 A	2 pole KG10B T102/68 VE	01374 6	2 pole KG10B T202/68 VE	01382 1
	20 A	3 x 380 V/440 V 5,5 kW / 120 A	3 pole KG10B T103/68 VE	01065 3	3 pole KG10B T203/68 VE	01083 7
	25 A	7,5 kW / 180 A	KG20B T103/68 VE	01066 0	KG20B T203/68 VE	01084 4
	32 A	11 kW / 220 A	KG32B T103/68 VE	01067 7	KG32B T203/68 VE	01085 1
	40 A	15 kW / 300 A	KG41B T103/68 VE	01068 4	KG41B T203/68 VE	01086 8
	63 A	22 kW / 350 A	KG64B T103/68 VE	01069 1	KG64B T203/68 VE	01087 5
	80 A	30 kW / 560 A	KG80 T103/68 VE	01070 7	KG80 T203/68 VE	01088 2
	100 A	37 kW / 650 A	KG100 T103/68 VE	01071 4	KG100 T203/68 VE	01089 9
IP 66 64 x 64 	20 A	3 x 380 V/440 V 5,5 kW / 120 A	3 pole KG10B T103/93 VE	06347 5	3 pole KG10B T203/93 VE	06354 3
	25 A	7,5 kW / 180 A	KG20B T103/93 VE	06348 2	KG20B T203/93 VE	06355 0
	32 A	11 kW / 220 A	KG32B T103/93 VE	06349 9	KG32B T203/93 VE	06356 7
	40 A	15 kW / 300 A	KG41B T103/93 VE	06350 5	KG41B T203/93 VE	06357 4
	63 A	22 kW / 350 A	KG64B T103/93 VE	06351 2	KG64B T203/93 VE	06358 1
	80 A	30 kW / 560 A	KG80 T103/93 VE	06352 9	KG80 T203/93 VE	06359 8
	100 A	37 kW / 650 A	KG100 T103/93 VE	06353 6	KG100 T203/93 VE	06360 4
Misalignment between the shaft and operator is compensated for by a centering device.						
IP 66 64 x 64 	20 A	3 x 380 V/440 V 5,5 kW / 120 A	3 pole KG10B T103/94 VE	06361 1	3 pole KG10B T203/94 VE	06368 0
	25 A	7,5 kW / 180 A	KG20B T103/94 VE	06362 8	KG20B T203/94 VE	06369 7
	32 A	11 kW / 220 A	KG32B T103/94 VE	06363 5	KG32B T203/94 VE	06370 3
	40 A	15 kW / 300 A	KG41B T103/94 VE	06364 2	KG41B T203/94 VE	06371 0
	63 A	22 kW / 350 A	KG64B T103/94 VE	06365 9	KG64B T203/94 VE	06372 7
	80 A	30 kW / 560 A	KG80 T103/94 VE	06366 6	KG80 T203/94 VE	06373 4
	100 A	37 kW / 650 A	KG100 T103/94 VE	06367 3	KG100 T203/94 VE	06374 1
Misalignment between the shaft and operator is compensated for by a centering device.						

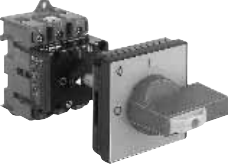
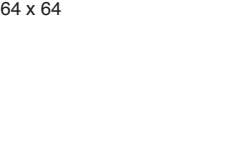
Main Switches and Main Switches with Emergency Function 3 pole, for Base Mounting with Door Clutch

Version	Thermal Current I_u/I_{th}	Ratings AC-23A, AC-23B Breaking Capacity 3 x 380 V/440 V	Main Switches Handle black	EAN-Code 9004257	Main Switches with Emergency Function Handle red Contrasting yellow plate	EAN-Code 9004257
IP 66/67 64 x 64 	20 A 25 A 32 A 40 A 63 A 80 A 100 A	5,5 kW / 120 A 7,5 kW / 180 A 11 kW / 220 A 15 kW / 300 A 22 kW / 350 A 30 kW / 560 A 37 kW / 650 A	KG10B T103/09 VE KG20B T103/09 VE KG32B T103/09 VE KG41B T103/09 VE KG64B T103/09 VE KG80 T103/09 VE KG100 T103/09 VE	01280 0 00093 7 00094 4 00095 1 00096 8 00097 5 00098 2	KG10B T203/09 VE KG20B T203/09 VE KG32B T203/09 VE KG41B T203/09 VE KG64B T203/09 VE KG80 T203/09 VE KG100 T203/09 VE	01281 7 00107 1 00108 8 00109 5 00110 1 00111 8 00112 5
88 x 88	125 A 160 A	45 kW / 750 A 55 kW / 850 A	KG125 T103/09 VE KG160 T103/09 VE	00100 2 00101 9	KG125 T203/09 VE KG160 T203/09 VE	00114 9 00115 6
IP 66/67 48 x 48 	20 A 25 A 32 A	5,5 kW / 120 A 7,5 kW / 180 A 11 kW / 220 A	KG10A T103/65 VE KG20A T103/65 VE KG32A T103/65 VE	01058 5 01120 9 01121 6	KG10A T203/65 VE KG20A T203/65 VE KG32A T203/65 VE	01076 9 01142 1 01143 8
64 x 64 	20 A 25 A 32 A 40 A 63 A 80 A 100 A	5,5 kW / 120 A 7,5 kW / 180 A 11 kW / 220 A 15 kW / 300 A 22 kW / 350 A 30 kW / 560 A 37 kW / 650 A	KG10B T103/65 VE KG20B T103/65 VE KG32B T103/65 VE KG41B T103/65 VE KG64B T103/65 VE KG80 T103/65 VE KG100 T103/65 VE	01059 2 01124 7 01125 4 01126 1 01127 8 01128 5 01129 2	KG10B T203/65 VE KG20B T203/65 VE KG32B T203/65 VE KG41B T203/65 VE KG64B T203/65 VE KG80 T203/65 VE KG100 T203/65 VE	01077 6 01146 9 01147 6 01148 3 01149 0 01150 6 01151 3
IP 66 88 x 88  <p>Using the device the electrical panel may be opened only when the switch is in the OFF position and no padlock is fitted. Note: Only in the ON position can knowledgeable personnel using a simple tool to defeat the interlock. The M700's flexibility allows for successful installation with as much as + or - 5 mm of misalignment between the shaft and door.</p>	25 A 32 A 40 A 63 A 80 A 100 A 125 A 160 A 200 A 250 A 315 A 315 A	7,5 kW / 180 A 11 kW / 220 A 15 kW / 300 A 22 kW / 350 A 30 kW / 560 A 37 kW / 650 A 45 kW / 750 A 55 kW / 850 A 75 kW / 1100 A 90 kW / 1380 A 110 kW / 1650 A 132 kW / 2000 A	KG20B T103/12 VE KG32B T103/12 VE KG41B T103/12 VE KG64B T103/12 VE KG80 T103/12 VE KG100 T103/12 VE KG125 T103/12 VE KG160 T103/12 VE KG210 T103/13 VE KG250 T103/13 VE KG315 T103/13 VE C316 T103/13 VE	01591 7 01592 4 00129 3 00130 9 00131 6 00132 3 00134 7 00135 4 07492 1 00137 8 00138 5 00139 2	KG20B T203/12 VE KG32B T203/12 VE KG41B T203/12 VE KG64B T203/12 VE KG80 T203/12 VE KG100 T203/12 VE KG125 T203/12 VE KG160 T203/12 VE KG210 T203/13 VE KG250 T203/13 VE KG315 T203/13 VE C316 T203/13 VE	01593 1 01594 8 00159 0 00160 6 00161 3 00162 0 00164 4 00165 1 07485 3 00167 5 00168 2 00169 9

Main Switches and Main Switches with Emergency Function 4 pole, for Four Hole Panel Mounting

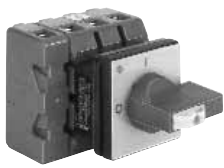
Version	Thermal Current I_U/I_{th}	Ratings AC-23A, AC-23B Breaking Capacity 3 x 380 V/440 V	Main Switches Handle black	EAN-Code 9004257	Main Switches with Emergency Function Handle red Contrasting yellow plate	EAN-Code 9004257
IP 66 64 x 64 	16 A 20 A 25 A 32 A 40 A 63 A 80 A 100 A	7,5 kW / 160 A 10 kW / 200 A 12 kW / 250 A 16 kW / 300 A 20 kW / 380 A 30 kW / 500 A 40 kW / 630 A 37 kW / 650 A	KH16B T104/01 E KH20B T104/01 E KH25B T104/01 E KH32 T104/01 E KH40 T104/01 E KH63 T104/01 E KH80 T104/01 E KG100 T104/01 E	07091 6 07092 3 07093 0 06510 3 06512 7 07493 8 07494 5 00186 6	KH16B T204/01 E KH20B T204/01 E KH25B T204/01 E KH32 T204/01 E KH40 T204/01 E KH63 T204/01 E KH80 T204/01 E KG100 T204/01 E	07094 7 07095 4 07096 1 06511 0 06513 4 07486 0 07487 7 00228 3
88 x 88	80 A 100 A 125 A 160 A	30 kW / 560 A 37 kW / 650 A 45 kW / 750 A 55 kW / 850 A	KG80C T104/01 E KG100C T104/01 E KG125 T104/01 E KG160 T104/01 E	01385 2 01386 9 00188 0 00189 7	KG80C T204/01 E KG100C T204/01 E KG125 T204/01 E KG160 T204/01 E	01391 3 01392 0 00230 6 00231 3
IP 66 ¹ 48 x 48	16 A 20 A 25 A 32 A 40 A 63 A	7,5 kW / 160 A 10 kW / 200 A 12 kW / 250 A 11 kW / 220 A 15 kW / 300 A 22 kW / 350 A	KH16 T104/04 E KH20 T104/04 E KH25 T104/04 E KG32A T104/04 E KG41 T104/04 E KG64 T104/04 E	07097 8 07099 2 07101 2 01236 7 01238 1 01240 4	KH16 T204/04 E KH20 T204/04 E KH25 T204/04 E KG32A T204/04 E KG41 T204/04 E KG64 T204/04 E	07098 5 07100 5 07102 9 01248 0 01250 3 01252 7
64 x 64 	16 A 20 A 25 A 32 A 40 A 63 A 80 A 100 A	7,5 kW / 160 A 10 kW / 200 A 12 kW / 250 A 16 kW / 300 A 20 kW / 380 A 30 kW / 500 A 40 kW / 630 A 37 kW / 650 A	KH16B T104/04 E KH20B T104/04 E KH25B T104/04 E KH32 T104/04 E KH40 T104/04 E KH63 T104/04 E KH80 T104/04 E KG100 T104/04 E	07103 6 07104 3 07105 0 06514 1 06516 5 07495 2 07496 9 01243 5	KH16B T204/04 E KH20B T204/04 E KH25B T204/04 E KH32 T204/04 E KH40 T204/04 E KH63 T204/04 E KH80 T204/04 E KG100 T204/04 E	07106 7 07107 4 07108 1 06515 8 06517 2 07488 4 07489 1 01255 8
88 x 88	80 A 100 A 125 A 160 A 200 A 250 A 315 A	30 kW / 560 A 37 kW / 650 A 45 kW / 750 A 55 kW / 850 A 75 kW / 1100 A 90 kW / 1380 A 110 kW / 1650 A	KG80C T104/04 E KG100C T104/04 E KG125 T104/04 E KG160 T104/04 E KG210 T104/05 E KG250 T104/05 E KG315 T104/05 E	00201 6 00202 3 00204 7 00205 4 07497 6 00207 8 00208 5	KG80C T204/04 E KG100C T204/04 E KG125 T204/04 E KG160 T204/04 E KG210 T204/05 E KG250 T204/05 E KG315 T204/05 E	00243 6 00244 3 00246 7 00247 4 07490 7 00249 8 00250 4
130 x 130	315 A	132 kW / 2000 A	C316 T104/05 E	00209 2	C316 T204/05 E	00251 1

¹C316 protection IP 40. Higher protection available on request.

Main Switches and Main Switches with Emergency Function 4 pole, for Four Hole Panel Mounting

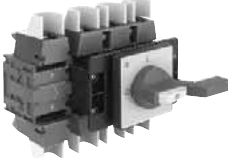

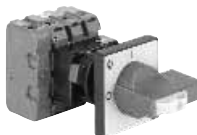

Version	Thermal Current I_U/I_{th}	Ratings AC-23A, AC-23B Breaking Capacity 3 x 380 V/440 V	Main Switches	EAN-Code 9004257	Main Switches with Emergency Function	EAN-Code 9004257
Protection Escutcheon plate in mm			Handle black		Handle red Contrasting yellow plate	
IP 66 88 x 88	250 A 315 A	90 kW / 1380 A 110 kW / 1650 A	KG250 T104/66 E KG315 T104/66 E	01256 5 01257 2	KG250 T204/66 E KG315 T204/66 E	01258 9 01259 6
						

Main Switches and Main Switches with Emergency Function 4 pole, for Single Hole Mounting 22 mm

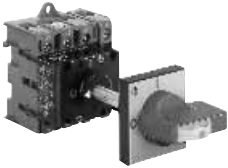

Version	Thermal Current I_U/I_{th}	Ratings AC-23A, AC-23B Breaking Capacity 3 x 380 V/440 V	Main Switches	EAN-Code 9004257	Main Switches with Emergency Function	EAN-Code 9004257
Protection Escutcheon plate in mm			Handle black		Handle red Contrasting yellow plate	
IP 66 64 x 64	16 A 20 A 25 A 32 A 40 A 63 A 80 A	7,5 kW / 160 A 10 kW / 200 A 12 kW / 250 A 16 kW / 300 A 20 kW / 380 A 30 kW / 500 A 40 kW / 630 A	KH16 T104/01 FH3 KH20 T104/01 FH3 KH25 T104/01 FH3 KH32 T104/01 FH3 KH40 T104/01 FH3 KH63 T104/01 FH3 ¹ KH80 T104/01 FH3 ¹	07109 8 07110 4 07111 1 06668 1 06669 8 08908 6 08910 9	KH16 T204/01 FH3 KH20 T204/01 FH3 KH25 T204/01 FH3 KH32 T204/01 FH3 KH40 T204/01 FH3 KH63 T204/01 FH3 ¹ KH80 T204/01 FH3 ¹	07112 8 07113 5 07114 2 06670 4 06671 1 08909 3 08911 6
IP 66 48 x 48	16 A 20 A 25 A 32 A	7,5 kW / 160 A 10 kW / 200 A 12 kW / 250 A 11 kW / 220 A	KH16 T104/04 FT2 KH20 T104/04 FT2 KH25 T104/04 FT2 KG32A T104/04 FT2	07115 9 07116 6 07117 3 01266 4	KH16 T204/04 FT2 KH20 T204/04 FT2 KH25 T204/04 FT2 KG32A T204/04 FT2	07118 0 07119 7 07120 3 01272 5
64 x 64	16 A 20 A 25 A 32 A 40 A 63 A 80 A	7,5 kW / 160 A 10 kW / 200 A 12 kW / 250 A 16 kW / 300 A 20 kW / 380 A 30 kW / 500 A 40 kW / 630 A	KH16 T104/04 FH3 KH20 T104/04 FH3 KH25 T104/04 FH3 KH32 T104/04 FH3 KH40 T104/04 FH3 KH63 T104/04 FH3 ¹ KH80 T104/04 FH3 ¹	07121 0 07122 7 07123 4 06672 8 06673 5 08912 3 08914 7	KH16 T204/04 FH3 KH20 T204/04 FH3 KH25 T204/04 FH3 KH32 T204/04 FH3 KH40 T204/04 FH3 KH63 T204/04 FH3 ¹ KH80 T204/04 FH3 ¹	07124 1 07125 8 07126 5 06674 2 06675 9 08913 0 08915 4
						
						

¹For KH63 and KH80 use flexible wire only in order to avoid excessive pressure on single hole mounting.

**Main Switches and Main Switches with Emergency Function
4 pole, for Base Mounting
with Door Clutch, Padlock Device and Single Hole Mounting 22 mm**

Version	Thermal Current I_U/I_{th}	Ratings AC-23A, AC-23B Breaking Capacity 3 x 380 V/440 V	Main Switches Handle black	EAN-Code 9004257	Main Switches with Emergency Function Handle red Contrasting yellow plate	EAN-Code 9004257
IP 66 48 x 48 	16 A 20 A 25 A 32 A 40 A 63 A	7,5 kW / 160 A 10 kW / 200 A 12 kW / 250 A 11 kW / 220 A 15 kW / 300 A 22 kW / 350 A	KH16 T104/68 VE KH20 T104/68 VE KH25 T104/68 VE KG32A T104/68 VE KG41 T104/68 VE KG64 T104/68 VE	07127 2 07128 9 07129 6 01182 7 01184 1 01186 5	KH16 T204/68 VE KH20 T204/68 VE KH25 T204/68 VE KG32A T204/68 VE KG41 T204/68 VE KG64 T204/68 VE	07130 2 07131 9 07132 6 01194 0 01196 4 01198 8
64 x 64 	16 A 20 A 25 A 32 A 40 A 63 A 80 A 100 A	7,5 kW / 160 A 10 kW / 200 A 12 kW / 250 A 16 kW / 300 A 20 kW / 380 A 30 kW / 500 A 40 kW / 630 A 37 kW / 650 A	KH16B T104/68 VE KH20B T104/68 VE KH25B T104/68 VE KH32 T104/68 VE KH40 T104/68 VE KH63 T104/68 VE KH80 T104/68 VE KG100 T104/68 VE	07133 3 07134 0 07135 7 06518 9 06520 2 07498 3 07500 3 01189 6	KH16B T204/68 VE KH20B T204/68 VE KH25B T204/68 VE KH32 T204/68 VE KH40 T204/68 VE KH63 T204/68 VE KH80 T204/68 VE KG100 T204/68 VE	07136 4 07137 1 07138 8 06519 6 06521 9 07499 0 07501 0 01201 5
IP 66 64 x 64  <p>Misalignment between the shaft and operator is compensated for by a centering device.</p>	16 A 20 A 25 A 32 A 40 A 63 A 80 A 100 A	7,5 kW / 160 A 10 kW / 200 A 12 kW / 250 A 16 kW / 300 A 20 kW / 380 A 30 kW / 500 A 40 kW / 630 A 37 kW / 650 A	KH16B T104/93 VE KH20B T104/93 VE KH25B T104/93 VE KH32 T104/93 VE KH40 T104/93 VE KH63 T104/93 VE KH80 T104/93 VE KG100 T104/93 VE	07139 5 07140 1 07141 8 06522 6 06524 0 07502 7 07504 1 06381 9	KH16B T204/93 VE KH20B T204/93 VE KH25B T204/93 VE KH32 T204/93 VE KH40 T204/93 VE KH63 T204/93 VE KH80 T204/93 VE KG100 T204/93 VE	07142 5 07143 2 07144 9 06523 3 06525 7 07503 4 07505 8 06388 8
IP 66 64 x 64  <p>Misalignment between the shaft and operator is compensated for by a centering device.</p>	16 A 20 A 25 A 32 A 40 A 63 A 80 A 100 A	7,5 kW / 160 A 10 kW / 200 A 12 kW / 250 A 16 kW / 300 A 20 kW / 380 A 30 kW / 500 A 40 kW / 630 A 37 kW / 650 A	KH16B T104/94 VE KH20B T104/94 VE KH25B T104/94 VE KH32 T104/94 VE KH40 T104/94 VE KH63 T104/94 VE KH80 T104/94 VE KG100 T104/94 VE	07145 6 07146 3 07147 0 06526 4 06528 8 07506 5 07508 9 06395 6	KH16B T204/94 VE KH20B T204/94 VE KH25B T204/94 VE KH32 T204/94 VE KH40 T204/94 VE KH63 T204/94 VE KH80 T204/94 VE KG100 T204/94 VE	07148 7 07149 4 07150 0 06527 1 06529 5 07507 2 07509 6 06402 1

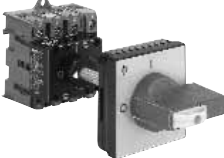
Main Switches and Main Switches with Emergency Function 4 pole, for Base Mounting with Door Clutch

Version	Thermal Current I_u/I_{th}	Ratings AC-23A, AC-23B Breaking Capacity 3 x 380 V/440 V	Main Switches		EAN-Code 9004257	Main Switches with Emergency Function		EAN-Code 9004257	
Protection Escutcheon plate in mm			Handle black			Handle red Contrasting yellow plate			
IP 66/67 64 x 64 	16 A	7,5 kW / 160 A	KH16B	T104/09 VE	07151 7	KH16B	T204/09 VE	07154 8	
	20 A	10 kW / 200 A	KH20B	T104/09 VE	07152 4	KH20B	T204/09 VE	07155 5	
	25 A	12 kW / 250 A	KH25B	T104/09 VE	07153 1	KH25B	T204/09 VE	07156 2	
	32 A	16 kW / 300 A	KH32	T104/09 VE	06530 1	KH32	T204/09 VE	06531 8	
	40 A	20 kW / 380 A	KH40	T104/09 VE	06532 5	KH40	T204/09 VE	06533 2	
	63 A	30 kW / 500 A	KH63	T104/09 VE	07510 2	KH63	T204/09 VE	07511 9	
	80 A	40 kW / 630 A	KH80	T104/09 VE	07512 6	KH80	T204/09 VE	07513 3	
	100 A	37 kW / 650 A	KG100	T104/09 VE	00278 8	KG100	T204/09 VE	00292 4	
	88 x 88	125 A	45 kW / 750 A	KG125	T104/09 VE	00280 1	KG125	T204/09 VE	00294 8
		160 A	55 kW / 850 A	KG160	T104/09 VE	00281 8	KG160	T204/09 VE	00295 5
	IP 66/67 48 x 48 64 x 64 	16 A	7,5 kW / 160 A	KH16	T104/65 VE	07157 9	KH16	T204/65 VE	07160 9
		20 A	10 kW / 200 A	KH20	T104/65 VE	07158 6	KH20	T204/65 VE	07161 6
		25 A	12 kW / 250 A	KH25	T104/65 VE	07159 3	KH25	T204/65 VE	07162 3
		64 x 64	16 A	7,5 kW / 160 A	KH16B	T104/65 VE	07163 0	KH16B	T204/65 VE
20 A			10 kW / 200 A	KH20B	T104/65 VE	07164 7	KH20B	T204/65 VE	07167 8
25 A			12 kW / 250 A	KH25B	T104/65 VE	07165 4	KH25B	T204/65 VE	07168 5
32 A			16 kW / 300 A	KH32	T104/65 VE	06534 9	KH32	T204/65 VE	06535 6
40 A			20 kW / 380 A	KH40	T104/65 VE	06536 3	KH40	T204/65 VE	06537 0
63 A			30 kW / 500 A	KH63	T104/65 VE	07514 0	KH63	T204/65 VE	07515 7
80 A			40 kW / 630 A	KH80	T104/65 VE	07516 4	KH80	T204/65 VE	07517 1
88 x 88		100 A	37 kW / 650 A	KG100	T104/65 VE	01165 0	KG100	T204/65 VE	01177 3
		125 A	45 kW / 750 A	KG125	T104/65 VE	03174 0	KG125	T204/65 VE	03178 8
		160 A	55 kW / 850 A	KG160	T104/65 VE	03175 7	KG160	T204/65 VE	03179 5
		250 A	90 kW / 1380 A	KG250	T104/83 VE	03198 6	KG250	T204/83 VE	03200 6
	315 A	110 kW / 1650 A	KG315	T104/83 VE	03199 3	KG315	T204/83 VE	03201 3	
IP 66 88 x 88 	25 A	7,5 kW / 180 A	KG20B	T104/12 VE	00307 5	KG20B	T204/12 VE	00337 2	
	32 A	16 kW / 300 A	KH32	T104/12 VE	06538 7	KH32	T204/12 VE	06539 4	
	40 A	20 kW / 380 A	KH40	T104/12 VE	06540 0	KH40	T204/12 VE	06541 7	
	63 A	30 kW / 500 A	KH63	T104/12 VE	07518 8	KH63	T204/12 VE	07519 5	
	80 A	40 kW / 630 A	KH80	T104/12 VE	07520 1	KH80	T204/12 VE	07521 8	
	100 A	37 kW / 650 A	KG100	T104/12 VE	00312 9	KG100	T204/12 VE	00342 6	
	125 A	45 kW / 750 A	KG125	T104/12 VE	00314 3	KG125	T204/12 VE	00344 0	
	160 A	55 kW / 850 A	KG160	T104/12 VE	00315 0	KG160	T204/12 VE	00345 7	
	200 A	75 kW / 1100 A	KG210	T104/13 VE	07522 5	KG210	T204/13 VE	07523 2	
	250 A	90 kW / 1380 A	KG250	T104/13 VE	00317 4	KG250	T204/13 VE	00347 1	
	315 A	110 kW / 1650 A	KG315	T104/13 VE	00318 1	KG315	T204/13 VE	00348 8	
	315 A	132 kW / 2000 A	C316	T104/13 VE	00319 8	C316	T204/13 VE	00349 5	

Using the device the electrical panel may be opened only when the switch is in the OFF position and no padlock is fitted.
Note: Only in the ON position can knowledgeable personnel using a simple tool to defeat the interlock. The M700's flexibility allows for successful installation with as much as + or - 5 mm of misalignment between the shaft and door.

Main Switches and Main Switches with Emergency Function
3 pole + Ground and Neutral Terminal,
for Four Hole Panel Mounting

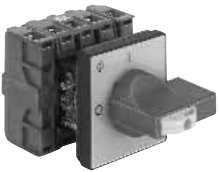
Version	Thermal Current I_U/I_{th}	Ratings AC-23A, AC-23B Breaking Capacity 3 x 380 V/440 V	Main Switches Handle black	EAN-Code 9004257	Main Switches with Emergency Function Handle red Contrasting yellow plate	EAN-Code 9004257
IP 66 64 x 64 	25 A 32 A 40 A 63 A 80 A 100 A	7,5 kW / 180 A 11 kW / 220 A 15 kW / 300 A 22 kW / 350 A 30 kW / 560 A 37 kW / 650 A	KG20B T105/01 E KG32B T105/01 E KG41B T105/01 E KG64B T105/01 E KG80 T105/01 E KG100 T105/01 E	01396 8 01397 5 01398 2 01399 9 01400 2 01402 6	KG20B T205/01 E KG32B T205/01 E KG41B T205/01 E KG64B T205/01 E KG80 T205/01 E KG100 T205/01 E	01407 1 01408 8 01409 5 01410 1 01411 8 01413 2
88 x 88	80 A 100 A 125 A 160 A	30 kW / 560 A 37 kW / 650 A 45 kW / 750 A 55 kW / 850 A	KG80C T105/01 E KG100C T105/01 E KG125 T105/01 E KG160 T105/01 E	01401 9 01403 3 01404 0 01405 7	KG80C T205/01 E KG100C T205/01 E KG125 T205/01 E KG160 T205/01 E	01412 5 01414 9 01415 6 01416 3
IP 66 ¹ 48 x 48	25 A 32 A 40 A 63 A	7,5 kW / 180 A 11 kW / 220 A 15 kW / 300 A 22 kW / 350 A	KG20A T105/04 E KG32A T105/04 E KG41 T105/04 E KG64 T105/04 E	01418 7 01419 4 01420 0 01421 7	KG20A T205/04 E KG32A T205/04 E KG41 T205/04 E KG64 T205/04 E	01434 7 01435 4 01436 1 01437 8
64 x 64 	25 A 32 A 40 A 63 A 80 A 100 A	7,5 kW / 180 A 11 kW / 220 A 15 kW / 300 A 22 kW / 350 A 30 kW / 560 A 37 kW / 650 A	KG20B T105/04 E KG32B T105/04 E KG41B T105/04 E KG64B T105/04 E KG80 T105/04 E KG100 T105/04 E	01423 1 01424 8 01425 5 01426 2 01427 9 01428 6	KG20B T205/04 E KG32B T205/04 E KG41B T205/04 E KG64B T205/04 E KG80 T205/04 E KG100 T205/04 E	01439 2 01440 8 01441 5 01442 2 01443 9 01444 6
88 x 88	80 A 100 A 125 A 160 A 200 A 250 A 315 A	30 kW / 560 A 37 kW / 650 A 45 kW / 750 A 55 kW / 850 A 75 kW / 1100 A 90 kW / 1380 A 110 kW / 1650 A	KG80C T105/04 E KG100C T105/04 E KG125 T105/04 E KG160 T105/04 E KG210 T105/05 E KG250 T105/05 E KG315 T105/05 E	01429 3 01430 9 01431 6 01432 3 07524 9 01449 1 01450 7	KG80C T205/04 E KG100C T205/04 E KG125 T205/04 E KG160 T205/04 E KG210 T205/05 E KG250 T205/05 E KG315 T205/05 E	01445 3 01446 0 01447 7 01448 4 07525 6 01451 4 01452 1

¹C316 protection IP 40. Higher protection available on request.

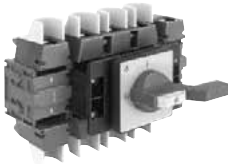

Main Switches and Main Switches with Emergency Function
3 pole + Ground and Neutral Terminal,
for Four Hole Panel Mounting

Version	Thermal Current I_u/I_{th}	Ratings AC-23A, AC-23B Breaking Capacity 3 x 380 V/440 V	Main Switches	EAN-Code 9004257	Main Switches with Emergency Function	EAN-Code 9004257
Protection Escutcheon plate in mm			Handle black		Handle red Contrasting yellow plate	
IP 66 88 x 88	250 A 315 A	90 kW / 1380 A 110 kW/ 1650 A	KG250 T105/66 E KG315 T105/66 E	01584 9 01585 6	KG250 T205/66 E KG315 T205/66 E	01586 3 01587 0
						

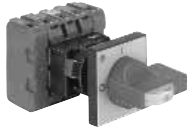

Main Switches and Main Switches with Emergency Function
3 pole + Ground and Neutral Terminal,
for Single Hole Mounting 22 mm

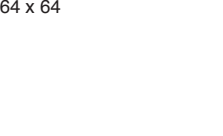
Version	Thermal Current I_u/I_{th}	Ratings AC-23A, AC-23B Breaking Capacity 3 x 380 V/440 V	Main Switches	EAN-Code 9004257	Main Switches with Emergency Function	EAN-Code 9004257
Protection Escutcheon plate in mm			Handle black		Handle red Contrasting yellow plate	
IP 66 64 x 64	25 A 32 A	7,5 kW / 180 A 11 kW / 220 A	KG20B T105/01 FT2 KG32B T105/01 FT2	01454 5 01455 2	KG20B T205/01 FT2 KG32B T205/01 FT2	01457 6 01458 3
						
IP 66 48 x 48	25 A 32 A	7,5 kW / 180 A 11 kW / 220 A	KG20A T105/04 FT2 KG32A T105/04 FT2	01460 6 01461 3	KG20A T205/04 FT2 KG32A T205/04 FT2	01463 7 01464 4
						
64 x 64	25 A 32 A	7,5 kW / 180 A 11 kW / 220 A	KG20B T105/04 FT2 KG32B T105/04 FT2	01601 3 01603 7	KG20B T205/04 FT2 KG32B T205/04 FT2	01602 0 01604 4

Main Switches and Main Switches with Emergency Function
3 pole + Ground and Neutral Terminal, for Base Mounting
with Door Clutch, Padlock Device and Single Hole Mounting 22 mm

Version	Thermal Current I_U/I_{th}	Ratings AC-23A, AC-23B Breaking Capacity 3 x 380 V/440 V	Main Switches Handle black	EAN-Code 9004257	Main Switches with Emergency Function Handle red Contrasting yellow plate	EAN-Code 9004257
IP 66 48 x 48 	25 A 32 A 40 A 63 A	7,5 kW / 180 A 11 kW / 220 A 15 kW / 300 A 22 kW / 350 A	KG20A T105/68 VE KG32A T105/68 VE KG41 T105/68 VE KG64 T105/68 VE	01524 5 01525 2 01526 9 01527 6	KG20A T205/68 VE KG32A T205/68 VE KG41 T205/68 VE KG64 T205/68 VE	01529 0 01530 6 01531 3 01532 0
64 x 64 	25 A 32 A 40 A 63 A 80 A 100 A	7,5 kW / 180 A 11 kW / 220 A 15 kW / 300 A 22 kW / 350 A 30 kW / 560 A 37 kW / 650 A	KG20B T105/68 VE KG32B T105/68 VE KG41B T105/68 VE KG64B T105/68 VE KG80 T105/68 VE KG100 T105/68 VE	01607 5 01609 9 01611 2 01613 6 01615 0 01617 4	KG20B T205/68 VE KG32B T205/68 VE KG41B T205/68 VE KG64B T205/68 VE KG80 T205/68 VE KG100 T205/68 VE	01608 2 01610 5 01612 9 01614 3 01616 7 01618 1
IP 66 64 x 64  Misalignment between the shaft and operator is compensated for by a centering device.	25 A 32 A 40 A 63 A 80 A 100 A	7,5 kW / 180 A 11 kW / 220 A 15 kW / 300 A 22 kW / 350 A 30 kW / 560 A 37 kW / 650 A	KG20B T105/93 VE KG32B T105/93 VE KG41B T105/93 VE KG64B T105/93 VE KG80 T105/93 VE KG100 T105/93 VE	06403 8 06404 5 06405 2 06406 9 06407 6 06408 3	KG20B T205/93 VE KG32B T205/93 VE KG41B T205/93 VE KG64B T205/93 VE KG80 T205/93 VE KG100 T205/93 VE	06409 0 06410 6 06411 3 06412 0 06413 7 06414 4
IP 66 64 x 64  Misalignment between the shaft and operator is compensated for by a centering device.	25 A 32 A 40 A 63 A 80 A 100 A	7,5 kW / 180 A 11 kW / 220 A 15 kW / 300 A 22 kW / 350 A 30 kW / 560 A 37 kW / 650 A	KG20B T105/94 VE KG32B T105/94 VE KG41B T105/94 VE KG64B T105/94 VE KG80 T105/94 VE KG100 T105/94 VE	06415 1 06416 8 06417 5 06418 2 06419 9 06420 5	KG20B T205/94 VE KG32B T205/94 VE KG41B T205/94 VE KG64B T205/94 VE KG80 T205/94 VE KG100 T205/94 VE	06421 2 06422 9 06423 6 06424 3 06425 0 06426 7

Main Switches and Main Switches with Emergency Function 3 pole + Ground and Neutral Terminal, for Base Mounting with Door Clutch

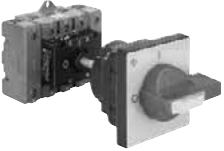
Version	Thermal Current I_u/I_{th}	Ratings AC-23A, AC-23B Breaking Capacity 3 x 380 V/440 V	Main Switches Handle black	EAN-Code 9004257	Main Switches with Emergency Function Handle red Contrasting yellow plate	EAN-Code 9004257
IP 66/67 64 x 64 	25 A 32 A 40 A 63 A 80 A 100 A	7,5 kW / 180 A 11 kW / 220 A 15 kW / 300 A 22 kW / 350 A 30 kW / 560 A 37 kW / 650 A	KG20B T105/09 VE KG32B T105/09 VE KG41B T105/09 VE KG64B T105/09 VE KG80 T105/09 VE KG100 T105/09 VE	01466 8 01467 5 01468 2 01469 9 01470 5 01471 2	KG20B T205/09 VE KG32B T205/09 VE KG41B T205/09 VE KG64B T205/09 VE KG80 T205/09 VE KG100 T205/09 VE	01475 0 01476 7 01477 4 01478 1 01479 8 01480 4
88 x 88	125 A 160 A	45 kW / 750 A 55 kW / 850 A	KG125 T105/09 VE KG160 T105/09 VE	01472 9 01473 6	KG125 T205/09 VE KG160 T205/09 VE	01481 1 01482 8
IP 66/67 48 x 48 	25 A 32 A	7,5 kW / 180 A 11 kW / 220 A	KG20A T105/65 VE KG32A T105/65 VE	01485 9 01487 3	KG20A T205/65 VE KG32A T205/65 VE	01497 2 01499 6
64 x 64 	25 A 32 A 40 A 63 A 80 A 100 A	7,5 kW / 180 A 11 kW / 220 A 15 kW / 300 A 22 kW / 350 A 30 kW / 560 A 37 kW / 650 A	KG20B T105/65 VE KG32B T105/65 VE KG41B T105/65 VE KG64B T105/65 VE KG80 T105/65 VE KG100 T105/65 VE	01486 6 01488 0 01410 3 01492 7 01493 4 01494 1	KG20B T205/65 VE KG32B T205/65 VE KG41B T205/65 VE KG64B T205/65 VE KG80 T205/65 VE KG100 T205/65 VE	01498 9 01500 9 01502 3 01504 7 01505 4 01506 1
IP 66 88 x 88  <p>Using the device the electrical panel may be opened only when the switch is in the OFF position and no padlock is fitted. Note: Only in the ON position can knowledgeable personnel using a simple tool to defeat the interlock. The M700's flexibility allows for successful installation with as much as + or - 5 mm of misalignment between the shaft and door.</p>	25 A 32 A 40 A 63 A 80 A 100 A 125 A 160 A 200 A 250 A 315 A	7,5 kW / 180 A 11 kW / 220 A 15 kW / 300 A 22 kW / 350 A 30 kW / 560 A 37 kW / 650 A 45 kW / 750 A 55 kW / 850 A 75 kW / 1100 A 90 kW / 1380 A 110 kW / 1650 A	KG20B T105/12 VE KG32B T105/12 VE KG41B T105/12 VE KG64B T105/12 VE KG80 T105/12 VE KG100 T105/12 VE KG125 T105/12 VE KG160 T105/12 VE KG210 T105/13 VE KG250 T105/13 VE KG315 T105/13 VE	01619 8 01621 1 01507 8 01508 5 01509 2 01510 8 01511 5 01512 2 07526 3 01513 9 01514 6	KG20B T205/12 VE KG32B T205/12 VE KG41B T205/12 VE KG64B T205/12 VE KG80 T205/12 VE KG100 T205/12 VE KG125 T205/12 VE KG160 T205/12 VE KG210 T205/13 VE KG250 T205/13 VE KG315 T205/13 VE	01620 4 01622 8 01515 3 01516 0 01517 7 01518 4 01519 1 01520 7 07527 0 01521 4 01522 1

Main Switches and Main Switches with Emergency Function
3 pole + 1 cam- or rack-operated auxiliary contact (NO),
for Four Hole Panel Mounting

Auxiliary contacts with special contact systems allow for use in low voltage and current applications as well as aggressive environments.

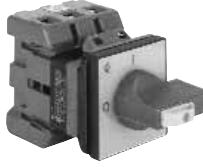
Version	Thermal Current I_U/I_{th}	Ratings AC-23A, AC-23B Breaking Capacity 3 x 380 V/440 V	Main Switches Handle black	EAN-Code 9004257	Main Switches with Emergency Function Handle red Contrasting yellow plate	EAN-Code 9004257
IP 66 64 x 64 	20 A	5,5 kW / 120 A	KG10B T103/17 E	01045 5	KG10B T203/17 E	01050 9
	25 A	7,5 kW / 180 A	KG20B T103/17 E	00361 7	KG20B T203/17 E	00401 0
	32 A	11 kW / 220 A	KG32B T103/17 E	00362 4	KG32B T203/17 E	00402 7
	40 A	15 kW / 300 A	KG41B T103/17 E	00363 1	KG41B T203/17 E	00403 4
	63 A	22 kW / 350 A	KG64B T103/17 E	00364 8	KG64B T203/17 E	00404 1
	80 A	30 kW / 560 A	KG80 T103/17 E	00365 5	KG80 T203/17 E	00405 8
	100 A	37 kW / 650 A	KG100 T103/17 E	00366 2	KG100 T203/17 E	00406 5
88 x 88	80 A	30 kW / 560 A	KG80C T103/17 E	01387 6	KG80C T203/17 E	01393 7
	100 A	37 kW / 650 A	KG100C T103/17 E	01388 3	KG100C T203/17 E	01394 4
	125 A	45 kW / 750 A	KG125 T103/17 E	00368 6	KG125 T203/17 E	00408 9
	160 A	55 kW / 850 A	KG160 T103/17 E	00369 3	KG160 T203/17 E	00409 6
IP 66 ¹ 48 x 48	20 A	5,5 kW / 120 A	KG10A T103/20 E	01202 2	KG10A T203/20 E	01214 5
	25 A	7,5 kW / 180 A	KG20A T103/20 E	01204 6	KG20A T203/20 E	01216 9
	32 A	11 kW / 220 A	KG32A T103/20 E	01206 0	KG32A T203/20 E	01218 3
64 x 64 	20 A	5,5 kW / 120 A	KG10B T103/20 E	01203 9	KG10B T203/20 E	01215 2
	25 A	7,5 kW / 180 A	KG20B T103/20 E	01205 3	KG20B T203/20 E	01217 6
	32 A	11 kW / 220 A	KG32B T103/20 E	01207 7	KG32B T203/20 E	01219 0
	40 A	15 kW / 300 A	KG41B T103/20 E	01209 1	KG41B T203/20 E	01221 3
	63 A	22 kW / 350 A	KG64B T103/20 E	01211 4	KG64B T203/20 E	01223 7
	80 A	30 kW / 560 A	KG80 T103/20 E	01212 1	KG80 T203/20 E	01224 4
	100 A	37 kW / 650 A	KG100 T103/20 E	01213 8	KG100 T203/20 E	01225 1
88 x 88	80 A	30 kW / 560 A	KG80C T103/20 E	00379 2	KG80C T203/20 E	00419 5
	100 A	37 kW / 650 A	KG100C T103/20 E	00380 8	KG100C T203/20 E	00420 1
	125 A	45 kW / 750 A	KG125 T103/20 E	00382 2	KG125 T203/20 E	00422 5
	160 A	55 kW / 850 A	KG160 T103/20 E	00383 9	KG160 T203/20 E	00423 2
	200 A	75 kW / 1100 A	KG210 T103/21 E	07528 7	KG210 T203/21 E	07529 4
	250 A	90 kW / 1380 A	KG250 T103/21 E	00385 3	KG250 T203/21 E	00425 6
315 A	110 kW / 1650 A	KG315 T103/21 E	00386 0	KG315 T203/21 E	00426 3	
130 x 130	315 A	132 kW / 2000 A	C316 T103/21 E	00387 7	C316 T203/21 E	00427 0

¹C316 protection IP 40. Higher protection available on request.

Main Switches and Main Switches with Emergency Function
3 pole + 1 cam- or rack-operated auxiliary contact (NO),
for Four Hole Panel Mounting

Auxiliary contacts with special contact systems allow for use in low voltage and current applications as well aggressive environments.

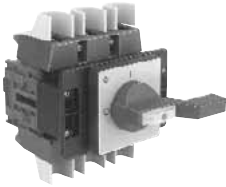
Version	Thermal Current I_u/I_{th}	Ratings AC-23A, AC-23B Breaking Capacity 3 x 380 V/440 V	Main Switches	EAN-Code 9004257	Main Switches with Emergency Function	EAN-Code 9004257
Protection Escutcheon plate in mm			Handle black		Handle red Contrasting yellow plate	
IP 66 88 x 88	250 A 315 A	90 kW / 1380 A 110 kW / 1650 A	KG250 T103/70 E KG315 T103/70 E	01226 8 01227 5	KG250 T203/70 E KG315 T203/70 E	01228 2 01229 9
						



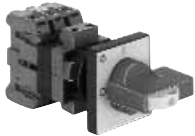
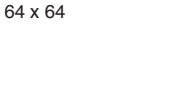

Main Switches and Main Switches with Emergency Function
3 pole + 1 cam-operated auxiliary contact (NO),
for Single Hole Mounting 22 mm

Auxiliary contacts with special contact systems allow for use in low voltage and current applications as well aggressive environments.

Version	Thermal Current I_u/I_{th}	Ratings AC-23A, AC-23B Breaking Capacity 3 x 380 V/440 V	Main Switches	EAN-Code 9004257	Main Switches with Emergency Function	EAN-Code 9004257
Protection Escutcheon plate in mm			Handle black		Handle red Contrasting yellow plate	
IP 66 64 x 64	20 A 25 A 32 A	5,5 kW / 120 A 7,5 kW / 180 A 11 kW / 220 A	KG10B T103/17 FT2 KG20B T103/17 FT2 KG32B T103/17 FT2	01302 9 00441 6 00442 3	KG10B T203/17 FT2 KG20B T203/17 FT2 KG32B T203/17 FT2	01303 6 00445 4 00446 1
						
IP 66 48 x 48	20 A 25 A 32 A	5,5 kW / 120 A 7,5 kW / 180 A 11 kW / 220 A	KG10A T103/20 FT2 KG20A T103/20 FT2 KG32A T103/20 FT2	01304 3 01306 7 01308 1	KG10A T203/20 FT2 KG20A T203/20 FT2 KG32A T203/20 FT2	01310 4 01312 8 01314 2
						
64 x 64	20 A 25 A 32 A	5,5 kW / 120 A 7,5 kW / 180 A 11 kW / 220 A	KG10B T103/20 FT2 KG20B T103/20 FT2 KG32B T103/20 FT2	01305 0 01307 4 01309 8	KG10B T203/20 FT2 KG20B T203/20 FT2 KG32B T203/20 FT2	01311 1 01313 5 01315 9
						

Main Switches and Main Switches with Emergency Function
3 pole + 1 cam-operated auxiliary contact (NO), for Base Mounting
with Door Clutch, Padlock Device and Single Hole Mounting 22 mm

Auxiliary contacts with special contact systems allow for use in low voltage and current applications as well aggressive environments.

Version	Thermal Current I_U/I_{th}	Ratings AC-23A, AC-23B Breaking Capacity 3 x 380 V/440 V	Main Switches	EAN-Code 9004257	Main Switches with Emergency Function	EAN-Code 9004257
Protection Escutcheon plate in mm IP 66 48 x 48 	20 A 25 A 32 A 40 A 63 A	5,5 kW / 120 A 7,5 kW / 180 A 11 kW / 220 A 15 kW / 300 A 22 kW / 350 A	Handle black KG10A T103/72 VE KG20A T103/72 VE KG32A T103/72 VE KG41 T103/72 VE KG64 T103/72 VE	01342 5 01344 9 01346 3 01348 7 01350 0	Handle red Contrasting yellow plate KG10A T203/72 VE KG20A T203/72 VE KG32A T203/72 VE KG41 T203/72 VE KG64 T203/72 VE	01354 8 01356 2 01358 6 01360 9 01362 3
64 x 64 	20 A 25 A 32 A 40 A 63 A 80 A 100 A	5,5 kW / 120 A 7,5 kW / 180 A 11 kW / 220 A 15 kW / 300 A 22 kW / 350 A 30 kW / 560 A 37 kW / 650 A	KG10B T103/72 VE KG20B T103/72 VE KG32B T103/72 VE KG41B T103/72 VE KG64B T103/72 VE KG80 T103/72 VE KG100 T103/72 VE	01343 2 01345 6 01347 0 01349 4 01351 7 01352 4 01353 1	KG10B T203/72 VE KG20B T203/72 VE KG32B T203/72 VE KG41B T203/72 VE KG64B T203/72 VE KG80 T203/72 VE KG100 T203/72 VE	01355 5 01357 9 01359 3 01361 6 01363 0 01364 7 01365 4
IP 66 64 x 64  <p>Misalignment between the shaft and operator is compensated for by a centering device.</p>	20 A 25 A 32 A 40 A 63 A 80 A 100 A	5,5 kW / 120 A 7,5 kW / 180 A 11 kW / 220 A 15 kW / 300 A 22 kW / 350 A 30 kW / 560 A 37 kW / 650 A	KG10B T103/95 VE KG20B T103/95 VE KG32B T103/95 VE KG41B T103/95 VE KG64B T103/95 VE KG80 T103/95 VE KG100 T103/95 VE	06427 4 06428 1 06429 8 06430 4 06431 1 06432 8 06433 5	KG10B T203/95 VE KG20B T203/95 VE KG32B T203/95 VE KG41B T203/95 VE KG64B T203/95 VE KG80 T203/95 VE KG100 T203/95 VE	06434 2 06435 9 06436 6 06437 3 06438 0 06439 7 06440 3
IP 66 64 x 64  <p>Misalignment between the shaft and operator is compensated for by a centering device.</p>	20 A 25 A 32 A 40 A 63 A 80 A 100 A	5,5 kW / 120 A 7,5 kW / 180 A 11 kW / 220 A 15 kW / 300 A 22 kW / 350 A 30 kW / 560 A 37 kW / 650 A	KG10B T103/96 VE KG20B T103/96 VE KG32B T103/96 VE KG41B T103/96 VE KG64B T103/96 VE KG80 T103/96 VE KG100 T103/96 VE	06441 0 06442 7 06443 4 06444 1 06445 8 06446 5 06447 2	KG10B T203/96 VE KG20B T203/96 VE KG32B T203/96 VE KG41B T203/96 VE KG64B T203/96 VE KG80 T203/96 VE KG100 T203/96 VE	06448 9 06449 6 06450 2 06451 9 06452 6 06453 3 06454 0





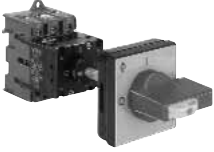
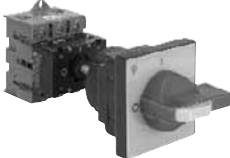











Main Switches and Main Switches with Emergency Function 3 pole + 1 cam- or rack-operated auxiliary contact (NO), for Base Mounting with Door Clutch

Auxiliary contacts with special contact systems allow for use in low voltage and current applications as well aggressive environments.

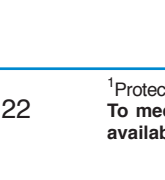
Version	Thermal Current I_u/I_{th}	Ratings AC-23A, AC-23B Breaking Capacity 3 x 380 V/440 V	Main Switches	EAN-Code 9004257	Main Switches with Emergency Function	EAN-Code 9004257	
Protection Escutcheon plate in mm			Handle black		Handle red Contrasting yellow plate		
IP 66/67 64 x 64 	20 A	5,5 kW / 120 A	KG10B T103/25 VE	01316 6	KG10B T203/25 VE	01317 3	
	25 A	7,5 kW / 180 A	KG20B T103/25 VE	00449 2	KG20B T203/25 VE	00463 8	
	32 A	11 kW / 220 A	KG32B T103/25 VE	00450 8	KG32B T203/25 VE	00464 5	
	40 A	15 kW / 300 A	KG41B T103/25 VE	00451 5	KG41B T203/25 VE	00465 2	
	63 A	22 kW / 350 A	KG64B T103/25 VE	00452 2	KG64B T203/25 VE	00466 9	
	80 A	30 kW / 560 A	KG80 T103/25 VE	00453 9	KG80 T203/25 VE	00467 6	
	100 A	37 kW / 650 A	KG100 T103/25 VE	00454 6	KG100 T203/25 VE	00468 3	
	88 x 88	125 A	45 kW / 750 A	KG125 T103/25 VE	00456 0	KG125 T203/25 VE	00470 6
		160 A	55 kW / 850 A	KG160 T103/25 VE	00457 7	KG160 T203/25 VE	00471 3
	IP 66/67 48 x 48 	20 A	5,5 kW / 120 A	KG10A T103/69 VE	01318 0	KG10A T203/69 VE	01330 2
25 A		7,5 kW / 180 A	KG20A T103/69 VE	01320 3	KG20A T203/69 VE	01332 6	
32 A		11 kW / 220 A	KG32A T103/69 VE	01322 7	KG32A T203/69 VE	01334 0	
64 x 64		20 A	5,5 kW / 120 A	KG10B T103/69 VE	01319 7	KG10B T203/69 VE	01331 9
		25 A	7,5 kW / 180 A	KG20B T103/69 VE	01321 0	KG20B T203/69 VE	01333 3
		32 A	11 kW / 220 A	KG32B T103/69 VE	01323 4	KG32B T203/69 VE	01335 7
		40 A	15 kW / 300 A	KG41B T103/69 VE	01325 8	KG41B T203/69 VE	01337 1
		63 A	22 kW / 350 A	KG64B T103/69 VE	01327 2	KG64B T203/69 VE	01339 5
		80 A	30 kW / 560 A	KG80 T103/69 VE	01328 9	KG80 T203/69 VE	01340 1
		100 A	37 kW / 650 A	KG100 T103/69 VE	01329 6	KG100 T203/69 VE	01341 8
IP 66 88 x 88  <p>Using the device the electrical panel may be opened only when the switch is in the OFF position and no padlock is fitted. Note: Only in the ON position can knowledgeable personnel using a simple tool to defeat the interlock. The M700's flexibility allows for successful installation with as much as + or - 5 mm of misalignment between the shaft and door.</p>	25 A	7,5 kW / 180 A	KG20B T103/28 VE	01625 9	KG20B T203/28 VE	00513 0	
	32 A	11 kW / 220 A	KG32B T103/28 VE	00484 3	KG32B T203/28 VE	00514 7	
	40 A	15 kW / 300 A	KG41B T103/28 VE	00485 0	KG41B T203/28 VE	00515 4	
	63 A	22 kW / 350 A	KG64B T103/28 VE	00486 7	KG64B T203/28 VE	00516 1	
	80 A	30 kW / 560 A	KG80 T103/28 VE	00487 4	KG80 T203/28 VE	00517 8	
	100 A	37 kW / 650 A	KG100 T103/28 VE	00488 1	KG100 T203/28 VE	00518 5	
	125 A	45 kW / 750 A	KG125 T103/28 VE	00490 4	KG125 T203/28 VE	00520 8	
	160 A	55 kW / 850 A	KG160 T103/28 VE	00491 1	KG160 T203/28 VE	00521 5	
	200 A	75 kW / 1100 A	KG210 T103/29 VE	07530 0	KG210 T203/29 VE	07531 7	
	250 A	90 kW / 1380 A	KG250 T103/29 VE	00493 5	KG250 T203/29 VE	00523 9	
	315 A	110 kW / 1650 A	KG315 T103/29 VE	00494 2	KG315 T203/29 VE	00524 6	
	315 A	132 kW / 2000 A	C316 T103/29 VE	00495 9	C316 T203/29 VE	00525 3	

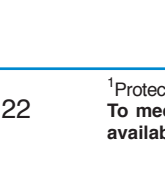
Maintenance and Safety Switches

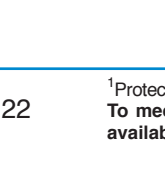
3 pole, in Plastic Enclosure (conduit entries for metric threads)















Version		Thermal Current	Ratings AC-23A, AC-23B Breaking Capacity 3 x 380 V/440 V	Main Switches Handle electro-gray 		EAN-Code	Main Switches with Emergency Function Handle red Contrasting yellow plate		EAN-Code	
Protection IP 66/67	Padlock Device	I_{the}		Handle black 		9004257			9004257	
		20 A	5,5 kW / 120 A	KG10	T103/33 KS51V	06743 5	KG10	T203/33 KS51V	06773 2	
		25 A	7,5 kW / 180 A	KG20	T103/33 KS51V	06744 2	KG20	T203/33 KS51V	06774 9	
		20 A	5,5 kW / 120 A	KG10	T103/75 KS51	06745 9	KG10	T203/75 KS51	06775 6	
		25 A	7,5 kW / 180 A	KG20	T103/75 KS51	06746 6	KG20	T203/75 KS51	06776 3	
		25 A	7,5 kW / 180 A	KG20	T103/33 KL51V	06747 3	KG20	T203/33 KL51V	06777 0	
		32 A	11 kW / 220 A	KG32	T103/33 KL51V ²	06748 0	KG32	T203/33 KL51V ²	06778 7	
		40 A	15 kW / 300 A	KG41	T103/33 KL11V	06749 7	KG41	T203/33 KL11V	06779 4	
		63 A	22 kW / 350 A	KG64	T103/33 KL11V	06750 3	KG64	T203/33 KL11V	06780 0	
		80 A	30 kW / 560 A	KG80	T103/33 KL71V	07454 9	KG80	T203/33 KL71V	07455 6	
		100 A	37 kW / 650 A	KG100	T103/33 KL71V	07456 3	KG100	T203/33 KL71V	07457 0	
				25 A	7,5 kW / 180 A	KG20	T103/75 KL51	06753 4	KG20	T203/75 KL51
32 A	11 kW / 220 A			KG32	T103/75 KL51 ²	06754 1	KG32	T203/75 KL51 ²	06784 8	
40 A	15 kW / 300 A			KG41	T103/75 KL11	06755 8	KG41	T203/75 KL11	06785 5	
63 A	22 kW / 350 A			KG64	T103/75 KL11	06756 5	KG64	T203/75 KL11	06786 2	
80 A	30 kW / 560 A			KG80	T103/75 KL71	07279 8	KG80	T203/75 KL71	07281 1	
100 A	37 kW / 650 A			KG100	T103/75 KL71	07280 4	KG100	T203/75 KL71	07282 8	
				125 A	45 kW / 750 A	KG125	T103/34 STM ¹	06759 6	KG125	T203/34 STM ¹
		160 A	55 kW / 850 A	KG160	T103/34 STM ¹	06760 2	KG160	T203/34 STM ¹	06790 9	
		125 A	45 kW / 750 A	KG125	T103/76 STM ¹	06761 9	KG125	T203/76 STM ¹	06791 6	
		160 A	55 kW / 850 A	KG160	T103/76 STM ¹	06762 6	KG160	T203/76 STM ¹	06792 3	
		250 A	90 kW / 1380 A	KG250	T103/36 STM	06763 3	KG250	T203/36 STM	06793 0	
		315 A	110 kW / 1650 A	KG315	T103/36 STM ³	06764 0	KG315	T203/36 STM ³	06794 7	
		315 A	132 kW / 2000 A	C316	T103/37 STM ³	06765 7	C316	T203/37 STM ³	06795 4	
				Oversized Wiring Space				Oversized Wiring Space		
		125 A	45 kW / 750 A	KG125	T103/38 STM	06766 4	KG125	T203/38 STM	06796 1	
		160 A	55 kW / 850 A	KG160	T103/38 STM	06767 1	KG160	T203/38 STM	06797 8	
		125 A	45 kW / 750 A	KG125	T103/36 STM	06768 8	KG125	T203/36 STM	06798 5	
		160 A	55 kW / 850 A	KG160	T103/36 STM	06769 5	KG160	T203/36 STM	06799 2	
		250 A	90 kW / 1380 A	KG250	T103/39 STM ³	06770 1	KG250	T203/39 STM ³	06800 5	
		315 A	110 kW / 1650 A	KG315	T103/39 STM ³	06771 8	KG315	T203/39 STM ³	06801 2	
		315 A	132 kW / 2000 A	C316	T103/39 STM ³	06772 5	C316	T203/39 STM ³	06802 9	

¹Protection IP 65. ²For conduit entries M25 in place of M20 the ordering data changes from KL51V to KL11V and from KL51 to KL11. ³Switches with cable glands. To meet the conditions of EMC (Electro Magnetic Compatibility) for connection of frequency regulated motors, maintenance switches are available with shield clips. These clips are used to continue the cable shield circuit through the enclosure.

Maintenance and Safety Switches

**3 pole + 2 cam- or rack-operated auxiliary contacts (1 NO, 1 NC),
in Plastic Enclosure (conduit entries for metric threads)**



















Auxiliary contacts with special contact systems allow for use in low voltage and current applications as well aggressive environments.

Version		Thermal Current	Ratings AC-23A, AC-23B Breaking Capacity 3 x 380 V/440 V	Main Switches Handle electro-gray  Handle black  		EAN-Code	Main Switches with Emergency Function Handle red Contrasting yellow plate		EAN-Code
Protection IP 66/67	Padlock Device	I_{the}				9004257			9004257
		20 A	5,5 kW / 120 A	KG10	T103/40 KS51V	06803 6	KG10	T203/40 KS51V	06804 3
		20 A	5,5 kW / 120 A	KG10	T103/78 KS51	06805 0	KG10	T203/78 KS51	06806 7
		25 A	7,5 kW / 180 A	KG20	T103/40 KL51V	06807 4	KG20	T203/40 KL51V	06808 1
		32 A	11 kW / 220 A	KG32	T103/40 KL51V ²	06809 8	KG32	T203/40 KL51V ²	06810 4
		40 A	15 kW / 300 A	KG41	T103/40 KL11V	06811 1	KG41	T203/40 KL11V	06812 8
		63 A	22 kW / 350 A	KG64	T103/40 KL11V	06813 5	KG64	T203/40 KL11V	06814 2
		80 A	30 kW / 560 A	KG80	T103/40 KL71V	07458 7	KG80	T203/40 KL71V	07459 4
		100 A	37 kW / 650 A	KG100	T103/40 KL71V	07460 0	KG100	T203/40 KL71V	07461 7
		25 A	7,5 kW / 180 A	KG20	T103/78 KL51	06819 7	KG20	T203/78 KL51	06820 3
		32 A	11 kW / 220 A	KG32	T103/78 KL51 ²	06821 0	KG32	T203/78 KL51 ²	06822 7
		40 A	15 kW / 300 A	KG41	T103/78 KL11	06823 4	KG41	T203/78 KL11	06824 1
		63 A	22 kW / 350 A	KG64	T103/78 KL11	06825 8	KG64	T203/78 KL11	06826 5
		80 A	30 kW / 560 A	KG80	T103/78 KL71	06827 2	KG80	T203/78 KL71	06828 9
		100 A	37 kW / 650 A	KG100	T103/78 KL71	06829 6	KG100	T203/78 KL71	06830 2
		125 A	45 kW / 750 A	KG125	T103/41 STM ¹	06831 9	KG125	T203/41 STM ¹	06832 6
		160 A	55 kW / 850 A	KG160	T103/41 STM ¹	06833 3	KG160	T203/41 STM ¹	06834 0
		125 A	45 kW / 750 A	KG125	T103/79 STM ¹	06835 7	KG125	T203/79 STM ¹	06836 4
		160 A	55 kW / 850 A	KG160	T103/79 STM ¹	06837 1	KG160	T203/79 STM ¹	06838 8
		250 A	90 kW / 1380 A	KG250	T103/43 STM	06839 5	KG250	T203/43 STM	06840 1
		315 A	110 kW / 1650 A	KG315	T103/43 STM ³	06841 8	KG315	T203/43 STM ³	06842 5
		315 A	132 kW / 2000 A	C316	T103/44 STM ³	06843 2	C316	T203/44 STM ³	06844 9
				Oversized Wiring Space			Oversized Wiring Space		
		125 A	45 kW / 750 A	KG125	T103/45 STM	06845 6	KG125	T203/45 STM	06846 3
		160 A	55 kW / 850 A	KG160	T103/45 STM	06847 0	KG160	T203/45 STM	06848 7
		125 A	45 kW / 750 A	KG125	T103/43 STM	06849 4	KG125	T203/43 STM	06850 0
		160 A	55 kW / 850 A	KG160	T103/43 STM	06851 7	KG160	T203/43 STM	06852 4
		250 A	90 kW / 1380 A	KG250	T103/46 STM ³	06853 1	KG250	T203/46 STM ³	06854 8
		315 A	110 kW / 1650 A	KG315	T103/46 STM ³	06855 5	KG315	T203/46 STM ³	06856 2
315 A	132 kW / 2000 A	C316	T103/46 STM ³	06857 9	C316	T203/46 STM ³	06858 6		

¹Protection IP 65. ²For conduit entries M25 in place of M20 the ordering data changes from KL51V to KL11V and from KL51 to KL11. ³Switches with cable glands. To meet the conditions of EMC (Electro Magnetic Compatibility) for connection of frequency regulated motors, maintenance switches are available with shield clips. These clips are used to continue the cable shield circuit through the enclosure.

Maintenance and Safety Switches

4 pole, in Plastic Enclosure (conduit entries for metric threads)

Version	Thermal Current	Ratings AC-23A, AC-23B Breaking Capacity	Main Switches	EAN-Code	Main Switches with Emergency Function	EAN-Code			
Protection IP 66/67	Padlock Device	I_{the}	Handle electro-gray  Handle black 	9004257	Handle red Contrasting yellow plate	9004257			
		3 x 380 V/440 V							
		20 A	5,5 kW / 120 A	KG10 T104/33 KS51V	06859 3	KG10 T204/33 KS51V	06860 9		
		16 A	7,5 kW / 160 A	KH16 T104/33 KS51V	08805 8	KH16 T204/33 KS51V	08807 2		
		20 A	5,5 kW / 120 A	KG10 T104/75 KS51	06863 0	KG10 T204/75 KS51	06864 7		
		16 A	7,5 kW / 160 A	KH16 T104/75 KS51	08806 5	KH16 T204/75 KS51	08808 9		
		20 A	10 kW / 200 A	KH20 T104/33 KL11V	08809 6	KH20 T204/33 KL11V	08810 2		
		25 A	12 kW / 250 A	KH25 T104/33 KL11V	08811 9	KH25 T204/33 KL11V	08812 6		
		32 A	16 kW / 300 A	KH32 T104/33 KL11V	08813 3	KH32 T204/33 KL11V	08837 9		
		40 A	20 kW / 380 A	KH40 T104/33 KL11V	08814 0	KH40 T204/33 KL11V	08838 6		
		63 A	30 kW / 500 A	KH63 T104/33 KL71V	08815 7	KH63 T204/33 KL71V	08839 3		
		80 A	40 kW / 630 A	KH80 T104/33 KL71V	08816 4	KH80 T204/33 KL71V	08840 9		
		100 A	37 kW / 650 A	KG100 T104/33 KL71V	07464 8	KG100 T204/33 KL71V	07465 5		
				20 A	10 kW / 200 A	KH20 T104/75 KL11	08817 1	KH20 T204/75 KL11	08841 6
25 A	12 kW / 250 A			KH25 T104/75 KL11	08818 8	KH25 T204/75 KL11	08842 3		
32 A	16 kW / 300 A			KH32 T104/75 KL11	08819 5	KH32 T204/75 KL11	08843 0		
40 A	20 kW / 380 A			KH40 T104/75 KL11	08820 1	KH40 T204/75 KL11	08844 7		
63 A	30 kW / 500 A			KH63 T104/75 KL71	08861 4	KH63 T204/75 KL71	08845 4		
80 A	40 kW / 630 A			KH80 T104/75 KL71	08862 1	KH80 T204/75 KL71	08846 1		
100 A	37 kW / 650 A			KG100 T104/75 KL71	06889 0	KG100 T204/75 KL71	06890 6		
				125 A	45 kW / 750 A	KG125 T104/35 STM	06891 3	KG125 T204/35 STM	06892 0
		160 A	55 kW / 850 A	KG160 T104/35 STM	06893 7	KG160 T204/35 STM	06894 4		
		125 A	45 kW / 750 A	KG125 T104/77 STM	06895 1	KG125 T204/77 STM	06896 8		
		160 A	55 kW / 850 A	KG160 T104/77 STM	06897 5	KG160 T204/77 STM	06898 2		
		250 A	90 kW / 1380 A	KG250 T104/36 STM	06899 9	KG250 T204/36 STM	06900 2		
		315 A	110 kW / 1650 A	KG315 T104/36 STM ¹	06901 9	KG315 T204/36 STM ¹	06902 6		
		315 A	132 kW / 2000 A	C316 T104/37 STM ¹	06903 3	C316 T204/37 STM ¹	06904 0		
					Oversized Wiring Space		Oversized Wiring Space		
				125 A	45 kW / 750 A	KG125 T104/38 STM	06905 7	KG125 T204/38 STM	06906 4
				160 A	55 kW / 850 A	KG160 T104/38 STM	06907 1	KG160 T204/38 STM	06908 8
				125 A	45 kW / 750 A	KG125 T104/36 STM	06909 5	KG125 T204/36 STM	06910 1
				160 A	55 kW / 850 A	KG160 T104/36 STM	06911 8	KG160 T204/36 STM	06912 5
250 A	90 kW / 1380 A			KG250 T104/47 STM ¹	06913 2	KG250 T204/47 STM ¹	06914 9		
315 A	110 kW / 1650 A			KG315 T104/47 STM ¹	06915 6	KG315 T204/47 STM ¹	06916 3		
		315 A	132 kW / 2000 A	C316 T104/39 STM ¹	06917 0	C316 T204/39 STM ¹	06918 7		

















¹Switches with cable glands.

To meet the conditions of EMC (Electro Magnetic Compatibility) for connection of frequency regulated motors, maintenance switches are available with shield clips. These clips are used to continue the cable shield circuit through the enclosure.

Maintenance and Safety Switches

**4 pole + 2 cam- or rack-operated auxiliary contacts (1 NO, 1 NC),
in Plastic Enclosure (conduit entries for metric threads)**

















Auxiliary contacts with special contact systems allow for use in low voltage and current applications as well aggressive environments.

Version		Thermal Current	Ratings AC-23A, AC-23B Breaking Capacity 3 x 380 V/440 V	Main Switches Handle electro-gray  Handle black  		EAN-Code	Main Switches with Emergency Function Handle red Contrasting yellow plate		EAN-Code	
Protection IP 66/67	Padlock Device	I_{the}				9004257			9004257	
		20 A	5,5 kW / 120 A	KG10	T104/40 KS51V	06919 4	KG10	T204/40 KS51V	06920 0	
		16 A	7,5 kW / 160 A	KH16	T104/40 KS51V	08823 2	KH16	T204/40 KS51V	08847 8	
		20 A	5,5 kW / 120 A	KG10	T104/78 KS51	06921 7	KG10	T204/78 KS51	06922 4	
		16 A	7,5 kW / 160 A	KH16	T104/78 KS51	08824 9	KH16	T204/78 KS51	08848 5	
		20 A	10 kW / 200 A	KH20	T104/40 KL11V	08825 6	KH20	T204/40 KL11V	08849 2	
		25 A	12 kW / 250 A	KH25	T104/40 KL11V	08826 3	KH25	T204/40 KL11V	08850 8	
		32 A	16 kW / 300 A	KH32	T104/40 KL11V	08827 0	KH32	T204/40 KL11V	08851 5	
		40 A	20 kW / 380 A	KH40	T104/40 KL11V	08828 7	KH40	T204/40 KL11V	08852 2	
		63 A	30 kW / 500 A	KH63	T104/40 KL71V	08829 4	KH63	T204/40 KL71V	08853 9	
		80 A	40 kW / 630 A	KH80	T104/40 KL71V	08830 0	KH80	T204/40 KL71V	08854 6	
		100 A	37 kW / 650 A	KG100	T104/40 KL71V	07468 6	KG100	T204/40 KL71V	07469 3	
				20 A	10 kW / 200 A	KH20	T104/78 KL11	08831 7	KH20	T204/78 KL11
25 A	12 kW / 250 A			KH25	T104/78 KL11	08832 4	KH25	T204/78 KL11	08856 0	
32 A	16 kW / 300 A			KH32	T104/78 KL11	08833 1	KH32	T204/78 KL11	08857 7	
40 A	20 kW / 380 A			KH40	T104/78 KL11	08834 8	KH40	T204/78 KL11	08858 4	
63 A	30 kW / 500 A			KH63	T104/78 KL71	08835 5	KH63	T204/78 KL71	08859 1	
80 A	40 kW / 630 A			KH80	T104/78 KL71	08836 2	KH80	T204/78 KL71	08860 7	
100 A	37 kW / 650 A			KG100	T104/78 KL71	06945 3	KG100	T204/78 KL71	06946 0	
				125 A	45 kW / 750 A	KG125	T104/42 STM	06947 7	KG125	T204/42 STM
		160 A	55 kW / 850 A	KG160	T104/42 STM	06949 1	KG160	T204/42 STM	06950 7	
		125 A	45 kW / 750 A	KG125	T104/80 STM	06951 4	KG125	T204/80 STM	06952 1	
		160 A	55 kW / 850 A	KG160	T104/80 STM	06953 8	KG160	T204/80 STM	06954 5	
		250 A	90 kW / 1380 A	KG250	T104/43 STM	06955 2	KG250	T204/43 STM	06956 9	
		315 A	110 kW / 1650 A	KG315	T104/43 STM ¹	06957 6	KG315	T204/43 STM ¹	06958 3	
		315 A	132 kW / 2000 A	C316	T104/44 STM ¹	06959 0	C316	T204/44 STM ¹	06960 6	
						Oversized Wiring Space				Oversized Wiring Space
			125 A	45 kW / 750 A	KG125	T104/45 STM	06961 3	KG125	T204/45 STM	06962 0
			160 A	55 kW / 850 A	KG160	T104/45 STM	06963 7	KG160	T204/45 STM	06964 4
		125 A	45 kW / 750 A	KG125	T104/43 STM	06965 1	KG125	T204/43 STM	06966 8	
		160 A	55 kW / 850 A	KG160	T104/43 STM	06967 5	KG160	T204/43 STM	06968 2	
		250 A	90 kW / 1380 A	KG250	T104/48 STM ¹	06969 9	KG250	T204/48 STM ¹	06970 5	
		315 A	110 kW / 1650 A	KG315	T104/48 STM ¹	06971 2	KG315	T204/48 STM ¹	06972 9	
315 A	132 kW / 2000 A	C316	T104/46 STM ¹	06973 6	C316	T204/46 STM ¹	06974 3			

¹Switches with cable glands.

To meet the conditions of EMC (Electro Magnetic Compatibility) for connection of frequency regulated motors, maintenance switches are available with shield clips. These clips are used to continue the cable shield circuit through the enclosure.

Maintenance and Safety Switches 
6 pole,
in Plastic Enclosure (conduit entries for metric threads)

Version	Thermal Current	Ratings AC-23A, AC-23B Breaking Capacity	Main Switches	EAN-Code	Main Switches with Emergency Function	EAN-Code	
Protection IP 66/67	Padlock Device	I_{the}	Handle electro-gray Handle black	  	9004257	Handle red Contrasting yellow plate	9004257
		20 A	5,5 kW / 120 A	KG10 T106/33 KS51V	06975 0	KG10 T206/33 KS51V	06976 7
		20 A	5,5 kW / 120 A	KG10 T106/75 KS51	06977 4	KG10 T206/75 KS51	06978 1
		25 A	7,5 kW / 180 A	KG20B T106/33 KL11V	06979 8	KG20B T206/33 KL11V	06980 4
		32 A	11 kW / 220 A	KG32B T106/33 KL11V	06981 1	KG32B T206/33 KL11V	06982 8
		40 A	15 kW / 300 A	KG41B T106/33 KL71V	07470 9	KG41B T206/33 KL71V	07471 6
		63 A	22 kW / 350 A	KG64B T106/33 KL71V	07472 3	KG64B T206/33 KL71V	07473 0
		25 A	7,5 kW / 180 A	KG20B T106/75 KL11	06987 3	KG20B T206/75 KL11	06988 0
		32 A	11 kW / 220 A	KG32B T106/75 KL11	06989 7	KG32B T206/75 KL11	06990 3
		40 A	15 kW / 300 A	KG41B T106/75 KL71	06991 0	KG41B T206/75 KL71	06992 7
		63 A	22 kW / 350 A	KG64B T106/75 KL71	06993 4	KG64B T206/75 KL71	06994 1
		80 A	30 kW / 560 A	KG80C T106/34 STM ¹	06995 8	KG80C T206/34 STM ¹	06996 5
		100 A	37 kW / 650 A	KG100C T106/34 STM ¹	06997 2	KG100C T206/34 STM ¹	06998 9
		125 A	45 kW / 750 A	KG125 T106/84 STM ¹	06999 6	KG125 T206/84 STM ¹	07000 8
		160 A	55 kW / 850 A	KG160 T106/84 STM ¹	07001 5	KG160 T206/84 STM ¹	07002 2
		80 A	30 kW / 560 A	KG80C T106/76 STM ¹	07003 9	KG80C T206/76 STM ¹	07004 6
		100 A	37 kW / 650 A	KG100C T106/76 STM ¹	07005 3	KG100C T206/76 STM ¹	07006 0
		125 A	45 kW / 750 A	KG125 T106/86 STM ¹	07013 8	KG125 T206/86 STM ¹	07014 5
		160 A	55 kW / 850 A	KG160 T106/86 STM ¹	07015 2	KG160 T206/86 STM ¹	07016 9
		125 A	45 kW / 750 A	KG125 T106/87 STM ¹	07017 6	KG125 T206/87 STM ¹	07018 3
		160 A	55 kW / 850 A	KG160 T106/87 STM ¹	07019 0	KG160 T206/87 STM ¹	07020 6
275 A	132 kW/2000 A	C316 T106/47 STM ²	07021 3	C316 T206/47 STM ²	07022 0		
			Oversized Wiring Space				Oversized Wiring Space















¹Protection IP 65. ²Switches with cable glands.

To meet the conditions of EMC (Electro Magnetic Compatibility) for connection of frequency regulated motors, maintenance switches are available with shield clips. These clips are used to continue the cable shield circuit through the enclosure.

Maintenance and Safety Switches

**6 pole + 2 cam-operated auxiliary contacts (1 NO, 1 NC),
in Plastic Enclosure (conduit entries for metric threads)**

Auxiliary contacts with special contact systems allow for use in low voltage and current applications as well aggressive environments.



Version		Thermal Current	Ratings AC-23A, AC-23B Breaking Capacity	Main Switches		EAN-Code	Main Switches with Emergency Function		EAN-Code
Protection IP 66/67	Padlock Device	I_{the}	3 x 380 V/440 V	Handle electro-gray 		9004257	Handle red Contrasting yellow plate		9004257
		20 A	5,5 kW / 120 A	KG10	T106/40 KS51V	07023 7	KG10	T206/40 KS51V	07024 4
		25 A	7,5 kW / 180 A	KG20B	T106/40 KL11V	07025 1	KG20B	T206/40 KL11V	07026 8
		32 A	11 kW / 220 A	KG32B	T106/40 KL11V	07027 5	KG32B	T206/40 KL11V	07028 2
		40 A	15 kW / 300 A	KG41B	T106/40 KL71V	07474 7	KG41B	T206/40 KL71V	07475 4
		63 A	22 kW / 350 A	KG64B	T106/40 KL71V	07476 1	KG64B	T206/40 KL71V	07477 8
		25 A	7,5 kW / 180 A	KG20B	T106/78 KL11	07033 6	KG20B	T206/78 KL11	07034 3
		32 A	11 kW / 220 A	KG32B	T106/78 KL11	07035 0	KG32B	T206/78 KL11	07036 7
		40 A	15 kW / 300 A	KG41B	T106/78 KL71	07037 4	KG41B	T206/78 KL71	07038 1
		63 A	22 kW / 350 A	KG64B	T106/78 KL71	07039 8	KG64B	T206/78 KL71	07040 4
		80 A	30 kW / 560 A	KG80C	T106/41 STM ¹	07041 1	KG80C	T206/41 STM ¹	07042 8
		100 A	37 kW / 650 A	KG100C	T106/41 STM ¹	07043 5	KG100C	T206/41 STM ¹	07044 2
		125 A	45 kW / 750 A	KG125	T106/88 STM ¹	07045 9	KG125	T206/88 STM ¹	07046 6
		160 A	55 kW / 850 A	KG160	T106/88 STM ¹	07047 3	KG160	T206/88 STM ¹	07048 0
		80 A	30 kW / 560 A	KG80C	T106/79 STM ¹	07049 7	KG80C	T206/79 STM ¹	07050 3
		100 A	37 kW / 650 A	KG100C	T106/79 STM ¹	07051 0	KG100C	T206/79 STM ¹	07052 7
		125 A	45 kW / 750 A	KG125	T106/89 STM ¹	07053 4	KG125	T206/89 STM ¹	07054 1
		160 A	55 kW / 850 A	KG160	T106/89 STM ¹	07055 8	KG160	T206/89 STM ¹	07056 5
		275 A	132 kW/2000 A	C316	T106/46 STM ²	07057 2	C316	T206/46 STM ²	07058 9
				Oversized Wiring Space					
		125 A	45 kW / 750 A	KG125	T106/90 STM ¹	07059 6	KG125	T206/90 STM ¹	07060 2
		160 A	55 kW / 850 A	KG160	T106/90 STM ¹	07061 9	KG160	T206/90 STM ¹	07062 6
		125 A	45 kW / 750 A	KG125	T106/91 STM ¹	07063 3	KG125	T206/91 STM ¹	07064 0
		160 A	55 kW / 850 A	KG160	T106/91 STM ¹	07065 7	KG160	T206/91 STM ¹	07066 4
		275 A	132 kW/2000 A	C316	T106/48 STM ²	07067 1	C316	T206/48 STM ²	07068 8

¹Protection IP 65. ²Switches with cable glands.

To meet the conditions of EMC (Electro Magnetic Compatibility) for connection of frequency regulated motors, maintenance switches are available with shield clips. These clips are used to continue the cable shield circuit through the enclosure.

Switch Disconnectors ○ – |

3 pole, Types of Mounting

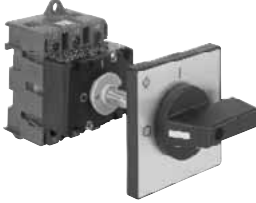
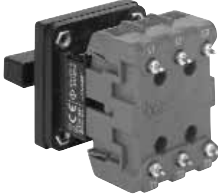

Technical Data		KG20A KG32A KG10A KG20B KG32B KG41 KG64 KG80 KG100 KG10B KG21A ² KG33A ² KG41B KG64B KG80C KG100C KG125 KG160 KG210 KG250 KG315 C316												
Ratings														
3 x 380 V/440 V														
AC-23A, AC-23B kW		5,5	7,5	11	15	22	30	37	45	55	75	90	110	132
AC-3 kW		3,7	5,5	7,5	11	18,5	22	30	37	45	55	55	75	55
Thermal Current I _U /I _{th} A		20	25	32	40	63	80	100	125	160	200	250	315	315
Version Protection	Four Hole Panel Mounting	EAN-Code		Version Protection	Base Mounting		EAN-Code							
		9004257					9004257							
IP 66 ¹ 	KG10A T303 E	01096 7		IP 40 	KG10A T303 VE	01098 1								
	KG10B T303 E	01286 2			KG10B T303 VE	01287 9								
	KG20A T303 E	00799 8			KG20A T303 VE	00820 9								
	KG20B T303 E	00800 1			KG20B T303 VE	00821 6								
	KG32A T303 E	00801 8			KG32A T303 VE	00822 3								
	KG32B T303 E	00802 5			KG32B T303 VE	00823 0								
	KG41 T303 E	00803 2			KG41 T303 VE	00824 7								
	KG41B T303 E	00804 9			KG41B T303 VE	00825 4								
	KG64 T303 E	00805 6			KG64 T303 VE	00826 1								
	KG64B T303 E	00806 3			KG64B T303 VE	00827 8								
	KG80 T303 E	00807 0			KG80 T303 VE	00828 5								
	KG80C T303 E	00808 7			KG80C T303 VE	00829 2								
	KG100 T303 E	00809 4			KG100 T303 VE	00830 8								
	KG100C T303 E	00810 0			KG100C T303 VE	00831 5								
	KG125 T303 E	00812 4			KG125 T303 VE	00833 9								
	KG160 T303 E	00813 1			KG160 T303 VE	00834 6								
	KG210 T303 E	07532 4			KG210 T303 VE	08371 8								
	KG250 T303 E	00815 5			KG250 T303 VE	00836 0								
	KG315 T303 E	00816 2			KG315 T303 VE	00837 7								
C316 T303 E	00817 9		C316 T303 VE	00838 4										
IP 66 	Single Hole Mounting 22 mm		IP 40 	and shaft extension										
	KG10A T303 FT2	02602 9		KG10A T303/57 VE	01289 3									
	KG20A T303 FT2	02603 6		KG10B T303/57 VE	01290 9									
	KG32A T303 FT2	02604 3		KG20A T303/57 VE	00839 1									
On request 	Direct-mounting on Printed Circuit Board			KG20B T303/57 VE	00840 7									
	KG21A T303 E	03234 1		KG32A T303/57 VE	00841 4									
	KG33A T303 E	03235 8		KG32B T303/57 VE	00842 1									
					KG41B T303/57 VE	00843 8								
					KG64B T303/57 VE	00844 5								
					KG80 T303/57 VE	00845 2								
					KG80C T303/57 VE	00846 9								
					KG100 T303/57 VE	00847 6								
					KG100C T303/57 VE	00848 3								
					KG125 T303/57 VE	00850 6								
					KG160 T303/57 VE	00851 3								
					KG210 T303/57 VE	07533 1								
					KG250 T303/57 VE	00853 7								
			KG315 T303/57 VE	00854 4										
			C316 T303/57 VE	00855 1										

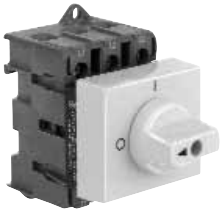
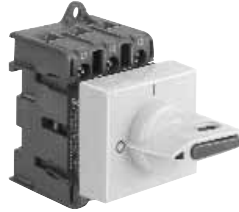
Switch Disconnectors ○ – | 3 pole, Types of Mounting

Technical Data		KG10A	KG20A	KG32A	KG41	KG64	KG80	KG100							
Ratings 3 x 380 V/440 V AC-23A, AC-23B kW AC-3 kW Thermal Current I_u/I_{th} A		5,5	7,5	11	15	22	30	37							
		3,7	5,5	7,5	11	18,5	22	30							
		20	25	32	40	63	80	100							
Version	Base Mounting for Track	EAN-Code			Version	Base Mounting for Track		EAN-Code							
		9004257						9004257							
	Esc. plate for 45 mm standard knock-out					and padlock device for padlocks									
	KG10A T303 VE21 KG20A T303 VE2 KG32A T303 VE2 KG41 T303 VE2 KG64 T303 VE2 KG80 T303 VE2 KG100 T303 VE2	01288 6	00856 8	00857 5		00858 2	00859 9	00860 5	00861 2	KG10A T303/58 VE21 KG20A T303/58 VE2 KG32A T303/58 VE2 KG41 T303/58 VE2 KG64 T303/58 VE2 KG80 T303/58 VE2 KG100 T303/58 VE2	01291 6	00862 9	00863 6	00864 3	00865 0

Switch Disconnectors ○ – | 3 pole + Ground Terminal





Switch Disconnectors ○ – | 3 pole + Neutral Terminal

Technical Data		KH16	KH20	KH25	KH32	KH40	KH63	KH80															
Ratings 3 x 380 V/440 V AC-23A, AC-23B kW AC-3 kW Thermal Current I_u/I_{th} A		7,5	10	12	16	20	30	40															
		5,5	6,5	7,5	11	15	22	30															
		16	20	25	32	40	63	80															
Version	Four Hole Panel Mounting	EAN-Code			Version	Four Hole Panel Mounting		EAN-Code															
Protection		9004257			Protection			9004257															
IP 66 	KH16 T300 E KH16B T300 E KH20 T300 E KH20B T300 E KH25 T300 E KH25B T300 E KH32 T300 E KH40 T300 E KH63 T300 E KH80 T300 E	09313 7	09314 4	09315 1	09316 8	09317 5	09318 2	09319 9	09320 5	09321 2	09322 9	IP 66 	KH16 T307 E KH16B T307 E KH20 T307 E KH20B T307 E KH25 T307 E KH25B T307 E KH32 T307 E KH40 T307 E KH63 T307 E KH80 T307 E	09303 8	09304 5	09305 2	09306 9	09307 6	09308 3	09309 0	09310 6	09311 3	09312 0

¹Further technical data for special applications on printed circuit boards on request.



Switch Disconnectors ○ – |

4 pole, Types of Mounting

Technical Data																		
		KH16 KH20 KH25								KG80 KG100								
		KH16B	KH20B	KH25B	KH32	KH40	KH63	KH80	KG80C	KG100C	KG125	KG160	KG210	KG250	KG315	C316		
Ratings																		
3 x 380 V/440 V																		
AC-23A, AC-23B		kW		7,5	10	12	16	20	30	40	30	37	45	55	75	90	110	132
AC-3		kW		5,5	6,5	7,5	11	15	22	30	22	30	37	45	55	55	75	55
Thermal Current I _U /I _{th}		A		16	20	25	32	40	63	80	80	100	125	160	200	250	315	315
Version Protection	Four Hole Panel Mounting	EAN- Code				Version Protection				Base Mounting				EAN- Code				
		9004257								9004257								
IP 66 ¹ 	KH16	T304 E	07069 5								KG160	T304 VE	00903 9					
	KH16B	T304 E	07070 1								KG210	T304 VE	07535 5					
	KH20	T304 E	07071 8								KG250	T304 VE	00905 3					
	KH20B	T304 E	07072 5								KG315	T304 VE	00906 0					
	KH25	T304 E	07073 2								C316	T304 VE	00907 7					
	KH25B	T304 E	07074 9								and shaft extension							
	KH32	T304 E	06544 8															
	KH40	T304 E	06545 5								IP 40 							
	KH63	T304 E	07536 2															
	KH80	T304 E	07537 9															
	KG80C	T304 E	00877 3															
	KG100	T304 E	00878 0															
	KG100C	T304 E	00879 7															
	KG125	T304 E	00881 0															
	KG160	T304 E	00882 7															
	KG210	T304 E	07534 8															
	KG250	T304 E	00884 1															
	KG315	T304 E	00885 8															
	C316	T304 E	00886 5															
IP 66 	Single Hole Mounting 22 mm																	
	KH16	T304 FT2	07075 6								KH16	T304/57 VE	07084 8					
	KH20	T304 FT2	07076 3								KH16B	T304/57 VE	07085 5					
	KH25	T304 FT2	07077 0								KH20	T304/57 VE	07086 2					
										KH20B	T304/57 VE	07087 9						
										KH25	T304/57 VE	07088 6						
										KH25B	T304/57 VE	07089 3						
										KH32	T304/57 VE	06548 6						
										KH40	T304/57 VE	06549 3						
										KH63	T304/57 VE	07538 6						
										KH80	T304/57 VE	07539 3						
										KG80C	T304/57 VE	00915 2						
										KG100	T304/57 VE	00916 9						
										KG100C	T304/57 VE	00917 6						
										KG125	T304/57 VE	00919 0						
										KG160	T304/57 VE	00920 6						
										KG210	T304/57 VE	07540 9						
										KG250	T304/57 VE	00922 0						
										KG315	T304/57 VE	00923 7						
										C316	T304/57 VE	00924 4						
IP 40 	Base Mounting																	
	KH16	T304 VE	07078 7															
	KH16B	T304 VE	07079 4															
	KH20	T304 VE	07080 0															
	KH20B	T304 VE	07081 7															
	KH25	T304 VE	07082 4															
	KH25B	T304 VE	07083 1															
	KH32	T304 VE	06546 2															
	KH40	T304 VE	06547 9															
	KH63	T304 VE	07541 6															
	KH80	T304 VE	07542 3															
	KG80C	T304 VE	00898 8															
	KG100	T304 VE	00899 5															
KG100C	T304 VE	00900 8																
KG125	T304 VE	00902 2																

¹C316 protection IP 40. Higher protection available on request.

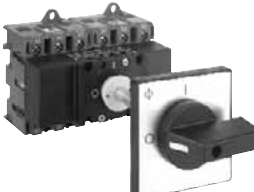

Switch Disconnectors ○ – 6 pole, Types of Mounting	Switch Disconnectors ○ – 8 pole, Types of Mounting
---	---

Technical Data															
	KH16		KG10A	KG10B	KG20B	KG32B	KG41B	KG64B	KG80	KG80C	KG100	KG100C	KG125	KG160	C316
	KH16B		KH20	KH20B	KH25	KH25B	KH32	KH40	KH63	KH80	KG100C	KG125	KG160	C316	
Ratings 3 x 380 V/440 V AC-23A, AC-23B kW AC-3 kW Thermal Current I _u /I _{th} A	7,5	5,5/10 ³	7,5/12 ³	11/16 ³	15/20 ³	22/30 ³	30/40	37	45	55	132				
	5,5	3,7/6,5 ³	5,5/7,5 ³	7,5/11 ³	11/15 ³	18,5/22 ³	22/30	30	37	45	55				
	16	20	25	32	40	63	80	100	125	160	315				
Version Protection	Four Hole Panel Mounting			EAN- Code 9004257		Version Protection			Four Hole Panel Mounting			EAN- Code 9004257			
IP 66 ¹ 	KG10A	T306 E	01296 1	IP 66 	KH16	T308 E	09323 6								
	KG10B	T306 E	01297 8		KH16B	T308 E	09324 3								
	KG20B	T306 E	00925 1		KH20	T308 E	09325 0								
	KG32B	T306 E	00926 8		KH20B	T308 E	09326 7								
	KG41B	T306 E	00927 5		KH25	T308 E	09327 4								
	KG64B	T306 E	00928 2		KH25B	T308 E	09328 1								
	KG80	T306 E	00929 9		KH32	T308 E	09329 8								
	KG80C	T306 E	00930 5		KH40	T308 E	09330 4								
	KG100	T306 E	00931 2		KH63	T308 E ²	09331 1								
	KG100C	T306 E	00932 9		KH80	T308 E ²	09332 8								
	KG125	T306 E	03683 7												
	KG160	T306 E	03685 1												
	C316	T306 E	00935 0												
IP 40  	Base Mounting														
	KG10A	T306 VE	01298 5												
	KG10B	T306 VE	01299 2												
	KG20B	T306 VE	00936 7												
	KG32B	T306 VE	00937 4												
	KG41B	T306 VE	00938 1												
	KG64B	T306 VE	00939 8												
	KG80	T306 VE	00940 4												
	KG80C	T306 VE	00941 1												
	KG100	T306 VE	00942 8												
	KG100C	T306 VE	00943 5												
	KG125	T306 VE	03684 4												
	KG160	T306 VE	03686 8												
	C316	T306 VE	00946 6												
	and shaft extension														
	KG10A	T306/57 VE	01300 5												
	KG10B	T306/57 VE	01301 2												
	KG20B	T306/57 VE	00947 3												
	KG32B	T306/57 VE	00948 0												
	KG41B	T306/57 VE	00949 7												
KG64B	T306/57 VE	00950 3													
KG80	T306/57 VE	00951 0													
KG80C	T306/57 VE	00952 7													
KG100	T306/57 VE	00953 4													
KG100C	T306/57 VE	00954 1													
KG125	T306/57 VE	03687 5													
KG160	T306/57 VE	03688 2													
C316	T306/57 VE	00957 2													

¹C80, C125 and C316 protection IP 40. Higher protection available on request. ²In preparation. ³The values after the slash are valid for KH switches.

Switch Disconnectors 1 – 0 – 2
Double-throw Switches 3 pole,
Types of Mounting













Switch Disconnectors 1 – 0 – 2
Double-throw Switches 2 and 4 pole,
Types of Mounting

Technical Data											
		KH16		KH20		KH25		KH32		C316	
		KH16B		KH20B		KH25B		KH32		C316	
Ratings		7,5		10		7,5/12 ³		11/16 ³		132	
3 x 380 V/440 V											
AC-23A, AC-23B		kW		kW		kW		kW		kW	
AC-3		5,5		6,5		5,5/7,5 ³		7,5/11 ³		55	
Thermal Current I _U /I _{th}		A		A		A		A		A	
16		20		25		32		40		315	
Version	Four Hole Panel Mounting	EAN-Code	Ausführung	Four Hole Panel Mounting	EAN-Code						
Protection		9004257	Schutzart		9004257						
IP 66 ¹		KG20A T903 E 00958 9 KG20B T903 E 00959 6 KG32A T903 E 00960 2 KG32B T903 E 00961 9 KG41B T903 E 00962 6 KG64B T903 E 00963 3 KG80 T903 E 00964 0 KG80C T903 E 00965 7 KG100 T903 E 00966 4 KG100C T903 E 00967 1 KG125 T903 E 03689 9 KG160 T903 E 03691 2 C316 T903 E 00970 1	IP 66	2 pole KH16 T902 E 09333 5 KH16B T902 E 09334 2 KH20 T902 E 09335 9 KH20B T902 E 09336 6 KH25 T902 E 09337 3 KH25B T902 E 09338 0 KH32 T902 E 09339 7 KH40 T902 E 09340 3 KH63 T902 E 09341 0 KH80 T902 E 09342 7							
						IP 40		Base Mounting KG20B T903 VE 00971 8 KG32B T903 VE 00972 5 KG41B T903 VE 00973 2 KG64B T903 VE 00974 9 KG80 T903 VE 00975 6 KG80C T903 VE 00976 3 KG100 T903 VE 00977 0 KG100C T903 VE 00978 7 KG125 T903 VE 03690 5 KG160 T903 VE 03692 9 C316 T903 VE 00981 7 and shaft extension KG20B T903/57 VE 00982 4 KG32B T903/57 VE 00983 1 KG41B T903/57 VE 00984 8 KG64B T903/57 VE 00985 5 KG80 T903/57 VE 00986 2 KG80C T903/57 VE 00987 9 KG100 T903/57 VE 00988 6 KG100C T903/57 VE 00989 3 KG125 T903/57 VE 03693 6 KG160 T903/57 VE 03694 3 C316 T903/57 VE 00992 3	IP 66	4 pole KH16 T904 E 09343 4 KH16B T904 E 09344 1 KH20 T904 E 09345 8 KH20B T904 E 09346 5 KH25 T904 E 09347 2 KH25B T904 E 09348 9 KH32 T904 E 09349 6 KH40 T904 E 09350 2 KH63 T904 E ² 09351 9 KH80 T904 E ² 09352 6	
IP 40		Base Mounting for Track KG20A T903 VE2 06488 5 KG32A T903 VE2 06489 2 KG41B T903 VE2 06490 8 KG64B T903 VE2 06491 5 KG80 T903 VE2 06492 2 KG100 T903 VE2 06493 9									

¹C80, C125 and C316 protection IP 40. Higher protection available on request. ²In preparation. ³The values after the slash are valid for KH switches.



Switch Disconnectors - |

3, 4, and 6 pole, in Plastic Enclosure (conduit entries for metric threads)

Technical Data		KG20 KG32 KG41 KG64 KG10 KG20B KG32B KG41B KG64B KG80 KH16 KH20 KH25 KH32 KH40 KH63 KH80 KG100 KG125 KG160 KG250 KG315 C316													
Ratings															
3 x 380 V/440 V															
AC-23A, AC-23B	kW	7,5	5,5/10 ⁴	7,5/12 ⁴	11/16 ⁴	15/20 ⁴	22/30 ⁴	30/40 ⁴	37	45	55	90	110	132	
AC-3	kW	5,5	3,7/6,5 ⁴	5,5/7,5 ⁴	7,5/11 ⁴	11/15 ⁴	18,5/22 ⁴	22/30 ⁴	30	37	45	55	75	55	
Thermal Current I _{the}	A	16	20	25	32	40	63	80	100	125	160	250	315	315 ² /275 ³	
Version	3 pole	EAN-Code	Version	4 pole	EAN-Code										
Protection IP 66/67		9004257	Protection IP 66/67		9004257										
	KG10 T303 KS51 KG20 T303 KS51	07283 5 07284 2		KG125 T304/60 STM KG160 T304/60 STM KG250 T304/61 STM KG315 T304/61 STM ⁵ C316 T304/62 STM ⁵	07309 2 07310 8 07311 5 07312 2 07313 9										
	KG20 T303 KL51 KG32 T303 KL51 KG41 T303 KL11 KG64 T303 KL11 KG80 T303 KL71 KG100 T303 KL71	07285 9 07286 6 07287 3 07288 0 07289 7 07290 3		Oversized Wiring Space											
	KG125 T303/59 STM ¹ KG160 T303/59 STM ¹ KG250 T303/61 STM KG315 T303/61 STM ⁵ C316 T303/62 STM ⁵	07291 0 07292 7 07293 4 07294 1 07295 8		6 pole											
	Oversized Wiring Space			KG10 T306 KS51 KG20B T306 KL11 KG32B T306 KL11 KG41B T306 KL71 KG64B T306 KL71	07319 1 07320 7 07321 4 07322 1 07323 8										
	KG125 T303/61 STM KG160 T303/61 STM KG250 T303/63 STM ⁵ KG315 T303/63 STM ⁵ C316 T303/63 STM ⁵	07296 5 07297 2 07298 9 07299 6 07300 9		KG80 T306/59 STM ¹ KG100 T306/59 STM ¹ KG125 T306/59 STM ¹ KG160 T306/59 STM ¹ C316 T306/63 STM ⁵	07324 5 07325 2 07326 9 07327 6 07328 3										
	4 pole			Oversized Wiring Space											
	KH16 T304 KS51 KH20 T304 KS11	08763 1 08764 8		KG125 T306/61 STM KG160 T306/61 STM C316 T306/64 STM ⁵	07329 0 07330 6 07331 3										
	KH25 T304 KL11 KH32 T304 KL11 KH40 T304 KL11 KH63 T304 KL71 KH80 T304 KL71 KG100 T304 KL71	08765 5 08766 2 08767 9 08863 8 08864 5 07308 5													

¹Protection IP 65. ²For switches 3 and 4 pole. ³For switches 6 pole. ⁴The values after the slash are valid for KH switches. ⁵Switches with cable glands.

Lateral mounted Auxiliary Contacts

Version	For Switch Type	For Front Mounting	EAN-Code 9004257	For Base Mounting	EAN-Code 9004257
Lateral mounted auxiliary contacts with 1 NO + 1 NC 	KG20-KG32B, KH16-KH25B	K0 H010/A11-E	06473 1	K0 H010/A11-VE	06474 8
	KH32, KH40, KH63, KH80	K1 H010/11A-E	06542 4	K1 H010/11A-VE	06543 1
	KG41-KG64B	K1 H010/A11-E	06475 5	K1 H010/A11-VE	06476 2
	KG80-KG100C	K2 H010/A11-E	06477 9	K2 H010/A11-VE	06478 6
Lateral mounted auxiliary contacts with 2 NO + 1 NC 	KG125, KG160	K3A H010/A21-E	06479 3	K3A H010/A21-VE	06480 9
	KG210, KG250, KG315	K3 H010/A21-E	06481 6	K3 H010/A21-VE	06482 3

Protective Covers

Version	For Switch Type		EAN-Code 9004257		EAN-Code 9004257
	KG10A, KG10B	2 pole	01574 0	3 and 4 pole	01575 7
		S0 M160/A12		S0 M160/A12 K2	
	KG20A, KG20B KG32A, KG32B	3 pole	01576 4	4 pole	01579 5
		K0 M160/3		K0 M160/4	
	KG41, KG41B KG64, KG64B	K1 M160/3	01577 1	K1 M160/4	01580 1
		K2 M160/3	01578 8	K2 M160/4	01581 8
	KG80, KG80C KG100, KG100C	K3 M160/32	01582 5	K3 M160/42	01583 2
		K3 M160/30	06486 1	K3 M160/40	06487 8
	KG125, KG160	For Front Mounting		For Base Mounting	
		KH32, KH40 KH63, KH80	K1 M160/45-E	09198 0	K1 M160/45-VE
K1 M160/44-E	08905 5		K1 M160/44-VE	08906 2	

Add-on Escutcheon Plates

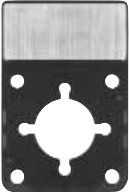
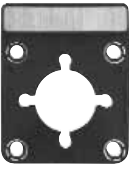
Version Escutcheon Plate frame Black	Description	Escutcheon Plate Size in mm	Escutcheon Plate Backing Brushed Alu	EAN- Code 9004257	Escutcheon Plate Backing Yellow	EAN- Code 9004257	
Higher Inscription field 	HAUPTSCHALTER	48 x 48 64 x 64 88 x 88 130 x 130	S0 F822/A1B - PRA S1 F822/A1B - PRA S2 F822/A1B - PRA S3 F822/A1B - PRA	01538 2 01539 9 01540 5 01541 2	S0 F822/E1B - PRA S1 F822/E1B - PRA S2 F822/E1B - PRA S3 F822/E1B - PRA	01542 9 01543 6 01544 3 01545 0	
	HAUPTSCHALTER NUR IN 0-STELLUNG ÖFFNEN	48 x 48 64 x 64 88 x 88 130 x 130	S0 F832/A1B - PRA S1 F832/A1B - PRA S2 F832/A1B - PRA S3 F832/A1B - PRA	01546 7 01547 4 01548 1 01549 8	S0 F832/E1B - PRA S1 F832/E1B - PRA S2 F832/E1B - PRA S3 F832/E1B - PRA	01550 4 01551 1 01552 8 01553 5	
	HAUPTSCHALTER MAIN SWITCH	48 x 48 64 x 64 88 x 88 130 x 130	S0 F836/A1B - PRA S1 F836/A1B - PRA S2 F836/A1B - PRA S3 F836/A1B - PRA	06335 2 06336 9 06337 6 06338 3	S0 F836/E1B - PRA S1 F836/E1B - PRA S2 F836/E1B - PRA S3 F836/E1B - PRA	06339 0 06340 6 06341 3 06342 0	
	MAIN SWITCH	48 x 48 64 x 64 88 x 88 130 x 130	S0 F824/A1B - PRA S1 F824/A1B - PRA S2 F824/A1B - PRA S3 F824/A1B - PRA	01554 2 01555 9 01556 6 01557 3	S0 F824/E1B - PRA S1 F824/E1B - PRA S2 F824/E1B - PRA S3 F824/E1B - PRA	01558 0 01559 7 01560 3 01561 0	
	INTERRUPTEUR GENERAL	48 x 48 64 x 64 88 x 88 130 x 130	S0 F828/A1B - PRA S1 F828/A1B - PRA S2 F828/A1B - PRA S3 F828/A1B - PRA	01562 7 01563 4 01564 1 01565 8	S0 F828/E1B - PRA S1 F828/E1B - PRA S2 F828/E1B - PRA S3 F828/E1B - PRA	01566 5 01567 2 01568 9 01569 6	
	Lower Inscription field 	HAUPTSCHALTER	48 x 48 64 x 64	S0 F822/A1B - PRC S1 F822/A1B - PRC	00549 9 00552 9	S0 F822/E1B - PRC S1 F822/E1B - PRC	00555 0 01588 7
		HAUPTSCHALTER NUR IN 0-STELLUNG ÖFFNEN	48 x 48 64 x 64	S0 F832/A1B - PRC S1 F832/A1B - PRC	01570 2 01571 9	S0 F832/E1B - PRC S1 F832/E1B - PRC	01572 6 01573 3
		HAUPTSCHALTER MAIN SWITCH	48 x 48 64 x 64	S0 F836/A1B - PRC S1 F836/A1B - PRC	06343 7 06344 4	S0 F836/E1B - PRC S1 F836/E1B - PRC	06345 1 06346 8
		MAIN SWITCH	48 x 48 64 x 64	S0 F824/A1B - PRC S1 F824/A1B - PRC	00550 5 00553 6	S0 F824/E1B - PRC S1 F824/E1B - PRC	00556 7 01589 4
		INTERRUPTEUR GENERAL	48 x 48 64 x 64	S0 F828/A1B - PRC S1 F828/A1B - PRC	00551 2 00554 3	S0 F828/E1B - PRC S1 F828/E1B - PRC	00557 4 01590 0

Terminals for Control Circuit

Version	For Switch Type		EAN-Code 9004257	Max. Permissible Wire Gage Single-core or stranded wire	Flexible wire
	KG41-KG64B	K1B D220 KS	08907 9	2,5 mm ² AWG12	2,5 mm ² AWG14
	KG80-KG100C	K2B D520 KSA	06483 0	2,5 mm ² AWG12	2,5 mm ² AWG14
	KG125, KG160	K3A D720 KS	06484 7	4 mm ² AWG10	4 mm ² AWG12
	KG210, KG250, KG315, C316	K3B D520 KS	06485 4	4 mm ² AWG10	4 mm ² AWG12

Unlock Insert

Version	Unlock insert for the M700		EAN-Code 9004257	
	To open the door in ON position. (After the locking has been made inactive, it is necessary to take effective precautions against an opening of the door by unauthorized persons.)	S1D M700 29	07090 9	

Mounting Key

Version	For Switches with Single Hole Mounting		EAN-Code 9004257	
	Mounting key for locking nut	S00 T170 09	08726 6	

Connection Diagrams

(KG and C switches)

3 pole

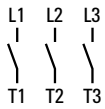

3 pole + 1 NO for KG switches

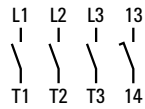

3 pole + 1 NO for C switches

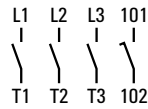

3 pole + 1 NO, 1 NC for KG switches

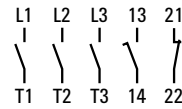

3 pole + 1 NO, 1 NC for C switches

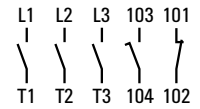

3 pole + PE, N

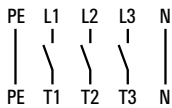

4 pole

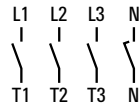

4 pole + 1 NO, 1 NC for KG switches

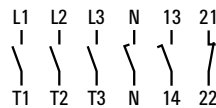

4 pole + 1 NO, 1 NC for C switches

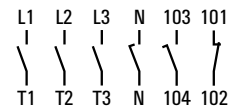

6 pole

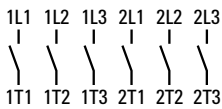

6 pole + 1 NO, 1 NC for KG switches

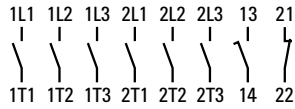

6 pole + 1 NO, 1 NC for C switches

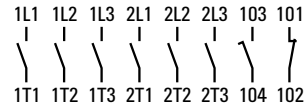

3 pole (Double-throw switches)

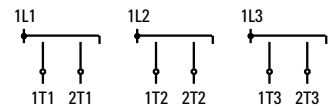

Connection Diagrams

(KH switches)

3 pole + PE

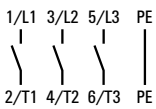

3 pole + N

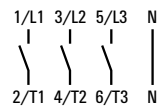

4 pole

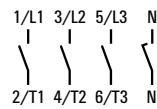

8 pole

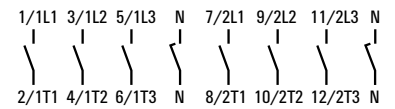

2 pole (Double-throw switches)

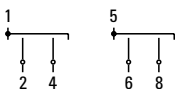

4 pole (Double-throw switches)

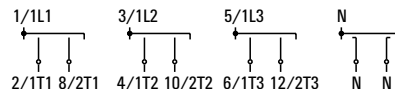

Switches for Panel Mounting

Two or Four Hole Panel Mounting

Dimensions mm
inch

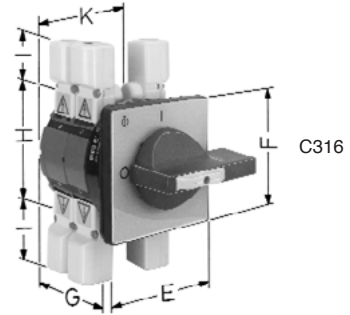
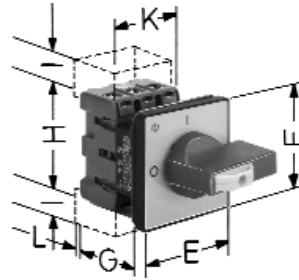
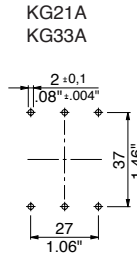
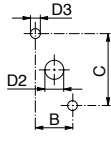
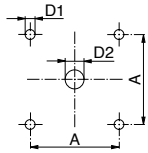

	A	B ²	C ²	D1	D2	D3	E/F	Pole					H	I	Pole					L			
								2	3, 4	3+1	3+PE,N	6 ¹			2, 3, 3+1	3+PE,N	4 ¹ 3+PE 3+N	6 ¹	8 ¹				
KG10A	36 1.42	12,2 .48	30 1.18	5 .20	11-15 .43-.59	3,5 .14	48 1.89	38,7 1.52	48,2 1.90	48,2 1.90		58 2.28	50 1.97	7,5 .30	48 1.89		48 1.89						
KG10B	48 1.89	12,2 .48	30 1.18	5 .20	11-15 .43-.59	3,5 .14	64 2.52	45,7 1.80	55,2 2.17	55,2 2.17		67 2.64	50 1.97	7,5 .30	48 1.89		48 1.89						
KG20A, KG32A, KG21A, KG33A	36 1.42	12,2 .48	30 1.18	5 .20	10 .39	3,5 .14	48 1.89		53,8 ³ 2.12	62,8 2.47	53,8 2.12	61,3 2.42	54 2.13	20 .79	42 1.65	69 2.72	56 2.21					6 .24	
KG20B, KG32B	48 1.89	12,2 .48	30 1.18	5 .20	10 .39	3,5 .14	64 2.52		53,8 2.12	62,8 2.47	53,8 2.12	61,3 2.42	54 2.13	20 .79	42 1.65	69 2.72	56 2.21	84 3.31				6 .24	
KG41, KG64	36 1.42			5 .20	10 .39		48 1.89		60,5 2.38		60,5 2.38	61,3 2.42	64 2.52	17 .67	50 1.97	82 3.23	66 2.60					5,5 .22	
KG41B, KG64B	48 1.89	12,2 .48	30 1.18	5 .20	10 .39	3,5 .14	64 2.52		60,5 2.38	73 2.87	60,5 2.38	66,5 2.62	64 2.52	17 .67	50 1.97	82 3.23	66 2.60	100 3.94				5,5 .22	
		14 .55	37 1.46			4,5 .18																	
KG41B T.3/81 E, KG64B T.3/81 E	68 2.68			6 .24	10 .39		88 3.46		61 2.40				64 2.52	17 .67	50 1.97							5,5 .22	
KG80, KG100	48 1.89	14 .55	37 1.46	5 .20	10 .39	4,5 .18	64 2.52		70,6 2.78	80,6 3.17	70,6 2.78	81,8 3.22	80 3.15	26 1.02	70 2.76	114 4.49	92 3.62	140 5.51				5,5 .22	
KG80C, KG100C	68 2.68	14 .55	37 1.46	6 .24	10 .39	4,5 .18	88 3.46		70,6 2.78	80,6 3.17	70,6 2.78	81,8 3.22	80 3.15	26 1.02	70 2.76	114 4.49	92 3.62	140 5.51				5,5 .22	
KG125, KG160	68 2.68			6 .24	13 .51		88 3.46		96 3.78	117 4.61	96 3.78	98 3.86	108 4.25	22,2 .87	112 4.41	188 7.40	150 5.91	224 8.82					
KG210, KG250, KG315	68 2.68			6 .24	13 .51		88 3.46		103 4.06	124 4.88	103 4.06		126 4.96	25 .98	145 5.71	250 9.84	197,5 7.78					6 .24	
KH16, KH20, KH25	36 1.42	12,2 .48	30 1.18	5 .20	10-15 .39	3,5 .14	48 1.89		49 1.93				56 2.20				60 2.36				120,1 4.73		
KH16B, KH20B, KH25B	48 1.89	12,2 .48	30 1.18	5 .20	10-15 .39	3,5 .14	64 2.52		49 1.93				56 2.20				60 2.36				120,1 4.73		
KH32, KH40	48 1.89	12,2 .48	30 1.18	5 .20	10-15 .39-.59	3,5 .14	64 2.52		54 2.13				62 2.44	14 .55			70 2.76				140,1 5.52		
KH63, KH80	48 1.89	14 .55	37 1.46	5 .20	10-15 .39-.59	4,5 .18	64 2.52		62 2.44				90 3.54	23,5 .93			86 3.39				172,1 6.78	3,5 .14	
C316	104 4.09			7 .28	16 .63		130 5.12		117,2 4.61	137,2 5.40		155,8 6.13	150 5.91	46 1.81	128 5.04		128 5.04						

¹Also valid for double-throw switches. ²Only for main switches and main switches with emergency function. ³KG21A and KG33A G = 56,1 mm/2.21 inch.

Single Hole Mounting 22 mm

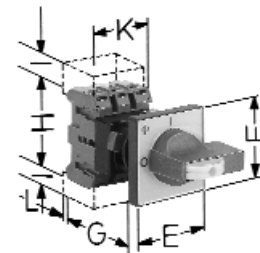
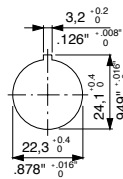

	E/F	E/F	E/F	Pole				H	I	Pole			L
				2	3, 4	3+1	3+PE, N			2, 3, 3+1	3+PE, N	4	
KG10A	49 1.93	48 1.89		56,6 2.23	66,1 2.60	66,1 2.60		50 1.97	7,5 .30	48 1.89		48 1.89	
KG10B		64 2.52	64 2.52	56,6 2.23	66,1 2.60	66,1 2.60		50 1.97	7,5 .30	48 1.89		48 1.89	
KG20A, KG32A	49 1.93	48 1.89			68,3 2.69	77,3 3.04	68,3 2.69	54 2.13	20 .79	42 1.65	69 2.72	56 2.20	6 .24
KG20B, KG32B		64 2.52	64 2.52		68,3 2.69	77,3 3.04	68,3 2.69	54 2.13	20 .79	42 1.65	69 2.72	56 2.20	6 .24
KH16, KH20, KH25 FT2	49 1.93	48 1.89			63,5 2.50			56 2.20				60 2.36	
KH16, KH20, KH25 FH3		64 2.52	64 2.52		63,5 2.50			56 2.20				60 2.36	
KH32, KH40		64 2.52	64 2.52		68,7 2.70			62 2.44	14 .55			70 2.76	
KH63, KH80		64 2.52	64 2.52		77,1 3.04			90 3.54	23,5 .93			86 3.39	

Switches for Base Mounting

Dimensions mm inch

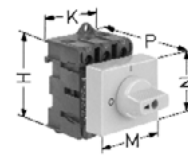
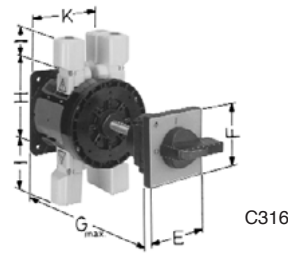
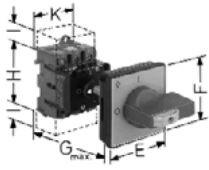

Switch Disconnectors

Main Switches and Main Switches with Emergency Function

	With shaft extension				With single hole mounting without centering device																	
	Pole 3, 4		6 ¹		3, 4, 6 ¹		2		3, 4, 3 + PE, N ³		3 + 1		Pole 3,3+1		3 + PE, N		4		6 ¹		6 ¹	
	E/F	G	G	G	E/F ²	G	G	G	G	H	I	K	K	K	K	M	N	P	P	P	P	
KG10A	48 1.89	61,2 2.41	70,7 2.78	190 7.48	48 1.89	190 7.48	151,2 5.95	160,7 6.33	160,7 6.33	50 1.97		48 1.89		48 1.89	48 1.89	52 2.05	44,7 1.76	64,3 2.53				
KG10B	64 2.52	85,2 3.35	94,7 3.73	190 7.48	64 2.52	190 7.48	160,2 6.31	169,7 6.68	169,7 6.68	50 1.97		48 1.89		48 1.89	48 1.89							
KG20A, KG32A	48 1.89	62 2.44		190 7.48	48 1.89	190 7.48		166,5 6.56	175,5 6.91	54 2.13	20 .79	42 1.65	69 2.72	55,5 2.19	84 3.31	43,3 1.70	44,2 1.74	61 2.40	69 2.72			
KG20B, KG32B	64 2.52	63,5 2.50	71 2.80	190 7.48	64 2.52	190 7.48		166,5 6.56	175,5 6.91	54 2.13	20 .79	42 1.65	69 2.72	55,5 2.19	84 3.31							
KG41, KG64	48 1.89	73 2.87		190 ⁵ 7.48	48 1.89	190 ⁵ 7.48		183,5 7.22	193,5 7.62	64 2.52	17 .67	50 1.97	82 3.23	66 2.60		52 2.05	44,4 1.75	61,5 2.42				
KG41B, KG64B	64 2.52	74,5 2.93	80,5 3.17	190 ⁵ 7.48	64 2.52	190 ⁵ 7.48		183,5 7.22	193,5 7.62	64 2.52	17 .67	50 1.97	82 3.23	66 2.60	100 3.94				67,5 2.66			
KG80	64 2.52	81,5 3.21	92,7 3.65	380 14.96	64 2.52	380 14.96		187,5 7.38	197,5 7.78	80 3.15	26 1.02	70 2.76	114 4.49	92 3.62	140 5.51	70 2.76	45 1.77	70 2.76				
KG80C	88 3.47	81,5 3.21	92,7 3.65	380 14.96	88 3.47	380 14.96																
KG100	64 2.52	81,5 3.21	92,7 3.65	450 17.72	64 2.52	450 17.72		187,5 7.38	197,5 7.78	80 3.15	26 1.02	70 2.76	114 4.49	92 3.62	140 5.51	70 2.76	45 1.77	70 2.76				
KG100C	88 3.47	81,5 3.21	92,7 3.65	450 17.72	88 3.47	450 17.72																
KG125, KG160	88 3.47	107 4.21	109 4.29	450 17.72	88 3.47	450 17.72				108 4.25	22,2 .87	112 4.41	188 7.40	150 5.91	224 8.82							
KG210, KG250, KG315	88 3.47	114 4.49		550 21.65	88 3.47	550 21.65				126 4.96	25 .98	145 5.71	250 9.84	197,5 7.78								
KH16, KH20, KH25	48 1.89	59 2.32		190 7.48	48 1.89	190 7.48		163,5 6.44		56 2.20				60 2.36								
KH16B, KH20B, KH25B	64 2.52	60,5 2.38		190 7.48	64 2.52	190 7.48		163,5 6.44		56 2.20				60 2.36								
KH32, KH40	64 2.52	79 3.11		190 7.48	64 2.52	190 7.48		178 7.01		62 2.44	14 .55			70 2.76								
KH63, KH80	64 2.52	85 3.35		330 ⁶ 12.99	64 2.52	330 ⁶ 12.99		187,5 7.38		90 3.54	23,5 .93			86 3.39								
C316	130 5.12	148 5.83	186,5 7.34	550 21.65	88 3.47	550 21.65				150 5.91	46 1.81	128 5.04		128 5.04	128 5.04							

	Bottom Plate					Front Plate			
	A	B	C	C1	D1	E ⁴	D3 ⁴	D2	D2 ⁴
KG10A						36	5	8-15	19-22
KG10B						1.42	.20	.32-.59	.75-.87
KG20A, KG32A	22	60			4,1	36	5	8-15	19-22
KG20B, KG32B	.87	2.36			.16	1.42	.20	.32-.59	.75-.87
KG41, KG64	25	70			4,1	36	5	8-15	19-22
KG41B, KG64B	.98	2.76			.16	1.42	.20	.32-.59	.75-.87
KG80, KG100	25	90			4,1	48	5	10-15	19-22
KG80C, KG100C	.98	3.54			.16	1.89	.20	.39-.59	.75-.87
KG125, KG160	36	120			6,4	68	6	13-17	26-30
KG210, KG250, KG315	44	142			6,4	68	6	13-17	26-30
KH16, KH20, KH25	22	60			.25	2.68	.24	.51-.67	1.02-1.18
KH16B, KH20B, KH25B	.86	2.36			.17	1.42	.20	.32-.59	.75-.87
KH32, KH40	25	70			4,2	36	5	8-15	19-22
KH63, KH80	.98	2.76			.16	1.89	.20	.39-.59	.75-.87
C316	104	104			7	104	7	15,5-20	.61-.79

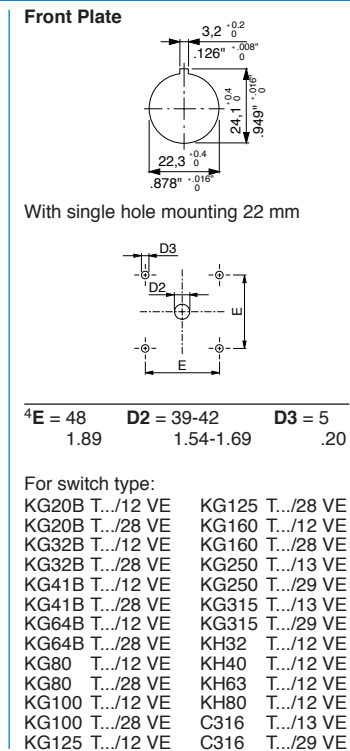
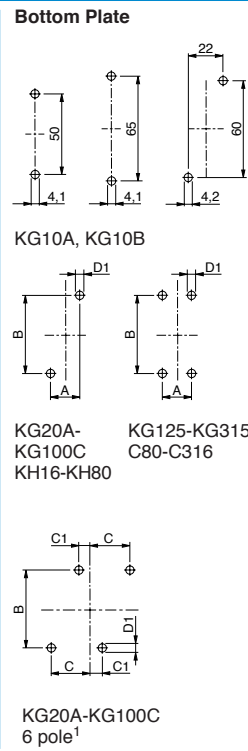

¹Also valid for double-throw switches. ²Versions T.../12 VE, T.../13 VE, T.../28 VE, T.../29 VE = 88 mm/3.47 inch. ³KG10A and KG10B + 9,5 mm/.37 inch. ⁴Different dimensions see right table. ⁵KG64 and KG64B G = 330 mm/12.99 inch. ⁶KH80 G = 380 mm/14.96 inch.

Switches in Plastic Enclosure

Dimensions mm
inch

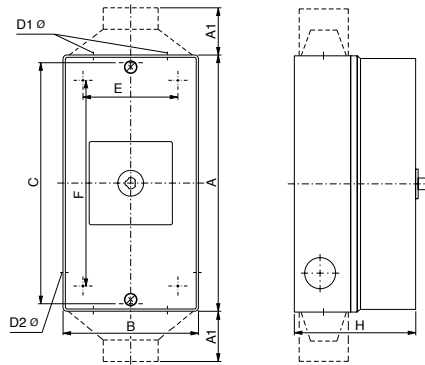

	Pole						A	A1	B	C	D1	D2	E	F	H
	3	3 + 2	4	4 + 2	6	6 + 2									
KG10 T... KS51	x	x	x	x	x		120		85	110	2 x 20/25	20			80
KH16 T... KS51 ²							4.72	3.35	4.33	2 x .79/.98	.79				3.15
KG10 T... KS51V	x	x	x	x	x	x	120		85	110	2 x 20/25	20			90
KH16 T... KS51V ²							4.72	3.35	4.33	2 x .79/.98	.79				3.54
KG20 T... KS51	x						120		85	110	2 x 20/25	20			80
							4.72	3.35	4.33	2 x .79/.98	.79				3.15
KG20 T... KS51V	x						120		85	110	2 x 20/25	20			90
							4.72	3.35	4.33	2 x .79/.98	.79				3.54
KG20 ¹ , KG32	x	x					160		85	150	2 x 20	20			78
T... KL51							6.30	3.35	5.91	2 x .79	.79				3.07
KG20 ¹ , KG32	x	x					160		85	150	2 x 20	20			82
T... KL51V							6.30	3.35	5.91	2 x .79	.79				3.23
KH20 T... KS11			x				120		85	110	2 x 20/25	20			80
							4.72	3.35	4.33	2 x .79/.98	.79				3.15
KH20, KH25			x	x			160		85	150	2 x 25	20			78
T... KL11							6.30	3.35	5.91	2 x .98	.79				3.07
KH20, KH25			x	x			160		85	150	2 x 25	20			82
T... KL11V							6.30	3.35	5.91	2 x .98	.79				3.23
KG20B, KG32B					x	x	190		100	178	2 x 25	25			91
T... KL11							7.48	3.94	7.01	2 x .98	.98				3.58
KG20B, KG32B					x	x	190		100	178	2 x 25	25			93
T... KL11V							7.48	3.94	7.01	2 x .98	.98				3.66
KG41, KG64 T... KL11	x	x	x	x			190		100	178	2 x 25	25			91
KH32, KH40 T... KL11 ²							7.48	3.94	7.01	2 x .98	.98				3.58
KG41, KG64 T... KL11V	x	x	x	x			190		100	178	2 x 25	25			93
KH32, KH40 T... KL11V ²							7.48	3.94	7.01	2 x .98	.98				3.66
KG41B, KG64B					x	x	250		145		2 x 40	25	124	229	107
							9.84	5.71			2 x 1.57	.98	4.88	9.02	4.21
KG80, KG100	x	x	x	x			250		145		2 x 40	25	124	229	107
KH63, KH80 ²							9.84	5.71			2 x 1.57	.98	4.88	9.02	4.21
KG80, KG100					x	x	300		200		2 x 40/50		172	272	172
KG80C, KG100C							11.81	7.87			2 x 1.57/1.97	3 x .79	6.77	10.71	6.77
KG125, KG160	x	x					300		200		2 x 40/50		172	272	172
							11.81	7.87			2 x 1.57/1.97	3 x .79	6.77	10.71	6.77
			x	x			280		280		2 x 50	1 x 20	254	254	180
							11.02	11.02			2 x 1.97	1 x .79	10.00	10.00	7.09
	x ¹	x ¹	x ¹	x ¹			380		280		2 x 63	1 x 20	254	354	180
							14.96	11.02			2 x 2.48	1 x .79	10.00	13.94	7.09
					x	x	300		300		2 x 50	1 x 20	272	272	172
							11.81	11.81			2 x 1.97	1 x .79	10.71	10.71	6.77
					x ¹	x ¹	400		300		2 x 63	1 x 20	272	372	172
							15.75	11.81			2 x 2.48	1 x .79	10.71	14.65	6.77
KG250	x	x	x	x			380		280		2 x 63	1 x 20	254	354	180
							14.96	11.02			2 x 2.48	1 x .79	10.00	13.94	7.09
	x ¹	x ¹					560	110	280		1 x 28-60 ³	2 x 20	254	534	180
							22.05	4.33	11.02		1 x 1.10-2.36	2 x .79	10.00	21.02	7.09
			x ¹	x ¹			560	110	380		1 x 28-60 ³	2 x 20	354	534	180
							22.05	4.33	14.96		1 x 1.10-2.36	2 x .79	13.94	21.02	7.09
KG315	x	x	x	x			380	110	280		1 x 28-60 ³	2 x 20	254	354	180
							14.96	4.33	11.02		1 x 1.10-2.36	2 x .79	10.00	13.94	7.09
	x ¹	x ¹					560	110	280		1 x 28-60 ³	2 x 20	254	534	180
							22.05	4.33	11.02		1 x 1.10-2.36	2 x .79	10.00	21.02	7.09
			x ¹	x ¹			560	110	380		1 x 28-60 ³	2 x 20	354	534	180
							22.05	4.33	14.96		1 x 1.10-2.36	2 x .79	13.94	21.02	7.09
C316	x	x	x	x			380	110	280		1 x 28-60 ³	2 x 20	254	354	230
							14.96	4.33	11.02		1 x 1.10-2.36	2 x .79	10.00	13.94	9.06
	x ¹	x ¹	x ¹	x ¹			560	110	280		1 x 28-60 ³	2 x 20	254	534	230
							22.05	4.33	11.02		1 x 1.10-2.36	2 x .79	10.00	21.02	9.06
					x		560	110	280		2 x 28-60 ³	2 x 20	254	534	230
							22.05	4.33	11.02		2 x 1.10-2.36	2 x .79	10.00	21.02	9.06
					x		560	110	280		2 x 28-60 ³	2 x 20	254	534	280
							22.05	4.33	11.02		2 x 1.10-2.36	2 x .79	10.00	21.02	11.02
					x ¹		560	110	380		2 x 28-60 ³	2 x 20	354	534	230
							22.05	4.33	14.96		2 x 1.10-2.36	2 x .79	13.94	21.02	9.06
						x ¹	560	110	380		2 x 28-60 ³	2 x 20	354	534	280
							22.05	4.33	14.96		2 x 1.10-2.36	2 x .79	13.94	21.02	11.02

¹Oversized wiring space. ²Pole 4 and 4+2. ³outside cable diameter

NOTES

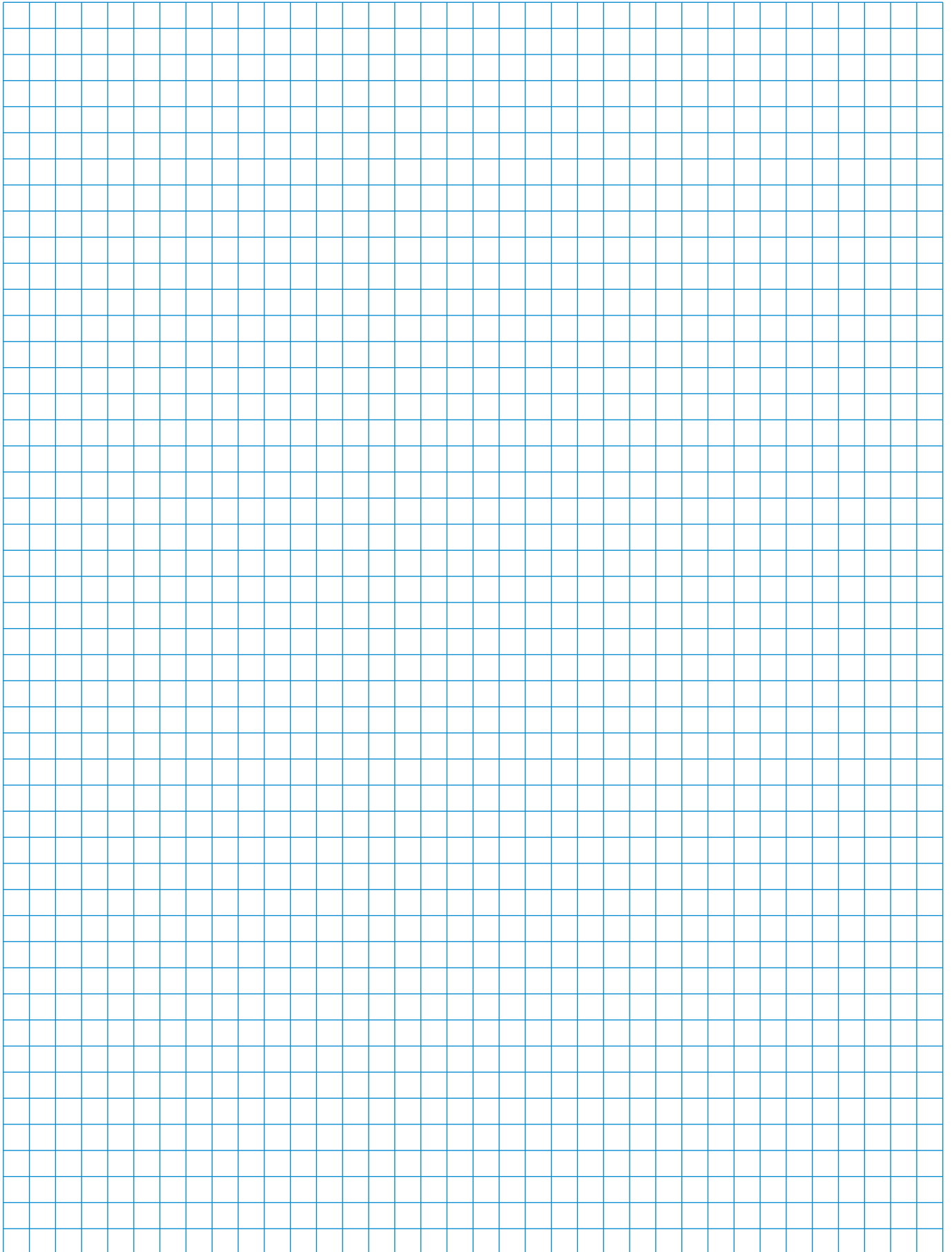

NOTES

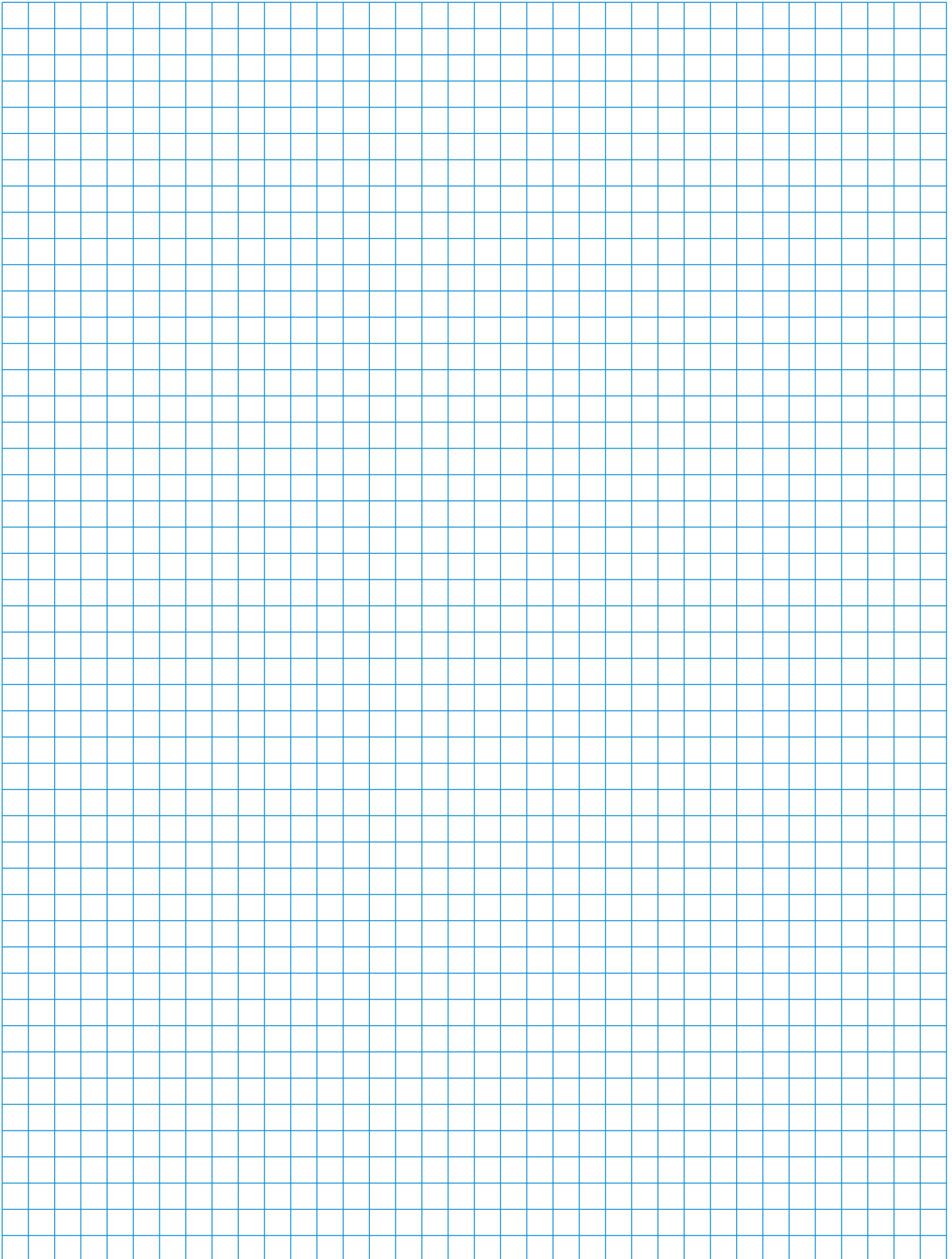

NOTES

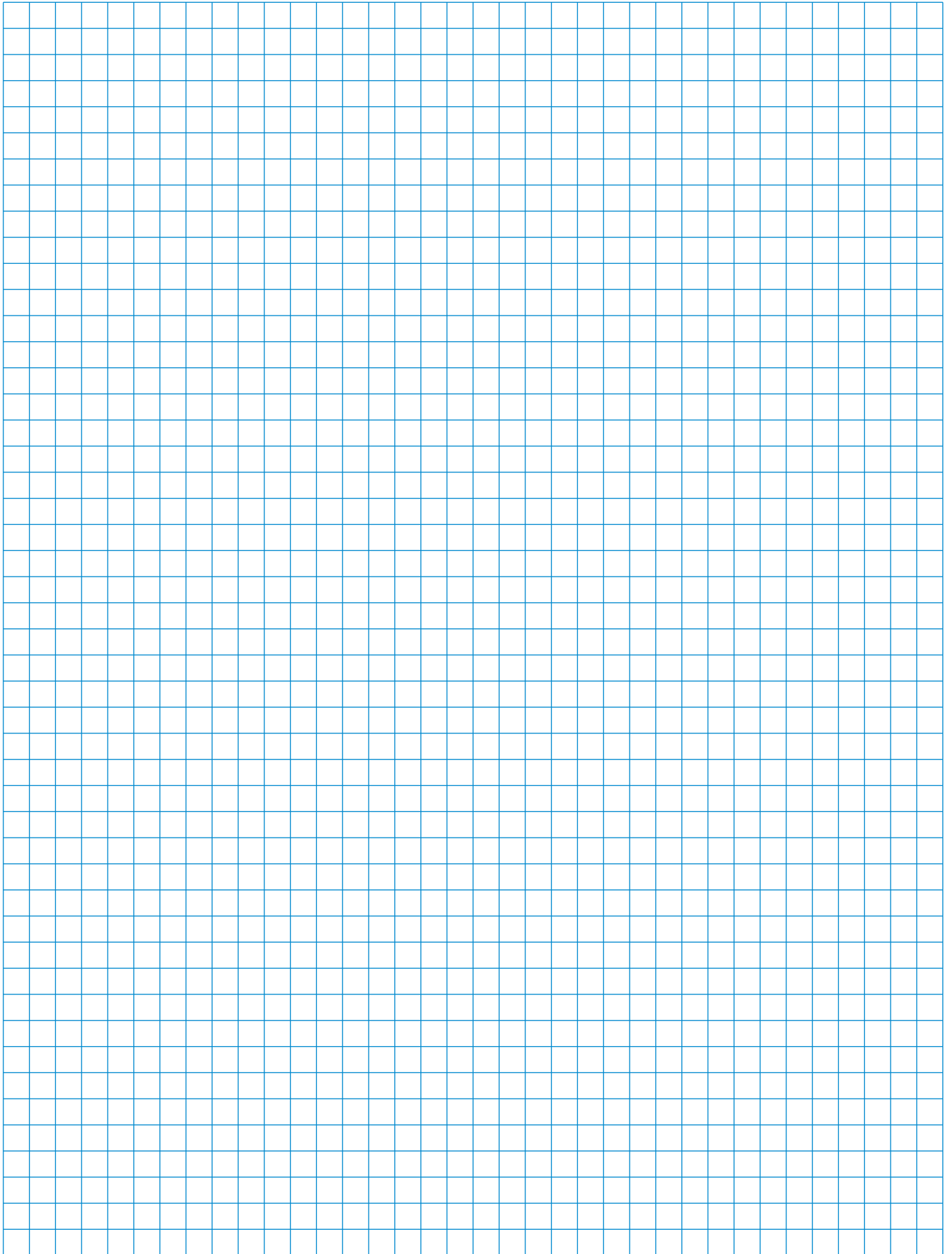

The Range of “Blue Line” Switchgear

Technical literature covering the following products is available on request.

	Catalog Number
Main Switches and Main Switches with Emergency Function 16 A-315 A Maintenance Switches 20 A-315 A Switch Disconnectors 20 A-315 A According to IEC 60947-3, EN 60947-3, VDE 0660 part 107, IEC 60204, EN 60204 and VDE 0113	500
CL Switches 10 A-20 A C, CA and CAD Switches 10 A-315 A and L Switches 350 A-2400 A C, CA and CAD switches are designed for universal application. They are recommended for instrument, isolator, double-throw and motor control. L switches are designed for load and off-load applications. They are used to switch resistive or low inductive loads.	100
Optional Extras and Enclosures The complete product line, a large number of optional extras is available, including door interlocks, push-pull devices, cylinder and padlock attachments, control and indicator devices, AC motor drives, as well as enclosures, both insulated and metal.	101
A and AD Switches 6 A-25 A A and AD switches have 4 contacts in each switching stage. These switches provide an extensive range of switch functions and require a minimum mounting depth. Up to 24 switching positions are possible, with availability of 48 contacts per 12 stage switch column.	110
CG, CH and CHR Switches 10 A-25 A Ultra compact CG, CH and CHR switches are ideally suited for control and instrumentation applications. Switch terminals are “finger-proof” and conveniently accessible for wiring and are delivered open. All CG4 switches offer specially designed gold plated contacts or H-bridges with “cross-wire” contact systems, which facilitates their use in electronic circuitry and chemically aggressive environments.	120
DH, DHR, DK and DKR Switches 6 A-16 A DH, DHR, DK and DKR switches incorporate unique corrosion resistant contacts that permit operation on system voltage as low as 1 V. They have fully enclosed and protected contacts which can be operated either by rotary and/or lateral handle movement. D switches are used in calibration and semiconductor circuits. They are also used for relay and contactor control.	130
X Switches 200 A-630 A X switches can be applied for load, tap and gang switching duties. They incorporate 6 contacts in each switching stage. Their compact design provides a minimum length dimension for mounting purposes.	140
KG Switches 20 A-315 A and KH and KHR Switches 16 A-80 A KG, KH and KHR switches are excellent circuit interruptors. They have high through fault and fault making capacities and are especially designed for use as isolators and safety switches for machine tools, distribution panels and switchboards. KG ON/OFF switches offer unusually high dimensioned air and creepage distances between terminals which are designed for time saving “straight-line” wiring. ON/OFF switches are available with up to 8 poles and double-throw switches are available with up to 4 poles.	150
Contactors 16 A-115 A and Motor Starters 1,1 kW-55 kW These include control relays, motor contactors, two and four pole output contactors, heating contactors, thermal overload relays.	200
Push Buttons and Pilot Lights, 22,5 mm Ø A complete range of state-of-the-art push buttons and pilot lights represent an ideal combination of functional security and economical efficiency in a modular design.	302

Australia

Kraus & Naimer Pty. Ltd.
379 Liverpool Road, ASHFIELD, N.S.W. 2131
Tel: +61 2 9797-7333, Fax: 0092
salesaus@krausnaimer.com

Austria

Kraus & Naimer GmbH
Schumanngasse 35, Postfach 431
A-1181 WIEN
Tel: +43 1 404 06-0, Fax: 404 06-190
aso@krausnaimer.com

Belgium, Luxembourg

Kraus & Naimer B.V.
Ikaros Business Park
Ikaroslaan 2
B-1930 ZAVENTHEM
Tel: +32 2 757-0141, Fax: 1640
sales.be@krausnaimer.com

Brazil

Central and South America
Kraus & Naimer Ind. Com. Ltda.
Rua Santa Monica, 1061
Parque Industrial San Jose
06715-865 Cotia - SP
Tel: +55 11 2198-1288, Fax: 1251
knbrasil@krausnaimer.com.br

Canada

Kraus & Naimer Ltd.
219 Connie Crescent, Unit: 13A
CONCORD, Ontario, L4K 1L4
Tel: +1 905 738-1666, Fax: 9327
salescan@krausnaimer.com

Cyprus

ELECTROMATIC CONSTRUCTIONS LTD.
72, Evagoras Pallikarides Str., CY-2235 LATSIA-Nicosia
P. O. Box 12630, CY-2251 LATSIA-Nicosia
Tel: +357 2 48 41 41, Fax: 48 57 47

Czech Republic

OBZOR, výrobní družstvo Zlín
Na Slanici 378
CZ-76413 ZLÍN
Tel: +420 57 7195-111/-153 (Techn. Supp.)
Fax: +420 57 7195-152/-138
ots@obzor.cz

Denmark

THIIM A/S
Transformervej 31
DK-2730 HERLEV
Tel: +45 4485 8000, Fax: 8005
thiim@thiim.com

Finland

Kraus & Naimer Oy
Karitie 7
FIN-01530 VANTAA
Tel: +358 9 825-424-0, Fax: 424-10
myynti@krausnaimer.com

France

Kraus & Naimer s.a.s.
33, rue Bobillot
F-75013 PARIS
Tél: +33 1 58 40 80 80, Fax: 45 80 91 19
ventes@krausnaimer.com

Germany

Kraus & Naimer GmbH
Wikingerstraße 20-28, D-76189 KARLSRUHE
Postfach 10 01 24, D-76231 KARLSRUHE
Tel: +49 721 59 88-0, Fax: 59 28 28
sales.ger@krausnaimer.com

Great Britain

Kraus & Naimer Ltd.
115 London Road
NEWBURY/BERKSHIRE RG14 2AH
Tel: +44 1635 262626, Fax: 37807
sales-uk@krausnaimer.com

Greece

KALAMARAKIS-SAPOUNAS S. A.
Ionias & Neromilou Str., P. O. Box 46566
GR-13671 ACHARNES/ATHENS
Tel: +30 2 10 240-6000-6, Fax: 240-6007
kalamarakis.sapounas@ksa.gr

Hungary

GANZ, Schalter- u. Gerätefabrik
X. Kőbányal út 41/c, Postfach 87
H-1475 BUDAPEST
Tel: +36 1 261-5479, Fax: 4685
ganzkk@ganzkk.hu

Iceland

BRAEDURNIR ORMSSON EHF
Lágmúli 6-8, P. O. Box 8670
REYKJAVIK
Tel: +354 530-28 00, Fax: 28 10
skuli@ormsson.is

India

Liaison Office, **Kraus & Naimer Pte. Ltd.**
10B, 1st Floor, Infinity,
Ashar Commercial Complex, Gladly Alwares Road
Off Pokhran Road no. 2,
THANE (W) 400 610
Tel: +91 22 66716451, Fax: 66716451
india@krausnaimer.com

Republic of Ireland

Kraus & Naimer Ltd.
Bay 145, Shannon Free Zone
SHANNON, Co. Clare
Tel: +353 61 704700, Fax: 471084
sales-ie@krausnaimer.com

Italy

Kraus & Naimer s.r.l.
Via Terracini, 9
I-24047 TREVIGLIO (BG)
Tel: +39 0363-30 11 12, Fax: 30 21 13
sales-ita@krausnaimer.com

Japan

Kraus & Naimer Ltd.
Yoshiwada Building 2F
1-11-6 Hamamatsucho
Minato-Ku, TOKYO 105-0013
Tel: +81 3 3436-6151, Fax: 6325
sales-jpn@krausnaimer.com

Mexico

JC Ingeniería y Control, SA de CV.
Ángel Gaviño 30,
C. Satélite, C. Medicos,
Naucalpan Edo. de Mexico, C.P. 53100
Tel. (+52 55) 55 62 75 77, Fax. 55 62 04 34
ventas@jcingeneriaycontrol.com

Middle East - UAE

Branch Office, **Kraus & Naimer Pte. Ltd.**
SAIF Zone, P. O. Box 121607,
Sharjah, UAE
Tel: +971 6 557 8886
Fax: +971 6 557 8088
uae@krausnaimer.com

Netherlands

Kraus & Naimer B.V.
Wegtersweg 38-40, Postbus 199
NL-7556 BR HENGEL0 (Ov.)
Tel: +31 74 291-9441, Fax: 8380
sales.nl@krausnaimer.com

New Zealand

Kraus & Naimer Ltd.
42 Miramar Avenue, WELLINGTON 6022
P. O. Box 15-009, WELLINGTON 6243
Tel: +64 4 380-9888, Fax: 9877
sales-nz@krausnaimer.com

Norway

Kraus & Naimer AS
Hjalmar Brantings vei 8, P. O. Box 21, Økern
N-0508 OSLO
Tel: +47 22 64 44 20, Fax: 65 39 49
ordre.no@krausnaimer.com

Poland

ASTAT sp. z o.o.
ul. Dąbrowskiego 461
PL-60451 POZNAN
Tel: +48 61 848-8871/72, Fax: 8276
info@astat.com.pl

Portugal

ELECTRICOL-DAMAS, FERREIRA & DAMASCENO, LDA.
Apartado 1063, S. Ant. Cavaleiros
P-2670 LOURES
Tel: +351 21 989-8939, Fax: 988-6464
Im.emertex@electricol.pt

Singapore

Kraus & Naimer Pte. Ltd.
Blk 115A, Commonwealth Drive
#03-17/23
SINGAPORE 149 596
Tel: +65 6473-8166, Fax: 8643
sgp@krausnaimer.com

Slovenia

SCHRACK Technik d.o.o.
Pameče 175
SI-2380 Slovenj Gradec
Tel: +386 2 883 92 00, Fax: +386 2 884 34 71
m.abeln@schrack.si

Republic of South Africa

Kraus & Naimer Pty. Ltd.
7 Village Crescent, Linbro Village
Linbro Business Park, SANDTON 2065
P. O. Box 511, KELVIN 2054
Tel: +27 11 608-6060, Fax: 608-2874
salesZAF@krausnaimer.com

Spain

HAZEMEYER HES. S.L.
Pol. Ind. Gaserans
Sector 3, Parcela 7B
17451 SANT FELIU DE BUIXALLEU (GIRONA)
Tel: +34 972 87-4450, Fax: 87-4402
hazemeyer@grupo-hes.net

Sweden

Kraus & Naimer AB
Dr. Widerströms Gata 11, FRUÅNGEN
Box 42097, S-126 14 STOCKHOLM
Tel: +46 8 97 00 80, Fax: 97 87 33
order.se@krausnaimer.com

Switzerland

AWAG Elektrotechnik AG
Sandbühlstraße 2, Postfach
CH-8604 VOLKETSCHWIL
Tel: +41 44 908 19 19, Fax: 19 99
info@awag.ch, www.awag.ch

Turkey

KARDEŞ ELEKTRİK SANAYİ VE TİCARET ANONİM ŞİRKETİ
Beşyol, Eski Londra Asfaltı-6
TR-34295 İSTANBUL-Sefaköy
Tel: +90 212 624-9204, Fax: 592-4810
info@unalkardes.com.tr

USA

Kraus & Naimer Inc.
760 New Brunswick Road
SOMERSET, NJ 08873
Tel: +1 732 560-1240, Fax: 8823
salesusa@krausnaimer.com



Kraus & Naimer

BLUE LINE switchgear



YOUR SALES CONTACT



Kraus & Naimer Produktion GmbH

A-1181 Wien · Schumanngasse 31-39 · PF 0046
Telefon: +43 1 404 06 · Telefax: +43 1 404 06 255
knw@krausnaimer.com · www.krausnaimer.com
124765 d · UID-Nr. ATU 14707101