



Kraus & Naimer

BLUE LINE switchgear

since 1907

Catalog 100

02/2013

Control and Load Switches for higher Capacities

CAD, CA and C type up to 315 A
L type up to 2400 A

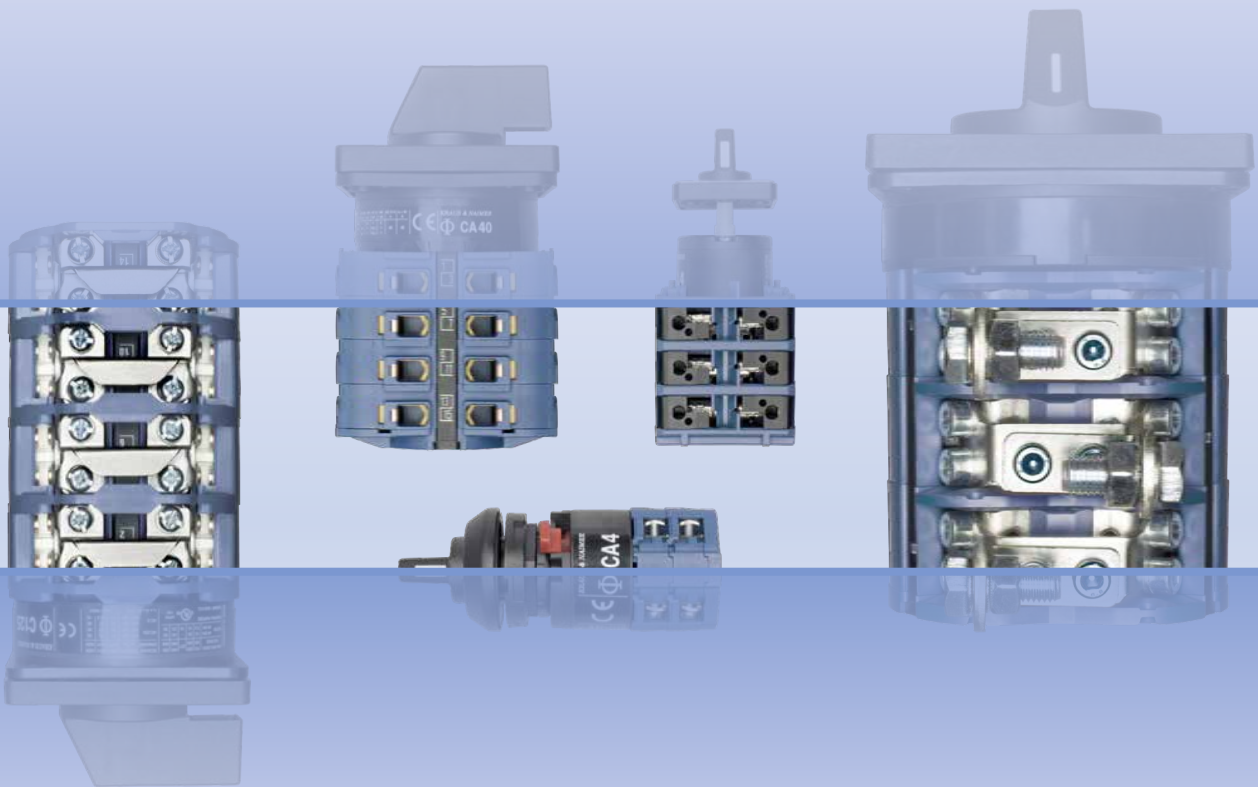

Kraus & Naimer

The development of the Blue Line rotary switch, contactor and motor starter product ranges is based on more than hundred years experience by Kraus & Naimer in the design and manufacture of electrical switchgear. Kraus & Naimer pioneered the introduction of the cam operated rotary switch and continues to be recognized as the world leader in that product field.

BLUE LINE

Blue Line products are protected by numerous patents throughout the industrial world. They are built to national and international standards and designed to withstand adverse temperatures and climates.

Blue Line products are accepted and universally recognized for their quality and workmanship. They are supported by a worldwide sales and service organization.

The Kraus & Naimer Registered Trademark



WORLDWIDE SYMBOL
FOR QUALITY SWITCHGEAR

Disconnectors and Main Switches acc. to IEC 60947-3 see Catalog 500

Contents	Page
Construction Data	2
Dimensions and Nominal Ratings	3
How to order	4, 5
Switch Function and Configuration	
C, CA and CAD Switches 10 A-315 A	
ON/OFF Switches	6, 7
Double-throw Switches	8-10
General Application Switches	10
Coding Switches	11
Multi-step Switches	12-14
Voltmeter Switches	15-17
Ammeter Switches	17-19
Volt-ammeter Switches	19
Control Switches	19, 20
Motor Switches	21-23
L Switches 350 A-2400 A	
ON/OFF Switches	24-26
Double-throw Switches	26-28
Multi-step Switches	29, 30
Types of Mounting	
Panel Mounting	31-35
Base Mounting	36
Wall Mounting	37
Escutcheon Plates	38, 39
Handles	40
International Standards and Approvals	41
Technical Data	42-45
Dimensions	
Panel Mounting	46-50
Base Mounting	50, 51
Wall Mounting	52
Overall Switch Lengths	52, 53
Blue Line Switchgear: Summary	54

Construction Data

The load switches of the C, CA and CAD-series offer a solution for most cam switch applications. Different contact designs, contact materials and terminals allow for their use as control switches, instrumentation switches and motor control switches, as well as in electronic circuitry and in aggressive environments according to IEC 60947-3 and VDE 0660 part 107.

The stage is the basis for all switches and can be supplied with a maximum of 2 contacts. The terminals are accessible from the side. CA and CAD switches are supplied with open terminals to facilitate wiring and are protected against accidental finger contact according to EN 50274, VDE 0660 part 514 and BGV A3. Switches up to type CA25B are supplied with captive screws with clamping plates. The switch types CA40-CA63 are supplied with box terminals. Captive plus-minus terminal screws and integrated screwdriver guides facilitate wiring.

If a positive manual operation or a higher DC rating is required, many of these switches can be fitted with a snap action latching mechanism - suffix „S“ - to the switch type.

The cam-operated switches of the L-series are continuous current rated for off-load switching. They may be used to switch resistive or low inductive loads.

Special Contact Systems

CA4/CA4-1

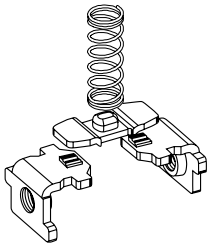

High contact reliability by multiple cross-point contacts, electronic compatible, CA4 with 1 μ and CA4-1 with 35 μ gold plating.

CAD4-1/CAD11/CAD12 (Until 31/12/2012)

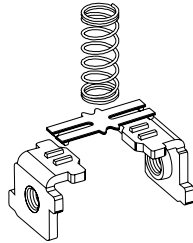

High contact reliability by H-bridge design with "cross-wire" contacts. The contact system with gold-plated contacts (CAD12 with silver contact) allows for low voltages, electronic compatible.

Type	Size	Possible Switching Angles	Max. No. of Stages
CA4, CA4-1, CAD4-1	S00	30°, 45°, 60°, 90°	9
CA10-CA25	S0	30°, 45°, 60°, 90°	12
CA10S-CA25S	S0	60°	on request
CAD11, CAD12	S0	30°, 45°, 60°, 90°	12
CA10B-CA25B	S1	30°, 45°, 60°, 90°	12
C26, C32, C42	S1	20°, 30°, 45°, 60°, 90°	12
C26S, C32S, C42S	S1	60°	on request
CA40, CA50, CA63	S1	30°, 45°, 60°, 90°	12
C43, C80, C125, C200-4	S2	20°, 30°, 45°, 60°, 90°	12
C315	S3	20°, 30°, 45°, 60°, 90°	12
L350/51, L630/31, L1000/01, L1250/51	S2	30°, 45°, 60°, 90°	12
L400, L600, L800, L1200, L1600, L2000	S3	30°, 45°, 60°, 90°	12

CA and CAD Switches (CA4-CA25B)



CA Switches (CA40-CA63)



C Switches



L Switches



Above illustrates the standard terminal positions.

Nominal Ratings

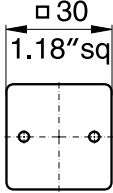
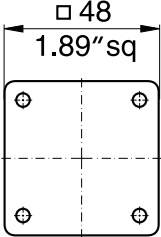
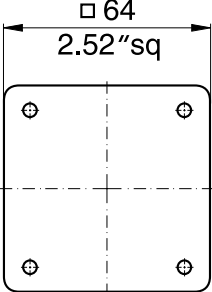
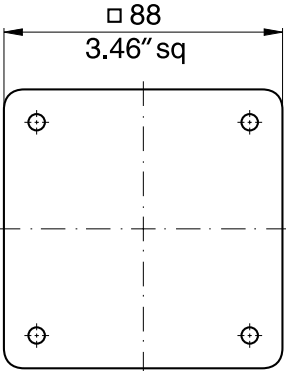
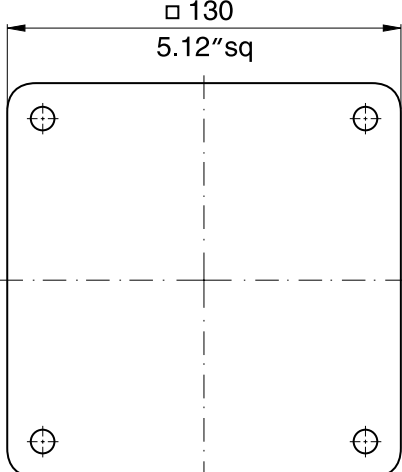
Switch Size	Type	According to IEC 60947-3/VDE 0660 part 107				
		Insulation Voltage ¹ U_i V	Thermal Current I_u/I_{th} A	Motor Rating 3 x 380 V-440 V AC-23 AC-3		
				kW	kW	
S00		CA4	440	10	3	2,2
		CA4-1	440	10	3	2,2
		CAD4-1	440	5	-	-
S0		CA10	690	20	7,5	5,5
		CA11	690	20	7,5	5,5
		CA20	690	25	11	7,5
		CA25	690	32	15	11
		CAD11	600	6	-	-
		CAD12 <small>(Until 31/12/2012)</small>	600	6	-	-
S1		CA10B	690	20	7,5	5,5
		CA11B	690	20	7,5	5,5
		CA20B	690	25	11	7,5
		CA25B	690	32	15	11
		C26	690	32	15	11
		C32	690	50	22	15
		C42	690	63	30	18,5
		CA40	690	40	18,5	15
		CA50	690	50	22	18,5
CA63	690	63	30	18,5		
S2		C43	690	63	30	18,5
		C80	690	115	45	30
		C125	690	150	75	37
		C200-4	690	200	75	37
		L350	690	350	90	37
		L351	690	350	90	37
		L630	690	630 ²	90	37
		L631	690	630 ²	90	37
		L1000	690	1000 ²	90	37
		L1001	690	1000 ²	90	37
		L1250	690	1250 ²	90	37
		L1251	690	1250 ²	90	37
S3		C315	690	315	132	55
		C316³	1000	315	132	55
		L400	690	500	132	55
		L600	690	800 ²	132	55
		L800	690	1100 ²	132	55
		L1200	690	1450 ²	132	55
		L1600	690	1900 ²	132	55
L2000	690	2400 ²	132	55		

For further technical details, refer to pages 42-45.
To furnish with gold contacts and quick connects see page 4.

¹Valid for lines with grounded common neutral termination, overvoltage category III, pollution degree 3. Values for other supply systems on request. ²Ambient temperature 35 °C max. ³Additional switch functions on request.

How to order

Disconnectors and Main Switches according to IEC 60947-3 see Catalog 500

Three types of data (shown below) are required for ordering Blue Line cam-operated switches. Code numbers for ordering are shown in this catalog.

1. Type of Switch

The type of switch required may be easily selected by referring to the table on page 3 which shows the thermal current, power rating and dimensions of each switch. For further technical details, refer to pages 40-43. Variations of contacts and terminals are shown below.

2. Switch Function

The code numbers for standard switches shown on pages 6-28 indicate the switch function, escutcheon plate, handle and any optional extras.

Additional coding to modify type and color of handle and escutcheon plate is explained below.

3. Type of Mounting

Types of mounting are shown on pages 29-35. Catalog 101 describes enclosures and optional extras.

Specify the mounting code to indicate required mounting.

CA10

A202-600

VE

Type of Switch

Extending the switch type coding the following combinations will define:

Amendment	Definition	For switch types
-1	with gold contacts ¹	CA10, CA11, CA10B, CA11B
-4	with quick connects	CA4
B ³	S0 switches with latching mechanism size S1	CAD11, CAD12 (Until 31/12/2012)
C ³	S1 switches with latching mechanism size S2 C26, C32	CA40, CA50, CA63
L	with lockout-relay w/o manual release for std. sw.	CA10, C26, C32, C42, CA40 ² , CA50 ² , CA63 ²
M	with lockout-relay with manual release for std. sw.	CA10, C26, C32, C42, CA40 ² , CA50 ² , CA63 ²
X	with power failure release	CA10, CA11, CA20, CA25, CAD12, C26, C32, C42, CA40 ² , CA50 ² , CA63 ²
Y	with power failure release and trip-free release	CA10, CA11, CA20
S ³	with snap action	CA10, CA11, CA20, CA25 with 60° or 90° switching
		C26, C32, C42, CA40, CA50, CA63 with 60° switching
R	with spring return latching mechanism	CA10

Example: Coding for switch type **CA10** with gold contacts is **CA10-1**.

Modification of Switches

The part number for switch function and options may be modified in cases where items are required other than standard. The modification may involve the escutcheon plate inscription, color combination of escutcheon plate and handle, type of escutcheon plate and handle or the optional extra.

Switch Size	Escutcheon Plate Frame	Handle	Escutcheon Plate Backing	Escutcheon Plate Lettering	Dash Number
S00, S0, S1, S2, S3	black	black	brushed alu	black	-600
S00, S0, S1, S2, S3	black	black	black	mat silver	-700

Other colour combinations available on request.

¹Technical data on request. ²In preparation. ³Additional length for switches with B, C, S, amendments refer page 52.

How to order

Modification of Switches

Color combinations of escutcheon plate and handle

The standard switch consists of a transparent escutcheon plate with brushed aluminum backing and black inscription. The escutcheon plate frame is black as well as the handle. Page 4 shows further color combinations of escutcheon plate and handle which are available. The appropriate dash number must be substituted in the switch function coding to specify other color combinations as required.

Example: The complete coding for switch type CA10 with a 3 pole ON/OFF switch function, electro-gray handle and electro-gray escutcheon plate frame with brushed aluminum backing and black inscription which reads 0-1 is as follows: **CA10 A202-100 E**.

The following is a list of special programs for escutcheon plate and handle combinations. They may be obtained by specifying any one of the following two (2) digit dash numbers as a part of the overall dash number. It is still necessary to prefix these two digit numbers with the first digit which represents the color combination desired.

Special programs for escutcheon plate and handle combinations

- **000** = without escutcheon plate, without handle
- **.01** = without escutcheon plate
- **.02** = without handle
- **.03** = with square escutcheon plate without lettering
- **.04** = with rectangular escutcheon plate without lettering
- **.05** = with square escutcheon plate without lettering and without handle
- **.06** = with rectangular escutcheon plate without lettering and without handle
- **.07** = standard escutcheon plate, without lettering on rectangular section
- **.08** = with F-handle
- **.09** = with P-handle
- **.10** = escutcheon plate frame and fixation ring only (if using switches with single hole mounting: - **.16**)
- **.11** = without escutcheon plate, but with handle bearing plate
- **.12** = with yellow escutcheon plate backing and red handle
- **.14** = with B-handle
- **.16** = escutcheon plate frame and fixation ring only, if using switches with single hole mounting
- **.17** = standard escutcheon plate and rectangular add-on escutcheon plate, if using switches with single hole mounting FT2

Example: The complete coding for switch type CA10 with a 3 pole ON/OFF switch function with electro-gray escutcheon plate frame, square escutcheon plate without lettering, brushed aluminum plate backing and electro-gray handle reads as follows: **CA10 A202-103 E**.

Handles, Escutcheon Plates and Optional Extras

The handles for standard switches shown on pages 6-30 are suitable for mounting units with four hole mounting. Alternative types of handles available are illustrated on page 40, and mounting units on pages 31-37. When a handle, escutcheon plate or optional extra is required but not covered by the dash number, the code number for the selected component should be entered separately. A comprehensive range of available standard escutcheon plates is illustrated on pages 38 and 39. Non-standard or special escutcheon plate engravings are available at extra cost. The large number of optional extras and enclosures is covered in Catalog 101.

Switch Size

Blue Line switches are available in sizes S00, S0, S1, S2 and S3. These size codes indicate the dimensions of the mounting, the escutcheon plate and the handle, as well as the size of optional devices and enclosures. Page 3 lists these sizes and the various switch types they include.

Ordering of Special Switches and Escutcheon Plates

When ordering special switches and escutcheon plates it is advisable to use our order form, as illustrated. The customer's requirements are shown in blue as an example.

For technical reasons, it may not be possible to follow the sequence of contacts requested by the customer. The final contact development which is sent with every switch will show the customer's original terminal markings.

ESCUTCHEON PLATE		CONTACT POSITIONS																																																					
MOTOR 1		1	2	3	4	5	6	7	8	9	10	11	12	13	14	15	16	17	18	19	20	21	22	23	24	25	26	27	28	29	30	31	32	33	34	35	36	37	38	39	40	41	42	43	44	45	46	47							
O						X																																																	
H		X		X		X		X		X		X		X		X		X		X		X		X		X		X		X		X		X		X		X		X		X		X		X		X		X		X		X	
A				X		X		X		X		X		X		X		X		X		X		X		X		X		X		X		X		X		X		X		X		X		X		X		X		X		X	
POSITIONS																																																							

SWITCH TYPE :	CA20	MOUNTING :	VE	FORM :	
ESCUTCHEON PLATE :		OPTIONAL EXTRAS :	MOD/02-1A 0 60		
HANDLE :	G001	DATE :		SIGNED :	

Order forms are available on request.

Switch Function and Configuration

C, CA, CAD Switches

Function	Escutch. Plate	Type/Handle				Code	Stages	Connection Diagram
		CA4 CA4-1 CAD4-1	CAD.. CA10- CA25	CA10B- CA25B	C26 C315			

ON/OFF Switches with 60° Switching

1 pole 2 pole 3 pole 3 pole with red handle 4 pole 4 pole 1 pole preclose 6° ¹ 5 pole 6 pole 7 pole 8 pole 8 pole 2 pole preclose 6° ¹ 9 pole 10 pole 11 pole 12 pole						A200-600 A201-600 A202-600 A202-626 A203-600 WAA653 WAA341 A342-600 A343-600 A344-600 WAA654 WAA345 A346-600 WAA347 A348-600	1 1 2 2 2 2 3 3 4 4 4 4 5 5 6 6	
1 pole 2 pole 3 pole 4 pole 4 pole 1 pole preclose 6° ¹ 5 pole 6 pole 7 pole 8 pole 8 pole 2 pole preclose 6° ¹ 9 pole 10 pole 11 pole 12 pole						A200-620 A201-620 A202-620 A203-620 WAA653 WAA341 A342-620 A343-600 A344-620 WAA654 WAA345 A346-620 WAA347 A348-620	1 1 2 2 2 3 3 4 4 4 4 5 5 6 6	
1 pole 2 pole 3 pole 4 pole 4 pole 1 pole preclose 6° ¹ 5 pole 6 pole						A200-621 A201-621 A202-621 A203-621 WAA653 WAA341 A342-621	1 1 2 2 2 3 3	
1 pole 2 pole 3 pole 4 pole 4 pole 1 pole preclose 6° ¹ 5 pole 6 pole						A200-622 A201-622 A202-622 A203-622 WAA653 WAA341 A342-622	1 1 2 2 2 3 3	
1 pole 2 pole 3 pole 4 pole 4 pole 1 pole preclose 6° ¹ 5 pole 6 pole						A200-623 A201-623 A202-623 A203-623 WAA653 WAA341 A342-623	1 1 2 2 2 3 3	
1 pole 2 pole 3 pole 4 pole 4 pole 1 pole preclose 6° ¹ 5 pole 6 pole						A200-624 A201-624 A202-624 A203-624 WAA653 WAA341 A342-624	1 1 2 2 2 3 3	
1 pole 2 pole 3 pole 4 pole 4 pole 1 pole preclose 6° ¹ 5 pole 6 pole						A200-625 A201-625 A202-625 A203-625 WAA653 WAA341 A342-625	1 1 2 2 2 3 3	

¹for use in a three phase four-wire system with switched neutral

Function	Escutch. Plate	Type/Handle	Code	Stages	Connection Diagram
		CA4 CAD.. CA4-1 CA10- CA10B- C26 CAD4-1 CA25 CA25B C315			

ON/OFF Switches with 90° Switching

1 pole contacts 2 pole preclose 30° 3 pole 4 pole 4 pole 1 pole preclose 60° ¹ 4 pole 3 pole preclose 30° 5 pole contacts 6 pole preclose 30°						A290-600 A291-600 A292-600 A324-600 A293-600 WAA327 WAA325 A326-600	1 1 2 2 2 2 3 3		1, 2, 3, 4, 5 and 6 pole
1 pole contacts 2 pole preclose 30° 3 pole 4 pole 4 pole 1 pole preclose 60° ¹ 4 pole 3 pole preclose 30° 5 pole contacts 6 pole preclose 30°						A290-620 A291-620 A292-620 A324-620 A293-620 WAA327 WAA325 A326-620	1 1 2 2 2 2 3 3		4 pole 1 pole preclose 60°
3 pole 360° rotation						WAA208 WAA208	2 2		
3 pole for foot operation					CA40-CA63	WAA386	2		

ON/OFF Switches with 30° Switching

1 pole 2 pole 3 pole 4 pole						WAA100 WAA101 WAA102 WAA103	1 1 2 2		1-4 pole
1 pole with spring return 2 pole with spring return 3 pole with spring return 4 pole with spring return						A204-600 A205-600 WAA206 WAA207	1 1 2 2		1-4 pole
1 pole with spring return 2 pole with spring return 3 pole with spring return 4 pole with spring return						A204-620 A205-620 WAA206 WAA207	1 1 2 2		

¹for use in a three phase four-wire system with switched neutral ²not available for switch type CA25 ³not available for switch type C315

Function	Escutch. Plate	Type/Handle	Code	Stages	Connection Diagram
		CA4 CAD.. CA4-1 CA10- CA10B- C26 CAD4-1 CA25 CA25B C315			

Double-throw Switches without „OFF“ 60° Switching

1 pole						A220-600	1	
2 pole						A221-600	2	
3 pole						A222-600	3	
4 pole						A223-600	4	
4 pole 1 pole preclose 6° ²						WAA673	4	
5 pole						A369-600	5	
6 pole						A370-600	6	
7 pole						A371-600	7	
8 pole						A372-600	8	
8 pole 2 pole preclose 6° ²						WAA972	8	
9 pole						WAA373	9	
10 pole						WAA374	10	
11 pole					WAA375	11		
12 pole					WAA376	12		

Double-throw Switches without „OFF“ with electrically isolated contacts

1 pole						A720-600	1		
2 pole						A721-600	2		
3 pole						A722-600	3		
4 pole						A723-600	4		
4 pole 1 pole preclose 6° ²					WAA973	4		4 pole 1 pole preclose 6°	
1 pole with spring return						A795-600	1		1 pole with spring return

Double-throw Switches without „OFF“ 30° Switching

1 pole						WAA120	1	
2 pole						WAA121	2	
3 pole						WAA122	3	
4 pole						WAA123	4	
1 pole with spring return						A295-600	1	
2 pole with spring return						A296-600	2	
3 pole with spring return						WAA297	3	
1 pole with spring return						A295-620	1	
2 pole with spring return						A296-620	2	
3 pole with spring return						WAA297	3	

¹not available for switch type CA25 ²for use in a three phase four-wire system with switched neutral

Function	Escutch. Plate	Type/Handle				Code	Stages	Connection Diagram
		CA4 CA4-1 CAD4-1	CAD.. CA10- CA25	CA10B- C43	C80- C315			

Double-throw Switches with Center „OFF“ 60° Switching

1 pole 2 pole 3 pole 4 pole 4 pole 1 pole preclose 6° ³ 5 pole 6 pole 7 pole 8 pole 8 pole 2 pole preclose 6° ³						A210-600 A211-600 A212-600 A213-600 WAA913 A361-600 A362-600 WAA363 WAA364 WAA664	1 2 3 4 5 6 7 8 8	
1 pole 2 pole 3 pole 4 pole 4 pole 1 pole preclose 6° ³ 5 pole 6 pole 7 pole 8 pole 8 pole 2 pole preclose 6° ³						A210-620 A211-620 A212-620 A213-620 WAA913 A361-620 A362-620 WAA363 WAA364 WAA664	1 2 3 4 4 5 6 7 8 8	
1 pole 2 pole 3 pole						A210-621 A211-621 A212-621	1 2 3	
1 pole 2 pole 3 pole						A210-622 A211-622 A212-622	1 2 3	
1 pole 2 pole 3 pole						A210-623 A211-623 A212-623	1 2 3	
1 pole 2 pole 3 pole 4 pole 4 pole 1 pole preclose 6° ³						A210-624 A211-624 A212-624 A213-624 WAA913	1 2 3 4 4	

Double-throw Switches with Center „OFF“ 90° Switching

1 pole 2 pole 3 pole 4 pole 1 pole preclose 60°						A218-600 A219-600 WAA299 WAA294	1 2 3 4	
1 pole 2 pole 3 pole 4 pole 1 pole preclose 60°						A218-620 A219-620 WAA299 WAA294	1 2 3 4	

Double-throw Switches with Center „OFF“ and electrically isolated contacts

1 pole 2 pole 3 pole 4 pole 4 pole 1 pole preclose 6° ³						A710-600 A711-600 A712-600 A713-600 WAA963	1 2 3 4 4	
1 pole with spring return 2 pole to center						A714-600 A715-600	1 2	

¹switch type C315 with handle ²not available for switch type C315 ³for use in a three phase four-wire system with switched neutral

Function	Escutch. Plate	Type/Handle				Code	Stages	Connection Diagram
		CA4 CA4-1 CAD4-1	CAD.. CA10- CA25	CA10B- CA25B	C26 C315			

Double-throw Switches with Spring Return to Center

1 pole with spring return to center						A214-600 A215-600 A216-600	1 2 3	
2 pole						A214-620 A215-620 A216-620	1 2 3	
3 pole								
1 pole with spring return from left to center						A320-600 A321-600 A322-600	1 2 3	
2 pole						A320-621 A321-621 A322-621	1 2 3	
3 pole								

General Application Switches

1 pole 2 Gang 2 pole Switching sequence: 3 pole 0, A, A+B						A310-600 A312-600 WAA314	1 2 3	
1 pole						A310-620 A312-620 WAA314	1 2 3	
2 pole								
3 pole								
1 pole 3 Gang 2 pole Switching sequence: 3 pole 0, A, A+B, A+B+C						A311-600 WAA313 WAA315	2 3 5	
1 pole						A311-620 WAA313 WAA315	2 3 5	
2 pole								
3 pole								
1 pole 2 Gang 2 pole Series switching 3 pole Switching sequence: 0, A, B, A+B						WAA330 WAA331 WAA332	1 2 3	
1 pole						WAA330 WAA331 WAA332	1 2 3	
2 pole								
3 pole								
2 pole 2 Gang Series-parallel Switching						WAA339	2	
Switching sequence: 0, A+B series, A, A+B parallel						WAA339	2	

¹not available for switch type CA25 ²not available for switch type C315 ³available only up to switch type CA63

Switch Function and Configuration

C, CA, CAD Switches

Function	Escutch. Plate	Type/Handle	Code	Stages	Connection Diagram
		CA4 CA10 CA4-1 CAD11 CA10B- C26 CAD4-1 CAD12 CA25B C315			

Coding Switches/Binary Code

0 - 7 360° rotation					A540-600	2	
0 - 7 complement 360° rotation					WAA541	2	
0 - 7 + complement 360° rotation					WAA542	3	
0 - 9					A550-600	2	
0 - 9 complement					WAA551	2	
0 - 9 + complement					WAA552	4	
0 - 11 360° rotation					A543-600	2	
0 - 11 + complement 360° rotation					WAA545	4	

Function	Escutch. Plate	Type/Handle				Code	Stages	Connection Diagram
		CA4 CA4-1 CAD4-1	CAD. CA10- CA25	CA10B- C43	C80- C315			

Multi-step Switches without „OFF“

1 pole 3 Step 2 pole 3 pole 4 pole 5 pole 6 pole						A230-600 A250-600 A270-600 A476-600 WAA484 WAA489	2 3 5 6 8 9	<p>1 pole</p> <p>3 pole</p> <p>4- and 5 pole</p> <p>6 pole</p>
1 pole 4 Step 2 pole 3 pole 4 pole 5 pole 6 pole						A231-600 A251-600 A271-600 A477-600 WAA485 WAA490	2 4 6 8 10 12	<p>1-3 pole</p> <p>4-6 pole</p>
1 pole 5 Step 2 pole 3 pole 4 pole						A232-600 A252-600 WAA272 WAA478	3 5 8 10	<p>1-4 pole</p>
1 pole 6 Step 2 pole 3 pole						A233-600 WAA253 WAA273	3 6 9	<p>1 and 2 pole</p> <p>3 pole</p>
1 pole 7 Step 2 pole 3 pole						WAA234 WAA254 WAA274	4 7 11	<p>1-3 pole</p>
1 pole 8 Step 2 pole 3 pole						WAA235 WAA255 WAA275	4 8 12	<p>1-3 pole</p>
1 pole 9 Step						WAA236	5	
1 pole 10 Step						WAA237	5	
1 pole 11 Step						WAA238	6	
1 pole 12 Step 1 pole 360° rotation						WAA239 WAA639	6 6	

¹switch type C315 with handle ²not available for switch type CA11B

Function	Escutch. Plate	Type/Handle				Code	Stages	Connection Diagram
		CA4 CA4-1 CAD4-1	CAD.. CA10- CA25	CA10B- C43	C80- C315			

Multi-step Switches without „OFF“ with electrically isolated contacts

1 pole 3 Step						A730-600	2	 1 pole
2 pole						A750-600	3	 2 pole
1 pole 4 Step						A731-600	2	 1 pole
2 pole						A751-600	4	 2 pole

Multi-step Switches with „OFF“

1 pole 2 Step						A240-600	1	 1-6 pole
2 pole						A260-600	2	
3 pole						A280-600	3	
4 pole						WAA480	4	
5 pole						WAA486	5	
6 pole						WAA491	6	
1 pole						A240-620	1	1-6 pole
2 pole						A260-620	2	
3 pole						A280-620	3	
4 pole						WAA480	4	
5 pole						WAA486	5	
6 pole						WAA491	6	
1 pole 3 Step						A241-600	2	 1 and 2 pole
2 pole						A261-600	3	
3 pole						A281-600	5	
4 pole						WAA481	6	
5 pole						WAA487	8	
							A241-620	
1 pole						A241-620	2	3 pole
2 pole						A261-620	3	
3 pole						A281-620	5	
4 pole						WAA481	6	
5 pole						WAA487	8	
							A241-621	
1 pole						A241-621	2	4 pole
2 pole						A261-621	3	
							A261-621	
								 5 pole

Switch Function and Configuration

C, CA, CAD Switches

Function	Escutch. Plate	Type/Handle				Code	Stages	Connection Diagram
		CA4 CA4-1 CAD4-1	CAD. CA10- CA25	CA10B- C43	C80- C315			

Multi-step Switches with „OFF“

1 pole 4 Step						A242-600 WAA262 WAA282 WAA482	2 4 6 8	
1 pole 4 Step						A242-620 WAA262 WAA282 WAA482	2 4 6 8	
1 pole 5 Step						A243-600 WAA263 WAA283	3 5 8	
1 pole 5 Step						A243-620 WAA263 WAA283	3 5 8	
1 pole 6 Step						A244-600 WAA264 WAA284	3 6 9	
1 pole 6 Step						A244-620 WAA264 WAA284	3 6 9	
1 pole 7 Step						WAA245 WAA265	4 7	
1 pole 7 Step						WAA245 WAA265	4 7	
1 pole 8 Step						WAA246	4	
1 pole 8 Step						WAA246	4	
1 pole 9 Step						WAA247	5	
1 pole 9 Step						WAA247	5	
1 pole 10 Step						WAA248	5	
1 pole 10 Step						WAA248	5	
1 pole 11 Step						WAA249 WAA649	6 6	
1 pole 11 Step						WAA249 WAA649	6 6	

Switch Function and Configuration

C, CA, CAD Switches

Function	Escutch. Plate	Type/Handle	Code	Stages	Connection Diagram
	CA4 CA4-1 CAD4-1	CA10- CAD.. CA10B- CA25 CA25B			

Voltmeter Switches without „OFF“

3 phase 3 wire						A023-600	2	
						A023-620	2	
3 phase 3 wire 3 phase to phase and phase to neutral						A025-600	3	
						A025-620	3	

Voltmeter Switches with „OFF“

2 pole 360° rotation						WAA002	1	
3 phase 3 wire						A004-600	2	
						A004-620	2	
						A004-621	2	
						A004-622	2	
						A004-623	2	
						A004-624	2	
						WAA011	2	

Function	Escutch. Plate	Type/Handle	Code	Stages	Connection Diagram
		CA4 CA4-1 CA10- CAD.. CA10B- CAD4-1 CA25 CA25B			

Voltmeter Switches with „OFF“

3 phase to neutral						WAA005	2	
						WAA005	2	
						WAA005	2	
						WAA005	2	
						WAA005	2	
3 phase to phase and 3 phase to neutral						A007-600	3	
						A007-620	3	
						A007-621	3	
						A007-622	3	
						A007-623	3	
						A007-624	3	
2 separate 3 phase with center „OFF“						WAA008	4	
						WAA008	4	
						WAA008	4	
						WAA008	4	

Function	Escutch. Plate	Type/Handle	Code	Stages	Connection Diagram
		CA4 CAD.. CA4-1 CA10- CA10B- C43 CAD4-1 CA25 C32 C125			

Voltmeter Switches with „OFF“

3 phase and 1 phase to neutral					WAA010	3	
					WAA010	3	
					WAA010	3	
					WAA010	3	

Ammeter Switches

Single pole with one current transformer					WAA046	1	
					WAA046	1	
					WAA046	1	
Single pole with 3 current transformers without „OFF“					A017-600	3	
					A017-620	3	
Single pole with 3 current transformers with „OFF“ 360° rotation					A048-600	3	
					A048-620	3	
					A048-621	3	
					A048-622	3	
					A048-623	3	

¹available only up to switch type CA25B

Function	Escutch. Plate	Type/Handle				Code	Stages	Connection Diagram
		CA4 CA4-1 CAD4-1	CAD. CA10- CA25	CA10B- C42	C43 C125			

Ammeter Switches

Single pole with 2 current transformers (3 readings)					A021-600	2	
					A021-620	2	
Single pole with 4 current transformers					WAA036	4	
					WAA036	4	
2 pole 2 current transformers					WAA037	3	
					WAA037	3	
					WAA037	3	
2 pole 3 current transformers					WAA019	5	
					WAA019	5	
					A038-600	5	
2 pole 3 current transformers					A038-620	5	
					A038-621	5	
					A038-621	5	
2 pole 4 current transformers					WAA039	6	
					WAA039	6	

¹available only up to switch type CA25B

Switch Function and Configuration

C, CA, CAD Switches

Function	Escutch. Plate	Type/Handle	Code	Stages	Connection Diagram
		CA4 CAD. CA4-1 CA10- CA10B- C26 CAD4-1 CA25 CA25B C43			

Volt-ammeter Switches

3 phase - phase to phase 3 current						WAA027	6	
							WAA028	7
3 phase voltage 3 phase current 4 wire						WAA033	5	
3 phase voltage 3 phase current 3 wire						WAA035	5	

Control Switches

Stop switch						WAA174	1	
Start switch						A175-600	1	
Stop start switch single pole						A176-600	1	
Stop start switch 2 pole						WAA183	2	
Stop start switch with spring return from start to run						A178-600	1	
						A178-620	1	
Stop start switch with spring return to run for 2 units						WAA177	2	
						WAA177	2	

¹available only up to switch type CA50

Function	Escutch. Plate	Type/Handle				Code	Stages	Connection Diagram
		CA4 CA4-1 CAD4-1	CAD. CA10- CA25	CA10B- CA25B	C26 C32			

Control Switches

Stop start switch with spring return to run with contactor interlock contactors for 2 units						WAA182	2	
						WAA182	2	
Motor voltage control switch						WAA150	2	

Control Switches with electrically isolated contacts

Stop start switch single pole						A789-600	1	
Stop start switch with spring return to 1						A791-600	1	
Stop start switch with spring return to run for 2 units						WAA790	2	
Contactor control with spring return to „OFF“						WAA179	2	
						WAA179	2	
Circuit breaker control						WAA537	2	

Control and Alarm Switches¹

With slip clutch and without indicator device						WAA190	5 ³	
Without indicator device						WAA192	2	

¹Advise the indicator device, described in Catalog 101, page 7. ²not available for switch types CA25 and CA25B ³incl. slip clutch ⁴available only up to switch type CA40

Function	Escutch. Plate	Type/Handle				Code	Stages	Connection Diagram
		CA4 CA4-1 CAD4-1	CAD.. CA10- CA25	CA..B C26 C43	C80- C315			

Motor Reversing Switches

2 pole						A400-600	2	
						A400-620	2	
						A400-621	2	
3 pole						A401-600	3	
						A401-620	3	
						A401-621	3	
3 pole with spring return to „OFF“						A228-600	3	
						A228-620	3	
3 pole for use with reversing contactors						WAA402	4	

Motor Control Switches

2 speed 2 winding 0-A-B Υ or Δ						WAA451	3	
						WAA451	3	
3 speed 2 winding 0-A Δ -B Υ -A $\Upsilon\Upsilon$						WAA457	6	
						WAA457	6	

¹not available for switch type CA25 ²not available for switch types CA40-CA63 ³available only up to switch type CA50

Function	Escutch. Plate	Type/Handle	Code	Stages	Connection Diagram
		CA4 CAD.. CA4-1 CA10- CA10B- C26 CAD4-1 CA25 CA25B C315			

Motor Control Switches

2 speed single winding						A440-600	4	
						A440-620	4	
2 speed single winding without „OFF“						A466-600	4	
2 speed single winding with center „OFF“						A441-600	4	
						A441-620	4	
2 speed single winding reversing						A442	6	
						A442	6	
2 speed single winding for use with contactors						WAA444	5	
						WAA444	5	
2 speed reversing for 2 way operation with slip clutch for „OFF“ load use						WAA468	10 ¹	
						WAA468	10 ¹	

¹incl. slip clutch

Function	Escutch. Plate	Type/Handle				Code	Stages	Connection Diagram
		CA4 CA4-1 CAD4-1	CAD.. CA10- CA25	CA..B C26 C43	C80- C315			

Star-delta Switches

OFF-star-delta						A410-600	4	
						A410-620	4	
Reversing						WAA413	5	
With auxiliary contact closed in „OFF“ position						WAA416	5	
For use with reversing contactors						A419-600	4	

Start and Run Switches

Split-phase start						A425-600	2	
						A425-620	2	
Split-phase start reversing						WAA426	3	
						WAA426	3	
Split-phase reversing auto cutout of start field winding						WAA622	3	

¹not available for switch type CA25

Switch Function and Configuration

L Switches

Function/Type	Escutch. Plate	Handle	Code	Stages	Double Latching	Connection Diagram	L350 L630 L1000 L1250	L351 L631 L1001 L1251
---------------	----------------	--------	------	--------	-----------------	--------------------	--------------------------------	--------------------------------

ON/OFF Switches with 60° Switching

1 pole 2 pole 3 pole 4 pole	L350/			WAA200-600 WAA201-600 WAA202-600 WAA203-600	1 2 3 4			1-4 pole
1 pole 2 pole 3 pole 4 pole	L351			WAA200-600 WAA201-600 WAA202-600 WAA203-600	1 2 3 4			1-4 pole
1 pole 2 pole 3 pole 4 pole	L400			WAA200-600 WAA201-600 WAA202-600 WAA203-600	2 2 4 4			1-4 pole
3 pole with lugs suitable for protective cover				WAA302-600	3			A302
1 pole 2 pole 3 pole 4 pole	L400			WAA200-600 WAA201-600 WAA202-600 WAA203-600	2 2 4 4			A302
1 pole 2 pole 3 pole 4 pole	L600			WAA200-600 WAA201-600 WAA202-600 WAA203-600	3 3 6 6			1-4 pole
1 pole 2 pole 3 pole 4 pole	L630			WAA200-600 WAA201-600 WAA202-600 WAA203-600	2 4 6 8	● ●		1-4 pole
1 pole 2 pole 3 pole 4 pole	L631			WAA200-600 WAA201-600 WAA202-600 WAA203-600	2 4 6 8	● ●		1-4 pole
1 pole 2 pole 3 pole 4 pole	L800			WAA200-600 WAA201-600 WAA202-600 WAA203-600	2 4 6 8			1-4 pole
1 pole 2 pole 3 pole 4 pole	L1000			WAA200-600 WAA201-600 WAA202-600 WAA203-600	3 6 9 12	● ● ●		1-4 pole
1 pole 2 pole 3 pole 4 pole	L1001			WAA200-600 WAA201-600 WAA202-600 WAA203-600	3 6 9 12	● ● ●		1-4 pole
1 pole 2 pole 3 pole	L1200			WAA200-600 WAA201-600 WAA202-600	3 6 9			1-3 pole
1 pole 2 pole 3 pole	L1250			WAA200-600 WAA201-600 WAA202-600 WAA203-600	4 8 12	● ●		1-3 pole

Switch Function and Configuration

L Switches

Function/Type	Escutch. Plate	Handle	Code	Stages	Double Latching	Connection Diagram	L350 L630 L1000 L1250	L351 L631 L1001 L1251
---------------	----------------	--------	------	--------	-----------------	--------------------	--------------------------------	--------------------------------

ON/OFF Switches with 60° Switching

1 pole 2 pole 3 pole	L1251			WAA200-600 WAA201-600 WAA202-600 WAA203-600	4 8 12	● ●		1-3 pole
1 pole 2 pole 3 pole	L1600			WAA200-600 WAA201-600 WAA202-600	4 8 12			1-3 pole
1 pole 2 pole	L2000			WAA200-600 WAA201-600	5 10	●		1 and 2 pole

ON/OFF Switches with 90° Switching

1 pole 2 pole 3 pole 4 pole	L350 1 pole preclose 60°			WAA290-600 WAA291-600 WAA292-600 WAA293-600	1 2 3 4			1-4 pole
1 pole 2 pole 3 pole 4 pole	L351 1 pole preclose 60°			WAA290-600 WAA291-600 WAA292-600 WAA293-600	1 2 3 4			1-4 pole
1 pole 2 pole 3 pole 4 pole	L400 1 pole preclose 60°			WAA290-600 WAA291-600 WAA292-600 WAA293-600	2 2 4 4			1-3 pole 4 pole
3 pole	with lugs suitable for protective cover			WAA307-600	3			1-3 pole
3 pole	360° rotation			WAA208-600	4			A307
1 pole 2 pole 3 pole 4 pole	L600 1 pole preclose 60°			WAA290-600 WAA291-600 WAA292-600 WAA293-600	3 3 6 6			1-3 pole 4 pole
1 pole 2 pole 3 pole 4 pole	L630 1 pole preclose 60°			WAA290-600 WAA291-600 WAA292-600 WAA293-600	2 4 6 8			1-3 pole 4 pole
1 pole 2 pole 3 pole 4 pole	L631 1 pole preclose 60°			WAA290-600 WAA291-600 WAA292-600 WAA293-600	2 4 6 8			1-3 pole 4 pole
1 pole 2 pole 3 pole 4 pole	L800 1 pole preclose 60°			WAA290-600 WAA291-600 WAA292-600 WAA293-600	2 4 6 8	● ● ●		1-3 pole 4 pole

- Additional length for switches size S2 for mounting E/EF = 27 mm
- Additional length for switches size S3 for mounting E/EF = 31,5 mm and mounting ER/VE = 20,1 mm

Switch Function and Configuration

L Switches

Function/Type	Escutch. Plate	Handle	Code	Stages	Double Latching	Connection Diagram	L350 L630 L1000 L1250	L351 L631 L1001 L1251
---------------	----------------	--------	------	--------	-----------------	--------------------	--------------------------------	--------------------------------

ON/OFF Switches with 90° Switching

1 pole 2 pole 3 pole 4 pole	L1000			WAA290-600 WAA291-600 WAA292-600 WAA293-600	3 6 9 12	● ● ●		
1 pole 2 pole 3 pole 4 pole	L1001			WAA290-600 WAA291-600 WAA292-600 WAA293-600	3 6 9 12	● ● ●		
1 pole 2 pole 3 pole	L1200			WAA290-600 WAA291-600 WAA292-600	3 6 9	● ● ●		1-3 pole
1 pole 2 pole 3 pole	L1250			WAA290-600 WAA291-600 WAA292-600 WAA293-600	4 8 12	● ●		1-3 pole
1 pole 2 pole 3 pole	L1251			WAA290-600 WAA291-600 WAA292-600 WAA293-600	4 8 12	● ●		1-3 pole
1 pole 2 pole 3 pole	L1600			WAA290-600 WAA291-600 WAA292-600	4 8 12	● ● ●		1-3 pole
1 pole 2 pole	L2000			WAA290-600 WAA291-600	5 10	● ●		1- and 2 pole

Double-throw Switches without „OFF“ 60° Switching

1 pole 2 pole 3 pole 4 pole	L350			WAA220-600 WAA221-600 WAA222-600 WAA223-600	2 4 6 8			1-4 pole
1 pole 2 pole 3 pole 4 pole	L351			WAA220-600 WAA221-600 WAA222-600 WAA223-600	2 4 6 8			1-4 pole
1 pole 2 pole 3 pole 4 pole	L400			WAA220-600 WAA221-600 WAA222-600 WAA223-600	2 4 6 8			1-4 pole
1 pole 2 pole 3 pole 4 pole	L600			WAA220-600 WAA221-600 WAA222-600 WAA223-600	3 6 9 12	● ●		1-4 pole
1 pole 2 pole 3 pole	L630			WAA220-600 WAA221-600 WAA222-600	4 8 12	●		1-3 pole

Function/Type	Escutch. Plate	Handle	Code	Stages	Double Latching	Connection Diagram	L350 L630 L1000 L1250	L351 L631 L1001 L1251
---------------	----------------	--------	------	--------	-----------------	--------------------	--------------------------------	--------------------------------

Double-throw Switches without „OFF“ 60° Switching

1 pole 2 pole 3 pole	L631			WAA220-600 WAA221-600 WAA222-600	4 8 12	●		1-3 pole
1 pole 2 pole 3 pole	L800			WAA220-600 WAA221-600 WAA222-600	4 8 12	●		1-3 pole
1 pole 2 pole	L1000			WAA220-600 WAA221-600	6 12	●		1 and 2 pole
1 pole 2 pole	L1001			WAA220-600 WAA221-600	6 12	●		1 and 2 pole
1 pole	L1200			WAA220-600	6			
1 pole	L1250			WAA220-600	8			
1 pole	L1251			WAA220-600	8			
1 pole	L1600			WAA220-600	8			
1 pole	L2000			WAA220-600	10			

Double-throw Switches with Center „OFF“

1 pole 2 pole 3 pole 4 pole	L350			WAA210-600 WAA211-600 WAA212-600 WAA213-600	2 4 6 8			1-4 pole
1 pole 2 pole 3 pole 4 pole	L351			WAA210-600 WAA211-600 WAA212-600 WAA213-600	2 4 6 8			1-4 pole
1 pole 2 pole 3 pole 4 pole	L400			WAA210-600 WAA211-600 WAA212-600 WAA213-600	2 4 6 8			1-4 pole

- Additional length for switches size S2 for mounting E/EF = 27 mm
- Additional length for switches size S3 for mounting E/EF = 31,5 mm and mounting ER/VE = 20,1 mm

Switch Function and Configuration

L Switches

Function/Type	Escutch. Plate	Handle	Code	Stages	Double Latching	Connection Diagram	L350 L630 L1000 L1250	L351 L631 L1001 L1251
---------------	----------------	--------	------	--------	-----------------	--------------------	--------------------------------	--------------------------------

Double-throw Switches with Center „OFF“

1 pole 2 pole 3 pole 4 pole	L600			WAA210-600 WAA211-600 WAA212-600 WAA213-600	3 6 9 12	● ●		1-4 pole
1 pole 2 pole 3 pole	L630			WAA210-600 WAA211-600 WAA212-600	4 8 12	●		1-3 pole
1 pole 2 pole 3 pole	L631			WAA210-600 WAA211-600 WAA212-600	4 8 12	●		1-3 pole
1 pole 2 pole 3 pole	L800			WAA210-600 WAA211-600 WAA212-600	4 8 12	●		1-3 pole
1 pole 2 pole	L1000			WAA210-600 WAA211-600	6 12	●		1 and 2 pole
1 pole 2 pole	L1001			WAA210-600 WAA211-600	6 12	●		1 and 2 pole
1 pole	L1200			WAA210-600	6			
1 pole	L1250			WAA210-600	8			
1 pole	L1251			WAA210-600	8			
1 pole	L1600			WAA210-600	8			
1 pole	L2000			WAA210-600	10			

Multi-step Switches single pole without „OFF“

3 Step	L350			WAA230-600	4			
3 Step	L351			WAA230-600	4			
3 Step	L400			WAA230-600	4			

Function/Type	Escutch. Plate	Handle	Code	Stages	Double Latching	Connection Diagram	L350 L630 L1000 L1250	L351 L631 L1001 L1251
---------------	----------------	--------	------	--------	-----------------	--------------------	--------------------------------	--------------------------------

Multi-step Switches single pole without „OFF“

4 Step	L350			WAA231-600	4			
4 Step	L351			WAA231-600	4			
4 Step	L400			WAA231-600	4			
5 Step	L350			WAA232-600	6			
5 Step	L351			WAA232-600	6			
5 Step	L400			WAA232-600	6			
6 Step	L350			WAA233-600	6			
6 Step	L351			WAA233-600	6			
6 Step	L400			WAA233-600	6			
7 Step	L350			WAA234-600	8			
7 Step	L351			WAA234-600	8			
7 Step	L400			WAA234-600	8			
8 Step	L350			WAA235-600	8			
8 Step	L351			WAA235-600	8			
8 Step	L400			WAA235-600	8			

Switch Function and Configuration

L Switches

Function/Type	Escutch. Plate	Handle	Code	Stages	Double Latching	Connection Diagram	L350 L630 L1000 L1250	L351 L631 L1001 L1251
---------------	----------------	--------	------	--------	-----------------	--------------------	--------------------------------	--------------------------------



Multi-step Switches single pole without „OFF“

9 Step	L350			WAA236-600	10			
9 Step	L351			WAA236-600	10			
9 Step	L400			WAA236-600	10			
10 Step	L350			WAA237-600	10			
10 Step	L351			WAA237-600	10			
10 Step	L400			WAA237-600	10			
11 Step	L350			WAA238-600	12			
11 Step	L351			WAA238-600	12			
11 Step	L400			WAA238-600	12			
12 Step	L350			WAA239-600	12			
12 Step	L351			WAA239-600	12			
12 Step	L400			WAA239-600	12			

Two Hole Panel Mount or Mosaic Mount	Terminals rotated 90°	Code	CA4 CA4-1 CAD4-1
--------------------------------------	-----------------------	-------------	------------------------

<p>Panel Mount</p> <div data-bbox="156 566 395 775">  </div> <p>Two hole</p> <div data-bbox="150 875 384 1077">  </div> <p>Two hole Protection IP 66</p> <div data-bbox="156 1216 363 1391">  </div> <p>Two hole with shaft for radio knobs Shaft diam. 6 mm/.24 inch</p> <p>Shaft diam. 6.35 mm/.25 inch</p>		<p>●</p> <p>●</p> <p>●</p> <p>●</p>	<p>E E-V</p> <p>EF EF-V</p> <p>E9</p> <p>E91</p>	<p>●</p> <p>●</p> <p>●</p> <p>●</p>
<p>Mosaic Mount</p> <div data-bbox="150 1653 421 1839">  </div> <p>For Siemens-Mosaic 30 mm grid depth</p> <div data-bbox="150 1839 421 2040">  </div> <p>For Subklew-, Kreutzenbeck-, Symo-Mosaic 28 mm 25 mm 25 mm grid depth</p> <p>For Mauell-Mosaic 30 mm grid depth</p>			<p>E92</p> <p>E93</p> <p>E94</p>	<p>●</p> <p>●</p> <p>●</p>

Two or Four Hole Panel Mount	Terminals rotated 90°	Code	CAD.. CA10- CA25	CA10B- CA63 C42	C43 C80- C200-4 L350- L1251 Size S2	C315 L400- L2000 Size S3
------------------------------	-----------------------	------	------------------------	-----------------------	--	-----------------------------------

<p>Panel Mount</p>  <p>Four hole</p> <p>Four hole Protection IP 66</p> <p>Two hole Protection IP 65</p> <p>Panel mount using larger escutcheon plate, handle and heavy duty stop</p>  <p>Four hole</p> <p>Four hole Protection IP 66</p>	<p>●</p> <p>●</p> <p>●</p> <p>●</p> <p>●</p>	<p>E E-V</p> <p>EF EF-V</p> <p>E22 E22-V</p> <p>EG</p> <p>EGF</p>	<p>●</p> <p>●</p> <p>●</p> <p>●</p> <p>●</p>	<p>●</p> <p>●</p> <p>●</p> <p>CA40- CA63</p> <p>CA40- CA63</p>	<p>●</p> <p>●</p> <p>●</p> <p>C80- C200-4</p> <p>C80- C200-4</p>	<p>●</p> <p>●</p> <p>●</p> <p>●</p> <p>●</p>
<p>Double End Mount</p>  <p>Four hole</p> <p>Four hole Protection IP 66</p>	<p>●</p> <p>●</p>	<p>ER</p> <p>ERF</p>	<p>●</p> <p>●</p>	<p>●</p> <p>●</p>	<p>●</p> <p>●</p>	<p>●</p> <p>●</p>



Two or Four Hole Panel Mount	Code	CAD.. CA10- CA25	CA10B CA11B CA20B CA25B	C32 C42 CA40 CA50 CA63	C43
-------------------------------------	-------------	------------------------	----------------------------------	------------------------------------	-----

	<p>Panel mount with heavy duty latching and metal shaft</p> <p>Four hole 48 x 48 Plate – S0</p>	KN2	●			
	<p>Four hole 64 x 64 Plate – S1</p> <p>Four hole 64 x 64 Plate – S1 complete with 6mm square metal shaft</p>	KN1 KD1	● ●	● ●	● ●	
	<p>Panel mount with protective cover</p> <p>Four hole Protection front IP 40 rear IP 30</p> <p>Four hole with additional shaft seal Protection front IP 65 rear IP 30</p> <p>Four hole Protection front IP 40 rear IP 42</p> <p>Four hole with additional shaft seal Protection front IP 65 rear IP 42</p> <p>Two hole Protection front IP 65 rear IP 42</p>	EC ED EC1 ED1 ED22	CAD.. CA10- CA25	● ● ● ●		CAD.. CA10- CA25

Single Hole Mount	Terminals rotated 90°	Code	CA4 CA4-1 CAD4-1	CAD.. CA10- CA25
-------------------	-----------------------	------	------------------------	------------------------

			mm	mm
 <p>Single Hole Mount complete with lock nut and shaft seal Bezel mount Protection IP 66</p>	●	FS1 FS1-V FT1 FT1-V FT3 FT3-V	16/22 16/22	22 22 22/30 22/30
 <p>Square escutcheon plate</p>	●	FS2 FS2-V FT2 FT2-V FT4 FT4-V	16/22 16/22	22 22 22/30 22/30
<p>S1 square escutcheon plate and heavy duty stop</p>	●	FH3 FH3-V		22 22
 <p>Rectangular escutcheon plate</p>	●	FS4 FS4-V FT6 FT6-V	16/22 16/22	22 22
<p>S1 rectangular escutcheon plate and heavy duty stop</p>	●	FH4 FH4-V		22 22
 <p>Lock nut spanner</p>		S00 T170 09		

Base Mount	Terminals rotated 90°	Code	CAD.. CA10- CA25	CA10B- CA63 C42	C43 C80- L2000
------------	-----------------------	------	------------------------	-----------------------	----------------------

Base Mount						
	<p>Four hole</p> <p>Four hole with integrated simplified door clutch, protection IP 65</p>	<p>●</p> <p>●</p>	<p>VE VE-V</p> <p>VF VF-V</p>	<p>CAD.. CA10- CA25</p> <p>CAD.. CA10- CA25</p>	<p>●</p> <p>●</p>	<p>●</p>
	<p>Two hole</p> <p>Two hole with integrated simplified door clutch, protection IP 65</p>	<p>●</p> <p>●</p>	<p>VE22 VE22V</p> <p>VF22 VF22V</p>	<p>● CAD.. CA10- CA25</p> <p>● CAD.. CA10- CA25</p>	<p>●</p>	<p>●</p>
	<p>Snap-on for DIN Rail EN 60715</p>		<p>VE1</p>	<p>●</p>	<p>●</p>	

Base Mount	Code	CA4 CA4-1 CAD4-1	CAD.. CA10- CA25
-------------------	-------------	------------------------	------------------------

DIN Rail Mount



Snap-on for DIN Rail EN 60715 with escutcheon plate for 45 mm standard knock-out.

VE2



Snap-on for DIN Rail EN 60715. With escutcheon plate for 45 mm standard knock-out. The handle and plate are adjustable in height.

VE21





CAD..
CA10-
CA20

VE21V

CA25

<p>Mounting Plates for Plaster Depth Boxes acc. to DIN 49070 and ÖNORM E6508</p>	<p>Code</p>	<p>CAD.. CA10- CA25</p>
--	-------------	---------------------------------

 <p>A white square switch plate with a rotary knob. The knob has three positions labeled 1, 0, and 2. Position 0 is at the top, 1 is to the left, and 2 is to the right. Below the knob is a small circular button with an upward-pointing arrow and a lightning bolt symbol.</p>	<p>Plaster depth trim</p>	<p>UE1</p>	<p>●</p>
 <p>A white square switch plate with a rotary knob and a red indicator light. The knob has three positions labeled 1, 0, and 2. Position 0 is at the top, 1 is to the left, and 2 is to the right. Below the knob is a small circular button with an upward-pointing arrow and a lightning bolt symbol.</p>	<p>With light</p>	<p>UE2</p>	<p>●</p>
 <p>A white square switch plate with a rotary knob and a red indicator light. The knob has three positions labeled 1, 0, and 2. Position 0 is at the top, 1 is to the left, and 2 is to the right. Below the knob is a small circular button with an upward-pointing arrow and a lightning bolt symbol.</p>	<p>With facility for light addition</p>	<p>UE3</p>	<p>●</p>

Escutcheon Plates



Square and rectangular escutcheon plates are available for each size of switch. The escutcheon plate consists of a frame and a faceplate having the switch positions which is then embossed with hot-foil backing. The escutcheon plate frame is an essential part of the switch and serves as a bearing surface for the handle. If the switch is to be mounted without an escutcheon plate we would recommend for size S1, S2 and S3 the handle bearing plate T100-04.

Standard Letterings Available

(Over 500 standard letterings, special letterings upon request.)

30° switching

45° switching

Escutcheon Plates

60° switching

F070	F087	F088	F089	F133	F197	F198	F232	F243	F247	F263	F268	F310	F311	F323	F328	F352	F367
F379	F380	F470	F754	F072	F163	F164	F192	F193	F196	F230	F231	F234	F244	F257	F262	F264	F282
F288	F291	F313	F382	F441	F705	F721	F722	F750	F757	F758	F075	F076	F098	F220	F223	F356	F357
F377	F723	F071	F073	F080	F081	F085	F086	F090	F091	F092	F093	F094	F104	F194	F235	F237	F239
F240	F241	F249	F260	F269	F274	F281	F290	F292	F312	F314	F315	F316	F324	F331	F344	F354	F358
F359	F364	F370	F371	F373	F381	F385	F442	F444	F469	F732	F735	F759	F077	F100	F101	F102	F309
F342	F343	F361	F362	F363	F365	F366	F078	F191	F325	F326	F720	F074	F082	F096	F097	F195	F724
F256	F079	F083	F084	F095	F099	F185	F190	F199	F233	F236	F238	F242	F283	F725	F730	F731	F736
F737																	

90° switching

F056	F063	F068	F134	F201	F251	F252	F346	F456	F058	F065	F069	F177	F178	F182	F208	F253	F254
F340	F360	F378	F458	F443	F700	F743	F057	F061	F064	F067	F171	F181	F205	F207	F209	F320	F349
F437	F445	F715	F719	F059	F060	F062	F066	F170	F172	F173	F174	F175	F176	F179	F180	F186	F188
F202	F204	F206	F250	F265	F266	F286	F318	F327	F338	F339	F425	F716	F717	F718	F726	F733	F751
F755	F756																

Miscellaneous

F119	F130	F122	F126	F125	F129	F225	F248	F246	F261	F341	F345	F287	F123	F127	F145	F146	F148						
F706	F707	F245	F120	F124	F128	F131	F121	F132	F749									F990	F991	F801	F802	F803	F804
F805	F806	F807	F808	F809	F810	F811	F812	F813	F814	F815	F816	F817	F818	F819	F820	F821	F822						
F823	F824	F825	F826	F827	F828	F829	F830	F831	F832	F833	F834	F835	F837	F838	F839	F840	F841						





¹INTERRUPTEUR PRINCIPAL, OUVERTURE EN POSITION 0 ²INTERRUPTORE GENERALE, APRIRE SOLO CON MANIGLIA SU 0
³INTERRUPTOR PRINCIPAL, ABRIR ARMARIO SOLO EN POS. "0"





Handles

Type	Color	Code	Size S00 S0 S1 S2 S3
------	-------	------	-------------------------

















Type	Color	Code	Size S00 S0 S1 S2 S3
------	-------	------	-------------------------

Black and Red are standard colours. White and Electro-Grey available on request.

R-Handle  S0	black red white electro-gray	G001 G002 G003 G007	— ● ● ● ● — ● ● ● ● — ● ● ● ● — ● ● ● ●
F-Handle  S0	black red white electro-gray	G221 G222 G223 G227	● ● ● ● — ● ● ● ● — ● ● ● ● — ● ● ● ● —
S-Handle  S0 S1	black red white electro-gray	G301 G302 G303 G307	— ● ● — — — ● ● — — — ● ● — — — ● ● — —
P-Handle  S0 S1-S3	black red white electro-gray	G211 G212 G213 G217	— ● ● ● ● — ● ● ● ● — ● ● ● ● — ● ● ● ●
Handwheel 	black	G971	— — — — ●

I-Handle  S00 S0-S3	black red white electro-gray	G251 G252 G253 G257	● ● ● ● ● ● ● ● ● ● ● ● ● ● ● ● ● ● ● ●
B-Handle 	black red white electro-gray	G521 G522 G523 G527	— ● ● — — — ● ● — — — ● ● — — — ● ● — —
L-Handle 	black red white electro-gray	G501 G502 G503 G507	— — ● — — — — ● — — — — ● — — — — ● — —
K-Handle 	black red white electro-gray	G411 G412 G413 G417	— — ● ● ● — — ● ● ● — — ● ● ● — — ● ● ●
O-Handle 	black red white electro-gray	G321 G322 G323 G327	— — ● — — — — ● — — — — ● — — — — ● — —

International Standards and Approvals

Country	Authority	Mark or Standard	CAD11/12	CA10	CA10B	C26	CA40	C43	L350/1	L1250/1	L400	L1200	
			CA4	CA11	CA11B	CA25	C32	CA50	C80	L630/1	C315	L600	L1600
			CA4-1	CA20	CA20B	CA25B	C42	CA63	C125	L1000/1	C316	L800	L2000
USA	Underwriters Laboratories Inc.	 ¹							●	●	●	●	
		 ² ³	●	●	●	●	●	●	●			●	
Canada	UL investigated acc. to CSA	 ⁶	●	●	●	●	●	●	●	●	●	●	
		 ¹ c.							●	●	●	●	
		 ² ³ c.	●	●	●	●	●	●	●			●	
Switzerland	Schweizerischer Elektrotechnischer Verein		+	+	+	+	+	+	+	+	+	+	
Denmark	Danmarks Elektriske Materielkontrol		+	+	+	+	+	+	+	+	+	+	
Norway	Norges Elektriske Materielkontrol		+	+	+	+	+	+	+	+	+	+	
Sweden	Svenska Elektriska Materielkontrollanstalten		+	+	+	+	+	+	+	+	+	+	
Finland	Sähkötar-kastuskeskus		+	+	+	+	+	+	+	+	+	+	
Austria	Österreichischer Verband für Elektrotechnik		+	+	+	+	+	+	+	+	+	+	
Federal Republic of Germany	Verband Deutscher Elektrotechniker	VDE 0660 ⁴	+	+	+	+	+	+	+	+	+	+	
Great Britain	British Standards Institution	BS EN 60947 ⁴	+	+	+	+	+	+	+	+	+	+	
International Electrical Commission (IEC) Recommendation		IEC 60947 ⁵	+	+	+	+	+	+	+	+	+	+	
China	China Quality Certification Centre	 ⁷ GB14048.3	●	●	●								
Russian Federation	GOST	 ⁷ CH01	●	●	●	●	●	●	+	+	+	+	
Russian Federation	Russian Maritime Register of Shipping		●	●	●	●	●	●	+	●	+	+	
Germanischer Lloyd			+	+	+	+	+	+	+	+	+	+	
Lloyds Register EMEA			+	+	+	+	+	+	+	+	+	+	

● Switch approved

+ Switch conforms to requirements

+ No approval required

¹Approved under the "Component Program" (UL-Recognized Industrial Component). File No. E35541, Category Control No. NLRV2 (U.S.) resp. NLRV8 (Canada).

²Approved under the "Listing Program". File No. E35541, Category Control No. NLRV (U.S.) resp. NLRV7 (Canada).

³Switch types CAD11/CAD12 approved under the "Listing Program". File No. E60262, Category Control No. NRNT (U.S.) resp. NRNT7 (Canada).

⁴It is not required for Industrial Switchgear to bear a symbol but must conform to requirements. By stating the specific standard no. on the product the manufacturer declares that all requirements of the product standard are met.

⁵IEC does not operate an approval scheme.

⁶File No. 13002ass No. 3211-05 resp. 4652-04.

⁷If this approval is required, please request when ordering.

Selection Data	CA4 CA10 CA11 CA20 CA25 C42 C315
	CA4-1 CA10B CA11B CA20B CA25B C26 C32 C43 CA40 CA50 CA63 C80 C125 C200-4 C316

Rated Insulation Voltage U_i	IEC 60947-3, EN 60947-3 ¹ VDE 0660 part 107 ¹ SEV ⁴ UL/Canada CEE/NEMKO min. voltage	V V V V	440 380 300 400/380	690 660 300 380	690 660 600 400	690 690 600 400	690 690 300 -	690 660 600 400	690 660 600 400	690 690 600 -	690 690 600 -	690 690 600 400	690 660 600 -	690 660 600 -	690/1000 660 600 -		
Rated Impulse Withstand Voltage U_{imp}		kV	4	6	6	6	6	6	6	6	6	6	6	6	6/8		
Rated Thermal Current I_u/I_{th}	IEC 60947-3, EN 60947-3 VDE 0660 part 107 SEV ⁴ 380 V 660 V UL/Canada	A A A A	10 10 -	20 16 12	20 16 12	25 25 25	32 32 32	32 40 40	50 63 63	63 40 40	63 50 63	63 63 63	115 100 -	150 160 -	200 -	315 315 315	
Rated Operational Current I_e																	
AC-21A Switching of resistive loads, including moderate overloads	IEC 60947-3, EN 60947-3 VDE 0660 part 107	A	10	20	20	25	32	32	40	63	40	50	63	100	150	200	315
AC-1 Resistive or low inductive loads	SEV ⁴ 380 V 660 V	A A	10 -	16 12	16 12	25 20	32 32	40 40	63 63	40 40	50 50	63 63	100 -	160 -	-	315 315	
AC-22A Switching of combined resistive or low inductive loads including moderate overloads	IEC 60947-3, EN 60947-3 VDE 0660 part 107 220 V-500 V 660 V-690 V	A A	10 -	20 20	20 25	25 32	32 32	40 40	63 63	40 40	50 50	63 63	100 100	150 125	150 125	315 125	
AC-15 Switching of control devices, contactors, valves etc.	IEC 60947-5-1, EN 60947-5-1 VDE 0660 part 107 220 V-240 V 380 V-440 V	A A	2,5 1,5	5 4	5 4	8 5	12 6	14 6	16 7	- -	14 6	16 7	- -	- -	- -	- -	
Pilot Duty	UL/Canada ⁴ Heavy	VAC	A300	A300	A600	A600	A300	A600	A600	A600	A600	A600	-	-	-	A600	
Ampere Rating Resistive or low inductive loads	UL/Canada ⁴	A	10	20	20	30	30	40	50	65	45	55	60	100	150	-	240
Resistive load/motor load	CEE NEMKO	A A	4/2 6/4 ²	10/6 10/6	10/6 -	16/10 20/10	- -	25/10	32/10	40/10	- -	- -	- -	63/10	- -	- -	
Breaking capacity	220 V-240 V 380 V-440 V 660 V-690 V	A A A	50 50 -	150 150 80	150 200 80	200 250 125	280 250 150	280 360 150	380 550 270	550 550 365	290 290 170	330 330 200	440 440 260	860 860 400	1100 1100 490	1100 2000 490	2000 2000 340
Power loss per contact at I_u Resistance to vibration Resistance to shock		W	0,4/0,9	0,9	0,9	0,9	0,7	1,3	1,3	1,7	1	1,8	2,8	5,8	3,8	6,7	17
Short Circuit Protection Max. fuse size (gG-characteristic) Rated short-time withstand current (1s-current)		A A	10 60	25 140	25 140	35 280	35 480	50 350	63 800	80 1000	50 950	63 950	63 950	125 1300	200 2000	200 2000	315 4200
DC Switching Capacity⁶																	
No. of series contacts	1 2 3 4 5 6 8																
Resistive loads $T \leq 1$ ms	24 48 70 95 120 145 190 48 95 140 190 240 290 350 60 120 180 240 300 360 450 110 220 330 440 550 660 - 220 440 660 - - - - 440 660 - - - - -	A	10 6 2,5 0,7 0,3 0,2	20 12 4,5 1 0,4 0,27	20 12 4,5 1 0,4 0,27	25 20 7,5 1,5 0,5 0,3	32 25 10 2 0,6 0,3	32 32 23 6,5 1,2 0,4	- 40 27 - - -	50 63 30 - - -	- 63 30 - - -	- 100 - - - -	115 100 -	- 150 -	- -	315 250 -	
Inductive loads $T = 50$ ms	24 48 70 95 120 145 190 30 60 90 120 150 180 240 48 95 140 190 240 290 350 60 120 180 240 300 360 450 110 220 330 440 550 660 -	A	6 3 1 0,7 0,3	12 5 2 1 0,4	12 5 2 1 0,4	20 9 3 1,5 0,5	25 12 3 1,5 0,5	32 25 16 11 3,2	40 30 20 15 3,5	63 55 - - -	100 33 - - -	150 50 -	250 70 -				
Ambient Temperature of Stages^{5,7}	open at 100% I_u/I_{th} enclosed at 100% I_{the}		55 °C during 24 hours with peaks up to 60 °C 35 °C during 24 hours with peaks up to 40 °C														

¹Valid for lines with grounded common neutral termination, overvoltage category III, pollution degree 3. Values for other supply systems on request. ²Valid for CA4 only. ³DC switching capacity applies to ON/OFF switches. Switching capacity for other configurations on request. ⁴International Standards and Approvals, refer to page 39. ⁵For electromagnetic optional extras see additional data in Catalog 101. ⁶Values for switches with spring return on request. ⁷Storage temperature: -40 °C to 85 °C (in case of temperature below -5 °C no shock load permissible).

Selection Data	CA4	CA10	CA11	CA20	CA25	C42			C315						
	CA4-1	CA10B	CA11B	CA20B	CA25B	C26	C32	C43	CA40	CA50	CA63	C80	C125	C200-4	C316

Rated Utilization Category	IEC 60947-3, EN 60947-3 VDE 0660 part 107																	
AC-2 Slip ring motor starting, reversing and plugging, star-delta starting CA4-CA50	3 phase	220 V-240 V	kW	2,5	4	4	5,5	7,5	8	10	18,5	10	11	18,5	30	37	37	55
	3 pole	380 V-440 V		4,5	7,5	7,5	11	15	15	18,5	30	18,5	22	30	45	55	55	90
		500 V		-	10	10	15	18,5	18,5	22	40	22	30	40	55	75	75	110
		660 V-690 V		-	10	10	13	15	15	22	37	22	30	37	55	55	55	55
AC-3 Direct-on-line starting, star-delta starting CA63-C315	3 phase	220 V-240 V	kW	1,5	3	3	4	5,5	5,5	7,5	11	7,5	11	11	15	22	22	37
	3 pole	380 V-440 V		2,2	5,5	5,5	7,5	11	11	15	18,5	15	18,5	18,5	30	37	37	55
		500 V		-	5,5	5,5	7,5	11	11	15	18,5	15	18,5	18,5	30	37	37	55
		660 V-690 V		-	5,5	5,5	7,5	11	11	15	18,5	15	18,5	22	30	30	30	37
AC-4 Direct-on-line starting, reversing, plugging and inching	1 phase	110 V-120 V	kW	0,3	0,6	0,6	1,5	2,2	2,2	2,5	3	2,5	3	3	3,7	5,5	5,5	11
	2 pole	220 V-240 V		0,55	2,2	2,2	3	4	4	5,5	6	5,5	6	6	7,5	11	11	22
		380 V-440 V		0,75	3	3	3,7	5,5	5,5	7,5	11	7,5	11	11	13	18,5	18,5	30
	3 phase	220 V-240 V		0,37	0,55	0,55	1,5	2,5	2,7	3,7	5,5	3,7	4	5,5	6	10	10	15
	3 pole	380 V-440 V		0,55	1,5	1,5	3	5,5	5,5	6	7,5	6	7	7,5	11	15	15	25
		500 V		-	1,5	1,5	3	5,5	5,5	6	7,5	6	7	7,5	11	15	15	25
AC-23A Frequent switching of motors or other high inductive loads	1 phase	110 V-120 V	kW	0,15	0,3	0,3	0,45	0,75	0,75	1,1	1,2	1,1	1,2	1,2	1,5	2,2	2,2	4
	2 pole	220 V-240 V		0,25	0,75	0,75	1,1	1,5	1,5	2,2	2,4	2,2	2,4	2,4	3	4	4	7,5
		380 V-440 V		0,5	1,5	1,5	2,2	3	3	3,7	4	3,7	4	4	5,5	7,5	7,5	11
	3 phase	220 V-240 V		1,8	3,7	3,7	5,5	7,5	7,5	11	15	7,5	11	15	30	37	37	75
	3 pole	380 V-440 V		3	7,5	7,5	11	15	15	22	30	18,5	22	30	45	75	75	132
		500 V		-	7,5	7,5	11	15	15	30	45	18,5	22	30	55	90	90	132
Ratings	Standard motor load DOL-Rating (similar AC-3)	3 phase	110 V-120 V	HP	0,75	1,5	1,5	3	5	5	7,5	7,5	7,5	7,5	10	15	-	30
		3 pole	220 V-240 V		1	3	3	7,5	10	10	15	15	15	15	20	25	-	75
			440 V-480 V		-	-	5	10	-	20	25	25	25	30	30	40	-	75
			550 V-600 V		-	-	5	10	-	25	30	30	25	30	40	50	-	60
	Heavy motor load Reversing-Rating (similar AC-4)	1 phase	110 V-120 V	HP	0,33	0,5	0,5	1,5	2	2	3	3	3	3	5	7,5	-	15
		2 pole	220 V-240 V		0,75	1	1	3	5	5	7,5	7,5	7,5	7,5	10	15	-	40
		277 V	0,75		2	2	3	5	5	7,5	7,5	7,5	10	10	15	-	40	
		440 V-480 V	-		-	2	5	-	10	15	15	15	15	20	25	-	50	
Max. Permissible Wire Gage - Use copper wire only Single-core or stranded wire			mm ²	2x	2x	2x	2x	2x	2x	2x	2x	2x	2x	2x	2x	2x	2x	2x
				1,5	2,5	2,5	4	6	6	10	16	16	16	16	35	70	95 ¹	185 ¹
				14	12	12	10	8	8	8	6	6	6	6	2	2/0	-	MCM
Flexible wire (sleeving in accordance with DIN 46228) Flexible AWG wires (without sleeve)			mm ²	2x	2x	2x	2x	2x	2x	2x	2x	2x	2x	2x	2x	2x	2x	2x
				1,5	2,5	2,5	4	4	6	6	10	10	10	10	25	50	95 ¹	150 ¹
				(1)	(2,5)	(2,5)	(2,5)	(4)	(4)	(6)	(10)	(10)	(10)	(10)	(25)	(50)	-	MCM
				16	14	14	12	10	10	8	6	6	6	6	3	1/0	-	300

¹Cable lug must accept M8 (C200-4) and M12 (C315/C316) screw. ²The insulation material of the conductor has to be PVC (typical wire codes are H05V-K0,5 ... H07V-K1,5 or H05V-U0,5 ... H07V-U1,5 etc.). Other materials on request. Connected conductors, which have to be disconnected and re-connected again must be cut in order to ensure a proper electrical connection and to prevent a complete cut-off of the wire insulation.

Selection Data	L350	L630			L1000			L1250		
	L351	L400	L600	L631	L800	L1001	L1200	L1251	L1600	L2000

Rated Insulation Voltage U_i	IEC 60947-3, EN 60947-3 ¹ VDE 0660 part 107 ¹ UL/Canada ²		V	690	690	690	690	690	690	690	690	690	690		
	min. voltage		V	on request											
				V	on request										
Rated Impulse Withstand Voltage U_{imp}			kV	6	6	6	6	6	6	6	6	6	6		
Rated Thermal Current I_u/I_{th}	IEC 60947-3, EN 60947-3 VDE 0660 part 107														
	Ambient temp. +35 °C during 24 hours with peaks up to +40 °C		A	350	500	800	630	1100	1000	1450	1250	1900	2400		
	Ambient temp. +55 °C during 24 hours with peaks up to +60 °C		A	350	500	750	600	950	920	1300	1100	1700	2000		
UL/Canada ²			A	350	400	630	630	800	1000	1200	1250	1600	2000		
Rated Operational Current I_e	AC-20A No-load operation		IEC 60947-3, EN 60947-3 VDE 0660 part 107	690 V	A	350	500	800	630	1100	1000	1450	1250	1900	2400
	Occasional switching under load $\cos \varphi$ 0,8 (AC-20B)		3 phase, 3 pole and 1 phase, 2 pole	220 V-440 V 500 V 660 V-690 V	A	350	500	800	500	1000	630	1200	630	1200	1200
					A	350	450	500	450	630	500	800	500	800	800
AC-21B Switching of resistive loads, including moderate overloads		3 phase, 3 pole and 1 phase, 2 pole	220 V-440 V 500 V 660 V-690 V	A	250	450	500	350	630	400	800	400	800	800	
				A	250	400	450	315	500	350	630	350	630	630	
				A	200	300	350	250	350	300	350	300	350	350	
Interrupting Rating		UL/Canada ² CSA	600 V 600 V	A	200	300	300	200	300	200	300	200	200	200	
				A	200	200	200	200	200	200	200	200	200	200	
Rated Utilization Category	IEC 60947-3, EN 60947-3 VDE 0660 part 107														
	AC-23B Occasional switching of motors or other high inductive loads		3 phase 3 pole	220 V-240 V 380 V-440 V 500 V 660 V-690 V	kW	45	75	75	45	75	45	75	45	75	75
					kW	90	132	132	90	132	90	132	90	132	132
				kW	110	132	132	110	132	110	132	110	132	132	
				kW	55	55	65	65	65	65	65	65	65	65	
Short Circuit Protection	Max. fuse size		(aR-characteristic)	A	400	500	800	630	1100	1000	2x800	1250	2x1000	2x1250	
	Rated short-time withstand current		(1s-current)	A	on request										
Terminals	for connection screw			M12	M12	M16	M16	M16	M16	M16	M16	M16	2xM16	4xM16	
	length		mm	20	30	40	30	40	40	40	40	50	50	50	
					Cable lug or copper bus										
Ambient Temperature of Stages^{3,4}			55 °C during 24 hours with peaks up to 60 °C, permissible load see Rated Thermal Current.												

¹Valid for lines with grounded common neutral termination, overvoltage category III, pollution degree 3. Values for other supply systems on request.
²International Standards and Approvals, refer to page 41. ³For electromagnetic optional extras see additional data in Catalog 101. ⁴Storage temperature: -40 °C to 85 °C (in case of temperature below -5 °C no shock load permissible).

Selection Data	CAD4-1	CAD11	CAD12 (until 31/12/2012)
-----------------------	--------	-------	-----------------------------

Rated Insulation Voltage U_i	IEC 60947-3, EN 60947-3 ¹ VDE 0660 part 107 SEV ² North America min. voltage	V V V V	440 – 300 1 ⁷	600 600 300 1	600 600 300 6
Rated Impulse Withstand Voltage U_{imp}				on request	
Rated Thermal Current I_U/I_{th}	IEC 60947-3, EN 60947-3 VDE 0660 part 107 SEV ² North America	A A A	5 – 5	6 5 6	6 5 6
Rated Operational Current I_e	IEC 60947-3, EN 60947-3 VDE 0660 part 107 North America ³				
AC-21A Switching of resistive loads, including moderate overloads	1 V/6 V 12 V/24 V 48 V/110 V 220 V/400 V 440 V/500 V 600 V	A A A A A A	5/2 1,2/0,7 0,45/0,25 0,15/– 0,1/– –	6/3 2/1 0,8/0,4 0,2/0,13 0,1/0,08 0,05	–/6 5/5 4/3 2/1,3 1/0,8 0,5
AC-1 Resistive or low inductive loads	SEV ² 1 V/6 V 12 V/24 V 48 V/110 V 220 V/380 V 440 V/500 V 600 V	A A A A A A	– – – – – –	5/3 2/1 0,8/0,4 0,2/0,13 0,1/0,08 0,05	–/5 5/5 4/3 2/1,3 1/0,8 0,5
Power loss per contact at I_U		W	0,4	0,5	0,2
Short Circuit Protection					
Max. fuse size	(gL-characteristic)	A	5	6	6
Rated short-time withstand current	(1s-current)	A	30	35	50
DC Switching Capacity⁵	IEC 60947-3, EN 60947-3 VDE 0660 part 107 SEV ² North America ³				
DC-1 Resistive load T = 1 ms	1 V/6 V 12 V/24 V 48 V/60 V 110 V/220 V 240 V/500 V 600 V	A A A A A A	3/1,2 0,7/0,4 0,25/0,2 0,13/– 0,08/–	4/2,5 1,5/0,8 0,3/0,27 0,2/0,1 0,08/0,03 0,02	–/4 3/2,2 1,2/1 0,6/0,3 0,25/0,1 0,1
Max. Permissible Wire Gage - Use copper wire only					
Single-core or stranded wire		mm ² AWG	2x 1,5 14	2x 2,5 12	2x 2,5 12
Flexible wire (sleeving in accordance with DIN 46228) Flexible AWG wires (without sleeve)		mm ² AWG	2x 1,5 (1) 16	2x 2,5 (2,5) 14	2x 2,5 (2,5) 14
Ambient Temperature of Stages^{4,6}	open at 100 % I_U/I_{th} enclosed at 100 % I_{the}		55 °C during 24 hours with peaks up to 60 °C 35 °C during 24 hours with peaks up to 40 °C		

¹Valid for lines with grounded common neutral termination, overvoltage category III, pollution degree 3. Values for other supply systems on request.

²International Standards and Approvals, refer to page 41. ³Max. 300 V. ⁴For electromagnetic optional extras see additional data in Catalog 101.

⁵Values for switches with spring return on request. ⁶Storage temperature: -40 °C to 85 °C (in case of temperature below -5 °C no shock load permissible).

⁷Values with lower voltages on request.

Two or Four Hole Panel Mounting

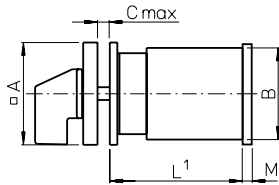

E
for CA4, CA4-1,
CAD4-1

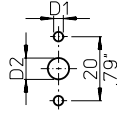

E-V
for CA4, CA4-1,
CAD4-1

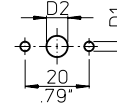

E
E-V
ER

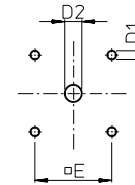

	CA10						CA10B				CA40 ³			C125		L switches		C315 ⁴	
	CA4	CA11			CA10B				CA40 ³							Size S2	Size S3		
	CA4-1	CAD11	CA20	CA25 ³	CA20B	CA25B	C26	C32	C42 ³	C43	CA50 ³	CA63 ³	C80	C200-4					
A	0	48	48	48 (64)	64	64	64	64	64 (88)	88	64 (88)	88	88	88	88	88	130	130	
	1.18	1.89	1.89	1.89 (2.52)	2.52	2.52	2.52	2.52	2.52 (3.46)	3.46	2.52	3.46	3.46	3.46	3.46	3.46	3.46	3.46 5.12	
B	29.5	43	45	46	56	56	58	60	66	84	55.5x64	84	88	88	88	88	126	126	
	1.16	1.69	1.77	1.81	2.20	2.20	2.28	2.36	2.60	3.30	2.19x2.52	3.30	3.46	3.46	3.46	3.46	4.96	4.96	
C	4	4	4	4	4	4	4	4	4	5.5	4	5.5	5.5	5.5	5.5	5.5	7	7	
	.16	.16	.16	.16	.16	.16	.16	.16	.16	.22	.16	.22	.22	.22	.22	.22	.28	.28	
D1	3,2	5	5	5	5	5	5	5	5 (6)	6	5 (6)	6	6	6	6	6	7	7	
	.13	.20	.20	.20	.20	.20	.20	.20	.20 (.24)	.24	.20 (.24)	.24	.24	.24	.24	.24	.28	.28	
D2	8-11	8-19	8-19	8-19	10-22	10-22	10-22	10-22	10-22	13-30	10-22	13-30	13-30	13-30	13-30	13-30	15.5-25	15.5-25	
	.31-.43	.31-.75	.31-.75	.31-.75	.39-.87	.39-.87	.39-.87	.39-.87	.39-.87	.51-1.18	.39-.87	.51-1.18	.51-1.18	.51-1.18	.51-1.18	.51-1.18	.61-.98	.61-.98	
E	-	36	36	36 (48)	48	48	48	48	48 (68)	68	48 (68)	68	68	68	68	68	104	104	
	-	1.42	1.42	1.42 (1.89)	1.89	1.89	1.89	1.89	1.89 (2.68)	2.68	1.89 (2.68)	2.68	2.68	2.68	2.68	2.68	4.09	4.09	
M²	-	4,5	4,5	5,5	5	5,5	7,5	7,5	7,5	7,5	7,6	9,4	9,4	9,4	27,5	11,9 (32)	11,9 (32)	11,9 (32)	
	-	.18	.18	.22	.20	.22	.30	.30	.30	.30	.30	.37	.37	.37	1.08	.47 (1.26)	.47 (1.26)	.47 (1.26)	

²M, additional length for mounting ER only
³Dimensions in () for ER mounting plate only

⁴Dimensions in () for L800, L1200, L1600

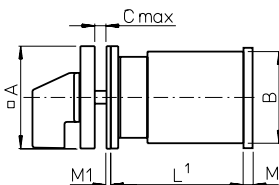

EF
for CA4, CA4-1,
CAD4-1

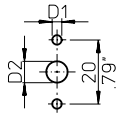

EF-V
for CA4, CA4-1,
CAD4-1

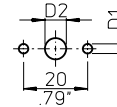

EF
EF-V
ERF

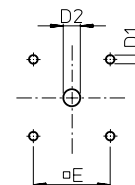

	CA10						CA10B				CA40 ³			C125		L switches		C315 ⁴	
	CA4	CA11			CA10B				CA40 ³							Size S2	Size S3		
	CA4-1	CAD11	CA20	CA25 ³	CA20B	CA25B	C26	C32	C42 ³	C43	CA50 ³	CA63 ³	C80	C200-4					
A	30	48	48	48 (64)	64	64	64	64	64 (88)	88	64 (88)	88	88	88	88	88	130	130	
	1.18	1.89	1.89	1.89 (2.52)	2.52	2.52	2.52	2.52	2.52 (3.46)	3.46	2.52 (3.46)	3.46	3.46	3.46	3.46	3.46	3.46	3.46 5.12	
B	29.5	43	45	46	56	56	58	60	66	84	55.5x64	84	88	88	88	88	126	126	
	1.16	1.69	1.77	1.81	2.20	2.20	2.28	2.36	2.60	3.30	2.19x2.52	3.30	3.46	3.46	3.46	3.46	4.96	4.96	
C	4	4	4	4	4	4	4	4	4	5.5	4	5.5	5.5	5.5	5.5	5.5	7	7	
	.16	.16	.16	.16	.16	.16	.16	.16	.16	.22	.16	.22	.22	.22	.22	.22	.28	.28	
D1	3,2	5	5	5	5	5	5	5	5 (6)	6	5 (6)	6	6	6	6	6	7	7	
	.13	.20	.20	.20	.20	.20	.20	.20	.20 (.24)	.24	.20 (.24)	.24	.24	.24	.24	.24	.28	.28	
D2	8-11	15-19	15-19	15-19	19-22	19-22	19-22	19-22	19-22	26-30	19-22	26-30	26-30	26-30	26-30	26-30	22-25	22-25	
	.31-.43	.59-.75	.59-.75	.59-.75	.75-.87	.75-.87	.75-.87	.75-.87	.75-.87	1.02-1.18	.75-.87	1.02-1.18	1.02-1.18	1.02-1.18	1.02-1.18	1.02-1.18	.87-.98	.87-.98	
E	-	36	36	36 (48)	48	48	48	48	48 (68)	68	48 (68)	68	68	68	68	68	104	104	
	-	1.42	1.42	1.42 (1.89)	1.89	1.89	1.89	1.89	1.89 (2.68)	2.68	1.89 (2.68)	2.68	2.68	2.68	2.68	2.68	4.09	4.09	
M²	-	4,5	4,5	5,5	5	5,5	7,5	7,5	7,5	7,5	7,6	9,4	9,4	9,4	27,5	11,9 (32)	11,9 (32)	11,9 (32)	
	-	.18	.18	.22	.20	.22	.30	.30	.30	.30	.30	.37	.37	.37	1.08	.47 (1.26)	.47 (1.26)	.47 (1.26)	
M1	1	-	-	-	-	-	-	-	-	-	-	-	-	-	-	-	-	-	
	.04	-	-	-	-	-	-	-	-	-	-	-	-	-	-	-	-	-	

²M, additional length for mounting ERF only
³Dimensions in () for ERF mounting plate only

⁴Dimensions in () for L800, L1200, L1600

¹see page 52

Two or Four Hole Panel Mounting

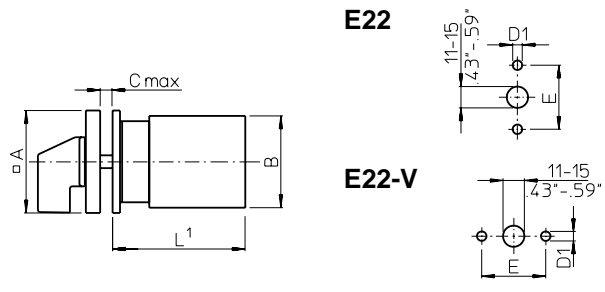

	CA10	CA11	CAD11	CAD12	CA20	CA25
A	48 1.89	48 1.89	48 1.89	48 1.89	48 1.89	48 1.89
B	43 1.69	45 1.77	46 1.81	43 1.69	45 1.77	46 1.81
C	4 .16	4 .16	4 .16	4 .16	4 .16	4 .16
D1	5 .20	5 .20	5 .20	5 .20	5 .20	5 .20
E	30 1.17	30 1.17	30 1.17	30 1.17	30 1.17	30 1.17

**EG
EGF**

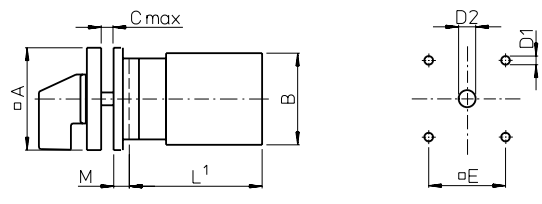

	CA10	CA11	CAD11	CAD12	CA20	CA25	C26	C32	C42	CA40	CA50	CA63	C80	C125	C200-4
														L switches	Size S2
A	64 2.52	64 2.52	64 2.52	64 2.52	64 2.52	64 2.52	88 3.46	88 3.46	88 3.46	88 3.46	88 3.46	88 3.46	130 5.12	130 5.12	130 5.12
B	43 1.69	45 1.77	46 1.81	43 1.69	45 1.77	46 1.81	58 2.28	60 2.36	66 2.60	55,5x64 2.19x2.52	84 3.30	84 3.30	84 3.30	88 3.46	88 3.46
C	4 .16	4 .16	4 .16	4 .16	4 .16	4 .16	5,5 .22	5,5 .22	5,5 .22	5,5 .22	5,5 .22	5,5 .22	7 .28	7 .28	7 .28
D1	5 .20	5 .20	5 .20	5 .20	5 .20	5 .20	6 .24	6 .24	6 .24	6 .24	6 .24	6 .24	7 .28	7 .28	7 .28
EG D2	10-22 .39-.87	10-22 .39-.87	10-22 .39-.87	10-22 .39-.87	10-22 .39-.87	10-22 .39-.87	13-30 .51-1.18	13-30 .51-1.18	13-30 .51-1.18	13-30 .51-1.18	13-30 .51-1.18	13-30 .51-1.18	15,5-25 .61-.98	15,5-25 .61-.98	15,5-25 .61-.98
EGF D2	19-22 .75-.87	19-22 .75-.87	19-22 .75-.87	19-22 .75-.87	19-22 .75-.87	19-22 .75-.87	26-30 1.02-1.18	26-30 1.02-1.18	26-30 1.02-1.18	26-30 1.02-1.18	26-30 1.02-1.18	26-30 1.02-1.18	22-25 .87-.98	22-25 .87-.98	22-25 .87-.98
E	48 1.89	48 1.89	48 1.89	48 1.89	48 1.89	48 1.89	68 2.68	68 2.68	68 2.68	68 2.68	68 2.68	68 2.68	104 4.09	104 4.09	104 4.09
M	6,7 .26	6,7 .26	6,7 .26	6,7 .26	6,7 .26	6,7 .26	0,5 .02	0,5 .02	0,5 .02	0,5 .02	0,5 .02	0,5 .02	2 .08	2 .08	2 .08

¹see page 52

Four Hole Panel Mounting or Mosaic Mounting

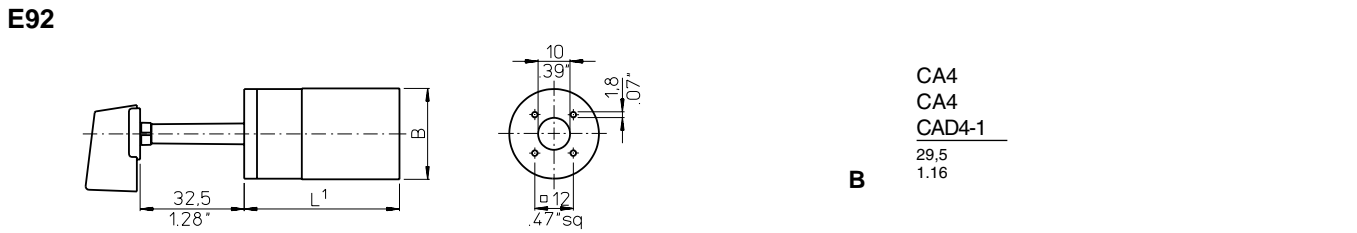
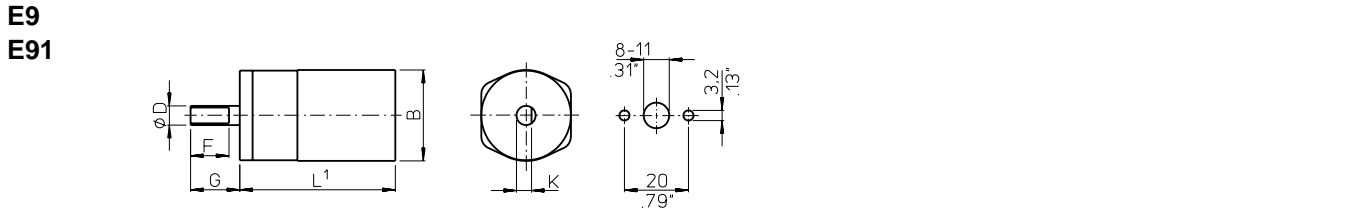

CA4
CA4
CAD4-1
29,5
1.16

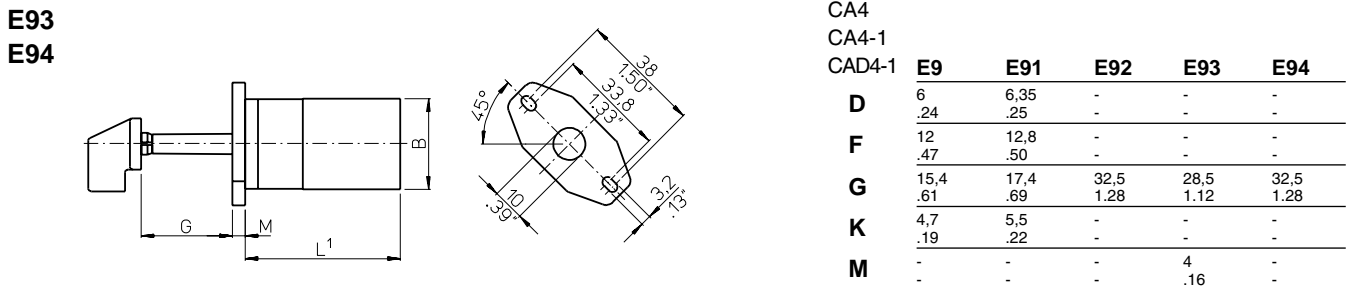

	CA4	CA4-1	CAD4-1	E9	E91	E92	E93	E94
B				6	6,35	-	-	-
D				.24	.25	-	-	-
F				.12	.12,8	-	-	-
G				.47	.50	-	-	-
K				15,4	17,4	32,5	28,5	32,5
				.61	.69	1,28	1,12	1,28
M				4,7	5,5	-	-	-
				.19	.22	-	-	-
				-	-	-	4	-
				-	-	-	.16	-

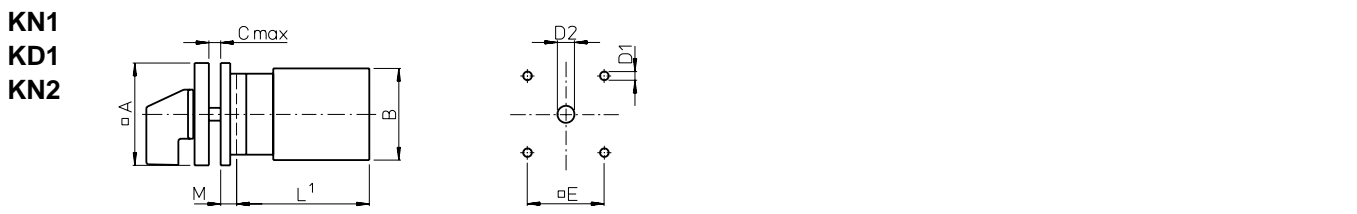

KN2	CA10	CA11	CAD11	CA20	CA25
A	48	48	48	48	48
	1.89	1.89	1.89	1.89	1.89
B	43	45	46	46	46
	1.69	1.77	1.81	1.81	1.81
C	4	4	4	4	4
	.16	.16	.16	.16	.16
D1	5	5	5	5	5
	.20	.20	.20	.20	.20
D2	8-19	8-19	8-19	8-19	8-19
	.31-.75	.31-.75	.31-.75	.31-.75	.31-.75
E	36	36	36	36	36
	1.42	1.42	1.42	1.42	1.42
M	5,2	5,2	5,2	5,2	5,2
	.20	.20	.20	.20	.20

KN1	CA10	CA11	CA10B	CA11B	CA20B	CA25B	C26	C32	C42	CA40	CA50	CA63
A	64	64	64	64	64	64	64	64	64	64	64	64
	2.52	2.52	2.52	2.52	2.52	2.52	2.52	2.52	2.52	2.52	2.52	2.52
B	43	45	46	56	56	58	60	66	66	66	55,5x64	2.19x2.52
	1.69	1.77	1.81	2.20	2.20	2.28	2.36	2.60	2.60	2.60	2.19x2.52	2.52
C	4	4	4	4	4	4	4	4	4	4	4	4
	.16	.16	.16	.16	.16	.16	.16	.16	.16	.16	.16	.16
D1	5	5	5	5	5	5	5	5	5	5	5	5
	.20	.20	.20	.20	.20	.20	.20	.20	.20	.20	.20	.20
D2	10-22	10-22	10-22	10-22	10-22	10-22	10-22	10-22	10-22	10-22	10-22	10-22
	.39-.87	.39-.87	.39-.87	.39-.87	.39-.87	.39-.87	.39-.87	.39-.87	.39-.87	.39-.87	.39-.87	.39-.87
E	48	48	48	48	48	48	48	48	48	48	48	48
	1.89	1.89	1.89	1.89	1.89	1.89	1.89	1.89	1.89	1.89	1.89	1.89
M	4,7	4,7	4,7	7	7	7	7	7	7	7	7	7
	.19	.19	.19	.28	.28	.28	.28	.28	.28	.28	.28	.28

¹see page 52

Two or Four Hole Panel Mounting

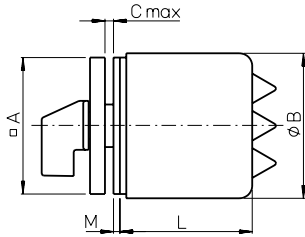

ED22

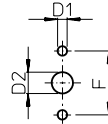

**EC
ED
EC1
ED1**

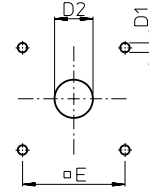

	CA10		CAD11		CA11		CA20		CA25		CA10B		CA11B		CA20B		C26		C32		C42		C43		CA40	CA50	CA63	
	EC	ED	EC	ED	EC	ED	EC	ED	EC	ED	EC	ED	EC	ED	EC	ED	EC	ED	EC	ED	EC	ED	EC	ED	EC	ED	EC	
A	48 1.89	48 1.89	48 1.89	48 1.89	64 2.52	48 1.89	64 2.52	48 1.89	64 2.52	48 1.89	64 2.52	64 2.52	64 2.52	64 2.52	64 2.52	64 2.52	64 2.52	64 2.52	88 3.46	88 3.46	88 3.46	88 3.46	88 3.46	88 3.46	88 3.46	88 3.46	88 3.46	
B	50 1.97	74 2.91	50 1.97	74 2.91	68 2.68	74 2.91	68 2.68	74 2.91	68 2.68	74 2.91	88 3.46	74 2.91	88 3.46	74 2.91	88 3.46	74 2.91	88 3.46	74 2.91	108 4.25	108 4.25	108 4.25	108 4.25	108 4.25	108 4.25	108 4.25	108 4.25	108 4.25	
C	4 .16	-	4 .16	-	4 .16	-	4 .16	-	4 .16	-	4 .16	-	4 .16	-	4 .16	-	4 .16	-	4 .16	-	4 .16	-	4 .16	-	4 .16	-	4 .16	5.5 .22
ED/ED1/ED22	2 .08	4 .16	2 .08	4 .16	2 .08	4 .16	2 .08	4 .16	2 .08	4 .16	2 .08	4 .16	2 .08	4 .16	2 .08	4 .16	2 .08	4 .16	2 .08	4 .16	2 .08	4 .16	2 .08	4 .16	2 .08	4 .16	7.5 .30	7.5 .30
D1	5 .20	5 .20	5 .20	5 .20	5 .20	5 .20	5 .20	5 .20	5 .20	5 .20	5 .20	5 .20	5 .20	5 .20	5 .20	5 .20	5 .20	5 .20	5 .20	5 .20	5 .20	5 .20	5 .20	5 .20	5 .20	5 .20	5 .20	5 .20
EC/EC1	8-15 .31-.59	-	8-15 .31-.59	-	8-15 .31-.59	-	8-15 .31-.59	-	8-15 .31-.59	-	10-15 .39-.59	10-15 .39-.59	10-15 .39-.59	10-15 .39-.59	10-15 .39-.59	10-15 .39-.59	10-15 .39-.59	10-15 .39-.59	10-15 .39-.59	10-15 .39-.59	10-15 .39-.59	10-15 .39-.59	10-15 .39-.59	10-15 .39-.59	10-15 .39-.59	10-15 .39-.59	10-15 .39-.59	
ED/ED1/ED22	18-22 .71-.87	11-15 .43-.59	18-22 .71-.87	11-15 .43-.59	18-22 .71-.87	11-15 .43-.59	18-22 .71-.87	11-15 .43-.59	18-22 .71-.87	11-15 .43-.59	22-25 .87-.98	19-22 .75-.87	22-25 .87-.98	19-22 .75-.87	22-25 .87-.98	19-22 .75-.87	22-25 .87-.98	19-22 .75-.87	22-25 .87-.98	19-22 .75-.87	22-25 .87-.98	19-22 .75-.87	22-25 .87-.98	19-22 .75-.87	22-25 .87-.98	19-22 .75-.87	22-25 .87-.98	
E	36 1.42	-	36 1.42	-	48 1.89	-	48 1.89	-	48 1.89	-	48 1.89	48 1.89	48 1.89	48 1.89	48 1.89	48 1.89	48 1.89	48 1.89	48 1.89	48 1.89	48 1.89	48 1.89	48 1.89	48 1.89	48 1.89	48 1.89	48 1.89	68 2.68
F	-	30 1.17	-	30 1.17	-	30 1.17	-	30 1.17	-	30 1.17	-	-	-	-	-	-	-	-	-	-	-	-	-	-	-	-	-	-
ED/ED22	2 .08	1.5 .06	2 .08	1.5 .06	2 .08	1.5 .06	2 .08	1.5 .06	2 .08	1.5 .06	2 .08	1.5 .06	2 .08	1.5 .06	2 .08	1.5 .06	2 .08	1.5 .06	2 .08	1.5 .06	2 .08	1.5 .06	2 .08	1.5 .06	2 .08	1.5 .06	2 .08	2.2 .09
Stages L	1	53,5 2.10	74,3 2.93	53,5 2.10	74,3 2.93	-	74,3 2.93	-	74,3 2.93	-	73,7 2.90	-	73,7 2.90	-	73,7 2.90	-	73,7 2.90	-	73,7 2.90	-	73,7 2.90	-	101 3.98	101 3.98	101 3.98	101 3.98	101 3.98	
	2	53,5 2.10	74,3 2.93	53,5 2.10	74,3 2.93	-	74,3 2.93	-	74,3 2.93	-	73,7 2.90	-	73,7 2.90	-	73,7 2.90	-	73,7 2.90	-	73,7 2.90	-	73,7 2.90	-	101 3.98	101 3.98	101 3.98	101 3.98	101 3.98	
	3	67,5 2.66	74,3 2.93	67,5 2.66	94,3 3.71	-	74,3 2.93	-	94,3 3.71	-	73,7 2.90	-	93,7 3.69	-	93,7 3.69	-	93,7 3.69	-	93,7 3.69	-	93,7 3.69	-	101 3.98	139 5.47	139 5.47	139 5.47	101 3.98	
	4	67,5 2.66	74,3 2.93	81,5 3.21	94,3 3.71	-	94,3 3.71	-	94,3 3.71	-	93,7 3.69	-	93,7 3.69	-	93,7 3.69	-	93,7 3.69	-	93,7 3.69	-	93,7 3.69	-	139 5.47	139 5.47	139 5.47	101 3.98	101 3.98	
	5	81,5 3.21	94,3 3.71	-	-	103 4.06	-	103 4.06	-	-	93,7 3.69	103 4.06	-	103 4.06	-	103 4.06	-	114,5 4.50	-	139 5.47	177 6.97	177 6.97	177 6.97	177 6.97	139 5.47	139 5.47	139 5.47	
	6	81,5 3.21	94,3 3.71	-	-	-	-	-	-	103 4.06	-	127 5	-	127 5	-	127 5	-	127 5	-	177 6.97	215 8.46	215 8.46	215 8.46	215 8.46	139 5.47	139 5.47	139 5.47	
	7	-	-	-	-	-	-	-	-	127 5	-	139,5 5.47	-	139,5 5.47	-	139,5 5.47	-	139,5 5.47	-	177 6.97	215 8.46	215 8.46	215 8.46	215 8.46	139 5.47	139 5.47	139 5.47	
	8	-	-	-	-	-	-	-	-	127 5	-	152 5.98	-	152 5.98	-	152 5.98	-	152 5.98	-	215 8.46	253 9.96	253 9.96	253 9.96	253 9.96	177 6.97	177 6.97	177 6.97	
	9	-	-	-	-	-	-	-	-	139,5 5.47	-	164,5 6.48	-	164,5 6.48	-	164,5 6.48	-	164,5 6.48	-	215 8.46	253 9.96	253 9.96	253 9.96	253 9.96	177 6.97	177 6.97	177 6.97	
	10	-	-	-	-	-	-	-	-	152 5.98	-	177 6.97	-	177 6.97	-	177 6.97	-	177 6.97	-	215 8.46	253 9.96	253 9.96	253 9.96	253 9.96	177 6.97	177 6.97	177 6.97	
	11	-	-	-	-	-	-	-	-	152 5.98	-	-	-	-	-	-	-	-	-	253 9.96	-	291 11.46	215 8.46	215 8.46	215 8.46	215 8.46	215 8.46	
	12	-	-	-	-	-	-	-	-	164,5 6.48	-	-	-	-	-	-	-	-	-	253 9.96	-	329 12.95	215 8.46	215 8.46	215 8.46	215 8.46	215 8.46	

Single Hole Mounting or Base Mounting

FS1...
FT1...
FT3...

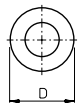

FS1...
FS2...
FS4...

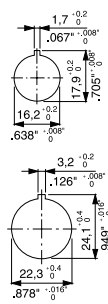

FH3...
FS2...
FT2...
FT4...

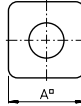

FH3...
FH4...
FT1...
FT2...
FT6...

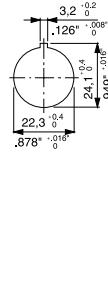

FH4...
FS4...
FT6...

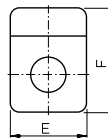

FT3...
FT4...

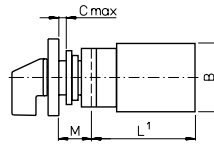
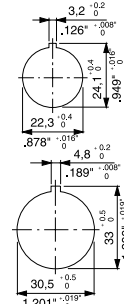

	CA4	CA10	CA11	CAD11	CA20	CA25
A/E	30	48	48	48	48	48
	1.18	1.89	1.89	1.89	1.89	1.89
FH3...	-	64	64	64	64	64
	-	2.52	2.52	2.52	2.52	2.52
FH4...	-	64	64	64	64	64
	-	2.52	2.52	2.52	2.52	2.52
B	28	43	45	46	46	46
	1.10	1.69	1.77	1.81	1.81	1.81
C	5	6	6	6	6	6
	.20	.24	.24	.24	.24	.24
D	29.5	39	39	39	39	39
	1.16	1.54	1.54	1.54	1.54	1.54
F	39	59	59	59	59	59
	1.54	2.32	2.32	2.32	2.32	2.32
FH4...	-	78.5	78.5	78.5	78.5	78.5
	-	3.09	3.09	3.09	3.09	3.09
M	12.5	18.2	18.2	18.2	18.2	18.2
	.49	.72	.72	.72	.72	.72
FH3...	-	25.2	25.2	25.2	25.2	25.2
	-	.99	.99	.99	.99	.99
FH4...	-	25.2	25.2	25.2	25.2	25.2
	-	.99	.99	.99	.99	.99

VE

VE-V

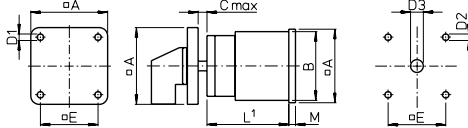

VE22

VE22V

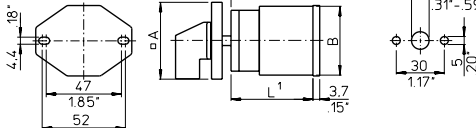

VF

VF-V

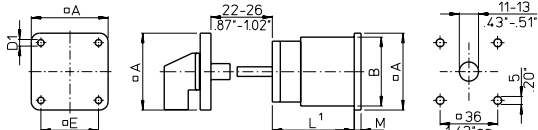

VF22

VF22V

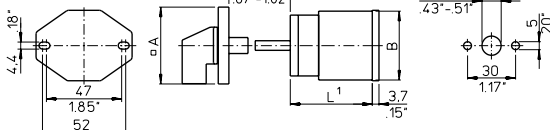

	CA10	CA11	CAD11	CA10B	CA11B	CA25B	C26	C32	C42 ²	C43	CA40 ²	CA50 ²	CA63 ²	C125	C80	C200-4	L switches	L switches
				CA20B													Size S2	Size S3
A	48	48	48	64 (64)	64	64	64	64	64 (88)	88	64 (88)	88	88	88	88	88	88	128
	1.89	1.89	1.89	2.52 (2.52)	2.52	2.52	2.52	2.52	2.52 (3.46)	3.46	2.52 (3.46)	3.46	3.46	3.46	3.46	3.46	3.46	5.04
B	43	45	46	56	56	58	60	66	84	84	55.5x64	84	88	88	88	88	88	126
	1.69	1.77	1.81	2.20	2.20	2.28	2.36	2.60	3.30	3.30	2.19x2.52	3.30	3.46	3.46	3.46	3.46	3.46	4.96
C	10.5	10.5	10.5	13.5	13.5	13.5	13.5	13.5	16	16	13.5	16	16	16	16	16	16	19.3
	.41	.41	.41	.53	.53	.53	.53	.53	.63	.63	.53	.63	.63	.63	.63	.63	.63	.76
D1	4.1	4.1	4.1	4.1	4.1	4.1	4.1	4.1	5.4	5.4	5.4	5.4	5.4	5.4	5.4	5.4	5.4	7
	.16	.16	.16	.16	.16	.16	.16	.16	.21	.21	.21	.21	.21	.21	.21	.21	.21	.28
D2	5	5	5	5	5	5	5	5	6	6	5 (6)	6	6	6	6	6	6	7
	.20	.20	.20	.20	.20	.20	.20	.20	.24	.24	.20 (.24)	.24	.24	.24	.24	.24	.24	.28
D3	8-19	8-19	8-19	10-22	10-22	10-22	10-22	10-22	10-22	13-30	10-22	13-30	13-30	13-30	13-30	13-30	13-30	15.5-25
	.31-.75	.31-.75	.31-.75	.39-.87	.39-.87	.39-.87	.39-.87	.39-.87	.39-.87	.51-1.18	.39-.87	.51-1.18	.51-1.18	.51-1.18	.51-1.18	.51-1.18	.51-1.18	.61-.98
E	36	36	36	48	48	48	48	48	68	68	48 (68)	68	68	68	68	68	68	104
	1.42	1.42	1.42	1.89	1.89	1.89	1.89	1.89	2.68	2.68	1.89 (2.68)	2.68	2.68	2.68	2.68	2.68	2.68	4.09
M	2.2	2.2	3.2	2.5	2.5	5	5	5	7	7	5.1	8.9	8.9	8.9	8.9	27	11.4	31.9
	.09	.09	.13	.10	.10	.20	.20	.20	.28	.28	.21	.35	.35	.35	1.06	1.06	.45	(1.25)

²Dimensions in () for revertive mounting plate

³Dimensions in () for L800, L1200, L1600

¹see page 52

Dimensions mm
inch

Base Mounting

VE1

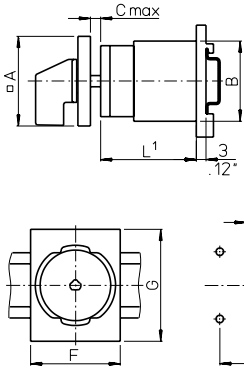

	CA10 CA11 CAD11 CAD12	CA20	CA25	CA10B CA11B CA20B	CA25B	C26	C32	C42	CA40 CA50 CA63
A	48 1.89	48 1.89	48 1.89	64 2.52	64 2.52	64 2.52	64 2.52	64 2.52	64 2.52
B	43 1.69	45 1.77	46 1.81	56 2.20	56 2.20	58 2.28	60 2.36	66 2.60	55,5x64 2.19x2.52
C	10,5 .41	10,5 .41	10,5 .41	13,5 .53	13,5 .53	13,5 .53	13,5 .53	13,5 .53	13,5 .53
D1	5 .20	5 .20	5 .20	5 .20	5 .20	5 .20	5 .20	5 .20	5 .20
D2	8-15 .31-.59	8-15 .31-.59	8-15 .31-.59	10-15 .39-.59	10-15 .39-.59	10-15 .39-.59	10-15 .39-.59	10-15 .39-.59	10-15 .39-.59
E	36 1.42	36 1.42	36 1.42	48 1.89	48 1.89	48 1.89	48 1.89	48 1.89	48 1.89
F	48 1.89	48 1.89	48 1.89	70 2.76	70 2.76	70 2.76	70 2.76	70 2.76	70 2.76
G	60 2.36	60 2.36	60 2.36	60 2.36	60 2.36	60 2.36	60 2.36	60 2.36	60 2.36

VE2

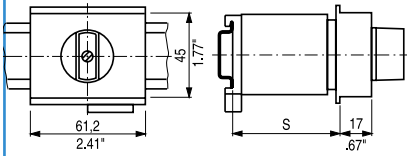

VE21 (for CA4, CA4-1 and CAD4-1)

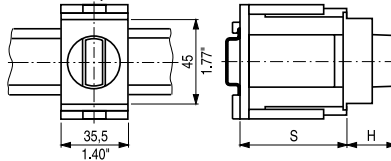

VE3

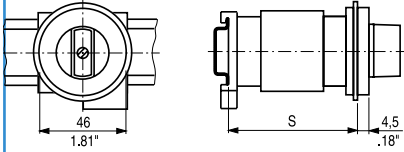

VE21 (for CA10-CA20)

VE21V (for CA25)

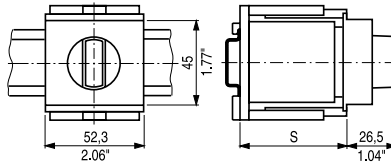

VE4

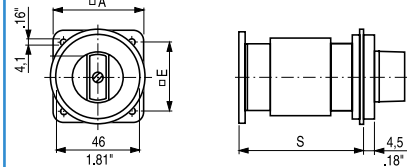

	VE2			VE3		VE4			S_{min.}	H	VE21, VE21V				
	CA10 CAD11 CAD12	CA11 CA20 CL10	CA25 CA25	CA10 CAD11 CAD12	CA20 CA25 CL10	CA10 CAD11 CAD12	CA11 CA20 CA25	Max. no. of stages			CA4 CA4-1 CAD4-1	CA10 CAD11 CAD12	CA11	CA20	CA25
S = 46 1.81	3	1	-	1	1	1	2	-	44 1.73	21 .83	1/2	1/2	1/2	1	
S = 50 1.97	3	1	1	2	1	2	2	1	46 1.81	26,5 1.04	3	3	-	2	
S = 61 2.40	4	2	2	3	2	3	3	2	54 2.13	26,5 1.04	4	-	-	-	
S = 67 2.64	5	2	2	3	2	3	3	2	56 2.20	-	-	-	3	3	
S = 69 2.70	5	3 ²	3	4	3	4	4	3	60 2.36	-	-	-	-	3	
									62 2.44	26,5 1.04	5	-	-	-	
									66 2.60	-	-	4/5	-	-	
									68 2.68	-	-	-	4	-	
									70 2.76	26,5 1.04	6	-	-	4	
									74 2.91	-	-	6	-	4	

¹see page 52 ²not available for switch type CA20

Dimensions mm
 inch

Wall Mounting, Escutcheon Plates and Additional Length

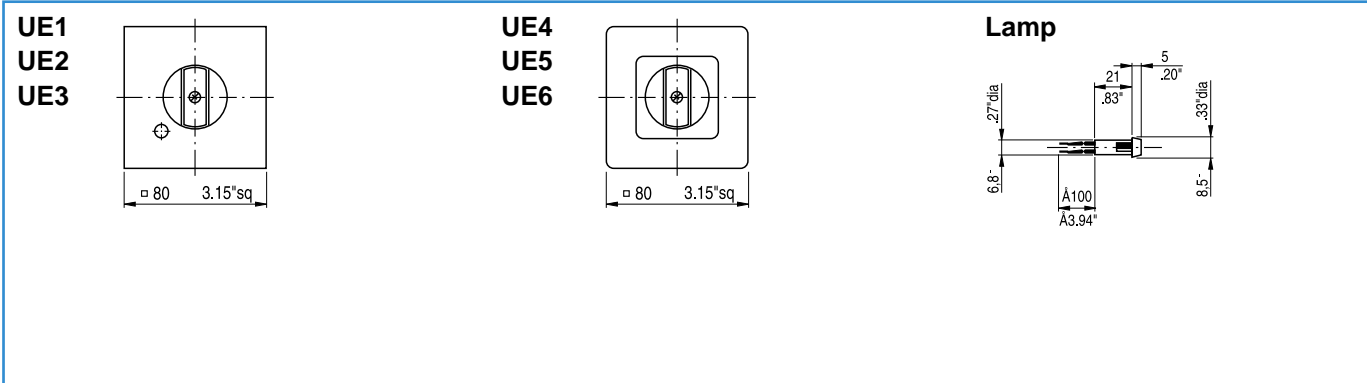

Escutcheon plates for mounting E, EF, ER, ERF, EG, EGF, KN1, KD1, KN2, EC, EC1, ED, ED1, VE, VE1, VF

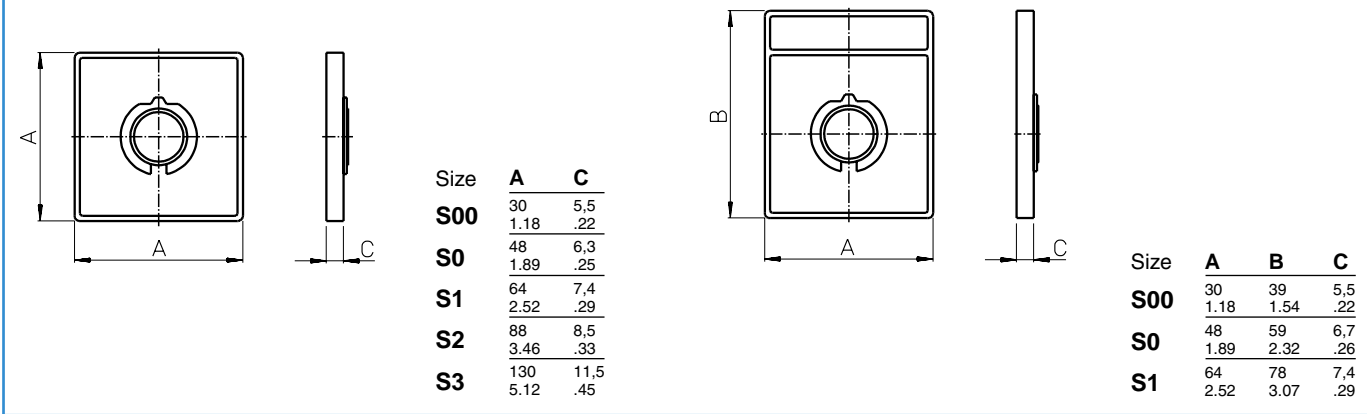

Additional length for amendment (page 4)

	CAD11	CAD12	CA10 CA11 CA20 CA25	C26	C32	C42	CA40 CA50 CA63
S0 switches with latching mechanism size S1	5,4 .21	-	-	-	-	-	-
S1 switches with latching mechanism size S2	-	-	-	9,2 .36	9,2 .36	-	8,2 .32
with snap action	-	14,3 .56	12,2 .48	12,2 .48	12,2 .48	-	in preparation

Quick connects for switches CA4-4



Dimensions mm
 inch

Additional Length

Terminal lugs for switches C200-4-, C315, C316 and L switches

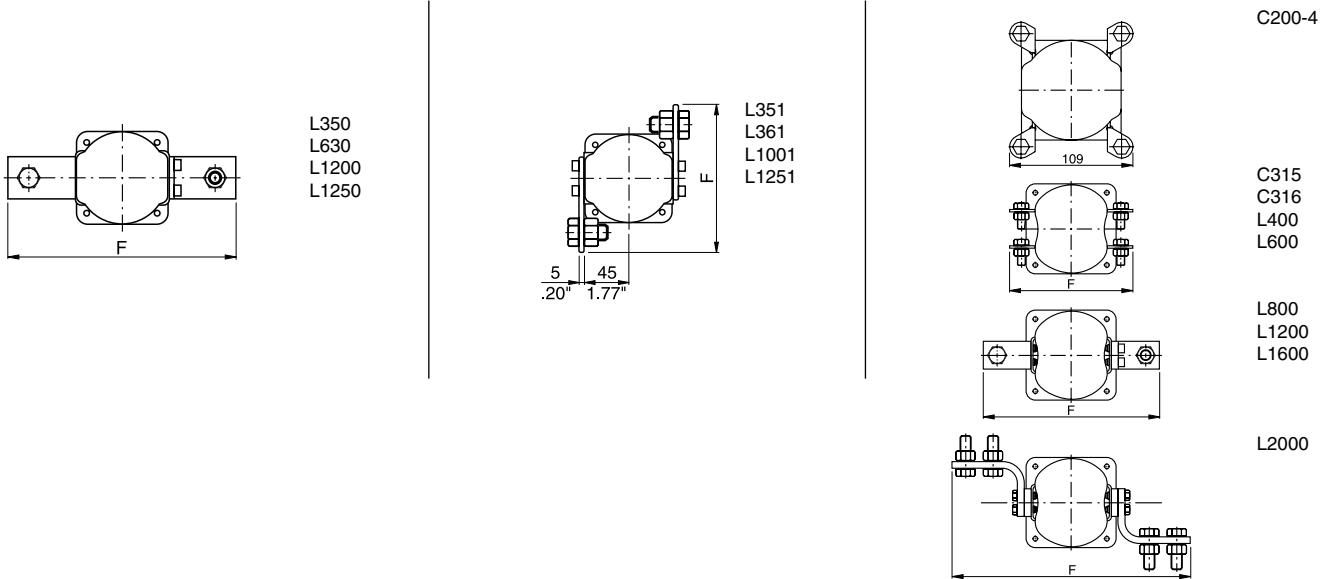

	L350	L630	L1000	L1250	L351	L631	L1001	L1251	C315 C316	L400	L600	L800 L1200	L1600 L2000
F	190 7.48	220 8.66	230 9.06	240 9.45	138 5.43	148 5.83	148 5.83	148 5.83	150 5.91	180 7.09	208 8.19	256 10.08	326 12.83

Length L

Stages	CA4		CA10												CA40		C125		C315	
	CA4-1	CAD11	CA11	CA20	CA25	CA10B	CA11B	CA20B	CA25B	C26	C32	C42	C43	CA63	C80	Size S2	Size S3	L switches	L switches	
1	30 1.18	33,5 1.32	36,7 1.44	37,7 1.48	39 1.51	38,9 1.53	42,1 1.66	43,1 1.75	44,4 1.75	42 1.65	46,8 1.84	50,8 2.00	59 2.32	42,5 1.67	61,5 2.42	67,5 2.66	78,6 3.09			
2	38 1.50	43 1.69	49,4 1.94	50,4 1.98	53 2.09	48,4 1.91	54,8 2.16	55,8 2.20	58,4 2.30	54,7 2.15	64,3 2.51	72,3 2.85	80,5 3.17	55,2 2.17	88,0 3.46	100 3.94	117,2 4.61			
3	46 1.81	52,5 2.07	62,1 2.44	63,1 2.48	67 2.64	57,9 2.28	67,5 2.66	68,5 2.70	72,4 2.85	67,4 2.65	81,8 3.22	93,8 3.69	102 4.02	67,9 2.67	114,5 4.51	132,5 5.22	155,8 6.13			
4	54 2.13	62 2.44	74,8 2.94	75,8 2.98	81 3.19	67,4 2.65	80,2 3.16	81,2 3.20	86,4 3.40	80,1 3.15	99,3 3.91	115,3 4.54	123,5 4.86	80,6 3.17	141 5.55	165 6.50	194,4 7.65			
5	62 2.44	71,5 2.81	87,5 3.44	88,5 3.48	95 3.74	76,9 3.03	92,9 3.66	93,9 3.70	100,4 3.95	92,8 3.65	116,8 4.60	136,8 5.39	145 5.71	93,3 3.67	167,5 6.59	197,5 7.78	233 9.17			
6	70 2.76	81 3.19	100,2 3.94	101,2 3.98	109 4.29	86,4 3.40	105,6 4.16	106,6 4.20	114,4 4.50	105,5 4.15	134,3 5.29	158,3 6.23	166,5 6.56	106 4.17	194 7.64	230 9.06	271,6 10.69			
7	78 3.07	90,5 3.56	112,9 4.44	113,9 4.48	123 4.84	95,9 3.78	118,3 4.66	119,3 4.70	128,4 5.05	118,2 4.65	151,8 5.98	179,8 7.08	188 7.40	118,7 4.67	220,5 8.68	262,5 10.33	310,2 12.21			
8	86 3.39	100 3.94	125,6 4.94	126,6 4.98	137 5.39	105,4 4.15	131 5.16	132 5.20	142,4 5.60	130,9 5.15	169,3 6.67	201,3 7.93	209,5 8.25	131,4 5.17	247 9.72	295 11.61	348,8 13.73			
9	94 3.70	109,5 4.31	138,3 5.44	139,3 5.48	151 5.94	114,9 4.52	143,7 5.66	144,7 5.70	156,4 6.15	143,6 5.65	186,8 7.36	222,8 8.77	231 9.09	144,1 5.67	273,5 10.77	327,5 12.89	387,4 15.25			
10	-	119 4.68	151 5.94	152 5.98	165 6.50	124,4 4.90	156,4 6.16	157,4 6.20	170,4 6.70	156,3 6.15	204,3 8.04	244,3 9.62	252,2 9.54	156,8 6.17	300 11.81	360 14.17	426 16.77			
11	-	128,5 5.06	163,7 6.44	164,7 6.48	179 7.05	133,9 5.27	169,1 6.66	170,1 6.70	184,4 7.25	169 6.65	221,8 8.73	265,8 10.46	274 10.79	169,5 6.67	326,5 12.85	392,5 15.45	464,6 18.29			
12	-	138 5.43	176,4 6.94	177,4 6.98	193 7.60	143,4 5.65	181,8 7.16	182,8 7.20	198,4 7.80	181,7 7.15	239,3 9.42	287,3 11.31	295,5 11.63	182,2 7.17	353 13.90	425 16.73	503,2 19.81			

The Range of “Blue Line” Switchgear

Technical literature covering the following products is available on request.

	Catalog Number
Main Switches and Main Switches with Emergency Function 16 A-315 A Maintenance Switches 20 A-315 A Switch Disconnectors 20 A-315 A According to IEC 60947-3, EN 60947-3, VDE 0660 part 107, IEC 60204, EN 60204 and VDE 0113	500
C, CA and CAD Switches 10 A-315 A and L Switches 350 A-2400 A C, CA and CAD switches are designed for universal application. They are recommended for instrument, isolator, double-throw and motor control. L switches are designed for load and off-load applications. They are used to switch resistive or low inductive loads.	100
Optional Extras and Enclosures The complete product line, a large number of optional extras is available, including door interlocks, push-pull devices, cylinder and padlock attachments, control and indicator devices, AC motor drives, as well as enclosures, both insulated and metal.	101
A and AD Switches 6 A-25 A A and AD switches have 4 contacts in each switching stage. These switches provide an extensive range of switch functions and require a minimum mounting depth. Up to 24 switching positions are possible, with availability of 48 contacts per 12 stage switch column.	110
CG, CH and CHR Switches 10 A-25 A Ultra compact CG, CH and CHR switches are ideally suited for control and instrumentation applications. Switch terminals are “finger-proof” and conveniently accessible for wiring and are delivered open. All CG4 switches offer specially designed gold plated contacts or H-bridges with “cross-wire” contact systems, which facilitates their use in electronic circuitry and chemically aggressive environments.	120
DH, DHR, DK and DKR Switches 6 A-16 A DH, DHR, DK and DKR switches incorporate unique corrosion resistant contacts that permit operation on system voltage as low as 1 V. They have fully enclosed and protected contacts which can be operated either by rotary and/or lateral handle movement. D switches are used in calibration and semiconductor circuits. They are also used for relay and contactor control.	130
X Switches 200 A-630 A X switches can be applied for load, tap and gang switching duties. They incorporate 6 contacts in each switching stage. Their compact design provides a minimum length dimension for mounting purposes.	140
KG Switches 20 A-315 A and KH and KHR Switches 16 A-80 A KG, KH and KHR switches are excellent circuit interruptors. They have high through fault and fault making capacities and are especially designed for use as isolators and safety switches for machine tools, distribution panels and switchboards. KG ON/OFF switches offer unusually high dimensioned air and creepage distances between terminals which are designed for time saving “straight-line” wiring. ON/OFF switches are available with up to 8 poles and double-throw switches are available with up to 4 poles.	150
Push Buttons and Pilot Lights, 22,5 mm Ø A complete range of state-of-the-art push buttons and pilot lights represent an ideal combination of functional security and economical efficiency in a modular design.	302

SALES AND SERVICE ORGANIZATION

Australia

Kraus & Naimer Pty. Ltd.
379 Liverpool Road, ASHFIELD, N.S.W. 2131
Tel: +61 2 9797-7333, Fax: 0092
salesaus@krausnaimer.com

Austria

Kraus & Naimer GmbH
Schumanngasse 35, Postfach 431
A-1181 WIEN
Tel: +43 1 404 06-0, Fax: 404 06-190
aso@krausnaimer.com

Belgium, Luxembourg

Kraus & Naimer B.V.
Ikaros Business Park
Ikaroslaan 2
B-1930 ZAVENTHEM
Tel: +32 2 757-0141, Fax: 1640
sales.be@krausnaimer.com

Brazil

Central and South America
Kraus & Naimer Ind. Com. Ltda.
Rua Santa Monica, 1061
Parque Industrial San Jose
06715-865 Cotia - SP
Tel: +55 11 2198-1288, Fax: 1251
knbrasil@krausnaimer.com.br

Canada

Kraus & Naimer Ltd.
219 Connie Crescent, Unit: 13A
CONCORD, Ontario, L4K 1L4
Tel: +1 905 738-1666, Fax: 9327
salescan@krausnaimer.com

Cyprus

ELECTROMATIC CONSTRUCTIONS LTD.
72, Evagoras Pallikarides Str., CY-2235 LATSIA-Nicosia
P. O. Box 12630, CY-2251 LATSIA-Nicosia
Tel: +357 2 48 41 41, Fax: 48 57 47

Czech Republic

OBZOR, výrobní družstvo Zlín
Na Slanici 378
CZ-76413 ZLÍN
Tel: +420 57 7195-111/-153 (Techn. Supp.)
Fax: +420 57 7195-152/-138
ots@obzor.cz

Denmark

THIIM A/S
Transformervej 31
DK-2730 HERLEV
Tel: +45 4485 8000, Fax: 8005
thiim@thiim.com

Finland

Kraus & Naimer Oy
Karitie 7
FIN-01530 VANTAA
Tel: +358 9 825-424-0, Fax: 424-10
myynti@krausnaimer.com

France

Kraus & Naimer s.a.s.
33, rue Bobillot
F-75013 PARIS
Tél: +33 1 58 40 80 80, Fax: 45 80 91 19
ventes@krausnaimer.com

Germany

Kraus & Naimer GmbH
Wikingerstraße 20-28, D-76189 KARLSRUHE
Postfach 10 01 24, D-76231 KARLSRUHE
Tel: +49 721 59 88-0, Fax: 59 28 28
sales.ger@krausnaimer.com

Great Britain

Kraus & Naimer Ltd.
115 London Road
NEWBURY/BERKSHIRE RG14 2AH
Tel: +44 1635 262626, Fax: 37807
sales-uk@krausnaimer.com

Greece

KALAMARAKIS-SAPOUNAS S. A.
Ionias & Neromilou Str., P. O. Box 46566
GR-13671 ACHARNES/ATHENS
Tel: +30 2 10 240-6000-6, Fax: 240-6007
kalamarakis.sapounas@ksa.gr

Hungary

GANZ, Schalter- u. Gerätefabrik
X. Kőbányal út 41/c, Postfach 87
H-1475 BUDAPEST
Tel: +36 1 261-5479, Fax: 4685
ganzkk@ganzkk.hu

Iceland

BRAEDURNIR ORMSSON EHF
Lágmúli 6-9, P. O. Box 8670
REYKJAVIK
Tel: +354 530-28 00, Fax: 28 10
skuli@ormsson.is

India

Liaison Office, Kraus & Naimer Pte. Ltd.
10B, 1st Floor, Infinity,
Ashar Commercial Complex, Gladly Alwares Road
Off Pokhran Road no. 2,
THANE (W) 400 610
Tel: +91 22 66716451, Fax: 66716451
india@krausnaimer.com

Republic of Ireland

Kraus & Naimer Ltd.
Bay 145, Shannon Free Zone
SHANNON, Co. Clare
Tel: +353 61 704700, Fax: 471084
sales-ie@krausnaimer.com

Italy

Kraus & Naimer s.r.l.
Via Terracini, 9
I-24047 TREVIGLIO (BG)
Tel: +39 0363-30 11 12, Fax: 30 21 13
sales-ita@krausnaimer.com

Japan

Kraus & Naimer Ltd.
Yoshiwada Building 2F
1-11-6 Hamamatsucho
Minato-Ku, TOKYO 105-0013
Tel: +81 3 3436-6151, Fax: 6325
sales-jpn@krausnaimer.com

Mexico

JC Ingeniería y Control, SA de CV.
Ángel Gaviño 30,
C. Satélite, C. Medicos,
Naucalpan Edo. de Mexico, C.P. 53100
Tel. (+52 55) 55 62 75 77, Fax. 55 62 04 34
ventas@jcingenieriacontrol.com

Middle East - UAE

Branch Office, Kraus & Naimer Pte. Ltd.
SAIF Zone, P. O. Box 121607,
Sharjah, UAE
Tel: +971 6 557 8886
Fax: +971 6 557 8088
uae@krausnaimer.com

Netherlands

Kraus & Naimer B.V.
Wegtersweg 38-40, Postbus 199
NL-7556 BR HENGEL0 (Ov.)
Tel: +31 74 291-9441, Fax: 8380
sales.nl@krausnaimer.com

New Zealand

Kraus & Naimer Ltd.
42 Miramar Avenue, WELLINGTON 6022
P. O. Box 15-009, WELLINGTON 6243
Tel: +64 4 380-9888, Fax: 9877
sales-nz@krausnaimer.com

Norway

Kraus & Naimer AS
Hjalmar Brantings vei 8, P. O. Box 21, Økern
N-0508 OSLO
Tel: +47 22 64 44 20, Fax: 65 39 49
ordre.no@krausnaimer.com

Poland

ASTAT sp. z o.o.
ul. Dąbrowskiego 461
PL-60451 POZNAN
Tel: +48 61 848-8871/72, Fax: 8276
info@astat.com.pl

Portugal

ELECTRICOL-DAMAS, FERREIRA & DAMASCENO, LDA.
Apartado 1063, S. Ant. Cavaleiros
P-2670 LOURES
Tel: +351 21 989-8939, Fax: 988-6464
Im.emertex@electricol.pt

Singapore

Kraus & Naimer Pte. Ltd.
Blk 115A, Commonwealth Drive
#03-17/23
SINGAPORE 149 596
Tel: +65 6473-8166, Fax: 8643
sgp@krausnaimer.com

Slovenia

SCHRACK Technik d.o.o.
Pameče 175
SI-2380 Slovenj Gradec
Tel: +386 2 883 92 00, Fax: +386 2 884 34 71
m.abeln@schrack.si

Republic of South Africa

Kraus & Naimer Pty. Ltd.
7 Village Crescent, Linbro Village
Linbro Business Park, SANDTON 2065
P. O. Box 511, KELVIN 2054
Tel: +27 11 608-6060, Fax: 608-2874
salesZAF@krausnaimer.com

Spain

HAZEMEYER HES. S.L.
Pol. Ind. Gaserans
Sector 3, Parcela 7B
17451 SANT FELIU DE BUIXALLEU (GIRONA)
Tel: +34 972 87-4450, Fax: 87-4402
hazemeyer@grupo-hes.net

Sweden

Kraus & Naimer AB
Dr. Widerströms Gata 11, FRUÅNGEN
Box 42097, S-126 14 STOCKHOLM
Tel: +46 8 97 00 80, Fax: 97 87 33
order.se@krausnaimer.com

Switzerland

AWAG Elektrotechnik AG
Sandbühlstraße 2, Postfach
CH-8604 VOLKETSCHWIL
Tel: +41 44 908 19 19, Fax: 19 99
info@awag.ch, www.awag.ch

Turkey

KARDEŞ ELEKTRİK SANAYİ VE TİCARET ANONİM ŞİRKETİ
Beşyol, Eski Londra Asfaltı-6
TR-34295 İSTANBUL-Sefaköy
Tel: +90 212 624-9204, Fax: 592-4810
info@unalkardes.com.tr

USA

Kraus & Naimer Inc.
760 New Brunswick Road
SOMERSET, NJ 08873
Tel: +1 732 560-1240, Fax: 8823
salesusa@krausnaimer.com



Kraus & Naimer

BLUE LINE switchgear



YOUR SALES CONTACT



Kraus & Naimer Produktion GmbH

A-1181 Wien · Schumanngasse 31-39 · PF 0046
Telefon: +43 1 404 06 · Telefax: +43 1 404 06 255
knw@krausnaimer.com · www.krausnaimer.com
124765 d · UID-Nr. ATU 14707101