

massive

massive

Home lighting at your convenience **2011**



# Свет с Massive

**Добро пожаловать в Massive 2011!** - Новая коллекция отличается не только широким выбором изделий, высоким качеством и оптимальным соотношением цены и качества, к которым вы привыкли: в этом году компания Massive представляет технологию будущего! Теперь во всех семействах продуктов Massive предлагаются светильники со встроенными светодиодами PowerLED с великолепным дизайном по разумной цене. Поэтому, если вы хотите создать освещение для домашнего интерьера с помощью качественных светильников по доступной цене, прилагая минимум усилий, то Massive — этот тот бренд, который вам нужен. На упаковке четко указано, как и где следует использовать освещение, а наглядные инструкции предельным образом упрощают установку изделий Massive. Благодаря вернувшейся популярности европейского стиля и качеству сборки Massive — это заслуживающий доверия бренд, изделия которого позволяют создавать подходящие системы освещения. Здесь соблюдаются все стандарты и нормы безопасности; более того, многие светильники Massive включают в себя лампы Philips, что обеспечивает высокое качество и надежное освещение на многие годы. Изделия Massive доступны в широком ассортименте для коммунального и декоративного освещения дома и в саду, причем каждое из них идеально соответствует своему назначению. Изящество и функциональность по разумной цене — вот что позволяет компании Massive производить удобные системы освещения, которые пользуются спросом.







# Содержание

## Коллекции для внутреннего освещения

1   Декоративные светильники	15
2   Настенные и потолочные светильники	149
3   Светильники акцентного освещения	205

## Концепции для интерьера

4   Top Selection – Премиальные светильники	259
5   Aqua – Светильники для ванных комнат	289
6   Cucina – Светильники для кухни	319
7   Kico – Светильники для детских комнат	331
8   Studio – Настольные светильники	351

## Коллекция светильников для улицы

9   Серия уличных светильников	367
--------------------------------	-----

## Функциональное освещение

10   Светильники направленного освещения	433
--	-----

Список позиций по артикулам	455
-----------------------------	-----

Техническая информация

# POWERLED

## Новая технология

**PHILIPS**

LED integrated

*PowerLED — это источник света будущего, но вы можете пользоваться им уже сегодня: в этом году компания Massive предлагает совершенно новую серию светильников PowerLED. Поскольку мы стремимся предлагать освещение наивысшего качества, то компания Massive использует технологию Philips PowerLED в своих инновациях.*

Светодиоды PowerLED имеют следующие преимущества:

  
**Экономят**  
энергию

### Экономия энергии

Светодиоды Philips PowerLED очень экономичны: они сберегают до 80% энергии по сравнению с традиционными лампами.



### Высокая мощность светового потока

Светодиоды PowerLED не оставят вас в темноте. Светодиодный модуль PowerLED на 7,5 Вт дает 300 люмен светового потока, что сравнимо со световой мощностью обычной лампы на 40 Вт.



### Теплый белый свет (2700 K)

Прощайте, синие светодиоды! Светильник Massive PowerLED излучает приятный теплый белый свет. Мы используем исключительно светодиоды PowerLED с цветовой температурой 2700 K.



### Возможность регулировки яркости

Во многих светильниках PowerLED можно регулировать яркость и тем самым создавать нужное настроение в домашнем интерьере. Светодиоды PowerLED несовместимы со светорегуляторами по переднему фронту, поэтому необходимо использовать регуляторы по заднему фронту. Это указывается в каталоге, когда изделие PowerLED допускает регулировку.



### Долгий срок службы (20 000 часов)

Светильник со встроенными светодиодами PowerLED работает до 20 000 часов, поэтому забудьте о трудностях и затратах, связанных с заменой разбитых ламп, и переходите на PowerLED — источник света, за которым будущее.



p.16-17 Mendel



p.16-17 Mendel



p.16-17 Mendel



p.18-19 Fuxe



p.18-19 Fuxe



p.18-19 Fuxe



p.20 Fresnel



p.20 Fresnel



p.20 Fresnel



p.21 Garaudy



p.21 Garaudy



p.206-207 Orbits



p.206-207 Orbits



p.206-207 Orbits



p.208-209 Orbits



p.208-209 Orbits



p.208-209 Orbits



p.262-263 Vision



p.262-263 Vision



p.262-263 Vision

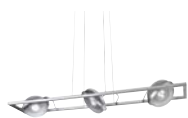

p.262-263 Vision



p.264-265 Hyves



p.264-265 Hyves



p.264-265 Hyves



p.266 Pauline



p.266 Louise



p.267 Louise



p.268 Pauline



p.269 Leah



p.269 Leah



p.354 Jarno



p.354-355 Nathan



p.370 Gotha



p.370 Gotha



p.370 Pori



p.371 Stavanger



p.371 Lyon



p.371 Messina



p.371 Slagelse



# Коллекции для внутреннего освещения

---



# Massive

## Свет, как образ жизни

*Сегодня украшение дома чрезвычайно популярно. Люди все больше осознают, что их интерьер характеризует их самих, и тратят много времени на его улучшение. Оформление, представленное в магазинах и салонах, дает вдохновение для постоянно развивающихся стилей. Компания Massive — привлекательный партнер для всех, кто занимается декорированием, так как предлагает подходящие светильники различных стилей по разумной цене.*

### Классификация по стилям

Наряду с концепциями для интерьеров, например AQUA, CUCINA и KICO, компания Massive предлагает целую коллекцию интерьерных светильников. Чтобы помочь потребителю найти идеальный светильник, коллекция разбивается на четыре группы согласно стандарту ISIS. ISIS расшифровывается как "Международная классификация по стилям" (International Segmentation Into Styles) и представляет собой инструмент для помощи заказчику в выборе наиболее подходящего стиля. В этой классификации существует четыре стиля: "Современный дизайн" (Contemporary Design), "Мульти" (Multi), "Шарм" (Charm) и "Аутентичный" (Authentic).



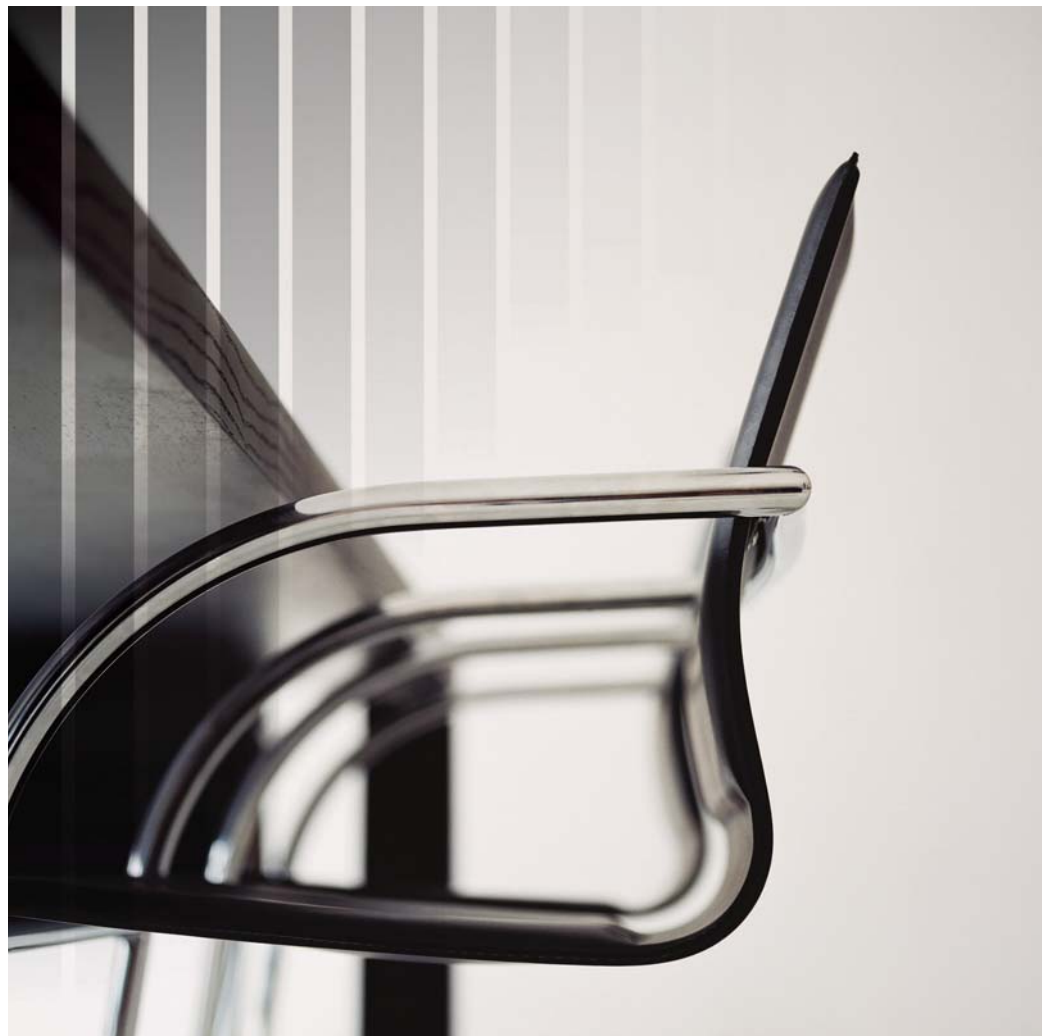

## Современный дизайн

Стиль "Современный дизайн" от компании Massive отличается изысканной простотой в современной манере, сочетая в себе минимализм и тонкий вкус. Изделия этого стиля дают ощущение творческого духа, новизны, процветания и гармонии.



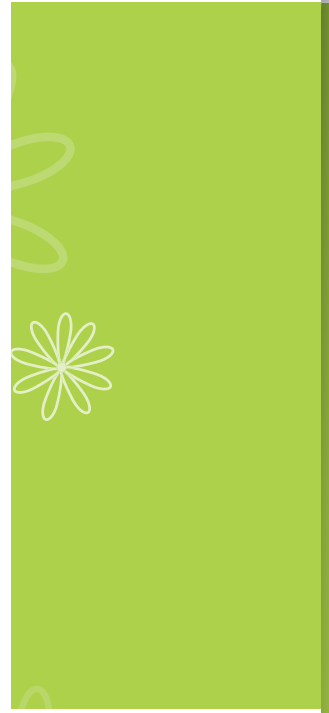

## Мульти

*Веселый и вольный стиль "Мульти" играет всеми красками жизни. Это буйство цветов и форм, которое всюду несет с собой энергию, игнорируя условности, ярко сверкает и освежает все вокруг, заряжая оптимизмом и счастьем.*



## Шарм

Интерьер в мягком и чувственном стиле "Шарм" с элементами абстракции наполняется романтизмом и страстью. Изящные и роскошные изделия по доступной цене, выполненные в элегантном стиле неоклассицизма или необарокко, создают интимную обстановку с оттенком ностальгии.

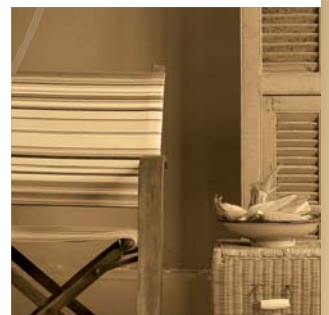

## Аутентичный

Идеи этого стиля уходят своими корнями к истокам культуры. Этот привычный стиль легко узнать, он отражает бесконечную гармонию и традиционные вкусы, сложившиеся в истории мировой культуры. Уютные интерьеры, выдержанные в этом строгом и подлинном стиле, создают успокаивающую и гостеприимную атмосферу.



# Декоративные светильники

---



1  
POWERLED

 **ЭКОНОМЯТ**  
энергию

## Mendel

 1 | 37865/11/10

**LED PHILIPS 7,5W INCL.** | PowerLED

3x LED | max. 7,5W |  SELV | 

 | 1500 | ↔ 990 | ↗ 160 |



POWERLED



Экономят энергию 

**Mendel**

1 | 37865/31/10

LED PHILIPS 7,5W INCL. | PowerLED  
3x LED | max. 7,5W | SELV

| 1500 | 990 | 160 |

ALU MET

**Mendel**

2 | 37866/11/10

3 | 37866/31/10

LED PHILIPS 7,5W INCL. | PowerLED  
3x LED | max. 7,5W | SELV

| 1500 | 500 | 500 |

ALU MET

**Mendel**

4 | 37867/11/10

5 | 37867/31/10

LED PHILIPS 7,5W INCL. | PowerLED  
2x LED | max. 2,5W | SELV

| 130 | 305 | 87 |

ALU MET

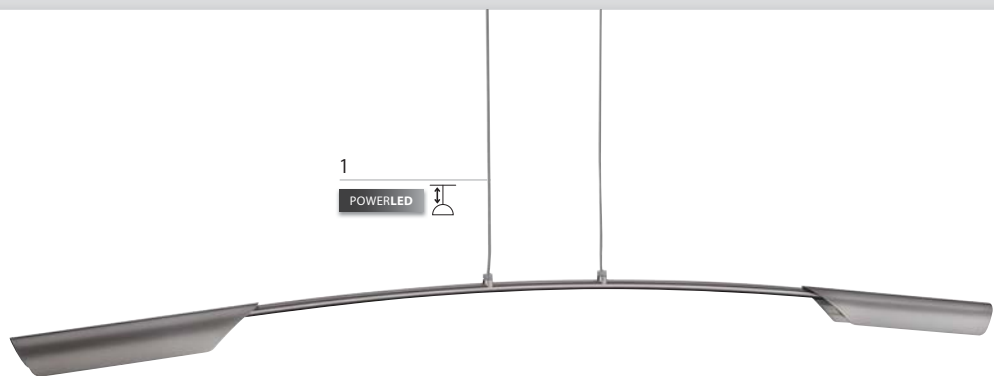

POWERLED

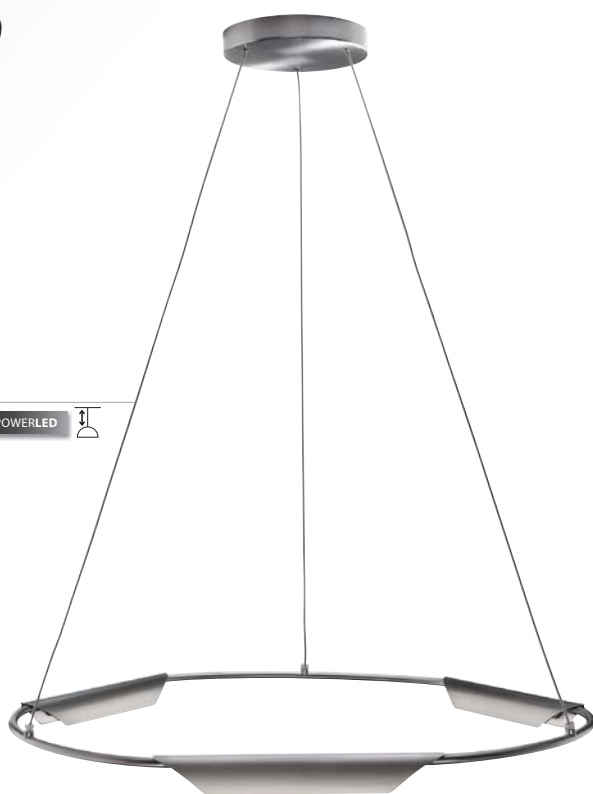

 **Экономят**  
энергию

**Foxe**

 1 | 37950/17/10

**LED PHILIPS 7,5W INCL.** | PowerLED

2x LED | max. 7,5W |  | 

 | 1 1600 | ↔ 1004 | ↗ 160 |

Доступно начиная с июля 2011

**Foxe**

 2 | 37951/17/10

**LED PHILIPS 7,5W INCL.** | PowerLED

3x LED | max. 7,5W |  | 

 | 1 1580 | ↔ 630 | ↗ 630 |

Доступно начиная с июля 2011

**Foxe**

 3 | 37954/17/10

**LED PHILIPS 7,5W INCL.** | PowerLED

1x LED | max. 7,5W |  | 

 | 1 470 | ↔ 194 | ↗ 498 |

Доступно начиная с июля 2011



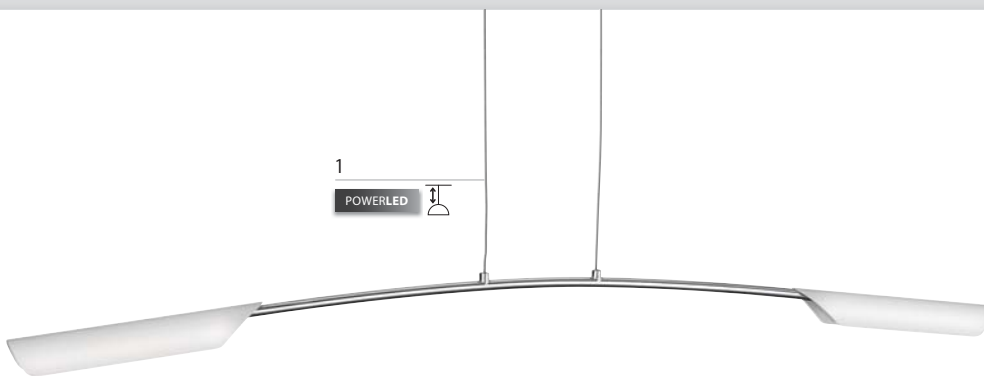

POWERLED



Экономят энергию 

Foxe

1 | 37950/31/10

LED PHILIPS 7,5W INCL. | PowerLED

2x LED | max. 7,5W |  SELV | 

 | ↓ 1600 | ↔ 1004 | ↗ 160 |

ALU  MET

Доступно начиная с июля 2011

Foxe

2 | 37951/31/10

LED PHILIPS 7,5W INCL. | PowerLED

3x LED | max. 7,5W |  SELV | 

 | ↓ 1580 | ↔ 630 | ↗ 630 |

ALU  MET

Доступно начиная с июля 2011

Foxe

3 | 37954/31/10

LED PHILIPS 7,5W INCL. | PowerLED

1x LED | max. 7,5W |  SELV | 

 | ↓ 470 | ↔ 194 | ↗ 498 |

ALU  MET

Доступно начиная с июля 2011

massive



POWERLED



Декоративные светильники  
20

 **Экономят**  
энергию

### Fresnel

 1 | 37955/48/10

LED PHILIPS 7,5W INCL. | PowerLED

2x LED | max. 7,5W |  SELV | 

 | 1600 | ↔ 600 | ↙ 90 |



Доступно начиная с июля 2011

### Fresnel

 2 | 37956/48/10

LED PHILIPS 7,5W INCL. | PowerLED

3x LED | max. 7,5W |  SELV | 

 | 1600 | ↔ 900 | ↙ 90 |



Доступно начиная с июля 2011

### Fresnel

 3 | 37957/48/10

LED PHILIPS 7,5W INCL. | PowerLED

1x LED | max. 7,5W |  SELV | 

 | 183 | ↔ 250 | ↙ 72 |



Доступно начиная с июля 2011

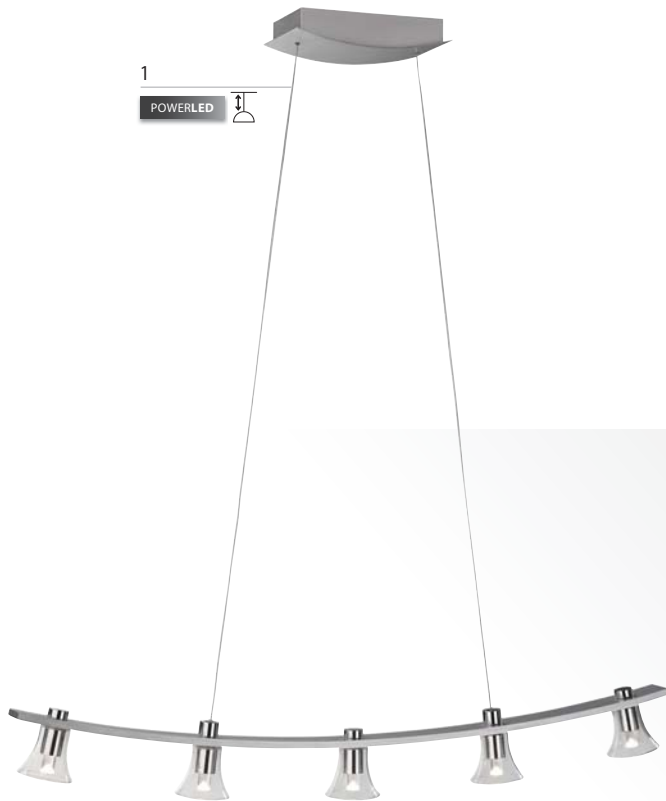

POWERLED



Декоративные светильники

21

### Garaudy

1 | 40595/48/10

LED PHILIPS 5W INCL. | PowerLED

5x LED | max. 5W | SELV | ⊕

Y | | 1600 | ← 834 | ↗ 120 |



Доступно начиная с июля 2011

### Garaudy

2 | 40596/48/10

LED PHILIPS 5W INCL. | PowerLED

6x LED | max. 5W | SELV | ⊕

Y | | 1600 | ← 707 | ↗ 324 |



Доступно начиная с июля 2011

Экономят  
энергию



1



3



2



**Aiken**

1 | 37650/17/10

20W INCL.

4x G4 | max. 20W | 230V 12V | Ⓟ

| 1400 | ↔ 624 | ↙ 66 |



**Aiken**

2 | 37651/17/10

20W INCL.

5x G4 | max. 20W | 230V 12V | Ⓟ

| 1400 | ↔ 814 | ↙ 66 |



**Aiken**

3 | 37653/17/10

20W INCL.

5x G4 | max. 20W | 230V 12V | Ⓟ

| 1550 | ↔ 250 | ↙ 180 |





## Aiken

■ 1 | 37652/17/10

 20W INCL.

2x G4 | max. 20W |  $\frac{230V}{12V}$  |  $\ominus$

 | 180 |  $\leftarrow$  180 |  $\swarrow$  122 |



2



3

1

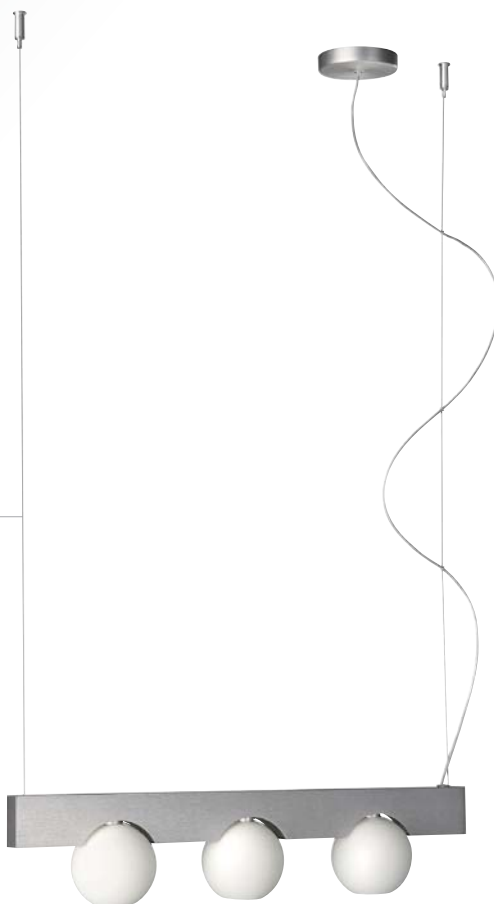

4



Menelaus

1 | 37510/48/10

PHILIPS 40W INCL.

3x G9 | max. 60W | 230V | Ⓢ

Y | | 1400 | ↔ 604 | ↗ 110 |



Menelaus

2 | 37511/48/10

PHILIPS 40W INCL.

5x G9 | max. 60W | 230V | Ⓢ

Y | | 1400 | ↔ 949 | ↗ 110 |



Menelaus

3 | 37512/48/10

PHILIPS 40W INCL.

1x G9 | max. 60W | 230V | Ⓢ

Y | | 100 | ↔ 204 | ↗ 132 |



Menelaus

4 | 37515/48/10

PHILIPS 40W INCL.

3x G9 | max. 60W | 230V | Ⓢ

Y | | 136 | ↔ 564 | ↗ 110 |



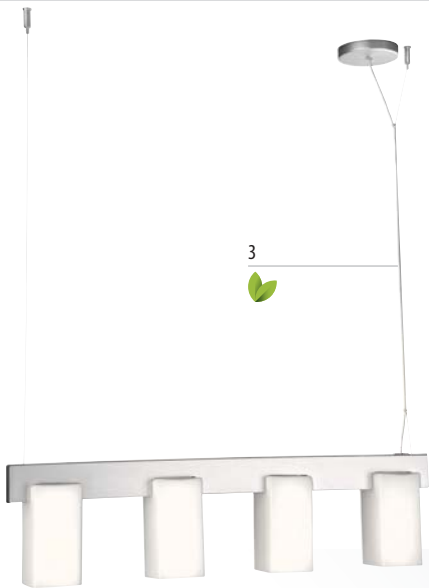



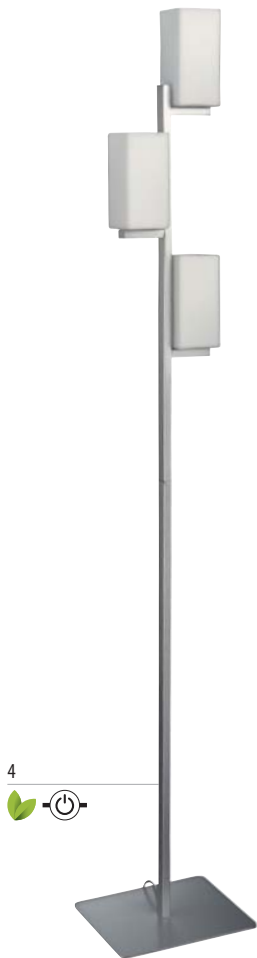









Экономят энергию 









Ediso

	1   37655/31/10
	<b>PHILIPS 23W INCL.</b>
	2x E27   max. 23W   230V   
	1643   ↔ 716   ↗ 116
	







Ediso

	2   37657/31/10
	<b>PHILIPS 11W INCL.</b>
	2x E14   max. 11W   230V   
	100   ↔ 350   ↗ 68
	

Khama

	3   37675/48/10
	<b>PHILIPS 11W INCL.</b>
	4x E14   max. 40W   230V   
	1708   ↔ 743   ↗ 110
	

Khama

	4   37678/48/10
	<b>PHILIPS 11W INCL.</b>
	3x E14   max. 40W   230V   
	1609   ↔ 270   ↗ 230
	



Декоративни лампички

26



### Kasavu

1 | 37460/31/10

 **PHILIPS 11W INCL.**

1x E27 | max. 11W | 230V | 

 | ↑ 1500 | ↔ 120 | ↙ 120 |



### Kasavu

2 | 37461/31/10

 **PHILIPS 11W INCL.**

3x E27 | max. 11W | 230V | 

 | ↑ 1500 | ↔ 670 | ↙ 120 |





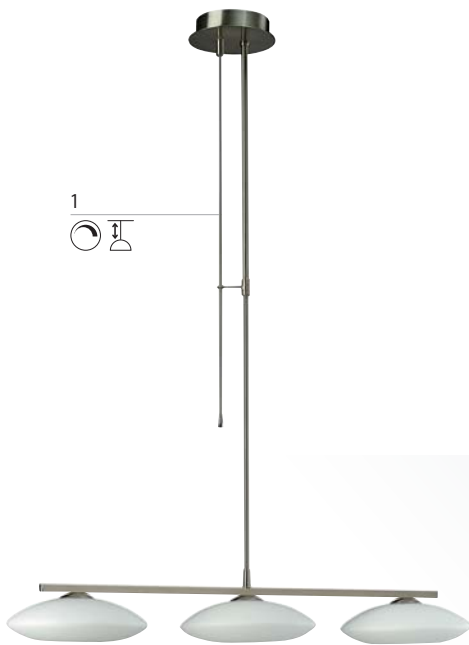

### Christian

■	1   36561/17/10
💡	<b>PHILIPS 40W INCL.</b>
	3x G9   max. 40W   230V   Ⓢ
↕	1270   ↔ 690   ↙ 195
MET	🚚

### Caplet

■	2   40430/17/10
💡	<b>PHILIPS 40W INCL.</b>
	3x G9   max. 40W   230V   Ⓢ
↕	1970   ↔ 810   ↙ 190
MET	🚚

### Baldasso

■	3   41593/31/10
💡	<b>7W INCL.</b>
	3x E14   max. 9W   230V   Ⓢ
↕	1500   ↔ 880   ↙ 200
MET	🚚

Экономят энергию

2



3



1



Draco

1 | 37160/31/10

PHILIPS 8W INCL.

1x E14 | max. 60W | 230V | Ⓢ

| ↑ 1300 | ↔ 130 | ↘ 130 |



Draco

2 | 37165/31/10

PHILIPS 8W INCL.

3x E14 | max. 60W | 230V | Ⓢ

| ↑ 1500 | ↔ 260 | ↘ 260 |



Draco

3 | 37166/31/10

PHILIPS 8W INCL.

4x E14 | max. 60W | 230V | Ⓢ

| ↑ 1500 | ↔ 1006 | ↘ 105 |





4

1



3



2

**Dosel**

1 | 36230/17/10

1x E27 | max. 75W | 230V | Ⓢ

Y | | 1300 | ← 215 | ↗ 215 |



**Dosel**

2 | 36231/17/10

1x E27 | max. 75W | 230V | Ⓢ

Y | | 1350 | ← 300 | ↗ 300 |



**Juliana**

3 | 36235/17/10

1x E27 | max. 75W | 230V | Ⓢ

Y | | 1350 | ← 170 | ↗ 170 |



**Juliana**

4 | 36236/17/10

3x E14 | max. 40W | 230V | Ⓢ

Y | | 1300 | ← 880 | ↗ 135 |



3



1



2



4



Dillo

1 | 36300/17/10

5x E14 | max. 40W | 230V | Ⓢ

Y | | 1125 | ↔ 620 | ↗ 620 |



Dillo

2 | 36302/17/10

1x E14 | max. 40W | 230V | Ⓢ

Y | | 225 | ↔ 150 | ↗ 225 |



Agnon

3 | 37380/87/10

1x E27 | max. 60W | 230V | Ⓢ

Y | | 1500 | ↔ 178 | ↗ 178 |



Agnon

4 | 37381/87/10

1x E27 | max. 75W | 230V | Ⓢ

Y | | 1500 | ↔ 295 | ↗ 295 |



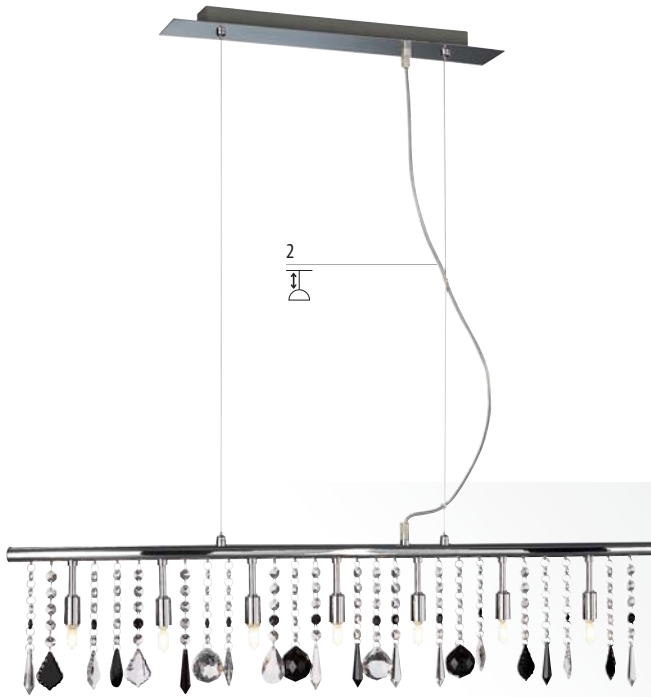

3



**Baldwin**

1 | 41632/11/10

3x E14 | max. 40W | 230V | Ⓢ

Y | T 220 | ← 300 | ↗ 300 |



**Nostri**

2 | 41633/11/10

PHILIPS 25W INCL.

7x G9 | max. 25W | 230V | Ⓢ

Y | T 1500 | ← 830 | ↗ 200 |



**Nostri**

3 | 41634/11/10

PHILIPS 25W INCL.



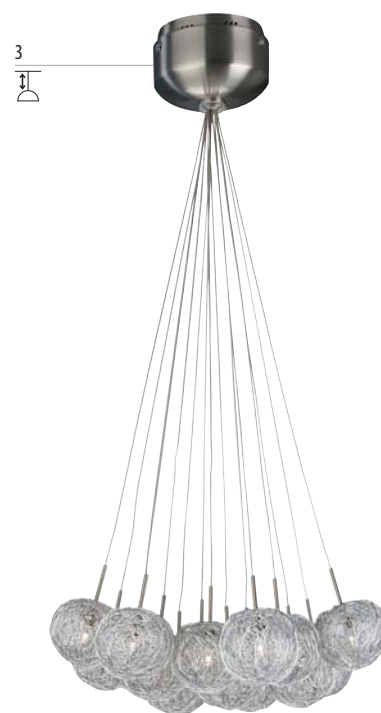

5x G9 | max. 25W | 230V | Ⓢ

Y | T 225 | ← 335 | ↗ 335 |













### Eldar

	1   38796/17/10
	10W INCL. 15x G4   max. 10W   230V-12V   ⊕
	1300   ↔ 420   ↙ 420
	

### Fontaine

	2   41850/17/10
	20W INCL. 4x G4   max. 20W   230V-12V   ⊕
	1500   ↔ 625   ↙ 110
	

### Fontaine

	3   41853/17/10
	10W INCL. 15x G4   max. 10W   230V-12V   ⊕
	1200   ↔ 355   ↙ 355
	



1

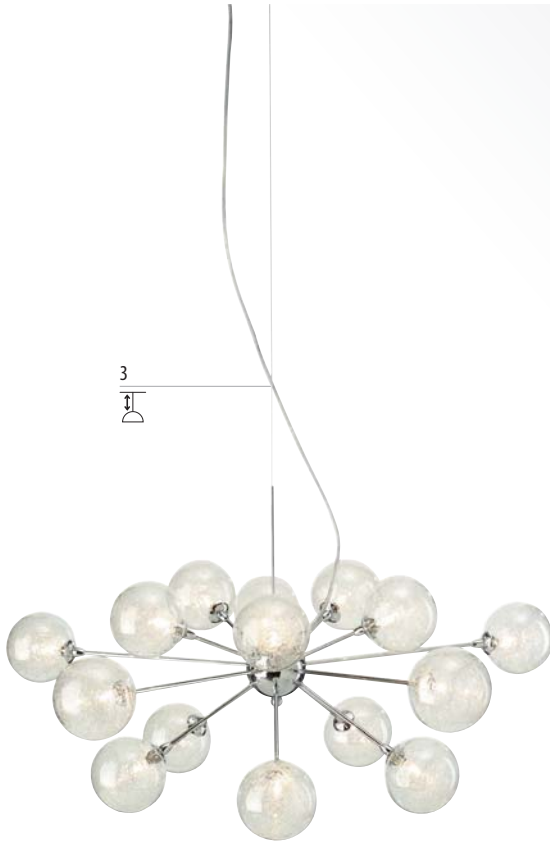

3



2

### Epico

1 | 40311/11/10

20W INCL.  
9x G4 | max. 20W | 230V-12V | ⊕

| T 110 | ← 360 | ↗ 360 |



### Barbarossa

2 | 41848/11/10

10W INCL.  
10x G4 | max. 10W | 230V-12V | ⊕

| T 1300 | ← 540 | ↗ 540 |



### Barbarossa

3 | 41849/11/10

10W INCL.  
15x G4 | max. 10W | 230V-12V | ⊕

| T 1300 | ← 800 | ↗ 800 |



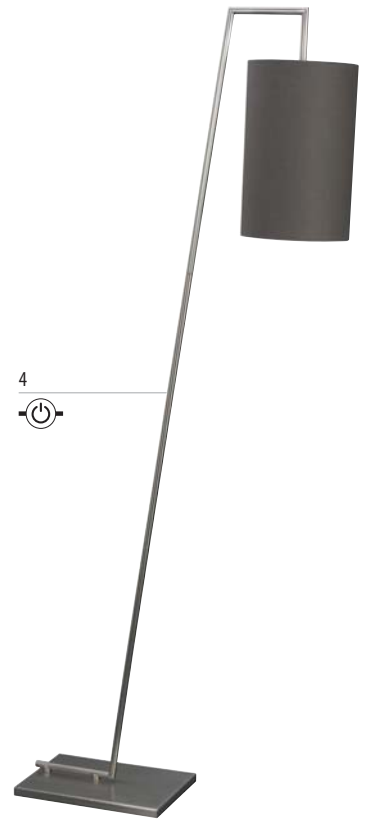

Декоративные светильники

**Forco**

1 | 40571/38/10

2 | 40571/43/10

1x E27 | max. 60W | 230V | Ⓢ

Y | | 1660 | ↔ 480 | ↗ 480 |



**Flemio**

3 | 42232/38/10

4 | 42232/93/10

1x E27 | max. 60W | 230V | Ⓢ

Y | | 1717 | ↔ 240 | ↗ 698 |





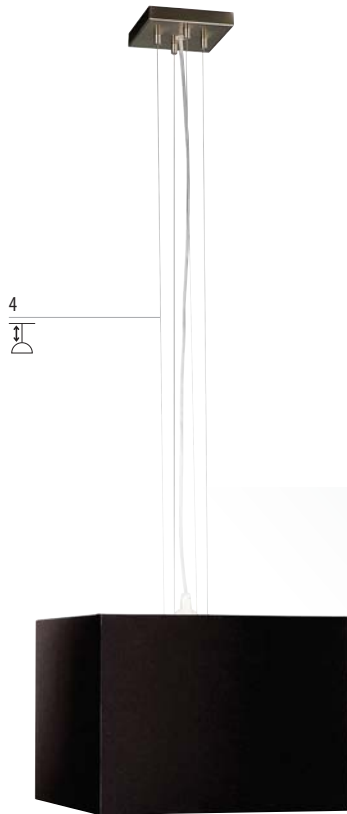

Декоративные светильники

**Adrio**

■	1   36675/17/10
	4x E14   max. 60W   230V   ⊕
Y	1 1350   ← 955   ↗ 205
	MET

**Adrio**

■	2   36677/17/10
	1x E14   max. 60W   230V   ⊕
Y	1 190   ↔ 162   ↗ 195
	MET

**Adrio**

■	3   36679/17/10
	1x E14   max. 60W   230V   ⊕
Y	1 389   ↔ 160   ↗ 160
	MET

**Esco**

■	4   40282/30/10
	1x E27   max. 60W   230V   ⊕
Y	1 1700   ↔ 300   ↗ 300
	MET



## Lagra

1 | 40568/93/10

5x E14 | max. 40W | 230V | Ⓢ

Y | 11500 | ↔ 627 | ↗ 652 |



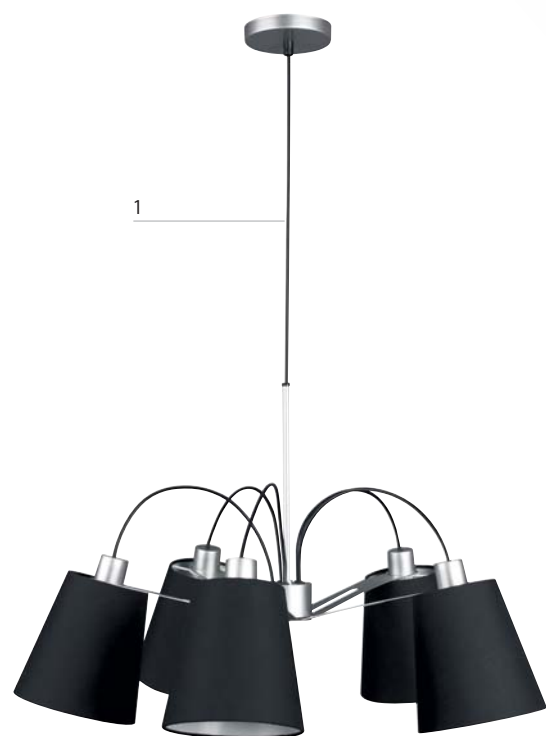

Lagra

1 | 40568/48/10

5x E14 | max. 40W | 230V | Ⓢ

Y | | 1500 | ← 627 | ↗ 652 |



Lagra

2 | 45568/48/10

3 | 45568/93/10



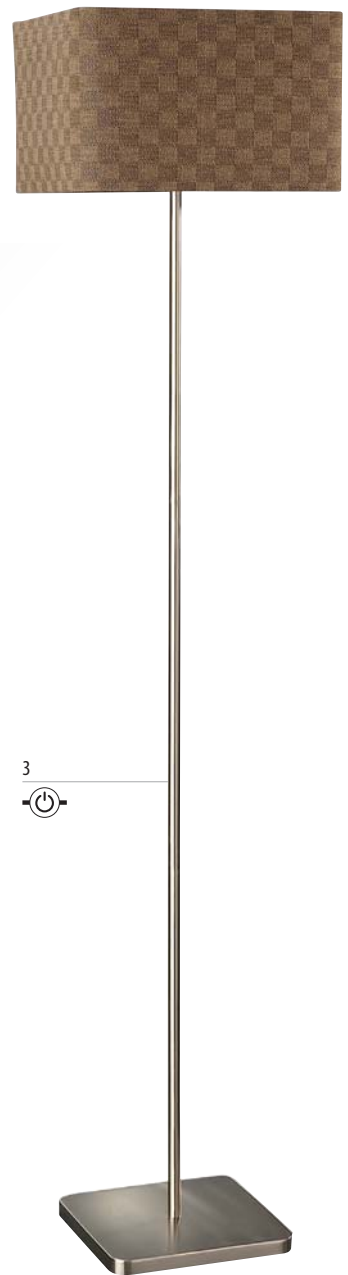

1x E14 | max. 40W | 230V | Ⓢ

Y | | 208 | ← 150 | ↗ 310 |















Duarte

	1   37370/43/10
	2x E27   max. 75W   230V   
	1500   ↔ 700   ↗ 200
	

Duarte

	2   37372/43/10
	1x E14   max. 60W   230V   
	235   ↔ 180   ↗ 354
	

Duarte

	3   37373/43/10
	1x E27   max. 100W   230V   
	1501   ↔ 300   ↗ 300
	



## Duarte

1 | 37374/43/10

1x E14 | max. 60W | 230V | ☐

Y | | 1 411 | ← 180 | ↗ 180 |





Декоративные светильники



Kiera

■	1   37695/86/10
	4x E14   max. 40W   230V   Ⓢ
Y	1500   ↔ 564   ↗ 564
	MET

Kiera

■	2   37696/86/10
	6x E14   max. 40W   230V   Ⓢ
Y	1500   ↔ 809   ↗ 564
	MET

Kiera

■	3   37697/86/10
	1x E14   max. 40W   230V   Ⓢ
Y	191   ↔ 150   ↗ 205
	MET





### Addiso

1 | 36275/32/10

1x E27 | max. 75W | 230V | Ⓟ

Y | | 1500 | ← 405 | ↗ 405 |



### Karmana

2 | 37150/32/10

3 | 37150/43/10





1x E27 | max. 100W | 230V | Ⓢ

Y | | 2100 | ← 405 | ↗ 405 |









**Esco**

	1   40282/38/10
	1x E27   max. 60W   230V   
	1700   ↔ 300   ↗ 300
 	

**Locke**

	2   41595/30/10
	1x E27   max. 75W   230V   
	1500   ↔ 350   ↗ 350
 	



2



1



3



### Babbage

■ 1 | 40436/30/10

□ 2 | 40436/31/10

1x E27 | max. 60W | 230V | Ⓢ

Y | | 1270 | ← 400 | ↗ 400 |



### Beatrix

■ 3 | 42208/11/10

1x E27 | max. 60W | 230V | □

Y | | 1800 | ← 450 | ↗ 1600 |



massive

Экономят  
энергию



Декоративные светильники



### Latu

1 | 40599/17/10

PHILIPS 23W INCL.

2x E27 | max. 23W | 230V | Ⓢ

| 1650 | 855 | 150 |



### Latu

2 | 40600/17/10

PHILIPS 23W INCL.

2x E27 | max. 23W | 230V | Ⓢ

| 1650 | 855 | 150 |



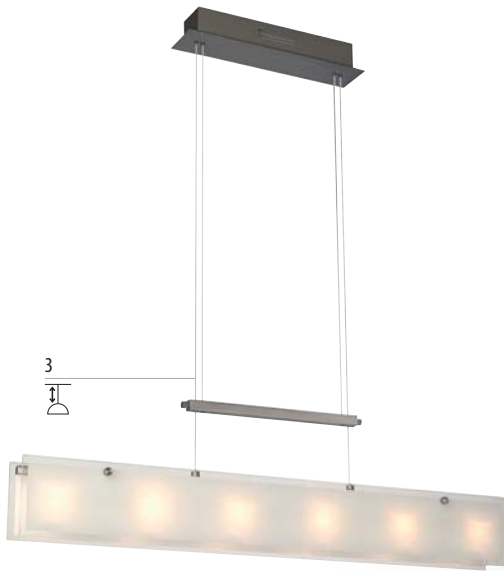

Jozef

1 | 36065/17/10

2x E27 | max. 60W | 230V |

| 1300 | ← 450 | ↘ 130 |



Jozef

2 | 36066/17/10

3x E27 | max. 60W | 230V |

| 1300 | ← 630 | ↘ 130 |



Fario

3 | 40388/17/10

20W INCL.  
6x G4 | max. 20W |  $\frac{230V}{12V}$  |

| 1500 | ← 862 | ↘ 92 |



Fario

4 | 40389/17/10

20W INCL.  
6x G4 | max. 20W |  $\frac{230V}{12V}$  |

| 1500 | ← 862 | ↘ 92 |



1



2



3



### Loyo

■ 1 | 40573/11/10

1x E27 | max. 60W | 230V | Ⓢ

Y | | 1 942 | ↔ 225 | ↗ 225 |



### Ferma

■ 2 | 40574/30/10

□ 3 | 40574/31/10



1x E27 | max. 60W | 230V | Ⓢ

Y | | 1 200 | ↔ 238 | ↗ 238 |

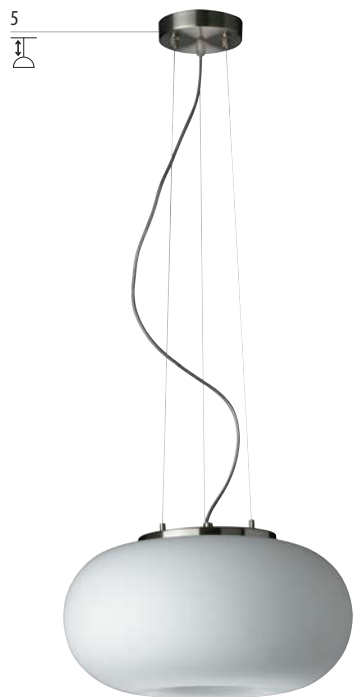







**Baldasso**

- 1 | 41596/30/10
- 2 | 41596/31/10
-  **PHILIPS 18W INCL.**  
1x E27 | max. 20W | 230V | Ⓢ
-  | ↓ 1500 | ↔ 350 | ↗ 350 |
- MET  W

**Baldasso**

- 3 | 41597/31/10
-  **7W INCL.**  
2x E14 | max. 9W | 230V | Ⓢ
-  | ↓ 1500 | ↔ 650 | ↗ 200 |
- MET  W

**Bambo**





- 4 | 41750/31/10
-  **PHILIPS 18W INCL.**  
1x E27 | max. 100W | 230V | Ⓢ
-  | ↓ 1530 | ↔ 420 | ↗ 360 |
- MET  W

**Foch**





- 5 | 41823/17/10
- 1x E27 | max. 100W | 230V | Ⓢ
-  | ↓ 1400 | ↔ 370 | ↗ 370 |
- MET  W







**Mauri**

	1   40625/17/10
	1x E27   max. 40W   230V   
	1200   ↔ 450   ↗ 450
	

**Mauri**

	2   40634/17/10
	1x E27   max. 40W   230V   
	1650   ↔ 400   ↗ 400
	

**Lode**

	3   41599/31/10
	1x E27   max. 75W   230V   
	1510   ↔ 450   ↗ 450
	



1

2

3

4



5

Edgar

1 | 37625/44/10

1x E27 | max. 60W | 230V | ☐

Y | | 1850 | ← 400 | ↗ 400 |



Edgar

2 | 37626/44/10

1x E27 | max. 60W | 230V | ☐

Y | | 1030 | ← 350 | ↗ 350 |



Eliot

3 | 40087/17/10

1x E27 | max. 75W | 230V | ☉

Y | | 1500 | ← 325 | ↗ 325 |



Fuyo

4 | 41598/30/10

5 | 41598/31/10

PHILIPS 18W INCL.

1x E27 | max. 20W | 230V | ☐

Y | | 1400 | ← 500 | ↗ 500 |





 **Экономят**  
энергию

2  

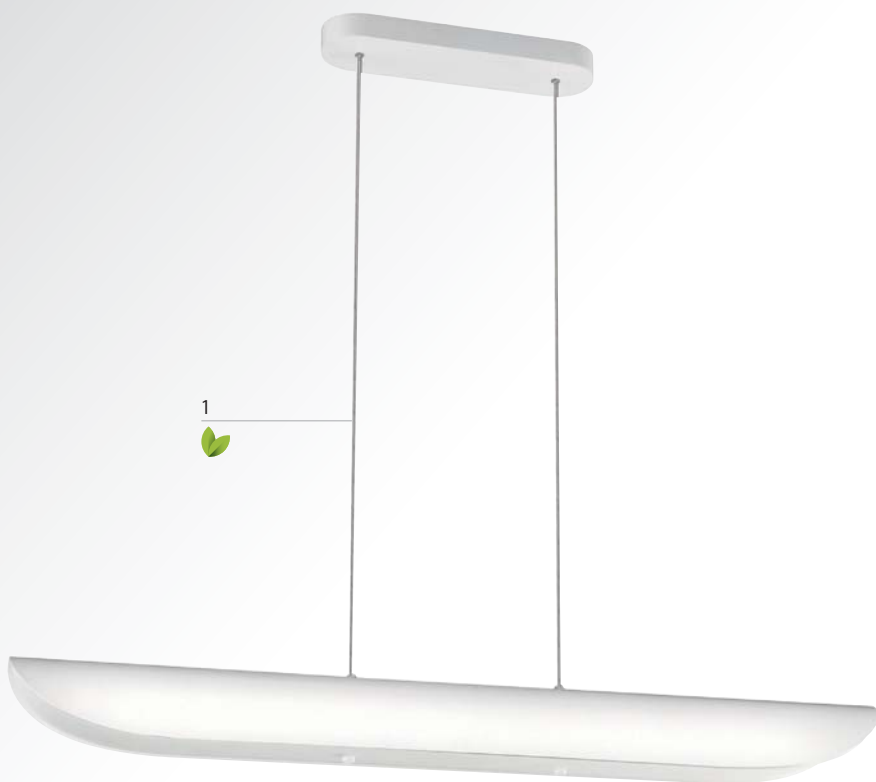

1  

### Diony

1 | 40566/31/10

2 | 40566/48/10

 **PHILIPS 23W INCL.**

2x E27 | max. 25W | 230V | 

 | 1500 | ↔ 900 | ↗ 102 |





Экономят энергию



Декоративные светильники

### Asylus

	1   40567/31/10
	2   40567/38/10
	3   40567/48/10
	<b>PHILIPS 18W INCL.</b> 1x E27   max. 40W   230V
	1 1500   ↔ 406   ↗ 406

### Callagan

	4   43235/31/10
	5   43235/38/10
	6   43235/48/10
	<b>PHILIPS 23W INCL.</b> 1x E27   max. 40W   230V
	1 244   ↔ 273   ↗ 100



**Matto**

■	1   40601/17/10
	4x E14   max. 40W   230V   ⊕
Y	1 1300   ↔ 943   ↗ 138
	Доступно начиная с июля 2011

**Matto**

■	2   45601/17/10
	1x E27   max. 40W   230V   ⊕
Y	1 225   ↔ 277   ↗ 118
	Доступно начиная с июля 2011



### Gaju

1 | 40616/31/10

2 | 40616/48/10

1x E27 | max. 40W | 230V |

| 1 1800 | → 499 | ↗ 499 |

MET  SYN

massive

1



2



4



3

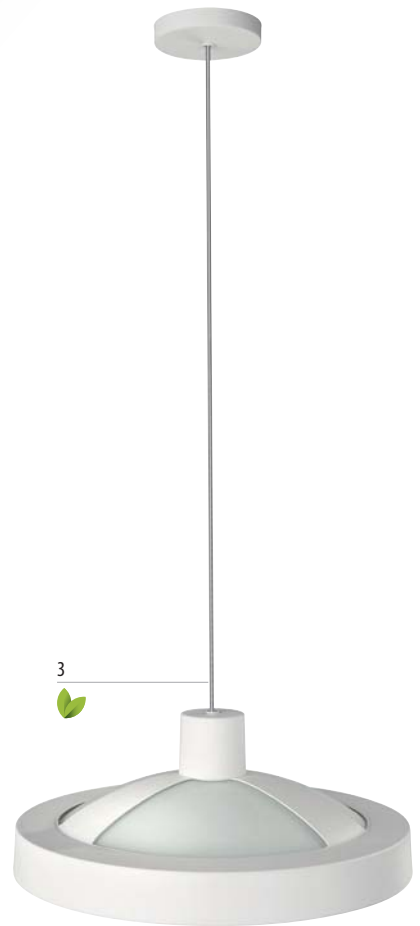

### Mobufu

1 | 40192/31/10

2 | 40192/48/10

1x E27 | max. 100W | 230V |

| 1500 | 355 | 355 |



### Andropov

3 | 40353/31/10

4 | 40353/48/10

**PHILIPS 14W INCL.**

1x E27 | max. 15W | 230V |

| 1500 | 405 | 405 |



2









3



1

**Marcoso**

	1   40617/31/10
	2   40617/57/10
	3   40617/93/10
1x E27   max. 40W   230V   	
	1 1750   ← 350   ↗ 350
	



Декоративные светильники

2



1



3



### Mercier

1 | 37960/48/10

20W INCL.  
5x G4 | max. 20W | 12V | ☐

| 1 1245 | ↔ 290 | ↗ 290 |

ALU

### Mercier

2 | 37961/48/10

20W INCL.  
8x G4 | max. 20W | 12V | ☐

| 1 1480 | ↔ 390 | ↗ 390 |

ALU

### Mercier

3 | 37964/48/10

20W INCL.  
5x G4 | max. 20W | 12V | ⊕

| 1 315 | ↔ 290 | ↗ 290 |

ALU





### Gautier

1 | 40396/60/10

1x E14 | max. 60W | 230V | ⊕

Y | | 1 955 | ↔ 175 | ↗ 175 |

MET SYN

### Ferdinand

2 | 40435/11/10

1x E27 | max. 60W | 230V | ⊕

Y | | 1 865 | ↔ 200 | ↗ 200 |

MET

### Barbara

3 | 41820/48/10

1x E27 | max. 100W | 230V | ⊕

Y | | 1 1180 | ↔ 180 | ↗ 180 |

MET

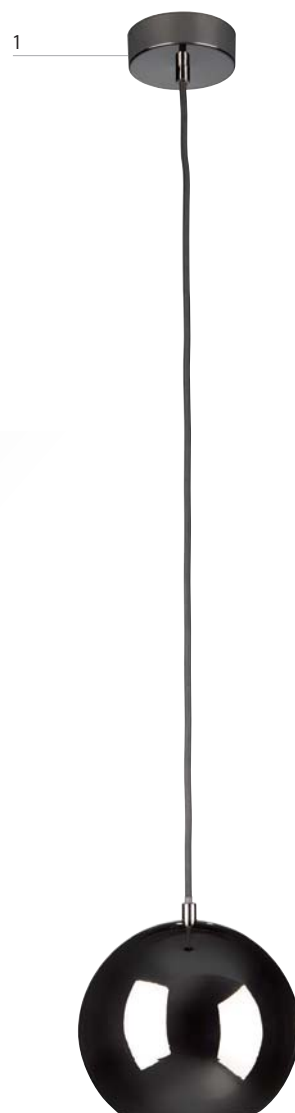
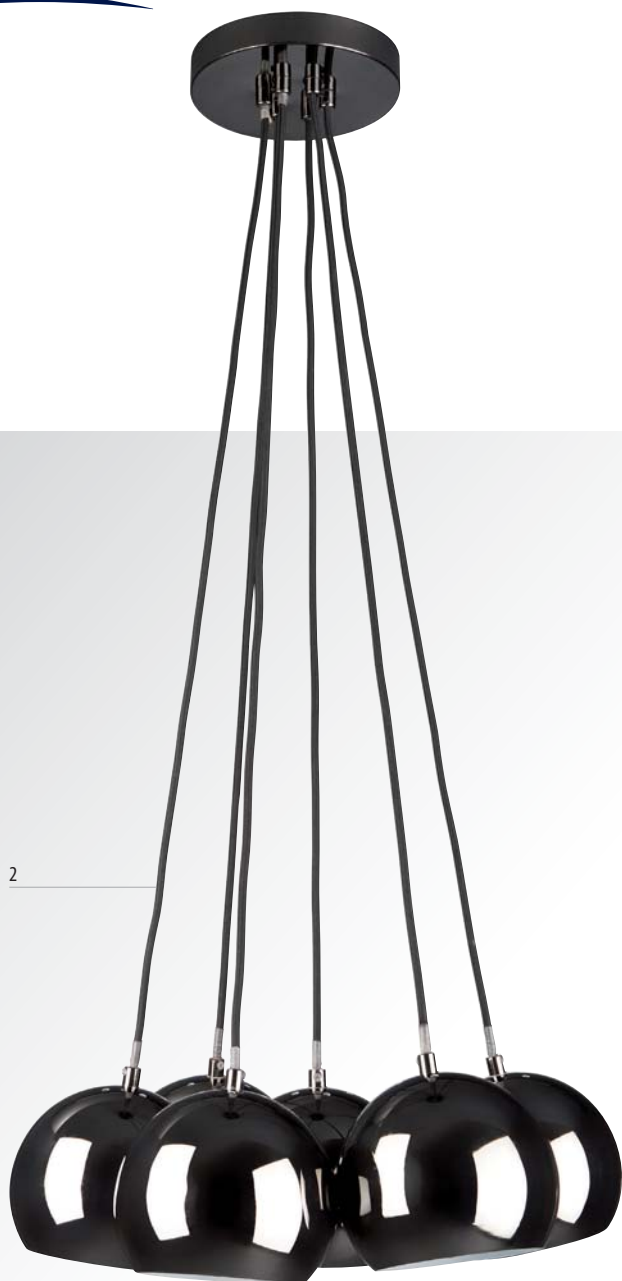

Balder

■	1   40433/30/10
	1x E14   max. 40W   230V   Ⓢ
Y	1200   ↔ 200   ↗ 200
	MET

Balder

■	2   40434/30/10
	6x E14   max. 40W   230V   Ⓢ
Y	1200   ↔ 410   ↗ 410
	MET

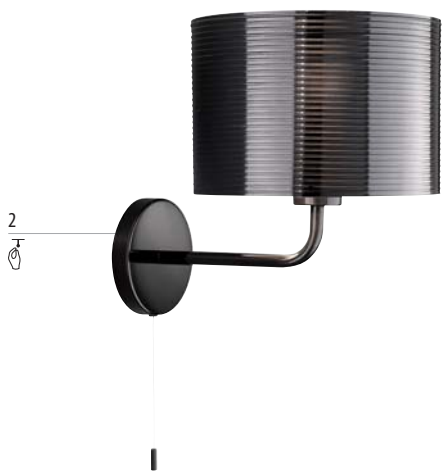

**Doran**

■	1   37505/30/10
	1x E27   max. 75W   230V   Ⓢ
	1 1000   ↔ 400   ↗ 400
	MET SYN

**Doran**

■	2   37507/30/10
	1x E27   max. 60W   230V   Ⓢ
	1 272   ↔ 220   ↗ 288
	MET SYN

**Doran**

■	3   37508/30/10
	1x E27   max. 100W   230V   Ⓢ
	1 1535   ↔ 400   ↗ 400
	MET SYN



## Berio

■ 1 | 43133/48/10

 **PHILIPS 40W INCL.**

1x G9 | max. 40W | 230V | 

 | 1197 | ← 300 | ↗ 73 |



**Marto**

1 | 43131/11/10

1x E27 | max. 60W | 230V |

| 1334 |  $\leftrightarrow$  180 |  $\nearrow$  167 |

**Berio**

2 | 43133/30/10

3 | 43133/31/10

**PHILIPS 40W INCL.**

1x G9 | max. 40W | 230V |

| 1197 |  $\leftrightarrow$  300 |  $\nearrow$  73 |

**Fleio**

4 | 43238/11/10

5 | 43238/93/10

**PHILIPS 12W INCL.**

1x E27 | max. 40W | 230V |

| 1146 |  $\leftrightarrow$  202 |  $\nearrow$  202 |



Gaju

■ 1 | 43214/30/10

□ 2 | 43214/31/10

■ 3 | 43214/43/10

1x E14 | max. 40W | 230V | ☐

Y | | 200 | ↔ 200 | ↗ 100 |





**Foqo**

1 | 42089/17/10

1x E27 | max. 60W | 230V | ☐

| 1608 | ↔ 325 | ↗ 1100 |



**Ambiori**

2 | 42119/17/10

**PHILIPS 40W INCL.**  
3x G9 | max. 60W | 230V | ☐

| 1641 | ↔ 300 | ↗ 440 |



**Frado**

3 | 42209/31/10

4 | 42209/43/10

2x E27 | max. 25W | 230V | ☐

| 1020 | ↔ 235 | ↗ 235 |





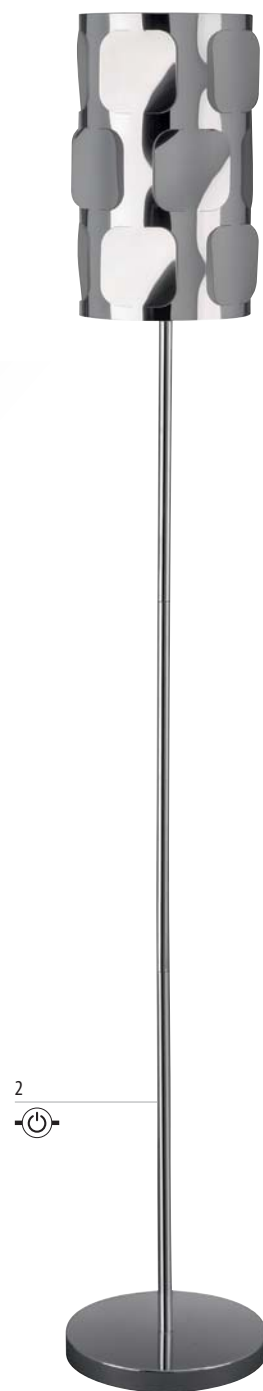

**Bertholo**

■	1   40643/11/10
	1x E27   max. 60W   230V   Ⓢ
Y	1500   ↔ 175   ↗ 175
	MET SYN

**Bertholo**

■	2   42643/11/10
	1x E27   max. 60W   230V   Ⓢ
Y	1425   ↔ 220   ↗ 220
	MET SYN



Lautra

1 | 40242/33/10

2 | 40242/53/10

3 | 40242/60/10

1x E27 | max. 100W | 230V | ☐

Y | | 1500 | ← 400 | ↗ 400 |





1



2



4



3



5

Konrad

1 | 40199/30/10

2 | 40199/31/10

1x E27 | max. 100W | 230V | Ⓢ

Y | | 1300 | ↔ 450 | ↗ 450 |



Kara

3 | 41648/33/10

4 | 41648/35/10

5 | 41648/53/10

1x E27 | max. 100W | 230V | Ⓢ

Y | | 1500 | ↔ 400 | ↗ 400 |





**Erapo**

1 | 40245/31/10

2 | 40245/33/10

3 | 40245/53/10

1x E27 | max. 60W | 230V |

| 1 1500 |  $\leftrightarrow$  164 |  $\swarrow$  164 |



1



2

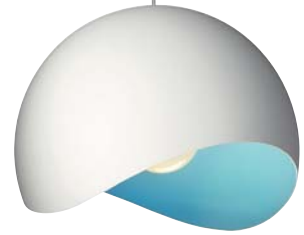

Экономят энергию

4



3



5



Eusebi

1 | 40354/34/10

2 | 40354/35/10

PHILIPS 14W INCL.

1x E27 | max. 20W | 230V | Ⓢ

Y | | 1500 | ↔ 300 | ↗ 300 |



Lami

3 | 43236/20/10

4 | 43236/34/10

5 | 43236/35/10

1x E14 | max. 40W | 230V | Ⓢ

Y | | 250 | ↔ 163 | ↗ 163 |





## Eusebi

1 | 40354/20/10



**PHILIPS 14W INCL.**

1x E27 | max. 20W | 230V |



| ↓ 1500 | ← 300 | ↗ 300 |



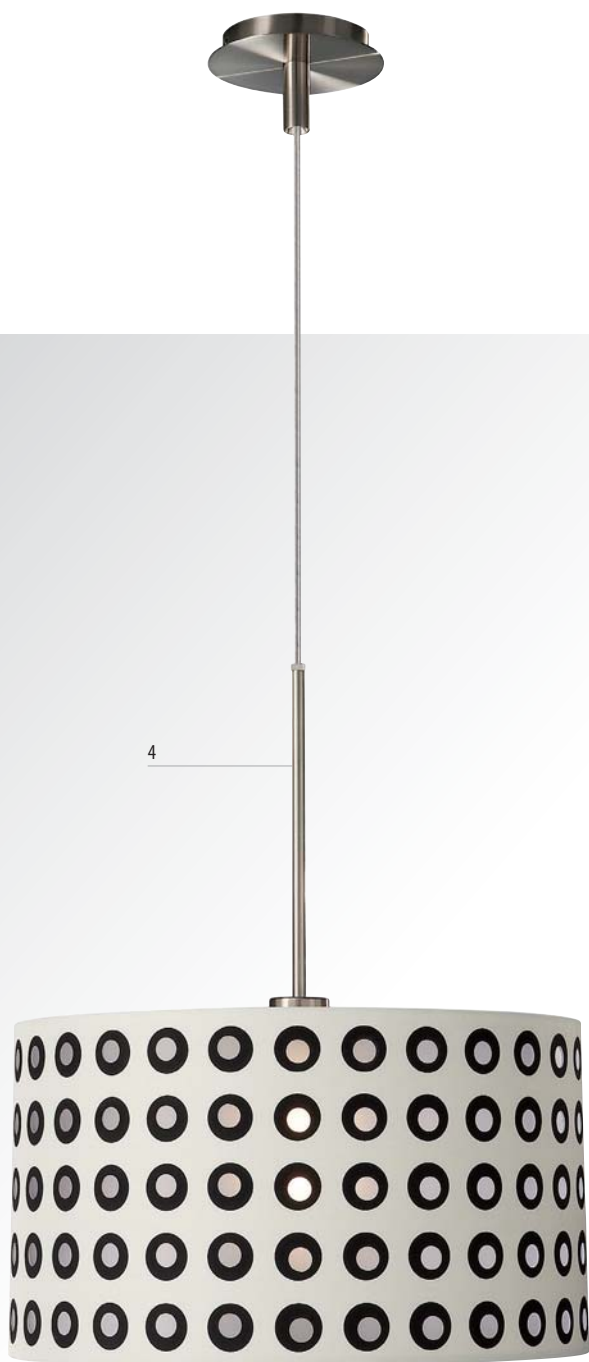

Erasmus

1 | 40227/11/10

1x E27 | max. 60W | 230V | Ⓢ

Y | | 1300 | ↔ 250 | ↗ 250 |



Erasmus

2 | 40228/11/10

1x E27 | max. 150W | 230V | Ⓢ

Y | | 1500 | ↔ 400 | ↗ 400 |



Festo

3 | 41592/30/10

4 | 41592/31/10

1x E27 | max. 100W | 230V | Ⓢ

Y | | 1500 | ↔ 400 | ↗ 400 |





### Flavio

1 | 41782/32/10

2 | 41782/35/10

3 | 41782/53/10

1x E27 | max. 60W | 230V | ☐

Y | | 1 1250 | ← 275 | ↗ 275 |







## Ballard

□ 1 | 41683/60/10





1x E27 | max. 60W | 230V | Ⓢ

Y | | 1100 | ↔ 280 | ↗ 280 |





MET SYN







**Chesty**

	1   43221/30/10
1x E14   max. 40W   230V   	
1 122   ↔ 150   ↗ 150	
 	

**Chesty**

	2   43222/56/10
1x E14   max. 40W   230V   	
1 122   ↔ 150   ↗ 150	
 	

**Chesty**

	3   43223/33/10
1x E14   max. 40W   230V   	
1 122   ↔ 150   ↗ 150	
 	



1

Декоративные светильники

74

## Kandi

1 | 36975/30/10

 **PHILIPS 40W INCL.**

6x G9 | max. 40W | 230V | 

 | 1500 |  $\leftrightarrow$  465 |  $\swarrow$  465 |



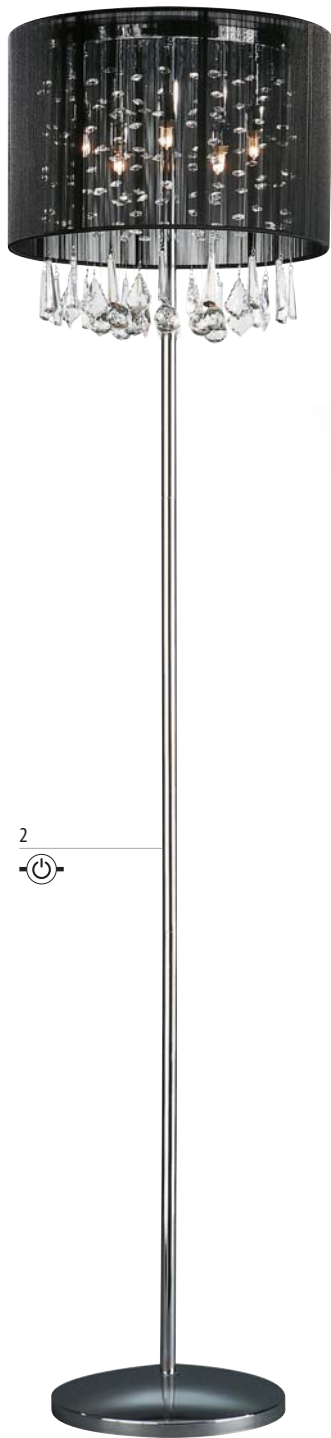

2



1



### Kandi

1 | 36976/30/10

 **PHILIPS 40W INCL.**

6x G9 | max. 40W | 230V | Ⓢ

 | T 370 | ← 465 | ↗ 465 |



### Kandi

2 | 36978/30/10

 **PHILIPS 40W INCL.**

5x G9 | max. 40W | 230V | Ⓢ

 | ↓ 1640 | ← 380 | ↗ 380 |





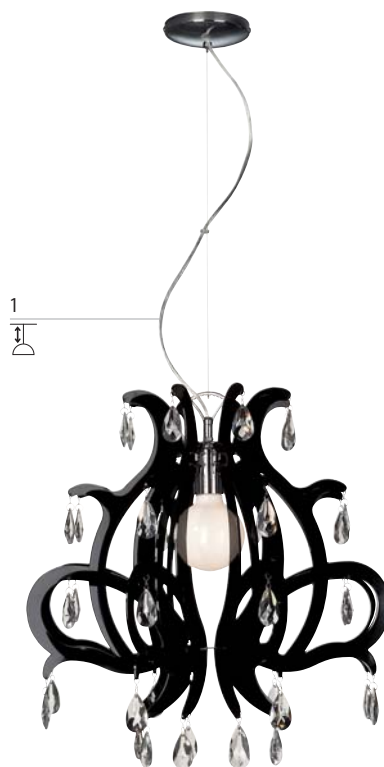



Декоративные светильники



**Erdo**

■	1   40239/30/10
	1x E27   max. 100W   230V   Ⓢ
Y	11530   ← 525   ↗ 525
	MET 

**Flaubo**

■	2   41766/30/10
	5x E14   max. 60W   230V   Ⓢ
Y	11260   ← 565   ↗ 565
	MET  

**Flaubo**

■	3   41767/30/10
	8x E14   max. 60W   230V   Ⓢ
Y	11130   ← 700   ↗ 700
	MET  

**Flaubo**

■	4   45936/30/10
	2x E14   max. 60W   230V   Ⓢ
Y	1150   ← 330   ↗ 180
	MET 



3

**Flaubo**

1 | 41766/31/10

5x E14 | max. 60W | 230V | Ⓢ

Y | | 1260 | ← 565 | ↗ 565 |



**Flaubo**

2 | 41767/31/10

8x E14 | max. 60W | 230V | Ⓢ

Y | | 1130 | ← 700 | ↗ 700 |



**Flaubo**

3 | 45936/31/10

2x E14 | max. 60W | 230V | Ⓢ

Y | | 150 | ← 330 | ↗ 180 |





Monteverdi

■	1   41787/11/10
	1x E27   max. 100W   230V   Ⓢ
Y	1 1000   ↔ 255   ↗ 255
	MET

Michelangelo

■	2   41807/11/10
	4x E14   max. 40W   230V   Ⓢ
Y	T 200   ↔ 550   ↗ 550
	MET

Madison

□	3   41814/31/10
	5x E14   max. 60W   230V   Ⓢ
Y	1 1000   ↔ 460   ↗ 460
	MET

Flo

■	4   41816/60/10
	1x E27   max. 100W   230V   Ⓢ
Y	1 795   ↔ 150   ↗ 150
	MET



Декоративные светильники

**Koco**

■	1   38365/11/10
	5x E14   max. 60W   230V   Ⓢ
Y	1130   ← 530   ↗ 530
	MET

**Koco**

■	2   38367/11/10
	2x E14   max. 60W   230V   Ⓢ
Y	1415   ← 305   ↗ 220
	MET

**Farro**

■	3   40536/11/10
	5x E14   max. 40W   230V   Ⓢ
Y	11000   ← 440   ↗ 440
	MET

**Nietzsche**

■	4   41826/11/10
	7x E14   max. 40W   230V   Ⓢ
Y	11500   ← 380   ↗ 380
	MET



1



2



3



4



Neyo

■	1   37315/11/10
	6x E14   max. 40W   230V   ⊕
Y	1170   ↔ 650   ↗ 650
	MET

Neyo

■	2   37317/11/10
	2x E14   max. 40W   230V   ⊕
Y	320   ↔ 350   ↗ 230
	MET

Balat

■	3   40564/11/10
	5x E14   max. 40W   230V   ⊕
Y	1060   ↔ 575   ↗ 575
	MET  SYN

Balat

■	4   45564/11/10
	2x E14   max. 40W   230V   ⊕
Y	240   ↔ 383   ↗ 350
	MET  SYN

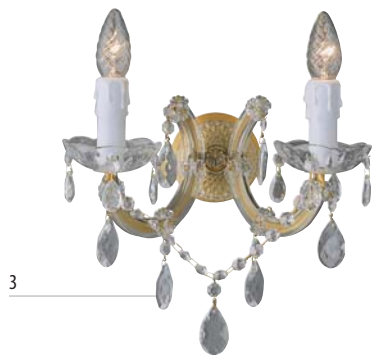

Декоративные светильники

**Madison**

1	41814/30/10
5x E14   max. 60W   230V   ⊕	
1000   ← 460   ↗ 460	
MET	

**Gindenburg**

2	41856/86/10
6x E14   max. 60W   230V   ⊕	
1150   ← 540   ↗ 540	
MET	

**Versailles**

3	80002/02/01
2x E14   max. 40W   230V   ⊕	
180   ← 310   ↗ 200	
MET	

**Flacio**

4	80002/05/01
5x E14   max. 40W   230V   ⊕	
1360   ← 480   ↗ 480	
MET	



## Dietie

1 | 36266/17/10

8x E14 | max. 40W | 230V | Ⓢ

Y | | 1120 | ← 620 | ↗ 620 |





**Dietie**

■	1   36265/17/10
	5x E14   max. 40W   230V   Ⓢ
Y	1120   ← 620   ↗ 620
	MET 

**Dietie**

■	2   36267/17/10
	2x E14   max. 40W   230V   Ⓢ
Y	1205   ← 230   ↗ 140
	MET 



1



2



**Fleuro**

■ 1 | 40580/30/10

□ 2 | 43580/31/10

■ 3 | 40580/87/10

1x E27 | max. 60W | 230V | Ⓢ

Y | | 1500 | ↔ 420 | ↗ 420 |







Ancus

- 1 | 40249/06/10
- 2 | 40249/31/10
- 5x E14 | max. 40W | 230V | Ⓢ
- Y | | 1423 | ← 550 | ↗ 550 |
- MET

Erno

- 3 | 40277/31/10
- 1x E27 | max. 100W | 230V | Ⓢ
- Y | | 1500 | ← 350 | ↗ 350 |
- MET

Erno

- 4 | 40278/31/10
- 3x E27 | max. 75W | 230V | Ⓢ
- Y | | 1500 | ← 800 | ↗ 250 |
- MET

massive

4



1



3



2

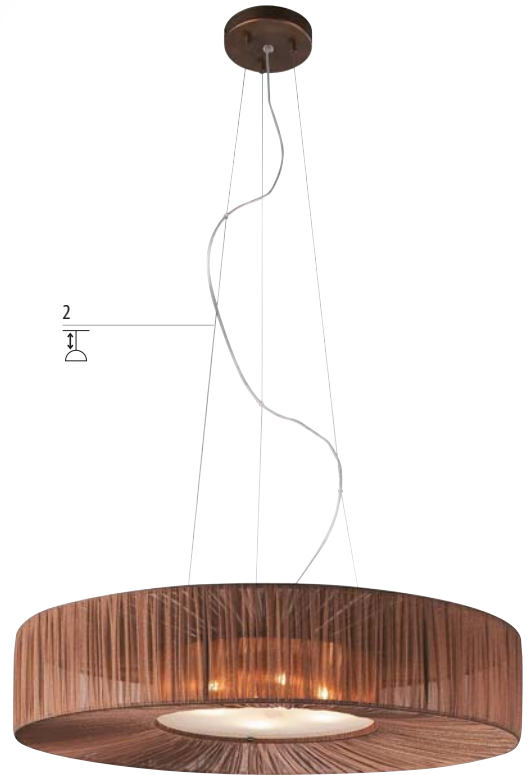

Декоративные светильники

86

Ernest

1 | 40271/38/10

2 | 40271/43/10

PHILIPS 40W INCL.

4x G9 | max. 40W | 230V | ⊕

Y | 11550 | ↔ 602 | ↗ 602 |



Maslo

3 | 40622/30/10

4 | 40622/31/10

1x E27 | max. 60W | 230V | ⊕

Y | 11750 | ↔ 400 | ↗ 400 |





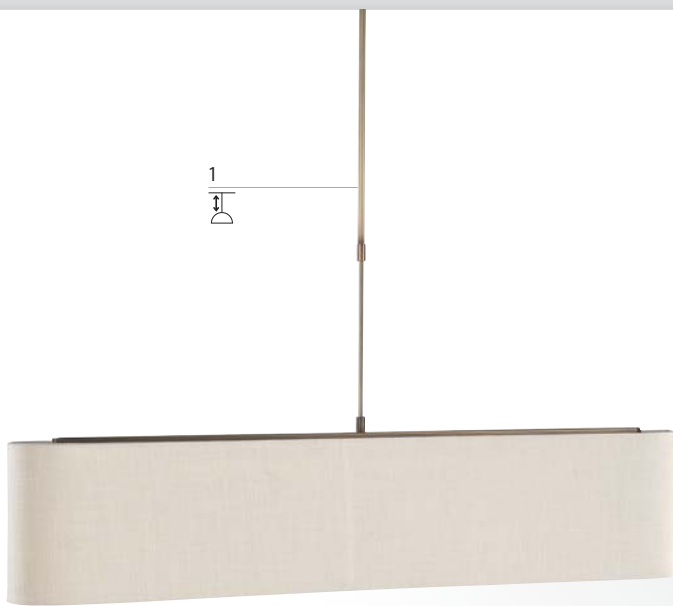

Доступно начиная с июля 2011







Декоративні світильники





**Egbert**

 1   37690/06/10
4x E14   max. 40W   230V   
   1380   ← 940   ↘ 160
 

**Egbert**

 2   37693/06/10
1x E27   max. 60W   230V   
   1608   ← 400   ↘ 200
 

**Egbert**

 3   37694/06/10
1x E14   max. 40W   230V   
   522   ← 300   ↘ 150
 



4  
E14



2



3  
E14



1



Pavlo

1 | 41577/87/10

5x E14 | max. 40W | 230V | Ⓢ

| 11043 | ↔ 554 | ↗ 533 |



Barras

2 | 42131/87/10

6x E14 | max. 40W | 230V | Ⓢ

| 11156 | ↔ 635 | ↗ 635 |



Pavlo

3 | 45577/31/10

4 | 45577/87/10

2x E14 | max. 40W | 230V | Ⓢ

| 1226 | ↔ 297 | ↗ 174 |





1

## Pavlo

□ 1 | 41577/31/10

5x E14 | max. 40W | 230V | Ⓢ

Y | 1 1043 | ← 554 | ↗ 533 |





90 | Декоративные светильники



Galea

1 | 37980/43/10

5x E14 | max. 40W | 230V | Ⓢ

Y | | 1 987 | ↔ 759 | ↙ 759 |



Доступно начиная с июля 2011

Galea

2 | 37982/43/10

2x E14 | max. 40W | 230V | Ⓢ

Y | | 1 250 | ↔ 311 | ↙ 197 |



Доступно начиная с июля 2011

Galea

3 | 37984/43/10

1x E14 | max. 40W | 230V | Ⓢ

Y | | 1 430 | ↔ 152 | ↙ 152 |



Доступно начиная с июля 2011



**Jensen**

1	3625/81/43
1x E14   max. 60W   230V   Ⓢ	
1 330   ↔ 210   ↗ 290	
<span>MET</span> <span>SYN</span> <span>⚡</span>	

**Jensen**

2	3625/85/43
5x E14   max. 60W   230V   Ⓢ	
1 1000   ↔ 700   ↗ 700	
<span>MET</span> <span>SYN</span> <span>⚡</span>	

**Baron**

3	9235/81/43
1x E27   max. 100W   230V   Ⓢ	
1 1590   ↔ 550   ↗ 550	
<span>MET</span> <span>SYN</span> <span>⚡</span>	

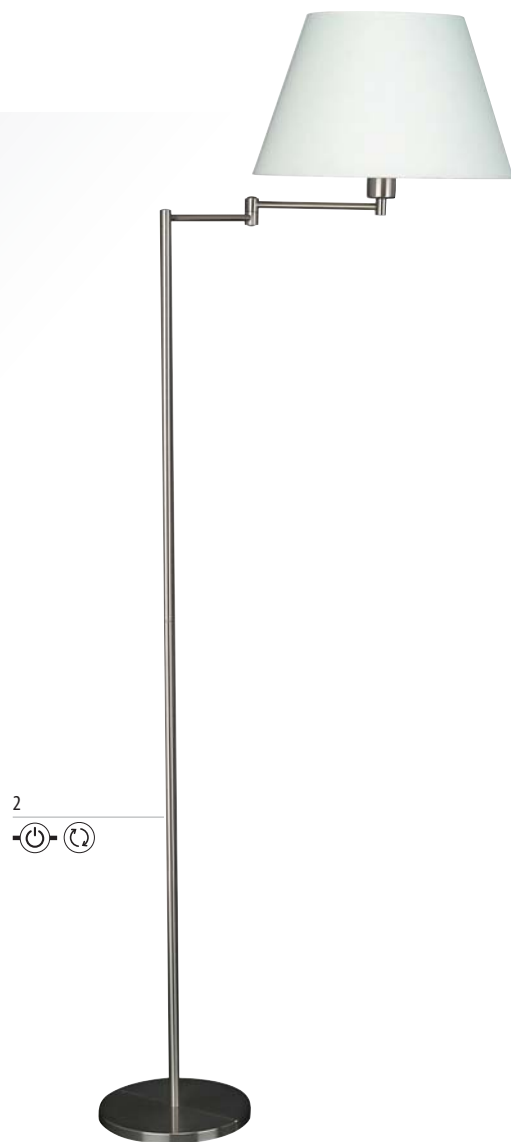

Junius

■	1   36412/17/10
	1x E27   max. 60W   230V   Ⓢ
Y	1 260   ↔ 85   ↗ 370
	MET

Junius

■	2   36413/17/10
	1x E27   max. 75W   230V   Ⓢ
Y	1 1555   ↔ 365   ↗ 365
	MET



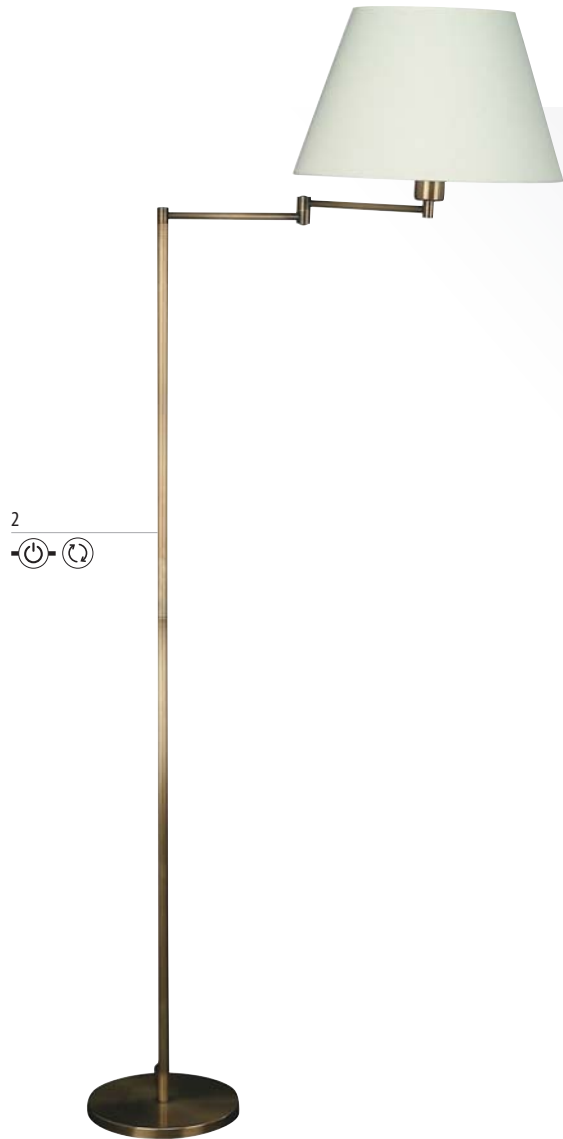

Junius

■	3   36414/17/10
	1x E27   max. 60W   230V   Ⓢ
Y	1 605   ↔ 255   ↗ 255
	MET







Декоративные светильники





Junius

	1   36412/06/10
	1x E27   max. 60W   230V   
	1 260   ↔ 85   ↗ 370
	

Junius

	2   36413/06/10
	1x E27   max. 75W   230V   
	1 1555   ↔ 365   ↗ 365
	

Junius

	3   36414/06/10
	1x E27   max. 60W   230V   
	1 605   ↔ 255   ↗ 255
	





### Irena

1 | 41846/06/10

2 | 41846/17/10

3x E14 | max. 60W | 230V | Ⓢ

Y | 1475 | ← 330 | ↗ 330 |



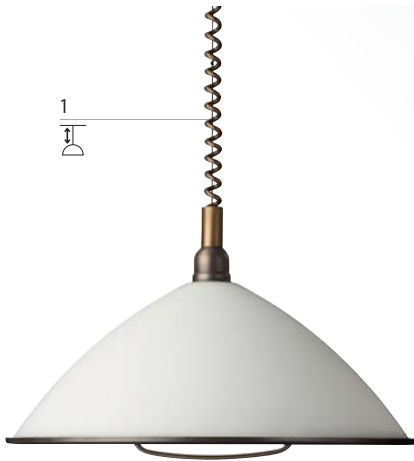

**Albani**

1 | 37700/06/10

1x E27 | max. 60W | 230V | ☐

Y | | 1520 | ↔ 455 | ↗ 455 |



**Albani**

2 | 37701/06/10

3x E27 | max. 60W | 230V | ⊕

Y | | 1235 | ↔ 1121 | ↗ 271 |



**Albani**

3 | 37702/06/10

1x E27 | max. 60W | 230V | ⊕

Y | | 1264 | ↔ 271 | ↗ 290 |



**Albani**

4 | 37704/06/10

1x E27 | max. 60W | 230V | ☐

Y | | 1471 | ↔ 270 | ↗ 283 |





2



3



1



**Kirco**

1 | 37711/06/10

2x E27 | max. 60W | 230V | Ⓢ

Y | | 1045 | ↔ 646 | ↗ 250 |



**Kirco**

2 | 37712/06/10

1x E27 | max. 60W | 230V | Ⓢ

Y | | 175 | ↔ 170 | ↗ 240 |



**Kirco**

3 | 37715/06/10





3x E27 | max. 60W | 230V | Ⓢ

Y | | 1943 | ↔ 620 | ↗ 620 |









**Kirco**

	1   37710/06/10
	1x E27   max. 60W   230V   
	1745   ↔ 404   ↗ 404
	

**Kirco**

	2   37716/06/10
	5x E27   max. 60W   230V   
	1910   ↔ 585   ↗ 585
	



Linco

	1   38990/06/10
	6x E14   max. 40W   230V   ⊕
	2x E27   max. 60W   230V
	1250   ↔ 830   ↗ 830

Linco





	2   38991/06/10
	3x E14   max. 40W   230V   ⊕
	2x E27   max. 60W   230V
	1250   ↔ 840   ↗ 840

Linco





	3   38992/06/10
	2x E14   max. 40W   230V   ⊕
	1205   ↔ 430   ↗ 260



**Barber**

	1   41898/06/10
	3x E14   max. 40W   230V   $\oplus$
	3x E27   max. 60W   230V
	$\updownarrow$ 1200   $\leftrightarrow$ 640   $\swarrow$ 640
	

**Barber**

	2   41899/06/10
	3x E27   max. 60W   230V   $\oplus$
	$\updownarrow$ 1150   $\leftrightarrow$ 390   $\swarrow$ 390
	



Lagra

■	1   38995/17/10
3x E14   max. 40W   230V   Ⓢ	
Y	1840   ↔ 550   ↗ 550
■	■

Lagra





■	2   38996/17/10
5x E14   max. 40W   230V   Ⓢ	
Y	1840   ↔ 550   ↗ 550
■	■

Lagra





■	3   38997/17/10
1x E14   max. 40W   230V   Ⓢ	
Y	1240   ↔ 175   ↗ 240
■	■







**Egmo**

 1   37720/06/10
3x E27   max. 60W   230V   
   1 975   ↔ 600   ↗ 600
 

**Egmo**

 2   37721/06/10
5x E27   max. 60W   230V   
   1 960   ↔ 580   ↗ 580
 

**Egmo**

 3   37722/06/10
1x E27   max. 40W   230V   
   1 260   ↔ 115   ↗ 325
 



Декоративные светильники

102

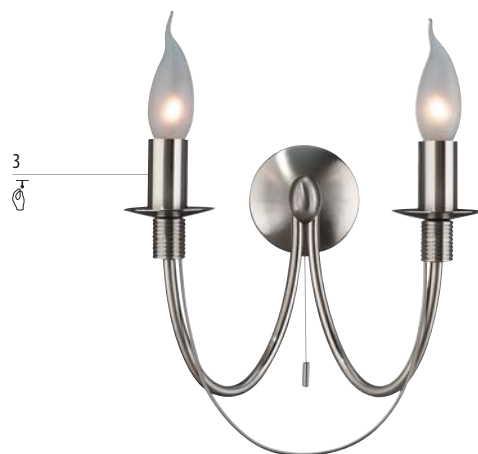

Jung

■	1   36270/17/10
	5x E14   max. 40W   230V   Ⓢ
Y	1240   ↔ 640   ↗ 640
	MET

Jung

■	2   36271/17/10
	8x E14   max. 40W   230V   Ⓢ
Y	1360   ↔ 640   ↗ 640
	MET

Jung

■	3   36272/17/10
	2x E14   max. 40W   230V   Ⓢ
Y	235   ↔ 265   ↗ 165
	MET





Adams

1 | 36255/06/10

5x E14 | max. 40W | 230V | Ⓢ

Y | | 1 1010 | ↔ 480 | ↗ 480 |



Adams

2 | 36256/06/10

8x E14 | max. 40W | 230V | Ⓢ

Y | | 1 1010 | ↔ 560 | ↗ 560 |



Adams

3 | 36257/06/10

2x E14 | max. 40W | 230V | Ⓢ

Y | | 1 225 | ↔ 260 | ↗ 130 |







## Gaio

1 | 37991/55/10

1x E14 | max. 40W | 230V | Ⓢ

Y | 11250 | ↔ 195 | ↗ 195



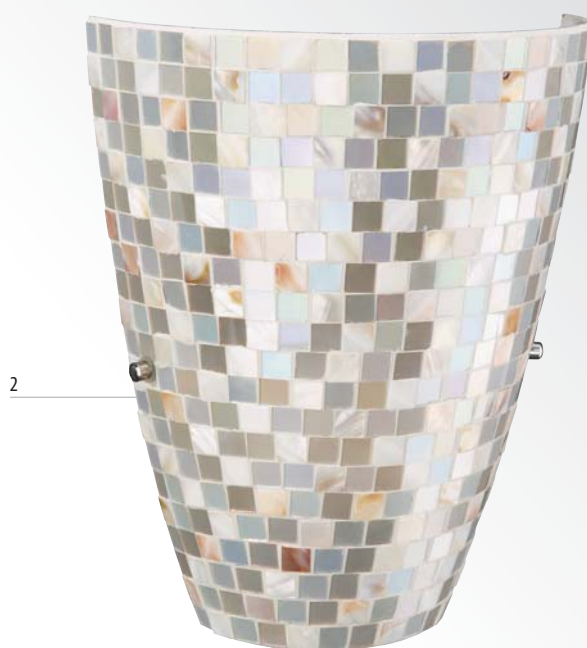

**Gaio**

1	37990/55/10
3x E14   max. 40W   230V   Ⓢ	
T 110   → 440   ↗ 440	
MET 	

**Gaio**

2	37992/55/10
1x E14   max. 40W   230V   Ⓢ	
I 265   → 215   ↗ 108	
MET 	

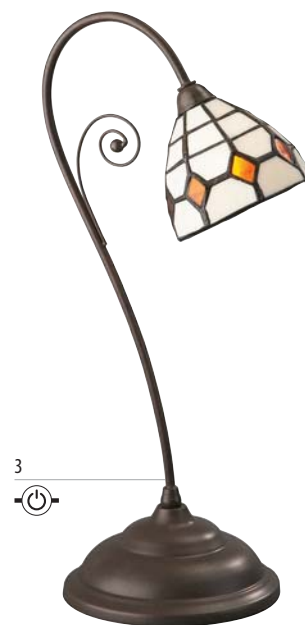

Elio

1 | 38650/55/10

PHILIPS 40W INCL.

6x G9 | max. 40W | 230V | Ⓢ

Y | | 1900 | ↔ 610 | ↗ 610 |



Elio

2 | 38652/55/10

PHILIPS 40W INCL.

1x G9 | max. 40W | 230V | Ⓢ

Y | | 175 | ↔ 105 | ↗ 223 |



Elio

3 | 38654/55/10

PHILIPS 40W INCL.

1x G9 | max. 40W | 230V | Ⓢ

Y | | 435 | ↔ 160 | ↗ 220 |





2



1



3



**Alce**

1 | 37760/55/10

1x E27 | max. 60W | 230V | Ⓟ

Y | | 1130 | ↔ 400 | ↗ 400 |



**Alce**

2 | 37762/55/10

1x E27 | max. 40W | 230V | Ⓟ

Y | | 165 | ↔ 310 | ↗ 150 |



**Alce**

3 | 37764/55/10



1x E27 | max. 60W | 230V | Ⓟ

Y | | 460 | ↔ 300 | ↗ 300 |







**Kanto**





1	36995/17/10
5x E14   max. 60W   230V   Ⓢ	
1850   ← 550   ↗ 550	
 	

**Kanto**





2	36996/17/10
3x E14   max. 60W   230V   Ⓢ	
1850   ← 465   ↗ 465	
 	



**Justina**

	1   36500/06/10
	2   36500/17/10
5x E14   max. 40W   230V   	
1400   ← 520   ↗ 520	
 	

**Justina**

	3   36502/06/10
	4   36502/17/10
1x E14   max. 40W   230V   	
190   ← 125   ↗ 260	
 	



4



1



5



2



3



Amalia

1 | 40097/01/10

2 | 40097/06/10

3 | 40097/17/10

5x E14 | max. 60W | 230V | Ⓢ

Y | | 1350 | ↔ 550 | ↗ 550 |



Baker

4 | 40334/15/10

5 | 40334/38/10

1x E14 | max. 60W | 230V | Ⓢ

Y | | 1750 | ↔ 176 | ↗ 176 |









**Fermini**

1   73979/03/43
3x E14   max. 40W   230V   Ⓢ
Y     1 920   ↔ 480   ↗ 480
MET 

**Fermini**

2   73979/05/43
5x E14   max. 40W   230V   Ⓢ
Y     1 960   ↔ 540   ↗ 540
MET 

**Fermini**

3   81979/01/43
1x E14   max. 40W   230V   Ⓢ
Y     1 180   ↔ 140   ↗ 260
MET 



**Moro**

<input checked="" type="checkbox"/>	1   43208/30/10
<input type="checkbox"/>	2   43208/31/10
1x E14   max. 60W   230V	
1395   ← 180   ↗ 180	

**Maxu**

<input checked="" type="checkbox"/>	3   45912/30/10
<input type="checkbox"/>	4   45912/31/10
1x E14   max. 60W   230V	
1475   ← 250   ↗ 250	



**Bernstein**

■ 1 | 43210/43/10

■ 2 | 43210/87/10

1x E27 | max. 60W | 230V | □

Y | 1 453 | ↔ 320 | ↗ 320 |





## Macena

1 | 37890/06/10

4x E27 | max. 60W | 230V | Ⓢ

Y | | 1165 | ↔ 1114 | ↗ 154 |





Macena

1 | 37892/06/10

1x E27 | max. 60W | 230V | ⊕

Y | | 1 295 | ← 154 | ↗ 240 |



Macena

2 | 37893/06/10

2x E27 | max. 60W | 230V | ⊞

Y | | 1 1669 | ← 454 | ↗ 280 |



Macena

3 | 37894/06/10

1x E27 | max. 60W | 230V | ⊞

Y | | 1 154 | ← 506 | ↗ 506 |



2



1



Декоративные светильники

16

3



Maupa

1 | 37995/86/10

3x E27 | max. 60W | 230V | Ⓢ

Y | | 1700 | ↔ 900 | ↗ 180 |



Maupa

2 | 37997/86/10

1x E27 | max. 60W | 230V | Ⓢ

Y | | 190 | ↔ 250 | ↗ 110 |



Maupa

3 | 37998/86/10

2x E27 | max. 60W | 230V | Ⓢ

Y | | 1602 | ↔ 330 | ↗ 180 |





**Adorno**

1	36505/43/10
	5x E14   max. 40W   230V   $\oplus$
	1150   $\leftrightarrow$ 660   $\swarrow$ 660
	MET

**Adorno**

2	36507/43/10
	2x E14   max. 40W   230V   $\oplus$
	1270   $\leftrightarrow$ 305   $\swarrow$ 200
	MET



1

2



Hersa

1 | 37355/43/10

2x E27 | max. 150W | 230V | Ⓢ

Y | | 1500 | ↔ 990 | ↗ 350 |



Hersa

2 | 37359/43/10

1x E27 | max. 75W | 230V | Ⓢ

Y | | 486 | ↔ 290 | ↗ 290 |





## Hersa

1 | 37358/43/10

1x E27 | max. 100W | 230V | ☐

Y | 1500 | ← 350 | ↗ 654 |



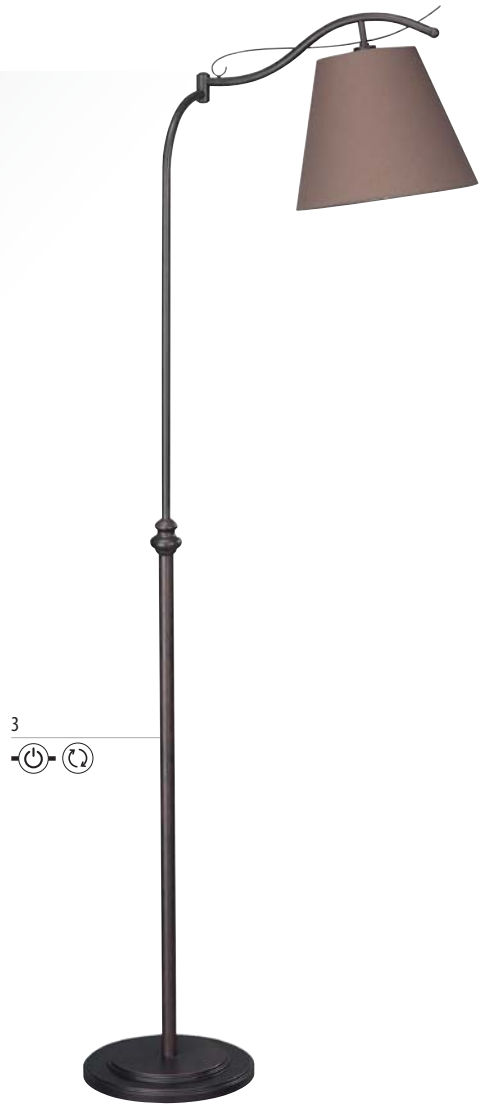

Edward

■	1   37670/86/10
	2x E27   max. 75W   230V   Ⓢ
Y	11097   ↔ 785   ↗ 259
	MET

Edward

■	2   37672/86/10
	1x E14   max. 40W   230V   Ⓢ
Y	1263   ↔ 213   ↗ 400
	MET

Edward

■	3   37673/86/10
	1x E27   max. 75W   230V   Ⓢ
Y	11584   ↔ 260   ↗ 448
	MET

Edward

■	4   37674/86/10
	1x E14   max. 40W   230V   Ⓢ
Y	1673   ↔ 213   ↗ 366
	MET



## Edward

1 | 37671/86/10

5x E14 | max. 60W | 230V | Ⓢ

Y | I 1007 | ← 623 | ↗ 623 |







3



1



2

### Agricola

1 | 37530/86/10

1x E27 | max. 60W | 230V | Ⓢ

Y | | 1500 | ↔ 320 | ↗ 320 |



### Agricola

2 | 37531/86/10

3x E27 | max. 60W | 230V | Ⓢ

Y | | 1500 | ↔ 800 | ↗ 260 |



### Agricola

3 | 37532/86/10



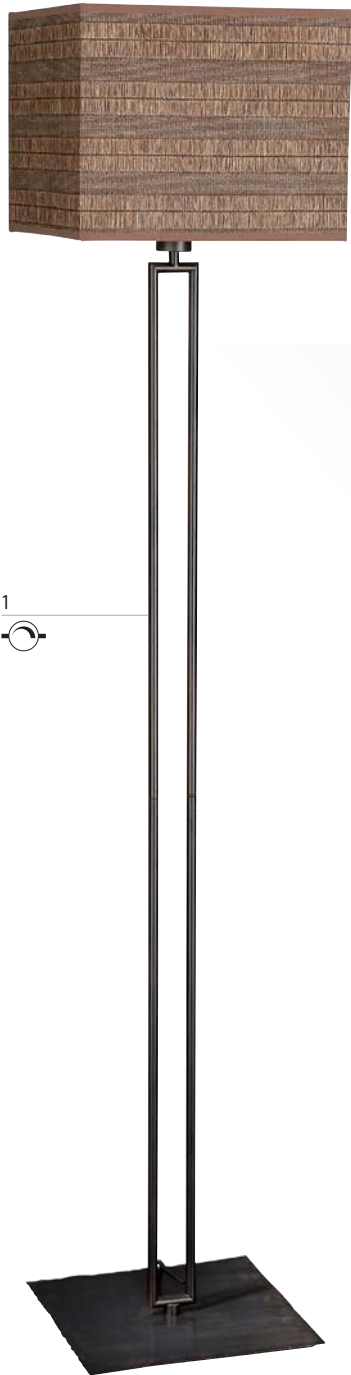

1x E27 | max. 60W | 230V | Ⓢ

Y | | 190 | ↔ 315 | ↗ 110 |









**Agricola**

	1   37533/86/10
	1x E27   max. 60W   230V   
	1 1594   ← 320   ↗ 320
	

**Agricola**

	2   37534/86/10
	1x E27   max. 60W   230V   
	1 385   ← 180   ↗ 180
	



Dunlo

■	1   37410/43/10
	1x E27   max. 75W   230V   Ⓢ
Y	1338   ↔ 172   ↗ 172
	ALU MET

Dunlo

■	2   37411/43/10
	3x E27   max. 75W   230V   Ⓢ
Y	1380   ↔ 972   ↗ 172
	ALU MET

Dunlo

■	3   37413/43/10
	1x E27   max. 75W   230V   □
Y	1580   ↔ 240   ↗ 660
	ALU MET

Dunlo

■	4   37414/43/10
	1x E27   max. 60W   230V   □
Y	1486   ↔ 200   ↗ 334
	ALU MET





Экономят энергию 



**Aki**

1 | 37665/86/10



**PHILIPS 14W INCL.**

1x E27 | max. 14W | 230V | 



| 1800 | ← 400 | ↗ 400 |



**Aki**

2 | 37666/86/10



**PHILIPS 14W INCL.**

2x E27 | max. 14W | 230V | 



| 1153 | ← 1078 | ↗ 400 |



**Aki**

3 | 37667/86/10



**PHILIPS 14W INCL.**

1x E27 | max. 14W | 230V | 



| 1328 | ← 252 | ↗ 416 |





Lambo

■	1   39010/86/10
	5x E14   max. 60W   230V   Ⓢ
Y	1600   ↔ 560   ↗ 560
	MET

Lambo

■	2   39011/86/10
	8x E14   max. 60W   230V   Ⓢ
Y	1600   ↔ 580   ↗ 580
	MET

Lambo

■	3   39012/86/10
	2x E14   max. 60W   230V   Ⓢ
Y	430   ↔ 355   ↗ 205
	MET



Agee

■	1   36950/86/10
	1x E27   max. 75W   230V   ⊕
Y	1500   ↔ 160   ↗ 160
	MET SYN

Agee

■	2   36952/86/10
	1x E27   max. 75W   230V   ⊕
Y	1245   ↔ 122   ↗ 100
	MET SYN

Agee

■	3   36953/86/10
	1x E27   max. 75W   230V   ⊕
Y	1709   ↔ 240   ↗ 240
	MET SYN

Agee

■	4   36954/86/10
	1x E27   max. 60W   230V   ⊕
Y	1268   ↔ 116   ↗ 116
	MET SYN

2



1



3



Dupre

1 | 37465/43/10

1x E27 | max. 60W | 230V | Ⓢ

Y | | 1500 | ↔ 400 | ↗ 400 |

MET SYN

Dupre

2 | 37467/43/10

1x E14 | max. 40W | 230V | Ⓢ

Y | | 260 | ↔ 165 | ↗ 115 |

MET SYN

Marco

3 | 42198/26/10

3x E14 | max. 40W | 230V | Ⓢ



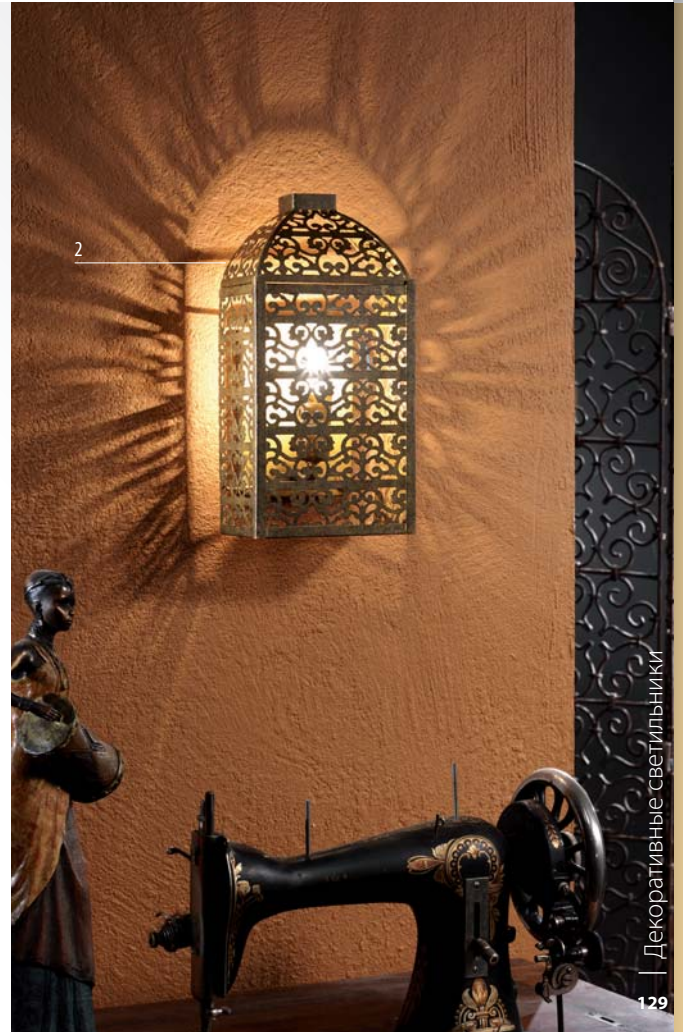

Y | | 1165 | ↔ 215 | ↗ 215 |

MET SYN









**Kene**

	1   37560/43/10
	1x E27   max. 75W   230V   
	1490   ← 153   ↗ 153
	

**Kene**

	2   37562/43/10
	1x E14   max. 40W   230V   
	320   ← 155   ↗ 110
	

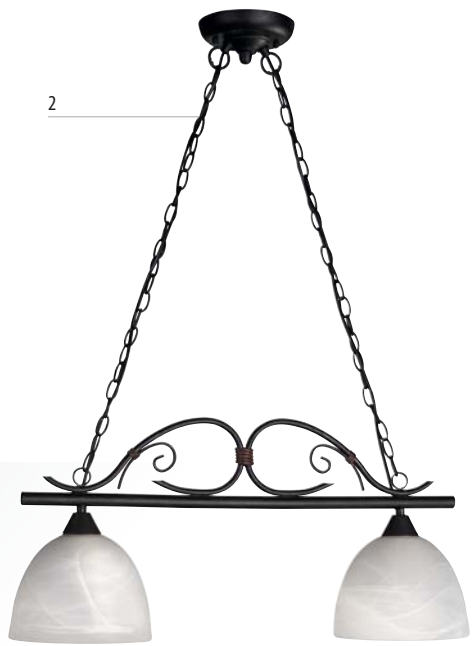

**Kissingo**

■	1   37740/43/10
	1x E27   max. 60W   230V   ⊕
Y	1113   ↔ 400   ↗ 400
	MET

**Kissingo**

■	2   37741/43/10
	2x E27   max. 60W   230V   ⊕
Y	1500   ↔ 680   ↗ 200
	MET

**Kissingo**

■	3   37742/43/10
	1x E27   max. 60W   230V   ⊕
Y	1225   ↔ 135   ↗ 200
	MET

**Kissingo**

■	4   37745/43/10
	5x E27   max. 60W   230V   ⊕
Y	1000   ↔ 560   ↗ 560
	MET



**Alarik**

1	37680/86/10
1x E27	max. 60W   230V   $\oplus$
Y	$\downarrow$ 1270   $\leftarrow$ 450   $\swarrow$ 450
MET	





**Alarik**

2	37681/86/10
2x E27	max. 60W   230V   $\oplus$
Y	$\downarrow$ 1100   $\leftarrow$ 1040   $\swarrow$ 390
MET	















Dion

	1   36490/43/10
	1x E27   max. 100W   230V   
	↑ 1300   ↔ 400   ↘ 400
	

Dion

	2   36491/43/10
	5x E14   max. 40W   230V   
	↑ 1155   ↔ 650   ↘ 650
	

Dion

	3   36492/43/10
	1x E14   max. 40W   230V   
	↑ 210   ↔ 180   ↘ 245
	



Docu

1 | 36375/43/10

3x E14 | max. 40W | 230V | Ⓢ

Y | | 1095 | ← 590 | ↗ 590 |



Docu

2 | 36376/43/10

5x E14 | max. 40W | 230V | Ⓢ

Y | | 1090 | ← 670 | ↗ 670 |



Docu

3 | 36377/43/10

1x E14 | max. 40W | 230V | Ⓢ

Y | | 150 | ← 170 | ↗ 230 |



Docu

4 | 36379/43/10

1x E14 | max. 40W | 230V | Ⓢ

Y | | 1450 | ← 170 | ↗ 250 |





1



2

Indy





	1   38811/42/10
	<b>PHILIPS 40W INCL.</b>
	12x G9   max. 40W   230V
	1950   ← 940   ↗ 910

Indy





	2   38812/42/10
	<b>PHILIPS 40W INCL.</b>
	2x G9   max. 40W   230V
	1285   ← 290   ↗ 160



**Kanto**

	1   36995/43/10
	5x E14   max. 60W   230V   
	1 850   ↔ 550   ↗ 550
	

**Kanto**

	2   36996/43/10
	3x E14   max. 60W   230V   
	1 850   ↔ 465   ↗ 465
	



Arezzo

1 | 38980/43/10

3x E14 | max. 40W | 230V | Ⓢ

Y | | 1900 | ↔ 590 | ↗ 590 |



Arezzo

2 | 38981/43/10

5x E14 | max. 40W | 230V | Ⓢ

Y | | 1900 | ↔ 590 | ↗ 590 |



Arezzo

3 | 38982/43/10

1x E14 | max. 40W | 230V | Ⓢ

Y | | 1170 | ↔ 135 | ↗ 290 |



1



2



3



4



Descartes

1 | 2322/01/54

1x E27 | max. 60W | 230V | Ⓢ

Y | | 1040 | ← 360 | ↗ 360 |



Johnson

2 | 7616/01/54

1x E14 | max. 40W | 230V | Ⓢ

Y | | 125 | ← 80 | ↗ 165 |



Johnson

3 | 7616/06/54

6x E14 | max. 40W | 230V | Ⓢ

Y | | 1000 | ← 570 | ↗ 320 |



Johnson

4 | 7617/05/54

5x E14 | max. 40W | 230V | Ⓢ

Y | | 815 | ← 510 | ↗ 510 |





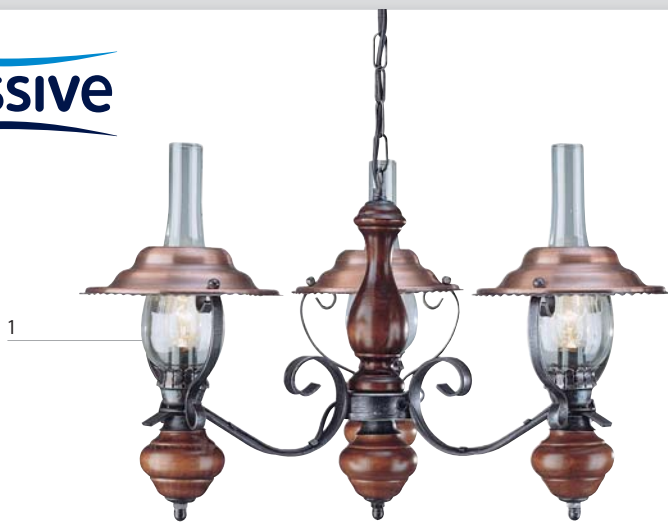

**Bonapa**

1	73357/03/54
3x E14   max. 40W   230V   Ⓢ	
1900   ↔ 650   ↘ 650	

**Bonapa**

2	75623/01/54
1x E27   max. 60W   230V   Ⓢ	
1880   ↔ 245   ↘ 245	

**Bonapa**

3	75624/01/54
1x E27   max. 60W   230V   Ⓢ	
1000   ↔ 390   ↘ 390	

**Bonapa**

4	80357/01/54
1x E14   max. 40W   230V   Ⓢ	
1355   ↔ 190   ↘ 235	





**Mauno**

<input type="checkbox"/>	1   40626/31/10
	1x E27   max. 40W   230V
	↓ 1500   ↔ 360   ↗ 360
	Доступно начиная с июля 2011

**Capone**

<input type="checkbox"/>	2   41631/62/10
	1x E27   max. 100W   230V
	↓ 1700   ↔ 275   ↗ 275

**Flandrina**





<input type="checkbox"/>	3   41757/43/10
	1x E27   max. 100W   230V
	↓ 865   ↔ 235   ↗ 235

**Morse**





<input type="checkbox"/>	4   41790/86/10
	1x E27   max. 100W   230V
	↓ 925   ↔ 150   ↗ 150







**Baldi**

	1   41614/43/10
1x E27   max. 75W   230V   	
	1500   ↔ 203   ↗ 210
	





**Baldi**

	2   41615/43/10
1x E27   max. 75W   230V   	
	1500   ↔ 200   ↗ 200
	

**Capone**







	3   41631/60/10
1x E27   max. 100W   230V   	
	1700   ↔ 275   ↗ 275
	

**Baptiste**





	4   41788/43/10
1x E27   max. 100W   230V   	
	1940   ↔ 330   ↗ 330
	



**Bar**

	1   41815/32/10
	2   41815/60/10
	1x E27   max. 100W   230V   
	1 975   ← 195   ↗ 195
	

**Flo**

	3   41816/62/10
	1x E27   max. 100W   230V   
	1 795   ← 150   ↗ 150
	

Экономят энергию



**Fourier**

1 | 42184/06/10

PHILIPS 22W INCL.

1x 2GX13 | max. 22W | 230V | ⚡

9W INCL.

1x E14 | max. 9W | 230V |

| 1790 | ↔ 280 | ↗ 280 |



**Bavo**

2 | 42192/17/10

55W INCL.

1x GR10 | max. 55W | 230V | ⚡

9W INCL.

1x E14 | max. 9W | 230V |

| 1800 | ↔ 345 | ↗ 345 |



**Padu**

3 | 42196/17/10

22W INCL.

1x E27 | max. 22W | 230V | ⚡

9W INCL.

1x E14 | max. 9W | 230V |

| 1810 | ↔ 345 | ↗ 330 |



Экономят  
энергию



### Camus

1 | 79094/22/01

2 | 79094/22/17

**PHILIPS Ecohalo 200W INCL.**

1x R7S 118 | max. 300W | 230V | ⚡

**PHILIPS 40W INCL.**

1x G9 | max. 40W | 230V |

| 1845 | ← 320 | ↗ 320 |



### Medi

3 | 79097/22/06

4 | 79097/22/17

**PHILIPS Ecohalo 200W INCL.**

1x R7S 118 | max. 300W | 230V | ⚡

**PHILIPS 40W INCL.**

1x G9 | max. 40W | 230V |

| 1810 | ← 290 | ↗ 290 |





## Barnard

1 | 42071/17/10

**PHILIPS Ecohalo 200W INCL.**

1x R7S 118 | max. 300W | 230V | Ⓢ

**PHILIPS 40W INCL.**

1x G9 | max. 40W | 230V |

| 1 1835 | ↔ 420 | ↗ 285 |





Экономят  
энергию 

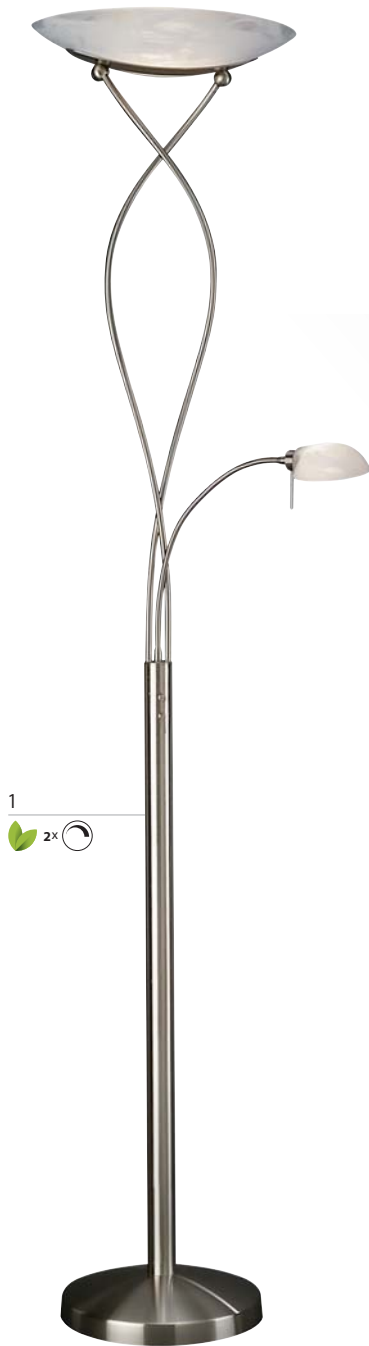

### Banting

1 | 42069/17/10

2 | 42069/43/10

 **PHILIPS Ecohalo 200W INCL.**

1x R7S 118 | max. 300W | 230V | 

 **PHILIPS 40W INCL.**

1x G9 | max. 40W | 230V |

 | ↑ 1800 | ← 360 | ↗ 360 |



### Barnard

3 | 42071/06/10

 **PHILIPS Ecohalo 200W INCL.**

1x R7S 118 | max. 300W | 230V | 

 **PHILIPS 40W INCL.**

1x G9 | max. 40W | 230V |

 | ↑ 1835 | ← 420 | ↗ 285 |



Экономят энергию



3  
2x

4  
2x

1

2

Achebe

1 | 9939/21/17

2 | 9939/21/30

PHILIPS Ecohalo 200W INCL.

1x R7S 118 | max. 300W | 230V

1 | 1760 | 280 | 280



Mamo

3 | 42070/06/10

4 | 42070/17/10

PHILIPS Ecohalo 200W INCL.

1x R7S 118 | max. 300W | 230V

PHILIPS 40W INCL.

1x G9 | max. 40W | 230V

1 | 1830 | 285 | 285



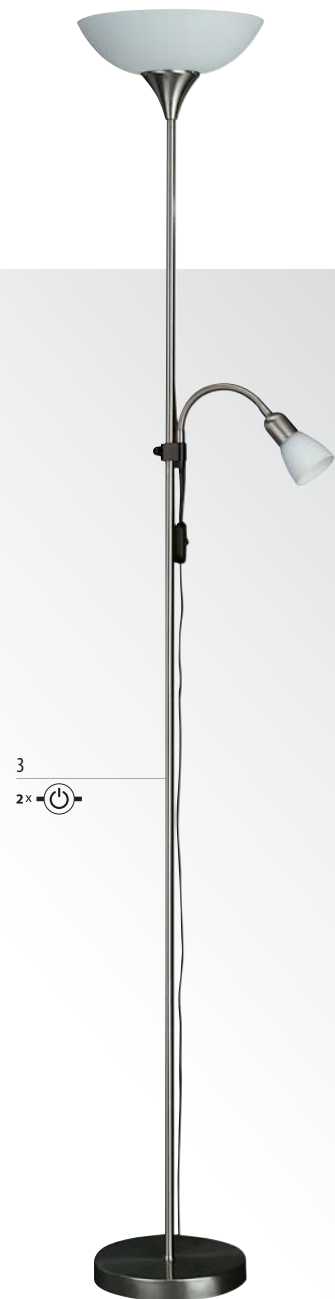
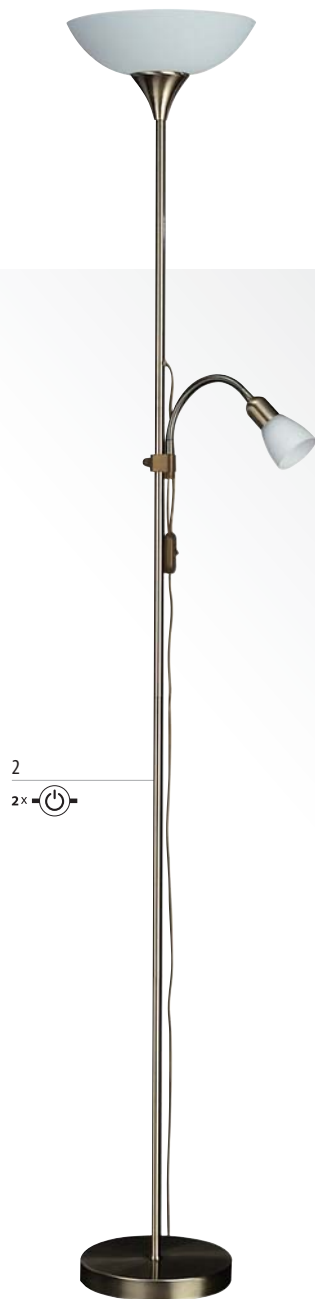

**Diaconus**

1 | 9297/02/43

1x E14 | max. 40W | 230V | ☐

1x E27 | max. 150W | 230V |

Y | | 1730 | ← 500 | ↗ 350 |



**Foca**

2 | 42084/06/10

3 | 42084/17/10

1x E14 | max. 40W | 230V | ☐

1x E27 | max. 100W | 230V |

Y | | 1860 | ← 275 | ↗ 275 |





# Настенные и ПОТОЛОЧНЫЕ СВЕТИЛЬНИКИ

---



## Ode

1 | 30350/11/10

 PHILIPS 23W INCL.

2x E27 | max. 23W | 230V | ⊕

 | T 100 | ↔ 501 | ↗ 448 |



Доступно начиная с июля 2011



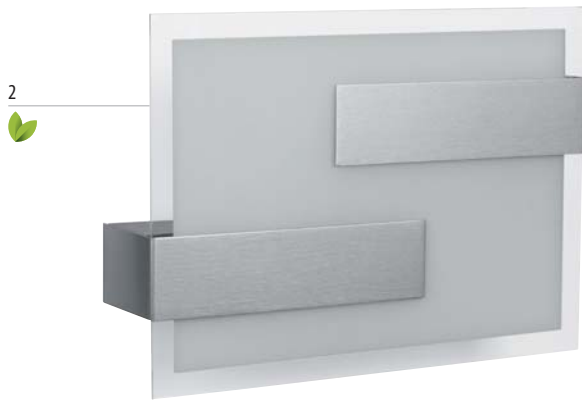

Экономят энергию 



**Nessa**

 1 | 33242/17/10

 **PHILIPS Ecohalo 70W INCL.**  
1x R7S 78 | max. 70W | 230V | ⊕

 | ↑ 120 | ↔ 300 | ↗ 80 |

 

Доступно начиная с июля 2011

**Valerie**

 2 | 33243/48/10

 **PHILIPS 23W INCL.**  
2x E27 | max. 23W | 230V | ⊕

 | ↑ 225 | ↔ 314 | ↗ 71 |

Доступно начиная с июля 2011

**Ode**

 3 | 33249/11/10

 **PHILIPS 23W INCL.**  
1x E27 | max. 23W | 230V | ⊕

 | ↑ 202 | ↔ 401 | ↗ 109 |

Доступно начиная с июля 2011

Экономят энергию

3



1



2



Susan

1 | 30175/30/10

2 | 30175/38/10

PHILIPS 23W INCL.

2x E27 | max. 23W | 230V | Ⓢ

| T 97 | ↔ 316 | ↗ 316 |



Susan

3 | 33200/30/10

PHILIPS 23W INCL.

1x E27 | max. 23W | 230V | Ⓢ

| ↑ 168 | ↔ 315 | ↗ 111 |









## Susan

1 | 33200/38/10

 **PHILIPS 23W INCL.**

1x E27 | max. 23W | 230V | 

 | 1 168 |  315 |  111 |





## Tyler

1 | 33247/38/10

 **PHILIPS 15W INCL.**

1x E27 | max. 15W | 230V | 

 | 1 260 |  $\leftrightarrow$  280 |  $\swarrow$  94 |



Доступно начиная с июля 2011

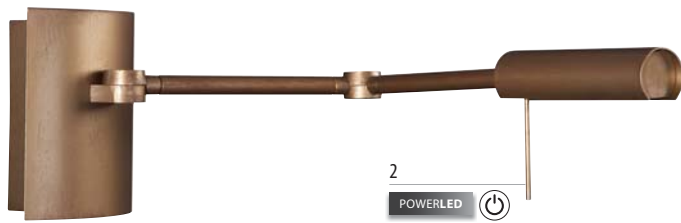

Экономят  
энергию 

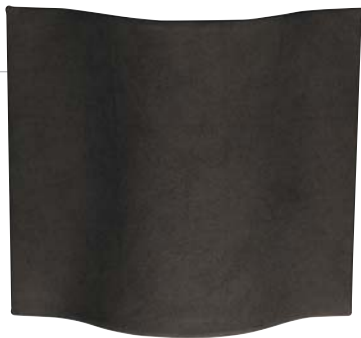



Настенные и потолочные светильники

155

## Tyler

1 | 33247/93/10

 **PHILIPS 15W INCL.**  
1x E27 | max. 15W | 230V | 

 | 1 260 | 280 | 94 |





Доступно начиная с июля 2011

## Lina

2 | 33261/06/10

3 | 33261/17/10

**LED 7,5W INCL.** | PowerLED  
1x LED | max. 7,5W | -SELV | 

 | 1 125 | 100 | 478 |



Доступно начиная с июля 2011



## Katie

1 | 33246/31/10

 PHILIPS 23W INCL.

1x E27 | max. 23W | 230V | 

 | 1120 | ← 270 | ↗ 108 |

Доступно начиная с июля 2011





Экономят энергию 



**Malia**

 1 | 33245/31/10

 2 | 33245/48/10

 **PHILIPS 23W INCL.**  
1x E27 | max. 23W | 230V | 



 | ↑ 289 | ↔ 156 | ↘ 81 |

 

Доступно начиная с июля 2011

**Katie**

 3 | 33246/30/10

 **PHILIPS 23W INCL.**  
1x E27 | max. 23W | 230V | 

 | ↑ 120 | ↔ 270 | ↘ 108 |

Доступно начиная с июля 2011



1



 ЭКОНОМЯТ  
энергию

3



2



4





### Inga

 1 | 33231/06/10

 2 | 33231/17/10

 **PHILIPS 23W INCL.**

1x E27 | max. 23W | 230V | 

 | 199 | ↔ 298 | ↗ 101 |





### Dawn

 3 | 33232/17/10

 4 | 33232/74/10

 **PHILIPS 12W INCL.**

1x E14 | max. 12W | 230V | 

 | 180 | ↔ 301 | ↗ 83 |





## Dawn

□ 1 | 33232/31/10

 **PHILIPS 12W INCL.**

1x E14 | max. 12W | 230V | Ⓢ

Y | 180 | ← 301 | ↗ 83 |



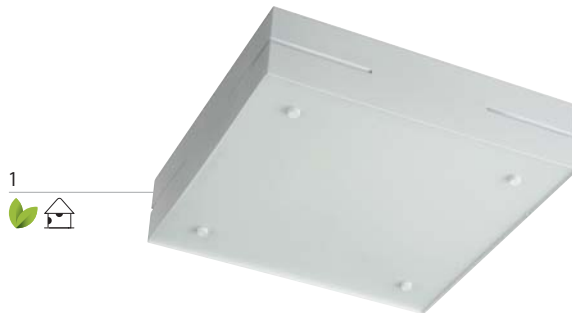

Экономят энергию



Adriana

	1   30194/31/10
	<b>PHILIPS 23W INCL.</b> 2x E27   max. 23W   230V
	T 85   ← 350   ↗ 350

Carley

	2   30197/31/10
	<b>PHILIPS 40W INCL.</b> 1x 2GX13   max. 40W   230V
	T 61   ← 396   ↗ 396

Myra

	3   33230/17/10
	<b>PHILIPS 23W INCL.</b> 2x E27   max. 23W   230V
	T 100   ← 442   ↗ 96





## Adriana

1 | 33208/31/10

 **PHILIPS 23W INCL.**

1x E27 | max. 23W | 230V | 

 | 1 170 |  228 |  100 |



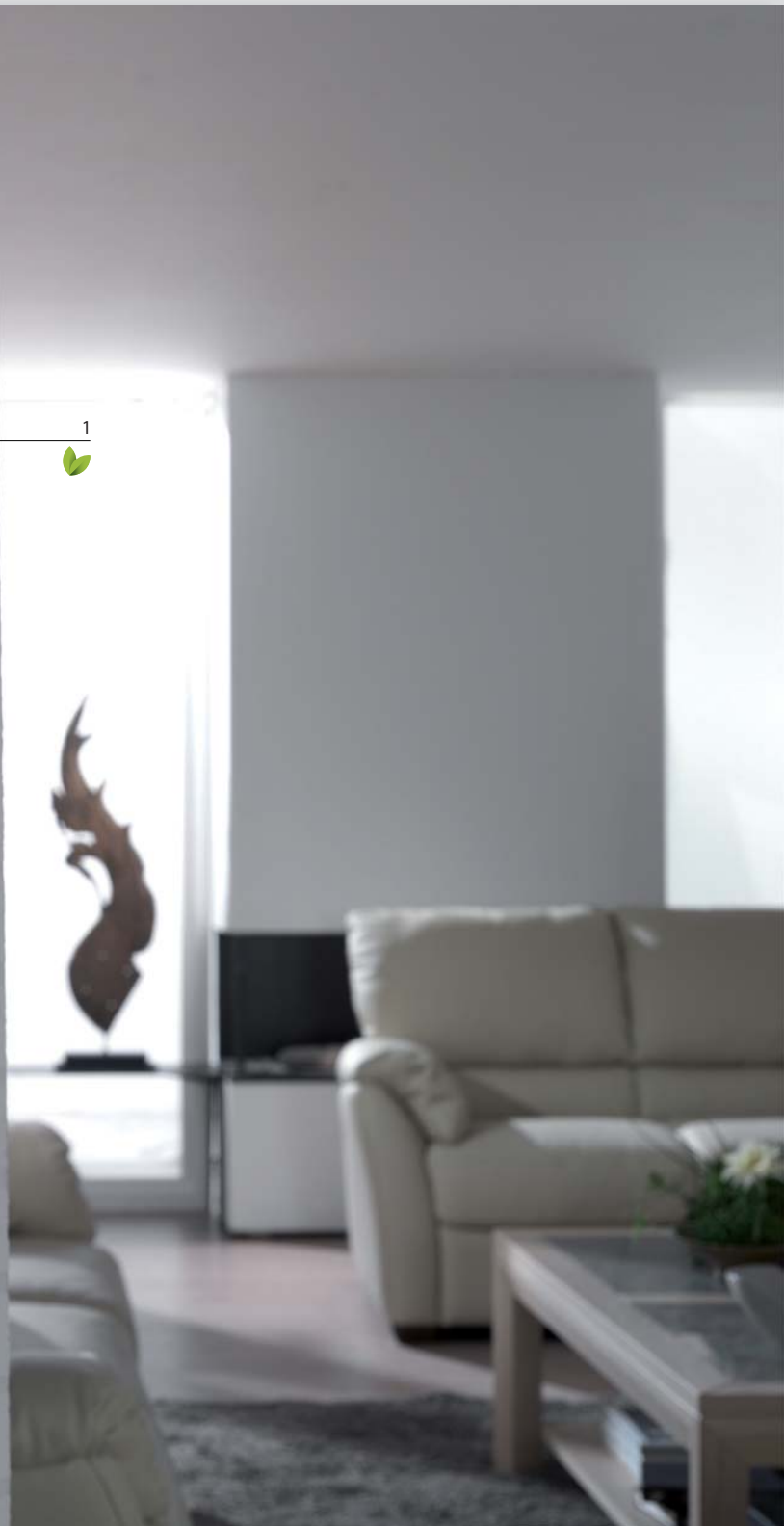





## Gillian

1 | 33206/31/10

 PHILIPS 23W INCL.

1x E27 | max. 23W | 230V | 

 | 190 |  401 |  103 |





1

Экономят  
энергию



2



3

Emily

	1   30198/17/10
	<b>PHILIPS 18W INCL.</b> 2x E27   max. 18W   230V
	T 79   ↔ 350   ↗ 350

Evita

	2   30200/87/10
	<b>PHILIPS 18W INCL.</b> 2x E27   max. 18W   230V
	T 86   ↔ 400   ↗ 400

Gillian

	3   33206/93/10
	<b>PHILIPS 23W INCL.</b> 1x E27   max. 23W   230V
	I 90   ↔ 401   ↗ 103

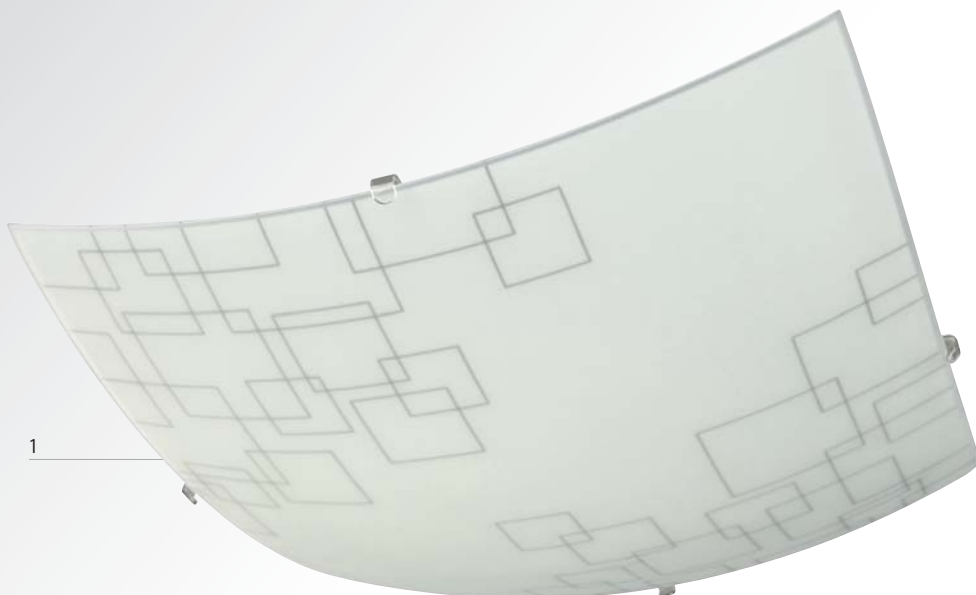

Ivy

■	1   30307/87/10
	2x E27   max. 60W   230V   ⊕
Y	T 94   ↔ 400   ↗ 400
	Доступно начиная с июля 2011

Ivy

■	2   30308/87/10
	1x E27   max. 100W   230V   ⊕
Y	T 90   ↔ 290   ↗ 290
	Доступно начиная с июля 2011

Ivy

■	3   33307/87/10
	1x E27   max. 60W   230V   ⊕
Y	T 250   ↔ 248   ↗ 109
	Доступно начиная с июля 2011



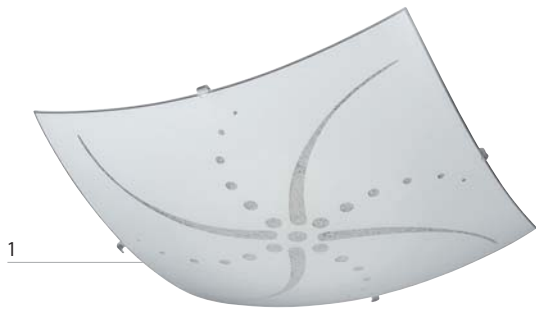

**Ellis**

1	30165/69/10
1x E27   max. 60W   230V   Ⓢ	
T 90   ↔ 290   ↗ 290	
MET	

**Ellis**

2	30180/69/10
2x E27   max. 60W   230V   Ⓢ	
T 94   ↔ 400   ↗ 400	
MET	

**Imani**

3	33237/69/10
1x E27   max. 60W   230V   Ⓢ	
T 290   ↔ 280   ↗ 90	
MET	

**Ellis**

4	80815/69/10
1x E27   max. 60W   230V   Ⓢ	
T 250   ↔ 248   ↗ 109	
MET	





1







2



### Quadro

	1   30010/67/10
	1x E27   max. 100W   230V   
	T 95   ↔ 290   ↗ 290
	

### Zebra

	2   30011/67/10
	1x E27   max. 100W   230V   
	T 95   ↔ 290   ↗ 290
	



### Quadros

1 | 30012/11/10

2 | 30012/17/10

1x E27 | max. 100W | 230V | Ⓢ

Y | T 85 | ↔ 360 | ↗ 360



### Amber

3 | 30190/17/10

PHILIPS Ecohalo 42W INCL.

1x G9 | max. 60W | 230V | Ⓢ

Y | T 80 | ↔ 220 | ↗ 220



Экономят  
энергию

2



1



Norah

1 | 30294/48/10



PHILIPS 36W INCL.

3x 2G11 | max. 36W | 230V | Ⓢ



| T 70 | ↔ 550 | ↗ 550 |



Norah

2 | 30295/48/10



PHILIPS 36W INCL.

2x 2G11 | max. 36W | 230V | Ⓢ



| T 70 | ↔ 550 | ↗ 290 |





1



Экономят  
энергию



2



3

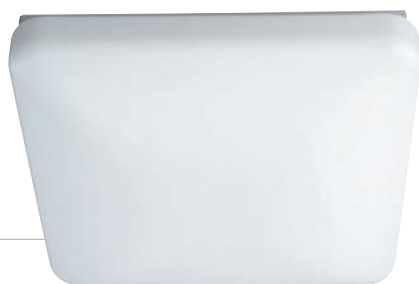

4



### Belinda

□ 1 | 30801/31/10

⊙ PHILIPS 22W INCL.

1x G10Q | max. 22W | 230V | ⊕

Y | T 83 | ↔ 280 | ↗ 280 |

MET SYN

IP44

### Belinda

□ 2 | 30802/31/10

⊙ PHILIPS 32W INCL.

1x G10Q | max. 32W | 230V | ⊕

Y | T 88 | ↔ 350 | ↗ 350 |

SYN

IP44

### Belinda

□ 3 | 30803/31/10

⊙ PHILIPS 40W INCL.

1x G10Q | max. 40W | 230V | ⊕

Y | T 88 | ↔ 490 | ↗ 490 |

MET SYN

IP44

### Berdine

□ 4 | 30842/31/10

⊙ PHILIPS 32W INCL.

1x G10Q | max. 32W | 230V | ⊕

Y | T 83 | ↔ 370 | ↗ 370 |

MET SYN

IP44

 **ЭКОНОМЯТ**  
энергию

1 



2 



**Lexie**

1 | 30221/31/10

 **PHILIPS 40W INCL.**

1x 2GX13 | max. 40W | 230V | 

 | T 120 | ↔ 437 | ↗ 437 |



**Lexie**

2 | 30222/31/10

 **PHILIPS 40W INCL.**

1x 2GX13 | max. 40W | 230V | 

 | T 120 | ↔ 437 | ↗ 437 |

















Экономят  
энергию 



Lora

	1   30243/48/10
	PHILIPS 40W INCL.
	1x 2GX13   max. 40W   230V   
	T 90   ← 405   ↗ 405
	

Lora

	2   30244/48/10
	PHILIPS 22W INCL.
	1x 2GX13   max. 22W   230V   
	T 105   ← 350   ↗ 350
	





**Zeus**

	1   33006/17/10
	1x E14   max. 40W   230V
	T 75   ← 180   ↗ 180

**Screen**

	2   33014/17/10
	1x E14   max. 40W   230V
	I 210   ← 300   ↗ 70

**Nicole**

	3   33065/17/10
	<b>70W INCL.</b>
	1x R7S 78   max. 70W   230V
	I 100   ← 165   ↗ 105

**Mia**

	4   33115/17/10
	<b>PHILIPS Ecohalo 70W INCL.</b>
	1x R7S 78   max. 100W   230V
	I 90   ← 250   ↗ 105

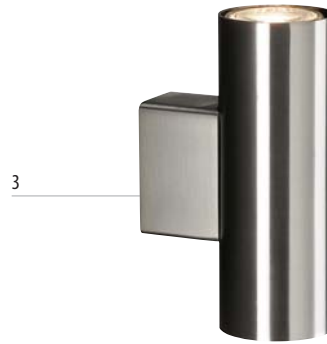
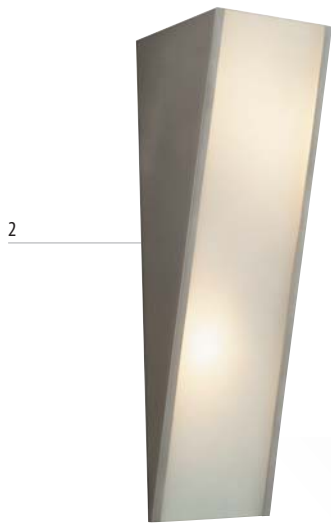

Настенные и потолочные светильники

### Cube

1 | 33012/17/10

 **PHILIPS 50W INCL.**  
2x GU10 | max. 50W | 230V | Ⓢ

 | 150 | ↔ 83 | ↘ 85 |



### Claire

2 | 33127/17/10

 **PHILIPS 40W INCL.**  
1x G9 | max. 40W | 230V | Ⓢ

 **PHILIPS 25W INCL.**  
1x G9 | max. 25W | 230V |

 | 1305 | ↔ 90 | ↘ 100 |



### Cleo

3 | 33132/17/10

 **PHILIPS 50W INCL.**  
2x GU10 | max. 50W | 230V | Ⓢ

 | 166 | ↔ 60 | ↘ 100 |



### Charlotte

4 | 33160/17/10

 **PHILIPS Ecohalo 42W INCL.**  
1x G9 | max. 60W | 230V | Ⓢ

 | 182 | ↔ 82 | ↘ 92 |





3



4



1 LED



2 LED

Led's move

1 | 33510/48/10

LED 3W INCL. | 16-LED

1x LED | max. 0,96W |  $\frac{2800}{3,2V}$  |

| 1140 |  $\leftrightarrow$  60 |  $\swarrow$  220 |

Led's go

2 | 33512/48/10

LED 4W INCL. | 16-LED

2x LED | max. 0,96W |  $\frac{2800}{3,2V}$  |

| 1141 |  $\leftrightarrow$  60 |  $\swarrow$  67 |

Riley

3 | 70712/02/17

2x E14 | max. 40W | 230V |

| T 62 |  $\leftrightarrow$  310 |  $\swarrow$  310 |

Riley

4 | 70712/03/17

3x E14 | max. 40W | 230V |

| T 62 |  $\leftrightarrow$  405 |  $\swarrow$  405 |



**Candide**

■	1   30136/48/10
	1x E27   max. 100W   230V   Ⓢ
Y	T 100   ↔ 317   ↗ 317
	MET

**Bertha**

■	2   30164/17/10
	4x E27   max. 60W   230V   Ⓢ
Y	T 131   ↔ 517   ↗ 517
	MET

**Annika**

■	3   70670/01/11
	1x E27   max. 60W   230V   Ⓢ
Y	T 75   ↔ 255   ↗ 255
	MET

1  



4



2  



5









3  











6



**Fergie**

	1   70700/01/11
	2   70700/01/17
	3   70700/01/31
1x E27   max. 60W   230V   	
   T 80   ↔ 310   ↗ 310	
 	

**Fergie**

	4   81531/01/11
	5   81531/01/17
	6   81531/01/31
1x E27   max. 60W   230V   	
   ↑ 155   ↔ 310   ↗ 80	
 	



### Universe

■ 1 | 30050/17/10

■ 2 | 30050/56/10

2x E27 | max. 75W | 230V | Ⓢ

Y | T 100 | ↔ 340 | ↗ 340 |



### Demy

■ 3 | 33050/17/10

1x E27 | max. 60W | 230V | Ⓢ

Y | T 150 | ↔ 290 | ↗ 80 |



### Tia

■ 4 | 77050/01/17

■ 5 | 77050/01/56

1x E27 | max. 60W | 230V | Ⓢ

Y | T 85 | ↔ 265 | ↗ 265 |





**Crissy**

<input type="checkbox"/>	1   30179/67/10
	1x E27   max. 100W   230V
	T 90   ↔ 290   ↗ 290

**Crissy**

<input type="checkbox"/>	2   30180/67/10
	2x E27   max. 60W   230V   Ⓢ
	T 94   ↔ 400   ↗ 400







**Crissy**

<input type="checkbox"/>	3   33199/67/10
	1x E27   max. 60W   230V   Ⓢ
	I 257   ↔ 263   ↗ 85





**Ana**

	1   77418/11/10
	2   77418/60/10
1x E27   max. 60W   230V   	
	T 90   ↔ 290   ↗ 290
	



1

### Mabel

■	1   30255/30/10
	1x E27   max. 60W   230V   Ⓢ
Y	T 81   ← 300   ↗ 300
MEY	🚚

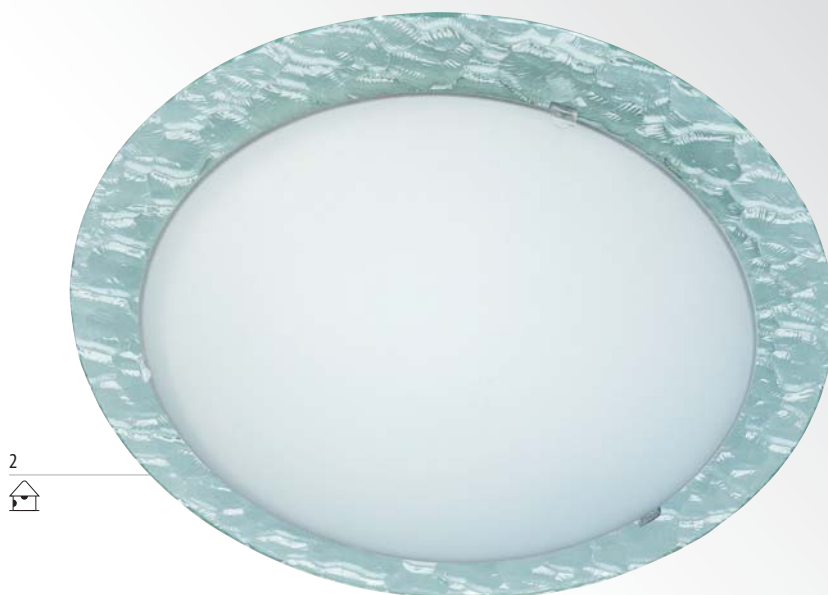

**Elin**

1	30259/67/10
1x E27   max. 60W   230V   Ⓢ	
T 82   ↔ 300   ↗ 300	
MET	

**Sadie**

2	70418/60/10
1x E27   max. 60W   230V   Ⓢ	
T 90   ↔ 313   ↗ 313	
MET	



## Rinoa

1 | 30193/01/10

1x E27 | max. 100W | 230V | Ⓢ

Y | T 96 | ↔ 413 | ↗ 413 |



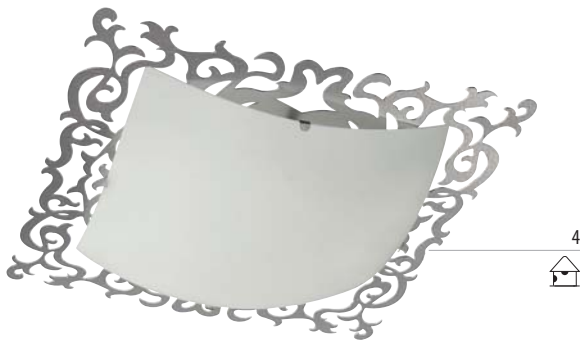

**Belle**

1 | 33248/38/10

 **PHILIPS 15W INCL.**

1x E27 | max. 15W | 230V | ⊕

 | ↑ 150 | ↔ 265 | ↘ 125 |



Доступно начиная с июля 2011

**Sue**

2 | 33252/18/10

3 | 33252/43/10

1x E27 | max. 60W | 230V | ⊕

 | ↑ 204 | ↔ 215 | ↘ 128 |



**Rinoa**

4 | 30193/14/10

1x E27 | max. 100W | 230V | ⊕

 | ↑ 96 | ↔ 413 | ↘ 413 |





## Fay

1 | 30280/67/10

2x E27 | max. 60W | 230V | Ⓢ

Y | T 135 | ↔ 400 | ↗ 400 |



Доступно начиная с июля 2011



Настенные и потолочные светильники

Fay

1 | 30279/67/10

1x E27 | max. 60W | 230V | Ⓢ

Y | T 111 | ↔ 300 | ↗ 300 |



Доступно начиная с июля 2011

Isla

2 | 31914/31/10

1x E27 | max. 60W | 230V | Ⓢ

Y | T 80 | ↔ 300 | ↗ 300 |



Dana

3 | 33227/30/10

4 | 33227/31/10

1x E14 | max. 40W | 230V | Ⓢ

Y | T 210 | ↔ 150 | ↗ 75 |







### Quadros

1 | 30012/06/10

1x E27 | max. 100W | 230V | Ⓢ

Y | T 85 | ← 360 | ↗ 360 |



### Nicole

2 | 33065/06/10

70W INCL.

1x R7S 78 | max. 70W | 230V | Ⓢ

Y | T 100 | ← 165 | ↗ 105 |



### Madison

3 | 70708/02/06

2x E27 | max. 40W | 230V | Ⓢ

Y | T 120 | ← 305 | ↗ 305 |



1



2



3



4



**Caroline**

<input type="checkbox"/>	1   30023/31/10
	1x E27   max. 100W   230V   ☐
	T 170   ← 150   ↗ 150

**Irina**

<input type="checkbox"/>	2   70172/01/60
	1x E27   max. 60W   230V   ⊕
	T 105   ← 180   ↗ 180

**Estella**

<input type="checkbox"/>	3   70173/01/60
	1x E27   max. 60W   230V   ⊕
	T 105   ← 180   ↗ 180

**Sonia**

<input type="checkbox"/>	4   72894/01/31
	1x E27   max. 60W   230V   ☐
	T 175   ← 150   ↗ 150



Leanne







1	31991/62/10
1x E27   max. 60W   230V   Ⓢ	
Y   T 85   ← 300   ↗ 300	
MET 	

Leanne







2	31992/62/10
2x E27   max. 60W   230V   Ⓢ	
Y   T 115   ← 400   ↗ 400	
MET 	



**Fergie**

	1   70368/01/53
	2   70368/01/73
1x E27   max. 60W   230V   	
T 90   ↔ 310   ↗ 310	
  	

**Fergie**

	3   81531/01/70
	4   81531/01/71
1x E27   max. 60W   230V   	
↓ 165   ↔ 315   ↗ 80	
  	

1



2



4



3



5



6



Zara

1 | 70748/01/31

2 | 70748/01/43

1x E27 | max. 60W | 230V | Ⓢ

Y | T 80 | ↔ 300 | ↗ 300 |



Zara

3 | 70748/02/31

4 | 70748/02/43

2x E27 | max. 60W | 230V | Ⓢ

Y | T 95 | ↔ 405 | ↗ 405 |



Ashley

5 | 81748/01/31

6 | 81748/01/43





1x E27 | max. 60W | 230V | Ⓢ

Y | T 155 | ↔ 300 | ↗ 75 |















### Universe

	1   30050/06/10
	2x E27   max. 75W   230V   
	T 100   ↔ 340   ↗ 340
	

### Demy

	2   33050/06/10
	1x E27   max. 60W   230V   
	T 150   ↔ 290   ↗ 80
	

### Tia

	3   77050/01/06
	1x E27   max. 60W   230V   
	T 85   ↔ 265   ↗ 265
	



3



1



4



2



Cecilia

1 | 30184/43/10

1x E27 | max. 100W | 230V | ⊕

Y | T 98 | ↔ 360 | ↗ 360 |



Sarah

2 | 33233/43/10



PHILIPS 14W INCL.

1x E27 | max. 60W | 230V | ⊕

Y | I 254 | ↔ 264 | ↗ 89 |



Nessa

3 | 33242/43/10



PHILIPS Ecohalo 70W INCL.

1x R7S 78 | max. 70W | 230V | ⊕

Y | I 120 | ↔ 300 | ↗ 80 |



Ilona

4 | 33254/43/10



PHILIPS 15W INCL.

1x E27 | max. 15W | 230V | ⊕

Y | I 260 | ↔ 373 | ↗ 89 |



Доступно начиная с июля 2011





1

## Cecilia

1 | 33204/43/10

1x E27 | max. 60W | 230V | Ⓢ

Y | 1320 | ↔ 200 | ↗ 111 |





## Moira

1 | 30204/86/10

1x E27 | max. 100W | 230V | Ⓢ

Y | T 96 | ↔ 404 | ↗ 404





**Sophie**

1 | 30067/43/10

1x E27 | max. 100W | 230V | Ⓢ

Y | T 100 | ↔ 315 | ↗ 315 |



**Alison**

2 | 30068/43/10

1x E27 | max. 100W | 230V | Ⓢ

Y | T 90 | ↔ 315 | ↗ 315 |



**Evita**

3 | 30200/86/10

 **PHILIPS 18W INCL.**

2x E27 | max. 18W | 230V | Ⓢ

Y | T 94 | ↔ 400 | ↗ 400 |



 **ЭКОНОМЯТ**  
энергию



### Sienna

 1 | 30270/43/10

 **PHILIPS 23W INCL.**  
1x E27 | max. 23W | 230V | 

 | T 118 | ↔ 316 | ↗ 316 |



Доступно начиная с июля 2011

### Sienna

 2 | 33256/43/10

 **PHILIPS 15W INCL.**  
1x E27 | max. 15W | 230V | 

 | I 160 | ↔ 300 | ↗ 88 |



Доступно начиная с июля 2011



3

Настенные и потолочные светильники

Jasmine

1	30096/43/10
1x E27   max. 60W   230V   Ⓢ	
Y	T 100   ← 310   ↗ 310
MET	☰

Jasmine

2	30097/43/10
1x E27   max. 100W   230V   Ⓢ	
Y	T 120   ← 420   ↗ 420
MET	☰

Jasmine

3	33096/43/10
1x E27   max. 60W   230V   Ⓢ	
Y	I 165   ← 300   ↗ 90
MET	☰





Настенные и потолочные светильники

198



### Aaliyah

1 | 33185/86/10

1x E14 | max. 40W | 230V | Ⓢ

Y | | 1206 | ← 227 | ↗ 72 |



### Davina

2 | 33187/86/10

 **PHILIPS Ecohalo 42W INCL.**

1x G9 | max. 42W | 230V | Ⓢ

Y | | 1450 | ← 90 | ↗ 112 |





Macy

■	1   77027/01/43
	1x E27   max. 60W   230V   Ⓢ
Y	T 85   ↔ 300   ↗ 300
	MET

Macy

■	2   77027/02/43
	2x E27   max. 60W   230V   Ⓢ
Y	T 110   ↔ 405   ↗ 405
	MET

Macy

■	3   80595/01/43
	1x E27   max. 60W   230V   Ⓢ
Y	I 155   ↔ 300   ↗ 80
	MET



Экономят  
энергию



Настенные и потолочные светильники

200

Lynne

1 | 33080/06/10

PHILIPS 13W INCL.

1x G5 | max. 13W | 230V | Ⓢ

| 151 | ↔ 555 | ↗ 222 |

MET SYN

Lynne

2 | 33081/06/10

PHILIPS 8W INCL.

1x G5 | max. 8W | 230V | Ⓢ

| 151 | ↔ 329 | ↗ 221 |

MET SYN





## Lynne

1 | 33080/48/10

 **PHILIPS 13W INCL.**

1x G5 | max. 13W | 230V | 

 | 1 51 |  555 |  222 |



Настенные и потолочные светильники

202

Cézanne

1 | 33084/06/10

2 | 33084/17/10

4x E14 | max. 15W | 230V | ☐

Y | | 180 | ↔ 465 | ↗ 200 |



Matisse

3 | 33087/06/10

4 | 33087/17/10

 PHILIPS 25W INCL.

2x G9 | max. 25W | 230V | ☐

Y | | 180 | ↔ 300 | ↗ 200 |





**Sienna**

1 | 81670/01/06

2 | 81670/01/11

1x E14 | max. 40W | 230V | Ⓢ

Y | | 110 | ↔ 210 | ↗ 225 |



**Sienna**

3 | 81670/02/06

4 | 81670/02/11

2x E14 | max. 40W | 230V | Ⓢ

Y | | 120 | ↔ 295 | ↗ 222 |





# Светильники акцентного освещения

---



 **Экономят**  
энергию

### Orbits

1 | 56424/31/10

**LED PHILIPS 7,5W INCL.** | PowerLED

4x LED | max. 7,5W |  SELV | 

 | T 115 | ↔ 525 | ↙ 90 |



Доступно начиная с июля 2011





2  
POWERLED



3  
POWERLED

POWERLED



4  
POWERLED



1  
POWERLED



5  
POWERLED

Экономит энергию 

Orbits

1 | 56420/31/10

2 | 56420/48/10

LED PHILIPS 7,5W INCL. | PowerLED

1x LED | max. 7,5W |  SELV | 

 | ↑ 181 | ↔ 90 | ↙ 115 |

ALU

Доступно начиная с июля 2011

Orbits

3 | 56422/31/10

4 | 56422/48/10

LED PHILIPS 7,5W INCL. | PowerLED

2x LED | max. 7,5W |  SELV | 

 | ↑ 115 | ↔ 265 | ↙ 90 |

ALU

Доступно начиная с июля 2011

Orbits

5 | 56424/48/10

LED PHILIPS 7,5W INCL. | PowerLED

4x LED | max. 7,5W |  SELV | 

 | ↑ 115 | ↔ 525 | ↙ 90 |

ALU

Доступно начиная с июля 2011



3

POWERLED

POWERLED



2

POWERLED



1

POWERLED

 **ЭКОНОМЯТ**  
энергию

**Kavo**

 1 | 56410/43/10

LED PHILIPS 7,5W INCL. | PowerLED

1x LED | max. 7,5W |  SELV | 

 | T 186 | ← 186 | ↗ 131 |

ALU

**Kavo**

 2 | 56413/43/10

LED PHILIPS 7,5W INCL. | PowerLED

3x LED | max. 7,5W |  SELV | 

 | T 120 | ← 112 | ↗ 285 |

ALU

**Kavo**

 3 | 56414/43/10

LED PHILIPS 7,5W INCL. | PowerLED

4x LED | max. 7,5W |  SELV | 

 | T 148 | ← 780 | ↗ 112 |

ALU



1  
POWERLED



2  
POWERLED

POWERLED



5  
POWERLED



6  
POWERLED



3  
POWERLED



4  
POWERLED

Экономят энергию 

**Kavo**

1 | 56410/17/10

2 | 56410/31/10

LED PHILIPS 7,5W INCL. | PowerLED

1x LED | max. 7,5W | SELV

Y | | T 186 | ← 112 | ↗ 131 |

ALU

**Kavo**

3 | 56413/17/10

4 | 56413/31/10

LED PHILIPS 7,5W INCL. | PowerLED

3x LED | max. 7,5W | SELV

Y | | T 120 | ← 285 | ↗ 285 |

ALU

**Kavo**

5 | 56414/17/10

6 | 56414/31/10

LED PHILIPS 7,5W INCL. | PowerLED

4x LED | max. 7,5W | SELV

Y | | T 148 | ← 780 | ↗ 112 |

ALU



Alrakis

<input type="checkbox"/>	1   52250/31/10
	<b>PHILIPS 12W INCL.</b> 1x E14   max. 12W   230V   ⊕
	182   ↔ 82   ↗ 152
Доступно начиная с июля 2011	

Alrakis

<input type="checkbox"/>	2   52252/31/10
	<b>PHILIPS 12W INCL.</b> 2x E14   max. 12W   230V   ⊕
	↑ 152   ↔ 305   ↗ 82
Доступно начиная с июля 2011	



## Alrakis

□ 1 | 52253/31/10

 **PHILIPS 12W INCL.**  
3x E14 | max. 12W | 230V | ⊕

Y | T 152 | ↔ 192 | ↗ 192 |



Доступно начиная с июля 2011



1



ЭКОНОМЯТ  
энергию



6



5



2



3



4



Studio

1 | 55650/31/10

2 | 55650/48/10

PHILIPS 10W INCL.

1x GU10 | max. 10W | 230V | ⊕

| 180 | ↔ 80 | ↗ 80 |

MET  SYN

Доступно начиная с июля 2011

Studio

3 | 55652/31/10

4 | 55652/48/10

PHILIPS 10W INCL.

2x GU10 | max. 10W | 230V | ⊕

| T 80 | ↔ 305 | ↗ 80 |

MET  SYN

Доступно начиная с июля 2011

Studio

5 | 55654/31/10

6 | 55654/48/10

PHILIPS 10W INCL.

4x GU10 | max. 10W | 230V | ⊕

| T 80 | ↔ 525 | ↗ 80 |

MET  SYN

Доступно начиная с июля 2011



Экономят  
энергию 

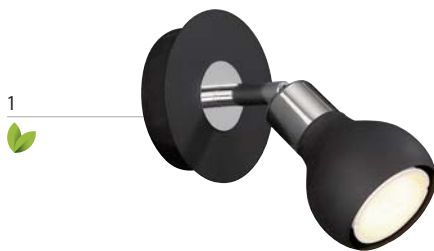

Светильники акцентного освещения

213

### Tomba

1 | 55870/30/10

 9W INCL.

1x GU10 | max. 9W | 230V | 

 | T 100 | ← 100 | ↗ 110 |

 

### Tomba

2 | 55874/30/10

 9W INCL.

4x GU10 | max. 9W | 230V | 

 | T 135 | ← 765 | ↗ 125 |

 

### Tomba

3 | 55879/30/10

 9W INCL.

3x GU10 | max. 9W | 230V | 

 | T 130 | ← 300 | ↗ 300 |





## Yildun

■ 1 | 52233/11/10

💡 **PHILIPS 12W INCL.**

3x E14 | max. 12W | 230V | Ⓢ

Y | T 126 | ↔ 525 | ↙ 109 |



Доступно начиная с июля 2011



Экономят  
энергию 





Светильники акцентного освещения

**Yildun**

 1 | 52230/11/10



---

 **PHILIPS 12W INCL.**  
1x E14 | max. 12W | 230V | 

---

 | ↑ 80 | ↔ 80 | ↗ 113 |

---

---

Доступно начиная с июля 2011

**Yildun**

 2 | 52234/11/10

---

 **PHILIPS 12W INCL.**  
4x E14 | max. 12W | 230V | 

---

 | ↑ 126 | ↔ 918 | ↗ 109 |

---

---

Доступно начиная с июля 2011

Экономят  
энергию



Светильники акцентного освещения

216

Amperi

■	1   51230/17/10
	<b>PHILIPS 12W INCL.</b> 1x E14   max. 12W   230V
	1100   ↔ 100   ↗ 115

Amperi

■	2   51231/17/10
	<b>PHILIPS 12W INCL.</b> 1x E14   max. 12W   230V
	1100   ↔ 100   ↗ 465

Amperi

■	3   51234/17/10
	<b>PHILIPS 12W INCL.</b> 4x E14   max. 12W   230V
	T 150   ↔ 760   ↗ 120

Amperi





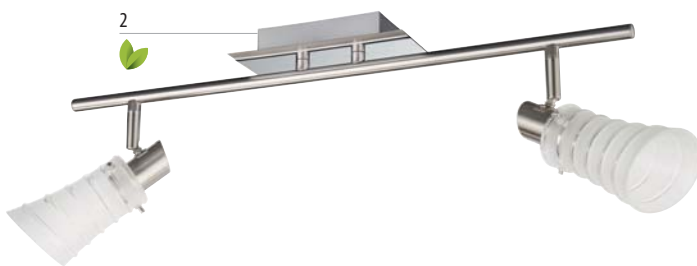

■	4   51239/17/10
	<b>PHILIPS 12W INCL.</b> 3x E14   max. 12W   230V
	T 150   ↔ 305   ↗ 305









Экономят энергию 









Jenga

	1   50920/17/10
	<b>PHILIPS 12W INCL.</b> 1x E14   max. 12W   230V   
	I 120   ← 120   ↗ 125
	







Jenga

	2   50922/17/10
	<b>PHILIPS 12W INCL.</b> 2x E14   max. 12W   230V   
	T 145   ← 550   ↗ 80
	

Jenga

	3   50924/17/10
	<b>PHILIPS 12W INCL.</b> 4x E14   max. 12W   230V   
	T 145   ← 1115   ↗ 111
	

Jenga

	4   50929/17/10
	<b>PHILIPS 12W INCL.</b> 3x E14   max. 12W   230V   
	T 145   ← 300   ↗ 300
	



ЭКОНОМЯТ  
энергию



Светильники акцентного освещения

Usagi

1 | 50990/17/10

PHILIPS 12W INCL.

1x E14 | max. 12W | 230V | Ⓢ

Y | | 110 | ← 130 | ↗ 125 |



Usagi

2 | 50994/17/10

PHILIPS 12W INCL.

4x E14 | max. 12W | 230V | Ⓢ

Y | | T 145 | ← 825 | ↗ 120 |



Usagi

3 | 50999/17/10

PHILIPS 12W INCL.

3x E14 | max. 12W | 230V | Ⓢ

Y | | T 150 | ← 300 | ↗ 300 |







## Usagi

1 | 50995/17/10

 **PHILIPS 12W INCL.**

5x E14 | max. 12W | 230V | 

 | T 175 | ← 665 | ↗ 665 |





Экономят энергию



Светильники акцентного освещения

220

Adela

	1   50950/17/10
	12W INCL. 1x E14   max. 12W   230V
	180   ← 80   ↗ 125

Adela

	2   50952/17/10
	12W INCL. 2x E14   max. 12W   230V
	T 112   ← 365   ↗ 90

Adela

	3   50954/17/10
	12W INCL. 4x E14   max. 12W   230V
	T 150   ← 695   ↗ 90





Экономят  
энергию 



**Adela**

1 | 50956/17/10

 12W INCL.

6x E14 | max. 12W | 230V | 

 | T 160 | ← 1460 | ↘ 90 |



**Adela**

2 | 50959/17/10

 12W INCL.

3x E14 | max. 12W | 230V | 

 | T 145 | ← 300 | ↘ 300 |







## Sirius

1 | 56442/11/10

 **PHILIPS Ecohalo 35W INCL.**

2x GU10 | max. 35W | 230V | 

 | T 113 | ↔ 306 | ↗ 80 |

 ALU

Доступно начиная с июля 2011



Экономят  
энергию 



### Sirius

1 | 56440/11/10

 PHILIPS Ecohalo 35W INCL.

1x GU10 | max. 35W | 230V | ⊕

 | T 113 | ← 80 | ↗ 80 |

ALU

Доступно начиная с июля 2011

### Sirius

2 | 56444/11/10

 PHILIPS Ecohalo 35W INCL.

4x GU10 | max. 35W | 230V | ⊕

 | T 112 | ← 525 | ↗ 80 |

ALU

Доступно начиная с июля 2011



Nero

■	1   56330/30/10
□	2   56330/31/10
☏	PHILIPS 50W INCL.
	1x GU10   max. 50W   230V   ☐
Y	T 120   ↔ 103   ↗ 103
	MET

Nero

■	3   56332/30/10
□	4   56332/31/10
☏	PHILIPS 50W INCL.
	2x GU10   max. 50W   230V   ☐
Y	T 120   ↔ 193   ↗ 103
	MET

Nero

■	5   56333/30/10
□	6   56333/31/10
☏	PHILIPS 50W INCL.
	3x GU10   max. 50W   230V   ☐
Y	T 120   ↔ 203   ↗ 190
	MET



Alma

■	1   56320/30/10
□	2   56320/31/10
⚡	75W INCL.
	1x GU10   max. 75W   230V   Ⓢ
⌵	180   ← 80   ↗ 122
MET	

Alma

■	3   56322/30/10
□	4   56322/31/10
⚡	75W INCL.
	2x GU10   max. 75W   230V   Ⓢ
⌵	T 122   ← 305   ↗ 80
MET	

Alma

■	5   56324/30/10
□	6   56324/31/10
⚡	75W INCL.
	4x GU10   max. 75W   230V   Ⓢ
⌵	T 122   ← 243   ↗ 243
MET	



1



4



2



3

Onyx

1 | 56230/48/10

PHILIPS 50W INCL.

1x GU10 | max. 50W | 230V | Ⓢ

Y | T 100 | ↔ 120 | ↗ 120 |



Onyx

2 | 56232/48/10

PHILIPS 50W INCL.

2x GU10 | max. 50W | 230V | Ⓢ

Y | T 100 | ↔ 220 | ↗ 120 |



Onyx

3 | 56233/48/10

PHILIPS 50W INCL.

3x GU10 | max. 50W | 230V | Ⓢ

Y | T 100 | ↔ 325 | ↗ 120 |



Onyx

4 | 56234/48/10

PHILIPS 50W INCL.

4x GU10 | max. 50W | 230V | Ⓢ

Y | T 100 | ↔ 220 | ↗ 220 |





3



4



1  
⏻



2  
⏻



7



8



5



6

Geronimo

- 1 | 55520/30/10
- 2 | 55520/48/10
- ⏻ **PHILIPS 50W INCL.**  
1x GU10 | max. 50W | 230V | Ⓢ
- ⌵ | I 114 | ↔ 114 | ↗ 131 |
- Ⓜ

Geronimo

- 3 | 55522/30/10
- 4 | 55522/48/10
- ⏻ **PHILIPS 50W INCL.**  
2x GU10 | max. 50W | 230V | Ⓢ
- ⌵ | T 131 | ↔ 305 | ↗ 80 |
- Ⓜ

Geronimo

- 5 | 55523/30/10
- 6 | 55523/48/10
- ⏻ **PHILIPS 50W INCL.**  
3x GU10 | max. 50W | 230V | Ⓢ
- ⌵ | T 131 | ↔ 525 | ↗ 80 |
- Ⓜ

Geronimo

- 7 | 55524/30/10
- 8 | 55524/48/10
- ⏻ **PHILIPS 50W INCL.**  
4x GU10 | max. 50W | 230V | Ⓢ
- ⌵ | T 130 | ↔ 243 | ↗ 243 |
- Ⓜ





Lara

1 | 55590/30/10

PHILIPS 50W INCL.

1x GU10 | max. 50W | 230V | Ⓢ

Y | | 110 | ← 110 | ↗ 100 |



Lara

2 | 55592/30/10

PHILIPS 50W INCL.

2x GU10 | max. 50W | 230V | Ⓢ

Y | | T 100 | ← 310 | ↗ 74 |



Lara

3 | 55594/30/10

PHILIPS 50W INCL.

4x GU10 | max. 50W | 230V | Ⓢ

Y | | T 125 | ← 340 | ↗ 340 |



Lara

4 | 55598/30/10

PHILIPS 50W INCL.

4x GU10 | max. 50W | 230V | Ⓢ

Y | | T 163 | ← 697 | ↗ 140 |





Lara

1	55590/67/10
	PHILIPS 50W INCL.
	1x GU10   max. 50W   230V   ⊕
	I 110   ← 110   ↗ 100

Lara

2	55592/67/10
	PHILIPS 50W INCL.
	2x GU10   max. 50W   230V   ⊕
	T 100   ← 310   ↗ 74

Lara

3	55594/67/10
	PHILIPS 50W INCL.
	4x GU10   max. 50W   230V   ⊕
	T 125   ← 340   ↗ 340

Lara

4	55598/67/10
	PHILIPS 50W INCL.
	4x GU10   max. 50W   230V   ⊕
	T 163   ← 697   ↗ 140



Wing

1 | 2510/21/17

PHILIPS 50W INCL.

1x GU10 | max. 50W | 230V | Ⓢ

Y | T 90 | ← 80 | ↗ 80 |



Wing

2 | 2514/25/17

PHILIPS 50W INCL.

5x GU10 | max. 50W | 230V | Ⓢ

Y | T 145 | ← 1160 | ↗ 1160 |



Wing

3 | 2516/22/17

PHILIPS 50W INCL.

2x GU10 | max. 50W | 230V | Ⓢ

Y | T 115 | ← 330 | ↗ 100 |



Wing

4 | 2518/24/17

PHILIPS 50W INCL.

4x GU10 | max. 50W | 230V | Ⓢ

Y | T 135 | ← 340 | ↗ 300 |



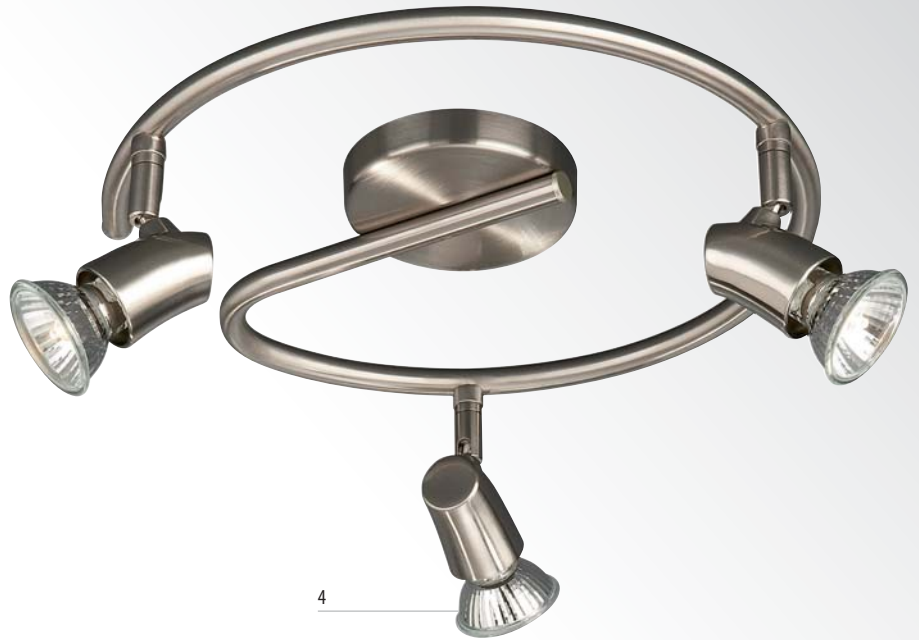

Kinja

■	1   54490/17/10
☏	PHILIPS 50W INCL.
	1x GU10   max. 50W   230V   Ⓢ
Y	180   ← 80   ↗ 109
	MET

Kinja

■	2   54492/17/10
☏	PHILIPS 50W INCL.
	2x GU10   max. 50W   230V   Ⓢ
Y	T 125   ← 332   ↗ 99
	MET

Kinja

■	3   54494/17/10
☏	PHILIPS 50W INCL.
	4x GU10   max. 50W   230V   Ⓢ
Y	T 125   ← 557   ↗ 98
	MET

Kinja

■	4   54499/17/10
☏	PHILIPS 50W INCL.
	3x GU10   max. 50W   230V   Ⓢ
Y	T 125   ← 316   ↗ 316
	MET



3



2



4

Fortuna

■	1   55210/70/10
☏	PHILIPS 50W INCL.
	1x GU10   max. 50W   230V   Ⓢ
↗	190   ↔ 90   ↘ 100
☑	MET ↑

Fortuna

■	2   55212/70/10
☏	PHILIPS 50W INCL.
	2x GU10   max. 50W   230V   Ⓢ
↕	100   ↔ 150   ↘ 150
☑	MET ↑

Fortuna

■	3   55213/70/10
☏	PHILIPS 50W INCL.
	3x GU10   max. 50W   230V   Ⓢ
↕	100   ↔ 400   ↘ 110
☑	MET ↑

Fortuna

■	4   55214/70/10
☏	PHILIPS 50W INCL.
	4x GU10   max. 50W   230V   Ⓢ
↕	100   ↔ 210   ↘ 210
☑	MET ↑

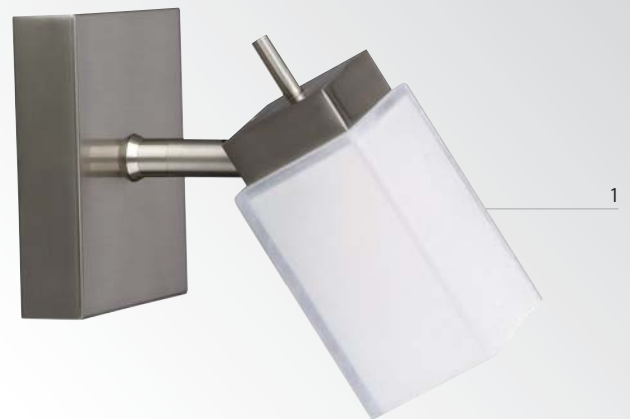

Mirati

1 | 54270/17/10

 **PHILIPS 40W INCL.**

1x G9 | max. 40W | 230V | 

 | 180 | ← 80 | ↗ 94 |



Mirati

2 | 54272/17/10

 **PHILIPS 40W INCL.**

2x G9 | max. 40W | 230V | 

 | T 106 | ← 330 | ↗ 109 |



Mirati

3 | 54274/17/10

 **PHILIPS 40W INCL.**

4x G9 | max. 40W | 230V | 

 | T 106 | ← 805 | ↗ 109 |







1

## Pera

 1 | 54380/31/10

 **PHILIPS 40W INCL.**

1x G9 | max. 40W | 230V | 

 | 180 |  80 |  82 |







Pera

<input type="checkbox"/>	1   54382/31/10
	<b>PHILIPS 40W INCL.</b> 2x G9   max. 40W   230V   Ⓢ
	T 85   ← 110   ↗ 110

Pera

<input type="checkbox"/>	2   54384/31/10
	<b>PHILIPS 40W INCL.</b> 4x G9   max. 40W   230V   Ⓢ
	T 93   ← 810   ↗ 100

Pera

<input type="checkbox"/>	3   54389/31/10
	<b>PHILIPS 40W INCL.</b> 3x G9   max. 40W   230V   Ⓢ
	T 93   ← 300   ↗ 300



1  
⏻

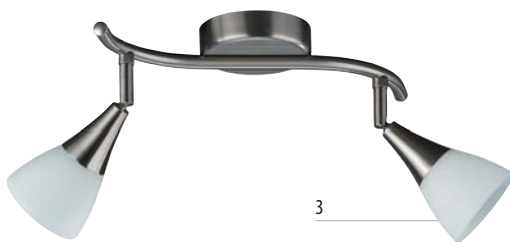

3



4



2  
⏻



5  
⏻

Aura

■	1   52030/17/10
	1x E14   max. 40W   230V   Ⓢ
Y	180   ↔ 80   ↗ 90
	MET

Aura

■	2   52031/17/10
	1x E14   max. 25W   230V   Ⓢ
Y	1280   ↔ 82   ↗ 320
	MET

Aura

■	3   52032/17/10
	2x E14   max. 40W   230V   Ⓢ
Y	T 117   ↔ 335   ↗ 95
	MET

Aura

■	4   52033/17/10
	3x E14   max. 40W   230V   Ⓢ
Y	T 117   ↔ 680   ↗ 95
	MET

Aura

■	5   52038/17/10
	4x E14   max. 40W   230V   Ⓢ
Y	T 117   ↔ 1320   ↗ 110
	MET



**Cosmos**

■	1   52060/17/10
	1x E14   max. 40W   230V   ⊕
Y	190   ↔ 120   ↘ 90
	MET

**Cosmos**

■	2   52061/17/10
	1x E14   max. 25W   230V   ⊕
Y	190   ↔ 90   ↘ 420
	MET

**Cosmos**

■	3   52062/17/10
	2x E14   max. 40W   230V   ⊕
Y	T 110   ↔ 260   ↘ 110
	MET

**Cosmos**

■	4   52064/17/10
	4x E14   max. 40W   230V   ⊕
Y	T 120   ↔ 260   ↘ 260
	MET



Vega

□ 1 | 55640/31/10

☏ PHILIPS 50W INCL.

1x GU10 | max. 50W | 230V | ⊕

Y | 180 | ↔ 80 | ↗ 102 |



Доступно начиная с июля 2011

Vega

□ 2 | 55643/31/10

☏ PHILIPS 50W INCL.

3x GU10 | max. 50W | 230V | ⊕

Y | T 103 | ↔ 194 | ↗ 194 |



Доступно начиная с июля 2011



Vega

<input type="checkbox"/>	1   55642/31/10
	<b>PHILIPS 50W INCL.</b> 2x GU10   max. 50W   230V   ⊕
	T 119   → 330   ↗ 98
	Доступно начиная с июля 2011

Vega

<input type="checkbox"/>	2   55644/31/10
	<b>PHILIPS 50W INCL.</b> 4x GU10   max. 50W   230V   ⊕
	T 134   → 845   ↗ 110
	Доступно начиная с июля 2011

 **ЭКОНОМЯТ**  
энергию





### Mimosa

1 | 55661/31/10

2 | 55661/48/10

 **PHILIPS 10W INCL.**

1x GU10 | max. 10W | 230V | 

 | 1 281 | ↔ 90 | ↗ 274 |

MET  SYN

Доступно начиная с июля 2011



Экономят  
энергию 





### Timo

■ 1 | 51201/30/10

■ 2 | 51201/87/10

1x E14 | max. 12W | 230V | 

 | 1 155 |  107 |  175 |





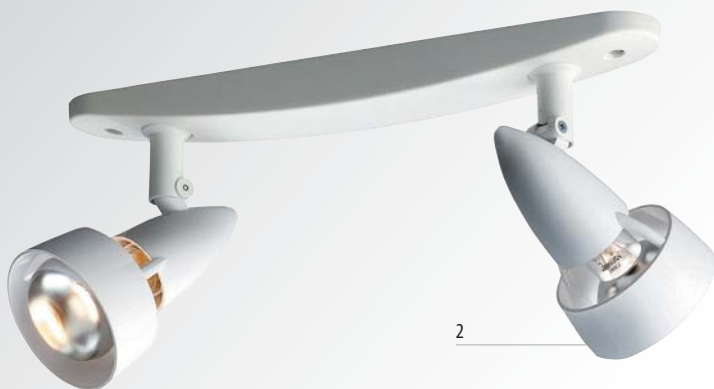

Vesta

<input type="checkbox"/>	1   4150/61/31
	1x E14   max. 40W   230V   ☐
	T 110   ↔ 85   ↗ 85

Vesta

<input type="checkbox"/>	2   4150/62/31
	2x E14   max. 40W   230V   ☐
	T 100   ↔ 290   ↗ 70

Vesta

<input type="checkbox"/>	3   4155/63/31
	3x E14   max. 40W   230V   ☐
	T 100   ↔ 195   ↗ 195

Vesta

<input type="checkbox"/>	4   4157/64/31
	4x E14   max. 40W   230V   ☐
	T 130   ↔ 880   ↗ 110



Lares

<input type="checkbox"/>	1   2793/63/31
	3x E27   max. 60W   230V   ☐
	T 135   ← 265   ↗ 265
	<input type="checkbox"/> MET <input type="checkbox"/> SYN

Lares

<input type="checkbox"/>	2   4920/61/31
	1x E27   max. 60W   230V   ☐
	T 145   ← 85   ↗ 85
	<input type="checkbox"/> MET <input type="checkbox"/> SYN

Lares

<input type="checkbox"/>	3   4922/61/31
	1x E27   max. 60W   230V   ☐
	T 160   ← 80   ↗ 145
	<input type="checkbox"/> MET <input type="checkbox"/> SYN

Lares

<input type="checkbox"/>	4   4924/62/31
	2x E27   max. 60W   230V   ☐
	T 130   ← 386   ↗ 78
	<input type="checkbox"/> MET <input type="checkbox"/> SYN



## Kajam

1 | 52242/43/10

7W INCL.

2x E14 | max. 7W | 230V | ⊕

Y | 1176 | ← 280 | ↗ 101 |

MET

Доступно начиная с июля 2011



Экономят  
энергию



### Кажам

1 | 52240/43/10

7W INCL.

1x E14 | max. 7W | 230V | ⊕

Y | | T 110 | ↔ 110 | ↗ 80 |



Доступно начиная с июля 2011

### Кажам

2 | 52244/43/10

7W INCL.

4x E14 | max. 7W | 230V | ⊕

Y | | T 101 | ↔ 803 | ↗ 173 |



Доступно начиная с июля 2011

### Кажам

3 | 52249/43/10

7W INCL.

3x E14 | max. 7W | 230V | ⊕

Y | | T 100 | ↔ 300 | ↗ 300 |



Доступно начиная с июля 2011

Экономят  
энергию



Светильники акцентного освещения

246

### Altari

1 | 52140/43/10

9W INCL.

1x E14 | max. 9W | 230V | Ⓢ

Y | | 191 | ↔ 91 | ↗ 105 |



### Altari

2 | 52143/43/10

9W INCL.

3x E14 | max. 9W | 230V | Ⓢ

Y | | 198 | ↔ 395 | ↗ 120 |



### Altari

3 | 52144/43/10

9W INCL.

4x E14 | max. 9W | 230V | Ⓢ

Y | | 230 | ↔ 596 | ↗ 216 |





**Aura**

	1   52030/06/10
	1x E14   max. 40W   230V
	↓ 80   ↔ 80   ↗ 90

**Aura**

	2   52031/06/10
	1x E14   max. 25W   230V
	↓ 280   ↔ 82   ↗ 320

**Aura**

	3   52032/06/10
	2x E14   max. 40W   230V
	T 117   ↔ 335   ↗ 95

**Aura**

	4   52033/06/10
	3x E14   max. 40W   230V
	T 117   ↔ 680   ↗ 95

**Aura**

	5   52038/06/10
	4x E14   max. 40W   230V
	T 117   ↔ 1320   ↗ 110









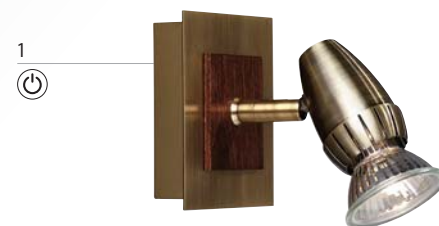

Светильники акцентного освещения







248









Fortuna

	1   55210/74/10
	PHILIPS 50W INCL.
	1x GU10   max. 50W   230V   
	1 90   ↔ 90   ↗ 100
	







Fortuna

	2   55212/74/10
	PHILIPS 50W INCL.
	2x GU10   max. 50W   230V   
	⊥ 100   ↔ 150   ↗ 150
	

Fortuna

	3   55213/74/10
	PHILIPS 50W INCL.
	3x GU10   max. 50W   230V   
	⊥ 100   ↔ 400   ↗ 110
	





Fortuna

	4   55214/74/10
	PHILIPS 50W INCL.
	4x GU10   max. 50W   230V   
	⊥ 100   ↔ 210   ↗ 210
	













Lipo

	1   55610/05/10
	PHILIPS 50W INCL.
	1x GU10   max. 50W   230V   ⊕
	190   ↔ 80   ↗ 110
	





Lipo

	2   55612/05/10
	PHILIPS 50W INCL.
	2x GU10   max. 50W   230V   ⊕
	T 110   ↔ 150   ↗ 150
	

Lipo

	3   55614/05/10
	PHILIPS 50W INCL.
	4x GU10   max. 50W   230V   ⊕
	T 131   ↔ 845   ↗ 150
	

Lipo

	4   55618/05/10
	PHILIPS 50W INCL.
	4x GU10   max. 50W   230V   ⊕
	T 110   ↔ 210   ↗ 210
	



1

Світлодіодні лампи

Світильник

## Petrol

1 | 52134/43/10

7W INCL.

4x E14 | max. 8W | 230V |  $\ominus$

Y | T 204 |  $\leftrightarrow$  894 |  $\swarrow$  98 |

MET



Экономят  
энергию



**Petrol**

1 | 52130/43/10



7W INCL.

1x E14 | max. 8W | 230V | Ⓢ



| 197 | ← 97 | ↗ 139 |



**Petrol**

2 | 52132/43/10



7W INCL.

2x E14 | max. 8W | 230V | Ⓢ



| T 209 | ← 395 | ↗ 97 |





1

Светильники акцентного освещения

252

## Chimo

1 | 55494/93/10

 PHILIPS 40W INCL.

4x G9 | max. 40W | 230V | Ⓢ

 | T 102 | ↔ 804 | ↗ 120 |

MET SYN



Chimo

1 | 55490/29/10

2 | 55490/93/10

 **PHILIPS 40W INCL.**  
1x G9 | max. 40W | 230V | Ⓢ

 | T 88 | ← 88 | ↘ 87 |

MET SYN

Chimo

3 | 55492/29/10

4 | 55492/93/10

 **PHILIPS 40W INCL.**  
2x G9 | max. 40W | 230V | Ⓢ

 | T 88 | ← 203 | ↘ 88 |

MET SYN

Chimo

5 | 55494/29/10

 **PHILIPS 40W INCL.**  
4x G9 | max. 40W | 230V | Ⓢ

 | T 102 | ← 804 | ↘ 120 |

MET SYN



1



2



3



4



Nori

1 | 55955/86/10

PHILIPS 40W INCL.

1x G9 | max. 40W | 230V | Ⓢ

Y | | T 150 | ← 140 | ↘ 135 |



Nori

2 | 55957/86/10

PHILIPS 40W INCL.

2x G9 | max. 40W | 230V | Ⓢ

Y | | T 155 | ← 330 | ↘ 130 |



Nori

3 | 55958/86/10

PHILIPS 40W INCL.

4x G9 | max. 40W | 230V | Ⓢ

Y | | T 155 | ← 815 | ↘ 130 |



Nori

4 | 55959/86/10

PHILIPS 40W INCL.

4x G9 | max. 40W | 230V | Ⓢ

Y | | T 155 | ← 350 | ↘ 330 |





Meriana

1   51160/43/10
1x E14   max. 40W   230V
1   103   ← 103   ↗ 119

Meriana

2   51162/43/10
2x E14   max. 40W   230V
T 123   ← 305   ↗ 122

Meriana

3   51164/43/10
4x E14   max. 40W   230V
T 123   ← 804   ↗ 122

Meriana

4   51169/43/10
3x E14   max. 40W   230V
T 123   ← 300   ↗ 300





# Концепции для интерьера

---

**TOPSELECTION**  
premium lighting



**TOPSELECTION**  
premium lighting



# Top Selection

## Только лучшее в свете

*Top Selection – это эксклюзивная, высококачественная коллекция светильников Massive, отличающаяся элегантностью и никогда не выходящим из моды дизайном по разумной цене. Все светильники этой серии сочетают в себе тепло декоративного освещения и прямоту модерна, современность и индивидуальность. Отделка светильников Top Selection полностью соответствует самым высоким стандартам, а лампы, входящие в комплект, являются гарантом высокого качества света.*

### Всегда актуальный дизайн и премиальное качество

Top Selection предлагает Вашему вниманию большое количество разнообразных по дизайну светильников. Что бы Вы ни искали: современный привлекательный светильник для акцентного освещения, классический настенный светильник или стильный потолочный светильник – Вы обязательно найдете то, что Вам понравится в коллекции Top Selection. Это самая передовая коллекция благодаря современному дизайну и использованию самых современных технологий в освещении: энергосберегающей и светодиодной.

В коллекции Top Selection мы предлагаем только продукты класса премиум и гордимся своими высокими стандартами - это отличная отделка, материалы самого высокого качества и соответствие жестким Европейским требованиям качества, что подтверждает значок "ENEC" (Степень воздействия электромагнитного излучения) на упаковке. Вот почему продукция Top Selection будет служить Вам долгие годы! К тому же все светильники коллекции Top Selection поставляются с лампами Philips в комплекте, что является гарантией высокого качества и энергоэффективности, а также высокой световой отдачи.

Также не менее важно, что коллекция Top Selection дружелюбна пользователю: продуманный дизайн и руководство пользователя, содержащее простые и понятные инструкции для легкой сборки и установки Вашего светильника Top Selection.

POWERLED

TOPSELECTION  
premium lighting

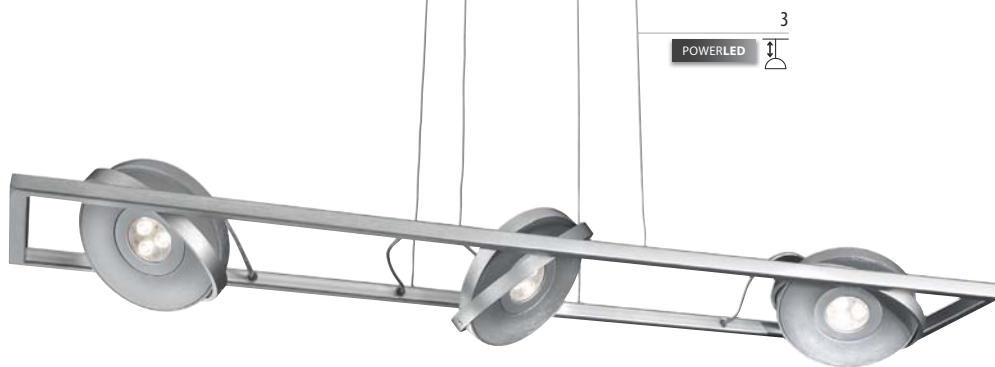

 ЭКОНОМЯТ  
энергию

Vision

1 | 53150/48/10

LED PHILIPS 7,5W INCL. | PowerLED

1x LED | max. 7,5W |  $\frac{230V}{240V}$ -SELV |  $\ominus$

 |  $\uparrow$  115 |  $\leftrightarrow$  150 |  $\searrow$  125 |

ALU

Vision

2 | 53152/48/10

LED PHILIPS 7,5W INCL. | PowerLED

2x LED | max. 7,5W |  $\frac{230V}{240V}$ -SELV |  $\ominus$

 |  $\uparrow$  115 |  $\leftrightarrow$  289 |  $\searrow$  125 |

ALU

Vision

3 | 53159/48/10

LED PHILIPS 7,5W INCL. | PowerLED

3x LED | max. 7,5W |  $\frac{230V}{240V}$ -SELV |  $\ominus$

 |  $\uparrow$  1500 |  $\leftrightarrow$  747 |  $\searrow$  171 |

ALU





Экономят  
энергию



## Vision

1 | 53154/48/10

LED PHILIPS 7,5W INCL. | PowerLED

4x LED | max. 7,5W | SELV |

| T 115 | ← 567 | ↘ 125 |

ALU

POWERLED

TOPSELECTION  
premium lighting



 ЭКОНОМЯТ  
энергию

Hyves

 1 | 53140/48/10

LED PHILIPS 7,5W INCL. | PowerLED

1x LED | max. 7,5W |  SELV | 

 | 1 118 | ↔ 201 | ↙ 112 |

ALU

Hyves

 2 | 53142/48/10

LED PHILIPS 7,5W INCL. | PowerLED

2x LED | max. 7,5W |  SELV | 

 | T 111 | ↔ 304 | ↙ 118 |

ALU



Экономят  
энергию



## Hyves

1 | 53143/48/10

LED PHILIPS 7,5W INCL. | PowerLED

3x LED | max. 7,5W |  $\frac{230V}{SELV}$  |  $\oplus$

Y | T 111 |  $\leftrightarrow$  527 |  $\swarrow$  118 |

ALU

POWERLED

TOPSELECTION  
premium lighting

1

POWERLED



2

POWERLED



 **ЭКОНОМЯТ**  
энергию

**Pauline**

1 | 32157/31/10

LED PHILIPS 2,5W INCL. | PowerLED

9x LED | max. 2,5W |  $\frac{230V}{230V}$ -SELV |  $\oplus$

 | T 36 |  $\leftrightarrow$  230 |  $\swarrow$  230 |

ALU SYN

**Louise**

2 | 32158/31/10

LED PHILIPS 2,5W INCL. | PowerLED

6x LED | max. 2,5W |  $\frac{230V}{230V}$ -SELV |  $\oplus$

 | T 47 |  $\leftrightarrow$  240 |  $\swarrow$  240 |

ALU 



1  
POWERLED 

| Top Selection

267

Экономят  
энергию





## Louise

1 | 33258/31/10

LED PHILIPS 2,5W INCL. | PowerLED

3x LED | max. 2,5W |  SELV | 

 | 1 138 |  157 |  157 |



POWERLED

TOPSELECTION  
premium lighting

1

POWERLED



2

POWERLED



 **ЭКОНОМЯТ**  
энергию

### Pauline

1 | 33257/31/10

2 | 33257/48/10

LED PHILIPS 2,5W INCL. | PowerLED

2x LED | max. 2,5W |  $\text{SELV}$  |  $\text{E}$

 | 128 |  $\leftrightarrow$  148 |  $\swarrow$  94 |



POWERLED



| Top Selection

269

Экономят  
энергию 

Leah

1 | 32159/31/10

2 | 32159/48/10

LED PHILIPS 7,5W INCL. | PowerLED

1x LED | max. 7,5W |  SELV | 

 | T 57 | ↔ 158 | ↗ 158 |



Leah

3 | 33259/31/10

4 | 33259/48/10

LED PHILIPS 2,5W INCL. | PowerLED

2x LED | max. 2,5W |  SELV | 

 | ↓ 146 | ↔ 50 | ↗ 115 |







Bloc

1 | 53130/48/10

PHILIPS Ecohalo 35W INCL.

1x GU10 | max. 35W | 230V | Ⓢ

| T 120 | ↔ 70 | ↙ 70 |

ALU MET

Bloc

2 | 53132/48/10

PHILIPS Ecohalo 35W INCL.

2x GU10 | max. 35W | 230V | Ⓢ

| T 120 | ↔ 160 | ↙ 70 |

ALU MET

Bloc

3 | 53134/48/10

PHILIPS Ecohalo 35W INCL.

4x GU10 | max. 35W | 230V | Ⓢ

| T 120 | ↔ 520 | ↙ 70 |

ALU MET



Magnus

■	1   53030/48/10
⚡	PHILIPS 75W INCL.
	1x GU10   max. 75W   230V   ⊕
⚡	I 90   ↔ 110   ↙ 110
ALU	MET

Magnus

■	2   53033/48/10
⚡	PHILIPS 75W INCL.
	3x GU10   max. 75W   230V   ⊕
⚡	T 112   ↔ 480   ↙ 90
ALU	MET

Magnus

■	3   53034/48/10
⚡	PHILIPS 75W INCL.
	4x GU10   max. 75W   230V   ⊕
⚡	T 112   ↔ 240   ↙ 240
ALU	MET

Magnus

■	4   53038/48/10
⚡	PHILIPS 75W INCL.
	4x GU10   max. 75W   230V   ⊕
⚡	T 199   ↔ 1153   ↙ 90
ALU	MET

Экономят  
энергию

TOPSELECTION  
premium lighting



Futura

1 | 53060/48/10

PHILIPS Ecohalo 42W INCL.  
1x G9 | max. 60W | 230V | Ⓢ

| T 190 | ↔ 162 | ↙ 97 |

ALU MET

Futura

2 | 53063/48/10

PHILIPS Ecohalo 42W INCL.  
3x G9 | max. 60W | 230V | Ⓢ

| T 183 | ↔ 466 | ↙ 126 |

ALU MET

Futura

3 | 53064/48/10

PHILIPS Ecohalo 42W INCL.  
4x G9 | max. 60W | 230V | Ⓢ

| T 183 | ↔ 618 | ↙ 126 |

ALU MET

Futura

4 | 53069/48/10

PHILIPS Ecohalo 42W INCL.  
3x G9 | max. 60W | 230V | Ⓢ

| T 1500 | ↔ 760 | ↙ 194 |

ALU MET



## Futura

1 | 53062/48/10

 **PHILIPS Ecohalo 42W INCL.**  
2x G9 | max. 60W | 230V | 

 | T 343 | ← 162 | ↗ 126 |

ALU MET

Экономят  
энергию

TOPSELECTION  
premium lighting

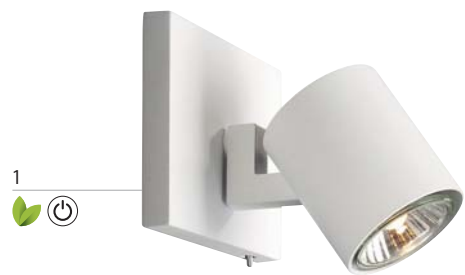

Hiro

1 | 53090/31/10

PHILIPS Ecohalo 35W INCL.

1x GU10 | max. 50W | 230V | Ⓢ

Y | | 190 | ↔ 110 | ↗ 107 |

ALU MET

Hiro

2 | 53093/31/10

PHILIPS Ecohalo 35W INCL.

3x GU10 | max. 50W | 230V | Ⓢ

Y | | T 109 | ↔ 480 | ↗ 90 |

ALU MET

Hiro

3 | 53094/31/10

PHILIPS Ecohalo 35W INCL.

4x GU10 | max. 50W | 230V | Ⓢ

Y | | T 109 | ↔ 240 | ↗ 240 |

ALU MET





## Hiro

□ 1 | 53092/31/10

⚡ **PHILIPS** Ecohalo 35W INCL.

2x GU10 | max. 50W | 230V | Ⓢ

⚡ | 190 | ← 305 | ↘ 109 |

ALU MET

Экономят  
энергию

TOPSELECTION  
premium lighting



Len

■	1   53120/11/10
⊙	PHILIPS 9W INCL.
	1x GX53   max. 9W   230V   ⊕
Y	110   ↔ 110   ↗ 93
	MET

Len

■	2   53122/11/10
⊙	PHILIPS 9W INCL.
	2x GX53   max. 9W   230V   ⊕
Y	T 95   ↔ 257   ↗ 112
	MET

Len

■	3   53124/11/10
⊙	PHILIPS 9W INCL.
	4x GX53   max. 9W   230V   ⊕
Y	T 95   ↔ 254   ↗ 254
	MET

















Экономят энергию 









**Cronus**

	1   53080/11/10
	PHILIPS Ecohalo 35W INCL.
	1x GU10   max. 50W   230V   
	I 90   ← 140   ↗ 150
	







**Cronus**

	2   53082/11/10
	PHILIPS Ecohalo 35W INCL.
	2x GU10   max. 50W   230V   
	T 150   ← 350   ↗ 90
	

**Cronus**

	3   53083/11/10
	PHILIPS Ecohalo 35W INCL.
	3x GU10   max. 50W   230V   
	T 150   ← 560   ↗ 90
	

**Cronus**

	4   53084/11/10
	PHILIPS Ecohalo 35W INCL.
	4x GU10   max. 50W   230V   
	T 150   ← 770   ↗ 90
	



Dorothy

1 | 32115/17/10

PHILIPS Ecohalo 42W INCL.

1x G9 | max. 60W | 230V | Ⓢ

Y | T 53 | ↔ 237 | ↗ 237 |



Dorothy

2 | 32116/17/10

PHILIPS Ecohalo 70W INCL.

1x R7S 78 | max. 100W | 230V | Ⓢ

Y | T 68 | ↔ 370 | ↗ 370 |



Adria

3 | 32129/17/10

PHILIPS Ecohalo 23W INCL.

2x E27 | max. 23W | 230V | Ⓢ

Y | T 91 | ↔ 320 | ↗ 320 |





## Adria

1 | 32130/17/10

 **PHILIPS Ecohalo 23W INCL.**

3x E27 | max. 23W | 230V | 

 | T 91 | ← 420 | ↗ 420 |







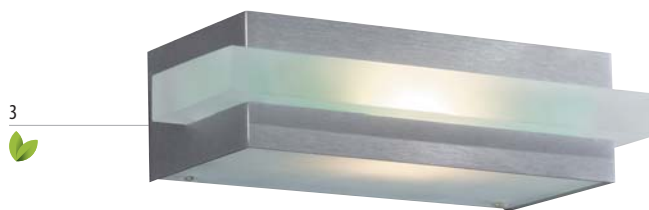

Экономят  
энергию







TOPSELECTION  
premium lighting









Eden

	1   34103/48/10
	<b>PHILIPS 12W INCL.</b> 2x E14   max. 12W   230V   
	↑ 120   ↔ 500   ↙ 72
	

Eden

	2   34104/48/10
	<b>PHILIPS 12W INCL.</b> 1x E14   max. 12W   230V   
	↑ 120   ↔ 300   ↙ 72
	

Anika

	3   34124/48/10
	<b>PHILIPS Ecohalo 70W INCL.</b> 1x R7S 78   max. 100W   230V   
	↑ 60   ↔ 222   ↙ 105
	





1

## Estelle

1 | 32146/48/10

 **PHILIPS 23W INCL.**

2x E27 | max. 23W | 230V | 

 | T 86 | ← 400 | ↗ 400 |



1



2



Tara

1 | 33218/48/10

PHILIPS 10W INCL.

1x GU10 | max. 10W | 230V | Ⓢ

Y | | 105 | ← 75 | ↗ 100 |

ALU MET

Tara

2 | 33219/48/10

PHILIPS 10W INCL.

2x GU10 | max. 10W | 230V | Ⓢ

Y | | 105 | ← 180 | ↗ 100 |

ALU MET

2





1





| Top Selection

283

### Tara

<input type="checkbox"/>	1   33218/31/10
	<b>PHILIPS 10W INCL.</b>
	1x GU10   max. 10W   230V   Ⓢ
	1105   ↔ 75   ↙ 100
	<input type="checkbox"/> ALU <input type="checkbox"/> MET

### Tara

<input type="checkbox"/>	2   33219/31/10
	<b>PHILIPS 10W INCL.</b>
	2x GU10   max. 10W   230V   Ⓢ
	1105   ↔ 180   ↙ 100
	<input type="checkbox"/> ALU <input type="checkbox"/> MET



ЭКОНОМЯТ  
энергию

TOPSELECTION  
premium lighting

1



2



### Winona

1 | 30205/11/10

PHILIPS 40W INCL.

1x 2GX13 | max. 40W | 230V | Ⓢ

Y | T 101 | ↔ 441 | ↗ 441



### Eve

2 | 32145/48/10

PHILIPS 60W INCL.

1x 2GX13 | max. 60W | 230V | Ⓢ

Y | T 92 | ↔ 438 | ↗ 438





Экономят энергию 

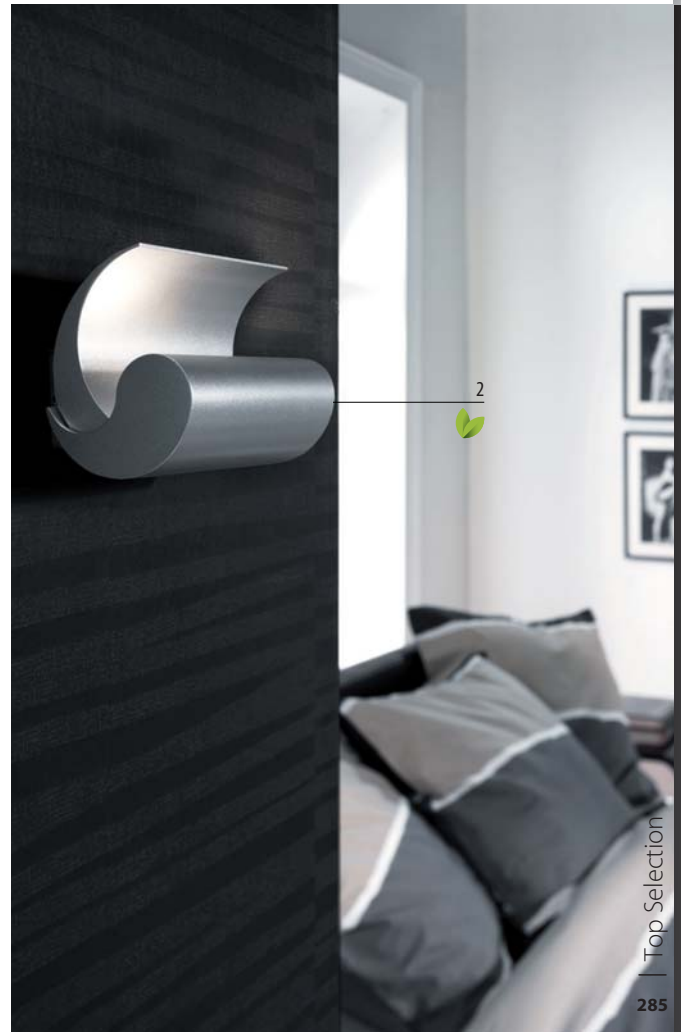

Zita

1 | 33211/31/10

2 | 33211/48/10

 **PHILIPS Ecohalo 70W INCL.**  
1x R7S 78 | max. 100W | 230V |  $\oplus$

 | 115 | 159 | 100 |

1 



TOPSELECTION  
premium lighting

2 



Catherine

 1 | 34101/17/10

 **PHILIPS Ecohalo 70W INCL.**

1x R7S 78 | max. 100W | 230V | 

 | ↑ 120 | ↔ 355 | ↘ 107 |



Monica

 2 | 34111/17/10

 **PHILIPS 40W INCL.**

1x G9 | max. 40W | 230V | 

 | ↑ 170 | ↔ 140 | ↘ 124 |



1  



Top Selection

287

## Iris

 1 | 32149/48/10

**LED 3W INCL.** | 16-LED

2x LED | max. 3W |  $\approx 3,2V$  |  $\oplus$

 **PHILIPS 32W INCL.**

1x G10Q | max. 32W | 230V |

 | T 92 |  $\leftrightarrow$  500 |  $\nearrow$  500 |



AQUA

Bathroom Lighting



# AQUA

Bathroom Lighting





# Aqua

## Купайтесь в свете

Хорошее освещение – обязательное условие в ванной комнате, месте, где Вам одновременно необходим яркий свет, чтобы накраситься или побриться, и мягкий теплый свет, для приятного пробуждения с утра или принятия ванны перед сном.

Светильники из серии Aqua полностью удовлетворяют эту необходимость. Серия Aqua – это широкий выбор готовых к установке светильников, разработанных специально для ванных комнат. Они дают мгновенный чистый и яркий свет там, где он Вам больше всего необходим, создавая спокойную и расслабленную атмосферу вокруг. К тому же эти светильники обладают безопасной конструкцией и долгим сроком службы в атмосфере повышенной влажности и их легко устанавливать и убирать.

### Ваша безопасность превыше всего





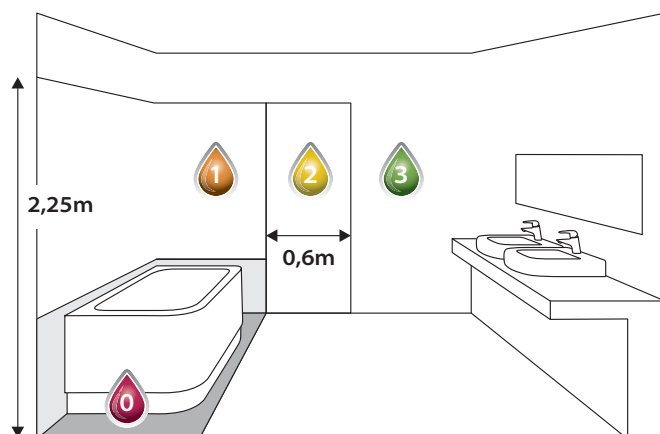

Выбирая освещение для ванных комнат, обратите особое внимание на безопасность светильника. Светильники серии Aqua соответствуют даже самым строгим Европейским стандартам и нормам в области освещения для ванных комнат. Также светильники обладают разным уровнем IP (Ingress Protection), что позволяет размещать светильники в разных частях ванных комнат. IP - это официальная классификация ламп, предназначенных для использования в ванных комнатах, по степени защиты от влаги.

Каждый светильник серии Aqua можно легко и быстро установить, так как они требуют минимальной сборки и идут со всем необходимым в комплекте, а многие сразу содержат лампу. К тому же на упаковке и в руководстве пользователя Вы найдете понятные пошаговые инструкции для установки светильника и информацию о возможности его размещения в соответствии с Европейскими стандартами.

Что бы Вы ни искали: настенные, потолочные, монтируемые или встраиваемые светильники для акцентного освещения, с серией Aqua Вы всегда найдете то, что ищете.



### классификация по IP

-   
-  IP65
-  IP65, IP44
-  IP65, IP44, IP43, IP21, IP20

1  



 **ЭКОНОМЯТ**  
энергию

**AQUA**  
Bathroom Lighting





2 

**Naida**

 1 | 34136/11/10

 **PHILIPS 23W INCL.**

2x E27 | max. 23W | 230V | 

 | 1120 | ↔ 630 | ↗ 91 |

IP44

Доступно начиная с июля 2011

**Naida**

 2 | 34138/11/10

 **PHILIPS 23W INCL.**

2x E27 | max. 23W | 230V |

 | 91 | ↔ 400 | ↗ 400 |

IP44

Доступно начиная с июля 2011



## Naida

1 | 34137/11/10

 **PHILIPS 20W INCL.**  
1x E27 | max. 20W | 230V |

 | 120 | 326 | 91 |

MET SYN

IP44

Доступно начиная с июля 2011

AQUA  
Bathroom Lighting



Ocean

■	1   34015/17/10
💡	<b>PHILIPS 40W INCL.</b> 1x G9   max. 40W   230V   ⊕
Y	175   ← 80   ↗ 110
⊠	MET
	IP21

Ocean

■	2   34016/17/10
💡	<b>PHILIPS 40W INCL.</b> 2x G9   max. 40W   230V   ⊕
Y	175   ← 420   ↗ 110
⊠	MET
	IP21

Oasis





■	3   34131/11/10
⊙	<b>PHILIPS 9W INCL.</b> 1x GX53   max. 9W   230V   ⊕
Y	51   ← 183   ↗ 146
⊠	MET SYN
	IP44

Oasis





■	4   34312/11/10
⊙	<b>PHILIPS 9W INCL.</b> 2x GX53   max. 9W   230V   ⊕
Y	51   ← 370   ↗ 146
⊠	MET SYN
	IP44







**Ice**

	1   32015/11/10
	3x E14   max. 40W   230V   ⊕
	T 140   ↔ 285   ↗ 285
	
	IP21





**Ice**

	2   34020/11/10
	1x E14   max. 40W   230V   ⊕
	I 165   ↔ 80   ↗ 100
	
	IP21

**Ice**

	3   34021/11/10
	2x E14   max. 40W   230V   ⊕
	I 165   ↔ 420   ↗ 100
	
	IP21





**Ice**

	4   34022/11/10
	3x E14   max. 40W   230V   ⊕
	I 165   ↔ 585   ↗ 100
	
	IP21





AQUA  
Bathroom Lighting



Glacier

	1   34081/11/10
	<b>PHILIPS 40W INCL.</b> 1x G9   max. 40W   230V   $\oplus$
	135   $\leftrightarrow$ 165   $\nearrow$ 127
	
IP21	

Glacier

	2   34082/11/10
	<b>PHILIPS 40W INCL.</b> 2x G9   max. 40W   230V   $\oplus$
	135   $\leftrightarrow$ 370   $\nearrow$ 127
	
IP21	



## Glacier

1 | 34083/11/10

 **PHILIPS 40W INCL.**

3x G9 | max. 40W | 230V | 

 | 135 | 650 | 127 |

IP21



AQUA  
Bathroom Lighting



Source

■	1   34030/17/10
	1x E14   max. 40W   230V   Ⓢ
Y	1215   ↔ 80   ↗ 100
	MET
	IP21

Aquatic

■	2   34084/11/10
	PHILIPS 40W INCL. 1x G9   max. 40W   230V   Ⓢ
Y	1249   ↔ 60   ↗ 70
	MET
	IP44

Crystal

■	3   34086/11/10
	PHILIPS 40W INCL. 1x G9   max. 40W   230V   Ⓢ
Y	1175   ↔ 100   ↗ 185
	MET
	IP44

Breeze

■	4   34096/11/10
	PHILIPS 25W INCL. 2x G9   max. 25W   230V   Ⓢ
Y	1310   ↔ 65   ↗ 103
	MET
	IP44



## Nile

1 | 34006/11/10

2x E14 | max. 40W | 230V | Ⓢ

Y | 180 | ↔ 310 | ↗ 105 |



IP44

massive

Экономят  
энергию

AQUA  
Bathroom Lighting

Aqua  
300



### Tide

1 | 34095/06/10

2 | 34095/11/10

9W INCL.  
1x E14 | max. 9W | 230V | ⊕

| 1265 | ← 142 | ↗ 171 |

MET SYN

IP44



Aqua  
301

## Calder

1 | 34110/11/10

 **PHILIPS 12W INCL.**

1x E14 | max. 12W | 230V | ⊕

 | 273 | ← 140 | ↗ 173 |

MET SYN

IP44

Доступно начиная с июля 2011



Экономят энергию

AQUA  
Bathroom Lighting

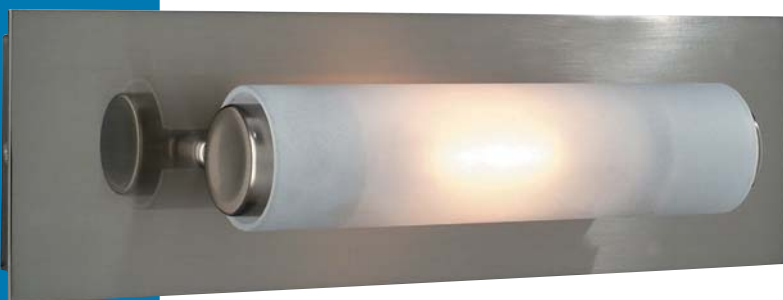

Amazone

1 | 34012/17/10

**PHILIPS Ecohalo 70W INCL.**  
1x R7S 78 | max. 100W | 230V | ⊕

| 1 90 | ↔ 300 | ↗ 90 |



IP21

Lagoon

2 | 34092/17/10

**PHILIPS Ecohalo 70W INCL.**  
1x R7S 78 | max. 100W | 230V | ⊕

| 1 128 | ↔ 190 | ↗ 138 |



IP21

Seaboard

3 | 34093/11/10

**PHILIPS 8W INCL.**  
1x G5 | max. 8W | 230V | ⊞

| 1 60 | ↔ 388 | ↗ 77 |



IP44

Seaboard

4 | 34094/11/10

**PHILIPS 13W INCL.**  
1x G5 | max. 13W | 230V | ⊞

| 1 60 | ↔ 616 | ↗ 77 |



IP44



Victoria

1 | 34008/11/10

2x E14 | max. 40W | 230V | Ⓟ

Y | | 185 | ↔ 305 | ↘ 70 |



IP21

Victoria

2 | 34009/11/10

3x E14 | max. 40W | 230V | Ⓟ

Y | | 185 | ↔ 405 | ↘ 70 |



IP21

Neptunus

3 | 34070/11/10

PHILIPS 13W INCL.

1x G5 | max. 13W | 230V | Ⓟ

Y | | 172 | ↔ 684 | ↘ 124 |



IP44

Victoria

4 | 34133/11/10

PHILIPS 11W INCL.

3x E14 | max. 11W | 230V | Ⓟ

Y | | 111 | ↔ 502 | ↘ 80 |



IP44

Экономят  
энергию

AQUA  
Bathroom Lighting



Brenna

1 | 32026/11/10

PHILIPS 20W INCL.

2x E27 | max. 20W | 230V | Ⓢ

Y | T 73 | ← 300 | ↗ 300 |



IP44

Доступно начиная с июля 2011

Brenna

2 | 34141/11/10

PHILIPS 12W INCL.

1x E14 | max. 12W | 230V | Ⓢ

Y | I 191 | ← 126 | ↗ 181 |



IP44

Доступно начиная с июля 2011





**Mermaid**

1 | 34097/11/10

 **PHILIPS 40W INCL.**  
1x G9 | max. 40W | 230V | ⊕

 | ↑ 130 | ↔ 74 | ↗ 182 |



IP21

**Mermaid**

2 | 34098/11/10

 **PHILIPS 40W INCL.**  
2x G9 | max. 40W | 230V | ⊕

 | ↑ 130 | ↔ 380 | ↗ 182 |







IP21







AQUA  
Bathroom Lighting



Flow

	2   34099/06/10
	<b>PHILIPS 40W INCL.</b> 2x G9   max. 40W   230V   ⊕
	193   ← 198   ↘ 175
	
IP21	

Reef

	2   34134/06/10
	<b>PHILIPS 11W INCL.</b> 3x E14   max. 11W   230V   □
	111   ← 531   ↘ 80
	
IP44	



## Flow

1 | 34088/06/10

 **PHILIPS 40W INCL.**

1x G9 | max. 40W | 230V | Ⓢ

 | 1 200 | ← 74 | ↗ 177 |







IP21

Экономят  
энергию





AQUA  
Bathroom Lighting



### Geyser

	1   32081/31/10
	PHILIPS 18W INCL. 1x E27   max. 18W   230V   Ⓢ
	T 110   ↔ 270   ↗ 270
 	
IP44	

### Mangrove

	2   32082/87/10
	PHILIPS 40W INCL. 1x 2GX13   max. 40W   230V   Ⓢ
	T 65   ↔ 400   ↗ 400
 	
IP44	

Экономят  
энергию 



## Brooks

 1 | 32025/31/10

 PHILIPS 25W INCL.

1x E27 | max. 25W | 230V | 

 | T 150 | ↔ 355 | ↗ 355 |

IP44

Доступно начиная с июля 2011

AQUA  
Bathroom Lighting

Aqua  
310



Anouk

□ 1 | 32001/31/10

1x E27 | max. 60W | 230V | ☐

Y | T 105 | ↔ 255 | ↗ 255 |



IP44

Aro

□ 2 | 32005/31/10

1x E27 | max. 60W | 230V | ⊕

Y | T 120 | ↔ 260 | ↗ 260 |



IP44

Bay

■ 3 | 32070/17/10

⊙ PHILIPS 40W INCL.

1x 2GX13 | max. 40W | 230V | ⊕

Y | T 54 | ↔ 360 | ↗ 360 |



IP44



## Surf

□ 1 | 32071/31/10

⊙ **PHILIPS 22W INCL.**

1x 2GX13 | max. 22W | 230V | Ⓢ

**LED 0,96W INCL.** | 16-LED

1x LED | max. 0,96W |  $\frac{230V}{3,2V}$  |

Y | T 90 | ↔ 360 | ↗ 360 |



IP44





AQUA  
Bathroom Lighting



4



3

Boat

1 | 32009/11/10

2 | 32009/17/10

 **PHILIPS 25W INCL.**  
1x G9 | max. 25W | 230V | ⊕

 | T 45 | ← 185 | ↗ 185 |



IP44

Ship

3 | 32010/11/10

4 | 32010/17/10

1x E27 | max. 60W | 230V | ⊕

 | T 100 | ← 315 | ↗ 315 |



IP44



1

2



3



4



### Rain

1 | 32020/67/10

1x E27 | max. 75W | 230V | Ⓢ

Y | T 90 | ↔ 300 | ↗ 300 |



IP21

### Atoll

2 | 32064/31/10

1x E27 | max. 60W | 230V | Ⓢ

Y | T 110 | ↔ 260 | ↗ 260 |



IP44

### Island

3 | 32067/31/10

2x E27 | max. 60W | 230V | Ⓢ

Y | T 120 | ↔ 400 | ↗ 400 |



IP44

### Dive

4 | 32080/17/10

1x E27 | max. 60W | 230V | Ⓢ

Y | T 85 | ↔ 314 | ↗ 314 |



IP44

1





2



Delta

1 | 59919/17/10

 PHILIPS 12W INCL.

1x E14 | max. 12W | 230V | 

 | ← 108 | Ⓢ 95 | ⊥ 133 |



IP44

Delta

2 | 59920/17/10

 PHILIPS 12W INCL.

1x E14 | max. 12W | 230V | 

 | ← 109 | Ⓢ 95 | ⊥ 143 |



IP44

1



2  
3 set



Spray

1 | 59922/17/10

 **PHILIPS 20W INCL.**

1x G4 | max. 20W |  $\frac{230V}{12V}$  | 

 |  $\leftrightarrow$  85 |  $\odot$  75 |  $\perp$  88 |



IP65

Spray

2 | 59924/17/10

 **PHILIPS 20W INCL.**

3x G4 | max. 20W |  $\frac{230V}{12V}$  | 







 |  $\leftrightarrow$  85 |  $\odot$  75 |  $\perp$  90 |









IP65



Lutea

-  1 | 59905/11/10
-  2 | 59905/17/18
-  **PHILIPS 50W INCL.**  
1x GU10 | max. 50W | 230V | 
-  | ← 105 | Ⓢ 90 | ⊥ 150 |
-  
- IP44

Tigris

-  3 | 59910/11/10
-  4 | 59910/17/18
-  **PHILIPS 50W INCL.**  
1x GU10 | max. 50W | 230V | 
-  | ← 105 | Ⓢ 90 | ⊥ 150 |
-  
- IP44





1  
3 set









2  



### Lake

	1   59902/11/10
	<b>PHILIPS 50W INCL.</b>
	3x GU10   max. 50W   230V   
	↔ 100   ⌀ 80   ± 110
	
	IP23

### Flow

	2   59915/17/10
	<b>PHILIPS 7W INCL.</b>
	1x GX53   max. 7W   230V   
	↔ 94   ⌀ 85   ± 30
	 
	IP23

# CUCINA

Kitchen Lighting





CUCINA  
Kitchen Lighting



# Cucina

## Идеальный рецепт для вашей кухни

При оснащении или переоборудовании такого универсального и часто посещаемого помещения, как кухни, освещение становится неотъемлемой частью интерьера. Правильный подбор освещения оптимизирует функциональность, внешний вид и энергопотребление кухни, а также играет важную роль в обеспечении комфорта, здоровья и безопасности.

### Настраиваемые системы освещения

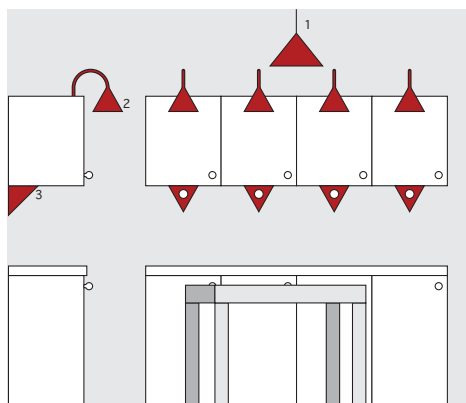

1- Подсветка или общее освещение

2- Акцентное освещение

3- Рабочее освещение

Кухня — это прежде всего помещение, где готовится пища, но это также и то место, где можно провести время с семьей и друзьями. Вот почему общее и акцентное освещение, которое повышает уровень комфорта во время пребывания на кухне, так же важно, как и рабочее освещение для создания функционального рабочего места.

1- Подсветка или общее освещение: люминесцентные люстры и потолочные светильники CUCINA обеспечивают общее освещение и наполняют помещение приятным свечением.

2- Акцентное освещение: выделите достоинства кухни путем подсветки шкафов, картин и т. д.

3- Рабочее освещение: находится ли оно под верхними шкафами или над островком кухни, разместите его там, где вы делаете нарезки и читаете рецепты.

### Комбинируемые системы

Поскольку функциональность имеет крайне важное значение, системы CUCINA предлагают изделия для освещения под шкафами, средства электроснабжения, аккумуляции и коммуникации. Их можно легко комбинировать, придавая результату законченный вид.

### Удобная для мытья отделка

Поскольку на кухне должна тщательно соблюдаться гигиена, все изделия CUCINA имеют специальную отделку, которая дает возможность содержать кухонные светильники в чистоте без излишних усилий.

### Простая установка

Проводите ли вы реконструкцию на старой кухне или собираете совершенно новую, благодаря четким инструкциям при установке изделий CUCINA не должно возникать никаких затруднений.

3



1



ЭКОНОМЯТ  
энергию

CUCINA

Kitchen Lighting



2



Cinnamon

1 | 33480/17/10

PHILIPS 32W INCL.

1x G10Q | max. 32W | 230V | Ⓢ

Y | | 1500 | ↔ 380 | ↗ 380 |



Dill

2 | 33481/17/10

PHILIPS 32W INCL.

1x G10Q | max. 32W | 230V | Ⓢ

Y | | 95 | ↔ 380 | ↗ 380 |



Nettle

3 | 40318/31/10

PHILIPS 60W INCL.

1x 2GX13 | max. 60W | 230V | Ⓢ

Y | | 1500 | ↔ 450 | ↗ 450 |

















Экономят  
энергию 



### Juniper

	1   33470/17/10
	<b>PHILIPS 14W INCL.</b> 1x G5   max. 14W   230V   
	T 36   ↔ 600   ↗ 100
	

### Juniper

	2   33471/17/10
	<b>PHILIPS 14W INCL.</b> 1x G5   max. 14W   230V   
	T 105   ↔ 600   ↗ 100
	





1  
 



2



3



4

Tarragon

 1 | 33450/17/10  
 **PHILIPS 14W INCL.**  
 1x G5 | max. 14W | 230V | 

 | 1 60 | ↔ 600 | ↗ 150 |







Tarragon

 2 | 33451/17/10  
 **20W INCL.**  
 1x G4 | max. 20W |  12V | 

 | 1 60 | ↔ 300 | ↗ 150 |



Tarragon

 3 | 33452/17/10  
 **20W INCL.**  
 2x G4 | max. 20W |  12V | 

 | 1 60 | ↔ 600 | ↗ 150 |



Tarragon

 4 | 33466/17/10

 | 1 60 | ↔ 150 | ↗ 150 |



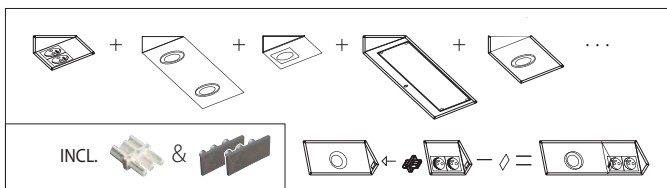

Tarragon

■	1   33464/17/10
Y	160   ← 150   ↘ 150
MET	

Tarragon

■	2   33465/17/10
Y	160   ← 150   ↘ 150
MET SYN	

Tarragon

■	3   33468/17/10
Y	160   ← 300   ↘ 150
MET SYN	



Экономят энергию

CUCINA  
Kitchen Lighting

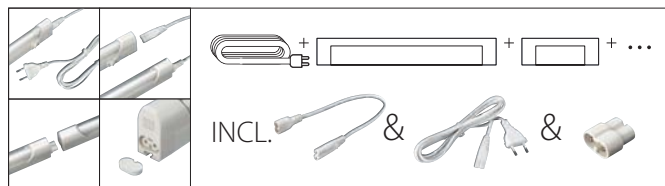

Myrtle

<input type="checkbox"/>	1   33490/31/10
	<b>PHILIPS 6W INCL.</b> 1x G5   max. 6W   230V
	142   ↔ 245   ↗ 22

Myrtle

<input type="checkbox"/>	2   33491/31/10
	<b>PHILIPS 14W INCL.</b> 1x G5   max. 14W   230V
	142   ↔ 580   ↗ 22

Myrtle

<input type="checkbox"/>	3   33492/31/10
	<b>PHILIPS 21W INCL.</b> 1x G5   max. 21W   230V
	142   ↔ 880   ↗ 22

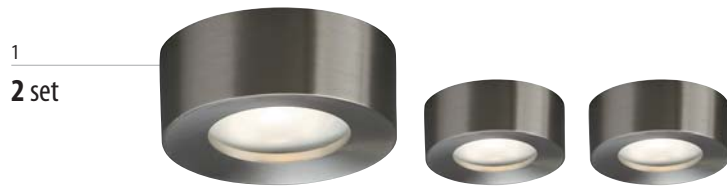

**Mint**

■	1   59700/17/10
⚡	20W INCL. 2x G4   max. 20W   230V-12V   □
Y	← 75   Ⓢ 75   ⊥ 30
MET	☼

**Coriander**

■	2   59701/17/10
⚡	20W INCL. 2x G4   max. 20W   230V-12V   □
Y	↓ 55   ← 90   ↗ 145
MET	☼

**Chives**

■	3   59702/17/10
⚡	20W INCL. 2x G4   max. 20W   230V-12V   □
Y	↓ 70   ← 95   ↗ 150
MET	☼

**Sesame**

■	4   59704/48/10
⚡	20W INCL. 2x G4   max. 20W   230V-12V   □
Y	↓ 50   ← 160   ↗ 140
MET	☼



Экономят энергию

CUCINA  
Kitchen Lighting



### Celery

1 | 33440/17/10

LED 0,06W INCL. | LED

6x LED | max. 0,06W | 230V-18V | □

Y | ← 15 | ⊕ 10 | ⊥ 37 |

MET

### Mace

□ 2 | 59706/31/10

■ 3 | 59706/48/10

⊙ PHILIPS 7W INCL.

2x GX53 | max. 7W | 230V | □

Y | ← 94 | ⊕ 85 | ⊥ 24 |

MET SYN



## Laurel

1 | 59708/17/10

 **PHILIPS 23W INCL.**

2x E27 | max. 23W | 230V | 

 | ↔ 230 | Ⓢ 200 | ⊥ 120 |





Kids Lighting







**KICO**  
Kids Lighting





# Kico

## Освещение для самых дорогих

*Серия светильников Kico разработана специально для детей от 0 до 12 лет. Главной целью этих светильников является создание уютной и веселой атмосферы, располагающей к играм и активному времяпрепровождению. Коллекция состоит из большого количества удивительных, веселых и забавных светильников, которые безусловно понравятся Вашему ребенку. Хорошее освещение важно для всех, но особенно оно важно и необходимо для самых маленьких. Чтобы подчеркнуть всю важность освещения детских комнат, мы разработали широкую линейку самых разных светильников для самых разнообразных потребностей: подвесные, потолочные, настольные и светильники для акцентного освещения.*

### Безопасность прежде всего!

Принцесса или пират, ангел или шалун, не важно, кто Ваш ребенок, главное для нас – его безопасность. Все светильники серии Kico соответствуют самым жестким требованиям Европейских норм в области детской безопасности. Мы гарантируем безопасность наших продуктов для детей, и мы гарантируем использование безопасных и экологичных материалов, таких как дерево и нетоксичные краски. Также многие продукты серии уже содержат лампы Philips, которые не только обладают высоким качеством и энергоэффективностью, но и обладают повышенной световой отдачей, которая так необходима в детских комнатах. Проявите заботу о детях, используйте светильники Kico.

1



2



3



**Giraf**

1 | 40590/55/10

**PHILIPS 18W INCL.**

1x E27 | max. 18W | 230V |

| 1 676 | ↔ 114 | ↗ 114 |

ALU MET SYN

**Monkey**

2 | 40591/55/10

**PHILIPS 18W INCL.**

1x E27 | max. 18W | 230V |

| 1 676 | ↔ 155 | ↗ 155 |

ALU MET SYN

**Giraf**

3 | 43590/55/10

**PHILIPS 10W INCL.**

1x G4 | max. 10W | 12V |

| 1 297 | ↔ 130 | ↗ 254 |

ALU MET SYN

**Monkey**

4 | 43591/55/10

**PHILIPS 10W INCL.**

1x G4 | max. 10W | 12V |

| 1 297 | ↔ 130 | ↗ 254 |

ALU MET SYN



Zebra

■	1   40592/55/10
💡	<b>PHILIPS 18W INCL.</b> 1x E27   max. 18W   230V   ☑
Y	I 676   ↔ 156   ↗ 156
ALU	MET SYN

Zoo

■	2   40593/55/10
💡	<b>PHILIPS 14W INCL.</b> 3x E27   max. 14W   230V   ⚡
Y	T 339   ↔ 626   ↗ 626
ALU	MET SYN

Zoo

■	3   40594/55/10
💡	<b>PHILIPS 14W INCL.</b> 3x E27   max. 14W   230V   ⚡
Y	I 660   ↔ 300   ↗ 300
ALU	MET SYN

Zebra

■	4   43592/55/10
💡	<b>PHILIPS 10W INCL.</b> 1x G4   max. 10W   230V 12V   ⚡
Y	I 297   ↔ 130   ↗ 254
ALU	MET SYN

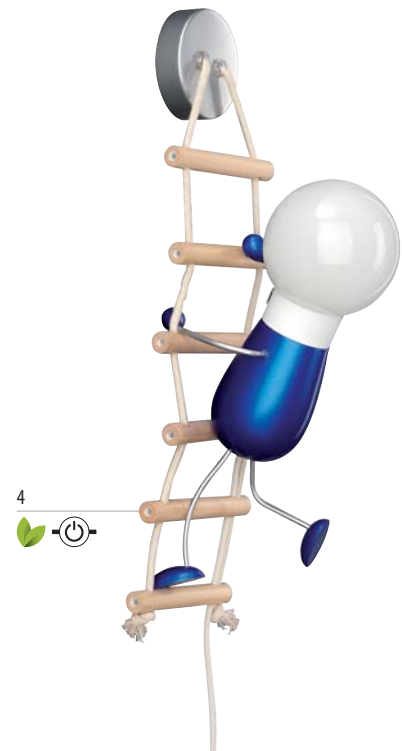
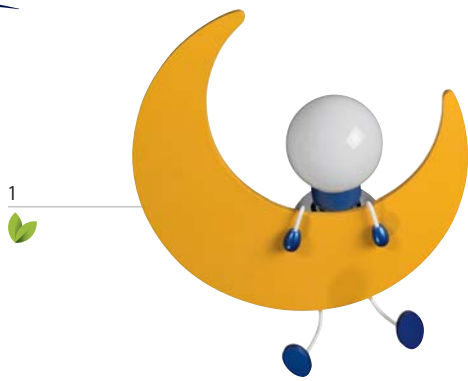

**Lunardo**

1 | 30268/55/10

**PHILIPS 14W INCL.**  
1x E27 | max. 14W | 230V | Ⓢ

| T 349 | ↔ 320 | ↗ 141 |



**Lunardo**

2 | 40092/34/10

**PHILIPS 14W INCL.**  
1x E27 | max. 14W | 230V | Ⓢ

| T 1050 | ↔ 340 | ↗ 150 |



**Lunardo**

3 | 43246/55/10

**PHILIPS 10W INCL.**  
1x G4 | max. 10W | 230V 12V | Ⓢ

| T 269 | ↔ 270 | ↗ 220 |



**Climbo**

4 | 45502/55/30

**PHILIPS 14W INCL.**  
1x E27 | max. 14W | 230V | Ⓢ

| T 500 | ↔ 125 | ↗ 140 |



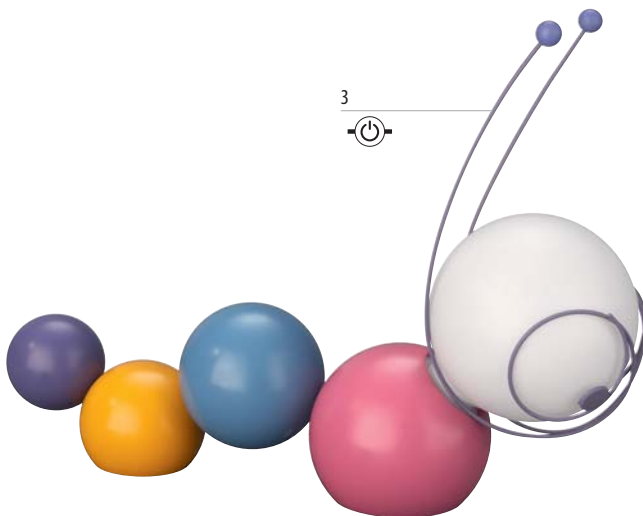
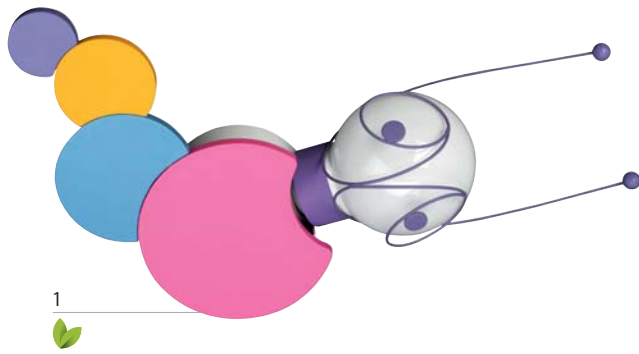

Kico

337

Ruby

1 | 30267/55/10

**PHILIPS 14W INCL.**

1x E27 | max. 14W | 230V |

| T 109 | ← 398 | ↗ 229 |



Ruby

2 | 40093/55/10

**PHILIPS 18W INCL.**

1x E27 | max. 18W | 230V |

| I 1250 | ← 470 | ↗ 130 |



Ruby

3 | 43245/55/10

**PHILIPS 10W INCL.**

1x G4 | max. 10W | 12V |

| I 242 | ← 330 | ↗ 112 |



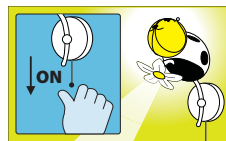
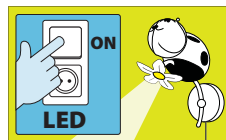

Экономят энергию

**KICO**  
Kids Lighting

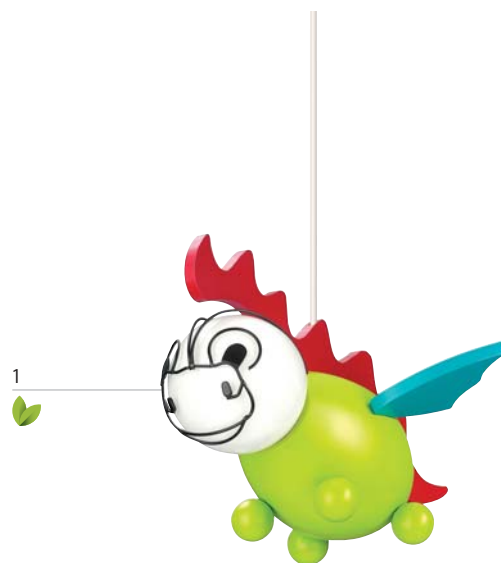

**Drakey**

1 | 40229/55/10

**PHILIPS 14W INCL.**  
1x E27 | max. 14W | 230V |

| 1500 | 320 | 270 |

MET SYN

**Butterfly**

2 | 40280/55/10

**PHILIPS 14W INCL.**  
1x E27 | max. 25W | 230V |

| 1500 | 369 | 418 |

SYN

**Coccinet**

3 | 41157/55/10

**PHILIPS 14W INCL.**  
1x E27 | max. 14W | 230V |

**LED 1W INCL.** | PowerLED  
1x LED | max. 1W |

| 312 | 310 | 160 |

ALU MET SYN

**Coccinet**

4 | 45557/55/10

**PHILIPS 14W INCL.**  
1x E27 | max. 14W | 230V |





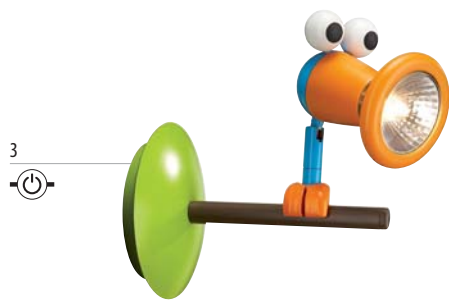
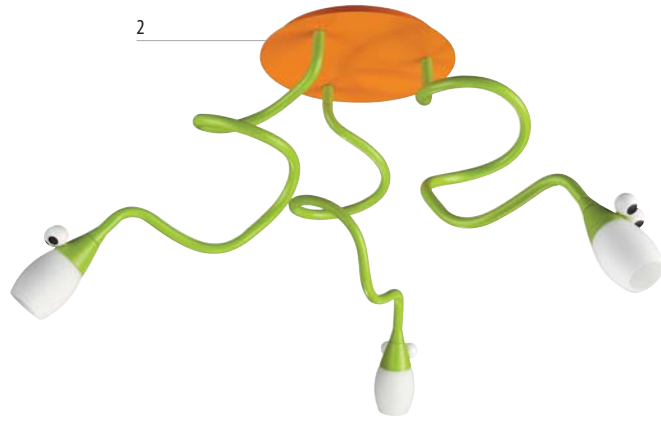

**LED 1W INCL.** | PowerLED  
1x LED | max. 1W |

| 285 | 122 | 253 |







ALU MET SYN









**Snakey**

	1   56300/55/30
	<b>PHILIPS 40W INCL.</b> 1x G9   max. 40W   230V   
	I 164   ← 164   ↗ 243
	 







**Snakey**

	2   56303/55/10
	<b>PHILIPS 40W INCL.</b> 3x G9   max. 40W   230V   
	T 348   ← 873   ↗ 230
	 

**Birdey**

	3   56310/55/30
	<b>PHILIPS 50W INCL.</b> 1x GU10   max. 50W   230V   
	I 145   ← 101   ↗ 161
	

**Birdey**

	4   56314/55/10
	<b>PHILIPS 50W INCL.</b> 4x GU10   max. 50W   230V   
	T 162   ← 814   ↗ 134
	



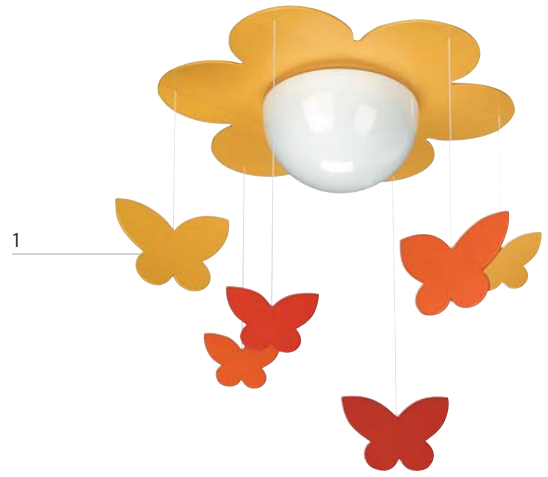

**Meria**

1 | 40096/34/10

1x E27 | max. 40W | 230V | ☐

Y | T 450 | ↔ 385 | ↗ 385 |



**Iridia**

2 | 40178/55/10

1x E27 | max. 75W | 230V | ☐

Y | I 1300 | ↔ 420 | ↗ 420 |



**Fiore**

3 | 40356/20/10

**PHILIPS 14W INCL.**  
1x E27 | max. 60W | 230V | ☐

Y | I 1500 | ↔ 662 | ↗ 662 |





2



3

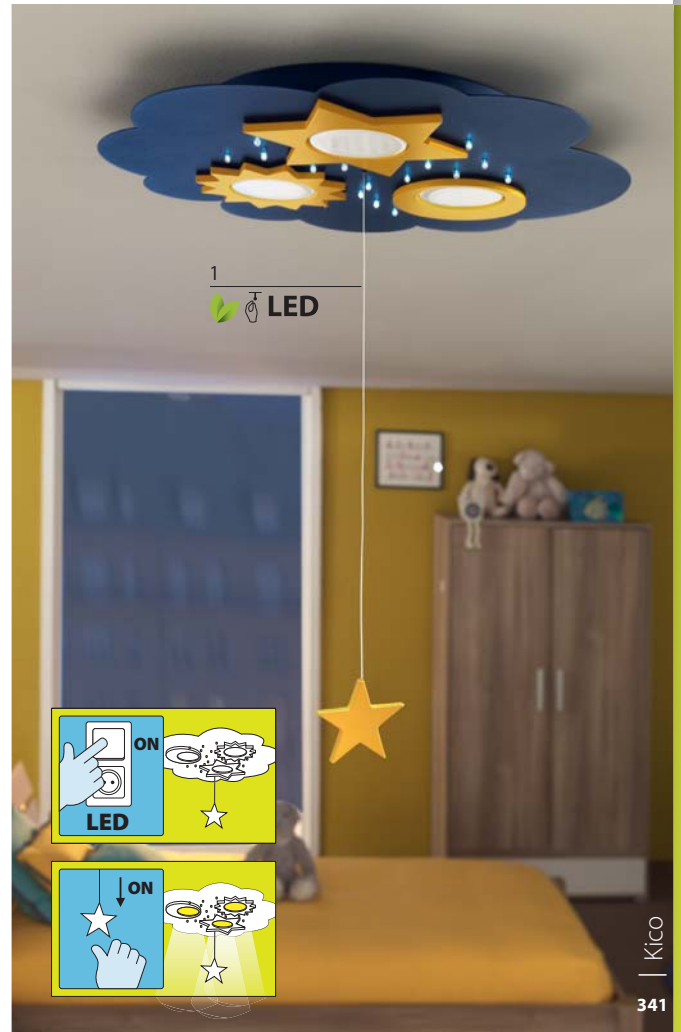

1  
LED

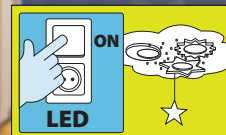

Kico  
341

### Strea

■ 1 | 30262/35/10

⊙ PHILIPS 9W INCL.

3x GX53 | max. 9W | 230V | ⊕

LED 0,06W INCL. | 16-LED

16x LED | max. 0,06W | 3,2V

Y | T 47 | ← 449 | ↗ 449



### Maripo

■ 2 | 40426/35/10

1x E27 | max. 75W | 230V | ⊞

Y | I 1500 | ← 350 | ↗ 350



### Maripo

■ 3 | 40427/34/10

1x E27 | max. 75W | 230V | ⊞

Y | I 1500 | ← 350 | ↗ 350



2



1





3





**Pinko**

<input type="checkbox"/>	1   40627/31/10
	1x E14   max. 40W   230V   Ⓢ
Y	11070   ↔ 290   ↗ 290
	MET 

**Princess**

<input checked="" type="checkbox"/>	2   41594/28/10
	3x E14   max. 40W   230V   Ⓢ
Y	11276   ↔ 466   ↗ 466
	MET  

**Princess**

<input checked="" type="checkbox"/>	3   45694/28/10
	2x E14   max. 40W   230V   Ⓢ
Y	1333   ↔ 322   ↗ 209
	MET  



## Fairy

1 | 40279/55/10

 **PHILIPS 18W INCL.**

1x E27 | max. 60W | 230V | 

 | 1 1500 | ← 185 | ↗ 234 |





### Rainbo

1 | 40509/55/10

4x E14 | max. 40W | 230V | ☐

Y | 1 | 1500 | ↔ 623 | ↗ 560 |



### Lali

2 | 40631/20/10

1x E27 | max. 60W | 230V | ☐

Y | 1 | 1500 | ↔ 365 | ↗ 365 |



Доступно начиная с июля 2011

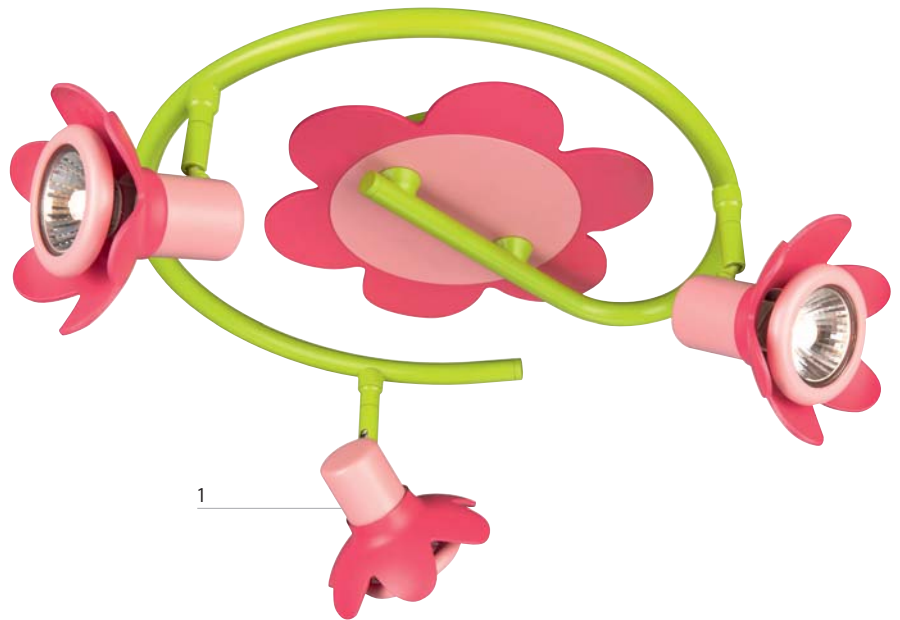

**Paquero**

1 | 56503/55/10

 **PHILIPS 50W INCL.**

3x GU10 | max. 50W | 230V | ⊕

 | T 152 | ← 406 | ↗ 406 |



Доступно начиная с июля 2011

**Paquero**

2 | 56504/55/10

 **PHILIPS 50W INCL.**

4x GU10 | max. 50W | 230V | ⊕





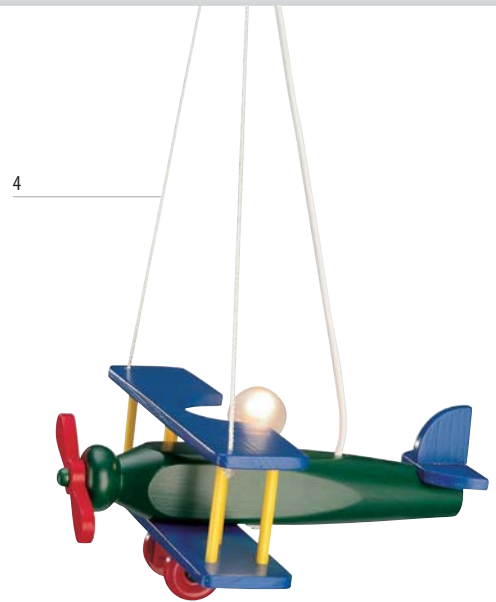

 | T 152 | ← 887 | ↗ 263 |







Доступно начиная с июля 2011







**Sky**

	1   30110/55/10
	1x E27   max. 60W   230V   Ⓢ
	T 135   ↔ 300   ↗ 300
	
	



**Monty**

	2   30112/55/10
	2x E27   max. 60W   230V   Ⓢ
	T 356   ↔ 400   ↗ 400
	

**Avigo**

	3   40153/55/10
	1x E27   max. 40W   230V   Ⓢ
	T 430   ↔ 400   ↗ 400
	

**Yumbo**

	4   78621/01/55
	1x E27   max. 60W   230V   Ⓢ
	↓ 1100   ↔ 300   ↗ 350
	



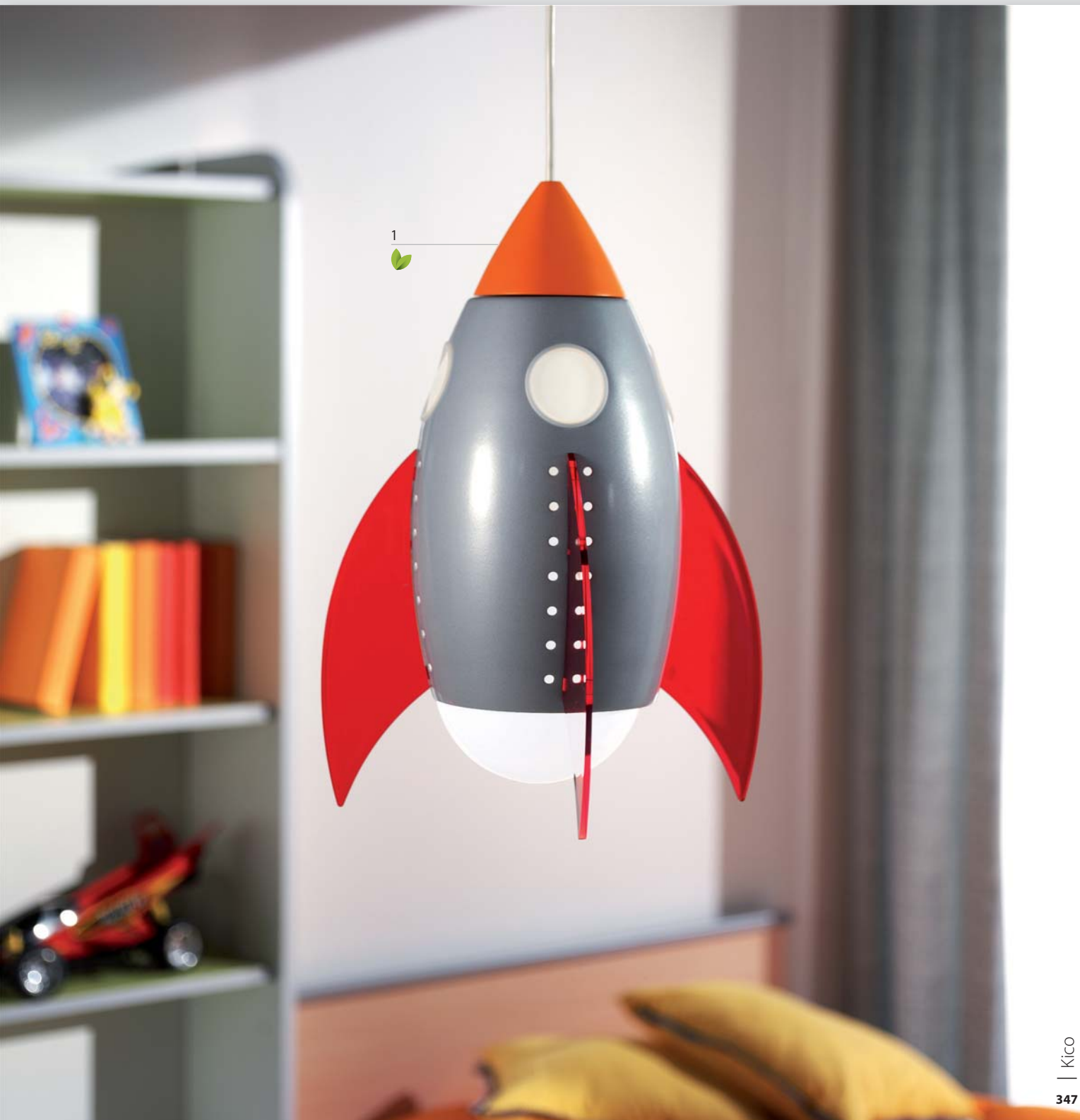

## Rocky

1 | 40204/55/10

 **PHILIPS 18W INCL.**

1x E27 | max. 60W | 230V | 

 | 1 1200 | ← 267 | ↗ 267 |



3



**Kico**

Kids Lighting



2

1



**Cheezzz...**

1 | 40281/34/10

1x E27 | max. 60W | 230V | ☐

Y | | I 1500 | ↔ 186 | ↗ 186 |



**Timeo**

2 | 56173/55/10

PHILIPS 50W INCL.

3x GU10 | max. 50W | 230V | ☐

Y | | T 360 | ↔ 290 | ↗ 290 |



**Sunshine**

3 | 70614/81/34

1x E27 | max. 60W | 230V | ☐

Y | | T 85 | ↔ 370 | ↗ 370 |

















| Kico

349

**Amore**

	1   40628/32/10
	1x E27   max. 40W   230V   
	1840   ← 416   ↗ 170
	 

**Kingston**

	2   40629/31/10
	1x E27   max. 40W   230V   
	1850   ← 457   ↗ 170
	 

# STUDIO



*Desk Lighting!*





**STUDIO**  
*Desk Lighting!*



# Studio

## Когда это заслуживает всего вашего ВНИМАНИЯ

*Такие занятия, как чтение, учеба и работа, требуют определенного освещения. Компания STUDIO предлагает серию настольных ламп, которые помогут осветить письменный стол оптимальным образом.*

Различные исследования показывают, что существует прямая зависимость между освещением и продуктивностью: когда глаза получают достаточно света, легче оставаться сосредоточенным. Это означает, что правильный тип освещения позволяет ускорить процесс работы, благодаря чему вероятность напряжения глаз, усталости и головных болей существенно снижается.

Безусловно, часто очень важно, чтобы свет можно было направлять в нужное место: направляемые лампы STUDIO разработаны и протестированы с учетом возможности выбора угла освещения без риска обжечь руки. Лампы STUDIO незаменимы, когда требуется полноценное освещение рабочего пространства.



POWERLED

STUDIO  
Desk Lighting!

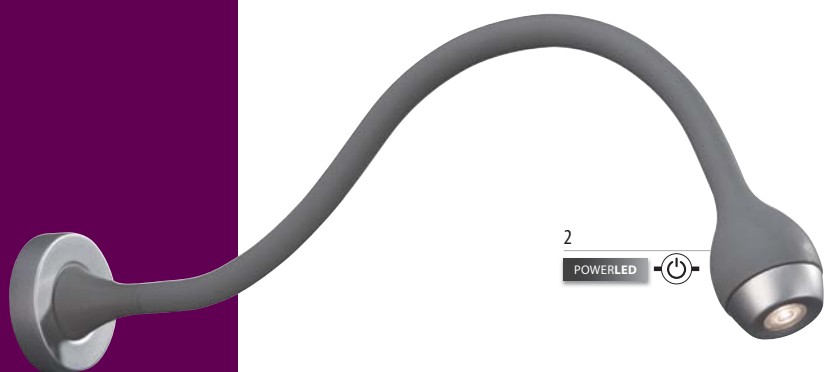

2  
POWERLED



3  
POWERLED



1  
POWERLED

 ЭКОНОМЯТ  
энергию

Jarno

1 | 66705/30/10

2 | 66705/87/10

LED 2,5W INCL. | PowerLED

1x LED | max. 2,5W | SELV | 

Y | | 1473 | ↔ 44 | ↗ 106 |

ALU SYN

Nathan

3 | 66706/87/10

LED 2,5W INCL. | PowerLED

2x LED | max. 2,5W | 230V | 

Y | | 631 | ↔ 154 | ↗ 390 |

ALU MET SYN



1

POWERLED



| Studio

355

Экономят  
энергию



## Nathan

■ 1 | 66706/30/10

LED 2,5W INCL. | PowerLED

2x LED | max. 2,5W | 230V | ☐

Y | I 631 | ← 154 | ↗ 390 |

ALU

MET

SYN



STUDIO  
Desk Lighting!



Carlton

1 | 1200/21/30

50W INCL.

1x GY 6,35 | max. 50W | 230V 12V | □

| 1510 | ↔ 160 | ↗ 270 |

MET SYN

Architect

2 | 12830/01/87

1x E27 | max. 60W | 230V | □

| 1900 | ↔ 190 | ↗ 800 |

MET SYN

Architect

3 | 12831/01/30

4 | 12831/01/31

1x E27 | max. 60W | 230V | □

| 1800 | ↔ 185 | ↗ 600 |

MET SYN

Lewis

5 | 66614/30/10

6 | 66614/87/10

PHILIPS 11W INCL.

1x G23 | max. 11W | 230V | □

| 1459 | ↔ 200 | ↗ 595 |

MET SYN



**Benjamin**

1 | 66434/17/10

2 | 66434/87/10

3 | 66434/91/10

1x E14 | max. 40W | 230V | ☐

Y | | 1 520 | ↔ 145 | ↗ 345 |

MET SYN

**Martin**

4 | 67201/17/10

1x E14 | max. 40W | 230V | ☐

Y | | 1 370 | ↔ 145 | ↗ 170 |

MET



STUDIO  
Desk Lighting!

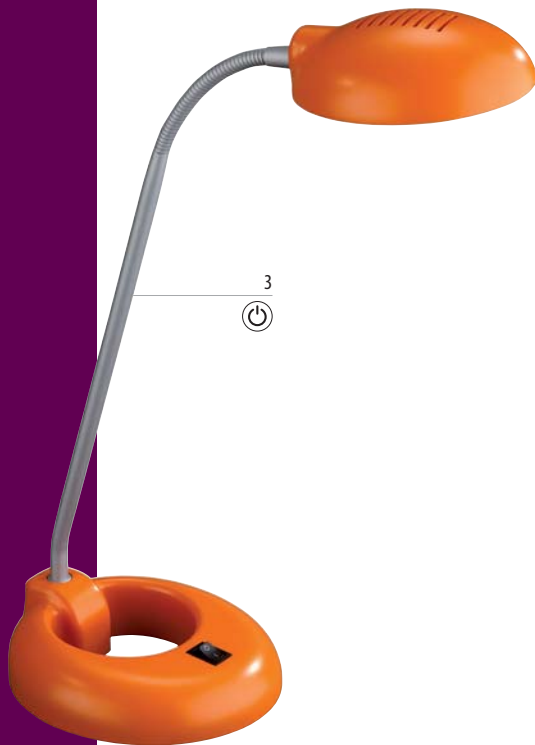

Phil

 1 | 67107/33/10

 2 | 67107/35/10

 3 | 67107/53/10

 PHILIPS 40W INCL.

1x G9 | max. 40W | 230V | 

 | 1385 | ↔ 140 | ↗ 275 |

Ewan

 4 | 67200/35/10

 5 | 67200/53/10

 6 | 67200/93/10

1x E14 | max. 40W | 230V | 

 | 1350 | ↔ 160 | ↗ 360 |



Экономят энергию



**Mick**

- 1 | 67203/30/10
- 2 | 67203/31/10
- 3 | 67203/46/10

1x E27 | max. 12W | 230V |

| 1 395 |  $\leftrightarrow$  130 |  $\nearrow$  225 |

**Frank**

- 4 | 67319/32/10
- 5 | 67319/87/10
- 6 | 67319/91/10

**PHILIPS 14W INCL.**

1x E27 | max. 14W | 230V |

| 1 360 |  $\leftrightarrow$  180 |  $\nearrow$  340 |

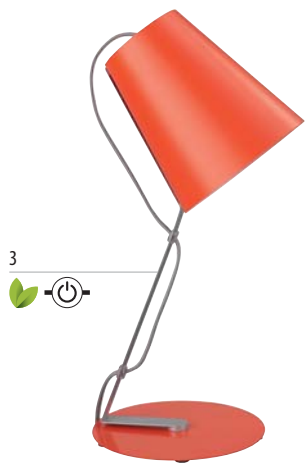

Timo

1 | 66615/20/10

2 | 66615/30/10

1x E14 | max. 12W | 230V | ☐

Y | | 1 405 | ↔ 225 | ↗ 260 |

MET SYN

Skip

3 | 66620/32/10

4 | 66620/33/10

1x E14 | max. 12W | 230V | ☐







Y | | 1 395 | ↔ 160 | ↗ 206 |

MET SYN





## Skip

	1   66620/28/10
	1x E14   max. 12W   230V   
	1 395    160    206
	



STUDIO  
Desk Lighting!

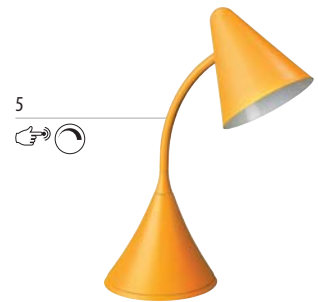

Ringo

1 | 12923/01/32

2 | 12923/01/35

1x E14 | max. 40W | 230V | ☐

Y | | 1335 | ↔ 110 | ↗ 155 |

MET SYN

Ringo

3 | 12923/01/53

4 | 12923/01/87

1x E14 | max. 40W | 230V | ☐

Y | | 1335 | ↔ 110 | ↗ 155 |

MET SYN

Benny

5 | 66236/34/10

6 | 66236/35/10

7 | 66236/87/10

 PHILIPS 40W INCL.

1x G9 | max. 60W | 230V | ☐

Y | | 1296 | ↔ 120 | ↗ 229 |

MET SYN

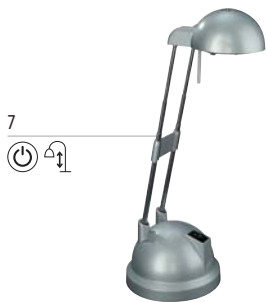
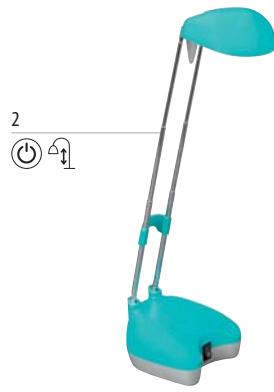
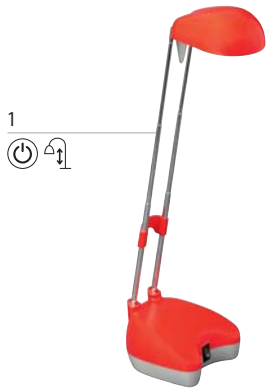

### Samuel

1 | 67002/32/10

2 | 67002/46/10

3 | 67002/96/10

35W INCL.

1x GY 6,35 | max. 35W | 230V-12V | □

| 1 475 | ← 110 | ↗ 125 |

MET SYN

### Tommi

4 | 83244/21/30

5 | 83244/21/34

6 | 83244/21/35

7 | 83244/21/87

20W INCL.

1x G4 | max. 20W | 230V-12V | □

| 1 440 | ← 117 | ↗ 430 |

MET SYN



STUDIO  
Desk Lighting!

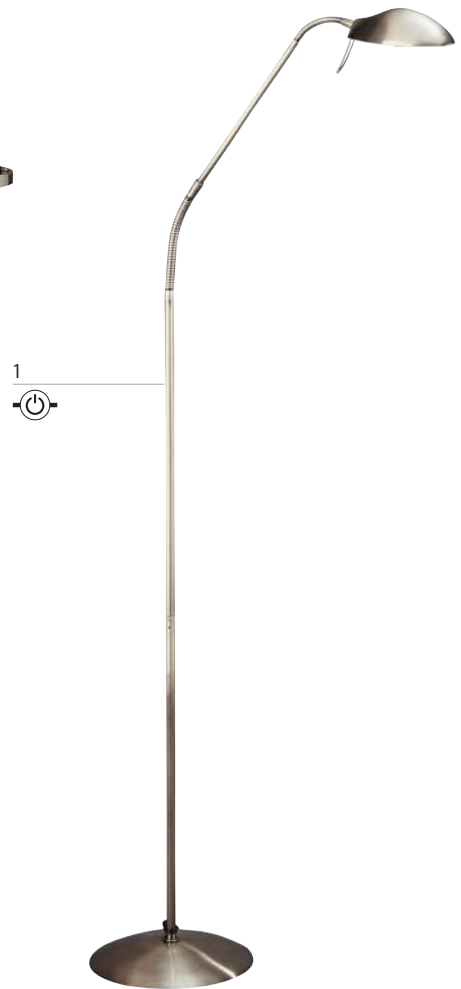

Flamingo

1 | 929/21/06

35W INCL.

1x GY 6,35 | max. 35W | 230V 12V | □

Y | | 1370 | ↔ 225 | ↗ 600 |



Flamingo

2 | 1229/21/06

3 | 1229/21/17

35W INCL.

1x GY 6,35 | max. 35W | 230V 12V | □

Y | | 500 | ↔ 150 | ↗ 350 |



Winston

4 | 67010/17/10

50W INCL.

1x GY 6,35 | max. 50W | 230V 12V | □

Y | | 555 | ↔ 200 | ↗ 445 |









Экономят энергию 







Studio

365





James

	1   66612/06/10
	<b>PHILIPS 14W INCL.</b> 1x E27   max. 14W   230V   
	1 100   ↔ 110   ↗ 476
	

James

	2   66613/06/10
	<b>PHILIPS 14W INCL.</b> 1x E27   max. 14W   230V   
	1 421   ↔ 172   ↗ 500
	

James

	3   67653/06/10
	<b>PHILIPS 14W INCL.</b> 1x E27   max. 14W   230V   
	1 1320   ↔ 220   ↗ 655
	



# Серия уличных светильников

---





# Серия уличных светильников

## Свет снаружи

Сад является неотъемлемой частью дома. Свет в нем используется для подсветки дорожек, порогов и автомобильного подъезда или для создания уютной атмосферы летом, во время посиделок на свежем воздухе. Massive предлагает Вашему вниманию большой выбор светильников разных стилей и для разных целей. Какие бы светильники Вы не искали, современные и лаконичные или романтические и изысканные, в коллекции светильников для улицы от Massive Вы найдете то, что соответствует Вашему вкусу и интерьеру.

### Жизнь под открытым небом

В настоящее время разделение на дом и улицу становится все более и более условным. Во многих садах и придомовых территориях появляются летние кухни и домики. Сад и терраса могут стать новым местом, где люди готовят, едят, читают, играют, отдыхают или работают. Для этих зон, как и для остального дома, компания Massive предлагает решения для создания уютной, расслабляющей атмосферы.

### У природы нет плохой погоды

Все светильники Massive из серии светильников для улицы тщательно продуманы и сконструированы для безопасной и долгой работы в любых погодных условиях, а также для простоты сборки и установки. Кроме того, большинство светильников для улицы содержат лампу Philips в комплекте, обеспечивая лучшую световую отдачу, качество и энергоэффективность.

#### P.I.R. 140° - Type A

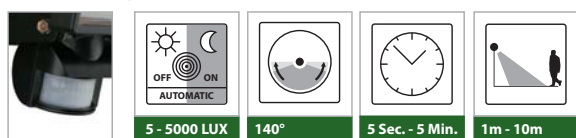

#### P.I.R. 140° - Type B

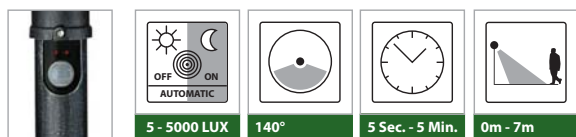
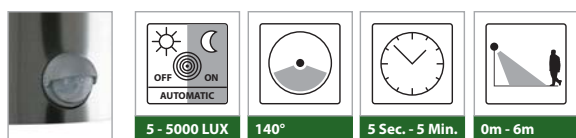
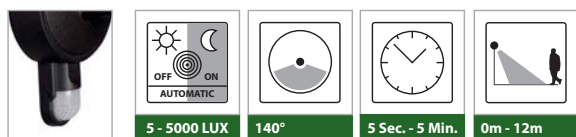



POWERLED

3

POWERLED



1

POWERLED



2

POWERLED



 Экономят энергию

Gotha

■ 1 | 16320/93/10

LED PHILIPS 7,5W INCL. | PowerLED

1x LED | max. 7,5W |  $\frac{230V}{SELV}$  |  $\oplus$

Y | | 1107 |  $\leftrightarrow$  124 |  $\nearrow$  82 |

ALU SYN

IP44

Gotha

■ 2 | 16321/93/10

LED PHILIPS 7,5W INCL. | PowerLED

1x LED | max. 7,5W |  $\frac{230V}{SELV}$  |  $\oplus$

Y | | 1793 |  $\leftrightarrow$  120 |  $\nearrow$  105 |

ALU SYN

IP44

Pori

■ 3 | 17208/93/10

LED PHILIPS 7,5W INCL. | PowerLED

1x LED | max. 7,5W |  $\frac{230V}{SELV}$  |  $\oplus$

Y | | 162 |  $\leftrightarrow$  329 |  $\nearrow$  117 |

ALU SYN

IP44

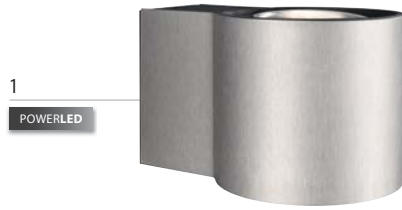

POWERLED



ЭКОНОМЯТ  
энергию 

### Stavanger

1 | 16318/47/10

LED PHILIPS 7,5W INCL. | PowerLED

2x LED | max. 7,5W | SELV | ⊕

Y | | 90 | ↔ 99 | ↗ 149 |

INOX SYN

IP44

### Lyon

2 | 17210/42/10

LED PHILIPS 7,5W INCL. | PowerLED

1x LED | max. 7,5W | SELV | ⊕

Y | | 133 | ↔ 260 | ↗ 328 |

ALU SYN

IP44

### Messina

3 | 17211/86/10

LED PHILIPS 7,5W INCL. | PowerLED

1x LED | max. 7,5W | SELV | ⊕

Y | | 209 | ↔ 200 | ↗ 270 |

ALU SYN

IP44

### Slagelse

4 | 17219/47/10

LED PHILIPS 7,5W INCL. | PowerLED

1x LED | max. 7,5W | SELV | ⊕





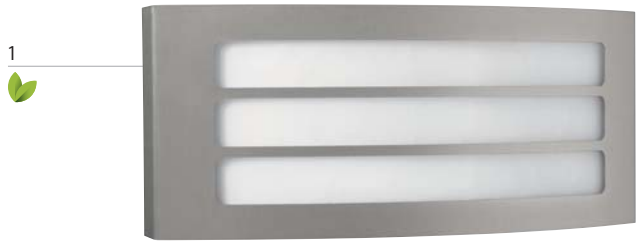

Y | | 183 | ↔ 183 | ↗ 82 |

INOX SYN







IP44



**Agrigento**

	1   17217/47/10
	<b>PHILIPS 23W INCL.</b> 1x E27   max. 23W   230V   
	1 143   ↔ 345   ↗ 102
	
IP44	

**Orsha**







	2   17218/47/10
	<b>PHILIPS 23W INCL.</b> 1x E27   max. 23W   230V   
	1 192   ↔ 413   ↗ 97
	
IP44	









Экономят  
энергию 









### Aberdeen

	1   17166/47/10
	23W INCL. 1x E27   max. 23W   230V   
	↑ 150   ↔ 309   ↘ 108
	
IP44	

### Capri

	2   17185/47/10
	PHILIPS 11W INCL. 2x E14   max. 11W   230V   
	↑ 141   ↔ 322   ↘ 96
	
IP44	

### Orly

	3   17201/47/10
	PHILIPS 23W INCL. 1x E27   max. 23W   230V   
	↑ 140   ↔ 370   ↘ 98
	
IP44	



Calgary

■	1   17025/47/10
	1x E27   max. 60W   230V   □
Y	↓ 155   ← 140   ↘ 100
	INOX
	IP44

Calgary

■	2   17173/47/10
	<b>PHILIPS 12W INCL.</b>
	1x E14   max. 12W   230V   □
Y	↓ 200   ← 176   ↘ 93
	INOX
	IP44

Calgary

■	3   17174/47/10
	<b>PHILIPS 12W INCL.</b>
	1x E14   max. 12W   230V   □
Y	↓ 235   ← 177   ↘ 110
	INOX
	IP44   P.I.R. 140°

Miami

■	4   17181/47/10
	<b>PHILIPS 15W INCL.</b>
	1x E27   max. 15W   230V   □
Y	↓ 78   ← 142   ↘ 171
	INOX   SYN
	IP44





### Kingston

■	1   17071/47/10
☼	<b>PHILIPS 35W INCL.</b>
	2x GU10   max. 35W   230V   ⊕
Y	↓ 103   ↔ 175   ↗ 115
	INOX   🚚
	IP44

### Dover

■	2   17101/47/10
☼	<b>PHILIPS 75W INCL.</b>
	2x GU10   max. 75W   230V   ⊕
Y	↓ 193   ↔ 140   ↗ 153
	INOX   🚚
	IP44

### Nantes

■	3   17102/47/10
☼	<b>PHILIPS 35W INCL.</b>
	2x GU10   max. 35W   230V   ⊕
Y	↓ 160   ↔ 97   ↗ 82
	INOX   🚚
	IP44

### Wexford

■	4   17151/47/10
☼	<b>PHILIPS 50W INCL.</b>
	1x GU10   max. 50W   230V   ☐
Y	↓ 132   ↔ 100   ↗ 134
	INOX   🚚
	IP44



Серия уличных светильников

376



Manhattan

1 | 16232/47/10

PHILIPS 23W INCL.

1x E27 | max. 23W | 230V | ☐

Y | | 130 | ↔ 110 | ↗ 230 |

INOX SYN

IP44

Manhattan

2 | 16233/47/10

PHILIPS 23W INCL.

1x E27 | max. 23W | 230V | ☐

Y | | 375 | ↔ 200 | ↗ 102 |

INOX SYN

IP44

Manhattan

3 | 16234/47/10

PHILIPS 23W INCL.

2x E27 | max. 23W | 230V | ☐

Y | | 774 | ↔ 200 | ↗ 102 |

INOX SYN

IP44

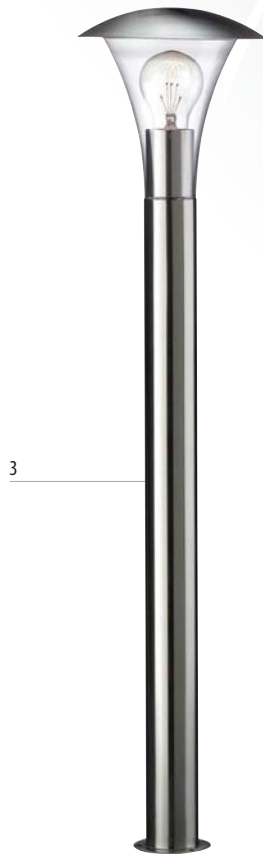

**Beaumont**

■	1   16120/47/10
	1x E27   max. 60W   230V   ⊕
Y	↑ 290   ↔ 182   ↘ 210
	INOX SYN
	IP44

**Beaumont**

■	2   16121/47/10
	1x E27   max. 60W   230V   ⊕
Y	↑ 455   ↔ 182   ↘ 182
	INOX SYN
	IP44

**Beaumont**

■	3   16122/47/10
	1x E27   max. 60W   230V   ⊕
Y	↑ 805   ↔ 182   ↘ 182
	INOX SYN
	IP44

**Bratislava**

■	4   16219/47/10
	1x E27   max. 60W   230V   ⊕
Y	↑ 325   ↔ 275   ↘ 335
	INOX
	IP44

**Bratislava**

■	5   16220/47/10
	1x E27   max. 60W   230V   ⊕
Y	↑ 930   ↔ 225   ↘ 375
	INOX
	IP44

ЭКОНОМЯТ  
энергию



Серия уличных светильников  
378



**Birmingham**

■	1   16190/47/10
	1x E27   max. 20W   230V   ⊕
Y	1 380   ↔ 110   ↘ 230
	INOX SYN
	IP44

**Birmingham**

■	2   16191/47/10
	1x E27   max. 20W   230V   ⊕
Y	1 395   ↔ 110   ↘ 110
	INOX SYN
	IP44

**Birmingham**

■	3   16192/47/10
	1x E27   max. 20W   230V   ⊕
Y	1 795   ↔ 110   ↘ 110
	INOX SYN
	IP44



2



4



Экономят  
энергию



3



1



Utrecht

1 | 1907/01/47

1x E27 | max. 20W | 230V | ⊕

Y | | 400 | ↔ 80 | ↗ 180 |

INOX SYN

IP44

Utrecht

2 | 1908/01/47

1x E27 | max. 20W | 230V | ⊕

Y | | 440 | ↔ 110 | ↗ 110 |

INOX SYN

IP44

Utrecht

3 | 1909/01/47

1x E27 | max. 20W | 230V | ⊕

Y | | 785 | ↔ 110 | ↗ 110 |

INOX SYN

IP44

Utrecht

4 | 1911/01/47

1x E27 | max. 20W | 230V | ⊕

Y | | 415 | ↔ 76 | ↗ 100 |

INOX SYN

IP44 | P.I.R. 140°



Экономят  
энергию



Серия уличных светильников

380



Essex

1 | 16167/47/10

1x E27 | max. 15W | 230V | Ⓢ

Y | | 1 360 | ↔ 90 | ↗ 120 |

INOX SYN

IP44

Essex

2 | 16168/47/10

1x E27 | max. 15W | 230V | Ⓢ

Y | | 1 390 | ↔ 90 | ↗ 90 |

INOX SYN

IP44

Essex

3 | 16169/47/10

1x E27 | max. 15W | 230V | Ⓢ

Y | | 1 800 | ↔ 90 | ↗ 90 |

INOX SYN







IP44









Экономят энергию 









Linz

	1   16314/93/10
	<b>PHILIPS 18W INCL.</b> 1x E27   max. 18W   230V   
	200   ↔ 200   ↗ 85
	
IP44	







Linz

	2   16315/93/10
	<b>PHILIPS 18W INCL.</b> 1x E27   max. 18W   230V   
	200   ↔ 200   ↗ 100
	
IP44   P.I.R. 140°	

Linz

	3   16316/93/10
	<b>PHILIPS 14W INCL.</b> 1x E27   max. 14W   230V   
	400   ↔ 120   ↗ 60
	
IP44	

Linz

	4   16317/93/10
	<b>PHILIPS 14W INCL.</b> 1x E27   max. 14W   230V   
	800   ↔ 120   ↗ 60
	
IP44	



4



1



Серия уличных светильников

2

3



Oslo

■	1   1726/01/93
	1x E27   max. 60W   230V   ☐
Y	1 260   ↔ 235   ↘ 95
	ALU SYN
	IP44

Oslo

■	2   1727/01/93
	1x E27   max. 20W   230V   ⊕
Y	1 405   ↔ 170   ↘ 115
	ALU SYN
	IP44

Oslo

■	3   1728/01/93
	1x E27   max. 20W   230V   ⊕
Y	1 995   ↔ 170   ↘ 115
	ALU SYN
	IP44

Oslo





■	4   17014/93/10
	1x E27   max. 60W   230V   ☐
Y	1 260   ↔ 235   ↘ 95
	ALU SYN
	IP44   P.I.R. 140°







Экономят  
энергию 







Graz

	1   16183/87/10
	<b>PHILIPS 7W INCL.</b> 1x GX53   max. 9W   230V   $\oplus$
	1 50   $\leftrightarrow$ 100   $\nearrow$ 151
	 
	IP44

Graz

	2   16184/87/10
	<b>PHILIPS 7W INCL.</b> 1x GX53   max. 9W   230V   $\oplus$
	1 400   $\leftrightarrow$ 100   $\nearrow$ 152
	 
	IP44

Graz

	3   16185/87/10
	<b>PHILIPS 7W INCL.</b> 1x GX53   max. 9W   230V   $\oplus$
	1 800   $\leftrightarrow$ 100   $\nearrow$ 152
	 
	IP44

massive

2



1

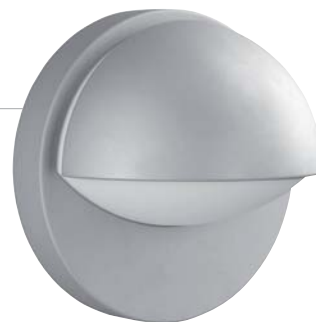

ЭКОНОМЯТ  
энергию



4



3



Серия уличных светильников

384

Reno

1 | 16245/87/10

2 | 16245/93/10

**PHILIPS 12W INCL.**  
1x E27 | max. 12W | 230V |

| 1 195 | ← 195 | ↗ 135 |

ALU SYN

IP44

Reno

3 | 16248/87/10

4 | 16248/93/10

**PHILIPS 12W INCL.**  
1x E27 | max. 12W | 230V |

| 1 799 | ← 191 | ↗ 154 |

ALU SYN

IP44

2



1



Экономят энергию 

4









3







Серия уличных светильников

385

Sydney

	1   16251/87/10
	2   16251/93/10
	<b>PHILIPS 14W INCL.</b> 1x E27   max. 14W   230V   
	I 242   ↔ 90   ↗ 134
	
IP44	

Sydney

	3   16252/87/10
	4   16252/93/10
	<b>PHILIPS 18W INCL.</b> 1x E27   max. 18W   230V   
	I 500   ↔ 181   ↗ 91
	
IP44	

1



2



ЭКОНОМЯТ  
энергию

3



5



4



Durban

1 | 17105/87/10

2 | 17105/93/10

PHILIPS 9W INCL.  
2x G23 | max. 9W | 230V | ⊕

Y | | 113 | ↔ 290 | ↗ 130 |

ALU SYN

IP44

Basel

3 | 17130/87/10

1x E27 | max. 27W | 230V | ⊕

Y | | 75 | ↔ 356 | ↗ 93 |

ALU SYN

IP44

Chicago

4 | 17183/87/10

PHILIPS 14W INCL.  
1x E27 | max. 14W | 230V | ⊕

Y | | 213 | ↔ 161 | ↗ 132 |

ALU SYN

IP44

Chicago

5 | 17184/87/10

PHILIPS 14W INCL.  
2x E27 | max. 14W | 230V | ⊕

Y | | 260 | ↔ 260 | ↗ 81 |

ALU SYN

IP44





## Basel

1 | 17130/93/10

1x E27 | max. 27W | 230V | ⊕

Y | 175 | ← 356 | ↗ 93 |

ALU SYN

IP44

1



2



3

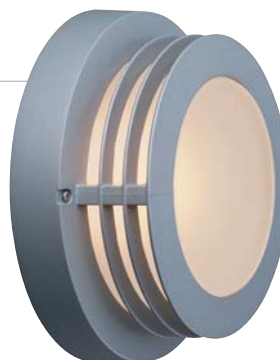

5



4



**Boston**

■	1   1302/01/30
□	2   1302/01/31
	1x E27   max. 60W   230V   ☐
Y	↑ 200   ↔ 200   ↘ 140
	ALU   🚚
	IP44

**Karachi**

■	3   17021/87/10
■	4   17021/93/10
	1x E27   max. 60W   230V   ☐
Y	↑ 85   ↔ 195   ↘ 195
	ALU   🚚
	IP44

**Manchester**

■	5   17150/47/10
	1x E27   max. 60W   230V   ☐
Y	↑ 194   ↔ 194   ↘ 137
	INOX   🚚
	IP44





1



2



3



4



### Dublin

■ 1 | 1465/01/30

□ 2 | 1465/01/31

1x E27 | max. 60W | 230V | ☐

Y | | 1260 | ↔ 185 | ↗ 105 |

ALU SYN

IP44

### Helsinki

■ 3 | 17177/87/10

⊙ PHILIPS 7W INCL.

1x GX53 | max. 7W | 230V | ⊕

Y | | 140 | ↔ 140 | ↗ 50 |

SYN

IP44

### Talinn

■ 4 | 17178/87/10

⊙ PHILIPS 7W INCL.

1x GX53 | max. 7W | 230V | ⊕

Y | | 140 | ↔ 140 | ↗ 50 |

SYN

IP44



1



2



### Santiago

1 | 15320/86/10



PHILIPS 14W INCL.

1x E27 | max. 14W | 230V | Ⓢ



| 1 309 | ↔ 240 | ↙ 270 |

ALU SYN

IP44

### Santiago

2 | 15323/86/10



PHILIPS 14W INCL.

1x E27 | max. 14W | 230V | Ⓢ



| 1 1082 | ↔ 240 | ↙ 240 |

ALU SYN

IP44



Palermo

- 1 | 1816/01/42
- 2 | 1816/01/45

1x E27 | max. 60W | 230V | Ⓢ

Y | | 290 | ↔ 300 | ↗ 350 |



IP44

Samara

- 3 | 16270/86/10

1x E27 | max. 60W | 230V | Ⓢ

Y | | 303 | ↔ 300 | ↗ 355 |



IP44

Samara

- 4 | 16271/86/10

1x E27 | max. 60W | 230V | Ⓢ

Y | | 663 | ↔ 300 | ↗ 300 |



IP44

Arad

- 5 | 17207/87/10



PHILIPS 15W INCL.

1x E27 | max. 15W | 230V | Ⓢ

Y | | 200 | ↔ 250 | ↗ 300 |



IP44



Sofia

■	1   15211/42/10
	1x E27   max. 100W   230V   ⊕
Y	1 306   ↔ 320   ↗ 382
	ALU SYN
	IP44

Sofia

■	2   15213/42/10
	1x E27   max. 100W   230V   ⊕
Y	1 1247   ↔ 320   ↗ 463
	ALU SYN
	IP44

Sofia

■	3   15215/42/10
	3x E27   max. 100W   230V   ⊕
Y	1 2025   ↔ 780   ↗ 780
	ALU SYN
	IP44

Sofia

■	4   15216/42/10
	1x E27   max. 60W   230V   ⊕
Y	1 658   ↔ 320   ↗ 320
	ALU SYN
	IP44

Экономят  
энергию



серия уличных светильников

393

Coventry

1 | 15261/42/10

**PHILIPS 23W INCL.**  
1x E27 | max. 23W | 230V | ⊕

| 1 309 | ← 160 | ↗ 246 |

ALU SYN

IP44

Coventry

2 | 15263/42/10

**PHILIPS 23W INCL.**  
1x E27 | max. 23W | 230V | ⊕

| 1 1060 | ← 160 | ↗ 287 |

ALU SYN

IP44

Coventry

3 | 15265/42/10

**PHILIPS 23W INCL.**  
3x E27 | max. 23W | 230V | ⊕

| 1 1997 | ← 471 | ↗ 429 |

ALU SYN

IP44

Coventry

4 | 15266/42/10

**PHILIPS 23W INCL.**  
1x E27 | max. 23W | 230V | ⊕

| 1 682 | ← 160 | ↗ 160 |

ALU SYN

IP44





Серия уличных светильников  
394

## Narbonne

■ 1 | 15205/86/10

3x E27 | max. 100W | 230V | Ⓢ

Y | 1 2175 | ← 700 | ↗ 700 |



IP43





**Narbonne**

■	1   15201/86/10
	1x E27   max. 100W   230V   ⊕
Y	↑ 590   ↔ 235   ↘ 265
	ALU
	IP43

**Narbonne**

■	2   15202/86/10
	1x E27   max. 100W   230V   ⊕
Y	↑ 720   ↔ 240   ↘ 240
	ALU
	IP44

**Narbonne**

■	3   15206/86/10
	1x E27   max. 60W   230V   ⊕
Y	↑ 1390   ↔ 235   ↘ 235
	ALU
	IP43



2



1



3



4



Murcia

■	1   15221/86/10
	1x E27   max. 100W   230V   ⊕
Y	1 340   ↔ 160   ↘ 195
	ALU
	IP44

Murcia

■	2   15226/86/10
	1x E27   max. 100W   230V   ⊕
Y	1 340   ↔ 160   ↘ 195
	ALU
	IP44

Istanbul

■	3   15401/86/10
	1x E27   max. 60W   230V   ⊕
Y	1 360   ↔ 180   ↘ 230
	ALU
	IP44

Istanbul

■	4   15403/86/10
	1x E27   max. 60W   230V   ⊕
Y	1 195   ↔ 180   ↘ 180
	ALU
	IP44

1



2



4



3



Algiers

■	1   16188/42/10
	1x E27   max. 60W   230V   ⊕
Y	1 446   ← 123   ↗ 187
	ALU SYN
	IP44

Algiers

■	2   16189/42/10
	1x E27   max. 60W   230V   ⊕
Y	1 775   ← 141   ↗ 141
	ALU SYN
	IP44

Split

■	3   16260/54/10
	1x E27   max. 60W   230V   ⊕
Y	1 325   ← 205   ↗ 220
	ALU
	IP44

Split

■	4   16261/54/10
	1x E27   max. 60W   230V   ⊕
Y	1 280   ← 205   ↗ 220
	ALU
	IP44



Серия уличных светильников

398



Paris

■	1   15383/30/10
	1x E27   max. 60W   230V   Ⓢ
Y	1 995   ↔ 175   ↙ 175
	ALU SYN
	IP44

Paris

■	2   15385/30/10
	3x E27   max. 60W   230V   Ⓢ
Y	1 840   ↔ 480   ↙ 450
	ALU SYN
	IP44

4



1



3



2



Paris

■	1   15380/30/10
	1x E27   max. 60W   230V   ⊕
Y	↑ 235   ↔ 175   ↘ 200
	ALU SYN
	IP44

Paris

■	2   15381/30/10
	1x E27   max. 60W   230V   ⊕
Y	↑ 240   ↔ 175   ↘ 200
	ALU SYN
	IP44

Paris

■	3   15382/30/10
	1x E27   max. 60W   230V   ⊕
Y	↑ 300   ↔ 175   ↘ 175
	ALU SYN
	IP44

Paris

■	4   15386/30/10
	1x E27   max. 60W   230V   ⊕
Y	↑ 820   ↔ 175   ↘ 175
	ALU SYN
	IP44



**Paris**

<input type="checkbox"/>	1   15380/31/10
	1x E27   max. 60W   230V   ⊕
Y	1235   ↔ 175   ↗ 200
	<input type="checkbox"/> ALU <input type="checkbox"/> SYN
	IP44

**Paris**

<input type="checkbox"/>	2   15386/31/10
	1x E27   max. 60W   230V   ⊕
Y	1820   ↔ 175   ↗ 175
	<input type="checkbox"/> ALU <input type="checkbox"/> SYN
	IP44

**Paris**

<input type="checkbox"/>	3   15387/31/10
	1x E27   max. 60W   230V   ⊕
Y	1195   ↔ 180   ↗ 130
	<input type="checkbox"/> ALU <input type="checkbox"/> SYN
	IP44



Paris

<input type="checkbox"/>	1   15382/31/10
	1x E27   max. 60W   230V   ⊕
	↑ 300   ↔ 175   ↙ 175
	<input type="checkbox"/> ALU <input type="checkbox"/> SYN
	IP44

Paris

<input type="checkbox"/>	2   15383/31/10
	1x E27   max. 60W   230V   ⊕
	↑ 995   ↔ 175   ↙ 175
	<input type="checkbox"/> ALU <input type="checkbox"/> SYN
	IP44

Paris

<input type="checkbox"/>	3   15385/31/10
	3x E27   max. 60W   230V   ⊕
	↑ 1840   ↔ 480   ↙ 450
	<input type="checkbox"/> ALU <input type="checkbox"/> SYN
	IP44



2



1



Серия уличных светильников

402

4



3



Chartres

1 | 15390/42/10

2 | 15390/54/10

1x E27 | max. 60W | 230V | Ⓢ

Y | | 1 265 | ← 160 | ↘ 190 |

ALU SYN

IP44

Chartres

3 | 15392/42/10

4 | 15392/54/10

1x E27 | max. 60W | 230V | Ⓢ

Y | | 1 360 | ← 170 | ↘ 170 |

ALU SYN

IP44





4



3



1



2

Reims

■	1   15350/30/10
	1x E27   max. 60W   230V   ⊕
Y	↑ 346   ↔ 175   ↘ 235
	ALU
	IP44

Reims

■	2   15352/30/10
	1x E27   max. 60W   230V   ⊕
Y	↑ 385   ↔ 200   ↘ 200
	ALU
	IP44

Reims

■	3   15355/30/10
	3x E27   max. 60W   230V   ⊕
Y	↑ 1850   ↔ 560   ↘ 560
	ALU
	IP44

Reims

■	4   15356/30/10
	1x E27   max. 60W   230V   ⊕
Y	↑ 935   ↔ 205   ↘ 205
	ALU
	IP44



Toulouse

■	1   15332/54/10
	1x E27   max. 60W   230V   ⊕
Y	1 430   ↔ 203   ↗ 203
	ALU
	IP44

Toulouse

■	2   15335/54/10
	3x E27   max. 60W   230V   ⊕
Y	1 2180   ↔ 600   ↗ 600
	ALU
	IP44

Toulouse

■	3   15336/54/10
	1x E27   max. 60W   230V   ⊕
Y	1 800   ↔ 203   ↗ 203
	ALU
	IP44



2



1



3

Toulouse

■	1   15330/54/10
	1x E27   max. 60W   230V   ⊕
Y	1 415   ↔ 203   ↗ 310
	ALU
	IP44

Toulouse

■	2   15331/54/10
	1x E27   max. 60W   230V   ⊕
Y	1 425   ↔ 203   ↗ 310
	ALU
	IP44

Toulouse

■	3   15338/54/10
	1x E27   max. 60W   230V   ⊕
Y	1 455   ↔ 203   ↗ 310
	ALU
	IP44   P.I.R. 140°



Серия уличных светильников

406

**Bridgeport**

■	1   15280/54/10
	1x E27   max. 60W   230V   ⊕
Y	1 235   ← 140   ↘ 197
	ALU SYN
	IP44

**Bridgeport**

■	2   15282/54/10
	1x E27   max. 60W   230V   ⊕
Y	1 471   ← 153   ↘ 153
	ALU SYN
	IP44

**Bridgeport**

■	3   15283/54/10
	1x E27   max. 60W   230V   ⊕
Y	1 1041   ← 153   ↘ 153
	ALU SYN
	IP44





Monastir

1   15190/86/10
1x E27   max. 100W   230V   ⊕
Y     435   ← 150   ↗ 190
ALU
IP43

Monastir

2   15191/86/10
1x E27   max. 100W   230V   ⊕
Y     340   ← 150   ↗ 190
ALU
IP43

Monastir

3   15192/86/10
1x E27   max. 100W   230V   ⊕
Y     485   ← 150   ↗ 150
ALU
IP43

Monastir

4   15193/86/10
1x E27   max. 100W   230V   ⊕
Y     1260   ← 150   ↗ 150
ALU
IP43

Monastir

5   15196/86/10
1x E27   max. 60W   230V   ⊕
Y     900   ← 150   ↗ 150
ALU
IP43



Серия уличных светильников

408



1



3

### München

■ 1 | 15170/42/10

1x E27 | max. 100W | 230V | Ⓢ

Y | | 1 450 | ← 180 | ↘ 260 |



IP44

### München

■ 2 | 15171/42/10

1x E27 | max. 100W | 230V | Ⓢ

Y | | 1 460 | ← 180 | ↘ 260 |



IP44

### München

■ 3 | 15172/42/10

1x E27 | max. 100W | 230V | Ⓢ

Y | | 1 450 | ← 180 | ↘ 180 |



IP44





München

1	15173/42/10
	1x E27   max. 100W   230V   Ⓢ
Y	↑ 1240   ↔ 180   ↘ 180
	ALU
	IP44

München





2	15175/42/10
	3x E27   max. 100W   230V   Ⓢ
Y	↑ 2080   ↔ 610   ↘ 610
	ALU
	IP44

München





3	15176/42/10
	1x E27   max. 60W   230V   Ⓢ
Y	↑ 980   ↔ 180   ↘ 180
	ALU
	IP44







**Koblentz**

	1   15362/42/10
	1x E27   max. 60W   230V   ⊕
	1 400   ↔ 175   ↗ 175
	
	IP44

**Koblentz**

	2   15365/42/10
	3x E27   max. 60W   230V   ⊕
	1 2000   ↔ 560   ↗ 560
	
	IP44

**Koblentz**

	3   15366/42/10
	1x E27   max. 60W   230V   ⊕
	1 935   ↔ 150   ↗ 150
	
	IP44







2







1

**Koblenz**

	1   15360/42/10
	1x E27   max. 60W   230V   ⊕
	↑ 330   ↔ 150   ↗ 205
	ALU
	IP44

**Koblenz**

	2   15361/42/10
	1x E27   max. 60W   230V   ⊕
	↑ 355   ↔ 150   ↗ 205
	ALU
	IP44



1



4



2

3



Lima

■ 1 | 71426/01/30

□ 2 | 71426/01/31

1x E27 | max. 60W | 230V | ⊕

Y | | 1 355 | ← 150 | ↘ 205 |



IP44

Lima

■ 3 | 71427/01/30

1x E27 | max. 60W | 230V | ⊕

Y | | 1 400 | ← 175 | ↘ 175 |



IP44

Lima

■ 4 | 71427/03/30

3x E27 | max. 60W | 230V | ⊕

Y | | 1 2000 | ← 560 | ↘ 560 |



IP44

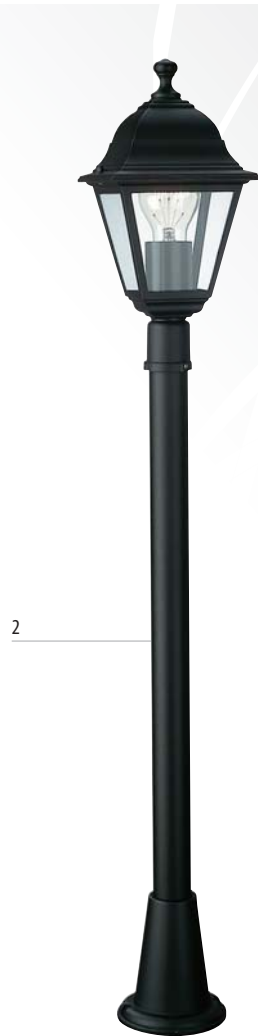
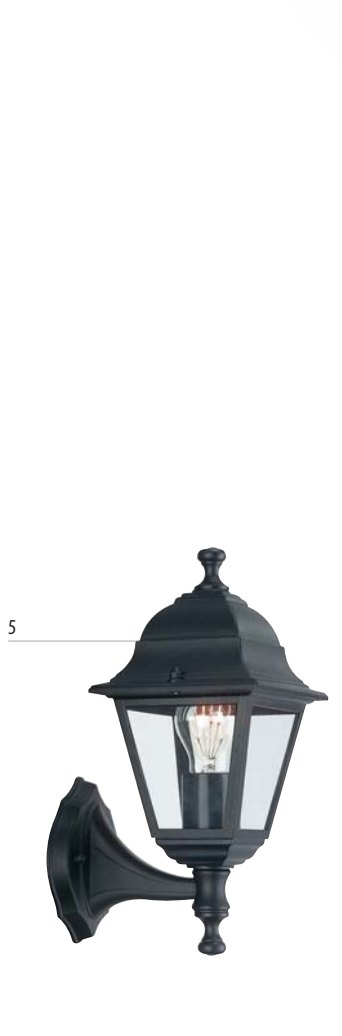

**Napels**

■	1   1304/01/30
1x E27   max. 100W   230V   ☐	
Y	1 365   ↔ 255   ↘ 125
ALU	SYN
IP44	

**Lima**

■	2   71421/01/30
1x E27   max. 60W   230V   ⊕	
Y	1 810   ↔ 150   ↘ 150
ALU	☑
IP44	

**Lima**

■	3   71424/01/30
□	4   71424/01/31
1x E27   max. 60W   230V   ⊕	
Y	1 290   ↔ 150   ↘ 150
ALU	☑
IP44	

**Lima**

■	5   71425/01/30
□	6   71425/01/31
1x E27   max. 60W   230V   ⊕	
Y	1 330   ↔ 150   ↘ 205
ALU	☑
IP44	





### Zagreb

■ 1 | 15020/42/10

1x E27 | max. 100W | 230V | Ⓢ

Y | | 1 515 | ↔ 205 | ↗ 285 |



IP44

### Zagreb

■ 2 | 15021/42/10

1x E27 | max. 100W | 230V | Ⓢ

Y | | 1 515 | ↔ 205 | ↗ 285 |



IP44

### Zagreb

■ 3 | 15022/42/10

1x E27 | max. 100W | 230V | Ⓢ

Y | | 1 515 | ↔ 230 | ↗ 230 |



IP44

### Zagreb

■ 4 | 15023/42/10

1x E27 | max. 100W | 230V | Ⓢ

Y | | 1 1250 | ↔ 230 | ↗ 230 |



IP44





1



2



3

### Zagreb

1 | 15024/42/10

1x E27 | max. 100W | 230V | Ⓢ

Y | | 2000 | → 230 | ↗ 230 |



IP44

### Zagreb

2 | 15025/42/10

3x E27 | max. 100W | 230V | Ⓢ

Y | | 2250 | → 600 | ↗ 600 |



IP44

### Zagreb

3 | 15026/42/10

1x E27 | max. 60W | 230V | Ⓢ

Y | | 1000 | → 230 | ↗ 230 |



IP44



1



2



3



4

### Zagreb

■	1   15020/54/10
	1x E27   max. 100W   230V   ⊕
Y	1 515   ↔ 205   ↘ 285
	ALU 
	IP44

### Zagreb

■	2   15021/54/10
	1x E27   max. 100W   230V   ⊕
Y	1 515   ↔ 205   ↘ 285
	ALU 
	IP44

### Zagreb

■	3   15022/54/10
	1x E27   max. 100W   230V   ⊕
Y	1 515   ↔ 230   ↘ 230
	ALU 
	IP44

### Zagreb

■	4   15023/54/10
	1x E27   max. 100W   230V   ⊕
Y	1 1250   ↔ 230   ↘ 230
	ALU 
	IP44



1



2



3

### Zagreb

1 | 15024/54/10

1x E27 | max. 100W | 230V | ⊕

Y | | 2000 | → 230 | ↗ 230 |



IP44

### Zagreb

2 | 15025/54/10

3x E27 | max. 100W | 230V | ⊕

Y | | 2250 | → 600 | ↗ 600 |



IP44

### Zagreb

3 | 15026/54/10

1x E27 | max. 60W | 230V | ⊕

Y | | 1000 | → 230 | ↗ 230 |



IP44



418



Dubrovnik

■	1   15030/45/10
	1x E27   max. 100W   230V   ⊕
Y	1 500   ↔ 170   ↘ 245
	ALU SYN
	IP44

Dubrovnik

■	2   15031/45/10
	1x E27   max. 100W   230V   ⊕
Y	1 500   ↔ 170   ↘ 250
	ALU SYN
	IP44

Dubrovnik

■	3   15032/45/10
	1x E27   max. 100W   230V   ⊕
Y	1 500   ↔ 170   ↘ 170
	ALU SYN
	IP44

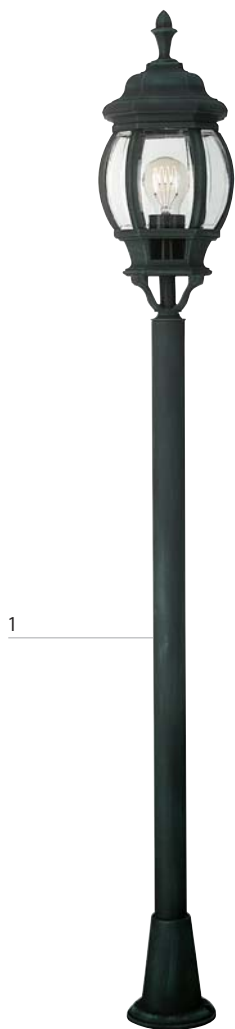

Dubrovnik

1 | 15033/45/10

1x E27 | max. 100W | 230V | ⊕

Y | | 1250 | ← 170 | ↗ 170 |

ALU SYN

IP44



Dubrovnik

2 | 15035/45/10

3x E27 | max. 100W | 230V | ⊕

Y | | 2250 | ← 600 | ↗ 600 |

ALU SYN

IP44



Dubrovnik

3 | 15036/45/10

1x E27 | max. 60W | 230V | ⊕

Y | | 1015 | ← 170 | ↗ 170 |

ALU SYN

IP44





**New Haven**

	1   15270/86/10
	1x E27   max. 60W   230V   Ⓢ
	1 290   ↔ 143   ↘ 200
	IP44

**New Haven**

	2   15272/86/10
	1x E27   max. 60W   230V   Ⓢ
	1 468   ↔ 166   ↘ 166
	IP44

**New Haven**

	3   15277/86/10
	1x E27   max. 60W   230V   Ⓢ
	1 294   ↔ 203   ↘ 120
	IP44



1



3



2



Cádiz

1 | 17131/42/10

1x E27 | max. 60W | 230V | ☐

Y | | 1 260 | ↔ 230 | ↗ 92 |

ALU SYN

IP44

Cádiz

2 | 17131/86/10

1x E27 | max. 60W | 230V | ☐

Y | | 1 260 | ↔ 230 | ↗ 92 |

ALU SYN

IP44

Calgary

3 | 17173/06/10



PHILIPS 12W INCL.

1x E14 | max. 12W | 230V | ☐

Y | | 1 200 | ↔ 176 | ↗ 93 |

INOX

IP44

3  
 



1  





2  



### Portsmouth

 1 | 17118/04/10

1x E27 | max. 60W | 230V | 

 | ↑ 252 | ↔ 252 | ↘ 96 |

 

IP44

### Chicago

 2 | 17183/86/10

 **PHILIPS 14W INCL.**  
 1x E27 | max. 14W | 230V | 



 | ↑ 213 | ↔ 161 | ↘ 132 |

 

IP44

### Chicago

 3 | 17184/86/10

 **PHILIPS 14W INCL.**  
 2x E27 | max. 14W | 230V | 

 | ↑ 81 | ↔ 260 | ↘ 260 |

IP44

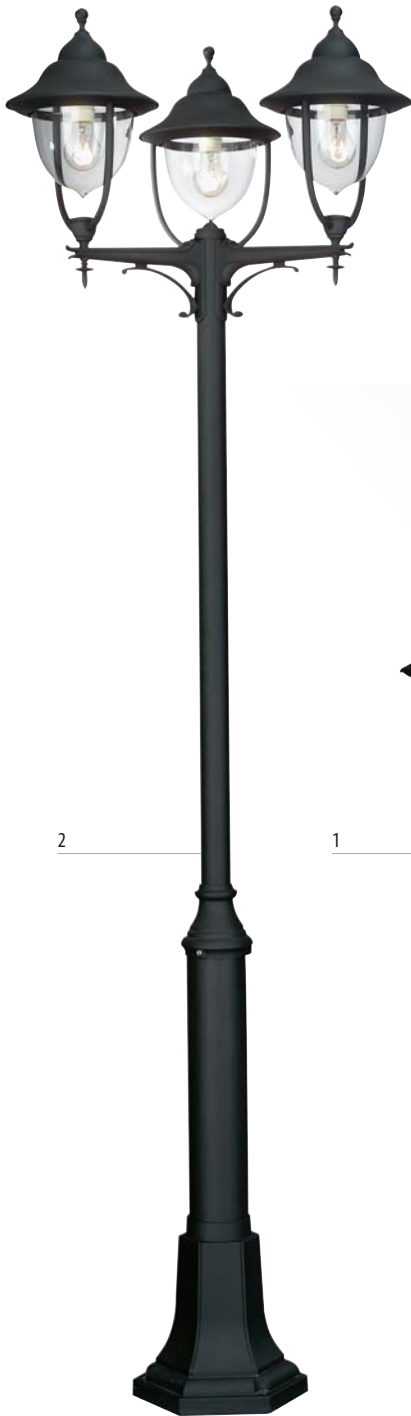

**Budapest**

■ 1 | 1623/01/30

1x E27 | max. 60W | 230V | ⊕

Y | | 1270 | ↔ 250 | ↗ 250 |

ALU SYN

IP44

**Budapest**

■ 2 | 1624/03/30

3x E27 | max. 60W | 230V | ⊕

Y | | 1275 | ↔ 650 | ↗ 650 |

ALU SYN

IP44

**Manila**

■ 3 | 17103/86/10



**PHILIPS 40W INCL.**

2x G9 | max. 40W | 230V | ⊕

Y | | 705 | ↔ 115 | ↗ 160 |

ALU

IP44

**Salvador**

■ 4 | 17156/42/10



**2x 50W INCL. + 2x 7W INCL.**

2x GU10 | max. 50W | 230V | ⊕

Y | | 190 | ↔ 74 | ↗ 116 |

ALU

IP44

**Santos**

■ 5 | 17157/54/10

1x E27 | max. 11W | 230V | ⊕

Y | | 518 | ↔ 76 | ↗ 116 |

ALU

IP44



3



4



5



6



**Bari**

1 | 17202/87/10

PHILIPS 18W INCL.

2x E27 | max. 18W | 230V |

| T 98 | ↔ 316 | ↗ 316 |



IP44

**Bari**

2 | 17203/87/10

PHILIPS 18W INCL.

2x E27 | max. 18W | 230V |

| T 98 | ↔ 316 | ↗ 316 |



IP44

**Sunderland**

3 | 71410/01/30

4 | 71410/01/31

1x E27 | max. 60W | 230V |

| T 105 | ↔ 275 | ↗ 150 |



IP65

**Casablanca**

5 | 71416/01/30

6 | 71416/01/31

1x E27 | max. 75W | 230V |

| T 100 | ↔ 270 | ↗ 270 |



IP54



### Cleveland

□ 1 | 17090/31/10

■ 2 | 17090/87/10

1x E27 | max. 40W | 230V | Ⓢ

Y | 1143 | ↔ 214 | ↗ 105 |

ALU SYN

IP44

### Denver

■ 3 | 17170/30/10

■ 4 | 17170/87/10

PHILIPS 9W INCL.

1x G23 | max. 9W | 230V | Ⓢ

Y | 1110 | ↔ 250 | ↗ 105 |

SYN

IP44



Bali

1 | 16007/65/10

1x E27 | max. 60W | 230V | ☐

Y | | 1460 | ↔ 200 | ↗ 200 |



IP44

Bali

2 | 16008/65/10

1x E27 | max. 60W | 230V | ☐

Y | | 1985 | ↔ 205 | ↗ 205 |



IP44

Bali

☐ 3 | 71825/01/31

■ 4 | 71825/01/65

1x E27 | max. 60W | 230V | ☐

Y | | 1265 | ↔ 200 | ↗ 265 |



IP44

Sussex

■ 5 | 81657/01/30

☐ 6 | 81657/01/31

1x E27 | max. 60W | 230V | ☐

Y | | 1180 | ↔ 125 | ↗ 110 |



IP44



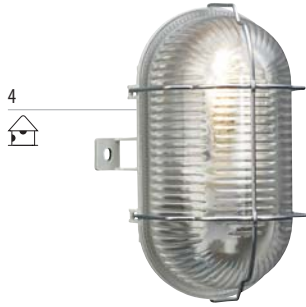

Dakota

1 | 17187/30/10

**PHILIPS 23W INCL.**  
2x E27 | max. 23W | 230V | ⊕

| 110 | ↔ 255 | ↗ 280 |



IP44

Dakota

2 | 17189/30/10

**PHILIPS 23W INCL.**  
2x E27 | max. 23W | 230V | ⊕

| 1400 | ↔ 270 | ↗ 250 |



IP44

Lagos

3 | 17515/87/10

**PHILIPS 23W INCL.**  
2x E27 | max. 23W | 230V | ⊕

| 1402 | ↔ 166 | ↗ 98 |



IP44

Bremen

4 | 81626/01/87

1x E27 | max. 60W | 230V | ⊕

| 180 | ↔ 135 | ↗ 95 |



IP44

massive

2



3



Экономят энергию

1



4



5



Серия уличных светильников

428

Faro

1 | 74900/21/30

2 | 74900/21/31

**PHILIPS Ecohalo 350W INCL.**  
1x R7S 118 | max. 500W | 230V | Ⓢ

| 1195 | ← 185 | ↗ 145 |



IP44

Faro

3 | 74902/21/30

4 | 74902/21/31

**PHILIPS Ecohalo 105W INCL.**  
1x R7S 78 | max. 150W | 230V | Ⓢ

| 1145 | ← 140 | ↗ 115 |



IP44

Faro

5 | 74904/21/30

**PHILIPS Ecohalo 350W INCL.**  
1x R7S 118 | max. 500W | 230V | Ⓢ

| 1310 | ← 220 | ↗ 210 |





### Faro

<input checked="" type="checkbox"/>	1   74943/21/30
<input type="checkbox"/>	2   74943/21/31
	<b>PHILIPS Ecohalo 350W INCL.</b> 1x R7S 118   max. 500W   230V   ⊕
	↑ 250   ↔ 185   ↗ 135
IP44   P.I.R. 140°	

### Faro

<input type="checkbox"/>	3   74946/21/31
	<b>PHILIPS Ecohalo 105W INCL.</b> 1x R7S 78   max. 150W   230V   ⊕
	↑ 200   ↔ 140   ↗ 120
IP44   P.I.R. 140°	

### Virginia

<input checked="" type="checkbox"/>	4   87098/12/30
<input type="checkbox"/>	5   87098/12/31
	↑ 94   ↔ 70   ↗ 104
IP44   P.I.R. 140°	



Серия уличных светильников  
430

**Acapulco**

1	17020/47/10
	1x E27   max. 20W   230V   □
Y	← 175   ⊕ 175   ⊥ 323
	INOX SYN
	IP67

**Adelaide**

2	17068/87/10
	PHILIPS 9W INCL.
	1x G23   max. 9W   230V   ⊖
Y	⊥ 125   ← 232   ↗ 60
	ALU
	IP44

**Brisbane**

3	17069/87/10
	PHILIPS 9W INCL.
	1x G23   max. 9W   230V   ⊖
Y	⊥ 125   ← 230   ↗ 60
	ALU
	IP44

**Acapulco**

4	71428/01/30
	1x E27   max. 40W   230V   □
Y	← 175   ⊕ 175   ⊥ 323
	SYN
	IP67



2



Экономят  
энергию



3

3 set LED



1

3 set LED



4

3 set LED



### Jakarta

1 | 17067/17/10

LED 0,6W INCL. | 6-LED

3x LED | max. 0,6W | 230V-12V |

| ↔ 115 | Ⓢ 93 | ⊥ 110 |

ALU SYN

IP67 | 16,5m

### Brooklyn

2 | 17074/47/50

7W INCL.

1x GU10 | max. 7W | 230V |

| ↔ 105 | Ⓢ 105 | ⊥ 222 |

INOX SYN

IP67

### Bedford

3 | 17079/47/10

LED 0,24W INCL. | 4-LED

3x LED | max. 0,24W | 230V-12V |

| ↔ 95 | Ⓢ 95 | ⊥ 65 |

INOX SYN

IP67 | 10m

### Montevideo

4 | 17179/48/10

LED 1W INCL. | 12-LED

3x LED | max. 1W | 230V-12V |

| ↔ 70 | Ⓢ 20 | ⊥ 1 |

ALU SYN

IP67 | 14m





# Светильники направленного освещения

---



# Светильники направленного освещения

## Ничего кроме безграничных возможностей

*Встраиваемые светильники акцентного освещения Massive доступны в широком выборе цветов, форм, размеров и уровней мощности, а также можно выбрать между обычным и декоративным освещением. В обширной коллекции Massive можно подобрать идеальные встраиваемые светильники для любого интерьера.*

Помимо дизайна и функциональности, для компании Massive ключевым приоритетом является удобство для пользователя. Это выражается в создании продуманных инженерных конструкций и написании наглядных руководств с четкими инструкциями по сборке и установке встраиваемых светильников, что позволяет проводить такие процедуры безупречным образом. Помимо этого, мы даем рекомендации по выбору наиболее подходящего для вас светильника.

### ВЫБОР ИДЕАЛЬНОГО ВСТРАИВАЕМОГО СВЕТИЛЬНИКА

#### **Выберите источник света**

Независимо от того, выберете ли вы яркие галогенные лампы или энергосберегающие лампы EcoPower, все встраиваемые светильники Massive поставляются с лампами Philips. Это гарантирует высокое качество и экономию энергии, а также оптимальную мощность светового излучения.

#### **Сделайте выбор между направленными или фиксированными светильниками**

Компания Massive предлагает возможность выбора между фиксированными и направляемыми встраиваемыми светильниками. Фиксированные светильники идеальны для общего освещения, в то время как направляемые хорошо подходят для акцентного освещения.

#### **Проверьте размеры для встройки**

Размер выреза. В упаковке и руководстве четко указаны параметры отверстия в потолке, которые необходимо предусмотреть.

Минимальное расстояние между светильниками. Не размещайте светильники слишком близко друг к другу. Минимальное расстояние указано на упаковке и в руководстве.

Глубина встройки. Убедитесь, что в (подвесном) потолке имеется столько необходимого места, сколько указано на упаковке. Значение имеет не только полная встройка светильника в потолок, но и возможность его охлаждения благодаря циркуляции воздуха.

#### **Проверьте, требуется ли трансформатор**

Трансформаторы необходимы только для светильников на 12V и обычно поставляются вместе с изделием. Внимательно проверьте упаковку.



1



## Liquido

■ 1 | 59552/17/10

⚡ **PHILIPS 50W INCL.**

2x GU10 | max. 50W | 230V | ☑

Y | ↔ 210 | 2x Ⓢ 100 | ⊥ 140 |

MET

IP23



### Liquido

■	1   59550/17/10
□	2   59550/31/10
⚡	<b>PHILIPS 50W INCL.</b> 1x GU10   max. 50W   230V   ☐
↔	← 110   Ⓢ 100   ⊥ 140
MEY	
IP23	

### Liquido

□	3   59552/31/10
⚡	<b>PHILIPS 50W INCL.</b> 2x GU10   max. 50W   230V   ☐
↔	← 210   2x Ⓢ 100   ⊥ 140
MEY	
IP23	

### Liquido

■	4   59553/17/10
□	5   59553/31/10
⚡	<b>PHILIPS 50W INCL.</b> 3x GU10   max. 50W   230V   ☐
↔	← 310   3x Ⓢ 100   ⊥ 140
MEY	
IP23	



Artemis

■	1   59303/17/10
☏	PHILIPS 50W INCL.
	3x GU10   max. 50W   230V   ☐
Y	← 280   3x Ⓢ 92   ⊥ 150
	MET
	IP23

Artemis

■	2   59304/17/10
☏	PHILIPS 50W INCL.
	4x GU10   max. 50W   230V   ☐
Y	← 188   4x Ⓢ 92   ⊥ 150
	MET
	IP23





Artemis

■	1   59300/17/10
⚡	<b>PHILIPS 50W INCL.</b> 1x GU10   max. 50W   230V   □
↔	↔ 100   Ⓢ 92   ⊥ 150
■	MET
	IP23

Artemis

■	2   59302/17/10
⚡	<b>PHILIPS 50W INCL.</b> 2x GU10   max. 50W   230V   □
↔	↔ 188   2x Ⓢ 92   ⊥ 150
■	MET
	IP23

Apollo

■	3   59500/48/10
⚡	<b>PHILIPS 35W INCL.</b> 1x GU10   max. 35W   230V   □
↔	↔ 85   Ⓢ 75   ⊥ 110
■	ALU
	IP23

Apollo

■	4   59502/48/10
⚡	<b>PHILIPS 35W INCL.</b> 2x GU10   max. 35W   230V   □
↔	↔ 150   2x Ⓢ 70   ⊥ 110
■	ALU
	IP23

2



1

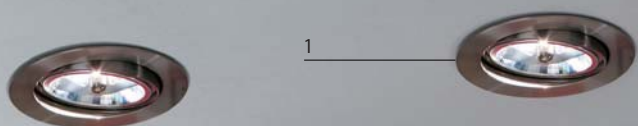

3



4



### Savio

■ 1 | 59040/17/10

⚡ 50W INCL.

1x G53 | max. 50W | 230V 12V |

Y | ↔ 167 | Ⓢ 155 | ⊥ 80 |



IP23

### Savio

■ 2 | 59042/17/10

⚡ 35W INCL.

2x G53 | max. 35W | 230V 12V |

Y | ↔ 327 | Ⓢ 155 x 315 | ⊥ 110 |



IP23

### Galea

■ 3 | 59410/17/10

⚡ PHILIPS 50W INCL.

1x GU10 | max. 50W | 230V | □

Y | ↔ 100 | Ⓢ 80 | ⊥ 150 |



IP23

### Rufa

■ 4 | 59420/17/10

⚡ PHILIPS 50W INCL.

1x GU10 | max. 50W | 230V | □

Y | ↔ 100 | Ⓢ 80 | ⊥ 150 |



IP23

2



1



Sapphire

■	1   59560/11/10
⚡	<b>PHILIPS 50W INCL.</b>
	1x GU10   max. 50W   230V   ☐
↔	↔ 100   Ⓢ 95   ⊥ 110
Ⓜ	Ⓜ
IP23	

Sapphire

■	2   59562/11/10
⚡	<b>PHILIPS 50W INCL.</b>
	2x GU10   max. 50W   230V   ☐
↔	↔ 190   2x Ⓢ 95   ⊥ 110
Ⓜ	Ⓜ
IP23	

Sapphire

■	3   59563/11/10
⚡	<b>PHILIPS 50W INCL.</b>
	3x GU10   max. 50W   230V   ☐
↔	↔ 280   3x Ⓢ 95   ⊥ 140
Ⓜ	Ⓜ
IP23	



### Allegro

1 | 59350/17/50

 **PHILIPS 35W INCL.**

1x GU10 | max. 35W | 230V | 

 | ↔ 90 | Ⓢ 64 | ⊥ 120 |



IP23

### Bonzi

2 | 59530/17/10

 **PHILIPS 35W INCL.**

1x GU10 | max. 35W | 230V | 

 | ↔ 117 | Ⓢ 100 | ⊥ 120 |





### Bolar

1 | 59515/30/10

2 | 59515/60/10

3 | 59515/67/10

 **PHILIPS 50W INCL.**

1x GU10 | max. 50W | 230V | 

 | ↔ 90 | Ⓢ 65 | ⊥ 150 |



IP23

### Glory

4 | 59763/11/10

 **20W INCL.**

3x G4 | max. 20W | 230V 12V | 

 | ↔ 80 | Ⓢ 52 | ⊥ 30 |



IP23

### MirnaX

5 | 59764/11/10

 **20W INCL.**

3x G4 | max. 20W | 230V 12V | 

 | ↔ 83 | Ⓢ 55 | ⊥ 85 |





Opal

■ 1 | 59330/17/10

□ 2 | 59330/31/10

 PHILIPS 50W INCL.

1x GU10 | max. 50W | 230V | 

 | ↔ 90 | ⌀ 74 | ⊥ 110 |



IP23

Opal

■ 3 | 59333/01/10

■ 4 | 59333/06/10

■ 5 | 59333/11/10

 PHILIPS 50W INCL.

3x GU10 | max. 50W | 230V | 

 | ↔ 90 | ⌀ 74 | ⊥ 110 |



IP23

Opal

■ 6 | 59333/17/10

□ 7 | 59333/31/10

■ 8 | 59333/48/10

 PHILIPS 50W INCL.

3x GU10 | max. 50W | 230V | 

 | ↔ 90 | ⌀ 74 | ⊥ 110 |









IP23











Quartz

	1   59323/01/10
	2   59323/06/10
	3   59323/11/10
	<b>PHILIPS 50W INCL.</b>
	3x GU10   max. 50W   230V   
	← 84   Ⓢ 74   ⊥ 110
	
	IP23

Quartz

	4   59323/17/10
	5   59323/31/10
	6   59323/48/10
	<b>PHILIPS 50W INCL.</b>
	3x GU10   max. 50W   230V   
	← 84   Ⓢ 74   ⊥ 110
	
	IP23



### Alpha

 1 | 59393/01/10

 2 | 59393/06/10

 3 | 59393/11/10

 4 | 59393/17/10

 5 | 59393/31/10

 **PHILIPS 50W INCL.**

3x GU10 | max. 50W | 230V | 

 | → 80 | Ⓢ 64 | ⊥ 110 |



IP23



### Mango

■	1   59463/17/10
☰	<b>PHILIPS 35W INCL.</b> 3x GU10   max. 35W   230V   ☐
↔	↔ 70   Ⓢ 55   ⊥ 110
☐	MET
	IP23

### Lemon

■	2   59473/17/10
☰	<b>PHILIPS 35W INCL.</b> 3x GU10   max. 35W   230V   ☐
↔	↔ 68   Ⓢ 55   ⊥ 110
☐	MET
	IP23

### Mira

■	3   72810/23/17
☰	<b>20W INCL.</b> 3x G4   max. 20W   230V 12V
↔	↔ 77   Ⓢ 64   ⊥ 105
☐	MET
	IP23

Экономят  
энергию



**Sigma**

	1   59590/56/10
	<b>PHILIPS 12W INCL.</b> 1x E14   max. 12W   230V
	↔ 116   Ⓢ 95   ⊥ 132
IP23	

**Mono**

	2   59600/31/10
	<b>PHILIPS 9W INCL.</b> 1x GX53   max. 9W   230V
	↔ 140   Ⓢ 127   ⊥ 75
IP23	

**Mono**

	3   59602/31/10
	<b>PHILIPS 9W INCL.</b> 2x GX53   max. 9W   230V
	↔ 290   Ⓢ 128 x 275   ⊥ 75
IP23	

1 



Экономят энергию 

3 









2 









4 



### Delta

	1   59570/17/10
	2   59570/31/10
	<b>PHILIPS 12W INCL.</b> 1x E14   max. 12W   230V   
	↔ 109   Ⓢ 95   ⊥ 133
 	
IP44	

### Omega

	3   59580/17/10
	4   59580/31/10
	<b>PHILIPS 12W INCL.</b> 1x E14   max. 12W   230V   
	↔ 108   Ⓢ 95   ⊥ 133
 	
IP44	

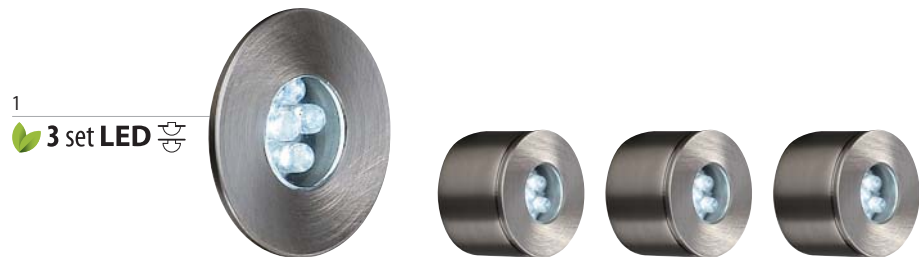

1  
3 set LED

ЭКОНОМЯТ  
энергию



2  
3 set LED



3  
LED

Attiki

1 | 59023/17/10

LED 0,36W INCL. | 6-LED

3x LED | max. 0,36W | 220V-11V | ⬡

Y | |← 40 | Ⓢ 35 | ± 30 |

MET SYN

Pretoria

2 | 59033/17/10

LED 0,96W INCL. | 16-LED

3x LED | max. 0,96W | 220V-9V | ⬡

Y | |← 62 | Ⓢ 57 | ± 30 |

MET SYN

Novara

3 | 59038/17/10

LED 0,96W INCL. | 16-LED

3x LED | max. 0,96W | 220V-9V | ⬡

Y | |← 62 | Ⓢ 57 | ± 30 |

MET SYN





Экономят энергию 



**Frea**

 1 | 59383/17/10

 **7W INCL.**  
3x GU10 | max. 7W | 230V | 

 | ↔ 80 | Ⓢ 64 | ⊥ 105 |



**Spark**

 2 | 59453/17/10

 **1,5W INCL.** | 15-LED  
3x LED | max. 1,5W | 230V | 

 | ↔ 82 | Ⓢ 64 | ⊥ 105 |



IP23

**Musa**

 3 | 59510/17/10

 4 | 59510/31/10

 **PHILIPS 7W INCL.**  
1x GX53 | max. 7W | 230V | 

 | ↔ 100 | Ⓢ 85 | ⊥ 24 |

1



2



Экономят  
энергию



3



4

Fern

■	1   59785/17/10
	<b>PHILIPS 8W INCL.</b>
	1x E27   max. 9W   230V   Ⓢ
	↔ 145   Ⓢ 130   ⊥ 120

Velvet

■	2   59786/17/10
	<b>PHILIPS 8W INCL.</b>
	1x E27   max. 9W   230V   Ⓢ
	↔ 120   Ⓢ 106   ⊥ 110

Volcan

■	3   59790/17/10
	<b>PHILIPS 14W INCL.</b>
	2x E27   max. 14W   230V   Ⓢ
	↔ 190   Ⓢ 173   ⊥ 120

Lava

■	4   59791/17/10
	<b>PHILIPS 14W INCL.</b>
	2x E27   max. 14W   230V   Ⓢ
	↔ 163   Ⓢ 148   ⊥ 110



1

Экономят  
энергию









2

3









4

Veta

	1   59796/17/10
	2   59796/31/10
	<b>PHILIPS 14W INCL.</b> 2x E27   max. 14W   230V   
	↔ 220   Ⓢ 195   ⊥ 120
	

Ronda

	3   59799/17/10
	4   59799/31/10
	<b>PHILIPS 14W INCL.</b> 2x E27   max. 14W   230V   
	↔ 230   Ⓢ 200   ⊥ 120
	





# Список позиций по артикулам

---

## Артикул Стр. Запасная часть Номер модели

00929/21/06	364		5	
01200/21/30	356		5	
01229/21/06	364		5	
01229/21/17	364		5	
01302/01/30	388	Ⓞ 14058/00/67	5	
01302/01/31	388	Ⓞ 14058/00/67	5	
01304/01/30	413	Ⓞ 61520/00/65	5	
01465/01/30	389	Ⓞ 01465/56/0P	5	
01465/01/31	389	Ⓞ 01465/56/0P	5	
01623/01/30	423	Ⓞ 61601/00/65	5	
01624/03/30	423	Ⓞ 61601/00/65	5	
01726/01/93	382	Ⓞ 01726/67/0P	5	
01727/01/93	382	Ⓞ 01728/31/0P	5	
01728/01/93	382	Ⓞ 01728/31/0P	5	
01816/01/42	391	Ⓞ 14094/01/61	5	
01816/01/45	391	Ⓞ 14094/01/61	5	
01907/01/47	379	Ⓞ 01907/61/0P	5	
01908/01/47	379	Ⓞ 01907/61/0P	5	
01909/01/47	379	Ⓞ 01907/61/0P	5	
01911/01/47	379	Ⓞ 01907/61/0P	5	
02322/01/54	137	Ⓞ 14823/01/61	5	
02510/21/17	230	Ⓞ 14469/00/67	5	
02514/25/17	230	Ⓞ GR000/42/67	5	
02516/22/17	230	Ⓞ 14469/00/67	5	
02518/24/17	230	Ⓞ 14469/00/67	5	

## Артикул Стр. Запасная часть Номер модели

02793/63/31	243		5	
03625/81/43	91	△ 26101/20/59	5	
03625/85/43	91	△ 26101/20/59	5	
04150/61/31	242		5	
04150/62/31	242		5	
04155/63/31	242		5	
04157/64/31	242		5	
04920/61/31	243		5	
04922/61/31	243		5	
04924/62/31	243		5	
07616/01/54	137		5	
07616/06/54	137		5	
07617/05/54	137		5	
09235/81/43	91	△ 26097/42/59	5	
09297/02/43	147	Ⓞ 14298/00/67	5	
09939/21/17	146		5	
09939/21/30	146		5	
12414/81/43	91	△ 26097/30/59	5	
12830/01/87	356	Ⓞ 13327/00/87	5	
12831/01/30	356	Ⓞ 13327/00/30	5	
12831/01/31	356	Ⓞ 13327/00/31	5	
12923/01/32	362		5	
12923/01/35	362		5	
12923/01/53	362		5	
12923/01/87	362		5	

















Артикул Стр. Запасная часть Номер модели

15020/42/10	414	Ⓢ 15020/60/0G	5	
15020/54/10	416	Ⓢ 15020/60/0G	5	
15021/42/10	414	Ⓢ 15020/60/0G	5	
15021/54/10	416	Ⓢ 15020/60/0G	5	
15022/42/10	414	Ⓢ 15020/60/0G	5	
15022/54/10	416	Ⓢ 15020/60/0G	5	
15023/42/10	414	Ⓢ 15020/60/0G	5	
15023/54/10	416	Ⓢ 15020/60/0G	5	
15024/42/10	415	Ⓢ 15020/60/0G	5	
15024/54/10	417	Ⓢ 15020/60/0G	5	
15025/42/10	415	Ⓢ 15020/60/0G	5	
15025/54/10	417	Ⓢ 15020/60/0G	5	
15026/42/10	415	Ⓢ 15020/60/0G	5	
15026/54/10	417	Ⓢ 15020/60/0G	5	
15030/45/10	418	Ⓢ 15030/60/0P	5	
15031/45/10	418	Ⓢ 15030/60/0P	5	
15032/45/10	418	Ⓢ 15030/60/0P	5	
15033/45/10	419	Ⓢ 15030/60/0P	5	
15035/45/10	419	Ⓢ 15030/60/0P	5	
15036/45/10	419	Ⓢ 15030/60/0P	5	
15170/42/10	408	Ⓢ GA002/10/55	5	
15171/42/10	408	Ⓢ GA002/10/55	5	
15172/42/10	408	Ⓢ GA002/10/55	5	
15173/42/10	409	Ⓢ GA002/10/55	5	
15175/42/10	409	Ⓢ GA002/10/55	5	























Артикул Стр. Запасная часть Номер модели

15176/42/10	409	Ⓢ GA002/10/55	5	
15190/86/10	407	Ⓢ GQ015/30/60	5	
15191/86/10	407	Ⓢ GQ015/30/60	5	
15192/86/10	407	Ⓢ GQ015/30/60	5	
15193/86/10	407	Ⓢ GQ015/30/60	5	
15196/86/10	407	Ⓢ GQ015/30/60	5	
15201/86/10	395	Ⓢ GF036/00/60	5	
15202/86/10	395	Ⓢ GF036/00/60	5	
15205/86/10	394	Ⓢ GF036/00/60	5	
15206/86/10	395	Ⓢ GF036/00/60	5	
15211/42/10	392	Ⓢ 15211/34/1P	5	
15213/42/10	392	Ⓢ 15211/34/1P	5	
15215/42/10	392	Ⓢ 15211/34/1P	5	
15216/42/10	392	Ⓢ 15211/34/1P	5	
15221/86/10	396	Ⓢ GB012/09/60	5	
15226/86/10	396	Ⓢ GB012/09/60	5	
15261/42/10	393	Ⓢ 15261/56/0P	5	
15263/42/10	393	Ⓢ 15261/56/0P	5	
15265/42/10	393	Ⓢ 15261/56/0P	5	
15266/42/10	393	Ⓢ 15261/56/0P	5	
15270/86/10	420	Ⓢ 15270/86/0G	5	
15272/86/10	420	Ⓢ 15270/86/0G	5	
15277/86/10	420	Ⓢ 15277/60/0P	5	
15280/54/10	406		5	
15282/54/10	406		5	

Артикул Стр. Запасная часть Номер модели

15283/54/10	406			5	
15320/86/10	390			5	
15323/86/10	390			5	
15330/54/10	405	Ⓜ GI008/80/69		5	
15331/54/10	405	Ⓜ GI008/80/69		5	
15332/54/10	404	Ⓜ GI008/80/69		5	
15335/54/10	404	Ⓜ GI008/80/69		5	
15336/54/10	404	Ⓜ GI008/80/69		5	
15338/54/10	405	Ⓜ GI008/80/69		5	
15350/30/10	403	Ⓜ GQ019/00/60		5	
15352/30/10	403	Ⓜ GQ019/00/60		5	
15355/30/10	403	Ⓜ GQ019/00/60		5	
15356/30/10	403	Ⓜ GQ019/00/60		5	
15360/42/10	411	Ⓜ 15360/42/0G		5	
15361/42/10	411	Ⓜ 15360/42/0G		5	
15362/42/10	410	Ⓜ 15360/42/0G		5	
15365/42/10	411	Ⓜ 15360/42/0G		5	
15366/42/10	411	Ⓜ 15360/42/0G		5	
15380/30/10	399			5	
15380/31/10	400			5	
15382/30/10	399			5	
15382/31/10	401			5	
15383/30/10	398			5	
15383/31/10	401			5	
15385/30/10	398			5	

Артикул Стр. Запасная часть Номер модели

15385/31/10	401			5	
15386/30/10	399			5	
15386/31/10	400			5	
15387/30/10	399			5	
15387/31/10	400			5	
15390/42/10	402			5	
15390/54/10	402			5	
15392/42/10	402			5	
15392/54/10	402			5	
15401/86/10	396			5	
15403/86/10	396			5	
16007/65/10	426	Ⓜ 14200/00/65		5	
16008/65/10	426	Ⓜ 14200/00/65		5	
16120/47/10	377	Ⓜ 16120/60/0P		5	
16121/47/10	377	Ⓜ 16120/60/0P		5	
16122/47/10	377	Ⓜ 16120/60/0P		5	
16167/47/10	380	Ⓜ 16167/60/0X		5	
16168/47/10	380	Ⓜ 16167/60/0X		5	
16169/47/10	380	Ⓜ 16167/60/0X		5	
16183/87/10	383	Ⓜ 16183/67/0P		5	
16184/87/10	383	Ⓜ 16184/60/0P		5	
16185/87/10	383	Ⓜ 16184/60/0P		5	
16188/42/10	397	Ⓜ 16188/60/0P		5	
16189/42/10	397	Ⓜ 16188/60/0P		5	
16190/47/10	378	Ⓜ HA066/20/47		5	









Артикул Стр. Запасная часть Номер модели

16191/47/10	378	HA066/20/47	5	412253 984139
16192/47/10	378	HA066/20/47	5	412253 984146
16219/47/10	377	GN057/90/61	5	413987 019777
16220/47/10	377	GN057/90/61	5	413987 019845
16232/47/10	376		5	413987 033131
16233/47/10	376		5	413987 033155
16234/47/10	376		5	413987 033162
16245/87/10	384	16245/56/0P	5	413987 056246
16245/93/10	384	16245/56/0P	5	413987 056253
16248/87/10	384	16247/56/0P	5	413987 056369
16248/93/10	384	16247/56/0P	5	413987 056376
16251/87/10	385	16251/56/0P	5	413987 062568
16251/93/10	385	16251/56/0P	5	413987 056314
16252/87/10	385	16252/56/0P	5	413987 062605
16252/93/10	385	16252/56/0P	5	413987 056338
16260/54/10	397	GF047/00/31	5	413987 070389
16261/54/10	397	GF046/90/31	5	413987 070402
16270/86/10	391	14698/00/61	5	413987 070433
16271/86/10	391	14698/00/61	5	413987 070440
16314/93/10	381		5	413987 099304
16315/93/10	381		5	413987 099298
16316/93/10	381		5	413987 092435
16317/93/10	381		5	413987 092428
16318/47/10	371		5	413987 087585
16320/93/10	370	16320/60/0P	5	413987 087530

Артикул Стр. Запасная часть Номер модели

16321/93/10	370	16320/60/0P	5	413987 087547
17014/93/10	382	17015/67/0P	5	412253 800965
17020/47/10	430		5	412253 791478
17021/87/10	388	GN018/30/67	5	412253 825487
17021/93/10	388	GN018/30/67	5	412253 825494
17025/47/10	374	GF009/50/67	5	412253 825562
17067/17/10	431		5	412253 867760
17068/87/10	430	GQ013/31/67	5	412253 867913
17069/87/10	430	GQ013/20/60	5	412253 867920
17071/47/10	375	HA041/10/47	5	412253 867944
17074/47/50	431		5	413987 047442
17079/47/10	431		5	412253 877820
17090/31/10	425	17090/67/0P	5	412253 882022
17090/87/10	425	17090/67/0P	5	412253 882039
17101/47/10	375	GR004/10/69	5	412253 918165
17102/47/10	375	GR004/00/69	5	412253 918172
17103/86/10	423	GN030/80/56	5	412253 918196
17105/87/10	386	17105/67/0P	5	412253 918226
17105/93/10	386	17105/67/0P	5	412253 918233
17118/04/10	422	GN037/90/67	5	412253 963073
17130/87/10	386		5	412253 963042
17130/93/10	387		5	412253 963059
17131/42/10	421	01726/67/0P	5	412253 963868
17131/86/10	421	01726/67/0P	5	412253 963875
17150/47/10	388	14058/00/67	5	413987 001901

## Артикул Стр. Запасная часть Номер модели

17151/47/10	375		5	
17156/42/10	423		5	
17157/54/10	423	Ⓢ GN046/60/56	5	
17166/47/10	373	Ⓢ 17166/60/0P	5	
17170/30/10	425		5	
17170/87/10	425		5	
17173/06/10	421	Ⓢ GF042/90/67	5	
17173/47/10	374		5	
17174/47/10	374		5	
17177/87/10	389	Ⓢ 17177/31/0P	5	
17178/87/10	389	Ⓢ 17177/31/0P	5	
17179/48/10	431		5	
17181/47/10	374	Ⓢ 17181/56/0P	5	
17183/86/10	422	Ⓢ 17183/34/0P	5	
17184/86/10	422	Ⓢ 17184/34/0P	5	
17184/87/10	386	Ⓢ 17184/56/0P	5	
17185/47/10	373	Ⓢ HA094/60/00	5	
17187/30/10	427	Ⓢ 17187/60/0P	5	
17189/30/10	427	Ⓢ 17187/60/0P	5	
17201/47/10	373		5	
17202/87/10	424		5	
17203/87/10	424		5	
17207/87/10	391		5	
17208/93/10	370		5	
17210/42/10	371		5	

## Артикул Стр. Запасная часть Номер модели

17211/86/10	371		5	
17217/47/10	372		5	
17218/47/10	372		5	
17219/47/10	371		5	
17515/87/10	427	Ⓢ GQ019/10/60	5	
30010/67/10	166	Ⓢ GS002/71/31	5	
30011/67/10	166	Ⓢ GB003/30/01	5	
30012/06/10	186	Ⓢ GS002/72/84	5	
30012/11/10	167	Ⓢ GS002/71/31	5	
30012/17/10	167	Ⓢ GS002/71/31	5	
30023/31/10	187	Ⓢ GN014/80/60	5	
30050/06/10	191	Ⓢ GS004/40/67	5	
30050/17/10	177	Ⓢ GS004/40/67	5	
30050/56/10	177	Ⓢ GS004/40/67	5	
30067/43/10	195	Ⓢ GS002/70/84	5	
30068/43/10	195	Ⓢ GS002/70/84	5	
30096/43/10	197		5	
30097/43/10	197	Ⓢ GS004/50/86	5	
30110/55/10	346	Ⓢ GS004/40/16	5	
30112/55/10	346	Ⓢ GS006/41/33	5	
30136/48/10	175	Ⓢ GS006/20/67	5	
30164/17/10	175	Ⓢ GS008/40/31	5	
30165/69/10	165		5	
30175/30/10	152	△ 30175/30/0S	5	
		Ⓢ GR007/30/67		

Артикул Стр. Запасная часть Номер модели

30175/38/10	152	△ 30175/38/0S	5		413987 010668
		Ⓢ GR007/30/67			
30179/67/10	178	Ⓢ GS002/70/20	5		413987 010200
30180/67/10	178	Ⓢ GB012/80/67	5		413987 011405
30180/69/10	165		5		413987 072024
30184/43/10	192	Ⓢ 30184/43/0G	5		413987 010774
30190/17/10	167	Ⓢ GB014/00/31	5		413987 037849
30193/01/10	182	Ⓢ GS002/70/31	5		413987 037887
30193/14/10	183	Ⓢ GS002/70/31	5		413987 037894
30194/31/10	160	Ⓢ GQ009/31/31	5		413987 037955
30197/31/10	160	Ⓢ 30197/31/0P	5		413987 037979
30198/17/10	163	Ⓢ 30198/31/0G	5		413987 037948
30200/86/10	195	Ⓢ GB014/20/67	5		413987 038235
30200/87/10	163	Ⓢ GB014/20/67	5		413987 037986
30204/86/10	194	Ⓢ 30204/31/0G	5		413987 038129
30205/11/10	284	Ⓢ GR009/80/31	5		413987 038099
30221/31/10	170		5		413987 047138
30222/31/10	170		5		413987 047145
30243/48/10	171		5		413987 073014
30244/48/10	171		5		413987 073007
30255/30/10	180		5		413987 061936
30259/67/10	181		5		413987 066986
30262/35/10	341		5		413987 066733
30267/55/10	337		5		413987 081149
30268/55/10	336		5		413987 081347

Артикул Стр. Запасная часть Номер модели

30270/43/10	196		5		413987 093753
30279/67/10	185		5		413987 093579
30280/67/10	184		5		413987 093586
30294/48/10	168	Ⓢ 30294/31/0G	5		413987 080517
30295/48/10	168	Ⓢ 30295/31/0G	5		413987 080524
30307/87/10	164		5		413987 093609
30308/87/10	164		5		413987 093593
30350/11/10	150		5		413987 096648
30801/31/10	169		5		412253 937166
30802/31/10	169		5		412253 937173
30803/31/10	169		5		412253 937180
30842/31/10	169	Ⓢ 30842/56/0P	5		412253 937197
31914/31/10	185	Ⓢ GS000/21/21	5		413987 017582
31991/62/10	188	Ⓢ GS010/00/62	5		412253 872795
31992/62/10	188	Ⓢ GS010/20/62	5		412253 872825
32001/31/10	310	Ⓢ 32001/67/0G	5		412253 776727
32005/31/10	310	Ⓢ GF010/70/56	5		412253 776758
32009/11/10	312	Ⓢ GS003/30/67	5		412253 826101
32009/17/10	312	Ⓢ GS003/30/67	5		412253 778356
32010/11/10	312	Ⓢ GS003/20/67	5		412253 826118
32010/17/10	312	Ⓢ GS003/20/67	5		412253 778363
32015/11/10	295		5		412253 802259
32020/67/10	313	Ⓢ GS000/21/67	5		412253 802365
32025/31/10	309		5		413987 090240
32026/11/10	304		5		413987 089916

Артикул Стр. Запасная часть Номер модели

32064/31/10	313	Ⓢ GF013/60/56	5	412253 892243
32067/31/10	313	Ⓢ GF013/80/56	5	412253 892267
32070/17/10	310		5	413987 010538
32071/31/10	311	Ⓢ GN048/80/31	5	413987 010897
32080/17/10	313	Ⓢ GS003/20/67	5	413987 037788
32081/31/10	308	Ⓢ 32081/31/0G	5	413987 069215
32082/87/10	308		5	413987 069185
32115/17/10	278	Ⓢ GQ007/50/67	5	412253 850342
32116/17/10	278	Ⓢ GQ007/40/67	5	412253 850373
32129/17/10	278		5	413987 089664
32130/17/10	279		5	413987 089671
32145/48/10	284		5	413987 061844
32146/48/10	281		5	413987 061875
32149/48/10	287	Ⓢ GF037/80/67	5	412253 977599
32157/31/10	266		5	413987 080050
32158/31/10	266		5	413987 080081
32159/31/10	269		5	413987 080142
32159/48/10	269		5	413987 080159
33006/17/10	172	Ⓢ GQ003/40/67	5	412253 815662
33012/17/10	173		5	412253 804529
33014/17/10	172	Ⓢ GB003/80/67	5	412253 804314
33050/06/10	191	Ⓢ 81531/00/31	5	412253 804550
33050/17/10	177	Ⓢ 81531/00/31	5	412253 804574
33065/06/10	186	Ⓢ GI007/40/67	5	412253 849629
33065/17/10	172	Ⓢ GI007/40/67	5	412253 849612

Артикул Стр. Запасная часть Номер модели















33080/06/10	200		5	413987 060649
33080/48/10	201		5	413987 060656
33081/06/10	200		5	413987 060663
33081/48/10	200		5	413987 060670
33084/06/10	202		5	412253 850656
33084/17/10	202		5	412253 850663
33087/06/10	202		5	412253 850687
33087/17/10	202		5	412253 850694
33096/43/10	197	Ⓢ GF013/50/86	5	412253 890614
33115/17/10	172	Ⓢ GI002/20/60	5	412253 890843
33127/17/10	173	Ⓢ GQ012/80/67	5	412253 890737
33132/17/10	173		5	412253 890744
33160/17/10	173	Ⓢ GF021/50/56	5	412253 937272
33185/86/10	198	Ⓢ 33185/53/0G	5	412253 977810
33187/86/10	198	Ⓢ GF024/30/62	5	412253 977674
33199/67/10	178	Ⓢ GB003/90/20	5	413987 010507
33200/30/10	152	△ 33200/30/0S	5	413987 010613
		Ⓢ GI005/90/67		
33200/38/10	153	△ 33200/38/0S	5	413987 010620
		Ⓢ GI005/90/67		
33204/43/10	193	Ⓢ 33204/43/0G	5	413987 010767
33206/31/10	162	Ⓢ GI007/00/31	5	413987 037856
33206/93/10	163	Ⓢ GI007/00/31	5	413987 037863
33208/31/10	161	Ⓢ GQ022/01/67	5	413987 037962
33211/31/10	285		5	413987 038105



Артикул Стр. Запасная часть Номер модели

33211/48/10	285		5	
33218/31/10	283		5	
33218/48/10	282		5	
33219/31/10	283		5	
33219/48/10	282		5	
33227/30/10	185		5	
33227/31/10	185		5	
33230/17/10	160	① 33230/31/0G	5	
33231/06/10	158		5	
33231/17/10	158		5	
33232/17/10	158		5	
33232/31/10	159		5	
33232/74/10	158		5	
33233/43/10	192	① 80813/00/67	5	
33237/69/10	165		5	
33242/17/10	151	① GB017/20/67	5	
33242/43/10	192	① GB017/20/67	5	
33243/48/10	151		5	
33245/31/10	157		5	
33245/48/10	157		5	
33246/30/10	157		5	
33246/31/10	156		5	
33247/38/10	154		5	
33247/93/10	155		5	
33248/38/10	183		5	

Артикул Стр. Запасная часть Номер модели

33249/11/10	151		5	
33252/18/10	183		5	
33252/43/10	183		5	
33254/43/10	192		5	
33256/43/10	196		5	
33257/31/10	268		5	
33257/48/10	268		5	
33258/31/10	267		5	
33259/31/10	269		5	
33259/48/10	269		5	
33261/06/10	155		5	
33261/17/10	155		5	
33307/87/10	164		5	
33440/17/10	328		5	
33450/17/10	324		5	
33451/17/10	324	① GR003/40/67	5	
33452/17/10	324	① GR003/40/67	5	
33464/17/10	325		5	
33465/17/10	325		5	
33466/17/10	324		5	
33468/17/10	325		5	
33470/17/10	323		5	
33471/17/10	323		5	
33480/17/10	322	① GN025/50/56	5	
33481/17/10	322	① GN025/50/56	5	

## Артикул Стр. Запасная часть Номер модели

33490/31/10	326		5		412253 878766
33491/31/10	326		5		412253 878773
33492/31/10	326		5		412253 878780
33510/48/10	174	☐ 33510/60/0P	5		412253 920519
33512/48/10	174	☐ 33510/60/0P	5		412253 920564
34006/11/10	299	Ⓢ GN014/70/56	5		412253 801948
34008/11/10	303	Ⓢ GB003/60/56	5		412253 802174
34009/11/10	303	Ⓢ GB003/70/56	5		412253 802181
34012/17/10	302	Ⓢ GB003/50/67	5		412253 801979
34015/17/10	294	Ⓢ 14298/00/56	5		412253 802006
34016/17/10	294	Ⓢ 14298/00/56	5		412253 802020
34020/11/10	295		5		412253 802198
34021/11/10	295		5		412253 802211
34022/11/10	295		5		412253 802235
34030/17/10	298	Ⓢ GN014/70/56	5		412253 850885
34070/11/10	303	☐ 34070/31/0P	5		412253 897767
34081/11/10	296	Ⓢ GN033/00/56	5		412253 937753
34082/11/10	296	Ⓢ GN033/00/56	5		412253 937760
34083/11/10	297	Ⓢ GN033/00/56	5		412253 937777
34084/11/10	298	Ⓢ GF021/30/56	5		412253 937791
34086/11/10	298	Ⓢ GN041/90/56	5		412253 937814
34088/06/10	307	Ⓢ GF016/10/56	5		412253 937838
34092/17/10	302	Ⓢ GB003/50/67	5		412253 977629
34093/11/10	302	Ⓢ GB013/00/67	5		413987 010552
34094/11/10	302	Ⓢ GB013/10/67	5		413987 010569

## Артикул Стр. Запасная часть Номер модели

34095/06/10	300	☐ 34095/67/0P	5		413987 037801
34095/11/10	300	☐ 34095/67/0P	5		413987 037818
34096/11/10	298	Ⓢ GN048/60/56	5		413987 010644
34097/11/10	305	Ⓢ GF040/30/69	5		413987 010736
34098/11/10	305	Ⓢ GF040/30/69	5		413987 010682
34099/06/10	306	Ⓢ GF016/10/56	5		413987 037795
34101/17/10	286	Ⓢ GI001/50/67	5		412253 850762
34103/48/10	280		5		413987 061851
34104/48/10	280		5		413987 061868
34110/11/10	301		5		413987 089619
34111/17/10	286	Ⓢ GS001/52/56	5		412253 850779
34124/48/10	280	Ⓢ GQ013/50/67	5		412253 937111
34131/11/10	294		5		413987 069178
34133/11/10	303		5		413987 069208
34134/06/10	306		5		413987 069192
34136/11/10	292		5		413987 089626
34137/11/10	293		5		413987 089725
34138/11/10	292		5		413987 089633
34141/11/10	304		5		413987 090264
34312/11/10	294		5		413987 069543
36065/17/10	45		5		412253 785248
36066/17/10	45	Ⓢ GB003/10/67	5		412253 785255
36230/17/10	29	Ⓢ GS002/80/56	5		412253 822097
36231/17/10	29	Ⓢ GS003/00/56	5		412253 822110
36235/17/10	29	Ⓢ GN016/70/56	5		412253 822462





Артикул Стр. Запасная часть Номер модели

36236/17/10	29	Ⓢ GN016/00/56	5	
36255/06/10	103		5	
36256/06/10	103		5	
36257/06/10	103		5	
36265/17/10	83	Ⓢ GF007/60/00	5	
36266/17/10	82	Ⓢ GF007/60/00	5	
36267/17/10	83	Ⓢ GF007/60/00	5	
36270/17/10	102		5	
36271/17/10	102		5	
36272/17/10	102		5	
36275/32/10	41	△ 36275/32/0S	5	
36300/17/10	30	Ⓢ GN018/90/56	5	
36302/17/10	30	Ⓢ GN018/90/56	5	
36375/43/10	133	Ⓢ GN021/90/43	5	
36376/43/10	133	Ⓢ GN021/90/43	5	
36377/43/10	133	Ⓢ GN021/90/43	5	
36379/43/10	133	Ⓢ GN021/90/43	5	
36412/06/10	93	△ 36412/38/0S	5	
36412/17/10	92		5	
36413/06/10	93	△ 26843/36/38	5	
36413/17/10	43	△ 36413/31/0S	5	
36414/06/10	93	△ 26841/25/38	5	
36414/17/10	92		5	
36490/43/10	132	Ⓢ GF012/77/43	5	
36491/43/10	132	Ⓢ GF012/00/86	5	

Артикул Стр. Запасная часть Номер модели

36492/43/10	132	Ⓢ GF012/00/86	5	
36500/06/10	109	Ⓢ 36500/31/1G	5	
36500/17/10	109	Ⓢ 36500/31/1G	5	
36502/06/10	109	Ⓢ 36500/31/1G	5	
36502/17/10	109	Ⓢ 36500/31/1G	5	
36505/43/10	117	△ 36505/38/0S	5	
36507/43/10	117	△ 36505/38/0S	5	
36561/17/10	27	Ⓢ GN029/10/56	5	
36675/17/10	35	△ 36675/30/0S	5	
36677/17/10	35	△ 36676/30/0S	5	
36679/17/10	35	△ 36676/30/0S	5	
36950/86/10	127		5	
36952/86/10	127		5	
36953/86/10	127		5	
36954/86/10	127		5	
36975/30/10	74	△ 36975/30/0S	5	
		Ⓢ HA074/40/60		
36976/30/10	75	△ 36975/30/0S	5	
		Ⓢ HA074/40/60		
36978/30/10	75	△ 36978/30/0S	5	
		Ⓢ HA074/40/60		
36995/17/10	108	Ⓢ GF041/20/60	5	
36995/43/10	135	Ⓢ GF041/20/60	5	
36996/17/10	108	Ⓢ GF041/20/60	5	
36996/43/10	135	Ⓢ GF041/20/60	5	

























Артикул Стр. Запасная часть Номер модели

37150/32/10	41		5	
37150/43/10	41		5	
37160/31/10	28	Ⓢ GN053/00/31	5	
37165/31/10	28	Ⓢ GN053/00/31	5	
37166/31/10	28	Ⓢ GN053/00/31	5	
37315/11/10	80	△ 37315/31/0S	5	
		Ⓢ HA059/60/60		
37317/11/10	80	△ 37315/31/0S	5	
		Ⓢ HA059/60/60		
37355/43/10	118	△ 37355/38/0S	5	
37358/43/10	119	△ 37355/38/0S	5	
37359/43/10	118	△ 37359/38/0S	5	
37370/43/10	38	△ 37370/43/0S	5	
37372/43/10	38	△ 37372/43/0S	5	
37373/43/10	38	△ 37373/43/0S	5	
37374/43/10	39	△ 37372/43/0S	5	
37380/87/10	30	Ⓢ GS010/30/31	5	
37381/87/10	30	Ⓢ GN037/30/31	5	
37410/43/10	124		5	
37411/43/10	124		5	
37413/43/10	124		5	
37414/43/10	124		5	
37460/31/10	26	Ⓢ GN055/90/56	5	
37461/31/10	26	Ⓢ GN055/90/56	5	
37465/43/10	128		5	















Артикул Стр. Запасная часть Номер модели

37467/43/10	128		5	
37505/30/10	59	△ 37508/30/0S	5	
37507/30/10	59	△ 37507/30/0S	5	
37508/30/10	59	△ 37508/30/0S	5	
37510/48/10	24	Ⓢ GS001/53/56	5	
37511/48/10	24	Ⓢ GS001/53/56	5	
37512/48/10	24		5	
37515/48/10	24	Ⓢ GS001/53/56	5	
37530/86/10	122	△ 37530/43/0S	5	
37531/86/10	122	△ 37531/43/0S	5	
37532/86/10	122	△ 37532/43/0S	5	
37533/86/10	123	△ 37530/43/0S	5	
37534/86/10	123	△ 37534/43/0S	5	
37560/43/10	129		5	
37562/43/10	129		5	
37625/44/10	49		5	
37626/44/10	49	Ⓢ GS011/90/67	5	
37650/17/10	22	Ⓢ GF043/80/69	5	
37651/17/10	22	Ⓢ GF043/80/69	5	
37652/17/10	23	Ⓢ GF043/80/69	5	
37653/17/10	22	Ⓢ GF043/80/69	5	
37655/31/10	25	Ⓢ 37655/67/0G	5	
37657/31/10	25	Ⓢ 37657/67/0G	5	
37665/86/10	125		5	
37666/86/10	125		5	

Артикул Стр. Запасная часть Номер модели

37667/86/10	125			5	
37670/86/10	120	△	37670/43/0S	5	
37671/86/10	121	△	37671/43/0S	5	
37672/86/10	120	△	37672/43/0S	5	
37673/86/10	120	△	37670/43/0S	5	
37674/86/10	120	△	37672/43/0S	5	
37675/48/10	25	Ⓢ	GF045/60/56	5	
37678/48/10	25			5	
37680/86/10	131	Ⓢ	GN063/57/31	5	
37681/86/10	131	Ⓢ	GN063/47/31	5	
37690/06/10	87	△	37690/38/0S	5	
37693/06/10	87	△	37693/38/0S	5	
37694/06/10	87	△	37694/38/0S	5	
37695/86/10	40			5	
37696/86/10	40	△	37695/38/0S	5	
37697/86/10	40			5	
37700/06/10	95	Ⓢ	GN061/00/67	5	
37701/06/10	95			5	
37702/06/10	95			5	
37704/06/10	95			5	
37710/06/10	97	Ⓢ	37710/31/0G	5	
37711/06/10	96			5	
37712/06/10	96	Ⓢ	37712/31/0G	5	
37715/06/10	96			5	
37716/06/10	97			5	











Артикул Стр. Запасная часть Номер модели

37720/06/10	101	Ⓢ	37720/31/0G	5	
37721/06/10	101			5	
37722/06/10	101			5	
37740/43/10	130			5	
37741/43/10	130			5	
37742/43/10	130			5	
37745/43/10	130			5	
37760/55/10	107			5	
37762/55/10	107			5	
37764/55/10	107			5	
37865/11/10	16			5	
37865/31/10	17			5	
37866/11/10	17			5	
37866/31/10	17			5	
37867/11/10	17			5	
37867/31/10	17			5	
37890/06/10	114			5	
37892/06/10	115			5	
37893/06/10	115			5	
37894/06/10	115			5	
37950/17/10	18			5	
37950/31/10	19			5	
37951/17/10	18			5	
37951/31/10	19			5	
37954/17/10	18			5	

Артикул Стр. Запасная часть Номер модели

37954/31/10	19		5	
37955/48/10	20		5	
37956/48/10	20		5	
37957/48/10	20		5	
37960/48/10	56		5	
37961/48/10	56		5	
37964/48/10	56		5	
37980/43/10	90		5	
37982/43/10	90		5	
37984/43/10	90		5	
37990/55/10	105		5	
37991/55/10	104		5	
37992/55/10	105		5	
37995/86/10	116		5	
37997/86/10	116		5	
37998/86/10	116		5	
38365/11/10	79	① HA084/40/60	5	
38367/11/10	79	① HA084/40/60	5	
38650/55/10	106	① GA001/90/55	5	
38652/55/10	106	① GA001/90/55	5	
38654/55/10	106	① GA001/90/55	5	
38796/17/10	32		5	
38811/42/10	134	① GF022/60/69	5	
38812/42/10	134	① GF022/60/69	5	
38980/43/10	136	① 38980/67/0G	5	

Артикул Стр. Запасная часть Номер модели





















38981/43/10	136	① 38980/67/0G	5	
38982/43/10	136	① 38980/67/0G	5	
38990/06/10	98	① 38990/31/1G	5	
38991/06/10	98	① 38990/31/1G	5	
38992/06/10	98	① 38990/31/0G	5	
38995/17/10	100	① 38995/31/0G	5	
38996/17/10	100	① 38995/31/0G	5	
38997/17/10	100	① 38995/31/0G	5	
39010/86/10	126		5	
39011/86/10	126		5	
39012/86/10	126		5	
40087/17/10	49	① GN022/00/56	5	
40092/34/10	336		5	
40093/55/10	337		5	
40096/34/10	340	① 14094/01/61	5	
40097/01/10	110	① 40097/31/1G	5	
40097/06/10	110	① 40097/31/1G	5	
40097/17/10	110	① 40097/31/1G	5	
40153/55/10	346	① 14094/01/61	5	
40178/55/10	340		5	
40192/31/10	54		5	
40192/48/10	54		5	
40199/30/10	66	① GS000/90/67	5	
40199/31/10	66	① GS000/90/67	5	
40204/55/10	347		5	



Артикул Стр. Запасная часть Номер модели

40227/11/10	70		5	
40228/11/10	70		5	
40229/55/10	338		5	
40239/30/10	76	Ⓢ HA059/50/60	5	
40242/33/10	65	Ⓢ GS008/75/60	5	
40242/53/10	65	Ⓢ GS008/75/60	5	
40242/60/10	65	Ⓢ GS008/75/60	5	
40245/31/10	67		5	
40245/33/10	67		5	
40245/53/10	67		5	
40249/06/10	85	△ 40249/43/0S	5	
40249/31/10	85	△ 40249/31/0S	5	
40271/38/10	86	Ⓢ GR006/70/67	5	
40271/43/10	86	Ⓢ GR006/70/67	5	
40277/31/10	85		5	
40278/31/10	85	△ 40278/31/0S	5	
40279/55/10	343		5	
40280/55/10	338		5	
40281/34/10	348		5	
40282/30/10	35	△ 36678/30/0S	5	
40282/38/10	42	△ 36678/31/0S	5	
40311/11/10	33		5	
40318/31/10	322	Ⓢ GR009/00/67	5	
40334/15/10	110	Ⓢ HA090/50/12	5	
40334/38/10	110	Ⓢ HA090/50/10	5	























Артикул Стр. Запасная часть Номер модели

40353/31/10	54	Ⓢ GS000/82/31	5	
40353/48/10	54	Ⓢ GS000/82/31	5	
40354/20/10	69		5	
40354/34/10	68		5	
40354/35/10	68		5	
40356/20/10	340		5	
40388/17/10	45	Ⓢ GQ025/00/31	5	
40389/17/10	45	Ⓢ GQ025/10/31	5	
40396/60/10	57		5	
40426/35/10	341	△ 40426/35/0S	5	
40427/34/10	341	△ 40427/34/0S	5	
40430/17/10	27	Ⓢ GS011/80/56	5	
40433/30/10	58		5	
40434/30/10	58		5	
40435/11/10	57	Ⓢ HA099/70/60	5	
40436/30/10	43	△ 40436/30/0S	5	
40436/31/10	43	△ 40436/31/0S	5	
40509/55/10	344	△ 40509/53/0S	5	
40536/11/10	79		5	
40564/11/10	80		5	
40566/31/10	50		5	
40566/48/10	50		5	
40567/31/10	51		5	
40567/38/10	51		5	
40567/48/10	51		5	

Артикул Стр. Запасная часть Номер модели

40568/48/10	37	5		413987 080814
40568/93/10	36	5		413987 080821
40571/38/10	34	5		413987 081408
40571/43/10	34	5		413987 081415
40573/11/10	46	5		413987 081088
40574/30/10	46	5		413987 081385
40574/31/10	46	5		413987 081392
40580/30/10	84	5		413987 082153
40580/87/10	84	5		413987 081446
40590/55/10	334	5		413987 081125
40591/55/10	334	5		413987 081217
40592/55/10	335	5		413987 081262
40593/55/10	335	5		413987 081255
40594/55/10	335	5		413987 081224
40595/48/10	21	5		413987 094460
40596/48/10	21	5		413987 094620
40599/17/10	44	5		413987 094682
40600/17/10	44	5		413987 094699
40601/17/10	52	5		413987 094590
40616/31/10	53	5		413987 094477
40616/48/10	53	5		413987 094484
40617/31/10	55	5		413987 094132
40617/57/10	55	5		413987 094149
40617/93/10	55	5		413987 094156
40622/30/10	86	5		413987 094286

Артикул Стр. Запасная часть Номер модели

40622/31/10	86	5		413987 094293	
40625/17/10	48	5		413987 094668	
40626/31/10	139	5		413987 094583	
40627/31/10	342	5		413987 094729	
40628/32/10	349	5		413987 094811	
40629/31/10	349	5		413987 094804	
40631/20/10	344	5		413987 094712	
40634/17/10	48	5		413987 098734	
40643/11/10	64	5		413987 094514	
41157/55/10	338	5		413987 057465	
41577/31/10	89	5		413987 080975	
41577/87/10	88	5		413987 080982	
41592/30/10	70	△	41592/30/0S	5 	413987 030956
41592/31/10	70	△	41592/31/0S	5 	413987 001536
41593/31/10	27	⊙	GN054/30/31	5 	413987 031007
41594/28/10	342	△	41594/28/0S	5 	413987 030826
		⊙	GF010/80/00		
41595/30/10	42	5		413987 030925	
41596/30/10	47	⊙	GS010/70/31	5 	413987 030666
41596/31/10	47	⊙	GS010/70/31	5 	413987 030673
41597/31/10	47	⊙	GN054/30/31	5 	413987 030635
41598/30/10	49	⊙	41598/30/0G	5 	413987 030642
41598/31/10	49	⊙	41598/31/0G	5 	413987 030659
41599/31/10	48	⊙	GS000/90/67	5 	413987 033049
41614/43/10	140	⊙	GN054/10/60	5 	413987 030598























Артикул Стр. Запасная часть Номер модели

41615/43/10	140	Ⓢ GN054/20/60	5	
41631/60/10	140		5	
41631/62/10	139		5	
41632/11/10	31	Ⓢ HA082/70/60	5	
41633/11/10	31	Ⓢ HA083/40/60	5	
41634/11/10	31	Ⓢ HA083/40/60	5	
41648/33/10	66	Ⓢ GS009/60/33	5	
41648/35/10	66	Ⓢ GS009/60/35	5	
41648/53/10	66	Ⓢ GS009/60/53	5	
41683/60/10	72		5	
41750/31/10	47	Ⓢ GN038/61/56	5	
41757/43/10	139	Ⓢ HA059/10/62	5	
41766/30/10	76	△ 41766/30/0S	5	
		Ⓢ HA059/00/30		
41766/31/10	77	△ 41766/31/0S	5	
		Ⓢ HA059/00/31		
41767/30/10	76	△ 41766/30/0S	5	
		Ⓢ HA059/00/30		
41767/31/10	77	△ 41766/31/0S	5	
		Ⓢ HA059/00/31		
41782/32/10	71		5	
41782/35/10	71		5	
41782/53/10	71		5	
41787/11/10	78	Ⓢ HA084/20/60	5	
41788/43/10	140		5	

























Артикул Стр. Запасная часть Номер модели

41790/86/10	139		5	
41807/11/10	78	Ⓢ HA060/00/60	5	
41814/30/10	81	Ⓢ HA064/50/32	5	
41814/31/10	78	Ⓢ HA064/50/60	5	
41815/32/10	141		5	
41815/60/10	141		5	
41816/60/10	78	Ⓢ HA059/70/60	5	
41816/62/10	141	Ⓢ HA059/70/62	5	
41820/48/10	57		5	
41823/17/10	47	Ⓢ GN035/00/56	5	
41826/11/10	79	Ⓢ HA059/80/60	5	
41846/06/10	94	Ⓢ GN033/90/56	5	
41846/17/10	94	Ⓢ GN033/90/56	5	
41848/11/10	33	Ⓢ GS006/60/60	5	
41849/11/10	33	Ⓢ GS006/60/60	5	
41850/17/10	32		5	
41853/17/10	32		5	
41856/86/10	81	Ⓢ HA049/90/60	5	
41898/06/10	99	Ⓢ 41898/31/1G	5	
41899/06/10	99	Ⓢ 41898/31/1G	5	
42069/17/10	145	Ⓢ GF035/97/31	5	
42069/43/10	145	Ⓢ GF035/97/43	5	
42070/06/10	146	Ⓢ 79097/00/67	5	
42070/17/10	146	Ⓢ 79097/00/67	5	
42071/06/10	145	Ⓢ GF020/20/84	5	

Артикул Стр. Запасная часть Номер модели

42071/17/10	144	Ⓜ GF020/20/56	5	
42084/06/10	147	Ⓜ 42083/31/0P	5	
		Ⓜ GN033/20/56		
42084/17/10	147	Ⓜ 42083/31/0P	5	
		Ⓜ GN033/20/56		
42089/17/10	63	Ⓜ GS004/80/56	5	
42119/17/10	63	Ⓜ GN046/00/56	5	
42131/87/10	88	△ 42131/87/0S	5	
42184/06/10	142	Ⓜ GN056/00/67	5	
42192/17/10	142	Ⓜ GN058/60/67	5	
42196/17/10	142	Ⓜ GS011/40/67	5	
42196/43/10	142	Ⓜ GS011/40/67	5	
42198/26/10	128	△ 42198/26/0S	5	
42208/11/10	43	△ 42208/30/0S	5	
42209/31/10	63		5	
42209/43/10	63		5	
42232/38/10	34		5	
42232/93/10	34		5	
42643/11/10	64		5	
43131/11/10	61		5	
43133/30/10	61		5	
43133/31/10	61		5	
43133/48/10	60		5	
43208/30/10	112	△ 43208/30/0S	5	
43208/31/10	112	△ 43208/31/0S	5	

Артикул Стр. Запасная часть Номер модели

43210/43/10	113	△ 43210/38/0S	5	
43210/87/10	113	△ 43210/31/0S	5	
43214/30/10	62	△ 43214/30/0S	5	
43214/31/10	62	△ 43214/31/0S	5	
43214/43/10	62	△ 43214/43/0S	5	
43221/30/10	73		5	
43222/56/10	73		5	
43223/33/10	73		5	
43235/31/10	51		5	
43235/38/10	51		5	
43235/48/10	51		5	
43236/20/10	68		5	
43236/34/10	68		5	
43236/35/10	68		5	
43238/11/10	61		5	
43238/93/10	61		5	
43245/55/10	337		5	
43246/55/10	336		5	
43580/31/10	84		5	
43590/55/10	334		5	
43591/55/10	334		5	
43592/55/10	335		5	
45502/55/30	336		5	
45557/55/10	338		5	
45564/11/10	80		5	

Артикул Стр. Запасная часть Номер модели

45568/48/10	37		5		413987 080838
45568/93/10	37		5		413987 080845
45577/31/10	88		5		413987 081057
45577/87/10	88		5		413987 081064
45601/17/10	52		5		413987 094637
45694/28/10	342	△ 41594/28/0S	5		413987 030987
		Ⓢ GF010/80/00			
45912/30/10	112	△ 45912/30/0S	5		413987 019951
45912/31/10	112	△ 45912/31/0S	5		413987 020421
45936/30/10	76		5		412253 997481
45936/31/10	77		5		413987 024504
50920/17/10	217		5		413987 079443
50922/17/10	217		5		413987 082276
50924/17/10	217		5		413987 082290
50929/17/10	217		5		413987 082283
50950/17/10	220		5		413987 077814
50952/17/10	220		5		413987 077821
50954/17/10	220		5		413987 077845
50956/17/10	221		5		413987 077852
50959/17/10	221		5		413987 077838
50990/17/10	218	Ⓢ GF043/40/56	5		413987 034428
50994/17/10	218	Ⓢ GF043/40/56	5		413987 033230
50995/17/10	219	Ⓢ GF043/40/56	5		413987 033261
50999/17/10	218	Ⓢ GF043/40/56	5		413987 033247
51160/43/10	255	Ⓢ GN053/90/56	5		413987 026188

Артикул Стр. Запасная часть Номер модели

51162/43/10	255	Ⓢ GN053/90/56	5		413987 026201
51164/43/10	255	Ⓢ GN053/90/56	5		413987 026249
51169/43/10	255	Ⓢ GN053/90/56	5		413987 026225
51201/30/10	241		5		413987 063091
51201/87/10	241		5		413987 063114
51230/17/10	216	Ⓢ GN064/49/31	5		413987 064890
51231/17/10	216	Ⓢ GN064/49/31	5		413987 064906
51234/17/10	216	Ⓢ GN064/49/31	5		413987 064920
51239/17/10	216	Ⓢ GN064/49/31	5		413987 064913
52030/06/10	247	Ⓢ 14298/00/67	5		412253 800019
52030/17/10	236	Ⓢ 14298/00/56	5		412253 800026
52031/06/10	247	Ⓢ 14298/00/67	5		412253 800040
52031/17/10	236	Ⓢ 14298/00/56	5		412253 800057
52032/06/10	247	Ⓢ 14298/00/67	5		412253 800064
52032/17/10	236	Ⓢ 14298/00/56	5		412253 800071
52033/06/10	247	Ⓢ 14298/00/67	5		412253 800088
52033/17/10	236	Ⓢ 14298/00/56	5		412253 818236
52038/06/10	247	Ⓢ 14298/00/67	5		412253 800125
52038/17/10	236	Ⓢ 14298/00/56	5		412253 800132
52060/17/10	237	Ⓢ GS005/60/56	5		412253 942221
52061/17/10	237	Ⓢ GS005/60/56	5		412253 942313
52062/17/10	237	Ⓢ GS005/60/56	5		412253 942252
52064/17/10	237	Ⓢ GS005/60/56	5		412253 942290
52130/43/10	251		5		413987 037740
52132/43/10	251		5		413987 037672

Артикул Стр. Запасная часть Номер модели

52134/43/10	250		5	
52140/43/10	246	Ⓜ GN055/10/61	5	
52143/43/10	246	Ⓜ GN055/10/61	5	
52144/43/10	246	Ⓜ GN055/10/61	5	
52230/11/10	215		5	
52233/11/10	214		5	
52234/11/10	215		5	
52240/43/10	245		5	
52242/43/10	244		5	
52244/43/10	245		5	
52249/43/10	245		5	
52250/31/10	210		5	
52252/31/10	210		5	
52253/31/10	211		5	
53030/48/10	271		5	
53033/48/10	271		5	
53034/48/10	271		5	
53038/48/10	271		5	
53060/48/10	272		5	
53062/48/10	273		5	
53063/48/10	272		5	
53064/48/10	272		5	
53069/48/10	272		5	
53080/11/10	277		5	
53082/11/10	277		5	

Артикул Стр. Запасная часть Номер модели













53083/11/10	277		5	
53084/11/10	277		5	
53090/31/10	274		5	
53092/31/10	275		5	
53093/31/10	274		5	
53094/31/10	274		5	
53120/11/10	276		5	
53122/11/10	276		5	
53124/11/10	276		5	
53130/48/10	270		5	
53132/48/10	270		5	
53134/48/10	270		5	
53140/48/10	264		5	
53142/48/10	264		5	
53143/48/10	265		5	
53150/48/10	262		5	
53152/48/10	262		5	
53154/48/10	263		5	
53159/48/10	262		5	
54270/17/10	233	Ⓜ GF021/00/56	5	
54272/17/10	233	Ⓜ GF021/00/56	5	
54274/17/10	233	Ⓜ GF021/00/56	5	
54380/31/10	234	Ⓜ GN025/69/31	5	
54382/31/10	235	Ⓜ GN025/69/31	5	
54384/31/10	235	Ⓜ GN025/69/31	5	



Артикул Стр. Запасная часть Номер модели

54389/31/10	235	Ⓢ GN025/69/31	5	
54490/17/10	231		5	
54492/17/10	231		5	
54494/17/10	231		5	
54499/17/10	231		5	
55210/70/10	232		5	
55210/74/10	248		5	
55212/70/10	232		5	
55212/74/10	248		5	
55213/70/10	232		5	
55213/74/10	248		5	
55214/70/10	232		5	
55214/74/10	248		5	
55490/29/10	253		5	
55490/93/10	253		5	
55492/29/10	253		5	
55492/93/10	253		5	
55494/29/10	253		5	
55494/93/10	252		5	
55520/30/10	227		5	
55520/48/10	227		5	
55522/30/10	227		5	
55522/48/10	227		5	
55523/30/10	227		5	
55523/48/10	227		5	

Артикул Стр. Запасная часть Номер модели

55524/30/10	227		5	
55524/48/10	227		5	
55590/30/10	228		5	
55590/67/10	229	Ⓢ GR001/00/67	5	
55592/30/10	228		5	
55592/67/10	229	Ⓢ GI000/80/67	5	
55594/30/10	228		5	
55594/67/10	229		5	
55598/30/10	228		5	
55598/67/10	229		5	
55610/05/10	249		5	
55612/05/10	249		5	
55614/05/10	249		5	
55618/05/10	249		5	
55640/31/10	238		5	
55642/31/10	239		5	
55643/31/10	238		5	
55644/31/10	239		5	
55650/31/10	212		5	
55650/48/10	212		5	
55652/31/10	212		5	
55652/48/10	212		5	
55654/31/10	212		5	
55654/48/10	212		5	
55661/31/10	240		5	

Артикул Стр. Запасная часть Номер модели

55661/48/10	240			5	
55870/30/10	213			5	
55874/30/10	213			5	
55879/30/10	213			5	
55955/86/10	254	Ⓜ GF041/97/31		5	
55957/86/10	254	Ⓜ GF041/97/31		5	
55958/86/10	254	Ⓜ GF041/97/31		5	
55959/86/10	254	Ⓜ GF041/97/31		5	
56173/55/10	348			5	
56230/48/10	226			5	
56232/48/10	226			5	
56233/48/10	226			5	
56234/48/10	226			5	
56300/55/30	339	Ⓜ 56010/56/0G		5	
56303/55/10	339	Ⓜ 56010/56/0G		5	
56310/55/30	339			5	
56314/55/10	339			5	
56320/30/10	225			5	
56320/31/10	225			5	
56322/30/10	225			5	
56322/31/10	225			5	
56324/30/10	225			5	
56324/31/10	225			5	
56330/30/10	224			5	
56330/31/10	224			5	

Артикул Стр. Запасная часть Номер модели

56332/30/10	224			5	
56332/31/10	224			5	
56333/30/10	224			5	
56333/31/10	224			5	
56410/17/10	209			5	
56410/31/10	209			5	
56410/43/10	208			5	
56413/17/10	209			5	
56413/31/10	209			5	
56413/43/10	208			5	
56414/17/10	209			5	
56413/31/10	209			5	
56414/31/10	209			5	
56414/43/10	208			5	
56420/31/10	207			5	
56420/48/10	207			5	
56422/31/10	207			5	
56422/48/10	207			5	
56424/31/10	206			5	
56424/48/10	207			5	
56440/11/10	223			5	
56442/11/10	222			5	
56444/11/10	223			5	
56503/55/10	345			5	
56504/55/10	345			5	
59023/17/10	450	Ⓜ 59023/60/0P		5	

Артикул Стр. Запасная часть Номер модели

59033/17/10	450	59033/60/0P	5	412253  900221
59038/17/10	450	59038/60/0P	5	412253  900238
59040/17/10	440		5	412253  935421
59042/17/10	440		5	413987  062964
59300/17/10	439		5	412253  800163
59302/17/10	439		5	412253  800194
59303/17/10	438		5	412253  800224
59304/17/10	438		5	412253  800248
59323/01/10	445		5	412253  842231
59323/06/10	445		5	412253  842248
59323/11/10	445		5	412253  842255
59323/17/10	445		5	412253  842279
59323/31/10	445		5	412253  842286
59323/48/10	445		5	412253  842293
59330/17/10	444		5	412253  842217
59330/31/10	444		5	412253  842224
59333/01/10	444		5	412253  842095
59333/06/10	444		5	412253  842118
59333/11/10	444		5	412253  842125
59333/17/10	444		5	412253  842149
59333/31/10	444		5	412253  842156
59333/48/10	444		5	412253  849711
59350/17/50	442	GQ008/70/67	5	412253  884743
59383/17/10	451		5	412253  970040
59393/01/10	446		5	412253  879015



Артикул Стр. Запасная часть Номер модели

59393/06/10	446		5	412253  877899
59393/11/10	446		5	412253  878995
59393/17/10	446		5	412253  877875
59393/31/10	446		5	412253  877912
59410/17/10	440		5	412253  884668
59420/17/10	440		5	412253  884699
59453/17/10	451		5	412253  970088
59463/17/10	447		5	412253  936350
59473/17/10	447		5	412253  935025
59500/48/10	439		5	412253  935377
59502/48/10	439		5	412253  935384
59510/17/10	451		5	412253  960690
59510/31/10	451		5	412253  960683
59515/30/10	443	GN039/70/60	5	412253  975014
59515/60/10	443	GN039/70/60	5	412253  975021
59515/67/10	443	GN039/70/67	5	412253  975038
59530/17/10	442		5	413987  008658
59550/17/10	437		5	413987  037429
59550/31/10	437		5	413987  037436
59552/17/10	436		5	413987  037641
59552/31/10	437		5	413987  037399
59553/17/10	437		5	413987  037405
59553/31/10	437		5	413987  037412
59560/11/10	441		5	413987  037559
59562/11/10	441		5	413987  037467

Артикул Стр. Запасная часть Номер модели

59563/11/10	441	Ⓢ GQ022/40/60	5	
59570/17/10	449	Ⓢ GR011/80/67	5	
59570/31/10	449	Ⓢ GR011/80/67	5	
59580/17/10	449	Ⓢ GR011/80/67	5	
59580/31/10	449	Ⓢ GR011/80/67	5	
59590/56/10	448	Ⓢ GN059/70/56	5	
59600/31/10	448		5	
59602/31/10	448		5	
59700/17/10	327	Ⓢ GR003/40/67	5	
59701/17/10	327	Ⓢ GR003/40/67	5	
59702/17/10	327	Ⓢ GR003/40/67	5	
59704/48/10	327	Ⓢ GR003/40/67	5	
59706/31/10	328		5	
59706/48/10	328		5	
59708/17/10	329	Ⓢ GR004/88/69	5	
59763/11/10	443	Ⓢ GQ020/70/60	5	
59764/11/10	443		5	
59785/17/10	452	Ⓢ GR008/80/69	5	
59786/17/10	452	Ⓢ GQ021/80/69	5	
59790/17/10	452	Ⓢ GR008/70/69	5	
59791/17/10	452	Ⓢ GQ021/70/69	5	
59796/17/10	453	Ⓢ GQ007/89/31	5	
59796/31/10	453	Ⓢ GQ007/89/31	5	
59799/17/10	453	Ⓢ GR004/89/31	5	
59799/31/10	453	Ⓢ GR004/89/31	5	

























Артикул Стр. Запасная часть Номер модели

59902/11/10	317		5	
59905/11/10	316	Ⓢ GR002/90/67	5	
59905/17/10	316	Ⓢ GR002/90/67	5	
59910/11/10	316	Ⓢ GR002/90/67	5	
59910/17/10	316	Ⓢ GR002/90/67	5	
59915/17/10	317		5	
59919/17/10	314		5	
59920/17/10	314		5	
59922/17/10	315		5	
59924/17/10	315		5	
66236/34/10	362		5	
66236/35/10	362		5	
66236/87/10	362		5	
66434/17/10	357		5	
66434/87/10	357		5	
66434/91/10	357		5	
66612/06/10	365		5	
66613/06/10	365		5	
66614/30/10	356		5	
66614/87/10	356		5	
66615/20/10	360		5	
66615/30/10	360		5	
66620/28/10	361		5	
66620/32/10	360		5	
66620/33/10	360		5	











Артикул Стр. Запасная часть Номер модели

66705/30/10	354		5	
66705/87/10	354		5	
66706/30/10	355		5	
66706/87/10	354		5	
67002/32/10	363		5	
67002/46/10	363		5	
67002/96/10	363		5	
67010/17/10	364	Ⓢ GF042/07/31	5	
67107/33/10	358		5	
67107/35/10	358		5	
67107/53/10	358		5	
67200/35/10	358		5	
67200/53/10	358		5	
67200/93/10	358		5	
67201/17/10	357		5	
67203/30/10	359		5	
67203/31/10	359		5	
67203/46/10	359		5	
67319/32/10	359		5	
67319/87/10	359		5	
67319/91/10	359		5	
67653/06/10	365		5	
70172/01/60	187	Ⓢ 70172/00/60	5	
70173/01/60	187	Ⓢ 70173/00/00	5	
70368/01/53	189	Ⓢ GS000/10/31	5	

Артикул Стр. Запасная часть Номер модели

70368/01/73	189	Ⓢ GS000/10/31	5	
70418/60/10	181	Ⓢ 70700/00/67	5	
70614/81/34	348	Ⓢ 70700/00/67	5	
70670/01/11	175	Ⓢ 70700/00/67	5	
70700/01/11	176	Ⓢ GS000/10/31	5	
70700/01/17	176	Ⓢ 70700/00/67	5	
70700/01/31	176	Ⓢ GS000/10/31	5	
70708/02/06	186	Ⓢ 70708/00/31	5	
70712/02/17	174	Ⓢ GR001/30/67	5	
70712/03/17	174	Ⓢ GR002/30/67	5	
70748/01/31	190	Ⓢ GN014/17/31	5	
70748/01/43	190	Ⓢ GN014/17/43	5	
70748/02/31	190	Ⓢ GN018/27/31	5	
70748/02/43	190	Ⓢ GN018/27/43	5	
71410/01/30	424	Ⓢ 71412/00/67	5	
71410/01/31	424	Ⓢ 71412/00/67	5	
71416/01/30	424	Ⓢ 71416/00/61	5	
71416/01/31	424	Ⓢ 71416/00/61	5	
71421/01/30	413	Ⓢ 71425/00/60	5	
71424/01/30	413	Ⓢ 71425/00/60	5	
71424/01/31	413	Ⓢ 71425/00/60	5	
71425/01/30	413	Ⓢ 71425/00/60	5	
71425/01/31	413	Ⓢ 71425/00/60	5	
71426/01/30	412	Ⓢ 71425/00/60	5	
71426/01/31	412	Ⓢ 71425/00/60	5	





Артикул Стр. Запасная часть Номер модели

71427/01/30	412	① 71425/00/60	5	
71427/03/30	412	① 71425/00/60	5	
71428/01/30	430	① 71428/60/1P	5	
		① GR001/40/67		
71825/01/31	426	① 14200/00/31	5	
71825/01/65	426		5	
72810/23/17	447		5	
72894/01/31	187	① 14160/00/31	5	
73357/03/54	138	① 75623/00/60	5	
73979/03/43	111	① 73979/00/67	5	
73979/05/43	111	① 73979/00/67	5	
74900/21/30	428	① 74904/00/60	5	
74900/21/31	428	① 74904/00/60	5	
74902/21/30	428	① 74923/00/60	5	
74902/21/31	428	① 74923/00/60	5	
74904/21/30	428	① 74904/00/60	5	
74943/21/30	429	① 74904/00/60	5	
74943/21/31	429	① 74904/00/60	5	
74946/21/30	429	① 74923/00/60	5	
74946/21/31	429	① 74923/00/60	5	
75623/01/54	138	① 75624/00/60	5	
75624/01/54	138	① 75624/00/60	5	
77027/01/43	199	① GN019/50/43	5	
77027/02/43	199	① GN019/70/43	5	
77050/01/06	191	① GS002/10/67	5	

Артикул Стр. Запасная часть Номер модели

77050/01/17	177	① GS002/10/67	5	
77050/01/56	177	① GS002/10/67	5	
77418/11/10	179		5	
77418/60/10	179		5	
78621/01/55	346		5	
79094/22/01	143	① GN026/50/67	5	
79094/22/17	143	① GN026/50/67	5	
79097/22/06	143	① 79097/00/67	5	
79097/22/17	143	① 79097/00/67	5	
80002/02/01	81	① 86518/00/60	5	
80002/05/01	81	① 86518/00/60	5	
80357/01/54	138	① 75623/00/60	5	
80595/01/43	199	① GF009/80/43	5	
80815/69/10	165		5	
81531/01/11	176	① 81531/00/61	5	
81531/01/17	176	① 81531/00/31	5	
81531/01/31	176	① 81531/00/61	5	
81531/01/70	189	① 81531/00/61	5	
81531/01/71	189	① 81531/00/61	5	
81626/01/87	427	① GF046/00/60	5	
81657/01/30	426	① GF046/00/60	5	
81657/01/31	426	① GF046/00/60	5	
81670/01/06	203		5	
81670/01/11	203		5	
81670/02/06	203		5	

Артикул Стр. Запасная часть Номер модели

81670/02/11	203		5	
81748/01/31	190	Ⓜ GF008/67/31	5	
81748/01/43	190	Ⓜ GF008/67/43	5	
81979/01/43	111	Ⓜ 73979/00/67	5	
83244/21/30	363		5	
83244/21/34	363		5	
83244/21/35	363		5	
83244/21/87	363		5	
87098/12/30	429		5	
87098/12/31	429		5	

Артикул Стр. Запасная часть Номер модели





# Техническая информация

---

# 1. Характеристики источников освещения: Massive при поддержке Philips

## Задумайся о природе!

Так как Massive настаивает на сокращении экологического следа при одновременном обеспечении максимального качества освещения, мы полагаемся на технологию Philips. Philips отвечает самым высоким стандартам по следующим критериям.

- 1. Экологичность.**
  - Экономия энергии
  - Без вреда для окружающей среды
- 2. Надежность.**
  - Высокое качество
  - Долгий срок службы
- 3. Качество освещения.**
  - Высокая мощность светового излучения
  - Цветовая температура
- 4. Устойчивое развитие**
  - Взаимовыгодная торговля
  - Обслуживание и поддержка

Дополнительные сведения см. на веб-сайте [www.philips.com](http://www.philips.com)

## Ватт или Люмен?

Мощность лампы в ваттах указывает количество потребляемой ею энергии. Для традиционных ламп мощность в ваттах пропорциональна мощности ожидаемого светового излучения. Однако при использовании энергосберегающих решений дела обстоят совсем иначе. Именно поэтому мы внедряем двойную систему, указывающую и мощность источника света в ваттах, и мощность его светового излучения, выражаемую в люменах (лм).

## Световая температура.

Световая температура, измеряемая в Кельвинах (K), указывает на цвет света. Чем ниже световая температура, тем теплее (желтее) свет; чем выше световая температура, тем свет будет более холодным (белым).

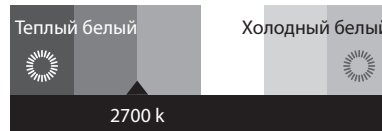

# 2. Характеристики светильников

## Крепления

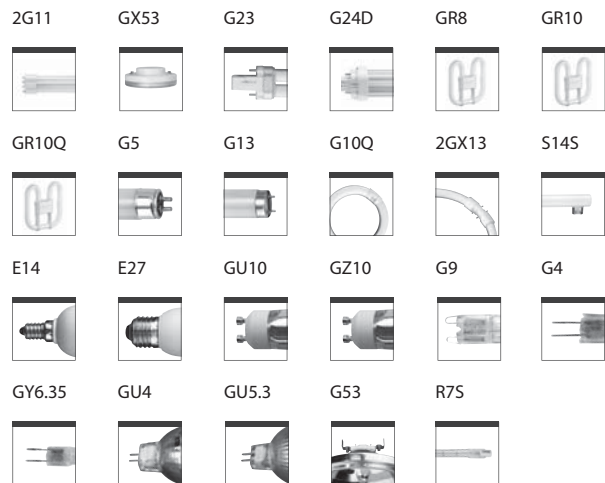

## Источники света

Если источник света входит в комплект поставки, компания Massive всегда предоставляет вместе со своей продукцией источники света Philips.

- Встроенные светодиоды PowerLED Philips**  
Светодиод PowerLED — это источник света века. Его основными преимуществами являются:
  - Сбережение до 80 % энергии по сравнению с обычными лампами
  - Высокая мощность светового потока
  - Теплый белый свет (2700 K)
  - С регулируемой яркостью
  - Срок службы до 20000 часов
- Усовершенствованная конструкция ламп со светодиодной технологией**  
Усовершенствованная конструкция ламп со светодиодной технологией сочетает в себе традиционное крепление с современными светодиодами, что позволяет использовать преимущества встроенных светодиодов в стандартном светильнике.
- Энергосберегающие лампы**  
Энергосберегающие лампы позволяют сэкономить значительно больше энергии по сравнению с обычными лампами, а также имеют более продолжительный срок службы.
- Обычные и галогенные лампы**  
Прежние обычные и галогенные лампы встречаются все реже и заменяются новыми, более энергоэффективными решениями.

В таблице ниже указано среднее количество люмен на ватт для различных источников света.

Мощность в ваттах обычной лампы	Значение люмен для обычной лампы	Эффективность обычной лампы	Эффективность галогенной лампы	Эффективность энергосберегающей галогенной лампы	Эффективность лампы CFL-i	Эффективность светодиодной лампы	Эффективность встроенного светодиода
15Ватт	120 Лм	9-15 Лм/Ватт	10-25 Лм/Ватт	13-32 Лм/Ватт	40-70 Лм/Ватт	10-30 Лм/Ватт	45 Лм/Ватт
25Ватт	220 Лм						
40Ватт	400 Лм						
60Ватт	700 Лм						
75Ватт	900 Лм						
100Ватт	1200 Лм						
150Ватт	1800 Лм						

## Серебристая наклейка

Серебристая наклейка присутствует на каждом светильнике. Обычно оно расположена максимально близко к источнику света. Тем не менее, если она может сказаться на внешнем виде светильника, она будет расположена в нижней или задней его части.

На серебристой наклейке указаны следующие данные.

- Фирма и артикул
- Напряжение, частота и максимальная мощность в ваттах
- Светильник
- Символ F
- Отметки (для каждой отдельной страны и общине)
- Страна происхождения

## Напряжение, частота и мощность в ваттах

Напряжение и мощность в ваттах светильника указаны вместе с техническими данными светильника, которые приведены на упаковке или на серебристой наклейке.

### • Напряжение

Напряжение представляет собой силу электрического тока. Наиболее распространенными значениями напряжения для бытового использования в странах всего мира являются следующие: 110 В, 220 В, 230 В и 240 В. Для всех изделий Massive подходит напряжение 230 В; для большинства из них также подходит напряжение 220–240 В.

### • SELV

SELV является аббревиатурой для “safety extra-low voltage” (безопасное сверхнизкое напряжение). Светильники с отметкой SELV имеют настолько низкую выходную мощность, что опасность поражения электрическим током отсутствует. Перед подключением к источнику питания данные светильники необходимо подключать к трансформатору, и они всегда относятся к классу III.

### • Частота

Частота измеряется в Герцах (Гц) и показывает, сколько раз в секунду электростанция подает переменный ток. В большинстве стран мира данное значение составляет 50 Гц, хотя в Америке оно обычно составляет 60 Гц. Большинство светильников Massive работают как при 50 Гц, так и при 60 Гц. Чтобы убедиться в этом, см. технические характеристики.

### • Мощность в ваттах

Максимальная мощность в ваттах светильника определяется тестированиями, предусмотренными международным стандартом для приборов освещения (IEC60598). Чтобы светильник проработал в течение всего срока службы и несчастные случаи не возникли, не превышайте максимальную мощность в ваттах.

## Электрический класс

Электрический класс показывает, какие меры предосторожности необходимо предпринять, чтобы предотвратить поражение электрическим током.



Для светильников класса I требуется заземление. Контакт с незащищенной частью электропроводки приведет к поступлению тока на землю, в результате чего подача питания будет автоматически отключена.



Для светильников класса II или с двойной изоляцией заземление не требуется. Провода защищены двойным слоем изолирующего материала, поэтому от прикосновения к любой части светильника поражение электрическим током невозможно.



К светильникам класса III относятся только светильники с безопасным сверхнизким напряжением, что означает, что сила тока недостаточно велика для поражения электрическим током. Поэтому дополнительные функции безопасности не требуются.

## F-symbol

В технической информации всегда присутствует обозначение F, указывающее материал, на который безопасно устанавливать светильник.



Подходит для монтажа непосредственно на легковоспламеняющейся поверхности. Данное изделие нельзя покрывать изолирующими или другими подобными материалами.



Не подходит для монтажа непосредственно на легковоспламеняющейся поверхности; монтаж разрешен только на невоспламеняющейся поверхности.



Подходит для непосредственного монтажа на легковоспламеняющейся поверхности. Изделие разрешено накрывать легковоспламеняющимся материалом.

## Значения степени защиты оболочки

IP является аббревиатурой для “Ingress Protection” (защита от пыли и влаги), и после нее всегда стоят 2 цифры. Первая цифра указывает на степень защиты от проникновения пыли или твердых предметов; вторая — на устойчивость светильника к попаданию воды. Чем выше значение, тем выше уровень защиты.

В таблице ниже приведены значения IP, встречающиеся среди данных для светильников Massive, и имеется пояснение для каждой из двух цифр.

Первая цифра ► Вторая цифра ▼	Защита от предметов диаметром более 12,5 мм	Защита от предметов диаметром более 2,5 мм	Защита от предметов, толщина или диаметр которых составляет более 1 мм	Защита от количества пыли, препятствующей работе оборудования	Пыленепроницаемый
Защита от попадания воды отсутствует	IP20				
Защита от вертикального водного потока	IP21 ▲		IP41 ▲		
Защита от водяного орошения	IP23 ◻	IP33 ◻	IP43 ◻		
Защита от водных брызг	IP24 ▲		IP44 ▲	IP54 ◆▲	
Защита от струи воды					IP65 ◆▲▲
Защита от кратковременного погружения					IP67 ◆■
Защита от полного, продолжительного погружения в воду					IP68 ◆■

## Различные способы применения IP

### AQUA: Защита от пыли и влаги

Коробка.

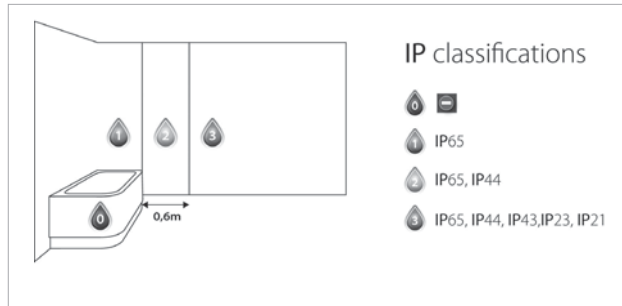

В зависимости от страны.

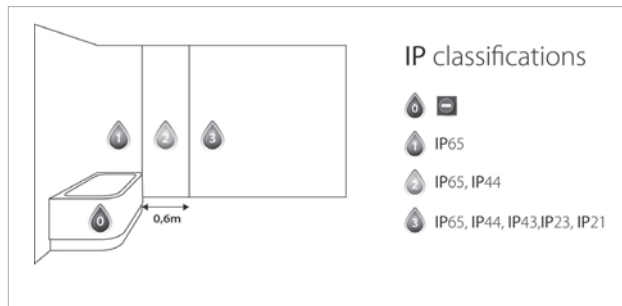

Сверьтесь с местными стандартами электрооборудования

Чтобы степени защиты оболочки были более понятны конечному пользователю, AQUA предложила разделение на зоны. Как показано на данной схеме, ванная комната разделена на 4 зоны. Каждой зоне присвоены номер и цвет капля. Также каждое изделие AQUA имеет номер и окрашенную каплю, в зависимости от степени защиты от пыли и влаги, что упрощает определение местоположения для безопасного монтажа изделия. Так как нормативы изменяются, на упаковке AQUA приведена общая версия данного обозначения. Схемы в зависимости от страны указаны в буклете для пользователей, на потолках TEGO и в выкладке товара.

### Вне помещения: Защита от пыли и влаги в саду

Степень защиты от пыли и влаги, необходимая для используемых вне помещения изделий, зависит от их применения.

#### Наземные светильники акцентного освещения

Тат как они должны выдерживать любые погодные условия, а также периодически находиться в воде, наземные светильники акцентного освещения Massive имеют значение не менее IP67.

#### • Потолочные светильники акцентного освещения

Так как они защищены от прямого попадания дождевой воды и требуют меньшей степени защиты от пыли и влаги, чем при других способах применения, потолочные наружные светильники акцентного освещения Massive имеют степень защиты не менее IP23.

#### • Дополнительное применение

Для всех других способов применения Massive обеспечивает минимальную степень защиты от пыли и влаги IP43.

## Трансформаторы и устройства запуска

### • Трансформаторы

Трансформаторы представляют собой устройства изменения входного напряжения (для наших устройств — питание от сети, обозначенное с помощью PRI (первичное)) на выходное напряжение переменного тока, соответствующее светильнику. В большинстве случаев наши трансформаторы имеют безопасное сверхнизкое напряжение.

Мощность трансформатора указана в вольт-амперах (ВА), что эквивалентно ваттам. Существует два типа трансформаторов.

• Работа традиционных трансформаторов основана на использовании стального сердечника и медной обмотки, что делает эти трансформаторы больше и тяжелее электронных трансформаторов. Они могут быть настолько удалены от источника света, насколько это необходимо, так как толщина соединяющего провода подбирается в соответствии с этим расстоянием. Данный принцип подробно описан в руководствах пользователя тех светильников Massive, комплект которых включает в себя трансформатор.

• В основе электронных трансформаторов лежит использование электронных компонентов, главным среди которых является преобразователь. Они имеют меньший размер и вес, чем традиционные трансформаторы. Длина провода, соединяющего трансформатор с источником света, не может превышать 2 м.

### Выбор соответствующего трансформатора

При подключении нескольких источников света с безопасным сверхнизким напряжением к одному трансформатору их общая мощность не должна превышать общую мощность трансформатора. Например, при установке 5 светильников акцентного освещения мощностью 20 Вт каждый необходимо использовать трансформатор мощностью не менее 100 ВА. Наиболее распространенными являются трансформаторы мощностью 60 ВА, 80 ВА, 105 ВА и 300 ВА.

### • Устройства запуска

Устройства запуска используются совместно со светодиодной технологией и выполняют ту же функцию, что и трансформаторы, а именно — изменяют выходное напряжение и частоту источника питания. Основное различие заключается в том, что трансформаторы генерируют переменный ток, а устройства запуска — постоянный. Комплект светодиодных светильников Massive всегда включает в себя соответствующее устройство запуска.

## 3. Включение и затемнение

### Пассивный инфракрасный выключатель (пассивный инфракрасный датчик движения)

Инфракрасный датчик движения включает свет при значительном изменении температуры в зоне обнаружения, вызванном, например, появлением человека или машины.

#### Функциональные возможности :

- При подключении пассивного инфракрасного датчика движения он автоматически включится для проверки работы, даже в дневное время суток. Спустя приблизительно пять минут после последнего зарегистрированного движения он выключит свет и перейдет в обычный автоматический режим.
- Встроенный датчик освещения обеспечивает работу пассивного инфракрасного датчика движения в автоматическом режиме только в темное время суток. Отдельный переключатель на датчике позволяет вручную настроить интенсивность освещения, при которой светильник включается и выключается.
- Второй переключатель на датчике позволяет настроить период, в течение которого светильник остается включенным после регистрации движения. При использовании энергосберегающих ламп рекомендуется устанавливать максимальную продолжительность данного периода.
- На зону обнаружения датчика может повлиять высота, на которой установлен светильник.

### Сенсорный выключатель, срабатывающий в зависимости от степени освещения

Сенсор, срабатывающий в зависимости от степени освещения, автоматически включает светильник при наступлении темноты и выключает, когда вокруг снова становится светло.

#### Функциональные возможности :

- использовании фотоэлемента, который измеряет интенсивность освещения (в люксах). Он включает светильник, если интенсивность освещения является ниже установленной, и выключает, когда она является выше. Отдельный переключатель на датчике позволяет настроить интенсивность освещения, при которой светильник будет включаться или выключаться.

## Электронный импульсный выключатель

Электронный импульсный выключатель встраивается в светильники с двумя различными источниками света, которые можно включать попеременно. Примером является светильник, который может использоваться, как для акцентного, так и для общего освещения.

### Функциональные возможности:

- Электронный импульсный выключатель не виден в светильнике и используется для подключения основного выключателя к различным источникам света. Он реагирует на импульсы основного выключателя.

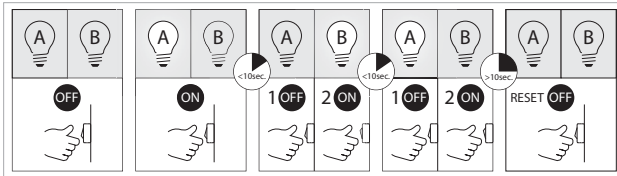

## Затемнение

При затемнении светильника уменьшается мощность светового излучения одного или нескольких источников света. Для светильников определены два типа светорегуляторов.

- **Встроенный светорегулятор:** для некоторых светильников предусмотрен встроенный светорегулятор, который также может использоваться в качестве основного выключателя. В зависимости от типа светорегулятора, мощность светового излучения может изменяться постепенно или пошагово.
- **Внешний светорегулятор:** большинство светильников могут быть подключены к внешнему светорегулятору. Однако функцию затемнения поддерживают не все источники света, и для некоторых требуется светорегулятор специального типа. Перед установкой внешнего светорегулятора ознакомьтесь с данными о совместимости и мерами предосторожности. В случае возникновения сомнений обратитесь за помощью к квалифицированному электрику.

Источник света	Срегулируемой яркостью?	Тип светорегулятора
Лампы накаливания	Да	с большинством светорегуляторов
Высоковольтные галогенные лампы	Да	с большинством светорегуляторов
Низковольтные галогенные лампы	Да, если регулировка яркости выполняется при использовании электронного устройства управления с регулируемой яркостью	с большинством светорегуляторов
CFL-i	Не в целом, на рынке доступны версии с регулируемой яркостью	лампы с регулируемой яркостью могут использоваться с определенными типами светорегуляторов
CFL-Ni	Да, если регулировка яркости выполняется при использовании электронного устройства управления с регулируемой яркостью	светорегулятор определенного типа подходит для затемнения лампы CFL-Ni
Светодиодные лампы	Не в целом, на рынке доступны версии с регулируемой яркостью	с определенными светорегуляторами
Встроенные светодиоды	Да, если регулировка яркости выполняется при использовании электронного устройства управления с регулируемой яркостью	только с симисторными светорегуляторами

## 4. Регламенты, нормы и отметки

### ENEC



ENEC — это знак высокого качества и уровня безопасности, одобренный в странах Европы и присваиваемый различным электрическим устройствам, включая светильники. Его основным преимуществом является свидетельство о соответствии различным регламентам и нормам, что сокращает необходимость получения отдельных отметок для каждой страны. Одобренные ENEC светильники проходят испытания, проводимые независимой организацией в Европе. Все ОСНОВНЫЕ МОДЕЛИ ассортимента продукции Massive одобрены ENEC.

### CE



Наличие отметки CE или знака соответствия стандарту обязательно для продаваемых в Европе светильников. В отличие от знака ENEC, который является официальным знаком, присваиваемым внешней организацией, отметка CE является исключительной ответственностью производителя. Нанося данную отметку на свою продукцию, Massive утверждает, что наша продукция отвечает действующим требованиям по технике безопасности, здравоохранению и охране окружающей среды в ЕС.

### EMC

EMC или “электромагнитная совместимость” означает, что устройство не оказывает нежелательного воздействия на другие устройства, и наоборот. Большинство изделий, реагирующих на электромагнитное воздействие, используются совместно с пультом ДУ, имеют устройство управления или приобретаются вместе с датчиком движения. Все светильники Massive с риском отсутствия электромагнитной совместимости перед получением одобрения проходят тщательную проверку.

## Регулируемые светильники

Регулируемые светильники проходят тщательную проверку, особенно если дело касается температуры: если регулируемая часть изготовлена из металла, ее температура не должна превышать 60° C; для других материалов температурное ограничение составляет 75° C. Для гарантии безопасности нашей продукции Massive часто использует дополнительный компонент (обычно стержень), который позволяет регулировать направления светового луча, не касаясь самой регулируемой части. Конечно же, перед началом производства все изделия проходят тщательную проверку.

## Дизайн, привлекательный для детей

Считается, что светильник понравится ребенку, если он выполнен в форме игрушки и дети могут дотянуться до него и переместить его. Это значит, что потолочный светильник в виде звезды не относится к этой категории, в то время как настольная лампа той же формы вероятнее всего будет представлять интерес. Светильники для детей должны отвечать определенным очень строгим требованиям.

- Класс III — обязательно;
- Максимальная выходная мощность 50W.
- Ребенок может коснуться светильника в любое время, поэтому температура должна оставаться очень низкой.
- Во время температурных испытаний светильник накрывается теплоизоляционным материалом.















# Знаки и символы

## Характеристики продукта













	Экологичный, дружелюбный к природе продукт
<b>PHILIPS</b>	Светильник поставляется с лампой Philips в комплекте
	Регулируемая высота
	Регулируемая высота
	Светильник содержит подвижные детали
	Регулируемая высота
	Только для использования в помещении
	Светильник может быть использован на полу и/или стене (для улицы)
	Светильник может быть использован на потолке и/или стене
	Светильник может монтироваться на поверхность или встраиваться
	Светильник может устанавливаться вертикально и горизонтально

## Диммеры и Выключатели



	Светильник оборудован выключателем
	Светильник оборудован 2 выключателями
	Светильник оборудован выключателем с возможностью выбора мощности 35 Вт/50 Вт
	Светильник оборудован выключателем на проводе
	Светильник оборудован 2 выключателями на проводе
	Светильник оборудован диммером
	Светильник оборудован 2 диммерами
	Светильник оборудован диммером на проводе
	Светильник оборудован выключателем и диммером
	Светильник оборудован выключателем и диммером на проводе
	Светильник оборудован сенсорным диммером
	Светильник оборудован выключателем со шнурком
	Светильник оборудован импульсным выключателем. При быстром нажатии выключателя несколько раз Вы можете поменять освещение, например, если в одном светильнике у Вас установлены 2 типа ламп: галогенные и светодиодные. Нажав 1 раз загорятся галогенные лампы, при быстром двойном нажатии – светодиодные.

	Светильник может выдержать вес до 2 000 кг
	Светильник может выдержать вес человека
	Светильник оборудован инфракрасным датчиком
	Светильник оборудован солнечными батареями
	Светильник оборудован встроенным датчиком автоматического включения в темноте
	Светильник поставляется с кабелем
	Светильник может использоваться с абажуром или без абажура
	Уровень изоляции I
	Уровень изоляции II
	Уровень изоляции III
	Трансформатор встроен или поставляется в комплекте

## Материалы

	Стекло
	Ткань и текстиль
	Дерево, бамбук, тростник
	Кожа
	Керамика и гипс
	Камень, искусственный камень и бетон
	Бумага и картон
	Алюминий и литой алюминий
	Медь
	Оцинкованный металл
	Нержавеющая сталь
	Металл
	Синтетические материалы

## Запасные части

	Синтетические материалы
	Стекло
	Абажур

# Задумайся о природе!



Экологичные «зеленые» продукты могут сократить расходы, энергопотребление и выброс CO<sub>2</sub> в атмосферу. Это решения для тех, кто думает об экологии и природе и заботится о будущем. Светильники Massive - выбор социально ответственных людей!

Мы помогаем сделать переход проще с помощью нашего зеленого логотипа. Этим логотипом отмечены те продукты, которые значительно более энергоэффективны, чем аналоги на рынке или предшествующие модели. Также эти светильники поставляются в комплекте с энергоэффективными лампами (светодиодными, энергосберегающими и т.д.) или могут использоваться только с подобными источниками света.



Начиная с 2010 года все каталоги компании Massive отмечены знаком FSC (знак Лесного попечительского совета). Производя каталоги на такого рода бумаге мы вносим свой вклад в защиту окружающей среды: знак FSC на бумаге удостоверяет, что для производства данной бумаги использовалась древесина, заготовленная неистощительным для лесных экосистем способом.