

**niko**  
Illuminating ideas.

# General catalogue

2011 - 2012

Export

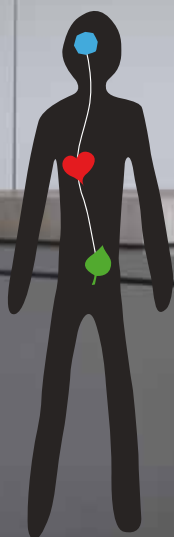

**Niko Home Control**



# Access control

More ease-of-installation? Always welcome!

From the simple but indestructible bell push button to the more sophisticated intercom or videophone - Niko offers a wide range of internal and external units for access control. Easy to install and with unlimited extensibility. More user-friendly than ever thanks to our latest preprogrammed kits.



## NEW INTERNAL UNITS WITH FIRST-RATE DESIGN

- extremely compact design
- design fits in any living room or kitchen
- internal video unit with touch-sensitive controls
- can be mounted in a flush-mounting box
- wide range of functionalities
- extra bell so you never miss a call



## COMPACT, RELIABLE EXTERNAL UNITS

- all external units are made of 3mm- to 7mm-thick aluminium
- surface-mounting version only extends 16 to 20mm from the wall
- double anodised - weather and wind resistant
- impact-resistant and equipped with an anti-vandal name plate
- all external video units are equipped with a colour camera
- razor-sharp image
- good visitor visibility, even at night

## EASY TO INSTALL

- easy to program
- service tool available for analysis and programming
- unlimited extension possibilities



## COMPLETE SOLUTION WITHIN ONE RANGE

- internal and external units in both door intercom and video systems
- the range is suitable for apartments as well as detached homes
- attractive kits for homes
- interfaces for telephone network or video surveillance systems
- solution for access control with scalable levels of access



### Audio kit, hands-free

This two-wire audio kit includes an external unit with one push-button doorbell, an internal unit and a power supply module. The kit is pre-programmed so that all you have to do is connect it! The microphone and speaker on the external unit are adjustable. The external unit is equipped with an illuminated text field for personalisation. The ring tone volume can be adjusted or switched off on the internal unit. The communication with the external unit is hands-free. The door lock can be directly connected to the power supply. The kit is expandable.

- external unit: see 10-151
- power supply: see 10-801
- internal unit: see 10-520
- pre-programmed

#### Expandable with

- 1 internal audio unit 10-520 or 10-511
- 1 external audio unit
- 1 relay 10-831 for controlling an extra gate or enclosure

### Complete pack

Doorcom set audio, handsfree

**10-010**

Pack: 1



### Door communication set video hands-free

This video kit includes the following products: a surface-mounting external video unit made of aluminium with one push-button doorbell and a colour camera, a power supply and a white internal unit with a colour screen and touch-sensitive controls. The kit is pre-programmed so that all you have to do is connect it. The microphone and speaker on the external unit are adjustable. The external unit is equipped with an illuminated text field for personalisation and IR LEDs for better visibility at night. The ring tone volume as well as the image settings can be adjusted on the internal unit. The communication with the external unit is hands-free. The door lock can be directly connected to the power supply. The set is expandable.

- external unit: see 10-401
- power supply: see 10-806
- internal unit: see 10-570
- pre-programmed

#### Expandable with

- 1 internal video unit 10-570 or 10-571 and a splitter 10-824-01

#### OR

with 3 internal audio units 10-511 or 10-520

- 1 external audio unit
- 1 relay 10-831 for controlling an extra gate or enclosure
- protective cap 10-876 for external unit

### Complete pack

Doorcom set video, handsfree

**10-040**

Pack: 1

**Surface mounting external unit 16mm**

The compact surface-mounting unit is made completely of aluminium; the surface-mounting height is only 16mm. This external unit is equipped with a vandal-resistant, 4mm-thick Plexiglas nameplate. The maintenance-free, gold-plated push button contacts guarantee a long life span. Thanks to the 2-wire technology, an existing bell push button can easily be replaced by an external unit.

- adjustable speaker and microphone
- every button has a memory for 2 serial numbers
- confirmation tone for the visitor
- bell push buttons can be used for switching the light
- electronic parts protected against water and corrosion
- removable memory (EEPROM)

**Complete units**

1 bell push button, 153x104x16mm	<b>10-151</b>	Pack: 1
2 bell push buttons, 153x104x16mm	<b>10-152</b>	Pack: 1
3 bell push buttons, 153x104x16mm	<b>10-153</b>	Pack: 1
4 bell push buttons, 153x104x16mm	<b>10-154</b>	Pack: 1
6 bell push buttons, 197x104x16mm	<b>10-156</b>	Pack: 1
8 bell push buttons, 241x104x16mm	<b>10-158</b>	Pack: 1

**Surface mounting external unit 20mm with 1 row of bell push buttons**

This sturdy surface-mounting door intercom unit is finished in 7mm-thick aluminium. The surface-mounting height is only 20mm. The external unit is equipped with a vandal-resistant, 5mm-thick, Plexiglas nameplate. The maintenance-free, gold-plated push button contacts are extremely durable. This series is equipped with large nameplates and is therefore extremely suitable for professional purposes.

By means of the extension modules, this series of external units can be extended to up to a max. of 23 bell push buttons. Extension module with same finish as the external unit. Given that the modules are opened at the bottom, they must be mounted laterally on the external unit.

- adjustable speaker and microphone
- every button has a memory for 2 serial numbers
- confirmation tone for the visitor
- bell push buttons can be used for switching the light
- electronic parts protected against water and corrosion
- removable memory (EEPROM)

**Complete units**

1 bell push button, 166x135x20mm	<b>10-171</b>	Pack: 1
2 bell push buttons, 166x135x20mm	<b>10-172</b>	Pack: 1
3 bell push buttons, 204x135x20mm	<b>10-173</b>	Pack: 1

**Extension modules**

Extension 4 bell push buttons, 166x135x20mm	<b>10-172-01</b>	Pack: 1
Extension 5 bell push buttons, 204x135x20mm	<b>10-173-01</b>	Pack: 1

**Accessories**

Cover cap, 83x139x60mm	<b>10-876</b>	Pack: 1
------------------------	---------------	---------

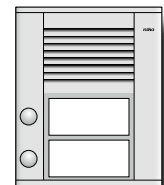
**Surface mounting external unit 20mm with 2 rows of bell push buttons**

This sturdy surface-mounting unit is finished in 7mm-thick aluminium. The surface mounting height is only 20mm. The external unit is equipped with a vandal-resistant, 5mm-thick, Plexiglas nameplate. The maintenance-free, gold-plated push button contacts are extremely durable. Equipped with a double column of bell push buttons and therefore suitable for large housing complexes. This range of external units is available for up to 92 bell push buttons when using the extension modules.

Extension module have the same finish as the external units. Given that the modules are opened at the bottom, they must be mounted laterally on the external unit.

- adjustable speaker and microphone
- every button has a memory for 2 serial numbers
- confirmation tone for the visitor
- bell push buttons can be used for switching the light
- electronic parts protected against water and corrosion
- removable memory (EEPROM)

**Complete units**

4 bell push buttons, 128x135x20mm	<b>10-104</b>	Pack: 1
6 bell push buttons, 147x135x20mm	<b>10-106</b>	Pack: 1
8 bell push buttons, 166x135x20mm	<b>10-108</b>	Pack: 1
10 bell push buttons, 185x135x20mm	<b>10-110</b>	Pack: 1
12 bell push buttons, 204x135x20mm	<b>10-112</b>	Pack: 1

**Extension modules**

Extension 12 bell push buttons, 128x135x20mm	<b>10-112-01</b>	Pack: 1
Extension 14 bell push buttons, 147x135x20mm	<b>10-114-01</b>	Pack: 1
Extension 16 bell push buttons, 2 rows, 166x135x20mm	<b>10-116-01</b>	Pack: 1
Extension 18 bell push buttons, 2 rows, 185x135x20mm	<b>10-118-01</b>	Pack: 1
Extension 20 bell push buttons, 2 rows, 204x135x20mm	<b>10-120-01</b>	Pack: 1

**Accessories**

Cover cap, 83x139x60mm	<b>10-876</b>	Pack: 1
------------------------	---------------	---------

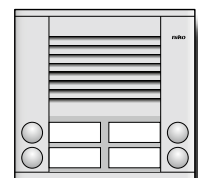



#### Flush mounting external unit with 1 row of bell push buttons

This ultra-flat flush-mounting unit is finished with a 3mm-thick aluminium front plate. This external unit is equipped with a vandal-resistant, 5mm-thick, Plexiglas nameplate. The maintenance-free, gold-plated push button contacts are extremely durable. Thanks to the 2-wire technology, an existing bell push button can easily be replaced by an external unit. Includes flush-mounting box.

- adjustable speaker and microphone
- every button has a memory for 2 serial numbers
- confirmation tone for the visitor
- bell push buttons can be used for switching the light
- electronic parts protected against water and corrosion
- removable memory (EEPROM)

For the dimensions of the flush-mounting box, see technical information.

#### Complete units

1 bell push button, 208x150x3mm	<b>10-201</b>	Pack: 1
2 bell push buttons, 208x150x3mm	<b>10-202</b>	Pack: 1
3 bell push buttons, 208x150x3mm	<b>10-203</b>	Pack: 1
4 bell push buttons, 208x150x3mm	<b>10-204</b>	Pack: 1
6 bell push buttons, 252x150x3mm	<b>10-206</b>	Pack: 1
8 bell push buttons, 296x150x3mm	<b>10-208</b>	Pack: 1
10 bell push buttons, 340x150x3mm	<b>10-210</b>	Pack: 1

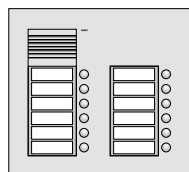

#### Flush mounting external unit with 2 rows of bell push buttons

This ultra-flat flush-mounting unit for door intercom is finished with a 3mm-thick, aluminium front plate. This external unit is equipped with vandal-resistant, 5mm-thick, Plexiglas nameplates. The maintenance-free, gold-plated push button contacts are extremely durable. The panel has 2 columns of bell push buttons. Includes flush-mounting box.

- adjustable speaker and microphone
- every button has a memory for 2 serial numbers
- confirmation tone for the visitor
- bell push buttons can be used for switching the light
- electronic parts protected against water and corrosion
- removable memory (EEPROM)

For the dimensions of the flush-mounting box, see technical information.

#### Complete units

12 bell push buttons, 252x274x3mm	<b>10-212</b>	Pack: 1
14 bell push buttons, 274x274x3mm	<b>10-214</b>	Pack: 1
16 bell push buttons, 296x274x3mm	<b>10-216</b>	Pack: 1
18 bell push buttons, 318x274x3mm	<b>10-218</b>	Pack: 1
20 bell push buttons, 340x274x3mm	<b>10-220</b>	Pack: 1

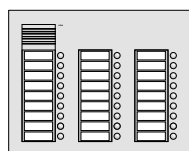

#### Flush mounting external unit with 3 rows of bell push buttons

This ultra-flat flush-mounting unit for door intercoms is finished with a 3mm-thick, aluminium front plate. The external unit is equipped with vandal-resistant, 5mm-thick, Plexiglas nameplates. The maintenance-free, gold-plated push button contacts are extremely durable. The panel has 3 columns of bell push buttons. Includes flush-mounting box.

- adjustable speaker and microphone
- every button has a memory for 2 serial numbers
- confirmation tone for the visitor
- bell push buttons can be used for switching the light
- electronic parts protected against water and corrosion
- removable memory (EEPROM)

For the dimensions of the flush-mounting box, see technical information.

#### Complete units

24 bell push buttons, 296x398x3mm	<b>10-224</b>	Pack: 1
27 bell push buttons, 318x398x3mm	<b>10-227</b>	Pack: 1
30 bell push buttons, 340x398x3mm	<b>10-230</b>	Pack: 1



#### Flush mounting external unit with 7-digit display

This aluminium external unit with 3mm-thick front plate is equipped with a microphone, speaker, numeric keyboard and a 7-segment display. The 7-segment display indicates the entered house number and the programming steps. The door open relay is controlled by entering a PIN code. Suitable for installations containing up to 200 housing units. For larger installations, contact Niko.

- dimensions, front plate: 320mm x 150mm x 3mm
- dimensions, flush-mounting frame: 296mm x 130mm x 50mm
- adjustable speaker and microphone
- every button has a memory for 2 serial numbers
- confirmation tone for the visitor
- electronic parts protected against water and corrosion
- removable memory (EEPROM)

#### Complete units

Flush mounting external unit with 7-digit display	<b>10-280</b>	Pack: 1
---	---------------	---------

**Flush mounting external unit with LCD display**

This aluminium external unit with 3mm-thick front plate is equipped with a microphone, loudspeaker, numeric keypad and a 2-line LCD display. The door open relay can be controlled by entering a PIN code. The LCD display indicates the house number and the name of the occupant. You can look up and call the occupant by means of an alphabetic name list. Suitable for installations of up to 200 housing units. For larger installations, contact Niko.

- front plate: 320mm x 150mm x 3mm
- flush-mounting frame: 296mm x 130mm x 50mm
- adjustable speaker and microphone
- every button has a memory for 2 serial numbers
- confirmation tone for the visitor
- electronic parts protected against water and corrosion
- removable memory (EEPROM)



**Complete units**

Flush mounting external unit with LCD display	<b>10-282</b>	Pack: 1
---	---------------	---------

**Accessories**

PC interface for programming	<b>10-855</b>	Pack: 1
------------------------------	---------------	---------

**Flush mounting door speaker**

Built-in door speaker for installation in existing panels or panels of your own design. In addition to the 16 doorbell push button connections, the module can be expanded with one or more (10-881-01) expansion modules (max. 6).

- dimensions: 112x80x34mm
- adjustable speaker and microphone volume
- microphone can be moved 25cm
- terminal connections for 16 pushbutton contacts
- each button has a memory for two serial numbers
- doorbell buttons can also be used for switching lights on and off
- can be connected to an expansion module
- check tone for the visitor
- removable memory (EEPROM)



Expansion module for installation into own or existing panels for door intercom and videophone. To be connected to built-in speaker 10-880-01.

- dimensions: 104x80x34mm
- terminal connections for 32 pushbutton contacts
- each button has a memory for two serial numbers
- can be connected 4x in cascade
- connection with 10-880-01 via a plug already provided
- removable memory (EEPROM)

**Complete units**

Door loudspeaker	<b>10-880-01</b>	Pack: 1
Extension for door loudspeaker	<b>10-881-01</b>	Pack: 1



### Surface mounting telephone

This surface-mounting telephone is based on 2-wire technology, equipped with the following functions:

- tone distinction between apartment door and front door calls
- busy signal and call indicated with LEDs
- 6 adjustable tones
- automatic conversation interruption after 60s
- door open key (optional: light switch function)
- volume control with slide switch
- colour: white
- dimensions: 212x94x65mm

Base for table mounting of the surface-mounting telephone 10-501.

- colour: aluminium
- incl. 3m cable with RJ12 connector
- dimensions: 185x67x26mm

#### Complete units

Surface-mounting telephone	<b>10-501</b>	Pack: 1
----------------------------	---------------	---------

#### Accessories

Base for table mounting	<b>10-509</b>	Pack: 1
-------------------------	---------------	---------

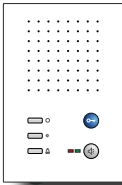

### Handsfree internal audio unit

This compact internal audio unit is standard equipped with the following functions:

- communicate with a visitor
- different ring tones for apartment door, main door and internal calls
- door open key and light switch key
- adjust volume
- switch off ring tone
- indicate busy signal and call signal with LEDs

The internal audio unit is equipped with 5 function keys and a volume adjuster. One of the following functions can be assigned to each free function key:

- transmit control function for relay 10-831
- parallel call
- internal call
- ring-and-come-in function
- call diversion command

The communication with the visitor is handsfree.

- material of the front: plastic
- material of the mounting plate: galvanised metal
- colour: white
- dimensions: 148x98x16mm
- number of keys: 5
- mounting: surface-mounting
- mounting on flush-mounting box possible

#### Complete units

Handsfree internal audio unit	<b>10-520</b>	Pack: 1
-------------------------------	---------------	---------

### Compact surface mounting telephone

Compact surface-mounting telephone equipped with the following functions:

- different ring tones for calls at apartment door, front door or internal call
- choice of 13 different tones
- door open key and light switch key
- volume control for the speaker
- speaker deactivation function
- LED call indication
- additional function key for ring-and-come-in function, internal call, etc.
- colour: white (10-511) or silver (10-511-50)
- dimensions: 201x98x42mm

Base for table mounting of the compact surface-mounting telephone 10-511.

- colour: aluminium
- incl. 3m cable with RJ12 connector
- dimensions: 128x92x27mm

#### Complete units

Compact surface mounting telephone, white	<b>10-511</b>	Pack: 1
---	---------------	---------

Compact surface mounting telephone, silver	<b>10-511-50</b>	Pack: 1
--	------------------	---------

#### Accessories

Base for table mounting	<b>10-519</b>	Pack: 1
-------------------------	---------------	---------





**Compact surface mounting telephone with extension**

Compact surface-mounting telephone consisting of one basic module (10-511) and one extension module. The extension module is equipped with 10 free function keys with feedback LED and name plate. One of the following functions can be assigned to a free function key:

- switching between communication with an external unit and a door open relay
- internal call
- feedback about contact status on bus indicator module (10-840)
- (de)activation of call diversion function
- sending of control function
- colour: white
- dimensions: 215mm x 172mm x 43mm

**Complete units**

Compact surface mounting telephone with extension	<b>10-512</b>	Pack: 1
---	---------------	---------

**Extra bell**

This device can be added to an internal unit as an extra bell so that a call at the door never goes unheard. There is a different tone for a call at an apartment door, the main door or an internal call. The user can easily switch off the extra bell. The ring tone volume can be adjusted at the time of installation. The device is connected to the bus system and can be programmed to work with a bell push button or in parallel with 2 internal units. It is not necessary to add an extra contact or bell transformer.

**Characteristics**

- |  |  |
|--|--|
| <ul style="list-style-type: none"> <li>• material: plastic</li> <li>• colour: white</li> </ul> | <ul style="list-style-type: none"> <li>• dimensions: 98x98x12mm</li> <li>• equipped with an on/off switch</li> <li>• mounting: surface-mounting</li> </ul> |
|--|--|

**Complete units**

Extra bell	<b>10-521</b>	Pack: 1
------------	---------------	---------

**Surface mounting telephone with door opener function**

As a replacement for damaged internal units of Niko's previous door communication system, an extra internal unit was added to the Access Control range. This internal unit can only be used in combination with pre-existing installations and should not be connected to the new external units. This internal unit, just like the previous one (15-591-50), is only equipped with a door open function.

**The previous Niko door communication system is no longer available.**

- colour: white
- dimensions: 212x94x65mm

**Complete units**

Surface-mounting telephone with door opener function	<b>15-591-10</b>	Pack: 1
--	------------------	---------

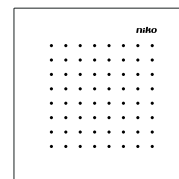

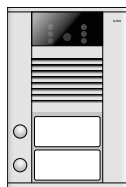

### Surface mounting external unit 20mm with 1 row of bell push buttons and colour camera

This solid surface-mounting unit is equipped with a 7mm-thick finish and has a surface-mounting height of only 20mm. The external unit is equipped with a 5mm-thick, vandal-resistant, Plexiglas nameplate and infrared LEDs for a better visibility at night. The maintenance-free, gold-plated bell push button contacts are extremely durable. Equipped with a built-in colour camera. Due to its extra large nameplates, this external unit is particularly suited for professional purposes. With the extension modules, this external unit can be extended up to a maximum of 22 bell push buttons. Extension module in the same finish as the external units. Given that the modules are to be opened at the bottom, they should be mounted laterally on the external unit.

- adjustable speaker and microphone
- every push button has a memory for 2 serial numbers
- confirmation tone for the visitor
- electronic parts protected against water and corrosion
- removable memory (EEPROM)

#### Specifications of the camera:

- Sony Super HAD CCD sensor
- objective: F2.0; focal distance: 3.6mm
- horizontal resolution: 420 video lines
- light sensitivity: 0.2lux
- video output: 1Vpp, symmetrical

#### Complete units

1 bell push button, 204x135x20mm	<b>10-401</b>	Pack: 1
2 bell push buttons, 204x135x20mm	<b>10-402</b>	Pack: 1
3 bell push buttons, 242x135x20mm	<b>10-403</b>	Pack: 1

#### Extension modules

Extension 4 bell push buttons, 166x135x20mm	<b>10-172-01</b>	Pack: 1
Extension 5 bell push buttons, 204x135x20mm	<b>10-173-01</b>	Pack: 1

#### Accessories

Cover cap, 83x139x60mm	<b>10-876</b>	Pack: 1
------------------------	---------------	---------

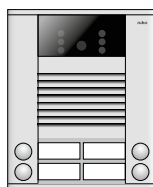

### Surface mounting external unit 20mm with 2 rows of bell push buttons and colour camera

This solid surface-mounting unit is made of 7mm-thick aluminium and has a surface-mounting height of only 20mm. The external unit is equipped with a 5mm-thick, vandal-resistant, Plexiglas nameplate and infrared LEDs for a better visibility at night. The maintenance-free, gold-plated bell push button contacts are extremely durable. Equipped with a double column of bell push buttons, suitable for large housing units, and a built-in colour camera. With the extension modules, this external unit can be extended up to a maximum of 88 bell push buttons. Extension module in the same finish as the external units. Given that the modules are to be opened at the bottom, they should be mounted laterally on the external unit.

- adjustable speaker and microphone
- every push button has a memory for 2 serial numbers
- confirmation tone for the visitor
- electronic parts protected against water and corrosion
- removable memory (EEPROM)

#### Specifications of the camera:

- Sony Super HAD CCD sensor
- objective: F2.0; focal distance: 3.6mm
- horizontal resolution: 420 video lines
- light sensitivity: 0.2lux
- video output: 1Vpp, symmetrical

#### Complete units

4 bell push buttons, 166x135x20mm	<b>10-404</b>	Pack: 1
6 bell push buttons, 185x135x20mm	<b>10-406</b>	Pack: 1
8 bell push buttons, 204x135x20mm	<b>10-408</b>	Pack: 1
10 bell push buttons, 223x135x20mm	<b>10-410</b>	Pack: 1
12 bell push buttons, 242x135x20mm	<b>10-412</b>	Pack: 1
16 bell push buttons, 280x135x20mm	<b>10-416</b>	Pack: 1

#### Extension modules

Extension 16 bell push buttons, 2 rows, 166x135x20mm	<b>10-116-01</b>	Pack: 1
Extension 18 bell push buttons, 2 rows, 185x135x20mm	<b>10-118-01</b>	Pack: 1
Extension 20 bell push buttons, 2 rows, 204x135x20mm	<b>10-120-01</b>	Pack: 1

#### Accessories

Cover cap, 83x139x60mm	<b>10-876</b>	Pack: 1
------------------------	---------------	---------

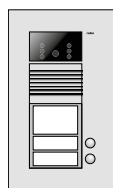

### Flush mounting external unit with 1 row of bell push buttons and colour camera

This ultra-flat flush-mounting external unit with colour camera is finished with a 3mm-thick aluminium front plate. This external unit is provided with a vandal-resistant, 5mm-thick, Plexiglas name plate. The maintenance-free, gold-plated push button contacts are extremely durable. Includes flush-mounting box.

- adjustable speaker and microphone
- every button has a memory for 2 serial numbers
- confirmation tone for the visitor
- electronic parts protected against water and corrosion
- removable memory (EEPROM)

#### Camera data:

- CCD sensor SONY Super HAD
- lens: F 2.0, focus 3.6mm
- 420 lines horizontal
- light sensitivity: 0.2lux
- video output: 1Vpp, symmetrical

For the dimensions of the flush-mounting box, see technical information.

**Complete units**

1 bell push button, 252x150x3mm	<b>10-301</b>	Pack: 1
2 bell push buttons, 252x150x3mm	<b>10-302</b>	Pack: 1
3 bell push buttons, 252x150x3mm	<b>10-303</b>	Pack: 1
4 bell push buttons, 252x150x3mm	<b>10-304</b>	Pack: 1
6 bell push buttons, 296x150x3mm	<b>10-306</b>	Pack: 1
8 bell push buttons, 340x150x3mm	<b>10-308</b>	Pack: 1

**Flush mounting external unit with 2 rows of bell push buttons and colour camera**

This ultra-flat, aluminium flush-mounting external unit with colour camera is equipped with a vandal-resistant, 5mm-thick, Plexiglas name plate. The maintenance-free, gold-plated push button contacts are extremely durable. The panel has 2 columns of bell push buttons. Includes flush-mounting box.

- adjustable speaker and microphone
- every button has a memory for 2 serial numbers
- confirmation tone for the visitor
- electronic parts protected against water and corrosion
- removable memory (EEPROM)

Camera data:

- CCD sensor SONY Super HAD
- lens: F 2.0, focus 3.6mm
- 420 lines horizontal
- light sensitivity: 0.2lux
- video output: 1Vpp, symmetrical

For the dimensions of the flush-mounting box, see technical information.

**Complete units**

10 bell push buttons, 274x274x3mm	<b>10-310</b>	Pack: 1
12 bell push buttons, 296x274x3mm	<b>10-312</b>	Pack: 1
14 bell push buttons, 318x274x3mm	<b>10-314</b>	Pack: 1
16 bell push buttons, 340x274x3mm	<b>10-316</b>	Pack: 1

**Flush mounting external unit with 3 rows of bell push buttons and colour camera**

Ultra-flat, aluminium flush-mounting external unit with colour camera is equipped with a vandal-resistant, 5mm-thick, Plexiglas name plate. The maintenance-free, gold-plated push button contacts are extremely durable. The panel has 3 columns with bell push buttons. Includes flush-mounting box.

- adjustable speaker and microphone
- every button has a memory for 2 serial numbers
- confirmation tone for the visitor
- electronic parts protected against water and corrosion
- removable memory (EEPROM)

Camera data:

- CCD sensor SONY Super HAD
- lens: F 2.0, focus 3.6mm
- 420 lines horizontal
- light sensitivity: 0.2lux
- video output: 1Vpp, symmetrical

For the dimensions of the flush-mounting box, see technical information.

**Complete units**

18 bell push buttons, 296x398x3mm	<b>10-318</b>	Pack: 1
21 bell push buttons, 318x398x3mm	<b>10-321</b>	Pack: 1
24 bell push buttons, 340x398x3mm	<b>10-324</b>	Pack: 1

**Flush mounting camera module**

Flush-mounting camera module for flush mounting in existing panels or panels of your own design. The camera module can be used in combination with the flush-mounting door speaker (10-880-01) and extension module (10-881-01).

Specifications of the camera:

- Sony Super HAD CCD sensor
- horizontal resolution: 420 video lines

- image width: 3.6mm (70° horizontal, 50° vertical)
- light sensitivity: 0.1lux at F2.0

**Complete units**

Flush mounting camera module	<b>10-496</b>	Pack: 1
------------------------------	---------------	---------

**Accessories**

Flush surround frame aluminium	<b>10-896</b>	Pack: 1
--------------------------------	---------------	---------

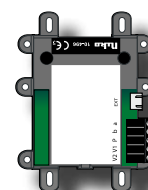
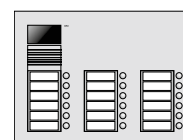
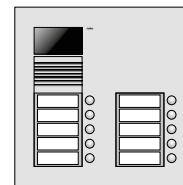



#### Flush mounting external unit with LCD display 128x128 pixels and colour camera

This flush-mounting external unit with 3mm-thick aluminium front plate is equipped with a microphone, a speaker, a scroll wheel, an LCD display, 128x128 pixels, and built-in colour camera. On the LCD display, both the house number and the name of the occupant are displayed. With the scroll wheel, you can run through the menu and retrieve the desired occupant via an alphabetical name list. Programming by means of the supplied programming tool. This external unit is suitable for 200 housing units. For larger installations, please contact Niko.

**Available on request. Contact Niko for more information and project support.**

- dimensions, front plate: 670mm x 200mm x 3mm
  - dimensions, flush-mounting frame: 650mm x 180mm x 50mm
  - adjustable speaker and microphone
  - every button has a memory for 2 serial numbers
  - confirmation tone for the visitor
  - electronic parts protected against water and corrosion
  - removable memory (EEPROM)
- Camera data:
    - CCD sensor SONY Super HAD
    - lens: F 2.0, focus 3.6mm
    - 420 lines horizontal
    - light sensitivity: 0.2lux
    - video output: 1Vpp, symmetrical

#### Complete units

Flush mounting external unit with LCD display	<b>10-384</b>	Pack: 1
---	---------------	---------

#### Parts

PC interface for programming	<b>10-855</b>	Pack: 1
------------------------------	---------------	---------



#### Flush mounting external unit with 7-digit display with colour camera

This external unit is equipped with a 3mm-thick aluminium front plate and a microphone, a speaker, numeric keyboard, 7-segment display and built-in colour camera module. The 7-segment display displays the house number entered and the programming steps to be followed. The door opener relay is controlled by inserting a PIN code. For this purpose, relay 10-835 or 10-836 can be used. Suitable for installations with up to 200 housing units. For larger installations, contact Niko.

- dimensions, front plate: 425mm x 150mm x 3mm
  - dimensions, flush-mounting frame: 401mm x 130mm x 50mm
  - adjustable speaker and microphone
  - every button has a memory for 2 serial numbers
  - confirmation tone for the visitor
  - electronic parts protected against water and corrosion
  - removable memory (EEPROM)
- Camera data:
    - CCD sensor SONY Super HAD
    - lens: F 2.0, focus 3.6mm
    - 420 lines horizontal
    - light sensitivity: 0.2lux
    - video output: 1Vpp, symmetrical

#### Complete units

Flush mounting external unit with 7-digit display	<b>10-380</b>	Pack: 1
---	---------------	---------



#### Flush mounting external unit with LCD display and colour camera

This external unit with 3mm-thick, aluminium front plate is equipped with a microphone, a speaker, a numerical keyboard, a 2-line LCD display and a built-in colour camera module. On the LCD display, both the house number and the name of the occupant are displayed. Via an alphabetical name list, you can call the desired occupant and you can activate the door opener via a PIN code. Programming by means of the software 10-855. This unit is suitable for a max. of 200 housing units. For larger installations, please contact Niko.

- dimensions, front plate: 425mm x 150mm x 3mm
  - dimensions, flush-mounting frame: 401mm x 130mm x 50mm
  - adjustable speaker and microphone
  - every button has a memory for 2 serial numbers
  - confirmation tone for the visitor
  - electronic parts protected against water and corrosion
  - removable memory (EEPROM)
- Camera data:
    - CCD sensor SONY Super HAD
    - lens: F 2.0, focus 3.6mm
    - 420 lines horizontal
    - light sensitivity: 0.2lux
    - video output: 1Vpp, symmetrical

#### Complete units

Flush mounting external unit with LCD display	<b>10-382</b>	Pack: 1
---	---------------	---------

#### Accessories

PC interface for programming	<b>10-855</b>	Pack: 1
------------------------------	---------------	---------

#### External surface mounting camera

This surface-mounting camera is suitable for outdoor use and can be rotated horizontally and vertically. Suitable for rapidly changing weather conditions. This colour camera is equipped with a varifocus lens. Infrared LEDs provide a better visibility at night.

**Available until July 2011. Replaced by 10-490-02.**

- Specifications of the colour camera:
- Sony Super HAD CCD sensor
  - horizontal resolution: 480 video lines
  - varifocus f: 4 – 9mm; externally adjustable
- 16 infrared LEDs
  - light sensitivity: 0lux (at night with IR LEDs) up to 8m; 0.3lux (at night): black and white image; 5lux: colour image
  - operating temperature: -20 – 50°C

#### Complete unit

External surface mounting camera	<b>10-490-01</b>	Pack: 1
----------------------------------	------------------	---------

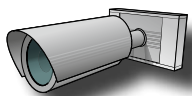

**Outdoor surface-mounting camera with video transmitter**

Surface-mounting camera for outdoor use, rotatable in horizontal and vertical direction. Suitable for rapidly changing weather conditions. This colour camera is equipped with a varifocus lens and IR LEDs for better visibility at night.

Video transmitter 10-498 included and connected to the camera by 2 wires (power supply) and a coax cable. The video transmitter is supplied via the bus and transforms the camera signal into a signal that is suitable for transmission over a twisted pair in the wiring.

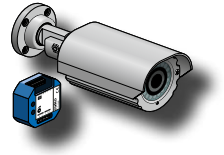

**Available starting from May 2010. Replaces 10-490-01.**

Camera:

- Colour camera CCD Interline Transfer
- 550 lines horizontal, PAL
- Light sensitivity
  - o 0.3lux (colour image)
  - o 0.1lux (black/white image)
  - o IR sensible sensor
- Varifocus  $f = 3.3$  to 12mm at F1.2; adjustable at installation
- Back light compensation
- Housing: aluminium
- Rotatable

- Input voltage: 12V DC
- Output signal: 1Vpp FBAS 75Ω
- Ambient temperature: -20 to 55°C

Video transmitter:

- Input impedance: 75Ω
- Output impedance: 100Ω (symmetrical)
- Video signal adjustment range: -10 to +4dB
- Camera power supply: 12V; max. 250mA
- Dimensions: 51x51x22mm

**Complete unit**

Outdoor surface-mounting camera with video transmitter

**10-490-02**

Pack: 1

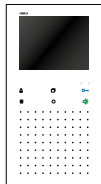

#### Handsfree internal video unit with colour display

This compact, surface-mounting, internal video unit with colour screen is standard equipped, among other things, with the following functions:

- communicate with a visitor
- different ring tones for apartment door, main door and internal calls
- door open key and light switch key
- adjust volume and image
- switch off ring tone
- activate camera images
- indicate busy signal and call signal with LEDs
- transmit control function for relay 10-831
- parallel call
- internal call

The controls consist of touch-sensitive keys and a menu which appears on the screen. The communication with the visitor is handsfree.

- material: plastic
- colour: white
- dimensions: 180x95x20mm
- TFT colour screen: 70x52mm
- number of keys: 6
- menu languages: Dutch, French, German, English, Slovak
- mounting: surface-mounting
- mounting on flush-mounting box possible

#### Complete unit

Handsfree internal video unit with colour display

**10-570**

Pack: 1



#### Aluminium handsfree internal video unit with colour screen

This compact, surface-mounting, internal video unit is standard equipped with the following functions:

- communicate with a visitor
- different ring tones for apartment door, main door and internal calls
- door open key and light switch key
- adjust volume and image
- switch off ring tone
- activate camera images
- indicate busy signal and call signal with LEDs

The internal video unit is equipped with 5 function keys and a menu that can be consulted via 3 navigation keys on the side of the device. One of the following functions can be assigned to each free function key:

- transmit control function for relay 10-831
- parallel call
- internal call
- switch light on/off
- ring-and-come-in function
- call diversion command

The communication with the visitor is handsfree.

- material: aluminium and plastic
- colour: black and aluminium
- dimensions: 104x153x19mm
- TFT colour screen: 68x50mm
- number of keys: 8
- mounting: surface-mounting
- mounting on flush-mounting box possible

#### Complete unit

Aluminium handsfree internal video unit with colour screen

**10-571**

Pack: 1

**Power supply 20**

This central bus power supply for DIN rail mounting is suitable for door communication and video installations. For use as a door communication power supply, a maximum of 20 internal units (10-501 and 10-511) or 6 internal units (10-520) and 2 illuminated external units can be connected. For use as a bus power supply for video installations, an additional DC power supply (10-805-01) is always required for powering the monitors. The power supply is equipped with connections for the bus, a potential-free relay contact for light switching and an AC output for 8 – 12V door openers. The front is equipped with a program key, a control LED and potentiometers to adjust the activation time of the door opener and the light switch contact.

- power supply voltage: 230V~
- bus power supply: 24 ± IV
- light switch contact: potential-free relay contact
- activation time of the light switch contact: 0.5" – 5'
- output voltage of the door key: 8 – 12V~
- activation time of the door opener: 0.8" – 8"
- current: 50mA for 2-wire connection, 130mA for 3-wire connection (P-wire)
- dimensions: 90x72x70mm (4U)

**Complete units**

Power supply 20	<b>10-801</b>	Pack: 1
-----------------	---------------	---------

**Power supply 100**

Central supply for door communication installations with maximum 80 internal units (10-501 and 10-511) or 24 internal units (10-520) and maximum 4 illuminated external units, depending on the chosen types. The power supply is equipped with connections for 3 2-wire buses, 1 additional power supply terminal P, 1 potential-free relay contact for light switching and 1 potential-free contact for controlling the relay for the door opener. The activation time of the door opener and the light switch contact is adjustable. Equipped with a start-up control LED.

- power supply voltage: 230V~
- bus power supply: 24 ± IV
- light switch contact: potential-free relay contact (max. 24V/1A)
- activation time of the light switch contact: 0.5" – 5'
- switch contact door lock: potential-free relay contact (max. 24V/1A)
- activation time of the door opener: 0.8" – 8"
- current: max. 280mA (3 buses together)
- dimensions: 90x105x70mm (6U)

**Complete units**

Power supply 100	<b>10-802</b>	Pack: 1
------------------	---------------	---------

**Video power supply**

Video power supply for DIN rail mounting, suitable for one video system with 1 external unit and maximum 12 internal units. No parallel operation of monitors allowed. Extension possibilities limited to internal audio units, 1 external audio unit and 1 relay. Provided with an output contact for light switching and an AC power supply output for opening an electric door lock. The activation time of both contacts can be adjusted by means of potentiometers at the front.

- power supply voltage: 230V~
- bus power supply: 26 ± IV
- light switch contact: 8 – 12V~ (external transformer 10-819)
- activation time of the light switch contact: 0.5" – 5'
- output voltage of the door key: 8 – 12V~
- activation time of the door opener: 0.8" – 8"
- dimensions: 90x105x70mm (6U)

**Complete units**

Video power supply	<b>10-806</b>	Pack: 1
--------------------	---------------	---------

**Direct current 2.5A**

This DC power supply for expanded video systems is suitable for DIN rail mounting. Is always used in combination with power supply 10-801 or 10-802.

- dimensions: 90mm x 140mm x 70mm (8U)
- input: 230V ± 15%
- output: 26V (Imax: 2.5A)

**Complete units**

Direct current 2.5A	<b>10-805-01</b>	Pack: 1
---------------------	------------------	---------

**Transformer**

Transformer for power supply unit of door openers.

- power supply voltage: 230V AC
- output voltage: 8V AC (2A), 12V AC (1.3A)
- housing: suitable for DIN rail mounting, 2U

**Complete units**

Transformer	<b>10-819</b>	Pack: 1
-------------	---------------	---------

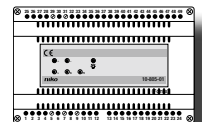
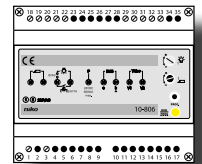
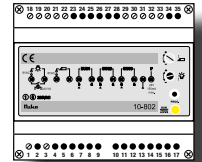
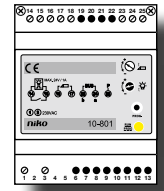

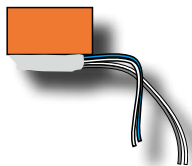

#### Relay for external unit

External relay for opening a lock. Suitable for flush mounting in all external units.

- dimensions: 20x26x6mm
- relay contact: 24V, 2A

#### Complete units

Relay 1	<b>10-835</b>	Pack: 1
---------	---------------	---------

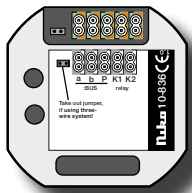

#### Flush mounting relay

This external relay for opening a lock reacts to the door open function without additional programming. In case several relay modules are used, programming is carried out by means of the service unit. Suitable for mounting in flush-mounting boxes.

- dimensions: 51mm x 51mm x 22mm
- bus power supply: 24V ± IV
- potential-free relay contact: 2A

#### Complete units

Flush mounting relay 2	<b>10-836</b>	Pack: 1
------------------------	---------------	---------

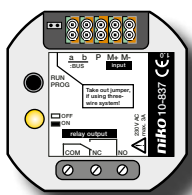

#### Universal flush mounting relay

This external, potential-free relay is equipped with a potential-free input contact and can be used as an N.C. or an N.O. contact. This relay is used for the connection of an additional bell or as a light switch. Suitable for mounting in flush-mounting boxes.

- dimensions: 51mm x 51mm x 22mm
- bus power supply: 24V ± IV
- potential-free relay contact: 230V AC, 3A

#### Complete units

Flush mounting relay universal	<b>10-837</b>	Pack: 1
--------------------------------	---------------	---------



#### DIN rail relay

Universal relay for DIN-rail mounting (10-830) for connection of an additional bell, use as a light switch, etc. Equipped with a potential-free input contact. The functions of both the output contact and the input contact are freely programmable. The relay switches its output when the control function of the internal audio units (10-51x), the video internal units or the code keyboard is used. The relay output switching time is adjustable. The input contact switches the output contact according to the pre-set time.

- potential-free relay contact: 230V, 3A
- potential-free input contact
- time settings for contact: 0-63s
- LED indication for input and output
- dimensions: 85mm x 18mm x 65mm (1U)
- 3-wire connection required (a, b, P)

#### Complete units

DIN rail relay universal	<b>10-830</b>	Pack: 1
DIN-rail relay, preprogrammed	<b>10-831</b>	Pack: 1



**Flush mounting splitter 2**

Flush-mounting video splitter for splitting video signals over 2 circuits. Equipped with an active amplifier. Depending on the number of participants, more than one video splitter can be included in an installation.

- dimensions: 51mm x 51mm x 22mm
- power consumption: I(a) = 0.0mA; I(Pmax) = 60mA
- signal gain: 0dB to +12dB (linear)
- max. output signal: 4Vpp (in case of 1Vpp at the input and a terminal resistor of 100Ω)

**Complete units**

Flush mounting splitter 2	<b>10-821-01</b>	Pack: 1
---------------------------	------------------	---------

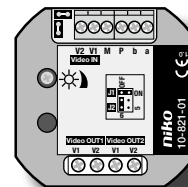

**Modular splitter 2**

Video splitter for DIN rail mounting. Suitable for splitting the video signal over 2 circuits. Equipped with active amplifiers. Depending on the number of participants, more than one video splitter can be included in an installation.

- dimensions: 90mm x 72mm x 70mm (4U)
- power consumption: I(a) = 0.0mA; I(Pmax) = 75mA
- signal gain: 0dB to +12dB (linear)
- max. output signal: 4Vpp (in case of 1Vpp at the input and a terminal resistor of 100Ω)

**Complete units**

Modular splitter 2	<b>10-824-01</b>	Pack: 1
--------------------	------------------	---------

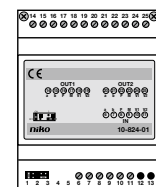

**Modular splitter 4**

Video splitter for DIN rail mounting. Suitable for splitting the video signals over 4 circuits. Equipped with active amplifiers. Depending on the number of participants, more than one video splitter can be included in one installation.

- dimensions: 90mm x 105mm x 70mm (6U)
- power consumption: I(a) = 0.0mA; I(Pmax) = 120mA
- signal gain: 0dB to +12dB (linear)
- max. output signal: 4Vpp (in case of 1Vpp at the input and a terminal resistor of 100Ω)

**Complete units**

Modular splitter 4	<b>10-822-01</b>	Pack: 1
--------------------	------------------	---------

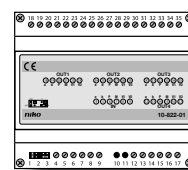

**Modular video switcher 4**

Video distributor for DIN rail mounting. Sends the video signal from max. 4 external units or cameras to 1 output. Several video switchers (max. 5) can be connected in cascade for installations with more than 4 external units.

- dimensions: 90mm x 105mm x 70mm (6U)
- power supply: 26V (P wire)
- power consumption: 45mA
- 4 video inputs, 1 video output

**Complete units**

Modular video switcher 4	<b>10-823</b>	Pack: 1
--------------------------	---------------	---------

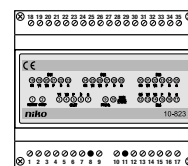

**Flush mounting floor video switcher**

This floor video switcher can select 2 video signals for 1 internal unit with a monitor. Per monitor, the floor video switcher can select the image of the floor external unit or the main external unit.

- dimensions: 52mm x 52mm x 23mm
- power consumption: I(a) = 0.4mA; I(Pmax) = 9mA

**Complete units**

Flush mounting floor video switcher	<b>10-825</b>	Pack: 1
-------------------------------------	---------------	---------

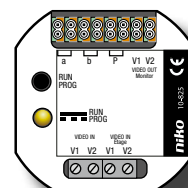

**Video transmitter**

Video transmitter for the connection between an external camera with coax connection and the bus. Is powered via the P wire of the bus and can be used at any location.

- input impedance: 75Ω
- output impedance: 100Ω symmetrical
- adjustment range video signal: -10dB to +4dB
- camera power supply: 12V; max. 250mA
- dimensions: 51mm x 51mm x 22mm

**Complete units**

Video transmitter	<b>10-498</b>	Pack: 1
-------------------	---------------	---------

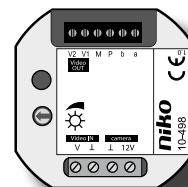

**Video receiver**

This video receiver connects a video signal to a coaxial system. It is used for displaying the image on a TV set or a video recorder, and it is powered via the P wire of the bus. The receiver can be used at any location.

- input impedance: 100Ω symmetrical
- output impedance: 75Ω
- adjustment range video signal: -10dB to +4dB
- dimensions: 51mm x 51mm x 22mm

**Complete units**

Video receiver	<b>10-499</b>	Pack: 1
----------------	---------------	---------

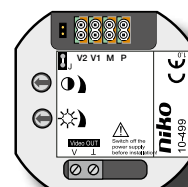

Drawings finished products purely illustrative!

**Complete units**

Video receiver

**10-499**

Pack: 1

**Telephone interface**

Modular interface (6U) for the connection of an access control system to the telephone network via the a/b connection of analogue and ISDN telephone exchanges.

Features:

- parallel switching of up to 64 telephone interfaces
- memory for 16 telephone numbers
- potential-free input
- relay output with programmable switching time
- control of door opener
- control of max. 10 bus relays
- safety function for programming status
- power supply via P wire
- the external unit can be connected to the internal telephones
  
- dimensions: 90mm x 105mm x 70mm (6U)

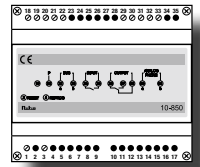

**Complete units**

Telephone interface	<b>10-850</b>	Pack: 1
---------------------	---------------	---------



### Service unit

Device which allows the programming of a complete installation by only 1 person. This set can connect all participants without requiring access to the housing units. Thanks to the built-in call suppression, all basic functions can be tested without disturbing the occupants. The device can also be used for analysing the installation or locating an error.

#### Features:

- is connected to the external unit(s) via a connection plug
- simple programming
- special functions such as programming block
- testing of the speech connections to external and internal units
- indication of bus parameters such as bus voltage, bus commands, etc.
- dimensions: 200mm x 50mm x 35mm

### Complete units

Service set	<b>10-870</b>	Pack: 1
-------------	---------------	---------

### PC interface for programming

PC interface for programming flush-mounted external video units 10-280, 10-282, 10-380, 10-382 and 10-384 with the accompanying PC software. Interface connection via USB. Bus connection via intermediate printed circuit board.

- required PC configuration: min. Windows 98SE
- USB connection: USB 1.1 or USB 2.0

### Complete unit

PC interface for programming	<b>10-855</b>	Pack: 1
------------------------------	---------------	---------

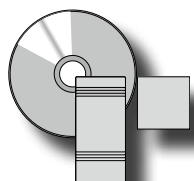

**Code keyboard**

This surface-mounting code keyboard is suitable for indoor and outdoor applications. Made entirely of aluminium. Maximum of 10 different user codes. Various functions can be assigned to a code, such as the bus power supply for a door opener and an external relay contact. The code keyboard can also be used as a stand-alone device. In combination with power supply 10-801, the code keyboard can directly control a door lock. The code keyboard is illuminated with 4 blue LEDs.

- dimensions: 113x88x12mm
- power consumption:  $I(a) = 0.4\text{mA}$ ,  $I(P_{\text{max}}) = 59\text{mA}$
- stand-alone: 24V DC, 60mA
- stand-alone output: 24V DC (for control of a 24V DC relay, such as 10-835)

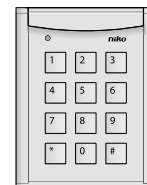
**Complete units**

Code keyboard

**10-901**

Pack: 1

**Surface-mounting access key reader**

This surface-mounting reader for electronic keys is suitable for indoor and outdoor applications. The housing is vandal-resistant, made of aluminium and equipped with an illuminated, 4mm-thick Plexiglas nameplate. In decentralised mode, up to 89 electronic keys can be manually programmed; with the Access Key Programmer software, up to a maximum of 250 keys. In centralised mode (with a PC permanently on-site), up to 2000 electronic keys can be managed thanks to the Access Key Controller software. Various functions can be linked to a key, e.g. switching the door opener of the bus power supply, switching an external relay contact, etc. The device is always part of an installation with a 10-801, 10-802 or 10-806 system power supply.

**Available on request. Contact Niko for more information and project support.**

- dimensions: 153x104x16mm
- NO contact
- 3-wire connection required
- electronic parts protected against water and corrosion
- power consumption:  $I(a) = 0.4\text{mA}$ ,  $I(P) = 4\text{mA}$ ,  $I(P_{\text{max}}) = 60\text{mA}$

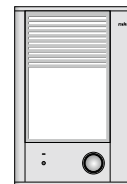
**Complete units**

Surface-mounting access key reader

**10-902**

Pack: 1

**Flush-mounting access key reader**

This flush-mounting reader for electronic keys is suitable for indoor and outdoor applications. The housing is vandal-resistant and made of 8mm-thick, black Plexiglas. In decentralised mode, up to 89 electronic keys can be manually programmed; with the Access Key Programmer software, up to a max. of 250 keys. In centralised mode (with a PC permanently on-site), up to 2000 electronic keys can be managed thanks to the Access Key Controller software. Various functions can be linked to a key, e.g. switching the door opener of the bus power supply, switching an external relay contact, etc. The device is always part of an installation with a 10-801, 10-802 or 10-806 system power supply. The module can be flush mounted in an external unit, type 10-384.

**Available on request. Contact Niko for more information and project support.**

- front dimensions to be flush mounted: 82x82x3mm
- NO and NC contacts
- 3-wire connection required
- electronic parts protected against water and corrosion
- power consumption:  $I(a) = 0.4\text{mA}$ ,  $I(P) = 4\text{mA}$ ,  $I(P_{\text{max}}) = 60\text{mA}$

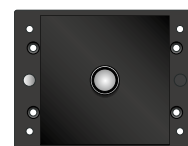
**Complete units**

Flush-mounting access key reader

**10-903**

Pack: 1

**Set of 50 access keys**

These electronic keys are suitable to be used with type 10-902 and 10-903 readers. Each key is delivered with a barcode that can be scanned, which simplifies the input into the software.

**Available on request. Contact Niko for more information and project support.**

- packaged per 50
- integrated in a black holder

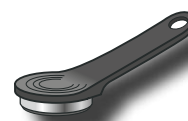
**Complete units**

Set of 50 access keys

**10-910-50**

Pack: 1

**Bus interface for access key system**

This bus interface makes the link between a permanently on-site PC and the bus system. It guarantees the highest operational reliability thanks to the integrated watchdog function. This interface can only be used with the Access Key Controller software and is permanently present in the installation.

**Available on request. Contact Niko for more information and project support.**

- dimensions: 114x90x32mm
- connection with the PC via serial cable (RS-232)
- connection with the system bus via RJ45 patch cable

**Complete units**

Bus interface for access key system

**10-856**

Pack: 1

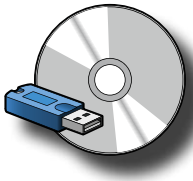

### Software key (dongle) + "Access Key Controller" software

The Access Key Controller user software allows you to execute a scalable access policy. It is a complete management package with which keys, profiles, time zones and functions can be assigned to persons. The software has 3 user modes: an observation mode which allows access to the log book, a standard mode in which keys and persons can be added and a configuration mode in which functions and profiles can be modified. The software is always used in combination with type 10-902 and 10-903 readers.

The software is equipped with a software key in the form of a USB dongle. This dongle must always be connected to the PC in the installation in order for it to function.

**Available on request; contact Niko for more information and project support.**

- required PC configuration: Windows XP, 256 MB RAM

### Complete units

Software key with access key software

10-857

Pack: 1

**Bell push buttons**

The Niko bell push button is constructed of the highest quality materials, such as injection-moulded aluminium and black plastic. It is resistant to corrosion and weather influences. The name plate is large and well-illuminated. The push button is equipped with top quality contacts: a reed contact, consisting of 2 rod contacts in a sealed, glass housing. The lamp must be removed when using an electronic gong.

- dimensions: 95mm x 54mm x 19mm

**Complete units**

12V~ 1A supplied as complete set with lamp (black/aluminium)	<b>05-540</b>	Pack: 10
12V~ 1A supplied as complete set with lamp (white/white)	<b>05-540-13</b>	Pack: 10
12V~ 1A supplied as complete set with lamp (black/white)	<b>05-540-23</b>	Pack: 10
12V~ 1A supplied as complete set with lamp (white/aluminium)	<b>05-540-33</b>	Pack: 10
6V~ 1A supplied as complete set with lamp (black/aluminium)	<b>05-540-06</b>	Pack: 10

**Accessories**

Lamp for bell push button 6V~ 1A	<b>05-501-06</b>	Pack: 10
Lamp for bell push button 12V~ 1A	<b>05-501-12</b>	Pack: 10

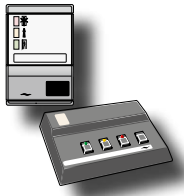

### Semaphor set

The Semaphore controls access to an office by means of sound and LED signalling. The Semaphore basic set consists of a bell push button, a main internal unit and 15m of wire.

- at the door: a bell push button to be operated by the visitor (includes symbols and texts in several languages)
- in the office: a main internal unit with 4 keys: green (IN), orange (WAIT) and red (OCCUPIED)
- N.O. push button with potential-free contacts, max. 24V~ = 100mA; for example, can control an electrical door lock using a relay or a buzzer in the waiting room.

The Semaphore operates at low voltage 12V~. The bell push button is mounted outside of the office near the door. The main internal unit is placed in the office within arm's reach. You can connect a sub internal unit to the main unit that operates in the same way (e.g., for a manager's and secretary's offices or for offices with 2 rooms). A max. of 2 bell push buttons can be connected to the main internal unit. The sub internal unit and the additional bell push button can be ordered separately.

#### SET

- bell push button: steel-grey plastic with black push button. Symbols and texts supplied in several languages. Mounted directly on the wall by means of screws (flush-mounting box not required).
- main internal unit: table model in matte black plastic with decorative band in anodized aluminium
- 15m wire
- dimensions bell push button: 120mm x 80mm x 16mm
- dimensions internal unit: 135mm x 90mm x 35mm

#### Complete unit

Semaphor set	<b>24-445-16</b>	Pack: 1
--------------	------------------	---------

### Secondary internal unit

Sub internal unit can only be used as an extension of the main internal unit. It has a matte black plastic finish with a decorative strip in anodized aluminium.

#### Complete unit

Secondary internal unit	<b>04-446-10</b>	Pack: 1
-------------------------	------------------	---------

### Bell push button

A max. of 2 bell push buttons can be connected to the main internal unit. This additional bell push button can be ordered separately and is finished in steel grey plastic with a black push button.

#### Complete unit

Bell push button	<b>24-445</b>	Pack: 1
------------------	---------------	---------

### Mains supply

If no 12V~ line is available in the office, you can use this net power supply (available separately). This net power supply is connected between the internal unit and a 230V contact outlet.

#### Complete unit

Mains supply	<b>04-448</b>	Pack: 1
--------------	---------------	---------

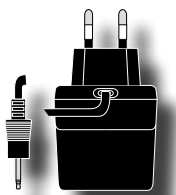
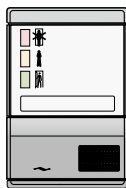



**ACCESS CONTROL - AUDIO DOOR COMMUNICATION**

The procedure for composing an intercom system is described on the following pages. The intercom and videophone systems are completely compatible. The functions and devices described in this section can therefore also be used in combination with the videophone system.

Check also the sections with general information on the Niko Access Control system, for example, programming and the connection of a floor bell push button, a lighting circuit, the telephone interface, the code keyboard, etc.



**CHOICE OF THE EXTERNAL UNIT**

All external units are made of aluminium and are suitable for outdoor mounting. Depending on the size of the installation, you can choose a unit from the following list:

external unit	max. # bell push buttons
Surface mounting, 16mm mounting height, ultra compact	8
Surface mounting, 20mm mounting height, large name plate	23
Flush mounting, 3mm front plate, 40mm mounting depth	30
Surface mounting, 20mm mounting height, double row of bell push buttons	92
Flush mounting in door panels (post box systems)	208
Flush mounting, 3mm front plate, keyboard with display	200
contact Niko	> 180

**CHOICE OF THE INTERNAL UNIT**

Depending on the desired function and design, you can choose a surface mounting internal unit from the following list:

Functions	 10-501	 10-511(-50) & 10-520	 10-512
door open key/optional light	X	X	X
light key		X	X
free function key(s)		X	X
call can be switched off	X	X	X
call volume adjustable	X	X	X
master-slave programming	X	X	X
control function		X *	X
ring-and-come-in function		X *	X
reroute function		X *	X
internal call		X *	X
adjustable ring tones	X	X	X
can be used for table mounting	X	X	

\* only 1 of the 4 functions can be programmed on the free function keys.

**CHOICE OF THE CABLING**

You can cable the audio door communication system as you wish. You do not have to maintain a strict topology.

**2-wire-cabling:** for smaller installations. You can then simultaneously call 2 internal units.

**3-wire-cabling:** for larger installations (see overview). The extra wire is used for an extra power supply. You can then call four internal units simultaneously.

**a & b :** This pair forms the BUS. This pair transmits the communication (speech) and the control commands. This pair will suffice for a two-wire installation. Between a and b you should be able to measure 24V DC (b = mass).

**P :** This wire provides for an extra power supply in a three-wire installation. Two-wire and three-wire cabling can both be used in the same system. Between P and b you should be able to measure 26V DC (b = mass).



**Which cable type do you use best?**

The diameter of the wires determines the max. distance that can be covered. The larger the diameter, the bigger the distance between the power supply and the farthest internal or external unit. In the table below, you find an overview of the max. distance (from power supply to internal or external unit) per cable type. You can double the max. distance by taking 2 pairs together.

diameter	0,5mm (e.g. UTP cat. 5E)	0,6mm (e.g. TPVF)	0,8mm (e.g. SVV, TVVF, JYSTY...)
max. distance	100m	150m	250m





For covering larger distances, please contact the Niko Customer Service.

## MOUNTING INSTRUCTIONS EXTERNAL UNITS



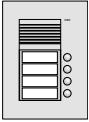

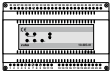
Mount the speaker part of the external unit at 140 to 150cm height.

## ACCESSORIES FOR DOOR INTERCOM INSTALLATIONS WITH ONE EXTERNAL UNIT AND ONE INTERNAL UNIT PER BELL PUSH BUTTON

Accessories for installation with **internal unit type 10-501 or 10-511:**

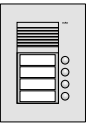
external unit *	System components			Internal unit	Wiring **
					
	<b>10-801</b>	<b>10-802</b>	<b>10-805-01</b>		
<b># push buttons</b>				<b>#</b>	
1				1	two-wire (a & b)
2				2	"
3				3	"
4				4	"
6				6	"
8				8	"
10				10	"
12				12	"
16				16	"
20				20	"
24				24	"
30				30	"
40				40	"
50				50	"
60				60	"
70				70	three-wire (a, b & P)
90				90	"
> 90	Contact Niko for advice				

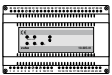
Accessories for installation with **internal unit type 10-520:**

External unit *	System components			Internal unit	Wiring **
					
	<b>10-801</b>	<b>10-802</b>	<b>10-805-01</b>	<b>10-520</b>	
<b># push buttons</b>				<b>#</b>	
1				1	two-wire (a & b)
2				2	"
3				3	"
4				4	"
6				6	"
8				8	"
10				10	"
12				12	"
16				16	"
20				20	"
24				24	"
30				30	three-wire (a, b & P)
40				40	"
50				50	"
60				60	"
> 60	Contact Niko for advice				

\* Remarks related to the external unit:

- When using the flush-mounting external units with a 7-digit or an LCD screen, the solution with power supply 10-802 in combination with 10-805-01 should always be used.
- A maximum of two external units can be connected to power supply 10-801, and a maximum of four external units can be connected to power supply 10-802.
- If you have more than four external units, then use the combination of power supplies 10-802 and 10-805-01.
- An extension module is considered an extra external unit.
- If you have several door stations, then use one relay 10-835 per external unit.

\*\* When using two-wire cabling, a maximum of two internal units can be called at one time. With three-wire cabling, this will be four units.

**DIMENSIONS FLUSH MOUNTING BOXES**

10-201	159 x 126 x 40mm
10-202	159 x 126 x 40mm
10-203	159 x 126 x 40mm
10-204	159 x 126 x 40mm
10-206	203 x 126 x 40mm
10-208	247 x 126 x 40mm
10-210	291 x 126 x 40mm
10-212	203 x 250 x 40mm
10-214	225 x 250 x 40mm
10-216	247 x 250 x 40mm
10-218	269 x 250 x 40mm
10-220	291 x 250 x 40mm
10-224	247 x 374 x 40mm
10-227	291 x 374 x 40mm
10-230	291 x 374 x 40mm

**AUDIO DOOR COMMUNICATION | EXT. ON | INT. UNIT**

**AUDIO DOOR COMMUNICATION | EXT. ON 20 INT. UNITS**

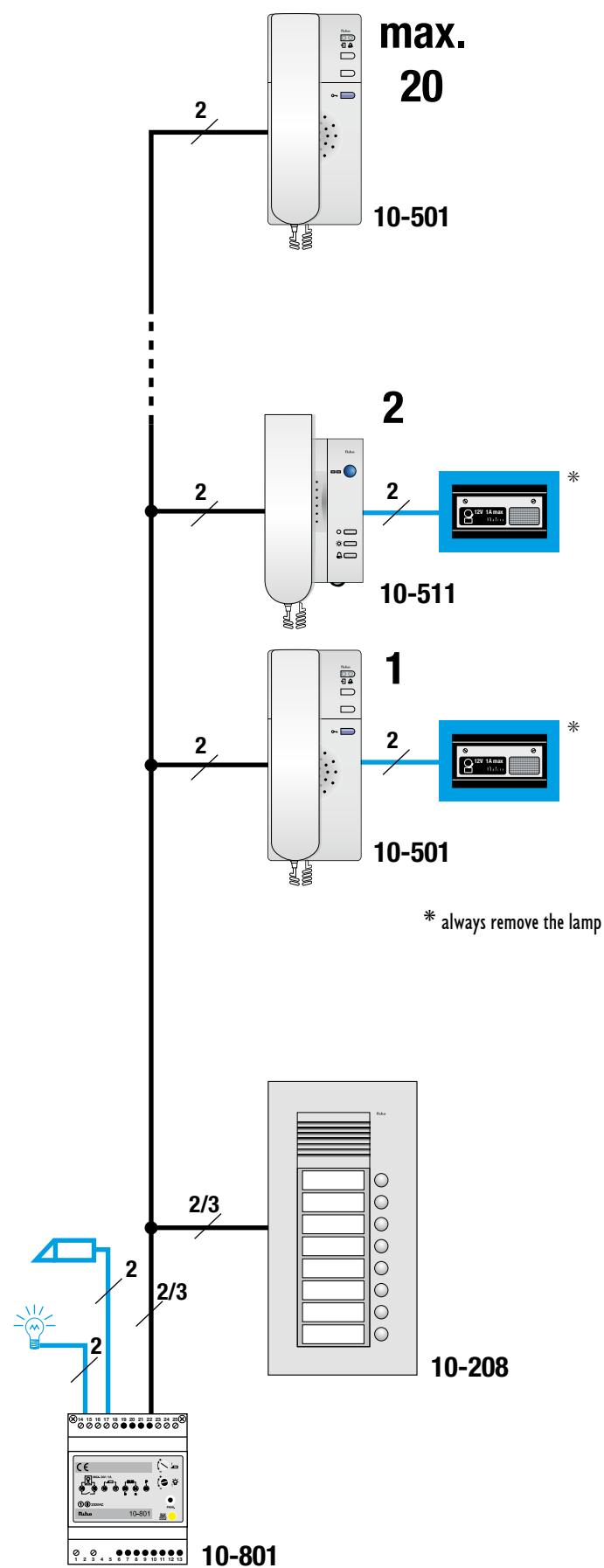
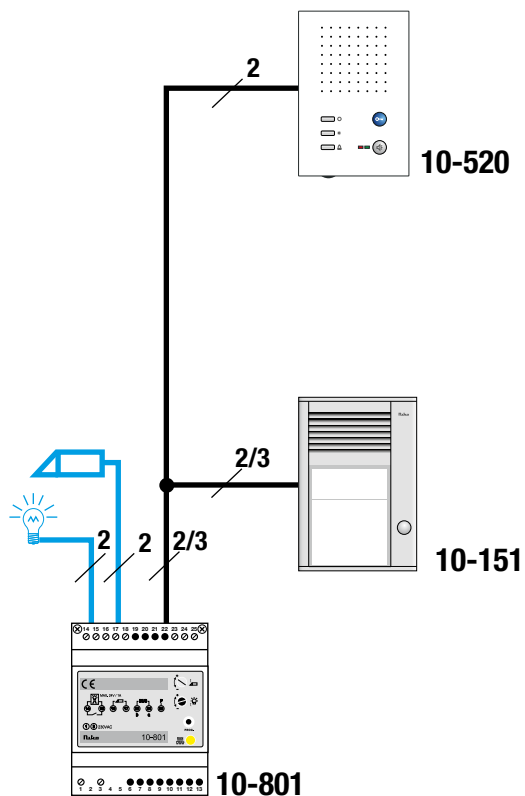

AUDIO DOOR COMMUNICATION > 4 EXT. ON 180 INT. UNITS

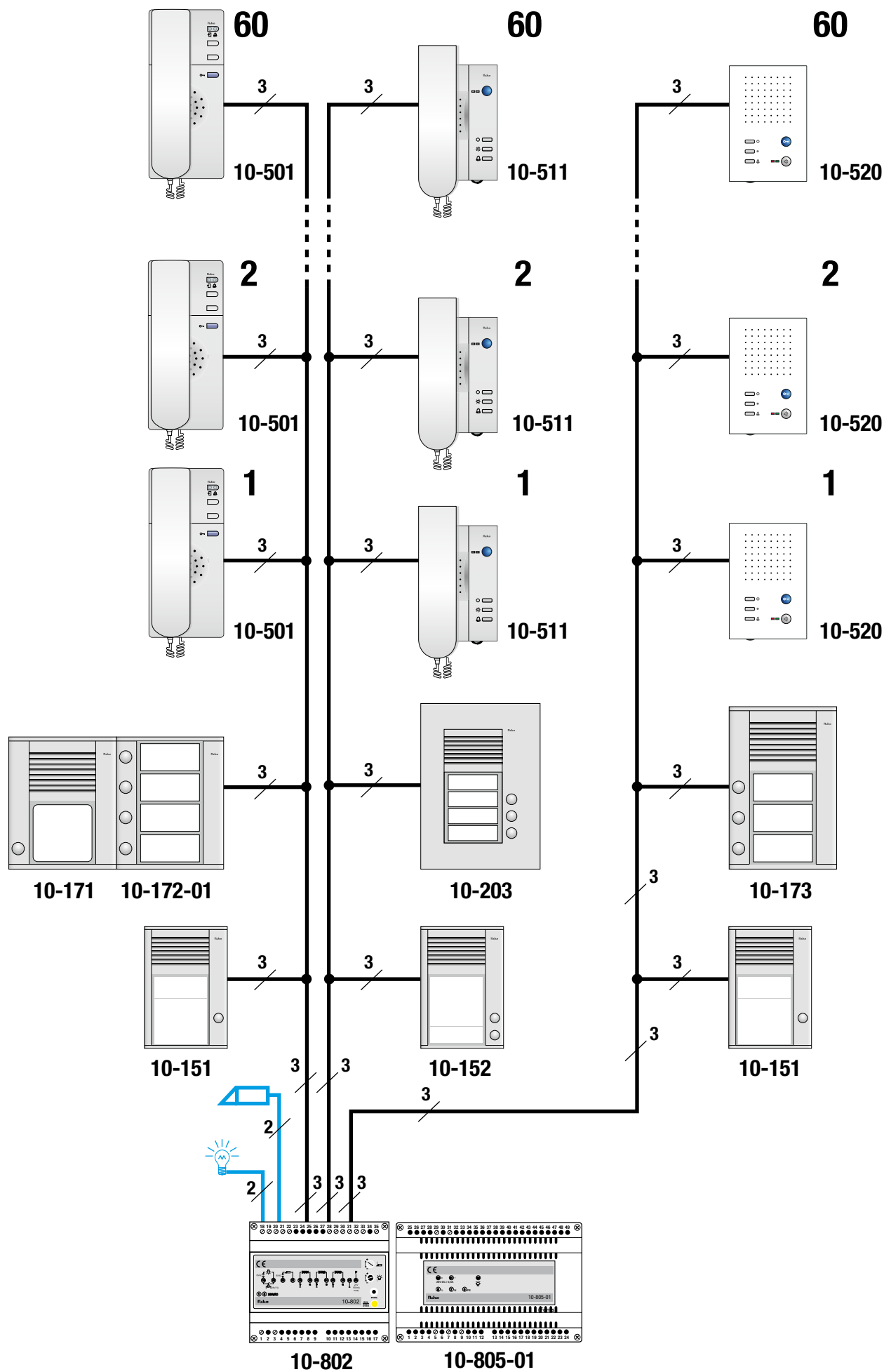

## ACCESS CONTROL – VIDEO DOOR COMMUNICATION

The procedure for composing a videophone system is described on the following pages. The intercom and videophone systems are completely compatible. The functions and devices described in this section can therefore also be used in combination with the intercom system.

Check also the sections with general information on the Niko Access Control system, for example, programming and the connection of a floor bell push button, a lighting circuit, the telephone interface, the code keyboard, etc.

### CHOICE OF THE EXTERNAL UNIT

All external video units are equipped with a **colour camera**. You can connect an internal unit with a black-and-white screen or a colour screen to an external unit. Depending on the size of the installation, you can make your choice using the table below.

external unit	max. # bell push buttons
surface mounting, 20mm mounting height, 1 row of bell push buttons	22
flush mounting	24
surface mounting, 20mm mounting height, double row of bell push buttons	88
flush mounting in door panels (post box systems)	208
flush mounting, with 7-digit or LCD display	200
flush mounting, with LCD display and scroll wheel	> 200
contact Niko	> 180

### CHOICE OF THE POWER SUPPLY

The internal and external units have to be provided with a power supply. The choice of the power supply only depends on the number and type of internal and external unit(s). In the table below, you find the max. configuration per power supply.

power supply	Max. # internal units video	Max. # external units video	Max. # internal units audio
<b>10-806</b>	12 * (no parallel function)	1	1
<b>10-801 &amp; 10-805-01</b>	> 3	> 1	> 1

\* Maximum of six parallel calls if two internal video units have been installed in parallel.

#### Note:

- When using the flush mounting external units with 7-digit or LCD display, always use ref. 10-802 in combination with ref. 10-805-01.

### CHOICE OF THE CABLING

A system with video appliances has to be cabled in a **6-wire way**. This makes the system very flexible, enabling you to add additional internal units (audio and video), relays or other appliances to your installation at any time.

- With a line cabling for monitors, you can connect up to 6 monitors with one cable without having to use splitters.
- With a star cabling for monitors, you have to use splitters to split the signal in 2 or 4 new signals. To every output of a splitter, you can again connect 6 monitors.
- If the installation has several external units or cameras, you have connect these to a switcher. The switcher selects the correct video image for the right internal unit.

You can run through all camera images at any time.

#### Function of the cable pairs

**a&b** : This pair forms the BUS. This pair transmits the communication (speech) and the control commands.

**P&M**: This pair provides an extra power supply.

Between P and M you should be able to measure 26V DC (M = mass).

**V1&V2**: This pair forms the video signal and should always consist of a twisted cable. Splitting the signal without the use of splitters is not permitted. Between V1 or V2 and b (b = mass) you should be able to measure approximately 5 V DC.

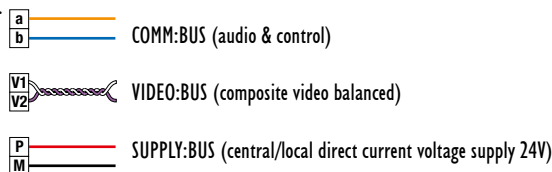

#### Which cable type do you use best?

In order to obtain an optimum image quality over long distances, use a twisted cable.

The diameter of the wires determines the max. distance that can be covered. The larger the diameter, the bigger the distance between the power supply and the farthest internal or external unit. In the table below, you find an overview of the max. distance (from power supply to internal or external unit) per cable type.

diameter	0,5mm (e.g. UTP cat. 5E 4x2x0,5)	0,6mm (e.g. TPVF 3x2x0,6)	0,8mm (e.g. TVVF 3x2x0,8, JYSTY 4x2x0,8, TWAVB 4x2x0,8...)
max. distance	70m	100m	200m

For covering larger distances, please contact the Niko Customer Service

**Parallel function of video monitors:**

If **2 monitors** are activated simultaneously on the same line cabling, you have to **divide the distances to be covered by 2**. If 3 monitors are activated simultaneously, you **divide the distance by 3** etc. If the monitors are activated simultaneously and are cabled in star, the max. distance applies again.

**MOUNTING INSTRUCTIONS FOR EXTERNAL UNITS**

**Directives for mounting a video external unit**

**Cameras should not be aimed at:**

- direct backlighting
- direct sunlight
- a blinding image background or a background with extreme contrasts
- highly reflective walls
- lamps or other light sources

**Recommended mounting height:**

- standing persons: approx. 160cm (normal)
- children, persons in a wheelchair: approx. 120cm
- sitting in a car: approx. 100 – 120cm
- sitting in a truck: approx. 180 – 220cm

Always make sure that the middle of the lens matches the middle of the image to be displayed.

**Horizontal and vertical detection range**

The detection range was calculated on the basis of an observation distance of 30 - 90cm (range of vision of a person). For detection beyond this range, the units are only limitedly suitable: the images are displayed too small. If this is the case, you can install the surface mounting camera with ref. 10-490-01 (with lenses with a larger focus length).

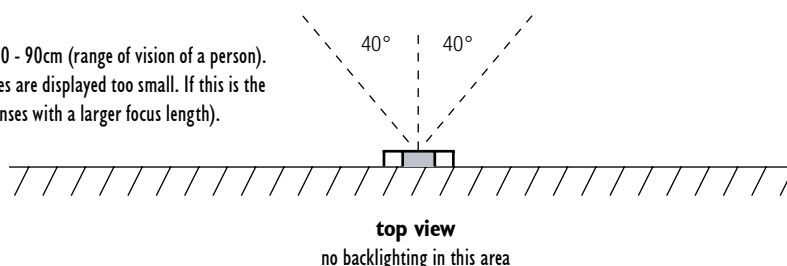

**ACCESSORIES FOR VIDEOPHONE INSTALLATIONS WITH ONE EXTERNAL UNIT AND ONE INTERNAL UNIT PER BELL PUSH BUTTON, TYPE 10-570 OR 10-571**

In the following overview you can see what is needed for an installation with one external unit and one internal unit per bell push button.

You can always add external and internal intercom units to the installation.

Take into account the maximum configuration of the power supply (see "CHOICE OF POWER SUPPLY") and the necessary system components (splitters and switchers) if you want to install the following:

- more than one internal video unit per bell push button
- more than one external video unit

**All external units are supplied with a colour camera.**

External unit *	System components					Internal unit
<b># push buttons</b>						<b>#</b>
1						1
2						2
3						3
4						4
6						6
8						8
10						10
12						12
16						16
20						20
24						24
30						30
42					2	42
60					2	60
> 60	Contact Niko for advice					

\* If you would like to have several door stations, then use one video switcher 10-823 (for a maximum of four external units) and one relay 10-835 per external unit.

\*\* If more than two internal units are active at the same time and the installation contains more than six internal units, then always use power supplies 10-801 and 10-805-01.

\*\*\* Calculated based on (maximum) six monitors per video output.

**DIMENSIONS FLUSH MOUNTING BOXES**

10-301	203 x 126 x 40mm
10-302	203 x 126 x 40mm
10-303	203 x 126 x 40mm
10-304	203 x 126 x 40mm
10-306	291 x 126 x 40mm
10-308	291 x 126 x 40mm
10-310	225 x 250 x 40mm
10-312	247 x 250 x 40mm
10-314	269 x 250 x 40mm
10-316	291 x 250 x 40mm
10-318	247 x 374 x 40mm
10-321	269 x 374 x 40mm
10-324	291 x 374 x 40mm



VIDEO DOOR COMMUNICATION SMALL INSTALLATIONS

SMALL INSTALLATIONS, NO PARALLEL FUNCTION, NO SPLITTERS

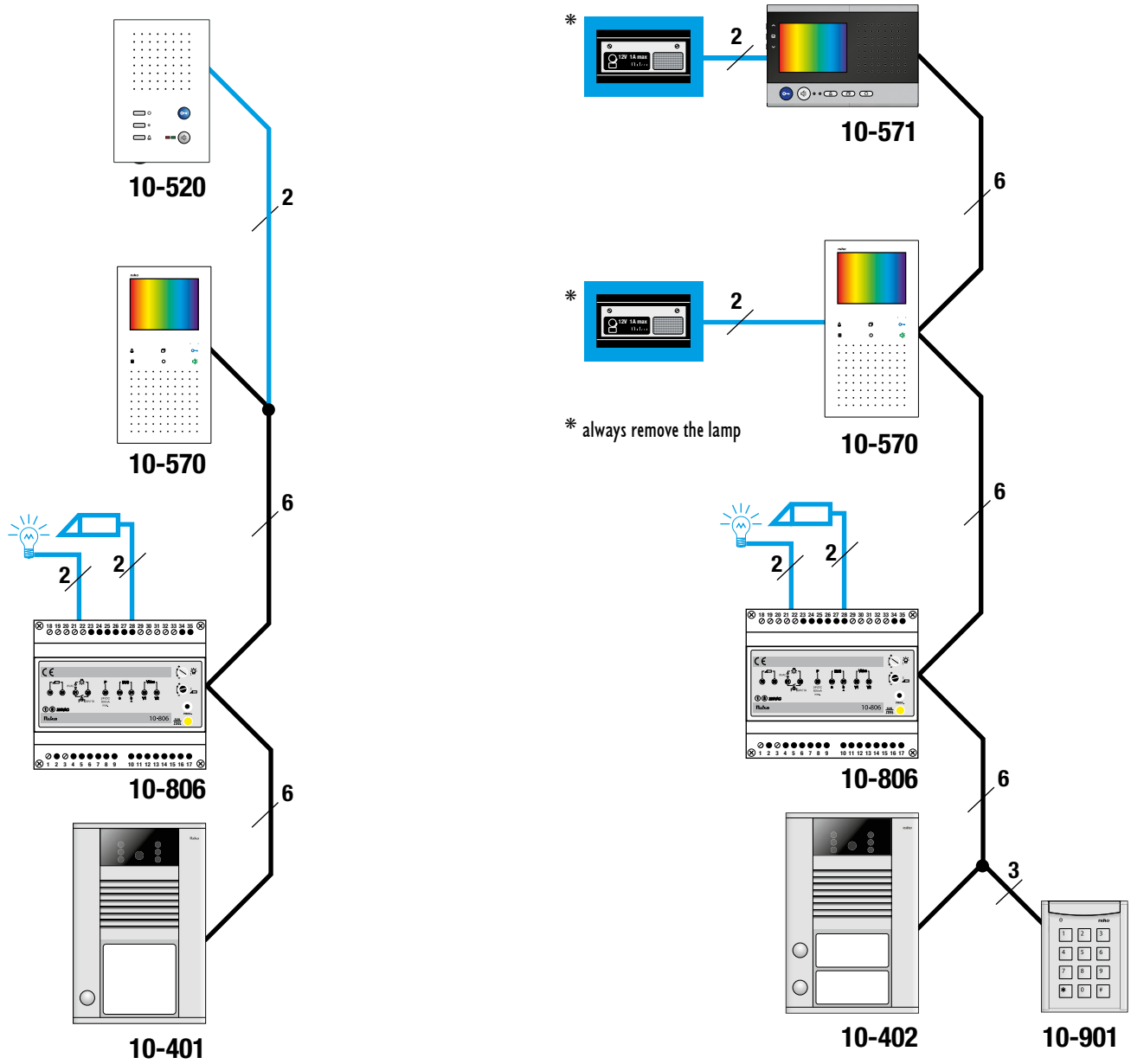

**VIDEO DOOR COMMUNICATION WITH PARALLEL FUNCTION OR LARGE INSTALLATIONS FOR 1 RISING MAINS (WITHOUT SPLITTERS)**

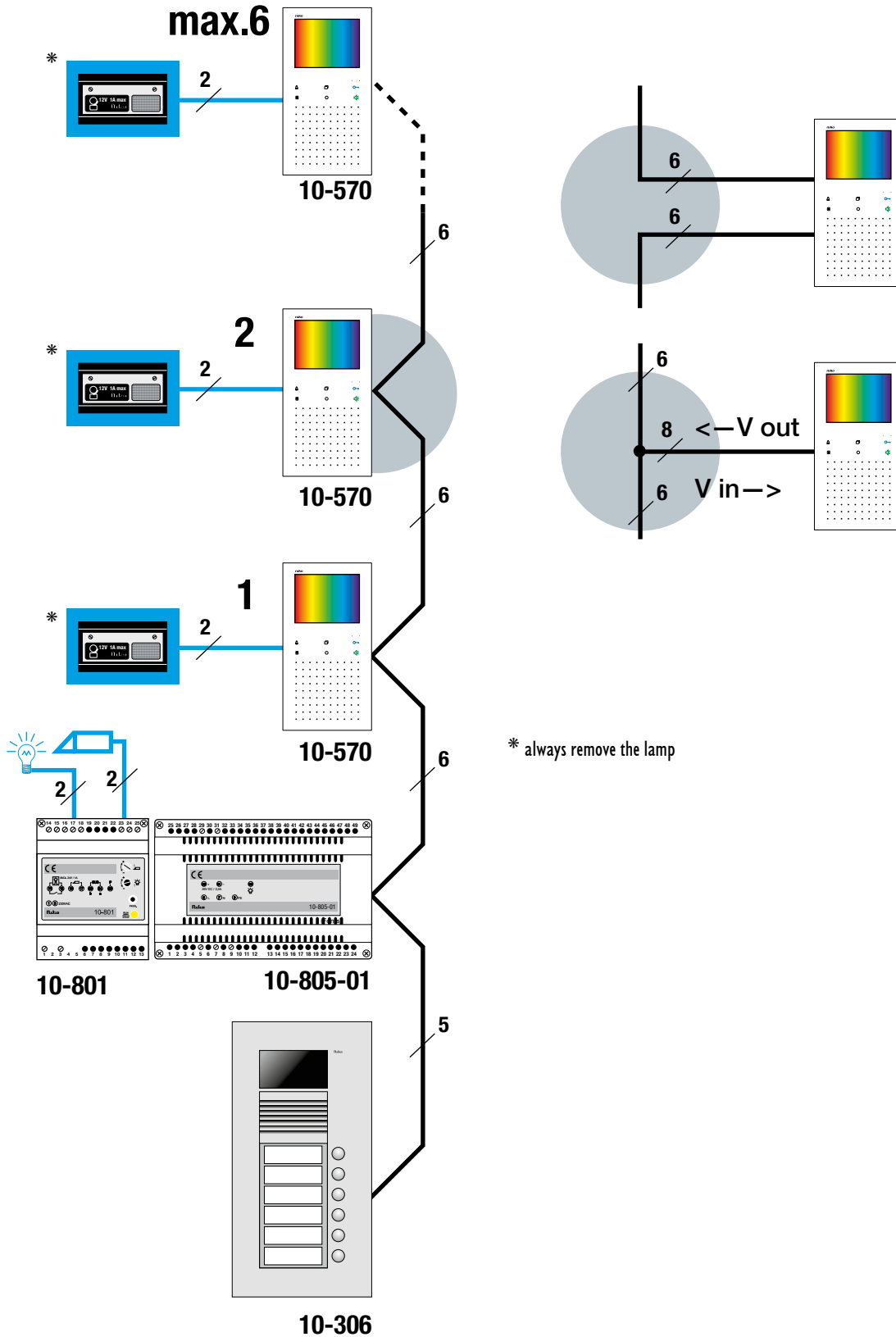

VIDEO DOOR COMMUNICATION WITH SPLITTER 10-824-01 (STAR CABLING)

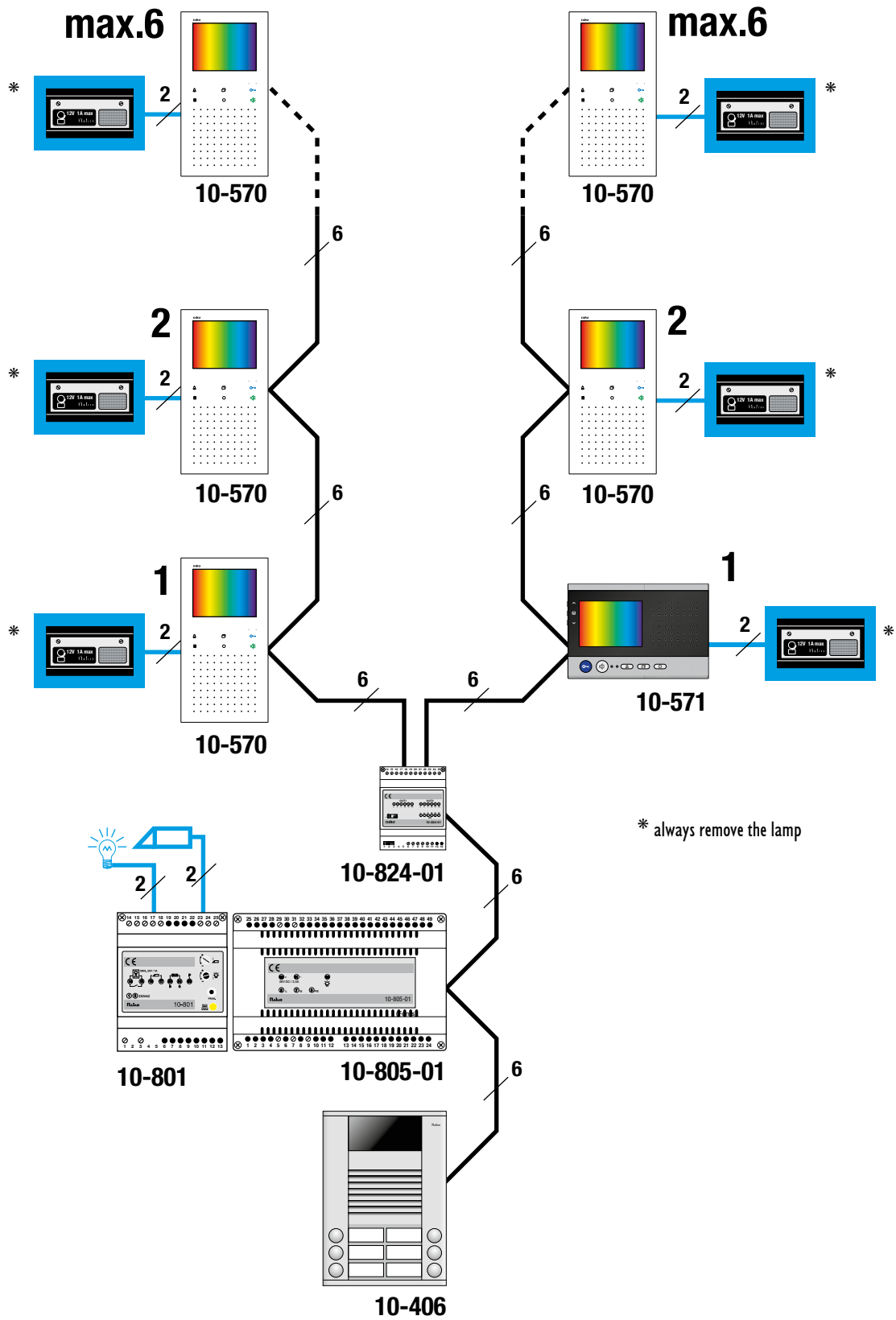

VIDEO DOOR COMMUNICATION WITH SPLITTER 10-822-01 FOR SEVERAL RISING MAINS

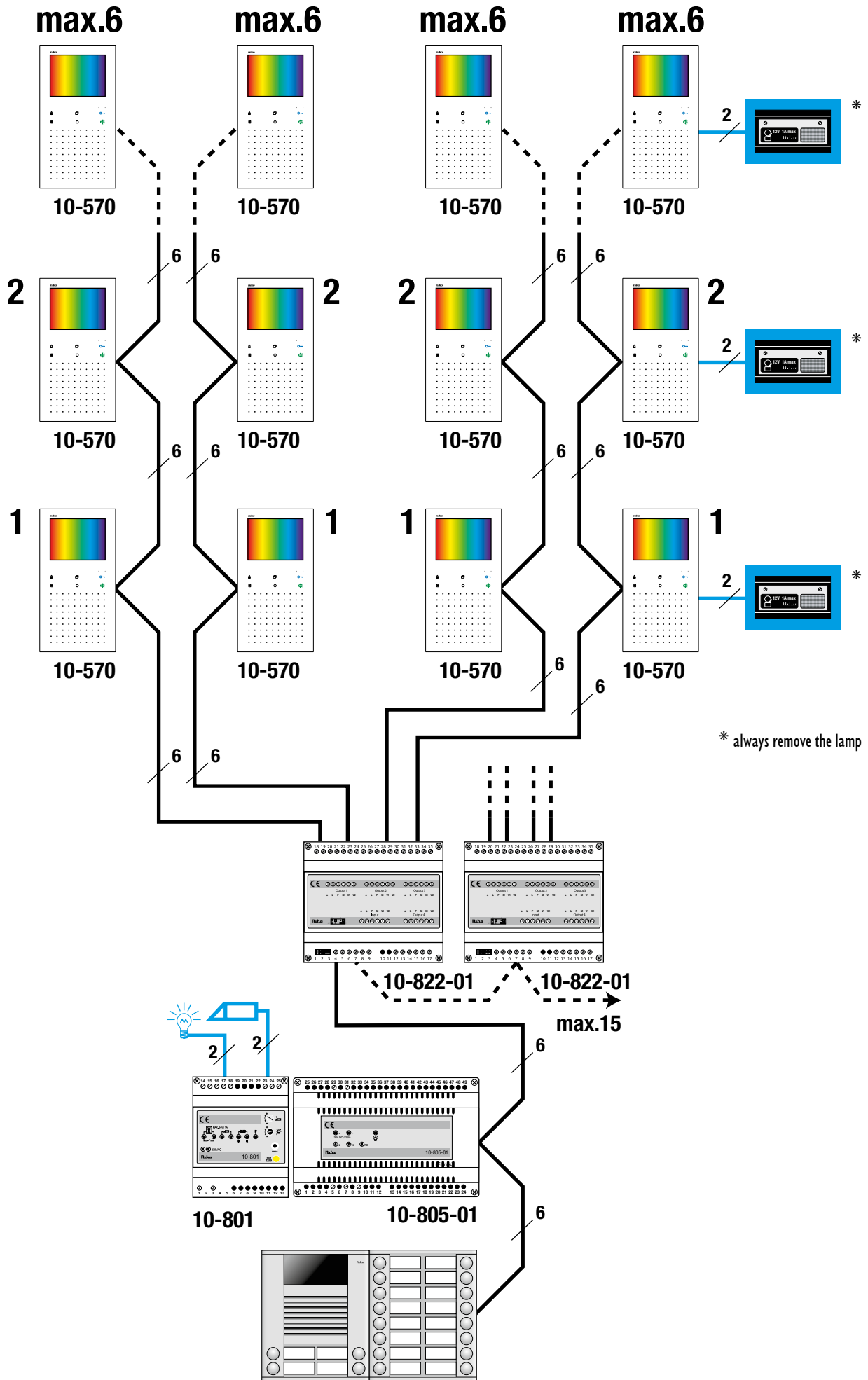

\* always remove the lamp

**VIDEO DOOR COMMUNICATION WITH SPLITTER 10-821-01 FOR 1 CENTRAL RISING MAINS**

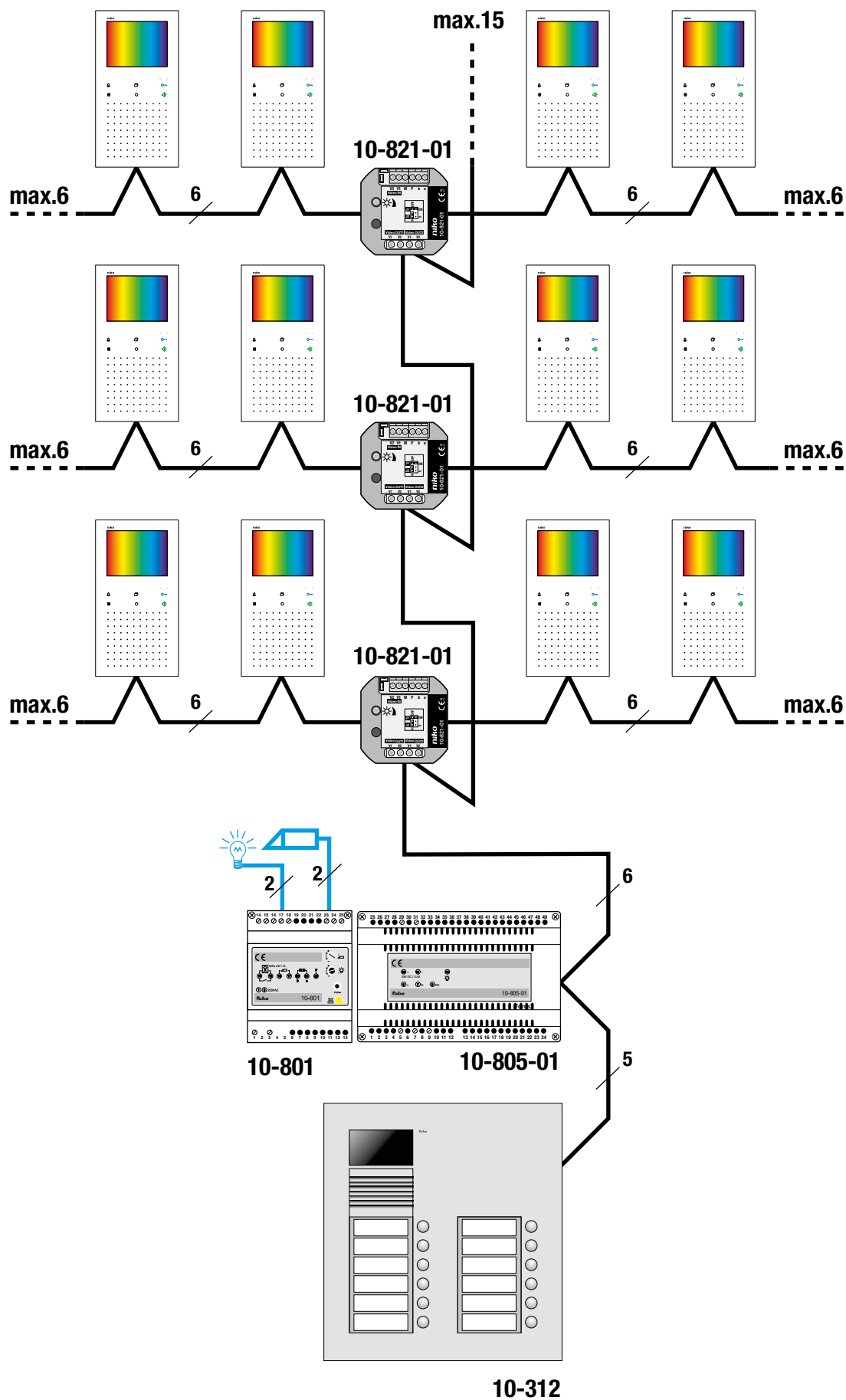

VIDEO DOOR COMMUNICATION WITH SEVERAL EXTERNAL UNITS

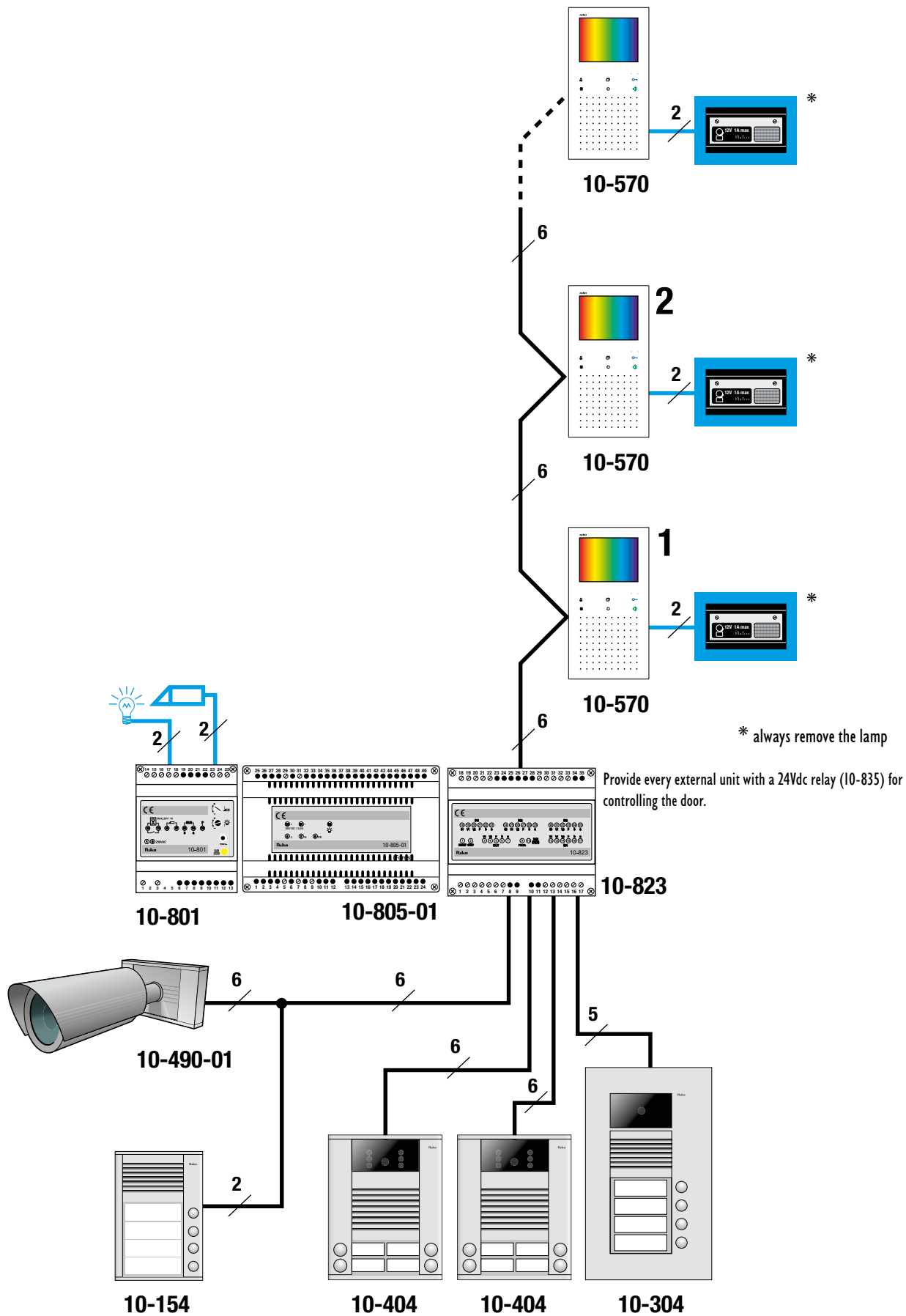

**ACCESS CONTROL: GENERAL INFORMATION**

This general information applies to both door intercom systems and videophone systems.

**CONNECTING A FLOOR BELL PUSH BUTTON**

You can always connect a floor bell push button on terminals E and P of the internal units. Please always remove the lamp from the bell push button.

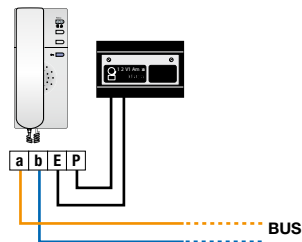

**CONNECTING A LIGHT CIRCUIT TO THE POWER SUPPLY**

You can connect a light circuit to the potentialfree contact (24V and 1A) of the power supply modules kan. In order to power the circuit, an additional transformer is required if the connected resistance is smaller than 6Ω. This relay can be controlled from every internal unit.

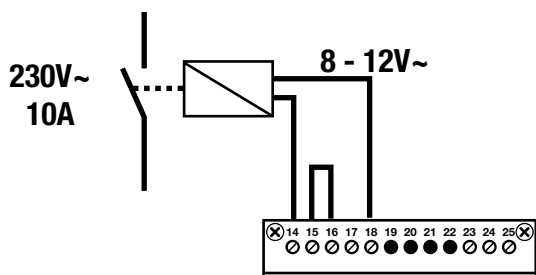

connecting a light circuit (230V~) to 10-801

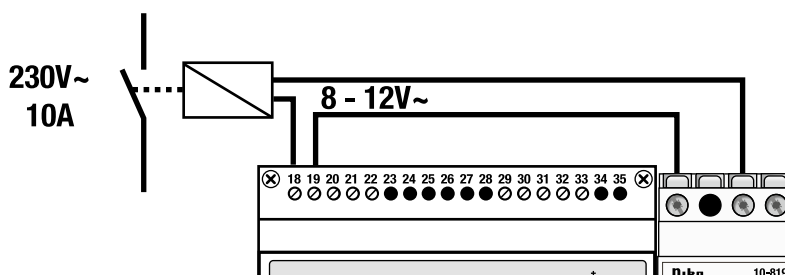

connecting a light circuit (230V~) to 10-802

**HOW TO PROGRAM IN A NUTSHELL**

**a) Manually**

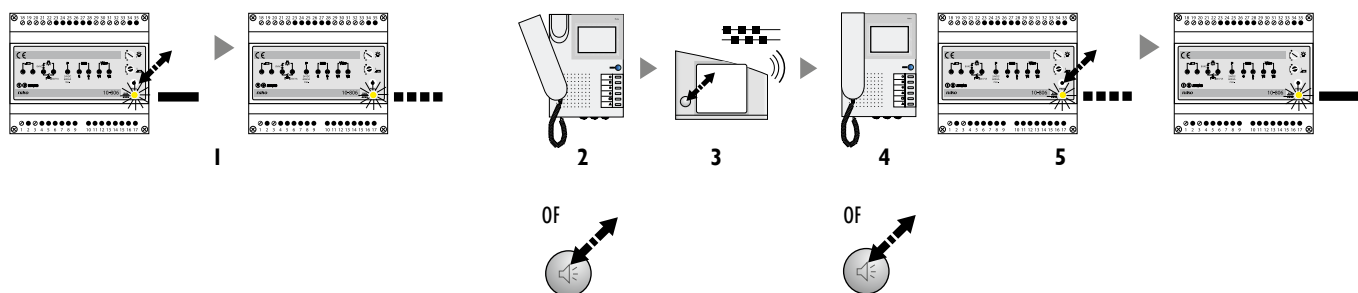

1. Briefly press the 'prog' key. The LED blinks.
2. Pick up the receiver of the internal unit.
3. Press the correct bell push button on the correct external unit.
4. Put down the receiver.
5. Exit programming mode by again briefly pressing the 'prog' key. The LED lights continuously.

**b) By means of the service set**

Thanks to the service set (10-870), the installation can be programmed much faster and more efficiently. You only have to stick the stickers with the serial number you find at the back of the internal unit to your wiring diagram. Connect the service set to the external unit, insert the serial numbers and assign the bell push buttons.

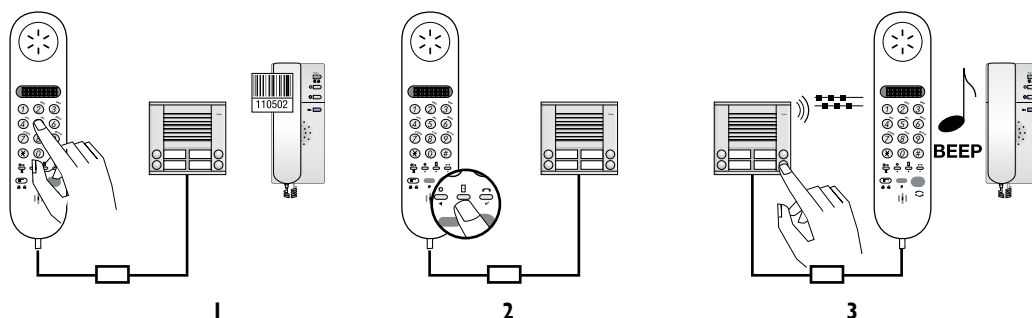

**APPLICATIONS WITH RELAY**

**Switching light:**

Apart from the use of the built-in lighting unit on the power supply, you can further extend the audio or video door communication system to switching for various purposes such as e.g. lighting by means of the flush mounting relay or the relay for DIN rail mounting.

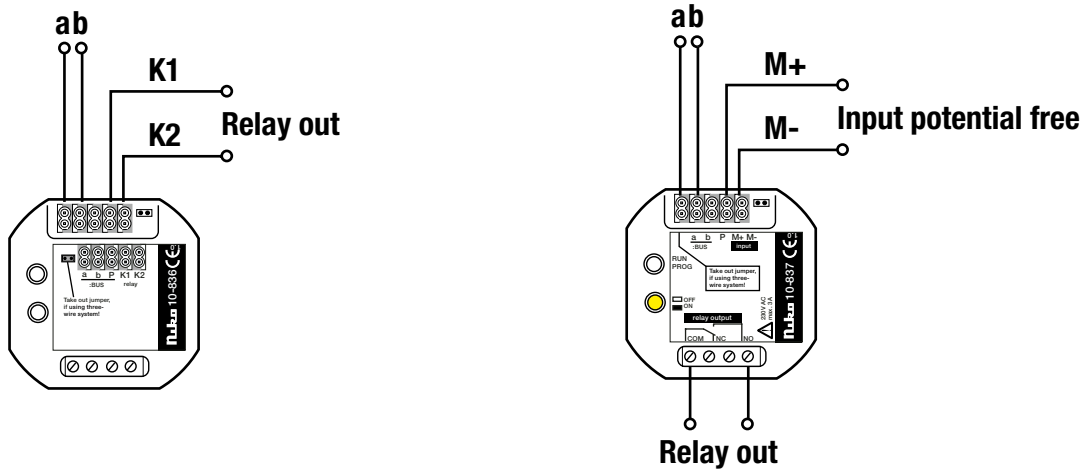

**Door opener::**

Apart from the door open contact that is provided on the power supply module as a standard, you can add several door open relays. This is required in case here are several external units.

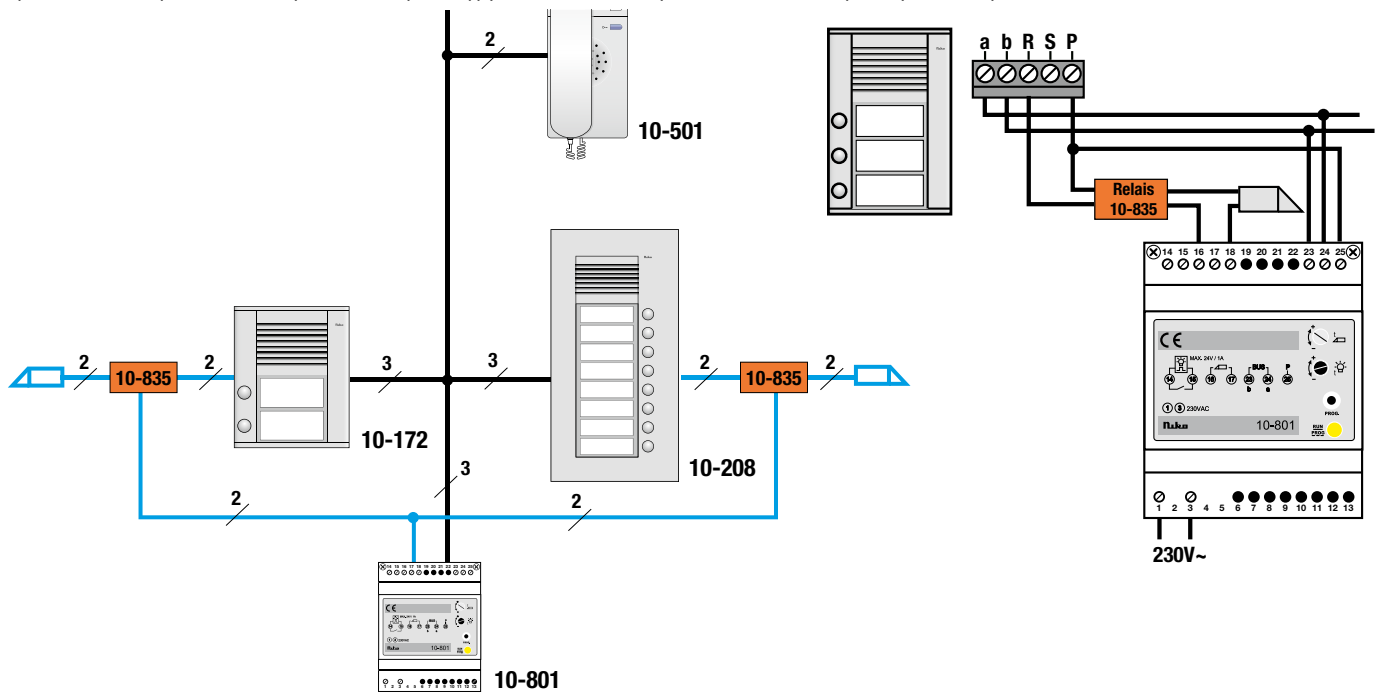

**Switching a bell / buzzer:**

Via the relay module with ref. 10-836 (24V contact), the relay with ref. 10-837 (230V contact) or the modular relay with ref. 10-830 (230V contact), you can connect an additional bell, chime or buzzer. In case of relays 10-837 and 10-830, this can be programmed manually, in case of relay 10-836, the service set is required for programming.

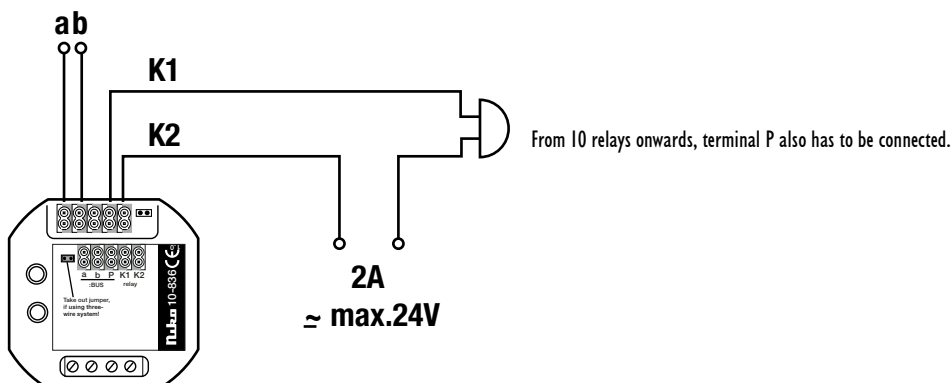



**DEURTELEFONIE MET TELEFOONINTERFACE**

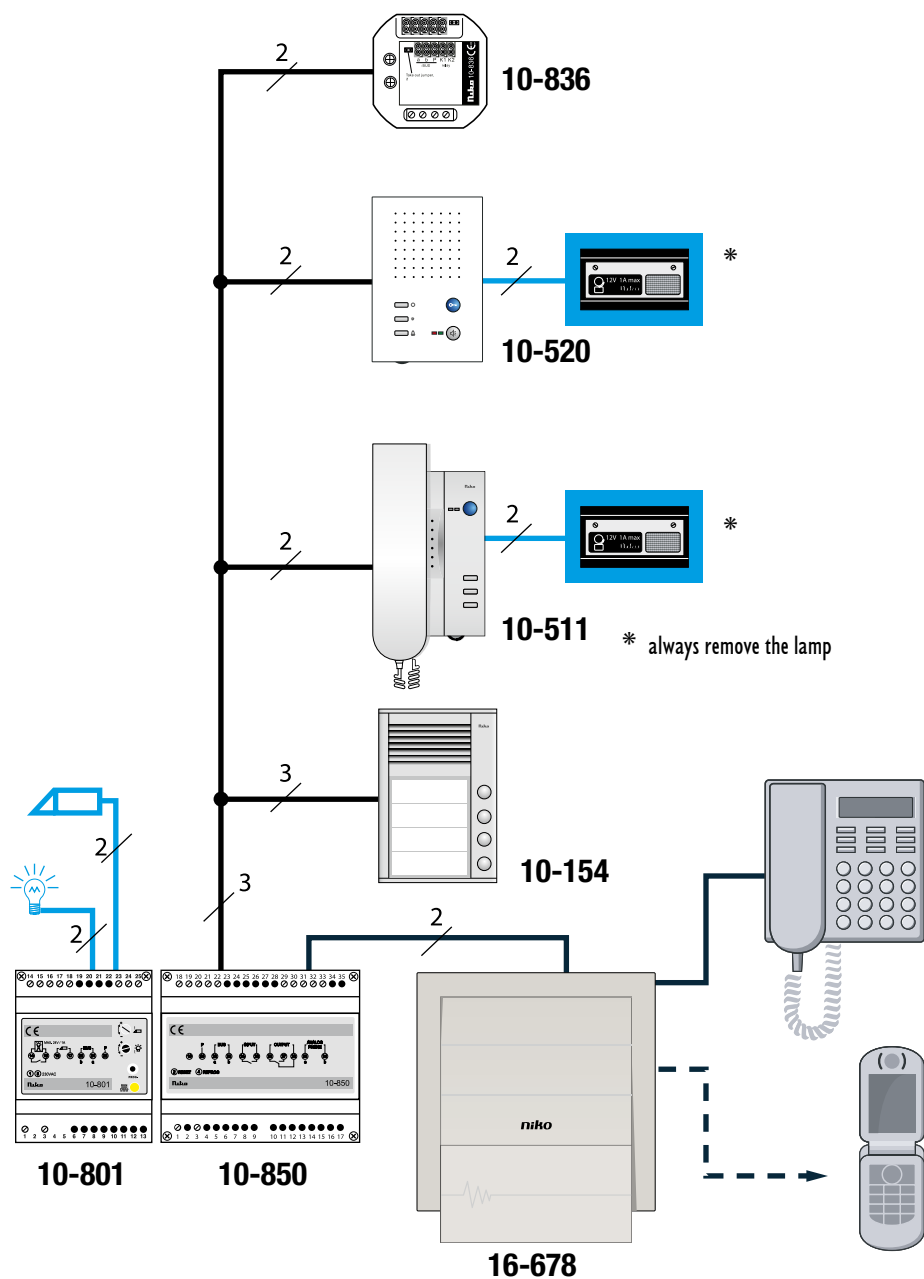

**CODE KEYBOARD**

With system power supply: (10-801 / 10-802 / 10-806):

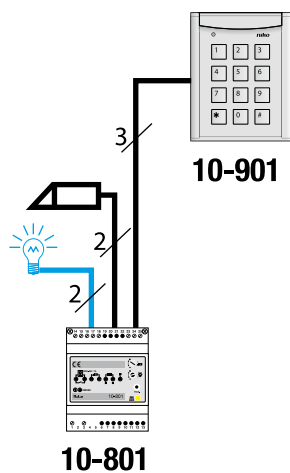

**NIKOBUS CONNECTION**

If you are using a bus interface module and the relay, you can make a connection to the Nikobus.  
In the following wiring diagrams, you find some of the possibilities.

**Wiring diagram with input module 05-206**

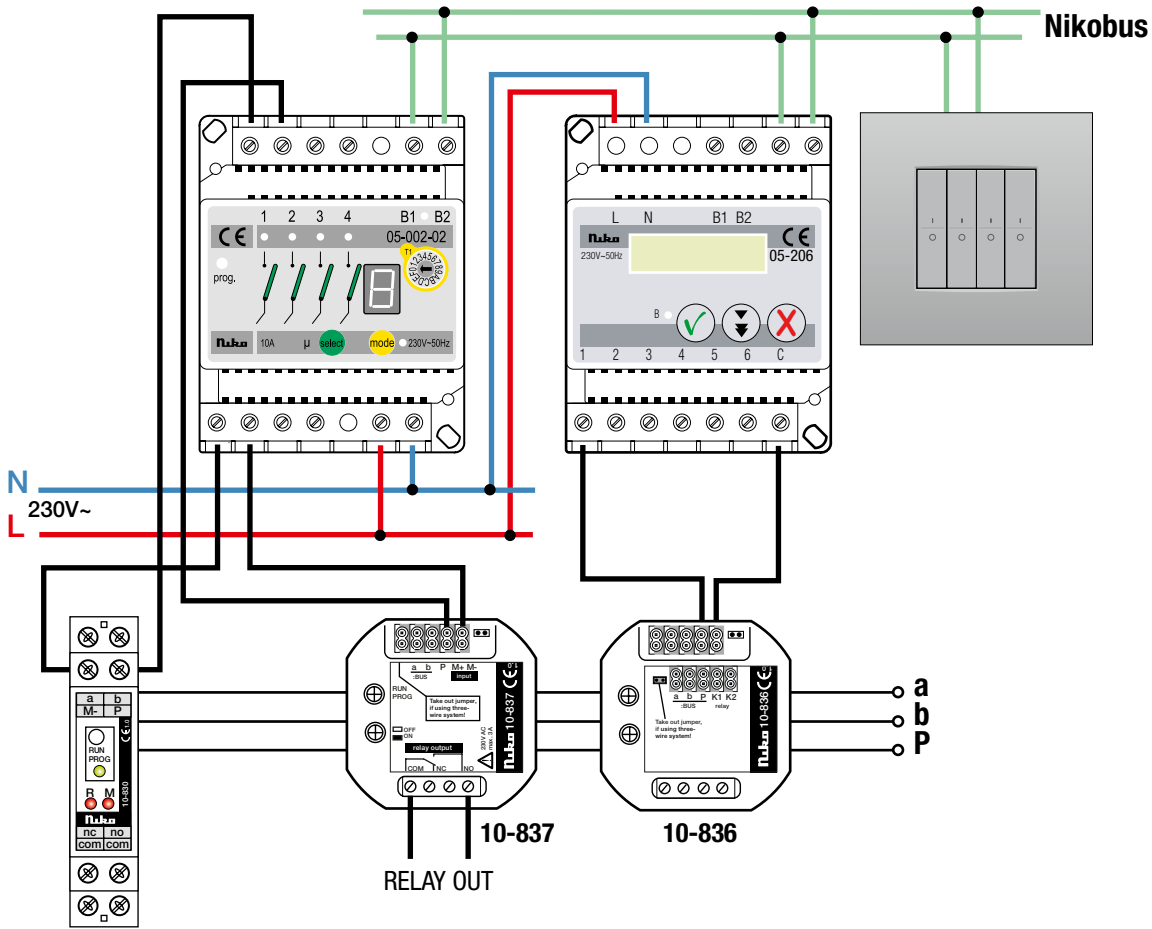

**Diagram with switching module 05-000-02**

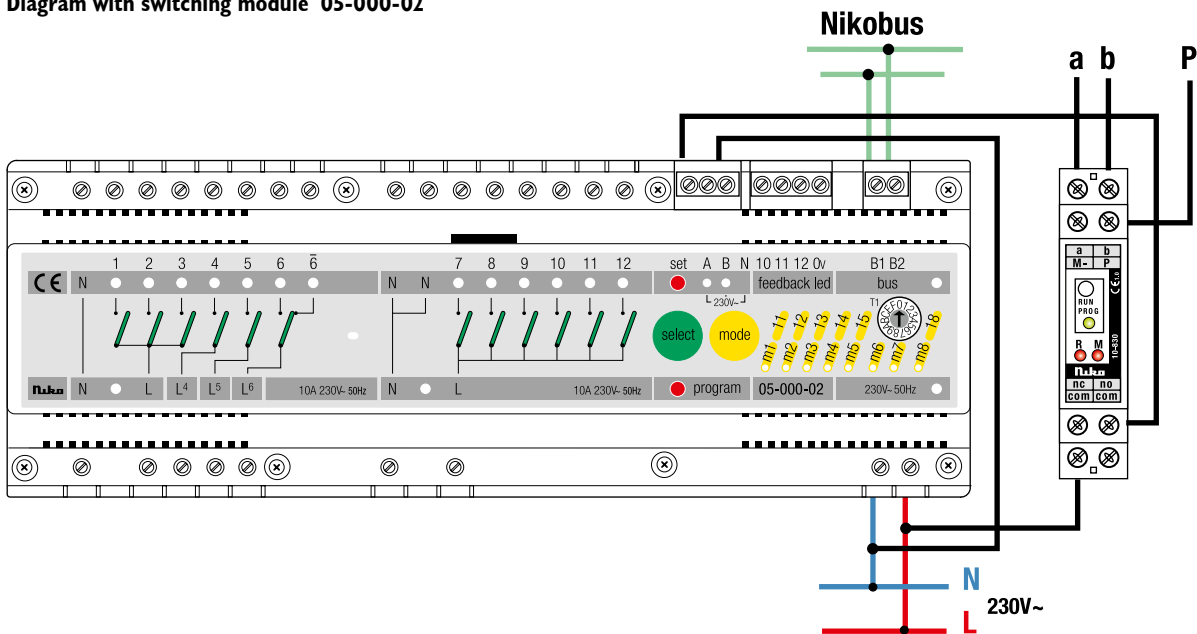

**SEMAPHOR WITH NIKO POWER SUPPLY 04-448**

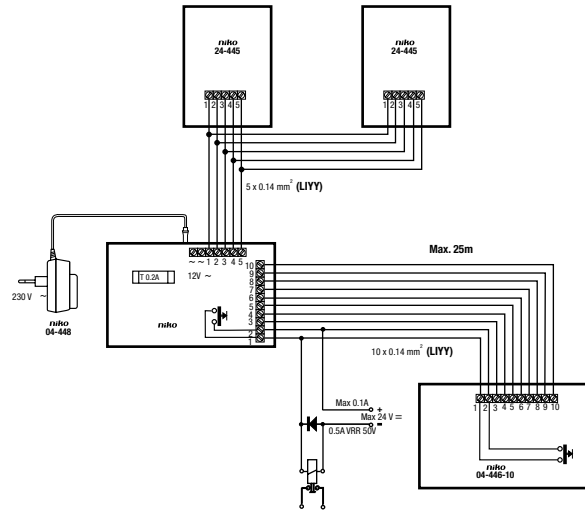
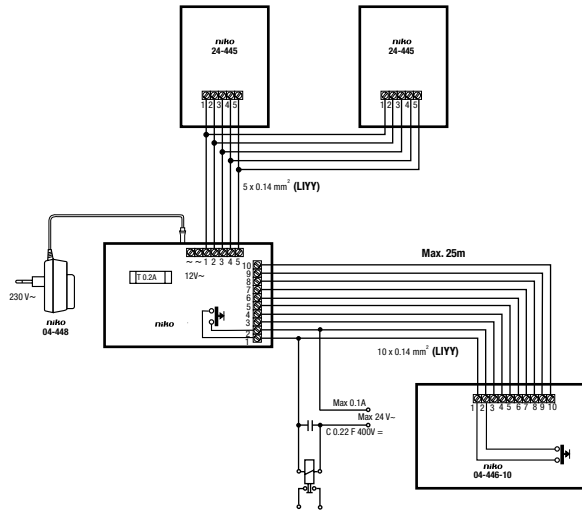

**SEMAPHOR WITH SAFETY TRANSFORMER 230V~/12V~**

