



Made in Italy

ITALIAN
QUALITY

Industrial division

M-LINE

SIR-E
SIR-E LED
FLR



 **SIRENA** S.p.A.



M-LINE

M-Line is a new and unique modular concept developed by Sirena which takes signaling devices to a whole new level delivering users with a customized product tailored for each specific application.

The high optical performances of the beacons, together with the strong sound output of the sounders makes M-Line a high-end range destined to the most demanding applications.

After a series of rigorous tests, M-Line has been granted IP65 status, a very high rating, especially for sounders, making this product ideal also for outdoor applications.

M-Line has been engineered with a unique modular concept which allows each of the three **domes** to be mounted on any of the five **bases**, drastically reducing on the number of parts stocked and allowing Professionals to have a more reactive response to the market needs.

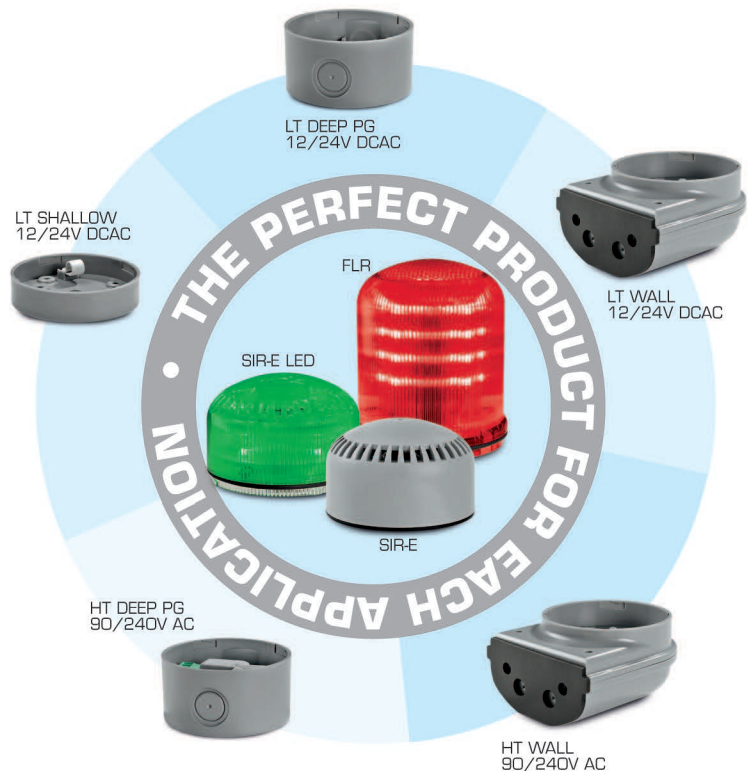

Furthermore, the innovative design allows M-Line to become a key player also in commercial and civil applications besides more traditional industrial applications.



M-LINE: multi-level technology

DOMES

Sirena has developed three multi-functional domes based on a unique **multi-level technology** allowing each function of the device to be controlled independently, creating **different levels of alarm** with one single device.

All M-Line acoustic domes adopt Sirena's brand new **"real-Time" technology** that allows modifying sounds via dip-switches without the need to power off the device allowing power-on operations on machinery.

Each M-Line component has also been engineered with an easy snap-on technology that allows easy and safe installation procedures also in the most challenging environments.

BASES

Sirena has developed three unique base shapes with two ranges of voltages offering a total of five different options: a perfect fit for each application.

- The **SHALLOW base** (available in **12/24V ACDC**) is the ideal choice for all flat mounting applications where cabling occurs from the bottom of the signaling device and where a more compact design is required
- The **DEEP base** (available in **12/24V ACDC** and **90/240V AC**) offers the possibility to install up to two cable glands (IN and OUT) on the sides of the base. This is the ideal choice when cabling from the bottom of the device is not possible or when an "in-series" installation is required
- The **WALL base** (available in **12/24V ACDC** and **90/240V AC**) is the ideal choice for "on-wall" installations

M-LINE: an "intelligent" solution to the most demanding applications

THE PERFECT PRODUCT FOR EACH APPLICATION

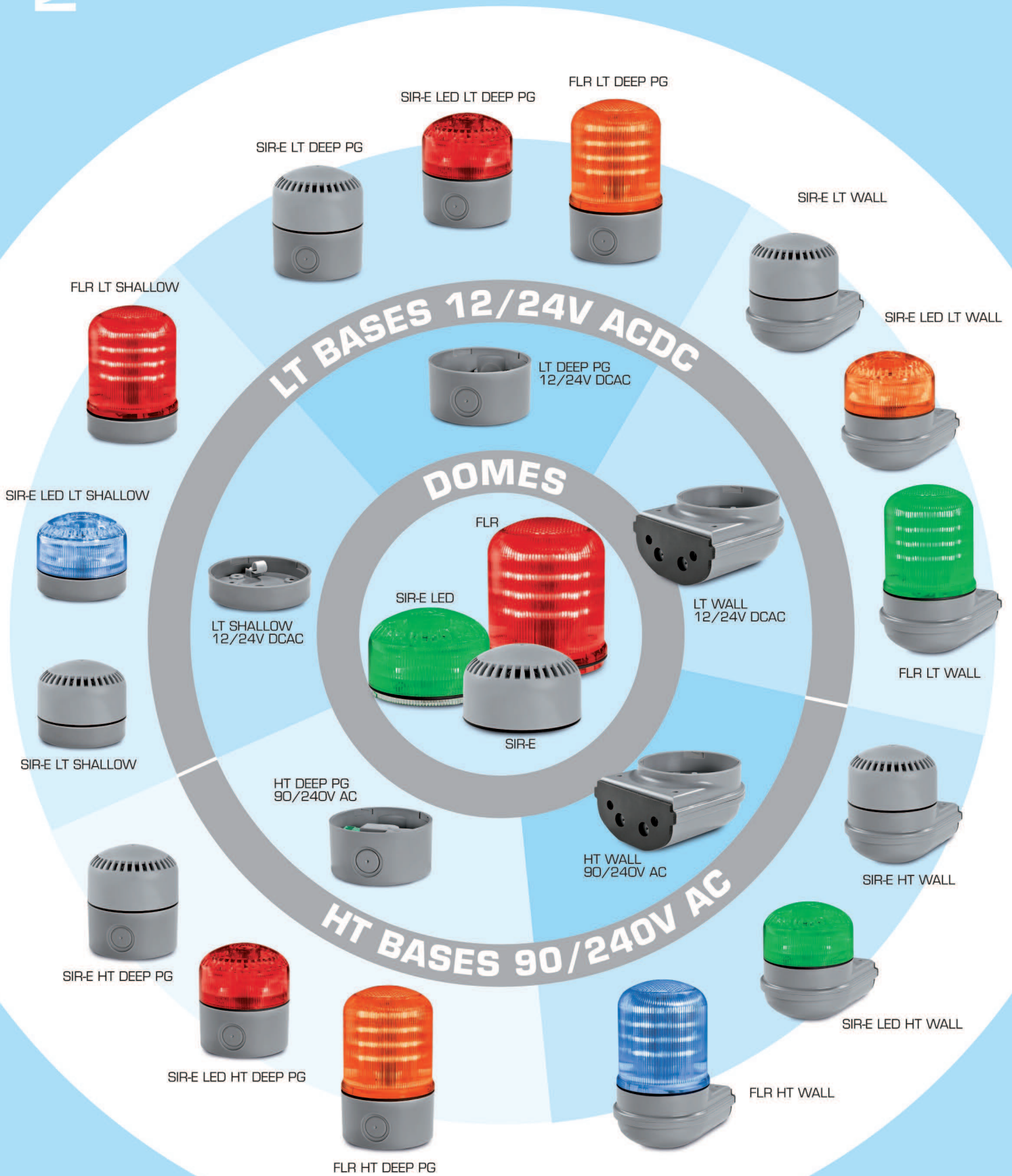



with LT base with HT base

$V = \text{---}$	12÷24		-	
$V \sim$	-		90÷240	
mA	215	250	60	35
dB(A)1m	102	105	100	100

IP 65	On ∞	°C -30 +50
64	PC	self-extinguishing

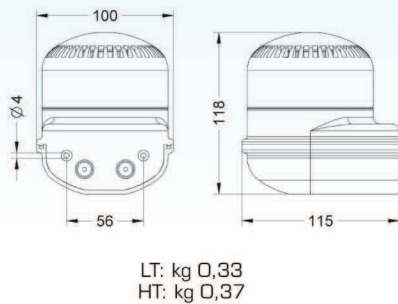
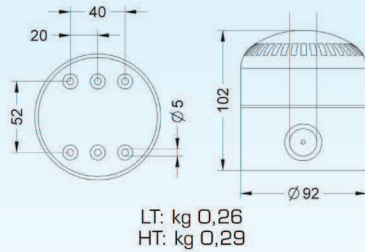
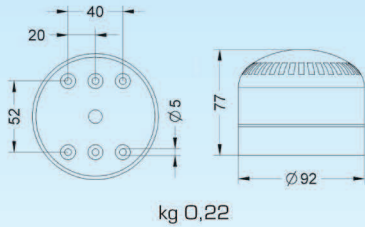

Multi-functional electronic sounder that guarantees a high sound output. Developed with a multi-level technology, the device allows two separate levels of alarm (warning, alarm) controllable via separate electric contacts. SIR-E benefits from 64 different sounds (selectable via dip-switch "A" and "B").

KEY CHARACTERISTICS

- **Multi-function:** 2 separate functions (warning, alarm) controllable independently via separate electric contacts
- **High sound performances:**
 - **First level of alarm:** a powerful up to 105 dB electronic sound, ideal for alerting staff of a danger or a serious change of operational circumstances (sound selectable via dip switch "A" out of 32 sounds)
 - **Second level of alarm:** a powerful up to 105 dB electronic sound, ideal for alerting staff of a permanent change of operational circumstances (sound selectable via dip switch "B" out of 32 sounds)
- **Possibility of lowering the volume:** min. 65 dB ca.
- **Multi-tone:** 64 sounds available, from fire alarm to civil tones
- **Multi-tension bases:** 12/24V ACDC and 90/240V AC
- **Three bases available:** SHALLOW, DEEP (PG) and WALL mount
- **High IP 65 rating:** also excellent for outdoor applications



LT SHALLOW
12/24V DCAC

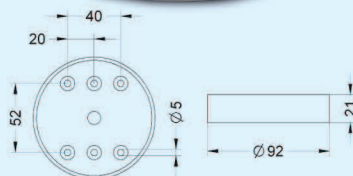

kg 0,04



PG
LT DEEP PG
12/24V DCAC

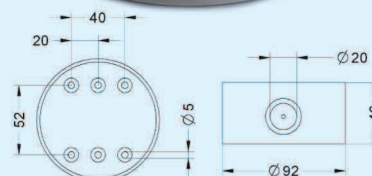

kg 0,08

SIR-E LED



with LT base with HT base

V	12÷24		-	
V			90÷240	
mA	300	350	95	60
dB(A)1m	102	105	100	100

Flash/min. 3F: 85±10	IP 65	On
°C -30 +50	64	PC self-extinguishing

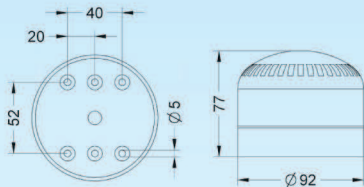

kg 0,22

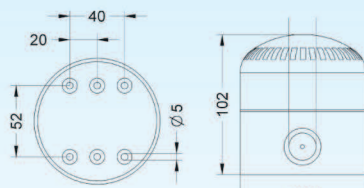

LT: kg 0,26
HT: kg 0,29

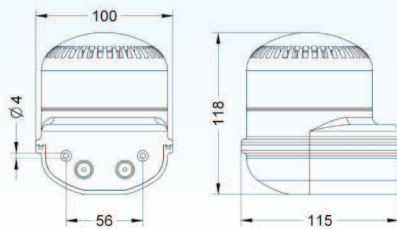

LT: kg 0,33
HT: kg 0,37

Multi-functional LED beacon-sounder that guarantees high optical performances as well as a high sound output. Developed with a multi-level technology, the device allows three separate levels of alarm (warning, alarm 1, alarm 2) controllable via separate electric contacts. SIR-E LED benefits from two light effects (steady, flashing) and 64 different sounds (selectable via dip-switch "A" and "B").

KEY CHARACTERISTICS

- **Multi-function:** 3 separate functions (warning, alarm 1, alarm 2) controllable independently via separate electric contacts
- **High sound performances:**
 - **First level of alarm:** a powerful triple-flash strobe effect that guarantees catching attention and warns operators of a potential danger or change of operating modes
 - **Second level of alarm:** a powerful triple-flash strobe effect combined with an up to 105 dB electronic sound, ideal for alerting staff of a danger or a serious change of operational circumstances (sound selectable via dip switch "A" out of 32 sounds)
 - **Third level of alarm:** a powerful steady light combined with an up to 105 dB electronic sound, ideal for alerting staff of a permanent change of operational circumstances (sound selectable via dip switch "B" out of 32 sounds)
- **Possibility of lowering the volume:** min. 65 dB ca.
- **Multi-tone:** 64 sounds available, from fire alarm to civil tones
- **Four colours available:** red, amber, green and blue
- **SMD LED technology:** longer lifetime and better resistance to vibrations
- **Multi-tension bases:** 12/24V ACDC and 90/240V AC
- **Three bases available:** SHALLOW, DEEP (PG) and WALL mount
- **High IP 65 rating:** also excellent for outdoor applications

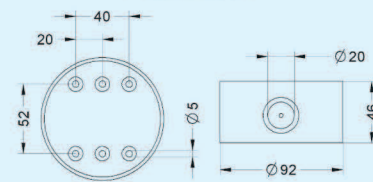
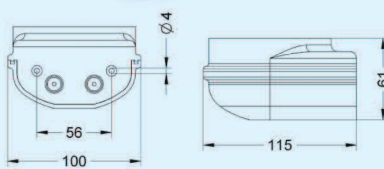
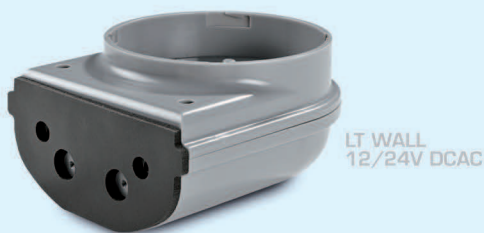

FLR



with LT base with HT base

V \equiv	12÷24	-	
V \sim		90÷240	
mA	530	330	100 70

Flash/min.	0 / 3F: 85±10	r.p.m.	140±10	IP	65
On	∞	°C	-30 +50	PC	self-extinguishing

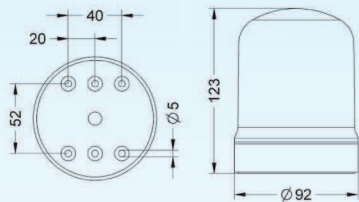

kg 0,19

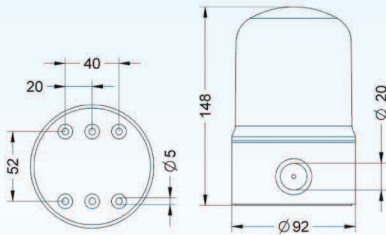

LT: kg 0,23
HT: kg 0,26

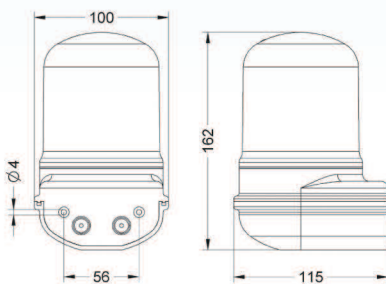

LT: kg 0,30
HT: kg 0,34

Multi-functional LED beacon with high optical performances. Developed with a multi-level technology, the device allows three separate lighting effects (steady, rotating, flashing) controllable via separate electric contacts.

KEY CHARACTERISTICS

- **Multi-function:** 3 separate functions (Steady, Rotating and Flashing) controllable independently via separate electric contacts
- **High optical performances:**
 - **Steady:** a deep and rich light source ideal for attracting attention yet without disturbing
 - **Flashing:** a triple-flash strobe effect ideal for all applications where an immediate attention gain is mandatory
 - **Rotating:** a unique rotating effect which perfectly simulates the traditional rotating beacons yet without moving parts hence enormously enhancing product life time
- **Four colours available:** red, amber, green and blue
- **SMD LED technology:** longer lifetime and better resistance to vibrations
- **Multi-tension bases:** 12/24V ACDC and 90/240V AC
- **Three bases available:** SHALLOW, DEEP (PG) and WALL mount
- **High IP 65 rating:** also excellent for outdoor applications



HT WALL
90/240V AC

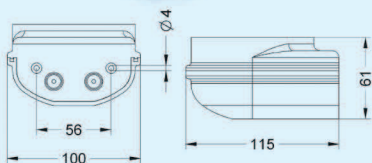

kg 0,19

CODES

DOMES					
SIR-E	90360	-	-	-	-
SIR-E LED	-	90361	90362	90363	90364
FLR	-	90351	90352	90353	90354

BASES	LOW TENSION	HIGH TENSION
BASE LT SHALLOW V12/24 DCAC	90367	-
BASE LT DEEP PG V12/24 DCAC	90368	-
BASE LT WALL V12/24 DCAC	90370	-
BASE HT DEEP PG V90/240 AC	-	90369
BASE HT WALL V90/240 AC	-	90371

V20-60DC/20-48AC range also available on request



SIRENA s.p.a.

Direzione e Sede: Corso Moncalisio 5-10-12-14-16 - 10090 ROSTA (Torino) Italia
Tel. 011.95.68.555 - Int. +39.011.95.68.555 - Fax 011.95.67.928 - 011.95.68.595
Fax Export +39.011.95.68.597 - E-mail: sirena.spa@sirena.it - www.sirena.it
R.E.A. 487901 - MECC. TO 027549 - Registro Imprese TO - C.F. 01047730013
Partita IVA comunitaria: IT 01047730013
Capitale sociale € 5.000.000 di cui versato € 5.000.000

Printed in Italy by LITOGRAF - 11/2011 - Ref. 2910

Distributed by