



Technical Data Sheet & Configuration Guide



High Performance, Broadband Network Analysis Solutions ME7828A Series

Vector Network Analyzers, Broadband and Millimeter Wave 70 kHz to 110 GHz,
Millimeter Waveguide Extensions to 0.5 THz

Introduction

This document provides the specifications for the VectorStar™ Broadband and mmWave configuration Vector Network Analyzers (VNAs), including all related options, and accessories. Alternative configurations available on request.



ME7828A Broadband Configuration

Table of Content

Description	Page
1. Definitions	2
2. Specifications for Broadband Configuration	4
2.1 System and Receiver Dynamic Range, Noise Floor.	4
2.2 Port Power Range, Receiver Compression	5
2.3 High Level Noise	5
2.4 Stability	5
2.5 Corrected System Performance and Uncertainties.	6
2.6 Measurement Time	7
2.7 Block Diagram.	7
2.8 Kelvin Bias Tees with Configuration -012	7
3. Specifications for Waveguide Band Configurations	8
3.1 Port Power, Noise Floor, Dynamic Range	8
3.2 Corrected System Performance and Uncertainties.	9
3.3 Measurement Time	14
3.4 Block Diagram.	14
4. Measurement Examples	15
5. Standard Capabilities for All Configurations	19
6. Calibration and Correction Capabilities.	20
7. Mechanical Calibration/Verification Kits	20
8. Test Port Cables	21
9. Precision Adapters, Attenuators, and more.	22
10. Warranty	22
11. Ordering Information	23

1. Definitions

All specifications and characteristics apply under the following conditions:

- After 90 minutes of warm-up time, where the instruments is left in the ON state.
- Over the 25 °C ± 5 °C temperature range, unless otherwise stated.
- For error- corrected specifications, over 23 °C ± 3 °C, with < 1° C deviation from calibration temperature.
- Specifications do not include effects of any user cables attached to the instrument.
- Specifications may exclude discrete spurious responses.
- All specifications apply with internal 10 MHz Reference Signal.
- All specifications subject to change without notice. For the most current data sheet, please visit the Anritsu website: www.us.anritsu.com
- All specifications below 300 kHz are typical.
- Typical performance indicates the performance of an average unit. It does not include any guard-bands and is not covered by the product warranty.

Typical specifications are shown in parenthesis, such as (-102 dB), or noted as Typical.

ME7828A Broadband System Configuration:

The ME7828A broadband VNA system provides single sweep coverage from 10 MHz to 110 GHz for measuring active devices. Consists of the following items:

- MS4647A VectorStar VNA, 10 MHz to 70 GHz with options 001, 007, 051
- 3738A Broadband VNA test set
- 3738A-002 Option 002, ME7828A configuration
- MG37022A (2) Fast Switching Signal Generator, 2-20 GHz, with option 001
- 3742A-EW (2) MM Module, with Attenuator
- 66670-3 MUX coupler, Left with 70 kHz internal bias tee
- 66671-3 MUX coupler, Right with 70 kHz internal bias tee
- 806-206 V Male to V Female phase stable interconnect cable, 24" (2)
- 806-207 V Male to V Male phase stable interconnect cable, 24" (2)
- 3700C3 Floor Console
- ME7828A-SS020 On-site system assembly and verification

ME7828A Broadband System Options:

- MS4647A Option 070, 70 kHz start frequency
- MS4647A Option 002, Time Domain Measurements
- 70556 Replaces 806-206 and 806-207 24" cables with 806-208 and 806-209 36" cables
- 70555 Cable set for SUSS MicroTec SIGMA integration. Replaces 806-206 and 806-207 24" cables with 806-210 806-211 14" cables. Replaces RF and LO ruggidized semi-rigid cables with 806-121 (qty 2) 36" flex cables.

ME7828A- Option 012

Option 012 is a premium package offering enhanced performance of the ME7828A broadband VNA system with single sweep coverage from 70 kHz to 110 GHz.

Consisting of the following additional items:

- MS4647A VectorStar VNA, Option 070, 70 kHz start frequency
- MS4647A VectorStar VNA, Option 062, adds four attenuators in forward and reverse directions for maximum power level control, bias tees in the VNA test set, gain compression and efficiency measurement software.
- MS4640A Option 002 Time Domain Measurements

ME7828A MillimeterWave System Configuration

The ME7828 Millimeter Wave VNA provides waveguide band coverage up to 500 GHz.

Consists of the following items:

- Any MS4640A VNA
- 3738A Test Set - 3738A-002 Option 002, ME7828A configuration
- MG37022A (2) Fast Switching Signal Generator, 2-20 GHz, with Option 001 (2 each)
- Any 3740A-x or 3741A-x Millimeter Wave Modules (two are required)
- 3700C3 Floor Console

A separate document found on the Anritsu website (www.us.anritsu.com) provides specifications for the MS4640A-series 20, 40, 50 and 70 GHz VNAs.

2. Specifications for Broadband Configuration

ME7828A Broadband System configured for Active Device Measurements, 10 MHz to 110 GHz

Nominal power level control of 20 dB. Does not include source or receive attenuators for Port1 or Port2. Kelvin bias tees included in the MUX coupler/combiner for active device measurements. Connection to Triax output Source Measure Units (SMUs) available.

ME7828A, Option 012, Broadband System for Active Device Measurements, 70 kHz to 110 GHz

Option 012 is a premium package providing enhanced performance of the ME7828A. In addition to 70 kHz operation, additional performance includes source and receiver attenuators for Port1 and Port2 for extended power level control.

2.1 System and Receiver Dynamic Range, Noise Floor¹

System Dynamic Range is calculated as the difference between the maximum rated port power and the specified noise floor at ports 1 or 2.

Receiver Dynamic Range is calculated as the difference between the receiver compression level and the specified noise floor at ports 1 or 2.

Noise Floor is measured at 10 Hz IF Bandwidth with no averaging and ports terminated.

All noise floor values are RMS and measurements are made with a VNA port power setting of -10 dBm.

Normalizing measurement made with a through line connection, with its effects compensated for.

Frequency Range (GHz)	System Dynamic Range (dB)		Receiver Dynamic Range (dB)		Noise Floor (dBm)	
	ME7828A	Option 012	ME7828A	Option 012	ME7828A	Option 012
< 0.01	–	79	–	84	–	-73
0.01 to 2.5	114	112	119	119	-105	-104
2.5 to 5	101 (111)	99 (109)	112 (122)	113 (123)	-98 (-108)	-98 (-108)
5 to 20	101 (114)	99 (112)	116 (129)	117 (130)	-100 (-113)	-100 (-113)
20 to 38	98 (108)	95 (105)	118 (128)	118 (128)	-100 (-110)	-98 (-108)
38 to 50	95 (103)	92 (100)	118 (126)	120 (128)	-98 (-106)	-98 (-106)
50 to 65	86 (94)	82 (90)	121 (129)	121 (128)	-98 (-106)	-96 (-106)
65 to 67	82 (90)	78 (86)	118 (126)	118 (126)	-95 (-103)	-93 (-101)
67 to 75	81 (90)	81 (90)	105 (114)	105 (114)	-92 (-111)	-92 (-111)
75 to 85	90 (100)	90 (100)	109 (118)	109 (118)	-96 (-104)	-96 (-104)
85 to 100	90 (100)	90 (100)	107 (116)	107 (116)	-95 (-103)	-95 (-103)
100 to 110	90 (100)	90 (100)	107 (116)	107 (116)	-97 (-105)	-97 (-105)

1. Using the 806-206 and 806-207 1.85mm 24" test port cables.

2.2 Test Port Power, Receiver Compression¹

Port power control is provided by the base VNA below 67 GHz, and by a manual 20 dB attenuator in the mmW module above 67 GHz, Typical.

Receiver compression point is defined as the port power level beyond which the response may be compressed more than 0.2 dB relative to normalization level. 10 Hz IF bandwidth used to remove trace noise effects.

Frequency Range (GHz)	Port Power (dBm)		Receiver Compression (dBm)	
	ME7828A	Option.012	ME7828A	Option.012
< 0.01	-	+6	-	+11
0.01 to 2.5	+9	+8	+14	+15
2.5 to 5	+3	+1	+14	+15
5 to 20	+1	-1	+16	+17
20 to 38	-2	-3	+18	+20
38 to 50	-3	-6	+20	+22
50 to 65	-12	-14	+23	+25
65 to 67	-13	-15	+23	+25
67 to 75	-11	-11	+16	+16
75 to 85	-7	-7	+13	+13
85 to 100	-6	-6	+12	+12
100 to 110	-8	-8	+12	+12

2.3 High Level Noise

Measured at 1 kHz IF bandwidth, at default power, with through transmission. RMS, Typical.

Frequency (GHz)	Magnitude (dB)	Phase (degree/°C)
< 500 kHz	< 0.05	< 0.5
500 kHz to 2.5 GHz	< 0.005	< 0.05
2.5 to 5	< 0.004	< 0.04
5 to 20	< 0.004	< 0.04
20 to 40	< 0.005	< 0.06
40 to 67	< 0.010	< 0.08
67 to 75	< 0.010	< 0.08
75 to 85	< 0.005	< 0.05
85 to 100	< 0.005	< 0.05
100 to 110	< 0.005	< 0.05

2.4 Stability

Ratioed measurement at nominally full signal strength over the normal specified temperature range. Typical.

Frequency (GHz)	Magnitude (dB/°C)	Phase (degree/°C)
< 10 MHz	< 0.04	< 0.4
.01 to 2.5	< 0.03	< 0.3
2.5 to 5	< 0.03	< 0.3
5 to 20	< 0.03	< 0.3
20 to 40	< 0.05	< 0.5
40 to 67	< 0.08	< 1.0
67 to 75	< 0.08	< 2.0 (< 1.5)
75 to 100	< 0.08	< 2.7 (< 1.5)
100 to 110	< 0.08	< 3.0 (< 2.0)

1. Using the 806-206 and 806-207 1.85mm 24" test port cables.

2.5 Corrected System Performance and Uncertainties

With 12-term concatenated SOLT and Triple Offset Short Calibration, using the 3656B W1 Cal Kit

Frequency Range (GHz)	Directivity (dB)	Source Match (dB)	Load Match (dB)	Reflection Tracking (dB)	Transmission Tracking (dB)
< 2.5	31	31	31	.06	.07
2.5 to 20	31	31	31	.06	.07
20 to 40	29	31	29	.06	.08
40 to 65	29	31	29	.10	.10
65 to 67	27	31	27	.10	.10
67 to 75	30	30	30	.08	.10
75 to 85	30	30	30	.08	.10
85 to 100	30	30	30	.08	.10
100 to 110	30	30	30	.08	.10

Measurement Uncertainties

The graphs give measurement uncertainties after the above calibration. The errors are worst case contribution of residual directivity, load and source match, frequency response and isolation, network analyzer dynamic accuracy, and connector repeatability. 10 Hz IF Bandwidth is used. For transmission uncertainties, it is assumed that $s_{11} = s_{22} = 0$. For reflection uncertainties, it is assumed that $s_{21} = s_{12} = 0$. For other conditions, please use our free Exact Uncertainty calculator software, down-loadable from the Anritsu website at, www.us.anritsu.com.

W1 Reflection Magnitude Uncertainties

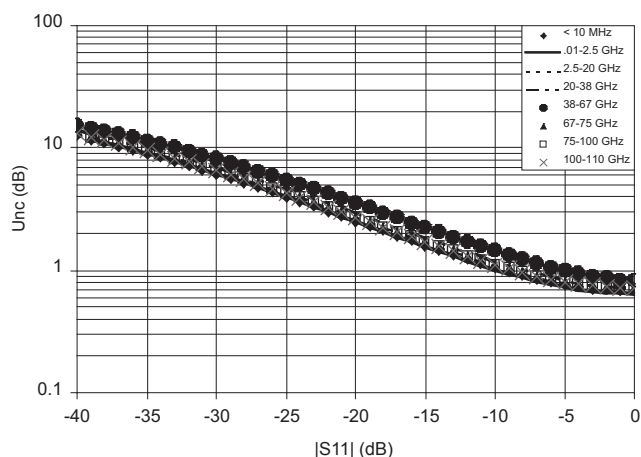

W1 Reflection Phase Uncertainties

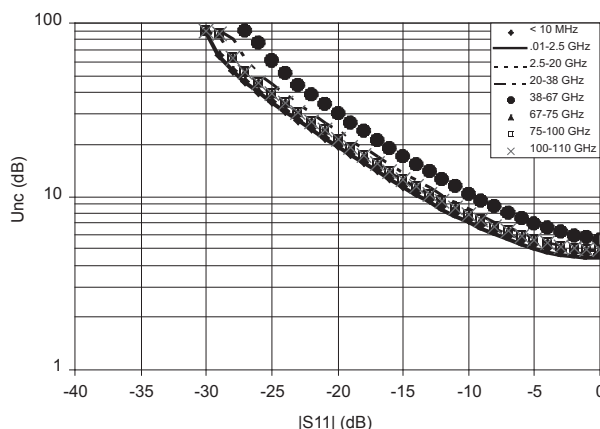

W1 Transmission Magnitude Uncertainties

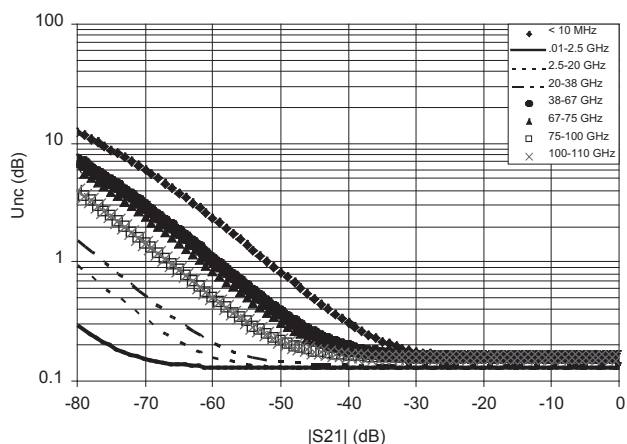

W1 Transmission Phase Uncertainties

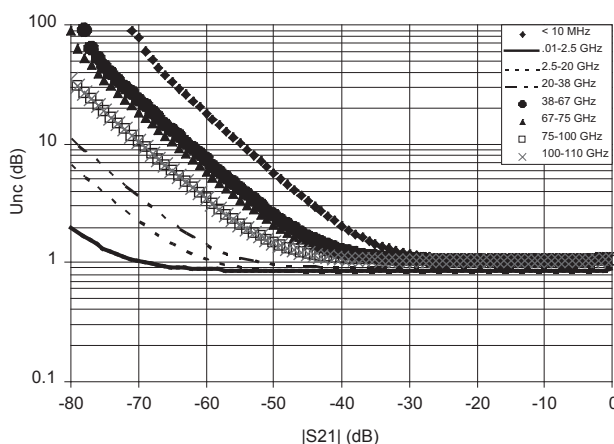

2.6 Measurement Time

Measurement times include sweep time, retrace time, and band-switching time. Typical.

Measurement Time (ms), Option 12 Full Band, 70 kHz to 110 GHz, SYNTHESIZED sweep, Display ON and ALC ON, TTL Fast Trigger Mode ON

Calibration	IF BW	201 points	401 points	1,601 points	10,001 points
Uncorrected or 1-port calibration	1 MHz	120	200	600	3,700
	30 kHz	120	200	600	3,700
	10 kHz	120	200	600	3,700
	1 kHz	300	500	1,900	12,000
	10 Hz	19,000	38,000	145,000	1,200,000
2-port calibration	1 MHz	240	400	1,200	7,400
	30 kHz	240	400	1,200	7,400
	10 kHz	240	400	1,200	7,400
	1 kHz	600	1,000	3,800	24,000
	10 Hz	38,000	76,000	290,000	2,400,000

Measurement Time (ms) vs. Noise Floor (dBm), Full Band, SYNTHESIZED sweep, Display ON and ALC ON

Calibration	201 points Measurement Time	Achieved Noise Floor (Opt 012 at 67 GHz)	IF BW and Averaging Used
Uncorrected or 1-port calibration	200	-65	10 kHz/no avg
	500	-75	1 kHz/no avg
2-port calibration	400	-65	10 kHz/no avg
	1000	-75	1 kHz/no avg

2.7 Block Diagram

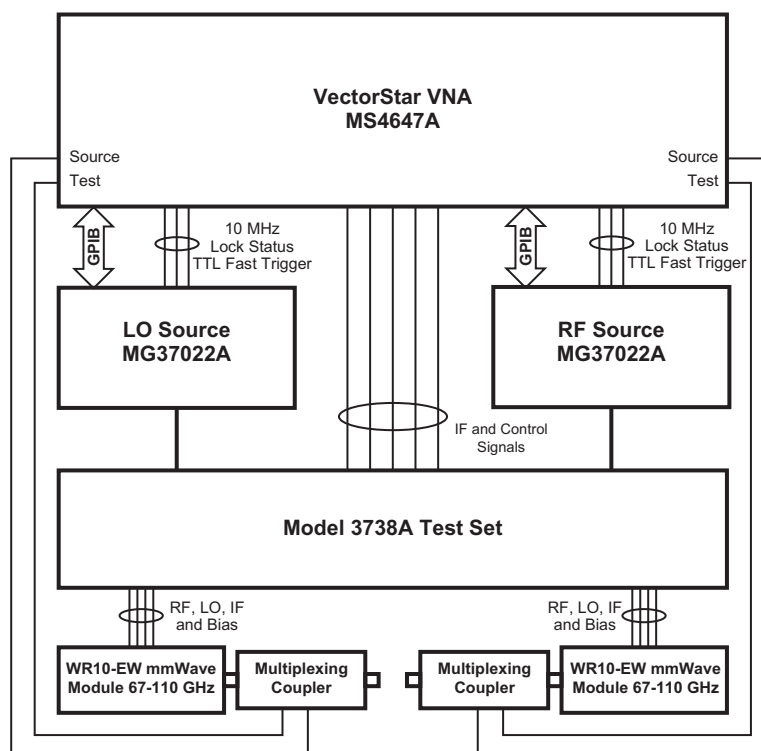

2.8 Kelvin Bias Tees

Provides Sense and Force BNC connections per combiner, close to the W1 interface, to minimize the IR drops associated with the impedances between the bias tee and the DUT. (Max Voltage: 16 VDC, Max Current: 100 mA)

For applications requiring Source Measure Units (SMUs) with tri-axial outputs, a tri-axial (male) to BNC (male) cable is available, with the inner-shield isolated from ground at the bias tee BNC end, to float at the SMU's guard potential. (Check the accessories list for ordering information.)

3. Specifications for Waveguide Band Configurations

ME7828A-000 mmW VNA, Waveguide band

Can be configured for the V, E, Extended-E, W, and Extended-W waveguide bands. Two mmW modules are needed, one per port. Two 3740A-style Transmission/Reflection modules could be used for full 2-port measurements. For Forward direction only measurements, a 3740A-style module is still needed on port 1, but a 3741A-style Transmission Only module could be substituted on port 2.

Band*	Frequency Range*	Waveguide Flange	Transmission/Reflection Module	Transmission Only Module
V	50 to 75 GHz	WR-15	3740A-V	3741A-V
E	60 to 90 GHz	WR-12	3740A-E	3741A-E
Ext-E	56 to 94 GHz	WR-12	3740A-EE	3741A-E
W	75 to 110 GHz	WR-10	3740A-W	3741A-W
Ext-W	65 to 110 GHz	WR-10	3740A-EW	3741A-EW

* For different bands such as WR-5 (140 to 220 GHz), WR-3 (220 to 325 GHz), or higher, please call the factory for a quote. For more information on mmwave modules, please visit www.omlinc.com.

3.1 Port Power, Noise Floor, Dynamic Range

System dynamic range is defined as the ratio of the source power to the noise floor.

Receiver dynamic range is defined as the ratio of max. receive power to the noise floor.

Noise Floor measurements are RMS, are made with no average in a 10 Hz IF bandwidth, and include an isolation calibration.

All figures are typical.

V Band (WR-15) Waveguide

Frequency Range (GHz)	Source Power (dBm)	Max. Receive Power (dBm)	Noise Floor (dBm)	System Dynamic Range (dB)	Receiver Dynamic Range (dB)
50 to 75	+7	+8	-95	102	103

E Band (WR-12) Waveguide

Frequency Range (GHz)	Source Power (dBm)	Max. Receive Power (dBm)	Noise Floor (dBm)	System Dynamic Range (dB)	Receiver Dynamic Range (dB)
60 to 90	+6	+8	-95	101	103

Extended-E Band (WR-12) Waveguide

Frequency Range (GHz)	Source Power (dBm)	Max. Receive Power (dBm)	Noise Floor (dBm)	System Dynamic Range (dB)	Receiver Dynamic Range (dB)
56 to 60	+5	+8	-90	95	98
60 to 85	+6	+8	-95	101	103
85 to 94	+4	+8	-81	85	89

W Band (WR-10) Waveguide

Frequency Range (GHz)	Source Power (dBm)	Max. Receive Power (dBm)	Noise Floor (dBm)	System Dynamic Range (dB)	Receiver Dynamic Range (dB)
75 to 100	+5	+6	-95	100	101
100 to 110	+2	+6	-95	97	101

Extended-W Band (WR-10) Waveguide

Frequency Range (GHz)	Source Power (dBm)	Max. Receive Power (dBm)	Noise Floor (dBm)	System Dynamic Range (dB)	Receiver Dynamic Range (dB)
65 to 67	-5	+6	-95	90	101
67 to 75	+3	+6	-96	99	102
75 to 100	+5	+6	-94	99	100
100 to 110	+2	+6	-92	94	98

3.2 Corrected System Performance and Uncertainties

With 12-term Offset Short Sliding Load or LRL Calibrations, using high precision waveguide sections and standards from the appropriate cal kit.

V Band (WR-15) Waveguide, 50 to 75 GHz

Calibration Type	Directivity (dB)	Source Match (dB)	Load Match (dB)	Reflection Tracking (dB)	Transmission Tracking (dB)
Offset Short	> 46	> 37	> 46	±0.030	±0.030
LRL	> 46	> 46	> 46	±0.002	±0.002

E Band (WR-12) Waveguide, 60 to 90 GHz

Calibration Type	Directivity (dB)	Source Match (dB)	Load Match (dB)	Reflection Tracking (dB)	Transmission Tracking (dB)
Offset Short	> 46	> 36	> 46	±0.040	±0.060
LRL	> 46	> 46	> 46	±0.002	±0.002

Extended-E Band (WR-12) Waveguide, 56 to 94 GHz

Calibration Type	Directivity (dB)	Source Match (dB)	Load Match (dB)	Reflection Tracking (dB)	Transmission Tracking (dB)
Offset Short	> 44	> 33	> 44	±0.080	±0.100
LRL	> 44	> 43	> 44	±0.006	±0.006

W Band (WR-10) Waveguide, 75 to 110 GHz

Calibration Type	Directivity (dB)	Source Match (dB)	Load Match (dB)	Reflection Tracking (dB)	Transmission Tracking (dB)
Offset Short	> 46	> 36	> 46	±0.040	±0.070
LRL	> 46	> 46	> 46	±0.002	±0.002

Extended-W Band (WR-10) Waveguide, 65 to 110 GHz

Calibration Type	Directivity (dB)	Source Match (dB)	Load Match (dB)	Reflection Tracking (dB)	Transmission Tracking (dB)
Offset Short	> 40	> 30	> 46	±0.080	±0.100
LRL	> 40	> 40	> 46	±0.006	±0.006

Measurement Uncertainties

The graphs give measurement uncertainties after the above calibration. The errors are worst case contribution of residual directivity, load and source match, frequency response and isolation, network analyzer dynamic accuracy, and connector repeatability. 10 Hz IF Bandwidth is used. For transmission uncertainties, it is assumed that $s_{11} = s_{22} = 0$. For reflection uncertainties, it is assumed that $s_{21} = s_{12} = 0$. For other conditions, please use our free Exact Uncertainty calculator software, down-loadable from the Anritsu website at, www.us.anritsu.com. Typical. The group of graphs represent an SSLT calibration or an LRL calibration.

E, Extended-E, and V Band Reflection Magnitude Uncertainties-SSLT

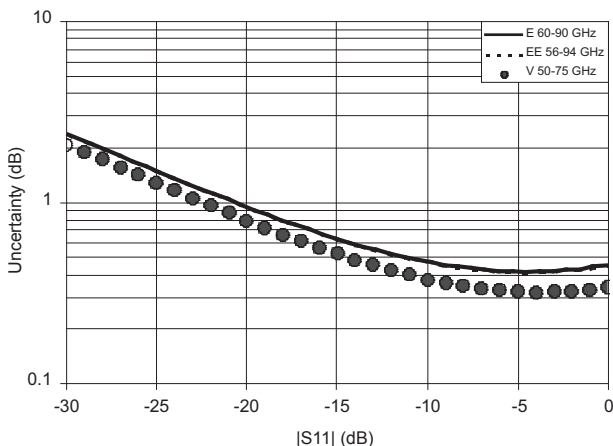

E, Extended-E, and V Band Reflection Phase Uncertainties-SSLT

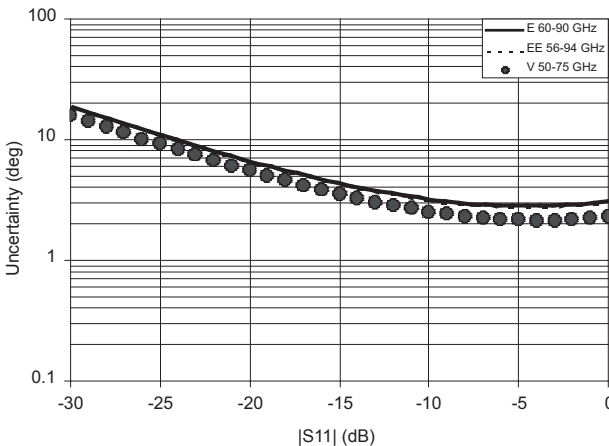

E, Extended-E, and V Band Transmission Magnitude Uncertainties-SSLT

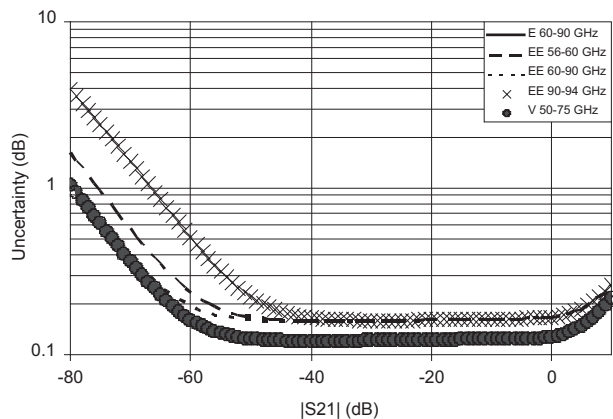

E, Extended-E, and V Band Transmission Phase Uncertainties-SSLT

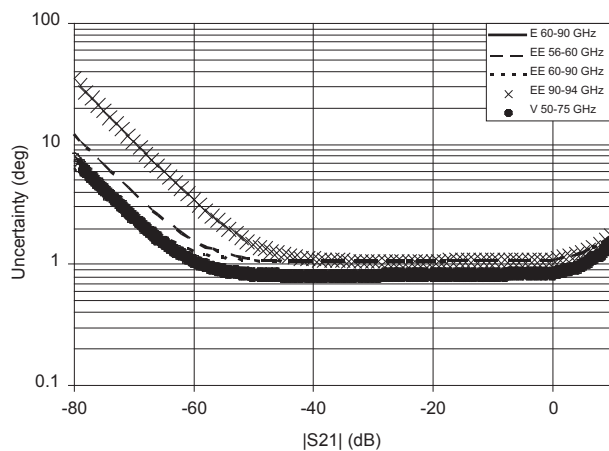

Measurement Uncertainties

The graphs give measurement uncertainties after the above calibration. The errors are worst case contribution of residual directivity, load and source match, frequency response and isolation, network analyzer dynamic accuracy, and connector repeatability. 10 Hz IF Bandwidth is used. For transmission uncertainties, it is assumed that $s_{11} = s_{22} = 0$. For reflection uncertainties, it is assumed that $s_{21} = s_{12} = 0$. For other conditions, please use our free Exact Uncertainty calculator software, down-loadable from the Anritsu website at, www.us.anritsu.com. Typical. The group of graphs represent an SSLT calibration or an LRL calibration.

E, Extended-E, and V Band Reflection Magnitude Uncertainties-LRL

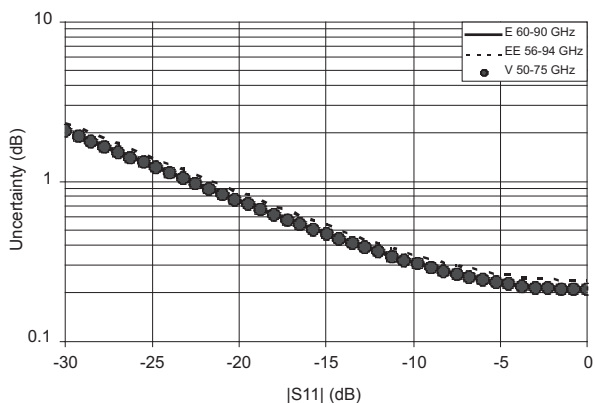

E, Extended-E, and V Band Reflection Phase Uncertainties-LRL

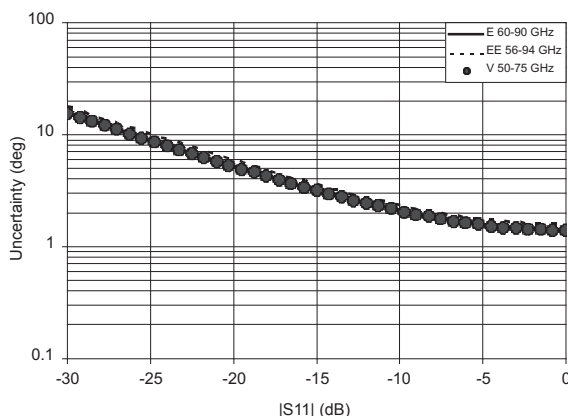

E, Extended-E, and V Band Transmission Magnitude Uncertainties-LRL

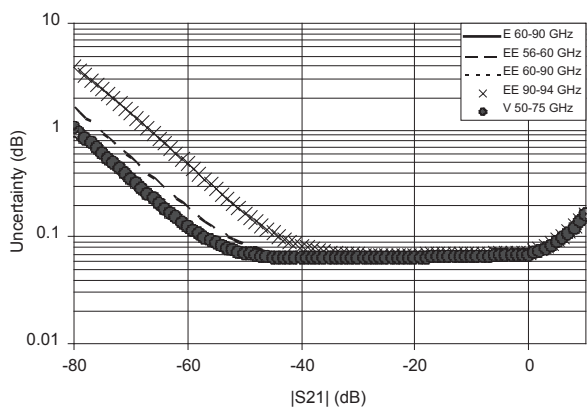

E, Extended-E, and V Band Transmission Phase Uncertainties-LRL

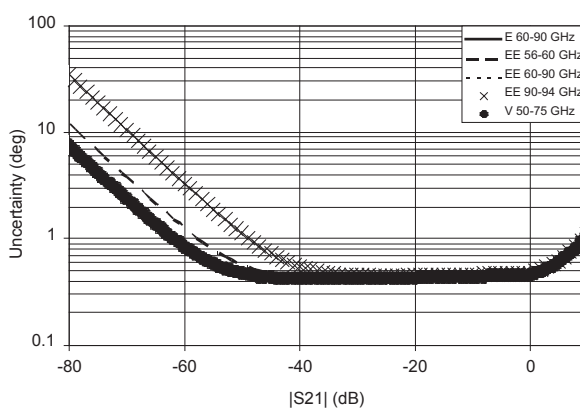

Measurement Uncertainties

The graphs give measurement uncertainties after the above calibration. The errors are worst case contribution of residual directivity, load and source match, frequency response and isolation, network analyzer dynamic accuracy, and connector repeatability. 10 Hz IF Bandwidth is used. For transmission uncertainties, it is assumed that $s_{11} = s_{22} = 0$. For reflection uncertainties, it is assumed that $s_{21} = s_{12} = 0$. For other conditions, please use our free Exact Uncertainty calculator software, down-loadable from the Anritsu website at, www.us.anritsu.com. Typical. The group of graphs represent an SSLT calibration or an LRL calibration.

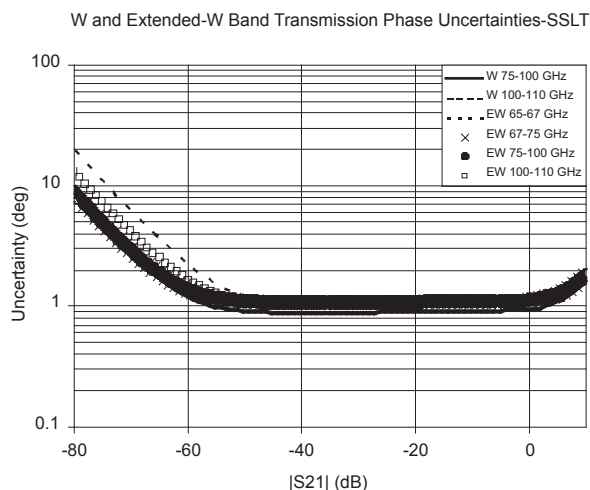
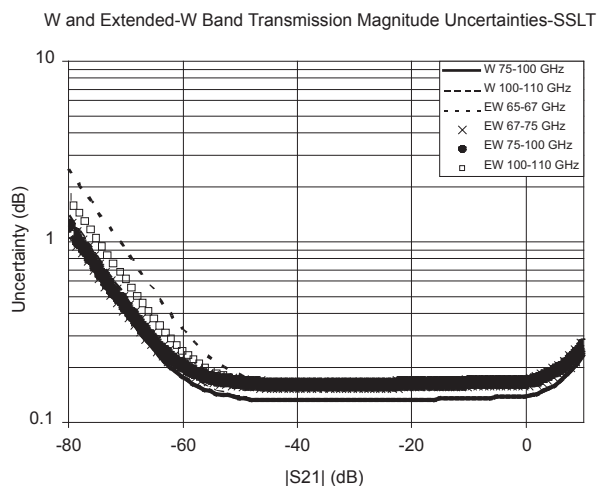
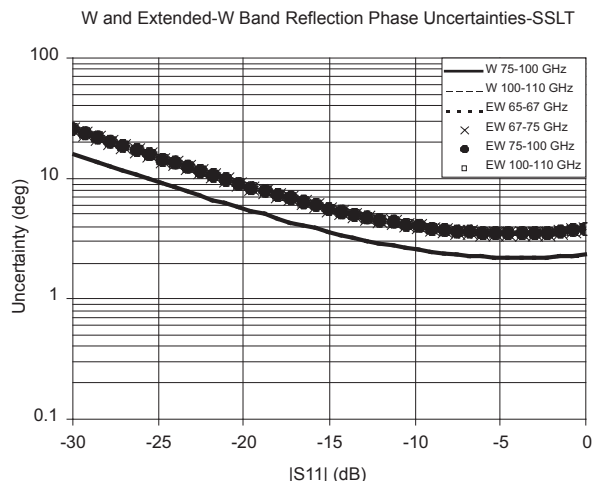
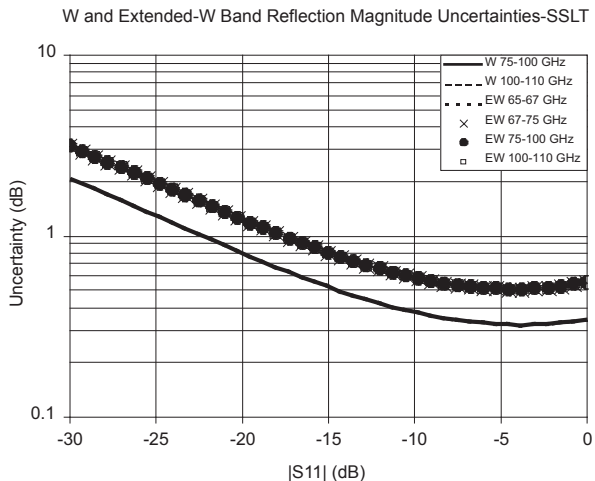

Measurement Uncertainties

The graphs give measurement uncertainties after the above calibration. The errors are worst case contribution of residual directivity, load and source match, frequency response and isolation, network analyzer dynamic accuracy, and connector repeatability. 10 Hz IF Bandwidth is used. For transmission uncertainties, it is assumed that $s_{11} = s_{22} = 0$. For reflection uncertainties, it is assumed that $s_{21} = s_{12} = 0$. For other conditions, please use our free Exact Uncertainty calculator software, down-loadable from the Anritsu website at, www.us.anritsu.com. Typical. The group of graphs represent an SSLT calibration or an LRL calibration.

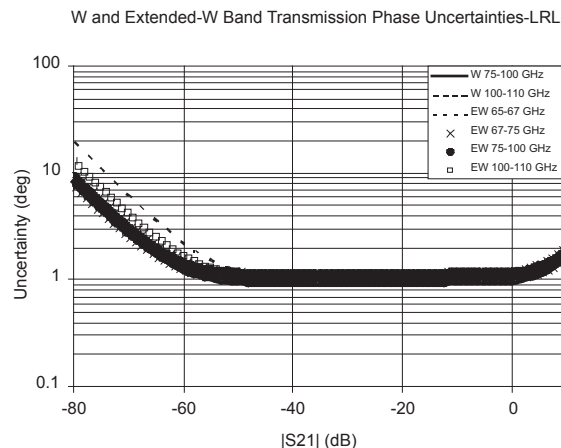
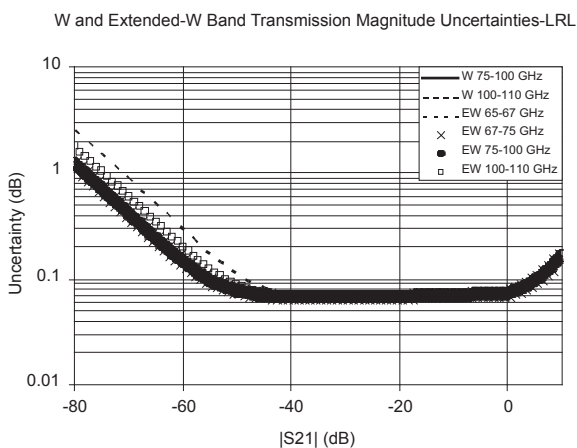
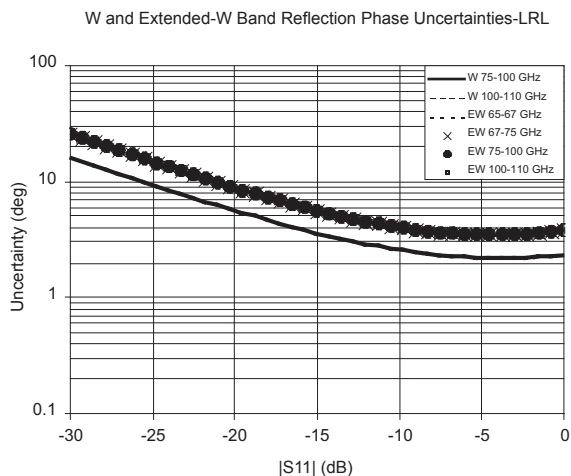
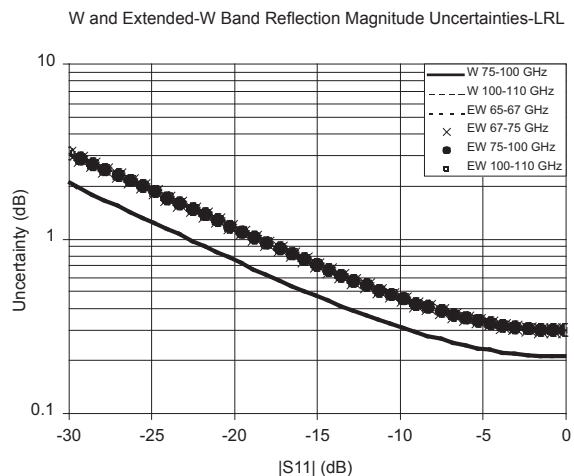

3.3 ME7828A Millimeter-Wave Configuration Measurement Time

Measurement times include sweep time, retrace time, and band-switching time. MG37020A Fast Switching Synthesizer. Typical.

Measurement Time (ms), Full Band, SYNTHESIZED sweep, Display ON and ALC ON, TTL Fast Trigger Mode ON

Calibration	IF BW	401 points	1,601 points	10,001 points
Uncorrected or 1-port calibration	1 MHz	700	2,000	5,000
	30 kHz	700	2,000	5,000
	1 kHz	900	2,500	12,500
	10 Hz	3,800	145,000	1,200,000
2-port calibration	1 MHz	1,400	4,000	10,000
	30 kHz	1,400	4,000	10,000
	1 kHz	1,800	5,400	24,000
	10 Hz	7,600	290,000	24,000,000

3.4 Block Diagram

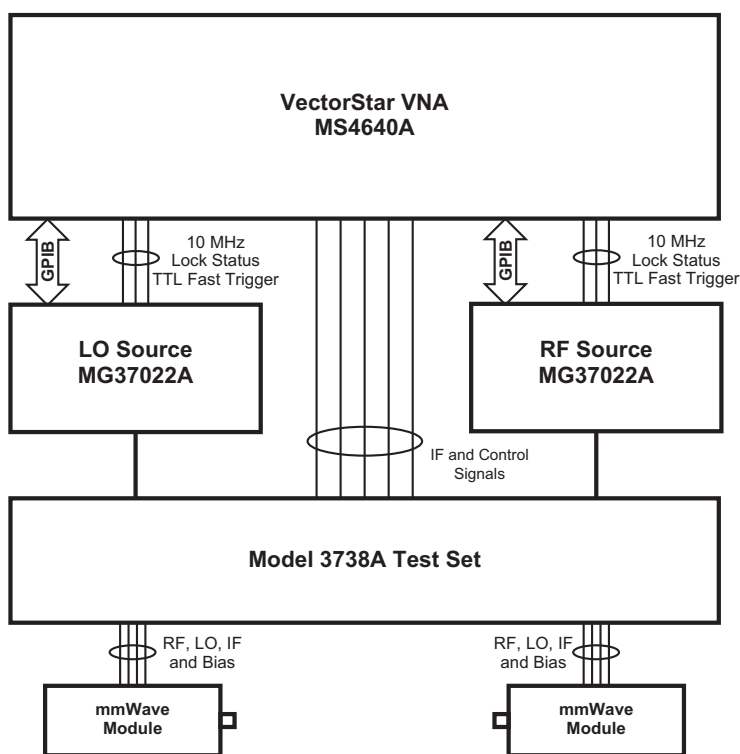

ME7828A Millimeter Wave Block Diagram

4. Measurement Examples

The following figures are measurement examples of different ME7828A configurations, including Broadband 70 kHz to 110 GHz, WR06 110-170 GHz, WR05 140-220 GHz and WR03 220-325 GHz bands.

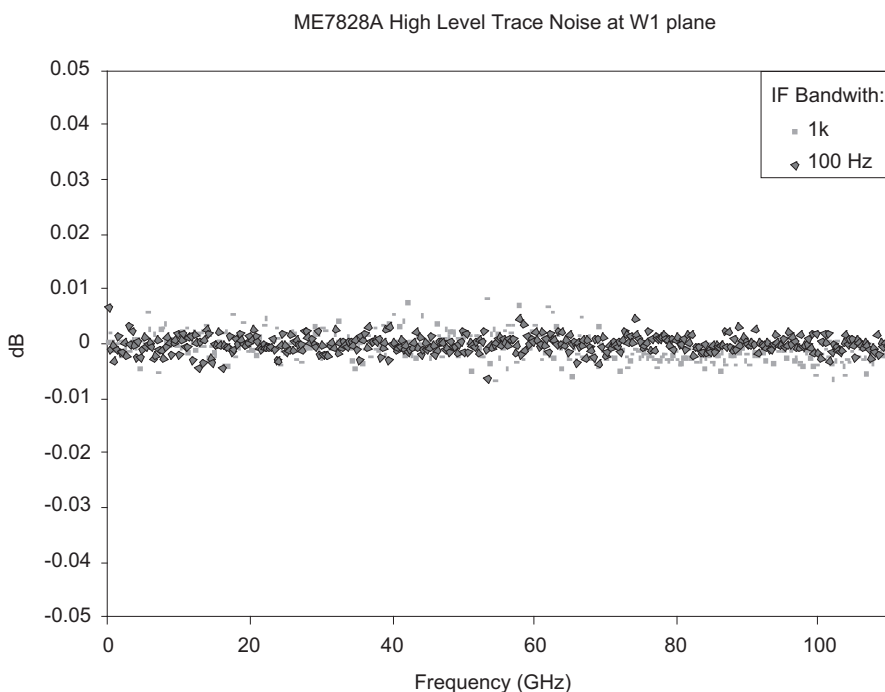

Figure 1. High level trace noise of ME7828A system at the W1 1mm coaxial test port with MG37022A Fast Switching Synthesizer.

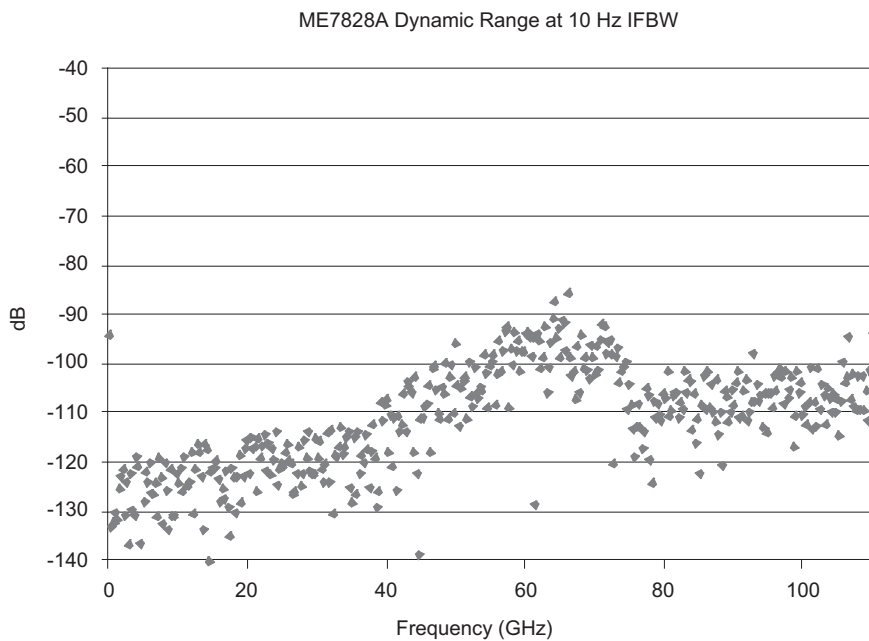

Figure 2. Dynamic Range of ME7828A system at the W1 1mm coaxial test port with MG37022A Fast Switching Synthesizer.

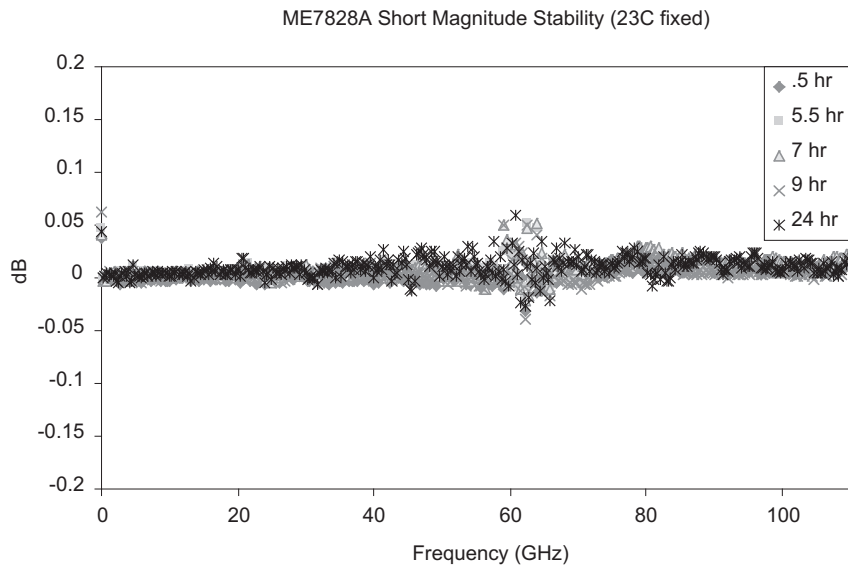

Figure 3. S11 measurement stability of short, ME7828A W1 1mm coaxial test port with MG37022A Fast Switching Synthesizer, over a 24 hour period.

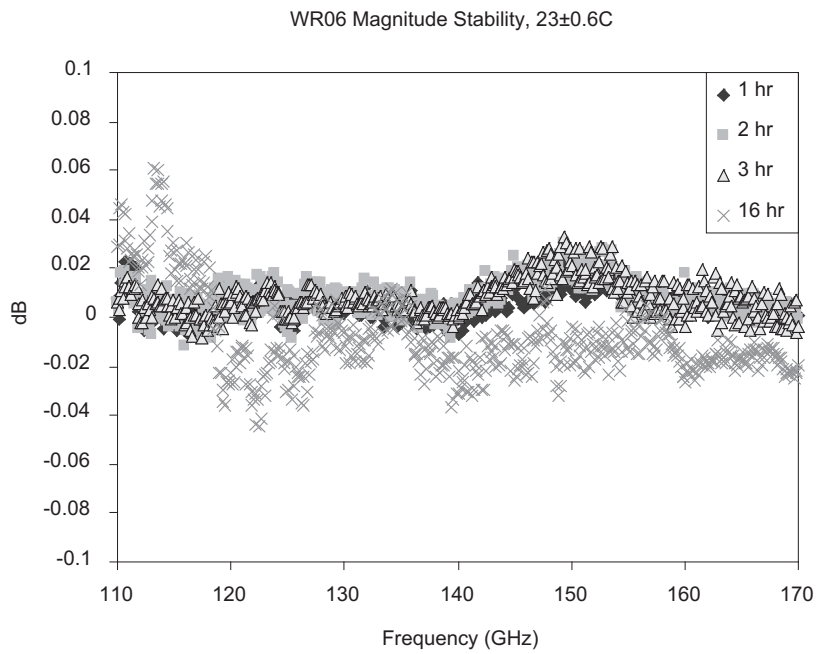

Figure 4. Magnitude stability plot of WR06 110 to 170 GHz using the Wildfire MG37022A fast switching synthesizer as the RF and LO source.

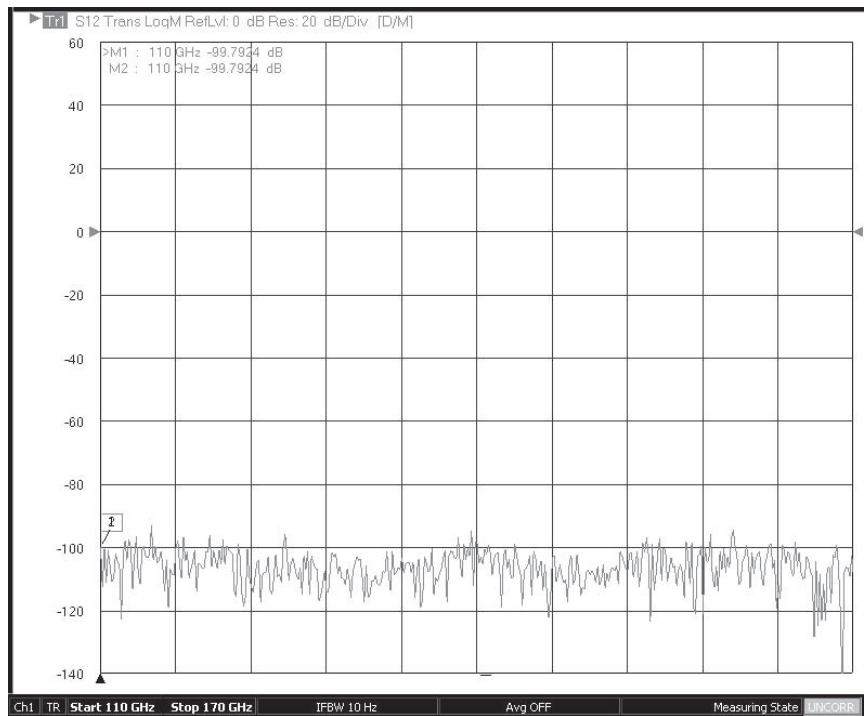

Figure 5. Dynamic range plot of the WR06 110 to 170 GHz band using the Wildfire MG37022A fast switching synthesizer.

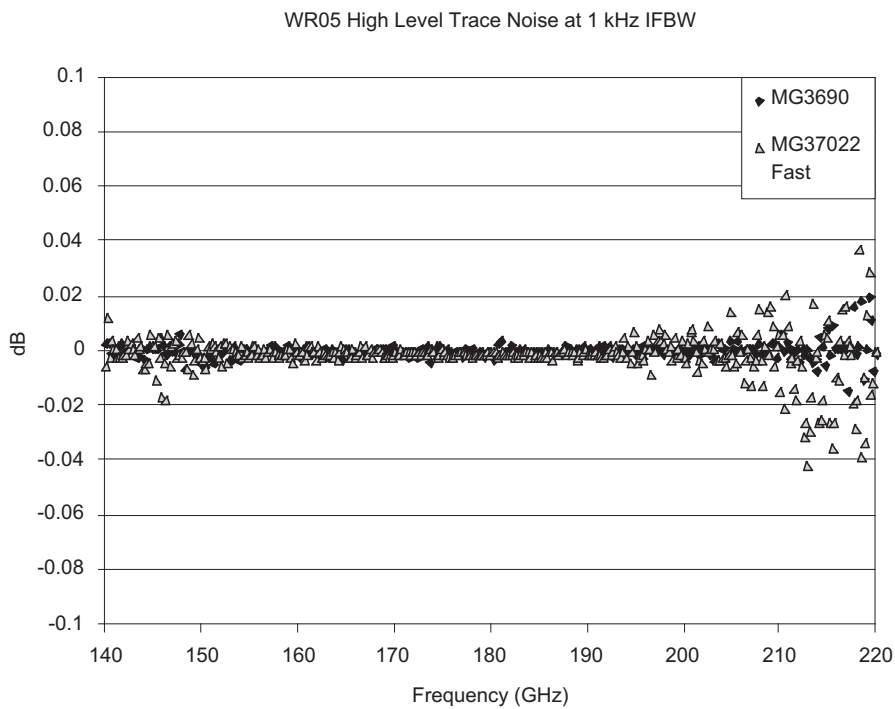

Figure 6. Trace noise of WR05 140-220 GHz millimeter-wave modules. Comparison between the MG3690B Signal Generator with Option 3 Ultra-low phase noise and MG37022A Fast Switching Microwave Signal Generator using TTL Fast Trigger Mode

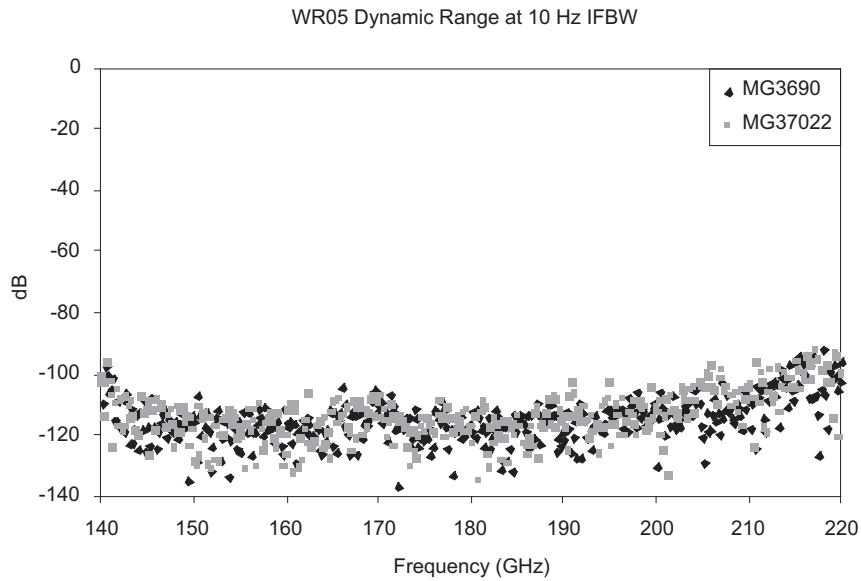

Figure 7. Dynamic range of WR05 140-220 GHz millimeter-wave modules. Comparison between the MG3690B Signal Generator with Option 3 Ultra-low phase noise and MG37022A Fast Switching Microwave Signal Generator using TTL Fast Trigger Mode.

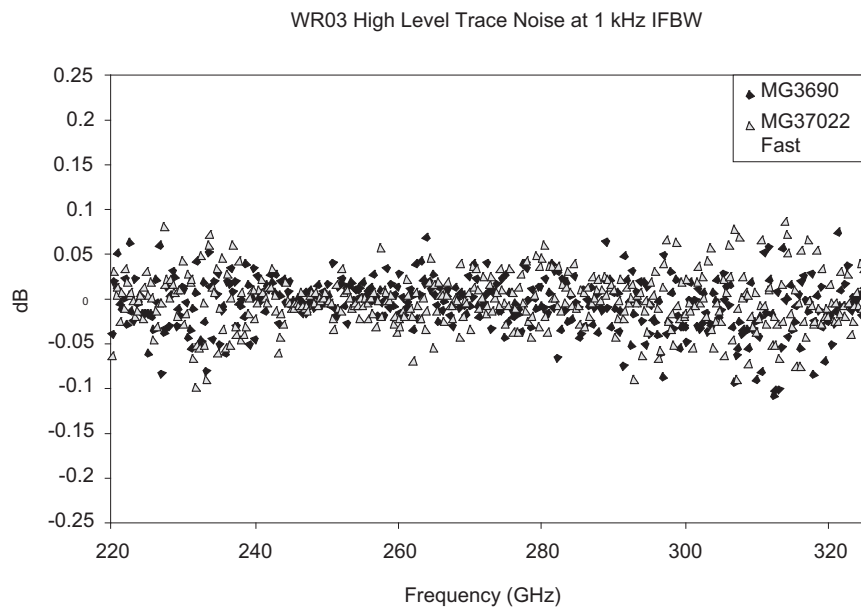

Figure 8. Trace noise of WR03 220-325 GHz millimeter-wave modules. Comparison between the MG3690B Signal Generator with Option 3 Ultra-low phase noise and MG37022A Fast Switching Microwave Signal Generator using TTL Fast Trigger Mode.

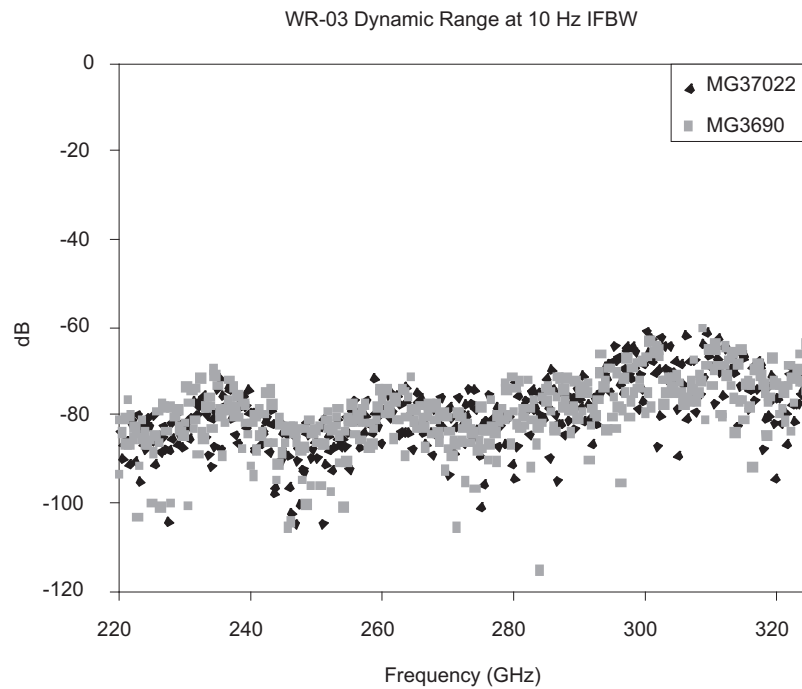

Figure 9. Dynamic range of WR03 220-325 GHz millimeter-wave modules. Comparison between the MG3690B Signal Generator with Option 3 Ultra-low phase noise and MG37022A Fast Switching Microwave Signal Generator using TTL Fast Trigger Mode.

5. Standard Capabilities for All Configurations

For standard capabilities, please use the MS4640A-series VNA data sheet 11410-00432, available at www.us.anritsu.com.

ME7828A Option 012 includes MS4640A 70 kHz option, Time Domain option, Source and Receiver attenuator option, and internal test set bias tees.

6. Calibration and Correction Capabilities

Calibration Methods	Short-Open-Load-Through (SOLT) with Fixed or Sliding Load Offset-Short Triple-Offset-Short Short-Open-Load-Reciprocal (SOLR) Reciprocal or Unknown Through Method Line-Reflect-Line (LRL) / Line-Reflect-Match (LRM) Advanced-LRM (A-LRM™) for improved on-wafer calibrations AutoCal (V connector, $\leq 70\text{ GHz}$)
Correction Models	Full 12-term 1 path / 2 port Frequency Response (Transmission or Reflection, one or both directions) Reflection Only (1 port or 2 ports)
Merged Calibration	Merge multiple calibration methods over bands of frequency points.
Calibration Standards' Coefficients	Load coefficients from your Anritsu cal kit's USB Memory stick Enter manual coefficients into User-Defined locations.
Reference Impedance	Modify the reference impedance from 50 Ω to any impedance but 0 Ω .
Interpolation	Allows interpolation between calibration frequency points, if selected.
Adapter Removal Calibration	Characterizes and "removes" an adapter used during calibration that will not be used for subsequent device measurements, for accurate measurement of non-insertable devices.
Dispersion Compensation	Selectable as Coaxial, other non-dispersive (e.g., for coplanar waveguide), Waveguide, or Microstrip.
Flat Power Calibrations and Linear Power Calibrations (Power Meter Correction)	Different power meter calibrations are available to enhance power accuracy at the desired reference plane (to usually ~ 0.1 dB for short periods of time). Flat power calibration up to 70 GHz using the appropriate W1 adapter is available. Power level is user-selectable when within the power adjustment range of the internal source. Other power levels are then arrived at by offset transfers. A linear power calibration is performed over a range of power levels for use in power sweep mode and is performed at a specified frequency or frequency range. Both calibrations are performed using an external power meter over the dedicated GPIB port or other suitable control ports.
Embedding/De-embedding	The MS4640A is equipped with an Embedding/De-embedding system. De-embedding is generally used for removal of test fixture contributions, modeled networks and other networks described by S-parameters (s2p files) from measurements. Similarly, the Embedding function can be used to simulate matching circuits for optimizing amplifier designs or simply adding effects of a known structure to a measurement. Multiple networks can be embedded/de-embedded and changing the port and network orientations is handled easily. An extraction utility is part of this package that allows the easier computation of de-embedding files based on some additional calibration steps and measurements.
Impedance Conversion	Allows entry of different impedances (complex values) for different ports.
Data Points	2 to 25,001 points, or 100,000 points in single channel

7. Mechanical Calibration/Verification Kits

W1 (1 mm) Calibration/Verification Kit, 3656B

Provides 12-term SOLT or Triple Offset Short calibrations, for W1 (1 mm) devices, and two verification standards.



3656A Cal Kit Contains:	Additional Information (typical)	Quantity	Part Number
Offset Short W1 (male)	Offset: 2.020 mm	1	23W50-1
Offset Short W1 (male)	Offset: 2.650 mm	1	23W50-2
Offset Short W1 (male)	Offset: 3.180 mm	1	23W50-5
Offset Short W1 (female)	Offset: 2.020 mm	1	23WF50-1
Offset Short W1 (female)	Offset: 2.650 mm	1	23WF50-2
Offset Short W1 (female)	Offset: 3.180 mm	1	23WF50-5
Open W1 (male)	Offset: 1.510 mm	1	24W50
Open W1 (female)	Offset: 1.930 mm	1	24WF50
Fixed Termination W1 (male)	Return Loss: 32 dB to 20 GHz, 30 dB to 67 GHz	1	28W50
Fixed Termination W1 (female)	Return Loss: 32 dB to 20 GHz, 30 dB to 67 GHz	1	28WF50
Adapter, W1 (male) to Fixed SC* Connector		1	33WSC50
Adapter, W1 (female) to Fixed SC* Connector		1	33WFSC50
Interchangeable Slider for SC* Connector (male)		1	
Interchangeable Slider for SC* Connector (female)		1	
Locking Keys for SC* Connectors		2	
Pin Exchange Tool for SC* Connectors	Contains 1 male pin	1	01-402
Adapter, W1 (male) to W1 (female)		1	33WWF50
Adapter, W1 (male) to W1 (male)		1	33WW50
Adapter, W1 (female) to W1 (female)		1	33WFWF50
Stepped Impedance ThruLine, W1 (male - female)	Verification Device	1	18WWF50-1B
50 Ω matched ThruLine, W1 (male - female)	Verification Device	1	18WWF50-1
Torque Wrench	6 mm, 5.4 N-cm (4 in-lbs)	1	01-504
Open-ended Wrench	6 mm / 7 mm	1	01-505
Coefficients for standards	On memory stick	1	-

* SC Connectors are a solution for accurate calibrations for non-insertable 1 mm devices. One can change the sex of the SC connector using the provided tool, pin, sliders, and locking keys to ensure the best pin-depth, thus valid calibrations after changing the sex of the adapter.

3655-series Waveguide Calibration Kits

The 3655-series calibration kit contains two Flush Shorts, two offsets, a 1/8 wavelength and a 3/8 wavelength, two Fixed Terminations, and two precision waveguide sections for a full 12-term Offset Short Calibration. The -1 cal kit adds a Sliding Load.

8. Test Port Cables

Test Port Cables, Flexible, High Performance

Description	Frequency Range	Impedance	Length (cm)	Insertion Loss (dB)	Return Loss (dB)	Part Number
W1 (1 mm) (male) to W1 (1 mm) (female)	DC to 110 GHz	50 Ω	10	1.74 (1.34)	≥ 14	3671W1-50-1
			13	2.23 (1.74)	≥ 14	3671W1-50-2
			16	2.74 (2.14)	≥ 14	3671W1-50-3



9. Precision Adapters, Attenuators, and more

Anritsu offers a complete line of precision adapters and attenuators. For more information, please visit our website at www.us.anritsu.com.



10. Warranty

The ME7828A series of VNAs and related accessories offer a 1 year warranty from the date of shipment. Please contact your local service center for additional warranty coverage. Note that the key component of the system, the MS4640A VNA, is covered by a 3-year standard warranty.

11. Ordering Information

ME7828A Broadband Network Analyzer

Part Number	Description	More Information
ME7828A	<p>ME7828A VNA, 10 MHz to 110 GHz</p> <p>Consists of:</p> <ul style="list-style-type: none"> • MS4647A, 10 MHz to 70 GHz VNA <ul style="list-style-type: none"> MS4647A-051, Direct Access Loops MS4640A-007, Receiver Offset Option MS4640A-001, Rack Mount Option • 3738A, Broadband Test Set • 3738A Option 002 ME7828A configuration • MG37022A, 2 to 20 GHz Synthesizer, 2 ea <ul style="list-style-type: none"> MG37022A-001, Rack Mount Option in each • 3742A-EW, WR-10 mmW modules, 2 ea • 66670-3, Combiner (left) With Bias Tee • 66671-3, Combiner (right) With Bias Tee • 806-206, V (male) to V (female) cable, 24", 2 ea • 806-207, V (male) to V (male) cable, 24", 2 ea • 3700C3, Console • ME7828A-SS020, On-Site System Assembly and Verification 	For Active Device Measurements
ME7828A Option 012	<p>VNA, 70 kHz to 110 GHz</p> <p>Consists of:</p> <ul style="list-style-type: none"> • MS4647A, 10 MHz to 70 GHz VNA <ul style="list-style-type: none"> MS4640A-002, Time Domain Option MS4647A-062, Active Meas. Suite, 4 atten., bias tees in test set, gain compression and efficiency measurement software MS4640A-007, Receiver Offset Option MS4640A-070, 70 kHz Frequency Coverage MS4640A-001, Rack Mount Option • 3738A, Broadband Test Set • 3738A Option 002, ME7828A configuration • MG37022A, 2 to 20 GHz Synthesizer, 2 ea <ul style="list-style-type: none"> MG37022A-001, Rack Mount Option in each • 3742A-EW, WR-10 mmW modules, 2 ea • 66670-3, Combiner (left) with Bias Tee • 66671-3, Combiner (right) with Bias Tee • 806-206, V (male) to V (female) cable, 24", 2 ea • 806-207, V (male) to V (male) cable, 24", 2 ea • 3700C3, Console • ME7828A-SS020, On-Site System Assembly and Verification 	For Active Device Measurements with source and receiver attenuators on Port1 and Port2 , gain compression and efficiency measurement software, and additional bias tees in the test set.

ME7828A Millimeter-Wave Network Analyzer

Millimeter Waveguide Bands must be ordered piece-wise using one of the following configurations.

Configurator for ME7828A Millimeter-Wave VNA, Waveguide Bands (order piece-wise).

Action	Part Number, Description	More Information	
Choose and order one of the three base VNAs, with the options listed	<ul style="list-style-type: none"> MS4642A, 10 MHz to 20 GHz VNA MS4642A-051, Direct Access Loops Option MS4640A-007, Receiver Offset Option MS4640A-001, Rack Mount Option 	Minimum Requirement	
	<ul style="list-style-type: none"> MS4644A, 10 MHz to 40 GHz VNA MS4644A-051, Direct Access Loops Option MS4640A-007, Receiver Offset Option MS4640A-001, Rack Mount Option 		
	<ul style="list-style-type: none"> MS4645A, 10 MHz to 50 GHz VNA MS4645A-051, Direct Access Loops Option MS4640A-007, Receiver Offset Option MS4640A-001, Rack Mount Option 		
	<ul style="list-style-type: none"> MS4647A, 10 MHz to 70 GHz VNA MS4647A-051, Direct Access Loops Option MS4640A-007, Receiver Offset Option MS4640A-001, Rack Mount Option 		
Add Options if desired, to the selected VNA	<ul style="list-style-type: none"> Substitute MS464xA-051 with either: MS464xA-061, Active Meas. Suite, 2 atten. or MS464xA-062, Active Meas. Suite, 4 atten. Add MS4640A-070 for 70 kHz coverage Add MS4640A-002 for Time Domain 		
Choose and order a pair of mmWave modules*	<ul style="list-style-type: none"> 3740A-V, 2 each 	V Band (WR-15) 50 to 75 GHz	Full 2-port Measurements
	<ul style="list-style-type: none"> 3740A-V 3741A-V 		Forward Measurements Only
	<ul style="list-style-type: none"> 3740A-E, 2 each 	E Band (WR-12) 60 to 90 GHz	Full 2-port Measurements
	<ul style="list-style-type: none"> 3740A-E 3741A-E 		Forward Measurements Only
	<ul style="list-style-type: none"> 3740A-EE, 2 each 	Extended-E Band (WR-12) 56 to 94 GHz	Full 2-port Measurements
	<ul style="list-style-type: none"> 3740A-EE 3741A-EE 		Forward Measurements Only
	<ul style="list-style-type: none"> 3740A-W, 2 each 	W Band (WR-10) 75 to 110 GHz	Full 2-port Measurements
	<ul style="list-style-type: none"> 3740A-W 3741A-W 		Forward Measurements Only
	<ul style="list-style-type: none"> 3740A-EW, 2 each 	Extended W Band (WR-10) 65 to 110 GHz	Full 2-port Measurements
	<ul style="list-style-type: none"> 3740A-EW 3741A-EW 		Forward Measurements Only
Order these Synthesizers with options	<ul style="list-style-type: none"> MG37022A, 2 to 20 GHz Synthesizer, 2 ea MG37022A-001 Option 01 Rack Mount Option, 2 ea 	Minimum Requirement. Add other options to the MG37022A as desired. Consult with Anritsu for higher frequency models..	
Order	<ul style="list-style-type: none"> 3738A, Broadband Test Set 3738A-002 Option ME7828A configuration 		
Order	<ul style="list-style-type: none"> 3700C3, Console 		

* More than one pair of modules could be ordered, sharing the same system.

Configurator for ME7828A Millimeter-Wave VNA, OML Waveguide Bands Above 110 GHz (order piece-wise)

Action	Part Number, Description		More Information
Choose and order one of the three base VNAs, with the options listed	<ul style="list-style-type: none"> MS4642A, 10 MHz to 20 GHz VNA MS4642A-051, Direct Access Loops Option MS4640A-007, Receiver Offset Option MS4640A-001, Rack Mount Option 		Minimum Requirement
	<ul style="list-style-type: none"> MS4644A, 10 MHz to 40 GHz VNA MS4644A-051, Direct Access Loops Option MS4640A-007, Receiver Offset Option MS4640A-001, Rack Mount Option 		
	<ul style="list-style-type: none"> MS4645A, 10 MHz to 50 GHz VNA MS4645A-051, Direct Access Loops Option MS4640A-007, Receiver Offset Option MS4640A-001, Rack Mount Option 		
	<ul style="list-style-type: none"> MS4647A, 10 MHz to 70 GHz VNA MS4647A-051, Direct Access Loops Option MS4640A-007, Receiver Offset Option MS4640A-001, Rack Mount Option 		
Add Options if desired, to the selected VNA	<ul style="list-style-type: none"> Substitute MS464xA-051 with either: MS464xA-061, Active Meas. Suite, 2 atten. or MS464xA-062, Active Meas. Suite, 4 atten. Add MS4640A-070 for 70 kHz coverage Add MS4640A-002 for Time Domain 		
Choose and order a pair of mmWave modules*	<ul style="list-style-type: none"> OML VXXVNA2-T/R, 2 ea 	Choose appropriate band	Full 2-port Measurements, order with Anritsu option.
	<ul style="list-style-type: none"> OML VXXVNA2-T/R, 1 ea OML VXXVNA2-T, 1 ea 	Choose appropriate band	Forward Measurements Only, order with Anritsu option.
Order these Synthesizers with options	<ul style="list-style-type: none"> MG37022A, 2 to 20 GHz Synthesizer, 2 ea MG37022A-001 Option 01 Rack Mount Option, 2 ea 		For frequency bands up to 325 GHz. Minimum Requirement. Add other options to the MG37022A as desired. Consult with Anritsu for higher frequency models.
	<ul style="list-style-type: none"> MG3692B 2 to 20 GHz Synthesizer, 2 ea MG3692B/1A Option 01 Rack Mount, 2 ea MG3692B/3 Option 03 Ultra Low Phase Noise 		For frequency bands above 325 GHz for optimum high level trace noise. Minimum Requirement. Add other options to the MG3690B as desired. Consult with Anritsu for higher frequency models.
Order	<ul style="list-style-type: none"> 3738A, Broadband Test Set 3738A-002 Option 002 ME7828A configuration 		
Order	<ul style="list-style-type: none"> 3700C3, Console 		

* More than one pair of modules could be ordered, sharing the same system.

mmW Modules

Part Number	Description	More Information
3740A-V	V Band (WR-15) mmW Module 50 to 75 GHz	Transmission/Reflection
3741A-V		Transmission
3740A-E	E Band (WR-12) mmW Module 60 to 90 GHz	Transmission/Reflection
3741A-E		Transmission
3740A-EE	Extended-E Band (WR-12) mmW Module 56 to 94 GHz	Transmission/Reflection
3741A-EE		Transmission
3740A-W	W Band (WR-10) mmW Module 75 to 110 GHz	Transmission/Reflection
3741A-W		Transmission
3740A-EW	Extended W Band (WR-10) mmW Module 65 to 110 GHz	Transmission/Reflection
3741A-EW		Transmission
3742A-EW		Transmission/Reflection, with Attenuator

Calibration/Verification Kits

Part Number	Description	More Information
3656B	W1 (1 mm) Calibration/Verification Kit	
3655V	WR-15 Waveguide Calibration Kit	Without Sliding Loads
3655V-1		With Sliding Loads
3655E	WR-12 Waveguide Calibration Kit	Without Sliding Loads
3655E-1		With Sliding Loads
3655W	WR-10 Waveguide Calibration Kit	Without Sliding Loads
3655W-1		With Sliding Loads
3650A	SMA/3.5 mm Calibration Kit	Without Sliding Loads
3650A-1		With Sliding Loads
3652A	K Calibration Kit	Without Sliding Loads
3652A-1		With Sliding Loads
3654D	V Calibration Kit	Without Sliding Loads
3654D-1		With Sliding Loads
3657	V Multi-Line Calibration Kit	Without Shorts
3657-1		With Shorts

Test Port Cables, Flexible, High Performance

Part Number	Description	More Information
3671W1-50-1	W1 (male) to W1 (female), 1 each	10.0 cm
3671W1-50-2		13.0 cm
3671W1-50-3		16.0 cm
3671S50-1	K (female) to 3.5 mm (male), 2 each	63.5 cm (25")
3671K50-1	K (female) to K (male), 2 each	63.5 cm (25")
3671K50-2	K (female) to K (male), 1 each	96.5 cm (38")
3671K50-3	K (female) to K (male), 1 each, and K (female) to K (female), 1 each	63.5 cm (25") 63.5 cm (25")
3671V50B-1	V (female) to V (male), 2 each	63.5 cm (25")
3671V50B-2	V (female) to V (male), 1 each	96.5 cm (38")

Power Meter and Sensor

Part Number	Description	More Information
ML2437A	Power Meter, Single Channel	For flat test port power calibration
SC7770	Thermal Sensor, with special characterization	70 kHz to 70 GHz, V (female)

Accessories

Part Number	Description	More Information
SC7662	Triax (male) to BNC (male) Cable (Inner-shield floating at BNC end)	1.5 m (2 needed per Kelvin Bias Tee)
2100-5	GPIB Cable	0.5 m
2100-1		1 m
2100-2		2 m
2100-4		4 m
01-201	Torque Wrench (for tightening male devices)	8 mm (5/16"), 0.9 N-m (8 in-lb) for SMA, 3.5 mm, 2.4 mm, K, and V
01-204	Wrench, Universal (circular, open-ended)	For SMA, 3.5 mm, 2.4 mm, K and V
01-203	Torque Wrench (for tightening the VNA test ports to female devices)	20.6 mm (13/16"), 0.9 N-m (8 in-lb)
806-206	Phase stable coaxial cables	V 1.85mm (M-F), 24"
806-207	Phase stable coaxial cables	V 1.85mm (M-M), 24"
806-210	Phase stable coaxial cables	V 1.85mm (M-F), 14"
806-211	Phase stable coaxial cables	V 1.85mm (M-M), 14"
806-209	Phase stable coaxial cables	V 1.85mm (M-F), 36"
806-208	Phase stable coaxial cables	V 1.85mm (M-M), 36"
34WV50	W1 (male) to V (male) Adapter	W1 (1 mm) to V, Coaxial
34WVF50	W1 (male) to V (female) Adapter	
34WV50	W1 (female) to V (male) Adapter	
34WV50	W1 (female) to V (female) Adapter	
33WW50	W1 (male) to W1 (male) Adapter	W1 (1 mm) in-series, Coaxial
33WWF50	W1 (male) to W1 (female) Adapter	
33WFW50	W1 (female) to W1 (female) Adapter	
35WR10W	WR10 to W1 (male) Adapter	W1 (1mm) to WR10 Waveguide
35WR10WF	WR10 to W1 (female) Adapter	
SC7260	WR12 to W1 (male) Adapter	W1 (1 mm) to WR12 Waveguide
SC7442	WR12 to W1 (female) Adapter	
35WR15V	WR15 to V (male) Adapter	V (1.85mm) to WR15 Waveguide
35WR15VF	WR15 to V (female) Adapter	
70556 Replaces 806-206 and 806-207 24" cables with 806-208 806-209 36" cables		
70555 Cable set for SUSS MicroTec SIGMA integration. Replaces 806-206 and 806-207 24" cables with 806-210 806-211 14" cables. Replaces RF and LO ruggidized semi-rigid cables with 806-121 36" flex cables.		
Refer to our extensive Precision RF & Microwave Components Catalog, 11410-00235, for more adapters, etc.		

Anritsu

Anritsu Corporation

5-1-1 Onna, Atsugi-shi, Kanagawa, 243-8555 Japan
Phone: +81-46-223-1111
Fax: +81-46-296-1264

• U.S.A.

Anritsu Company

1155 East Collins Boulevard, Suite 100,
Richardson, Texas 75081 U.S.A.
Toll Free: 1-800-ANRITSU (267-4878)
Phone: +1-972-644-1777
Fax: +1-972-671-1877

• Canada

Anritsu Electronics Ltd.

700 Silver Seven Road, Suite 120, Kanata,
Ontario K2V 1C3, Canada
Phone: +1-613-591-2003
Fax: +1-613-591-1006

• Brazil

Anritsu Eletrônica Ltda.

Praca Amadeu Amaral, 27-1 Andar
01327-010 - Paraisópolis, São Paulo, Brazil
Phone: +55-11-3283-2511
Fax: +55-11-3886940

• Mexico

Anritsu Company, S.A. de C.V.

Av. Ejército Nacional No. 579 Piso 9, Col. Granada
11520 México, D.F., México
Phone: +52-55-1101-2370
Fax: +52-55-5254-3147

• U.K.

Anritsu EMEA Ltd.

200 Capability Green, Luton, Bedfordshire LU1 3LU, U.K.
Phone: +44-1582-433200
Fax: +44-1582-731303

• France

Anritsu S.A.

16/18 Avenue du Québec-SILIC 720
91961 COURTABOEUF CEDEX, France
Phone: +33-1-60-92-15-50
Fax: +33-1-64-46-10-65

• Germany

Anritsu GmbH

Nemetschek Haus, Konrad-Zuse-Platz 1
81829 München, Germany
Phone: +49 (0) 89 442308-0
Fax: +49 (0) 89 442308-55

• Italy

Anritsu S.p.A.

Via Elio Vittorini, 129, 00144 Roma, Italy
Phone: +39-06-509-9711
Fax: +39-06-502-2425

• Sweden

Anritsu AB

Borgafjordsgatan 13, 164 40 Kista, Sweden
Phone: +46-8-534-707-00
Fax: +46-8-534-707-30

• Finland

Anritsu AB

Teknobulevardi 3-5, FI-01530 Vantaa, Finland
Phone: +358-20-741-8100
Fax: +358-20-741-8111

• Denmark

Anritsu A/S

Kirkebjerg Allé 90 DK-2605 Brøndby, Denmark
Phone: +45-72112200
Fax: +45-72112210

• Spain

Anritsu EMEA Ltd.

Oficina de Representación en España

Edificio Veganova
Avda de la Vega, nº 1 (edf 8, pl1, of 8)
28108 ALCOBENDAS - Madrid, Spain
Phone: +34-914905761
Fax: +34-914905762

• Russia

Anritsu EMEA Ltd.

Representation Office in Russia

Tverskaya str. 16/2, bld. 1, 7th floor.
Russia, 125009, Moscow
Phone: +7-495-363-1694
Fax: +7-495-935-8962

• United Arab Emirates

Anritsu EMEA Ltd.

Dubai Liaison Office

P O Box 500413 - Dubai Internet City
Al Thuraya Building, Tower 1, Suite 701, 7th Floor
Dubai, United Arab Emirates
Phone: +971-4-3670352
Fax: +971-4-3688460

• Singapore

Anritsu Pte. Ltd.

60 Alexandra Terrace, #02-08, The Comtech (Lobby A)
Singapore 118502
Phone: +65-6282-2400
Fax: +65-6282-2533

• India

Anritsu Pte. Ltd.

India Branch Office

3rd Floor, Shri Lakshminarayan Niwas,
#2726, 80 ft Road, HAL 3rd Stage, Bangalore - 560 075, India
Phone: +91-80-4058-1300
Fax: +91-80-4058-1301

• P. R. China (Hong Kong)

Anritsu Company Ltd.

Units 4 & 5, 28th Floor, Greenfield Tower, Concordia Plaza,
No. 1 Science Museum Road, Tsim Sha Tsui East,
Kowloon, Hong Kong, P.R. China
Phone: +852-2301-4980
Fax: +852-2301-3545

• P. R. China (Beijing)

Anritsu Company Ltd.

Beijing Representative Office

Room 1515, Beijing Fortune Building,
No. 5, Dong-San-Huan Bei Road,
Chao-Yang District, Beijing 100004, P.R. China
Phone: +86-10-6590-9230
Fax: +86-10-6590-9235

• Korea

Anritsu Corporation, Ltd.

8F Hyunjuk Bldg, 832-41, Yeoksam-Dong,
Kangnam-ku, Seoul, 135-080, Korea
Phone: +82-2-553-6603
Fax: +82-2-553-6604

• Australia

Anritsu Pty Ltd.

Unit 21/270 Ferntree Gully Road, Notting Hill
Victoria, 3168, Australia
Phone: +61-3-9558-8177
Fax: +61-3-9558-8255

• Taiwan

Anritsu Company Inc.

7F, No. 316, Sec. 1, Neihu Rd., Taipei 114, Taiwan
Phone: +886-2-8751-1816
Fax: +886-2-8751-1817

