



Ultraflo U1000

T&D THORNE & DERRICK UK

Tel: +44 (0)191 490 1547

Fax: +44 (0)191 477 5371

Email: northernsales@thorneandderrick.co.uk

Website: www.heatracing.co.uk

www.thorneandderrick.co.uk

The new alternative to cutting pipes and mechanical meters from Micronics, for simple, low cost flow measurement from outside the pipe!

The U1000 is an ultrasonic permanent/fixed clamp-on flow metering solution for measuring flow rate – with a volume pulse output and optional 4-20mA flow rate signal, which can be used as a stand alone meter or as an integral part of an aM&T or BEM's system.

Simple to install – clamp-on to the pipe, connect power and enter the pipe diameter, no specialist skills or tools required!

A cost effective alternative to traditional in-line meter installation, plus dry servicing, providing minimum downtime and maximum availability!

Compact, rugged and reliable, the U1000 has been designed to provide sustained performance in industrial environments.

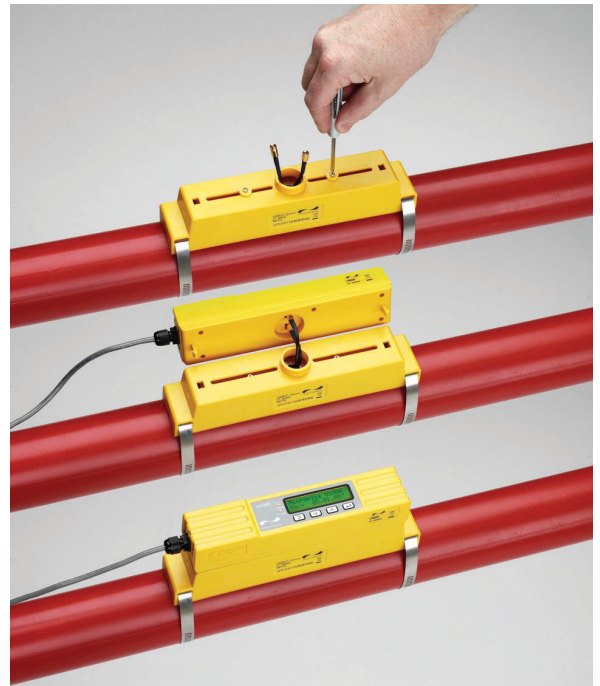

- Metered liquid flow rate and volume
- Easy to install
- Clamp-on sensors
- Lower installed cost than in-line meters

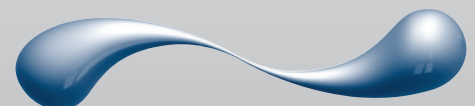

micronics
Through measurement comes control



INDUSTRIES:

- Building Services
- Energy Management
- Water Treatment
- Chemical
- Pharmaceutical
- Petrochemical
- Food

RECOMMENDED FOR:

- Hot water < 85°C
- Chilled water
- Potable water
- Demineralised water

APPLICATION/USE:

- Hot water metering and flow measurement
- Flow measurement for heat metering
- Chilled water metering and flow measurement
- Flow measurement for chilled water energy metering
- Potable water metering and flow measurement
- Process water metering and flow measurement
- Ultrapure water measurement

PIPE MATERIALS:

- Steel
- Plastic
- Copper

U1000 - Permanent Ultrasonic Liquid Flow Meter



U1000 Specification

Accuracy: +/-1-3% of flow reading for >0.3m/s

Flow Velocity Range: 0.1 to 10m/s

Pipe Range: 25mm OD - 115mm OD

Water Temp Range: 0°C to 85°C

Flow Rate Output: Optional 4-20mA

Volume Output: Pulse or Frequency

Outputs preset to default condition based on Pipe Nominal Bore

External Power Supply: 12V-24V +/- 10% AC/DC at 7 watts

Electronics Enclosure: IP54

Input/Output Cable: 5m x 6 core for power in and data out

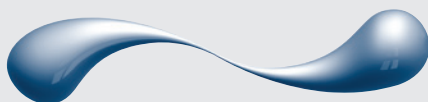

micronics
Through measurement comes control

U1000 - Permanent Ultrasonic Liquid Flow Meter

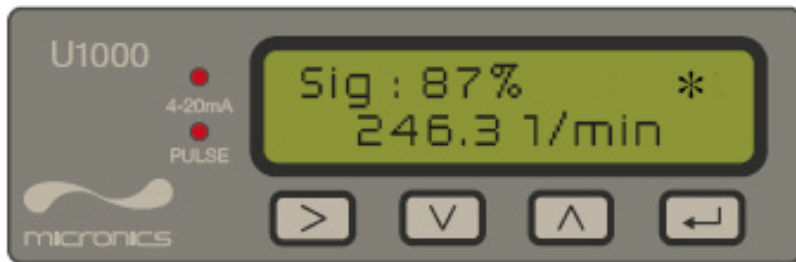

U1000 Flow Reading Screen

U1000 Product Features and Benefits

- Factory configured for pipe size – minimal site configuration
- Simplified guide rail & sensor assembly – simple installation
- Clamp-on – non-invasive & low install cost
- LCD with backlight – install & service information
- Integral pulse and optional 4-20mA outputs – aM&T & BEM's compatible
- Metal, plastic and copper pipes

Simple steps for locating U1000 on pipe



Guide rail and sensor assembly showing grease applied



Clamp guide rail and sensor assembly to pipe and release sensor locking screws



Connect power and sensors to electronic assembly



Click electronic assembly onto guide rail and sensor assembly

HOW DOES IT WORK?

The Ultraflo is a transit time ultrasonic flow meter designed to work with clamp-on transducers, to provide accurate measurement of liquid flowing within a closed pipe, without the need for any mechanical parts to be inserted through the pipe wall or to protrude into the flow system. It takes just a few minutes to install and there is no need to shut down flow or drain the system!

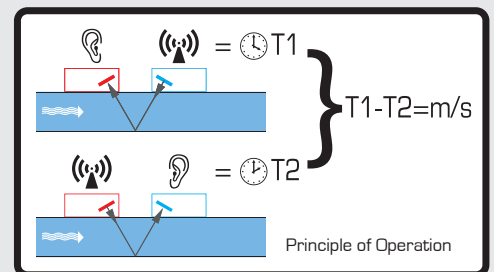

When ultrasound is transmitted between the transducers, the speed at which the sound travels through the liquid is accelerated slightly by the velocity of the liquid through the pipe. When ultrasound is transmitted in the opposite direction, the flow of the liquid causes the transmitted sound to decelerate. The subsequent time difference is directly proportional to the flow velocity in the pipe. Having measured the flow velocity and knowing the pipe cross-sectional area, the volumetric flow can be easily calculated.

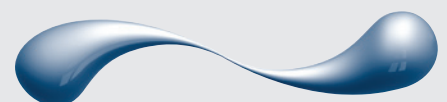



Power on configuration:



U1000 dimensions:

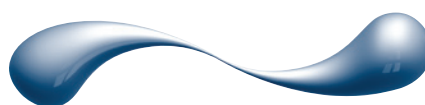
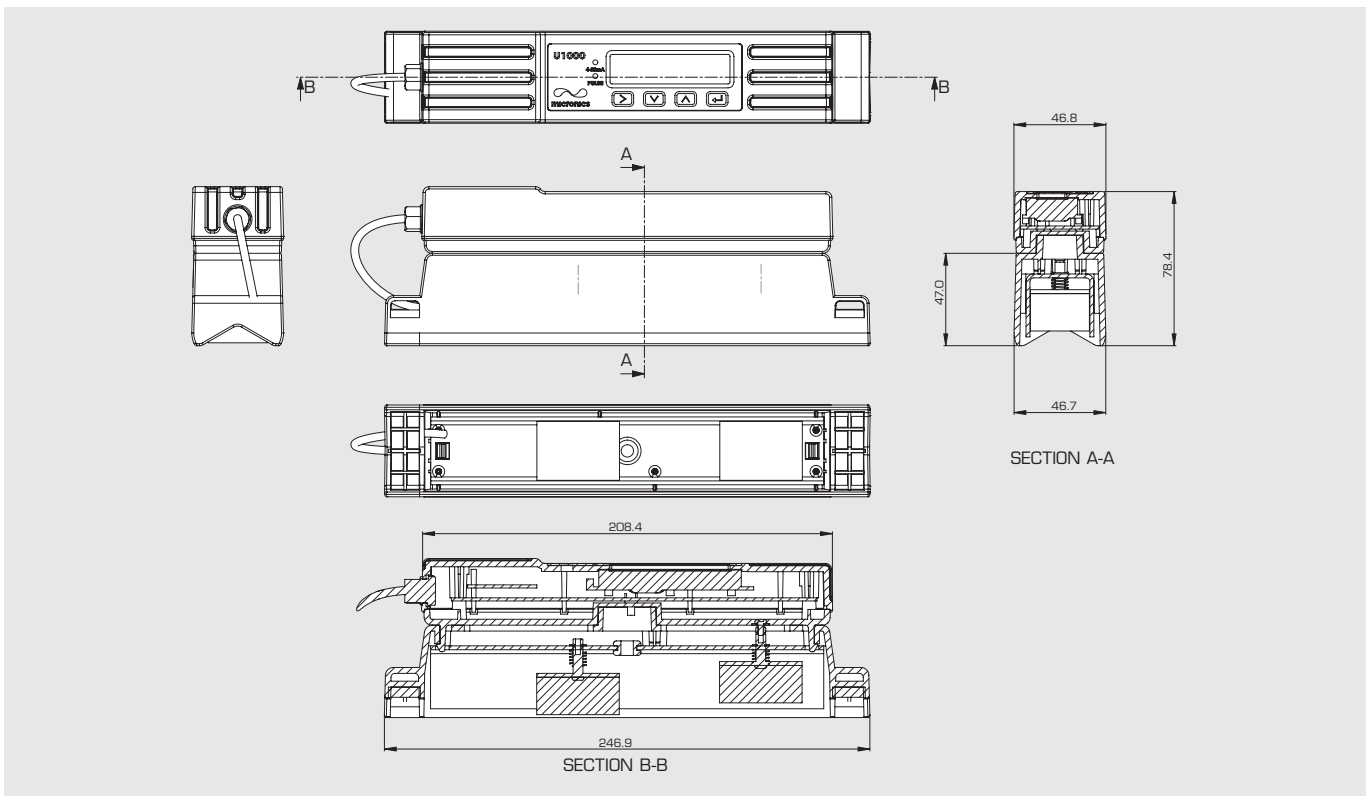

micronics
Through measurement comes control