

Fontini
TURN ON. BE DIFFERENT

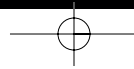
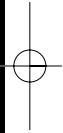
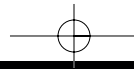

EL GESTO DE ENCENDER LA LUZ SIEMPRE HA TENIDO ALGO MÁGICO. PARA FONTINI SIGNIFICA IMAGINAR NUEVAS FORMAS, EMPLEAR NUEVOS MATERIALES E INCORPORAR SOLUCIONES TÉCNICAS AVANZADAS. UN PROCESO SIEMPRE PERMEABLE A LAS NUEVAS TENDENCIAS DE LA ARQUITECTURA, LA CONSTRUCCIÓN Y EL INTERIORISMO. 50 AÑOS DE TRABAJO DE CREACIÓN, DESARROLLO, PRODUCCIÓN Y CONTROL DE CALIDAD. FONTINI ES ARTE Y TECNOLOGÍA, ES ANTE TODO, EL AFÁN POR LOGRAR QUE EL SIMPLE GESTO DE DAR LA LUZ SIGA ENCENDIENDO EMOCIONES.

THE GESTURE OF SWITCHING THE LIGHT HAS ALWAYS HAD SOMETHING MAGIC. FOR FONTINI IT MEANS IMAGINING NEW SHAPES, USING NEW MATERIALS AND ADDING NEW ADVANCED TECHNICAL SOLUTIONS. A PROCESS ALWAYS PERMEABLE TO THE NEW TRENDS OF ARCHITECTURE, CONSTRUCTION AND INTERIOR DESIGN. 50 YEARS OF WORK ON THE CREATION, DEVELOPMENT, PRODUCTION AND QUALITY PRODUCTS. FONTINI IS ART AND TECHNOLOGY, IT IS ABOVE ALL, THE AIM TO ACHIEVE THAT THE SIMPLE GESTURE OF TURNING THE LIGHT STILL LIGHTS EMOTIONS.

LE GESTE D'ALLUMER AVAIT TOUJOURS QUELQUE CHOSE DE MAGIQUE. POUR FONTINI IL SIGNIFIE IMAGINER DES NOUVELLES FORMES, UTILISER DES NOUVEAUX MATERIAUX ET INCORPORER DES SOLUTIONS TECHNIQUES AVANCEES. UN PROCES TOUJOURS PERMEABLE AUX NOUVELLES TENDANCES DE L'ARCHITECTURE, LA CONSTRUCTION ET LE DESIGN D'INTERIEURS. 50 ANS DE TRAVAIL DE CREATION, DEVELOPPEMENT, PRODUCTION ET CONTROLE DE QUALITE. FONTINI EST ART ET TECHNOLOGIE. C'EST AVANT TOUT, LE DESIR POUR REUSSIR QUE LE SIMPLE GESTE D'ALLUMER CONTINUES ALLUMANT DES EMOTIONS.

EN FONTINI NOS IDENTIFICAMOS CON NUESTROS PRODUCTOS. CREEMOS QUE SU DESARROLLO, PRODUCCIÓN Y CONTROL DE CALIDAD, SÓLO DEBEN PASAR POR NUESTRAS MANOS. NOS VALEMOS IGUAL DE LAS ÚLTIMAS TECNOLOGÍAS, QUE DE NUESTROS 50 AÑOS DE TRADICIÓN FAMILIAR. ASIMILAMOS NUEVAS TENDENCIAS EN ARQUITECTURA E INTERIORISMO SIN OLVIDAR LA GRAN RIQUEZA DE LA TRADICIÓN DE LA QUE SOMOS DEPOSITARIOS. LLEGAMOS A NUEVOS MERCADOS DESDE EL CONOCIMIENTO PROFUNDO DEL PROPIO. EN FONTINI DEFENDEMOS EL ESPÍRITU ARTESANAL COMO EL MEJOR MODO DE MANTENER EL COMPROMISO CON NOSOTROS MISMOS Y CON NUESTROS CLIENTES. POR ESO NUESTRA EMPRESA PREFERE CRECER EN VALORES COMO LA EXCLUSIVIDAD DE NUESTROS PRODUCTOS, LA FLEXIBILIDAD CON LOS DISTRIBUIDORES Y LA PROXIMIDAD CON LOS CLIENTES. FONTINI MÁS CERCA, MÁS FÁCIL Y MÁS RÁPIDO.

www.fontini.com: una herramienta para arquitectos, interioristas y distribuidores. Con el objetivo de simplificarle el trabajo, Fontini ha desarrollado un completo simulador online en el que puede realizar infinitas combinaciones: elija el estilo, el modelo, los acabados, los materiales y la superficie en la que se instalará su interruptor. Conéctese y encontrará la solución exclusiva que necesita.

Servicio Express 24h: Y en caso de urgencia, Fontini le garantiza una entrega inmediata de su pedido. Llame al teléfono de atención al profesional y consulte condiciones: 902.120.103

AT FONTINI WE IDENTIFY OURSELVES WITH OUR PRODUCTS. WE BELIEVE THAT ITS DEVELOPMENT, PRODUCTION AND QUALITY CONTROL SHOULD ONLY STAY IN OUR HANDS. WE TAKE ADVANTAGE FROM THE LATEST TECHNOLOGIES AS WELL AS FROM OUR 50 YEARS OF FAMILY TRADITION. WE ASSIMILATE NEW TRENDS OF ARCHITECTURE AND INTERIOR DESIGN NOT FORGETTING THE RICHNESS OF THE TRADITIONS WE HAVE INHERITED. WE REACH NEW MARKETS FROM THE DEEP KNOWLEDGE OF OURS. IN FONTINI WE DEFEND THE HANDCRAFT SPIRIT AS THE BEST WAY TO KEEP THE COMMITMENT WITH OURSELVES AND WITH OUR CUSTOMERS. FOR THIS REASON OUR COMPANY PREFERS GROWING IN VALUES LIKE EXCLUSIVITY OF OUR PRODUCTS, FLEXIBILITY WITH OUR DISTRIBUTORS AND PROXIMITY WITH OUR CLIENTS. FONTINI CLOSER, EASIER AND FASTER.

www.fontini.com: a tool for architects, interior designers and distributors. With the aim of simplifying your job, Fontini has developed a complete online simulator where you can make thousands of combinations. Choose your style, model, finishes, materials and the surface where you will install your switch. Get connected and you will find the exclusive solution you need.

www.fontini.com

LES CRÉATIONS FONTINI SE DÉMARQUENT PAR LA QUALITÉ ET LA PRÉCISION DE NOS MÉCANISMES ET L'UTILISATION DE MATÉRIEAUX NOBLES (PORCELAINE, VERRE, LAITON, INOX, BOIS). NOUS GÉERONS DANS SA TOTALITÉ CHACUNE DES ÉTAPES DE NOS FABRICATIONS (DÉVELOPPEMENT, PRODUCTION, CONTRÔLE DE QUALITÉ). NOUS AVONS SU CONJUGUER LES DERNIÈRES TECHNOLOGIES ET NOTRE SAVOIR FAIRE DE 50 ANS DE TRADITION. CHAQUE JOYAU FONTINI ALLIE LES NOUVELLES TENDANCES EN ARCHITECTURE D'INTÉRIEURE ET LA RICHESSE DES TRADITIONS DONT NOUS SOMMES LE GARANT. LE RAFFINEMENT DE NOS DIFFÉRENTES COLLECTIONS (STYLE, BOURGEOIS, CHAMPÊTRE, MINIMALISTE) S'ADAPTE DE TOUTE ÉVIDENCE AUX BESOINS DE CHACUN. BIEN QU'À LA POINTE DES TECHNOLOGIES NOUVELLES, CHEZ FONTINI, NOUS DÉFENDONS L'ESPRIT ARTISANAL QUI GARANTIT UNE GRANDE FLEXIBILITÉ, NOUS PERMETTANT AINSI DE RÉPONDRE À DES DEMANDES PERSONNALISÉES. FONTINI PLUS PRÈS, PLUS FACILE ET PLUS RAPIDE.

www.fontini.com: un outil pour les architectes, pour les décorateurs d'intérieurs et pour nos distributeurs. Avec pour objectif de faciliter le travail, FONTINI a développé un simulateur complet en ligne, dans lequel vous pouvez créer une infinité de combinaisons : Choisissez le style, le modèle, les finitions, les matériaux et la surface sur laquelle vous installerez votre interrupteur. Connectez vous et créez votre style exclusif !...

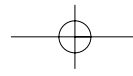

COLLECTIONS//MINIMAL

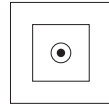
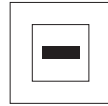

RURAL

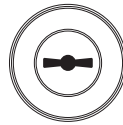

PROVENÇAL

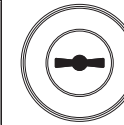
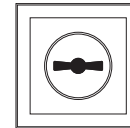

CLASSICAL

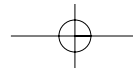
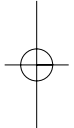
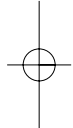
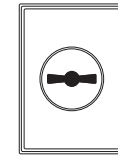

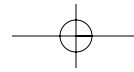

P.09 F-37 COLLECTION
P.25 DIMBLER COLLECTION
P.31 GARBY COLLECTION
P.43 GARBY COLONIAL COLLECTION
P.55 VENEZIA COLLECTION
P.77 PULSADORES/ PUSHBUTTONS
P.80 SONIDO FONTINI
P.83 INFORMACIÓN TÉCNICA/ TECHNICAL INFORMATION

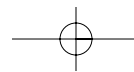
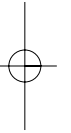
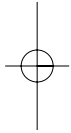

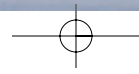
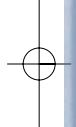
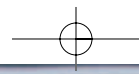

Collection

F-37 Rocking & Rotary Switches







Collection F-37 Rocking switches

Instalación empotrada

- Mecanismos de 10AX - 250V~
- Construida con termoplásticos técnicos
- Contactos de plata de alto poder de ruptura
- Combinable con marcos y accesorios F-37
- Manecillas y accesorios de latón cromado
- Bastidores enlazables
- Instalación en caja universal con tornillos

Fitting installation

- 10AX - 250V~ mechanisms
- Manufactured with technical thermoplastic materials
- Combinable with F-37 frames and accessories
- Knobs and accessories made of chrome-plated brass
- Silver contacts with high breaking power
- Joinable chassis
- Installation in standard box with screws

Installation encastrée

- Mécanismes de 10AX - 250V~
- Fabriquée à partir de thermoplastiques techniques
- Contacts d'argent d'haute pouvoir de rupture
- Combinable avec cadres et accessoires F-37
- Manettes de laiton chromé
- Châssis joignable
- Installation en boîte standard avec vis

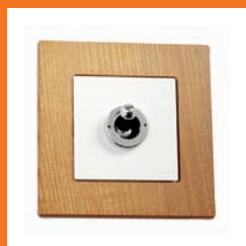

02//
Cerezo
Merisier
Cerry wood



03//
Tabaco
Tobacco
Tabac



07//
Vidrio Azul reflex
Blue Reflex glass
Verre Bleu



66//
Vidrio translúcido
Translucent glass
Verre transparent

Collection F-37 Rotary Switches

Instalación empotrada

- Mecanismos de 10AX - 250V~
- Bases de enchufe de 16A - 250V~
- Construida con termoplásticos técnicos
- Marcos de cristal fundido translúcido o Azul Reflex
- Fondos de color intercambiables
- Marcos de madera maciza de fresno
- 3 acabados de madera· Lazos de acero inoxidable
- Contactos de plata de alto poder de ruptura
- Marcos para instalar en posición vertical u horizontal
- Bastidores enlazables
- Instalación en caja universal con tornillos
- Producto certificado

Fitting installation

- 10AX - 250V~ mechanisms
- 16A - 250V~ sockets
- Manufactured with technical thermoplastic materials
- Frames of foundry glass, translucent and Reflex Blue
- Exchangeable background colours
- Frames of massif ash tree
- 3 wood finishes
- Stainless steel keys
- Silver contacts with high breaking power
- Frames for vertical or horizontal installation
- Joinable chassis
- Installation in standard box with screws
- Certified product

Installation encastrée

- Mécanismes de 10AX - 250V~
- Prises de courant de 16A - 250V~
- Fabriquée à partir de thermoplastiques techniques
- Cadres verre pressé translucide et Bleu Reflex
- Fonds de couleur interchangeable
- Cadres en bois massif du frêne
- 3 finitions du bois
- Boutons papillon d'acier inoxydable
- Contacts d'argent d'haute puissance de rupture
- Cadres pour installation verticale ou horizontale
- Châssis joignable
- Installation en boîte standard avec vis
- Produit certifié



66//
Blanco
White
Blanc



66//
Verde Manzana
Apple Green
Vert pomme



07//
Marco Azul Reflex
Reflex Blue Frame
Bleu Reflex



02//
Cerezo
Cherry Wood
Merisier



04//
Wengé
Wenge
Wengé



03//
Tabaco
Tobacco
Tabac

Collection
F-37 Rocking Switches



Interruptor unipolar 10AX - 250V~
One pole switch 10AX - 250V~
Interrupteur unipolaire 10AX-250V~

Serie
Set Série

Código
Code Cod

Acabado
Finish Finition

Embalaje
Packaging Emballage

67

306

25
51

ref. 2

Conmutador 10AX - 250V~
Two-way switch 10AX - 250V~
Va-et-vient 10AX-250V~

67

308

25
51

ref. 2

Cruzamiento 10AX - 250V~
Crossing switch 10AX - 250V~
Permutateur 10AX-250V~

67

304

25
51

ref. 2

Interruptor bipolar 10AX - 250V~
Two pole switch 10AX - 250V~
Interrupteur bipolaire 10AX-250V~

67

314

25
51

ref. 2

1 Unidad Unit Unité



Doble interruptor 10AX - 250V~
Double switch 10AX - 250V~
Double interrupteur unipolaire 10AX-250V~

67

300

25
51

ref. 2

Doble conmutador 10AX - 250V~
Double two-way switch 10AX - 250V~
Double va-et-vient 10AX-250V~

67

302

25
51

ref. 2

1 Unidad Unit Unité

www.fontini-lux.ru



Pulsador 10A - 250V~ 24V DC
Pushbutton 10A - 250V~ 24V DC
Bouton poussoir 10A-250V~ - 24V DC

ref. 2

1 Unidad Unit Unité



Doble pulsador 10A - 250V~ 24V DC
Double pushbutton 10A - 250V~ 24V DC
Double bouton poussoir 10A-250V~ - 24V DC

67

343

25
51

ref. 2

1 Unidad Unit Unité

ACABADO FINISH FINITION



25.
Blanco/Cromado
White/Chrome Plated
Blanc/Chromé



51.
Metalizado/Cromado
Metallic/Chrome Plated
Metalisé/chomé

		Serie Set Série	Código Code Cod	Acabado Finish Finition	Embalaje Packaging Emballage	
	Regulador conmutador potencia 40-500W (incandescencia y halógenas) Dimmer two-way switch power 40-500W (for incandescence and halogen bulbs) Variateur - va-et-vient Puissance 40-500W (incandescent et halogène)	67	332	25 51	ref. 2 	
						1 Unidad Unit Unité
	Regulador para motores 6A-250V~ Dimmer for motors 6A-250V~ Variateur pour moteurs 6A-250V~	67	331	25 51	ref. 2 	
						1 Unidad Unit Unité
	Potenciómetro regulador de volumen Potentiometer for volume regulation Potentiomètre pour réglage du volume				.2 	Ver información técnica en página 94. See technical information on page 94. Voir information technique sur page 94.
						1 Unidad Unit Unité
						Mecanismos combinables con los marcos y accesorios F-37 Mechanisms are combinable with F-37 frames and accessories Mécanismes combinables avec les cadres et accessoires F-37

www.fontini-lux.ru

Collection
F-37



Interrupción unipolar 10AX - 250V~
One pole switch 10AX - 250V~
Interrupteur unipolaire 10AX-250V~

Serie
Set Série

Código
Code Cod

Acabado
Finish Finition

Embalaje
Packaging Emballage

37

306

25
51

ref. 2

Conmutador 10AX - 250V~
Two-way switch 10AX - 250V~
Va-et-vient 10AX-250V~

37

308

25
51

ref. 2

Cruzamiento 10AX - 250V~
Crossing switch 10AX - 250V~
Permutateur 10AX-250V~

37

304

25
51

ref. 2

Interrupción bipolar 10AX - 250V~
Two pole switch 10AX - 250V~
Interrupteur bipolaire 10AX-250V~

37

314

25
51

ref. 2

1 Unidad Unit Unité



Doble interrupción 10AX - 250V~
Double switch 10AX - 250V~
Double interrupteur unipolaire 10AX-250V~

37

300

25
51

ref. 2

Doble conmutador 10AX - 250V~
Double two-way switch 10AX - 250V~
Double va-et-vient 10AX-250V~

37

302

25
51

ref. 2

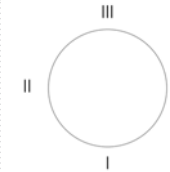

0 Circuitos cerrados
I Circuito A abierto
II Circuito A y B abierto
III Circuito A cerrado y B abierto
0 Both circuits Off
I A circuit On
II Both circuits On
III B circuit On, A Off
0 Circuits fermés
I Circuit A ouvert
II Circuits A et B ouverts
III Circuit B ouvert, A fermé

302
La posición 0 varía según la posición del otro conmutador
Position 0 depends on the position of the other two-way switch
La position 0 varie selon la position de l'autre va-et-vient

1 Unidad Unit Unité

www.fontini-lux.ru



Pulsador 10A - 250V~ 24V DC
Pushbutton 10A - 250V~ 24V DC
Bouton poussoir 10A-250V~ - 24V DC

25

ref. 2

1 Unidad Unit Unité



Doble pulsador 10A - 250V~ 24V DC
Double pushbutton 10A - 250V~ 24V DC
Double bouton poussoir 10A-250V~ - 24V DC

37

343

25
51

ref. 2

1 Unidad Unit Unité

ACABADO FINISH FINITION



25.
Blanco/acero inox
White/stainless steel
Blanc / acier inoxydable



51.
Metalizado/acero inox
Metallic/stainless steel
Métallisé / acier inoxydable

		Serie Set Série	Código Code Cod	Acabado Finish Finition	Embalaje Packaging Emballage	
	Mecanismo para persianas 10A - 250V~ para motores 1'66A Electric blinds mechanism 10A - 250V~ for 1'66 A motors Mécanisme pour volets roulants 10A-250V~ Pour moteurs 1,66A	37	342	25 51	ref. 2 	1 Unidad Unit Unité
	Mecanismo para tarjetas con indicador luminoso Mechanism for cards with luminous indicator Mécanisme pour cartes avec indicateur lumineux	37	935	05 50	ref. 2 	Se recomienda la instalación con relés Installation with relays is recommended L'installation avec relais est recommandée
	Interrupor-Conmutador 1 Microrruptor 6A-250V~ Switch two way switch 1 micro 6A-250V~ Interrupteur - va-et-vient 1 microrrupteur 6A-250V	37	936	05 50	ref. 2 	
	Base de enchufe 16A - 250V~ con obturadores de seguridad Socket outlet 2 pole without earth 16A - 250V~ with shutters Prise de courant 16A - 250V~ avec obturateurs de sécurité	37	209	05 50	ref. 2 	Sólo reposición Only for replacement Uniquement pour remplacement
	Base TT lateral con obturadores de seguridad 16A - 250V~ German 2 pole socket with Earth 16A -250V~ with shutters Prise de courant 16A - 250V~ avec contact de terre schuko et obturateurs de sécurité	37	212	05 50	ref. 2 	1 Unidad Unit Unité

www.fontini-lux.ru

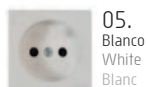

05.
Blanco
White
Blanc



50.
Metalizado
Metallic
Métallisé

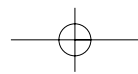

Collection
F-37

		Serie Set Série	Código Code Cod	Acabado Finish Finition	Embalaje Packaging Emballage		
	Base TT sistema francés 16A - 250V~ con obturadores de seguridad French 2 pole socket with earth pin 16A - 250V~ with shutters Prise de courant 16A-250V~ avec terre français et obturateurs de sécurité	37	208	05 50	ref. 2		
						1 Unidad Unit Unité	
	Doble toma teléfono Double telephone socket Double prise de téléphone	4-6 vías 4-6 ways 4-6 voies	37	706	05 50	ref. 2	1 línea y 2 salidas. Posibilidad de 2 líneas independientes (ver notas técnicas en pág. 92). 1 line and 2 ways. Possibility of 2 independent lines (see technical notes at page 92). 1 ligne, 2 sorties. Possibilité de 2 lignes indépendants. (voir notes techniques page 92)
							1 Unidad Unit Unité
	Tomas de red Pc sockets Prises d'ordinateur	Doble RJ45 Categoría 5e Double RJ45 Category 5e Double prise RJ45 Cat. 5e	37	707	05 50	ref. 2	
		Conjunto 6 vías + RJ45 Set 6 ways + RJ45 Ensemble prise tél. 6V et RJ45	37	708	05 50	ref. 2	
						1 Unidad Unit Unité	
	Tomas señal R/TV y SAT ecualizada R/TV and SAT socket outlets Prises signal RTV et SAT	Toma única Single socket Prise unique	37	712	05 50	ref. 2	Ver información técnica en página 91. See technical information on page 91. Voir information technique sur page 91.
		Intermedia A Intermediate A Intermède A	37	713	05 50	ref. 2	
		Intermedia B Intermediate B Intermède B	37	714	05 50	ref. 2	
		Toma final Final socket Prise finale	37	711	05 50	ref. 2	
		Sólo tapa Only cover Seulement couvercle	37	715	05 50	ref. 2	
						1 Unidad Unit Unité	

www.fontini-lux.ru

ACABADO FINISH FINITION

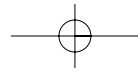

		Serie Set Série	Código Code Cod	Acabado Finish Finition	Embalaje Packaging Emballage	
	Regulador conmutador potencia 40-500W (incandescencia y halógenas) Dimmer two-way switch power 40-500W (for incandescence and halogen bulbs) Variateur - va-et-vient Puissance 40-500W (incandescent et halogène)	37	332	25 51	ref. 2 	Ver notas técnicas en pág. 90. See technical notes at page 90. Voir l'information technique sur page 90.
	Regulador para motores 6A-250V~ Dimmer for motors 6A-250V~ Variateur pour moteurs 6A-250V~	37	331	25 51	ref. 2 	
www.fontini-lux.ru						
	Termostato para calefacción suelo radiante, incluye sonda Thermostat for underfloor heating, with sounding line Thermostat pour chauffage sol radiant, avec sonde	37	721	05	ref. 2 	1 Unidad Unit Unité
	Termostato para calefacción temperatura ambiente Room temperature thermostat Thermostat chauffage temperature d'ambiance	37	722	05	ref. 2 	
	Detector de presencia 180º y sonido Presence and sound detector 180º Détecteur de présence et son 180º	37	750	05	ref. 2 	1 Unidad Unit Unité

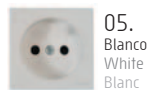

Collection
F-37

	Serie Set Série	Código Code Cod	Acabado Finish Finition	Embalaje Packaging Emballage	
 <p>Caratula para salida de cables Cable outlet Couvercle pour sortie de câbles</p>	37	927	05 50	ref. 2 	1 Unidad Unit Unité
 <p>Placa ciega Blind cover Couvercle neutre</p>	37	656	05 50	ref. 2 	1 Unidad Unit Unité
www.fontini-lux.ru					
 <p>Potenciómetro regulador de volumen Potentiometer for volume regulation Potentiomètre pour réglage du volume</p>	37	924	25 51	ref. 2 	<p>Ver notas técnicas en pág. 94. See technical notes at page 94. Voir l'information technique sur page 94.</p> <p>1 Unidad Unit Unité</p>
 <p>Altavoz para caja universal Potencia 2W Impedancia 16 Ω Loudspeaker for universal box Power 2W Impedance 16 Ω Hautparleur pour boîtier standard Puissance 2W - impédance 16 Ω</p>	37	926	05 50	ref. 2 	<p>Ver notas técnicas en pág. 94. See technical notes at page 94. Voir l'information technique sur page 94.</p> <p>1 Unidad Unit Unité</p>

ACABADO FINISH FINITION



	Serie Set Série	Código Code Cod	Acabado Finish Finition	Embalaje Packaging Emballage	
 <p>Toma para altavoz 2 salidas Loudspeaker socket 2 ways Prise pour hautparleur 2 sorties</p>	37	905	05 50	ref. 2 	1 Unidad Unit Unité
 <p>Adaptador para controles de sonido EGI® Adaptor for EGI® sound controls Adaptateur pour contrôles de son EGI®</p>	37	944	05 Blanco White Blanc 10 Negro Black Noir	ref. 2 	<p>Para más información ver pág. 95. For more information see page 95. Pour plusieurs renseignements voir page 95.</p> <p>1 Unidad Unit Unité</p>
 <p>Adaptador para controles de sonido TEZ® y Sonbel® Adaptor for TEZ® and Sonbel® sound controls Adaptateur pour contrôles de son TEZ® et Sonbel®</p>	37	945	05 Blanco White Blanc 10 Negro Black Noir	ref. 2 	<p>Para más información ver pág. 96. For more information see page 96. Pour plusieurs renseignements voir page 96.</p> <p>1 Unidad Unit Unité</p>
 <p>Zumbador 220V 80dB intermitente Buzzer 220V 80dB intermittent Sonette 220V 80dB intermittent</p>	37	390	05 50	ref. 2 	<p>Para más información ver pág. 94. For more information see page 94. Pour plusieurs renseignements voir page 94.</p> <p>1 Unidad Unit Unité</p>



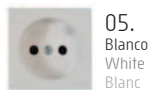



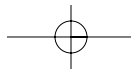

www.fontini-lux.ru



® Marca registrada



Collection
F-37

	Serie Set Série	Código Code Cod	Acabado Finish Finition	Embalaje Packaging Emballage	
 <p>Marco madera 1 elemento Wood frame 1 element Cadre en bois 1 élément 90x90x11mm</p>	37	801	Ver acabados See finishings Voir finitions	ref. 2 	1 Unidad Unit Unité
 <p>Marco madera 2 elementos Wood frame 2 elements Cadre en bois 2 éléments 90x162x11mm</p>	37	802	Ver acabados See finishings Voir finitions	ref. 2 	1 Unidad Unit Unité
www.fontini-lux.ru					
 <p>Marco madera 3 elementos Wood frame 3 elements Cadre en bois 3 éléments 90x233x11mm</p>	37	803	Ver acabados See finishings Voir finitions	ref. 2 	1 Unidad Unit Unité
 <p>Marco madera 4 elementos Wood frame 4 elements Cadre en bois 4 éléments 90x299x11mm</p>	37	804	Ver acabados See finishings Voir finitions	ref. 2 	1 Unidad Unit Unité

ACABADO FINISH FINITION



04.
Wenge
Wengue







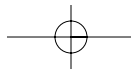

03.
Tabacco
Tabacco
Tabac

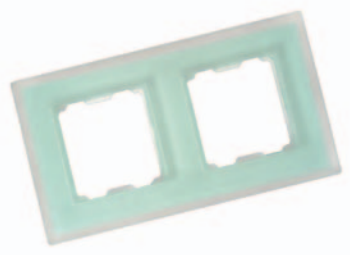

02.
Cerezo
Cherry tree
Mérissier

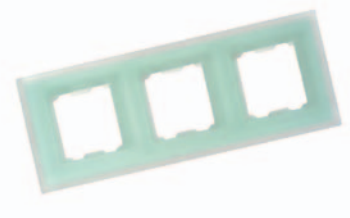

		Serie Set Série	Código Code Cod	Acabado Finish Finition	Embalaje Packaging Emballage	
	Marco cristal 1 elemento Glass frame 1 element Cadre en verre 1 élément 90x90x12mm	37	801	Ver acabados See finishings Voir finitions	ref. 2 	1 Unidad Unit Unité
	Marco cristal 2 elementos Glass frame 2 elements Cadre en verre 2 éléments 90x162x12mm	37	802	Ver acabados See finishings Voir finitions	ref. 2 	1 Unidad Unit Unité
	Marco cristal 3 elementos Glass frame 3 elements Cadre en verre 3 éléments 90x233x12mm	37	803	Ver acabados See finishings Voir finitions	ref. 2 	1 Unidad Unit Unité



07.
Azul Reflex
Reflex Blue
Bleu reflex



66.
Blanco
White
Blanc



66.
Verde Manzana
Apple Green
Vert pomme

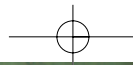

Collection Dimbler

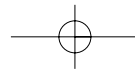

www.fontini-lux.ru

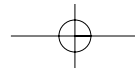
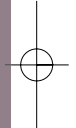
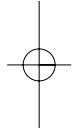

Collection Dimbler

Instalación de superficie

- Mecanismos de 10AX - 250V~
- Construida con termoplásticos técnicos
- Contactos de plata de alto poder de ruptura
- Combinable con peanas y accesorios Garby
- Manecillas de latón cromado, dorado y patiné
- Embellecedores de latón niquelado, dorado y patiné
- Cuerpo-base de porcelana

Surface installation

- 10AX - 250V~ mechanisms
- Manufactured with technical thermoplastic materials
- Silver contacts with high breaking power
- Combinable with Garby plates and accessories
- Knobs made of brass chrome-plated, golden and antique bronze
- Cover made of brass nickel-plated, golden and antique bronze
- Porcelain body

Installation saillie

- Mécanismes de 10AX - 250V~
- Fabriquée à partir de thermoplastiques techniques
- Contacts d'argent d'haut pouvoir de rupture
- Combinable avec socles et accessoires Garby
- Manettes de laiton chromé, doré et patiné américain
- Enjoliveur de laiton nickelée, doré et patiné américain
- Corps de porcelaine



50//
Dorado
Golden
Doré



51//
Niquelado
Nickel-plated
Nickelée



53//
Patiné Americano
Antique bronze
Patiné Americane

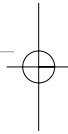
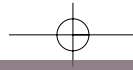

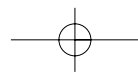

Collection Dimbler



Interruptor unipolar 10AX - 250V~
One pole switch 10AX - 250V~
Interrupteur unipolaire 10AX-250V~

Conmutador 10AX - 250V~
Two-way switch 10AX - 250V~
Va-et-vient 10AX-250V~

Cruzamiento 10AX - 250V~
Crossing switch 10AX - 250V~
Permutateur 10AX-250V~

Interruptor bipolar 10AX - 250V~
Two-pole switch 10AX - 250V~
Interrupteur bipolaire 10AX-250V~

Serie
Set Série

Código
Code Cod

Acabado
Finish Finition

Embalaje
Packaging Emballage

60

306

Ver acabados
See finishings
Voir finitions

ref. 2



ref. 4



60

308

ref. 2



ref. 4



60

304

ref. 2



ref. 4



60

314

ref. 2



ref. 4



1 Unidad Unit Unité



Pulsador 10A - 250V~ - 24V DC
Pushbutton 2A - 250V~ - 24V DC
Bouton poussoir 10A-250V~ - 24V DC

60

310

Ver acabados
See finishings
Voir finitions

ref. 2



ref. 4



1 Unidad Unit Unité

www.fontini-lux.ru

Mecanismos combinables con las colecciones Garby y Garby colonial
Mechanisms are combinable with Garby and Garby colonial Collections
Mécanismes combinables avec les collections Garby et Garby Colonial



ACABADO FINISH FINITION

Con paso de cable
With cable inlet
Avec pas de câble



50.
Dorado
Golden
Doré



51.
Niquelado
Nickel-plated
Nickelée



53.
Patiné Americano
Antique bronze
Patiné Americane

Sin paso de cable
Without cable inlet
Sans pas de câble



55.
Dorado
Golden
Doré



56.
Niquelado
Nickel-plated
Nickelée



57.
Patiné Americano
Antique bronze
Patiné Americane

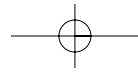



Collection Garby



17// Lazo Porcelana · Blanco
Porcelain Key · White
Bouton porcelaine · Blanc



18// Lazo Madera · Blanco
Wood Key · White
Bouton bois · Blanc



11// Lazo Porcelana · Cenefa Azul
Porcelain Key · Blue Decor
Bouton porcelaine · Décor. bleu



12// Lazo Madera · Cenefa Azul
Wood Key · Blue Decor
Bouton bois · Décor. bleu

www.fontini-lux.ru



13// Lazo Porcelana · Cenefa Marrón
Porcelain Key · Brown Decor
Bouton porcelaine · Décor. marron



14// Lazo Madera · Cenefa Marrón
Wood Key · Brown Decor
Bouton bois · Décor. marron



15// Garby Reggia
Garby Reggia
Garby Reggia



Lazo Retro Blanco*
White Retro Key *
Bouton Rétro*

*Lazo Retro opcional. Ref. 35.930.17.2 ver pág. 75
*The Retro key is optional. Ref. 35.930.17.2 see page 75
*Bouton Rétro opyonel. Réf. 35.930.17.2 voir page 75



Collection Garby

- Instalación de superficie
- Mecanismos de 10AX - 250V~
 - Bases de enchufe de 10/16A - 250V~
 - Construida con porcelana y termoplásticos técnicos
 - Peanas de haya
 - Manecillas de haya, porcelana y latón
 - Contactos de plata de alto poder de ruptura
 - Peanas para instalar en posición vertical u horizontal
 - Producto certificado

- Surface installation
- 10AX - 250V~ mechanisms
 - 10/16A - 250V~ earthing sockets
 - Manufactured with porcelain and technical thermoplastic materials
 - Beech wood bases
 - Control taps made of wood, porcelain and brass
 - Silver contacts with high breaking power
 - Beech wood bases for vertical or horizontal installations
 - Certified product

- Installation en saillie
- Mécanisme de 10A - 250V~
 - Prises de 10/16A - 250V ~
 - Fabriquée en porcelaine et à partir de thermoplastiques techniques
 - Bases en hêtre
 - Boutons en bois, porcelaine ou laiton
 - Contacts d'argent d'haute pouvoir de rupture
 - Bases pour installations verticales ou horizontales
 - Produit homologué

www.fontini-lux.ru



Decorado - Marco porcelana
Decorated - Porcelain frame
Décoré - Cadre porcelaine



Porcelana blanco - Marco craquelé
White porcelain - Craquelé frame
Porcelaine blanche - Cadre craqué



Garby Reggia - Marco envejecido
Garby Reggia - Old wood frame
Garby Reggia - Cadre bois vieilli



Porcelana lazo madera - marco envejecido
Porcelain wood key - old wood frame
Porcelaine bouton bois - cadre bois vieilli

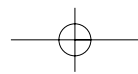

Collection
Garby



Interruptor 10AX - 250V~
Switch 10AX - 250V~
Interrupteur unipolaire 10AX-250V~

Serie
Set Série

Código
Code Cod

Acabado
Finish Finition

Embalaje
Packaging Emballage

30

306

Ver acabados
See finishings
Voir finitions

ref. 2



ref. 4



Conmutador 10AX - 250V~
Two-way switch 10AX - 250V~
Va-et-vient 10AX-250V~

30

308

ref. 2



ref. 4



Cruzamiento 10AX- 250V~
Crossing switch 10AX - 250V~
Permutateur 10AX-250V~

30

304

ref. 2



ref. 4



Interruptor bipolar 10AX - 250V~
Two-pole switch 10AX - 250V~
Interrupteur bipolaire 10AX-250V~

30

314

ref. 2



1 Unidad Unit Unité



Mecanismo para persianas 10A - 250V~
Electric blinds mechanism 10A - 250V~
Mécanisme pour volets roulants 10A-250V~

30

342

Ver acabados
See finishings
Voir finitions

ref. 2



www.fontini-lux.ru

1 Unidad Unit Unité



Base normal superficie 16A - 250V~
Two-pole socket outlet without earth 10/16A - 250V~
Prise de courant 10/16A - 250V~ avec obturateurs de sécurité

30

209

17
11
13
15

ref. 2



ref. 4



Sólo reposición
Only for replacement
Uniquement pour remplacement

1 Unidad Unit Unité



Base superficie TT 16A - 250V~
con obturadores de seguridad
German two-pole socket With shutters
With earth 10/16A - 250V~
Prise de courant avec terre allemand
10/16A - 250V~ avec obturateurs de sécurité

30

204

17
11
13
15

ref. 2



ref. 4



1 Unidad Unit Unité

ACABADO FINISH FINITION



17.



11.



13.



18.



12.

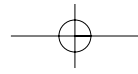

		Serie Set Série	Código Code Cod	Acabado Finish Finition	Embalaje Packaging Emballage		
	<p>Base superficie TT 16A- 250V~ sistema francés con obturador French two-pole socket With earth pin 10/16A - 250V~ With shutters Prise de courant 16A-250V~ avec terre français et obturateurs de sécurité</p>	30	208	17 11 13 15	ref. 2  ref. 4 	1 Unidad Unit Unité	
	<p>Pulsador timbre 10A - 250V~ 24V DC Pushbutton 10A - 250V~ 24V DC Bouton poussoir 10A-250V~ - 24V DC</p>	30	310	17 11 13 15	ref. 2  ref. 4 	1 Unidad Unit Unité	
www.fontini-lux.ru							
	<p>Doble pulsador 10A - 250V~ 24V DC Double pushbutton 10A - 250V~ 24V DC Double bouton poussoir 10A-250V~ - 24V DC</p>	30	343	17 11 13 15	ref. 2 	1 Unidad Unit Unité	
	<p>Tomas señal RTV/SAT ecualizadas RTV/SAT sockets outlets Prises signal RTV et SAT</p>	<p>Toma única Single socket Prise unique</p> <p>Intermedia A Intermediate A Intermède A</p> <p>Intermedia B Intermediate B Intermède B</p> <p>Toma final Final socket Prise finale</p>	30 30 30 30	712 713 714 709	17 11 13 15	ref. 2  ref. 4 	Ver información técnica en página 91. See technical information on page 91. Voir information technique sur page 91.
1 Unidad Unit Unité							



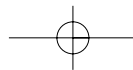

Collection
Garby



Tomas TV/FM
TV/FM sockets
Prises TV/FM

Toma serie serial socket prise série
Toma final final socket prise finale

Serie
Set Série

Código
Code Cod

Acabado
Finish Finition

Embalaje
Packaging Emballage

30

710

11

ref. 2



ref. 4



13

15

17

1 Unidad Unit Unité



Toma teléfono
Telephone socket
Prise téléphone 4 voies

4 vías 4 ways 4 voies
6 vías 6 ways 6 voies

30

700

11

ref. 2



ref. 4



13

15

17

www.fontini-lux.ru

1 Unidad Unit Unité



Toma RJ45 categoria 5e
Computer socket RJ45 category 5e
Prise RJ45 Cat 5e

30

702

11

ref. 2



13

15

17

1 Unidad Unit Unité



Tapa ciega
Blind cover
Couvercle neutre

30

656

17

ref. 2



1 Unidad Unit Unité

ACABADO FINISH FINITION



17.



11.



13.



15.

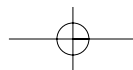

		Serie Set Série	Código Code Cod	Acabado Finish Finition	Embalaje Packaging Emballage	
	Salida de cables Cable outlet Sortie de câbles	30	927	11 13 15 17	ref. 2  ref. 4 	1 Unidad Unit Unité
	Caja de empalmes medida exterior ø110x50 mm Wall connection box external size ø110x50 mm Boîte de dérivation Dimensions extérieurs ø110x50 mm	30	400	17	ref. 2 	
www.fontini-lux.ru						
	Florón para lámpara medida ø100x34 mm Rosette for lamps size ø100x34 mm Rosette pour luminaires mesure: ø100x34mm	30	940	17	ref. 2 	1 Unidad Unit Unité
	Bastidor con garras para caja universal sin tornillos Claws support for universal box Without screws Châssis métallique pour boîte sans vis	20	901	97 Metal Metallic Métal	ref. 0  ref. 4 	Sólo para peanas ref. 30.80x... Only for wood bases ref. 30.80x... Seulement pour socles réf. 30.80x...
						ref. 0 - 25 Unidades Units Unités ref. 4 - 12 Unidades Units Unités

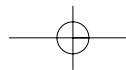

Collection
Garby

Serie Set Série Código Code Cod Acabado Finish Finition Embalaje Packaging Emballage



Aislador blanco para cable trenzado
medidas ø19x20 mm alto
Cable insulator white for intertwined cables
size ø19x20 mm height
Isolateur pour câble torsadé blanc
Dimensions: ø19 x 20mm haut

30

913

05

ref. 0 ref. 2 ref. 4

ref. 0 - 50 Unidades Units Unités
ref. 2 - 5 Unidades Units Unités
ref. 4 - 5 Unidades Units Unités



Aislador Marrón para cable trenzado
medidas ø19x20 mm alto
Cable insulator brown for intertwined cables
size ø19x20 mm height
Isolateur pour câble torsadé marron foncé
Dimensions: ø19 x 20mm haut

30

913

03

ref. 0 ref. 2 ref. 4

ref. 0 - 50 Unidades Units Unités
ref. 2 - 5 Unidades Units Unités
ref. 4 - 5 Unidades Units Unités

www.fontini-lux.ru



Tapón pasamuros (para tubo de 16 mm)
Medidas ø 26x19 mm
Wall-Passing Cap (For tubes of 16 mm)
Size ø26x19 mm
Bouchon passe-murs
Dimensions: ø26 x 19mm

30

938

05
03

ref. 2

2 Unidades Units Unités

Aplicación del tapón pasamuros
Use of the wall-passing cap
Application du bouchon passe-murs

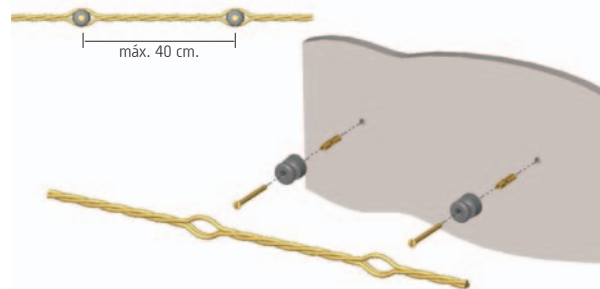
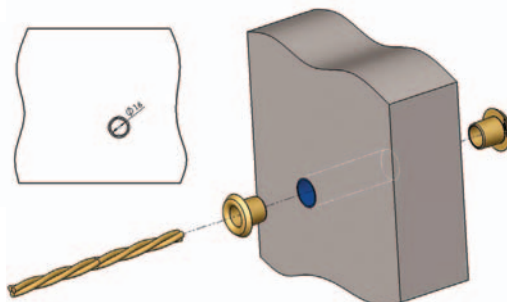

Instalación de cable trenzado con aisladores
Installation of intertwined cable with insulators
Installation de câble torsadé avec isolateurs

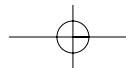

		Sección Section	Serie Set Série	Código Code Cod	Acabado Finish Finition	Embalaje Packaging Emballage	
	Conductor PVC 750 V con recubrimiento de algodón trenzado Intertwined PVC wire 750 V with cotton coating Fil conducteur torsadé PVC 750V avec revêtement en coton	2x1 mm 2x1,5 mm 2x2,5 mm 3x1 mm 3x1,5 mm	30 30 30 30 30	970 976 977 978 979	05 Blanco White Blanc	ref. 2	<p>Según Reglamento Electrotécnico para Baja Tensión (Real Decreto 842/2002) con entrada en vigor el 18 de Septiembre de 2003, el cable trenzado PVC de 750 V únicamente es apto para reformas o modificaciones de instalaciones existentes que no afecten a más del 50% de la potencia instalada.</p> <p>Fontini recommends checking the electrical regulations of your country before installing intertwinced cable. Fixed installations may not be allowed using the cable without an extra protection,</p> <p>Fontini recommande vérifier la normative électrique de votre pays avant d'installer câble torsadé. Les installations fixes avec le câble peuvent ne être pas autorisées sans une protection extra.</p>
	Conductor PVC blindado con aislante mineral ignífugo 750 V trenzado Intertwined pvc wire 750 V with mineral fireproof coating Fil conducteur torsadé PVC 750V avec revêtement minérale ignifugue	2x1,5 mm 2x2,5 mm 3x1,5 mm 3x2,5 mm 4x1,5 mm	30 30 30 30 30	971 972 974 975 980*	05 Blanco White Blanc 03 Marrón Brown Marron	ref. 2	
www.fontini-lux.ru							
							Rollos 100 m Rolls 100 m Rouleau 100 m *980 Rollos 25 m *980 Rolls 25 m Rouleau 25 m

	Peana de madera de haya superficie para 1 elemento ø100x12 mm Beech wood base 1 element surface mounting ø100x11,75 mm Socle en bois du hêtre pour 1 élément saillie ø100x12 mm		30	811	19	ref. 2	Incluye tornillos para montaje mecanismo-peana Screws included for fixing mechanism on wood base Inclus vis de montage mécanisme-socle
--	---------------------------------------------------------------------------------------------------------------------------------------------------------------------------------------	--	----	-----	----	--------	----------------------------------------------------------------------------------------------------------------------------------------------

1 Unidad Unit Unité

	Peana de madera de haya superficie para 2 elementos 175x100x12 mm Beech wood base 2 elements surface mounting 175x100x11,75 mm Socle en bois du hêtre pour 2 éléments saillie 175x100x12 mm		30	812	19	ref. 2	Incluye tornillos para montaje mecanismo-peana Screws included for fixing mechanism on wood base Inclus vis de montage mécanisme-socle
--	---------------------------------------------------------------------------------------------------------------------------------------------------------------------------------------------------	--	----	-----	----	--------	----------------------------------------------------------------------------------------------------------------------------------------------

1 Unidad Unit Unité

ACABADO FINISH FINITION



00.
Crudo (pintable)
Natural
Cru



19.
Miel
Honey
Miel



21.
Envejecida
Old wood
Bois vieilli

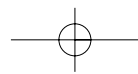

Collection
Garby

Serie Set Série Código Code Cod Acabado Finish Finition Embalaje Packaging Emballage



Peana de madera de haya superficie para 3 elementos 246,5x100x12 mm
beech wood base 3 elements surface mounting 246,5x100x12 mm
Socle en bois du hêtre pour 3 éléments saillie 246,5x100x12 mm

30

813

19

ref. 2

Incluye tornillos para montaje mecanismo-peana
Screws included for fixing mechanism on wood base
Inclues vis de montage mécanisme-socle

1 Unidad Unit Unité



Peana de madera de haya para 1 elemento ø95x22 mm para instalación con caja universal o superficie
Beech wood base 1 element ø95x22 mm for universal box or surface installations
Socle en bois du hêtre pour 1 élément ø95x22 mm Pour installations sur boîte standard ou saillie

30

801

19

ref. 2

Incluye tornillos para montaje mecanismo-peana y peana-caja de empotrar
Screws included for fixing mechanism-wood base and wood base on fitting box
Inclues vis de montage mécanisme-socle et socle-boîte d'encastrement

1 Unidad Unit Unité



Peana de madera de haya para 2 elementos 181x87,5x22 mm para instalación con caja universal o tubo
Beech wood base 2 elements 181x87,5x22 mm for universal box or tube installations
Socle en bois du hêtre pour 2 éléments 181x87,5x22 mm Pour installations sur boîte standard ou saillie

30

802

19
21
00

ref. 2

Incluye tornillos para montaje mecanismo-peana y peana-caja de empotrar
Screws included for fixing mechanism-wood base and wood base on fitting box
Inclues vis de montage mécanisme-socle et socle-boîte d'encastrement

1 Unidad Unit Unité



Peana de madera de haya para 3 elementos 252,5x87,5x22 mm para instalación con caja universal o tubo
Beech wood base 3 elements 252,5x87,5x22 mm for universal box or tube installations
Socle en bois du hêtre pour 3 éléments 252,5x87,5x22 mm Pour installations sur boîte standard ou saillie

30

803

19
21
00





ref. 2

Incluye tornillos para montaje mecanismo-peana y peana-caja de empotrar
Screws included for fixing mechanism-wood base and wood base on fitting box
Inclues vis de montage mécanisme-socle et socle-boîte d'encastrement

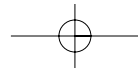
1 Unidad Unit Unité

www.fontini-lux.ru

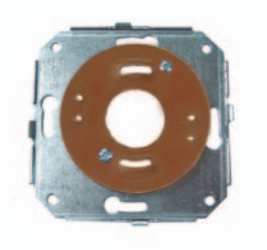

		Serie Set Série	Código Code Cod	Acabado Finish Finition	Embalaje Packaging Emballage	
	<p>Adaptador para marcos en superficie apto para marcos Garby Colonial, Venezia Clasica, Venezia Toscana, Venezia Metal y Venezia Carré. Adaptor for frames in surface installations suitable for frames Garby Colonial, Venezia Clasica, Venezia Toscana, Venezia Metal and Venezia Carré. Adaptateur pour cadres - installation saillie Valable pour cadres Garby Colonial, Venezia Clásica, Venezia Toscana, Venezia Métal et Venezia Carré.</p>	30	950	98	ref. 2 	
						6 Unidades Units Unités
	<p>Adaptador para marcos en caja universal apto para marcos Garby Colonial, Venezia Clasica, Venezia Toscana, Venezia Metal y Venezia Carré. Adaptor for frames in fitted-in installations suitable for frames Garby Colonial, Venezia Clasica, Venezia Toscana, Venezia Metal and Venezia Carré. Adaptateur pour cadres - installation sur boîte encastré Valable pour cadres Garby Colonial, Venezia Clásica, Venezia Toscana, Venezia Métal et Venezia Carré.</p>	30	951	98	ref. 2 	
						6 Unidades Units Unités

www.fontini-lux.ru

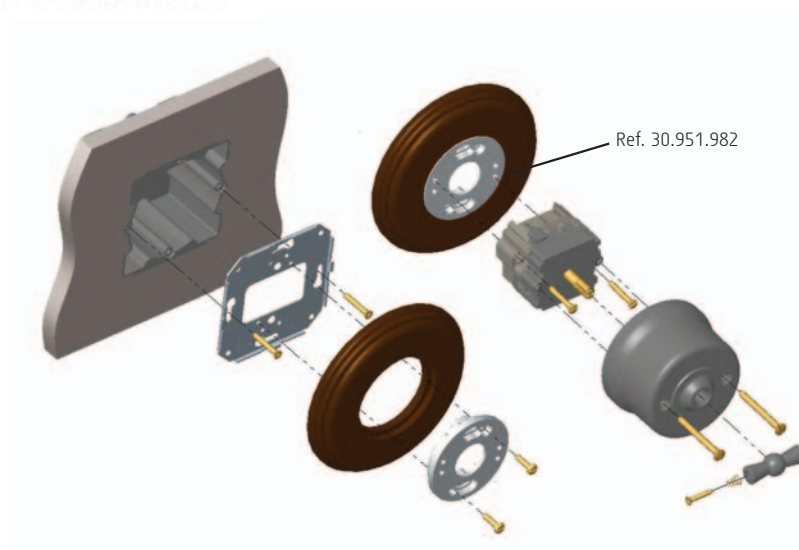
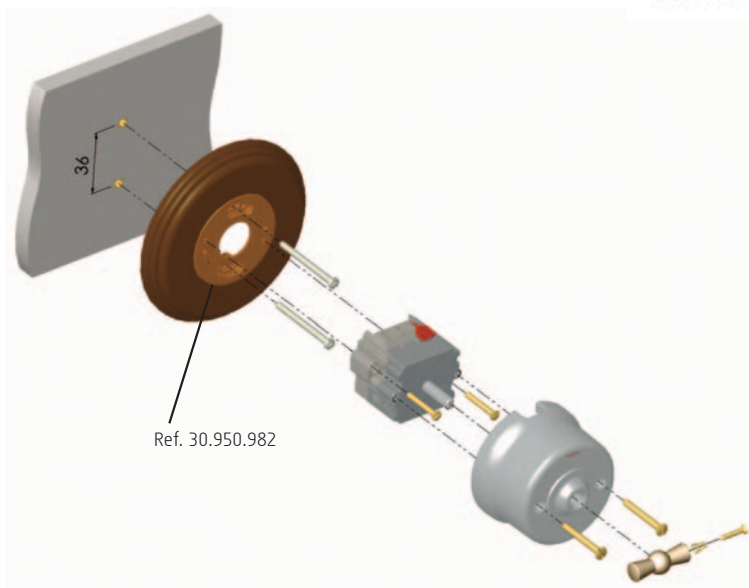

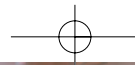

www.fontini-lux.ru

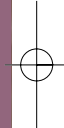
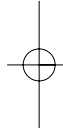

Collection Garby Colonial

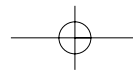

Lazo Porcelana · Marco Madera Envejecida
Porcelain Key · Old Wood Frame
Bouton porcelaine - Cadre bois vieillie



Lazo Madera · Marco Miel
Wood Key · Honey Frame
Bouton bois - Cadre bois miel



Lazo envejecido · Marco envejecido
Old key · Old frame
Bouton vieillie - Cadre bois vieillie

www.fontini-lux.ru



Lazo Porcelana · Marco Craquelé
Porcelain Key · Craquelé Frame
Bouton porcelaine - Cadre craquelé



Lazo Porcelana · Marco Decorado
Porcelain Key · Porcelain Decor Frame
Bouton porcelaine - Cadre décoré



Lazo Porcelana-Retro · Marco Porcelana
Porcelain Retro Key · Porcelain Frame
Bouton Rétro - Cadre porcelaine

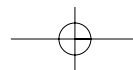

Collection Garby Colonial

Instalación empotrada

- Mecanismos de 10AX - 250V~
- Bases de enchufe de 10/16A - 250V~
- Construida con porcelana y termoplásticos técnicos
- Marcos de haya y porcelana
- Manecillas de haya y porcelana
- Contactos de plata de alto poder de ruptura
- Marcos para instalar en posición vertical u horizontal
- Bastidores enlazables
- Instalación en caja universal
- Producto certificado

Fitting installation

- 10AX - 250V~ mechanisms
- 10/16A - 250V~ earthing sockets
- Manufactured with porcelain and technical thermoplastic materials
- Beech wood and porcelain frames
- Control taps made of wood and porcelain
- Silver contacts with high breaking power
- Frames for vertical or horizontal installations, fitted in universal boxes
- Chassis rings to link
- Installation in standard box
- Certified product

Installation encastrée

- Mécanisme de 10A - 250V~
- Prises de 10/16A - 250V ~
- Fabriquée en porcelaine et à partir de thermoplastiques techniques
- Cadres en hêtre et porcelaine
- Boutons en hêtre et porcelaine
- Contacts d'argent d'haute puissance de rupture
- Cadres pour installations verticales ou horizontales
- Châssis joignables
- Produits certifiés

www.fontini-lux.ru









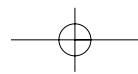









Conjunto 2 interruptores manecilla porcelana marco madera envejecida

Set 2 switches with porcelain key and old wood frame

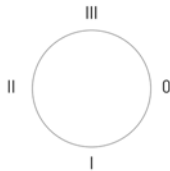
2 interrupteurs avec bouton papillon en porcelaine et cadre en bois vieilli



Collection
Garby Colonial

	Serie Set Série	Código Code Cod	Acabado Finish Finition	Embalaje Packaging Emballage	
	Interruptor unipolar 10AX - 250V~ One pole switch 10AX - 250V~ Interrupteur unipolaire 10AX-250V~	31 306	Ver acabados See finishings Voir finitions	ref. 2  ref. 4 	1 Unidad Unit Unité
	Conmutador 10AX - 250V~ Two-way switch 10AX - 250V~ Interrupteur unipolaire 10AX-250V~	31 308		ref. 2  ref. 4 	
	Cruzamiento 10AX - 250V~ Crossing switch 10AX - 250V~ Permutateur 10AX-250V~	31 304		ref. 2  ref. 4 	
	Interruptor bipolar 10AX - 250V~ Two-pole switch 10AX - 250V~ Interrupteur bipolaire 10AX-250V~	31 314		ref. 2 	
	Doble interruptor 10AX - 250V~ Double switch 10AX - 250V~ Double interrupteur unipolaire 10AX-250V~	31 300	Ver acabados See finishings Voir finitions	ref. 2  ref. 4 	 <ul style="list-style-type: none"> 0 Circuitos cerrados I Circuito A abierto II Circuito A y B abierto III Circuito A cerrado y B abierto 0 Both circuits Off I A circuit On II Both circuits On III B circuit On, A Off 0 Circuits fermés I Circuit A ouvert II Circuits A et B ouverts III Circuit B ouvert, A fermé
	Doble conmutador 10AX - 250V~ Double two-way switch 10AX - 250V~ Double va-et-vient 10AX-250V~	31 302		ref. 2  ref. 4 	
	La posición 0 varía según la posición del otro conmutador Position 0 depends on the position of the other two-way switch La position 0 varie selon la position de l'autre va-et-vient				
	Pulsador 10A - 250V~ - 24V DC Pushbutton 10A - 250V~ - 24V DC Bouton poussoir 10A-250V~ - 24V DC	31 310	17	ref. 2  ref. 4 	1 Unidad Unit Unité
	Doble pulsador 10A - 250V~ - 24V DC Double pushbutton 10A - 250V~ - 24V DC Double bouton poussoir 10A-250V~ - 24V DC	31 343	25 Tuercas Niqueladas Nickel-plated Nuts Écrous Nickelées	ref. 2 	1 Unidad Unit Unité

ACABADO FINISH FINITION





17.
Porcelana
Porcelain

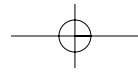

18.
Madera miel
Honey wood



		Serie Set Série	Código Code Cod	Acabado Finish Finition	Embalaje Packaging Emballage	
	Mecanismo para persiana 10A - 250V~ (para motores de 1,66A) Electric blinds mechanism 10A - 250V~ (for 1,66A motors) Mécanisme pour volets roulants 10A-250V~ (Pour moteurs 1,66A)	31	342	Ver acabados See finishings Voir finitions	ref. 2  ref. 4 	1 Unidad Unit Unité
	Mecanismo para tarjetas con indicador luminoso Mechanism for cards with luminous indicator Mécanisme pour cartes avec indicateur lumineux	37	935	05	ref. 2 	Se recomienda la instalación con relés Installation with relays is recommended L'installation avec relais est recommandée
	Interruptor-Conmutador 1 Microrruptor 6A-250V~ Switch two way switch 1 micro 6A-250V~ Interrupteur - va-et-vient 1 microrrupteur 6A-250V	37	936	05	ref. 2 	
	Base de enchufe 16A - 250V~ con obturador de seguridad Two-pole socket outlet without earth 16A - 250V~ With shutters Prise de courant 16A - 250V~ avec obturateurs de sécurité	31	209	05	ref. 2  ref. 4 	Sólo reposición Only for replacement Uniquement pour remplacement
	Base de enchufe TT lateral 16A - 250V~ con obturador de seguridad German two-pole socket with earth 16A - 250V~ With shutters Prise de courant 16A - 250V~ avec contact de terre schuko et obturateurs de sécurité	31	212	05	ref. 2  ref. 4 	1 Unidad Unit Unité









23.
Porcelana retro
Retro key



21.
Madera envejecida
Old wood







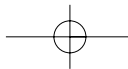



Collection
Garby Colonial

			Serie Set Série	Código Code Cod	Acabado Finish Finition	Embalaje Packaging Emballage	
	Base de enchufe TT sistema frances 16A - 250V~ con obturador de seguridad French two-pole socket with earth pin 16A - 250V~ With shutters Prise de courant 16A-250V~ avec terre français et obturateurs de sécurité		31	208	05	ref. 2  ref. 4 	1 Unidad Unit Unité
	Toma teléfono Telephone socket Prise téléphone	4 vías 4 ways 4 voies 6 vías 6 ways 6 voies	31	700 701	05	ref. 2  ref. 4 	1 Unidad Unit Unité
	Toma RJ 45 categoria 5e Computer socket RJ 45 category 5e Prise RJ45 Cat 5e		31	702	05	ref. 2 	1 Unidad Unit Unité
	Tomas R/TV señal SAT ecualizadas R/TV and SAT sockets outlets~ Prises signal RTV et SAT	Toma única Single socket Prise unique Intermedia A Intermediate A Intermède A Intermedia B Intermediate B Intermède B Toma final Final socket Prise finale Sólo tapa Only cover Seulement couvercle	35	712	05	ref. 2  ref. 4 	Ver información técnica en página 91. See technical information on page 91. Voir information technique sur page 91.
			35	713	05	ref. 2  ref. 4 	
			35	714	05	ref. 2  ref. 4 	
			35	711	05	ref. 2  ref. 4 	
			35	715	05	ref. 2  ref. 4 	
							1 Unidad Unit Unité

		Serie Set Série	Código Code Cod	Acabado Finish Finition	Embalaje Packaging Emballage	
	Regulador conmutador potencia 40-500W (incandescencia y halógenas) Dimmer two-way switch power 40-500W (for incandescence and halogen bulbs) Variateur - va-et-vient Puissance 40-500W (incandescent et halogène)	31	332	05	ref. 2  ref. 4 	
						1 Unidad Unit Unité
	Regulador para motores 6A - 250V~ Dimmer for motors 6A-250V~ Variateur pour moteurs 6A-250V~	31	331	05	ref. 2 	
						1 Unidad Unit Unité
	Termostato para calefacción suelo radiante. Incluye sonda. Thermostat for underfloor heating. With sounding line. Thermostat pour chauffage sol radiant. Avec sonde	37	721	05	ref. 2 	Instalar sólo en marco especial para elementos cuadrados ref. 31-821.. Install only on special frame for squared elements ref. 31-821.. À installer seulement sur le cadre spéciale pour éléments carrées réf. 31-821..
	Termostato para calefacción temperatura ambiente Room temperature thermostat Thermostat chauffage temperature d'ambiance	37	722	05	ref. 2 	
						1 Unidad Unit Unité
	Detector de presencia 180° y Sonido Presence and sound detector 180° Défcteur de présence et son 180°	37	750	05	ref. 2 	Instalar sólo en marco especial para elementos cuadrados ref. 31-821.. Install only on special frame for squared elements ref. 31-821.. À installer seulement sur le cadre spéciale pour éléments carrées réf. 31-821..
						1 Unidad Unit Unité





Collection
Garby Colonial

	Serie Set Série	Código Code Cod	Acabado Finish Finition	Embalaje Packaging Emballage	
 <p>Mecanismo interruptor con llave Switch mechanism with key Interrupteur à clé</p>	31	906	05	ref. 2 	
					1 Unidad Unit Unité
 <p>Carátula para salida de cables Cable outlet Couvercle pour sortie de câbles</p>	31	927	17	ref. 2  ref. 4 	
					1 Unidad Unit Unité
 <p>Placa ciega Blind cover Couvercle neutre</p>	31	656	17	ref. 2  ref. 4 	
					1 Unidad Unit Unité
 <p>Potenciómetro regulador de volumen Potentiometer for volume regulation Potentiomètre pour réglage du+B67 volume</p>	31	924	05	ref. 2  ref. 4 	
					1 Unidad Unit Unité

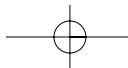
Ver notas técnicas en pág. 94.
See technical notes at page 94.
Voir l'information technique sur page 94.



		Serie Set Série	Código Code Cod	Acabado Finish Finition	Embalaje Packaging Emballage	
	Sintonizador de radio y control de volumen Radio tuner and volume regulator Radio tuner-potentiomètre	31	925	05	ref. 2 	Ver notas técnicas en pág. 94. See technical notes at page 94. Voir l'information technique sur page 94.
	Altavoz para caja universal Potencia 2W Impedancia 16 Ω Loudspeaker for universal box Power 2W Impedance 16 Ω Hautparleur pour boîtier standard Puissance 2W - impédance 16Ω	31	926	05	ref. 2 	Ver notas técnicas en pág. 94. See technical notes at page 94. Voir l'information technique sur page 94.
	Toma para altavoz Loudspeaker socket Prise pour hautparleur	31	905	05	ref. 2 	Ver notas técnicas en pág. 94. See technical notes at page 94. Voir l'information technique sur page 94.
	Zumbador 220V 80 dB intermitente Buzzer 220V 80dB intermittent Sonette 220V 80dB intermittent	31	390	05	ref. 2 	

1 Unidad Unit Unité

1 Unidad Unit Unité

1 Unidad Unit Unité

1 Unidad Unit Unité

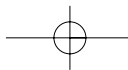

Collection
Garby Colonial

	Serie Set Série	Código Code Cod	Acabado Finish Finition	Embalaje Packaging Emballage	
	31	801	19 21 00	ref. 2 	
		821	19 21 00	ref. 2 	
	31	802	19 21 00	ref. 2 	1 Unidad Unit Unité
www.fontini-lux.ru					
	31	803	19 21 00	ref. 2 	1 Unidad Unit Unité
	31	804	19 21 00	ref. 2 	1 Unidad Unit Unité

ACABADO FINISH FINITION



19.
Miel
Honey
Miel







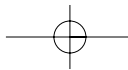

21.
Envejecida*
Old wood*
Vieilli*



00.
Crudo
Natural
Cru



		Serie Set Série	Código Code Cod	Acabado Finish Finition	Embalaje Packaging Emballage	
	Marco 1 elemento porcelana Porcelain frame 1 element Cadre 1 élément porcelaine ø100x12 mm	31	801	17 09 11	ref. 2 	1 Unidad Unit Unité
	Marco 2 elementos porcelana Porcelain frame 2 elements Cadre 2 éléments porcelaine 175x100x12 mm	31	802	17 09 11	ref. 2 	1 Unidad Unit Unité
	Marco 3 elementos porcelana Porcelain frame 3 elements Cadre 3 éléments porcelaine 246x100x12 mm	31	803	17 09 11	ref. 2 	1 Unidad Unit Unité





Collection Venezia Rotary & Rocking Switches

www.fontini-lux.ru