

# TVSarray<sup>®</sup>

Selector and Design Guide

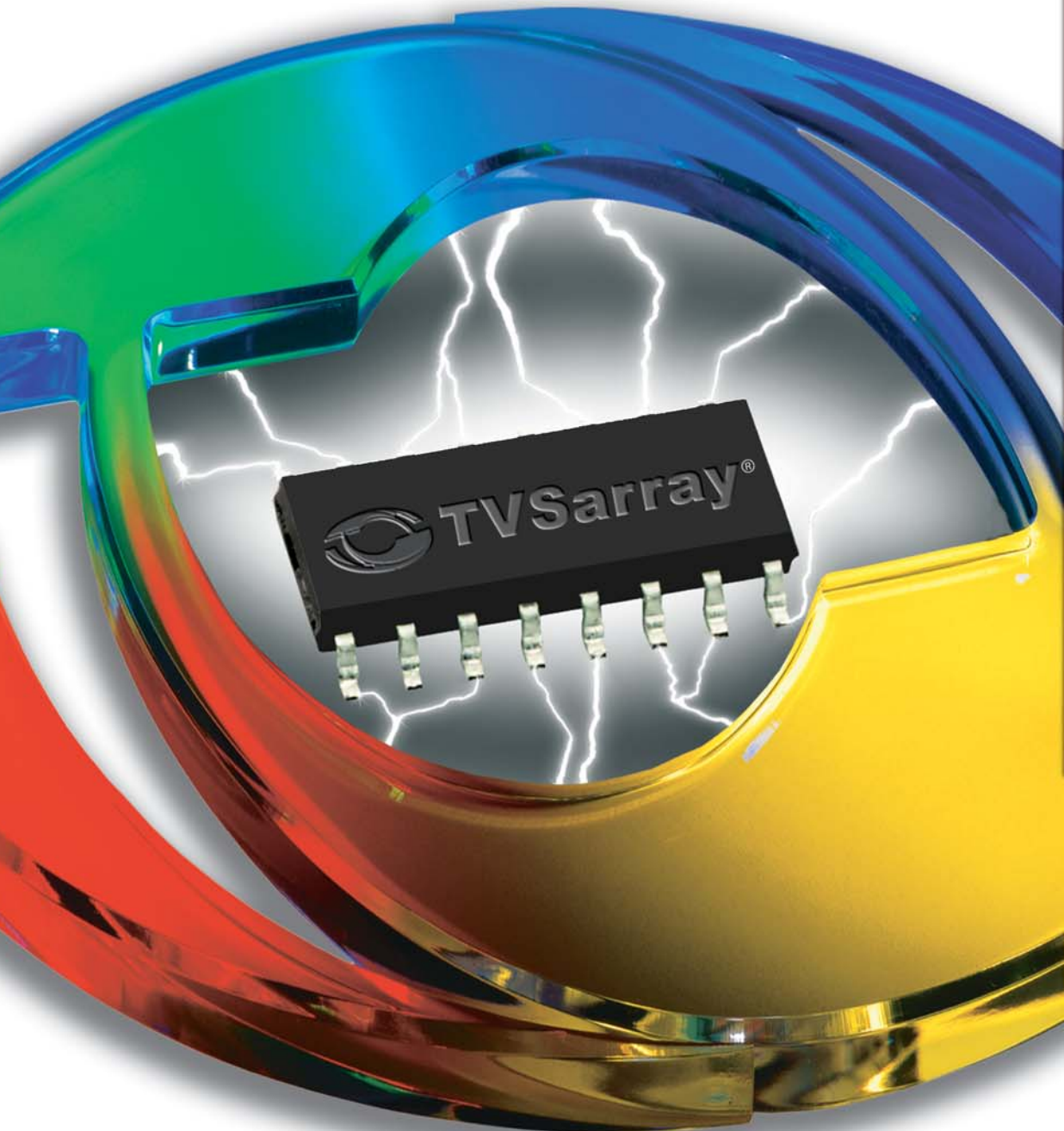

[www.Microsemi.com](http://www.Microsemi.com)

**Microsemi<sup>®</sup>**

# TVS

## Transient Voltage Protection

## Protection

- Electrostatic discharge
- Induced lightning
- Inductive load switching

## Advantages

- Custom solutions
- Three wafer fabrication facilities
- Numerous standard product offerings
- Continuous process control & improvement
- Number three US-based TVS manufacturer
- Active R&D

## Products

- Axial and stud mount
- Multi-element arrays
- Surface mount
- Chips, cells, straps
- QPL products
- Modules
- DIP



The functionality of today's electronic systems has few limits. However, the digital world that enables enhanced performance and efficiency of these systems is susceptible to threats. High among them, transient voltage spikes.

Have you ever given any thought to such damage while talking on the phone during a lightning storm, or working on a notebook computer on a windy day in a carpeted office, or flying on an airliner during rough weather?

Probably not. But we have.

All these environmental conditions pose a threat to the continued functionality of the complex and sensitive circuitry that allows these systems to operate. To safeguard these components, transient voltage suppressor (TVS) devices, were designed and characterized for voltage spike protection against threats that originate from electrostatic discharge (ESD), induced lightning and inductive load switching.

Microsemi Corporation is a leading supplier of these TVS devices to the computer/peripheral, telecommunication, medical, and military/aerospace marketplace.

Today, Microsemi offers voltage spike protection for virtually all commercial and high reliability applications. With over 12,000 part types, Microsemi has the most complete surface mount, axial, die, and TVS module product offering of any company in the world.

Microsemi has three transient voltage suppressor product centers throughout North America: Scottsdale, Arizona, Santa Ana, California and Watertown, Massachusetts. Each location is equipped with complete manufacturing and wafer fabrication facilities and has access to Microsemi's global low cost manufacturing facilities in Asia, India, and Mexico.



# TVSarray<sup>®</sup>

by Microsemi

With continual downsizing and greater sensitivity of electronic apparatus to improve and expand performance, Microsemi has kept pace by expanding its offering of transient voltage suppressor devices in surface mount arrays. Today, more than 20 families of Microsemi TVSarray<sup>®</sup> products are available in a range of packages that include SOT-23, SOT-143, SO-8, SO-14, and SO-16. These include unidirectional and bi-directional TVS devices to protect from electrostatic discharge, inductive kick-back, and low levels of induced lightning.

## Electrical Performance

Microsemi's large selection of TVSarray products provides a variety of circuit protection options:

- *SOT-23 TVS devices for single line bi-directional protection.*
- *Low capacitance USB04XXC in the SOT-143 for protection across a high data rate, single wire such as a coax cable.*
- *Up to seven lines can be protected from ESD, inductive load switching or low levels of induced lightning with a single SO-8 package. The SO-8 protects two high-speed data lines or up to seven lines for bi-directional signals.*
- *SO-16 packages can provide up to eight lines with unidirectional or bi-directional protection.*
- *For protection across fast data rate lines, Microsemi's ultra low capacitance TVSarrays are available in all package styles*

## Device Descriptions

This selection guide provides the most significant electrical and mechanical characteristics needed for quick identification and selection of Microsemi TVSarrays. Unidirectional TVSarrays are designed to operate with positive going signals and voltages only, while bi-directional devices are bilaterally symmetrical for both positive and negative voltage excursions.

Most TVSarrays are rated for a minimum of 300 W @ 8/20  $\mu$ s with a maximum pulse repetition rate of 0.01%. Some are rated as high as 600 W @ 10/1000  $\mu$ s. Standard operating voltages are available for 3.3 V, 5 V, 12 V, 15 V and 24 V applications. (Other voltages are available if needed. With few exceptions, low capacitance devices are designated with an "L", "LC", or "USB" in the part number and bi-directional devices are identified with a "C" suffix.



## Get Protected!

SO-8 and SO-16 TVSarrays are intended for high-density packaging in present and future designs. This series has been built to withstand transient surges as defined in IEC 1000-4-2 for EDS and electrical fast transients per IEC 1000-4-4. Electronic apparatus must meet the surge requirements of these specs to be certified for the European Community market. The SMDB series is rated for 10 A of induced lightning at 8/20  $\mu$ s. Rated for 600 W @ 10/1000  $\mu$ s, the SMP6LC6.5 is designed for use in severe telecom environments. Dimensions, lead configurations, mechanical outlines and specific electrical parameters are listed on individual data sheets found on our web site. To convert the generic types listed in the tables to a specific part, substitute the device operating voltage for the "XX", e.g. SMDA05, to designate a component having a 5 V operating voltage, or SMDA12 for 12 V applications.

For complete data on any part consult our web site or the factory.

# Quick Key

## Guide To TVS Components Selection

1. What is the continuous or repetitive peak voltages at the circuit location the TVS will be placed to protect a sensitive load?

*NOTE: This will determine "Working Standoff Voltage" or  $V_{wm}$  found on TVS data sheets. Any of these TVS devices serve as a clamp and are placed in parallel to the sensitive load to divert high surge currents to ground or around the sensitive load.*

2. What is the worst-case transient waveform in peak impulse current and pulse width duration the TVS needs to divert around the sensitive load?

*NOTE: This will determine Peak Impulse Current or  $I_{pp}$  as well as pulse width to help further select the correct Part Number(s) on TVS data sheets.*

3. What is the worst case peak voltage the sensitive load can withstand for the pulse duration in item #2 above?

*NOTE: This will determine the clamping voltage or  $V_c$  required from the TVS on the data sheets.*

4. What is the repetitive peak pulse power dissipation required to further select the correct part?

*NOTE: This will determine the important  $P_{pp}$  rating provided on TVS data sheets. It is the product of the peak impulse current and the clamping voltage above or  $P_{pp} = I_{pp} \times V_c$  at the pulse width in item #2.*

5. Is the pulse width different than described for the TVS rating in  $P_{pp}$ ?

*NOTE: The  $P_{pp}$  is often rated at 10/1000 us or 8/20 us. If different, use the  $P_{pp}$  versus pulse width performance curve given on the data sheet.*

*Example: if pulse width is shorter than a rating given at 10/1000 us, both the  $P_{pp}$  and  $I_{pp}$  will be higher in capability for shorter pulse widths. The clamping voltage  $V_c$  does not significantly change for TVS devices when operated along this performance curve.*

6. Is the required  $V_c$  lower in value than available on the data sheet for the  $V_{wm}$  described in item #1?

*NOTE: If the answer is yes, oversizing the  $P_{pp}$  selection for a given pulse condition will reduce the  $V_c$  where it is closer to  $V_{br}$  and  $V_{wm}$ . Also see Microsemi MicroNote 108.*

7. What package style is needed? (Axial, surface mount, array, etc.)

8. Is the surge waveform difficult to define for answering item #2 due to the illusive nature of some transients?

*NOTE: If the transient waveform is unknown, review MicroNote 125 for general recommendations regarding the three basic levels of protection recognized throughout the industry.*

### Applications

In addition to meeting IEC specifications for general use, Microsemi TVSarrays can provide protection from transient voltages encountered in hand-held equipment such as data logging systems, palmtop and laptop computers, computer peripherals, modems and RF amplifiers. One user is protecting CATV line extenders with



USB0405C TVSarrays. Initial device selection guidance for common applications can be found on the two charts that follow. In addition, this design guide includes two Microsemi MicroNotes™ on *Protecting USM Data I/O Ports* and *Transient Voltage Protection Across High Data Rate & RF Lines*.

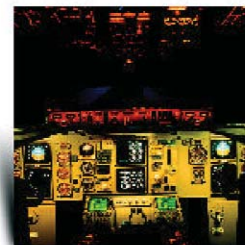



# TVSarray®

Series SO-8, SO-14 and SO16

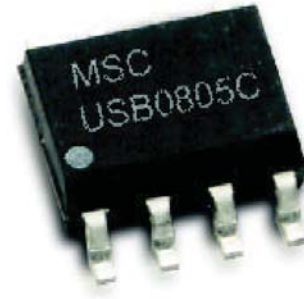

| Fig                                                                        | Part Number | Stand-off Voltage<br>$V_{WM}$<br>(V)<br>MAX | Breakdown Voltage<br>$V_{BR}$<br>@ $V_{BI} = 1mA$<br>(V)<br>MIN | Clamping Voltage<br>$V_C$<br>@ 1 Amp<br>(V)<br>MAX | Standby Current<br>$I_S$<br>@ $V_{WM}$<br>( $\mu A$ )<br>MAX | Capacitance<br>( $f = 1 MHz$ )<br>@ 0V<br>(pF)<br>TYP | Temperature<br>Coefficient of V <sub>BR</sub><br>$a_{VBR}$<br>mV/°C<br>MAX |
|----------------------------------------------------------------------------|-------------|---------------------------------------------|-----------------------------------------------------------------|----------------------------------------------------|--------------------------------------------------------------|-------------------------------------------------------|----------------------------------------------------------------------------|
| <b>SMDA (UNIDIRECTIONAL) 300 W 8/20 <math>\mu s</math></b>                 |             |                                             |                                                                 |                                                    |                                                              |                                                       |                                                                            |
| 1A                                                                         | SMDA03      | 3.3                                         | 4                                                               | 7                                                  | 200                                                          | 800                                                   | -3                                                                         |
| 1A                                                                         | SMDA05      | 5.0                                         | 6                                                               | 9.8                                                | 20                                                           | 600                                                   | 3                                                                          |
| 1A                                                                         | SMDA12      | 12.0                                        | 13.3                                                            | 19                                                 | 1                                                            | 185                                                   | 10                                                                         |
| 1A                                                                         | SMDA15      | 15.0                                        | 16.7                                                            | 24                                                 | 1                                                            | 140                                                   | 13                                                                         |
| 1A                                                                         | SMDA24      | 24.0                                        | 26.7                                                            | 43                                                 | 1                                                            | 90                                                    | 30                                                                         |
| <b>SMDA (BIDIRECTIONAL) 300 W 8/20 <math>\mu s</math></b>                  |             |                                             |                                                                 |                                                    |                                                              |                                                       |                                                                            |
| 1B                                                                         | SMDA03C     | 3.3                                         | 4                                                               | 7                                                  | 200                                                          | 400                                                   | -5                                                                         |
| 1B                                                                         | SMDA05C     | 5.0                                         | 6                                                               | 9.8                                                | 40                                                           | 300                                                   | 1                                                                          |
| 1B                                                                         | SMDA12C     | 12.0                                        | 13.3                                                            | 19                                                 | 1                                                            | 94                                                    | 8                                                                          |
| 1B                                                                         | SMDA15C     | 15.0                                        | 16.7                                                            | 24                                                 | 1                                                            | 70                                                    | 11                                                                         |
| 1B                                                                         | SMDA24C     | 24.0                                        | 26.7                                                            | 43                                                 | 1                                                            | 45                                                    | 28                                                                         |
| <b>SMDB (UNIDIRECTIONAL) 500 W 8/20 <math>\mu s</math></b>                 |             |                                             |                                                                 |                                                    |                                                              |                                                       |                                                                            |
| 1A                                                                         | SMDB03      | 3.3                                         | 4                                                               | 7                                                  | 200                                                          | 800                                                   | -3                                                                         |
| 1A                                                                         | SMDB05      | 5.0                                         | 6                                                               | 9.8                                                | 20                                                           | 600                                                   | 3                                                                          |
| 1A                                                                         | SMDB12      | 12.0                                        | 13.3                                                            | 19                                                 | 1                                                            | 185                                                   | 10                                                                         |
| 1A                                                                         | SMDB15      | 15.0                                        | 16.7                                                            | 24                                                 | 1                                                            | 140                                                   | 13                                                                         |
| 1A                                                                         | SMDB24      | 24.0                                        | 26.7                                                            | 43                                                 | 1                                                            | 90                                                    | 30                                                                         |
| <b>SMDB (BIDIRECTIONAL) 500 W 8/20 <math>\mu s</math></b>                  |             |                                             |                                                                 |                                                    |                                                              |                                                       |                                                                            |
| 1B                                                                         | SMDB03C     | 3.3                                         | 4                                                               | 7                                                  | 200                                                          | 400                                                   | -5                                                                         |
| 1B                                                                         | SMDB05C     | 5.0                                         | 6                                                               | 9.8                                                | 40                                                           | 300                                                   | 1                                                                          |
| 1B                                                                         | SMDB12C     | 12.0                                        | 13.3                                                            | 19                                                 | 1                                                            | 94                                                    | 8                                                                          |
| 1B                                                                         | SMDB15C     | 15.0                                        | 16.7                                                            | 24                                                 | 1                                                            | 70                                                    | 11                                                                         |
| 1B                                                                         | SMDB24C     | 24.0                                        | 26.7                                                            | 43                                                 | 1                                                            | 45                                                    | 28                                                                         |
| <b>SMDAXXC-4 (4 LINE BIDIRECTIONAL) 300 W 8/20 <math>\mu s</math></b>      |             |                                             |                                                                 |                                                    |                                                              |                                                       |                                                                            |
| 2                                                                          | SMDA03C-4   | 3.3                                         | 4                                                               | 7                                                  | 200                                                          | 300                                                   | -5                                                                         |
| 2                                                                          | SMDA05C-4   | 5.0                                         | 6                                                               | 9.8                                                | 40                                                           | 200                                                   | 3                                                                          |
| 2                                                                          | SMDA12C-4   | 12.0                                        | 13.3                                                            | 19                                                 | 1                                                            | 185                                                   | 10                                                                         |
| 2                                                                          | SMDA15C-4   | 15.0                                        | 16.7                                                            | 24                                                 | 1                                                            | 140                                                   | 13                                                                         |
| 2                                                                          | SMDA24C-4   | 24.0                                        | 26.7                                                            | 43                                                 | 1                                                            | 90                                                    | 30                                                                         |
| <b>SMDAXXC-4-2 (4/5 LINES BIDIRECTIONAL) 300 W 8/20 <math>\mu s</math></b> |             |                                             |                                                                 |                                                    |                                                              |                                                       |                                                                            |
| 3                                                                          | SMDA03C-4-2 | 3.3                                         | 4                                                               | 7                                                  | 200                                                          | 300                                                   | -5                                                                         |
| 3                                                                          | SMDA05C-4-2 | 5.0                                         | 6                                                               | 9.8                                                | 40                                                           | 200                                                   | 1                                                                          |
| 3                                                                          | SMDA12C-4-2 | 12.0                                        | 13.3                                                            | 19                                                 | 1                                                            | 75                                                    | 8                                                                          |
| 3                                                                          | SMDA15C-4-2 | 15.0                                        | 16.7                                                            | 24                                                 | 1                                                            | 50                                                    | 11                                                                         |
| 3                                                                          | SMDB24C-4-2 | 24.0                                        | 26.7                                                            | 43                                                 | 1                                                            | 35                                                    | 28                                                                         |
| <b>SMDAXXC-5 (5 LINE BIDIRECTIONAL) 300 W 8/20 <math>\mu s</math></b>      |             |                                             |                                                                 |                                                    |                                                              |                                                       |                                                                            |
| 4                                                                          | SMDA03C-5   | 3.3                                         | 4                                                               | 7                                                  | 200                                                          | 300                                                   | -5                                                                         |
| 4                                                                          | SMDA05C-5   | 5.0                                         | 6                                                               | 9.8                                                | 40                                                           | 200                                                   | 3                                                                          |
| 4                                                                          | SMDA12C-5   | 12.0                                        | 13.3                                                            | 19                                                 | 1                                                            | 75                                                    | 10                                                                         |
| 4                                                                          | SMDA15C-5   | 15.0                                        | 16.7                                                            | 24                                                 | 1                                                            | 50                                                    | 13                                                                         |
| 4                                                                          | SMDA24C-5   | 24.0                                        | 26.7                                                            | 43                                                 | 1                                                            | 32                                                    | 30                                                                         |
| <b>SMDAXX-6 (6 LINE UNIDIRECTIONAL) 300 W 8/20 <math>\mu s</math></b>      |             |                                             |                                                                 |                                                    |                                                              |                                                       |                                                                            |
| 5                                                                          | SMDA03-6    | 3.3                                         | 4                                                               | 7                                                  | 200                                                          | 800                                                   | -3                                                                         |
| 5                                                                          | SMDA05-6    | 5.0                                         | 6                                                               | 9.8                                                | 20                                                           | 550                                                   | 3                                                                          |
| 5                                                                          | SMDA12-6    | 12.0                                        | 13.3                                                            | 19                                                 | 1                                                            | 185                                                   | 10                                                                         |
| 5                                                                          | SMDA15-6    | 15.0                                        | 16.7                                                            | 24                                                 | 1                                                            | 140                                                   | 13                                                                         |
| 5                                                                          | SMDA24-6    | 24.0                                        | 26.7                                                            | 43                                                 | 1                                                            | 88                                                    | 30                                                                         |
| <b>SMDAXXC-7 (7 LINE BIDIRECTIONAL) 300 W 8/20 <math>\mu s</math></b>      |             |                                             |                                                                 |                                                    |                                                              |                                                       |                                                                            |
| 6                                                                          | SMDA03-7    | 3.3                                         | 4                                                               | 7                                                  | 200                                                          | 300                                                   | -5                                                                         |
| 6                                                                          | SMDA05-7    | 5.0                                         | 6                                                               | 9.8                                                | 40                                                           | 200                                                   | 1                                                                          |
| 6                                                                          | SMDA12-7    | 12.0                                        | 13.3                                                            | 19                                                 | 1                                                            | 75                                                    | 8                                                                          |
| 6                                                                          | SMDA15-7    | 15.0                                        | 16.7                                                            | 24                                                 | 1                                                            | 50                                                    | 11                                                                         |
| 6                                                                          | SMDA24-7    | 24.0                                        | 26.7                                                            | 43                                                 | 1                                                            | 35                                                    | 28                                                                         |

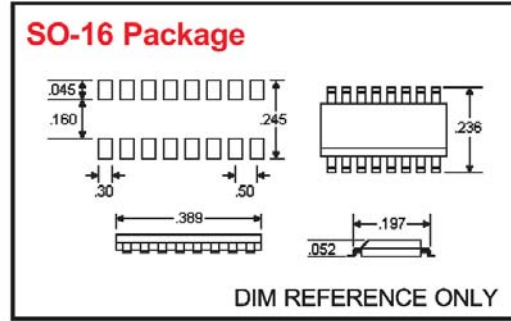
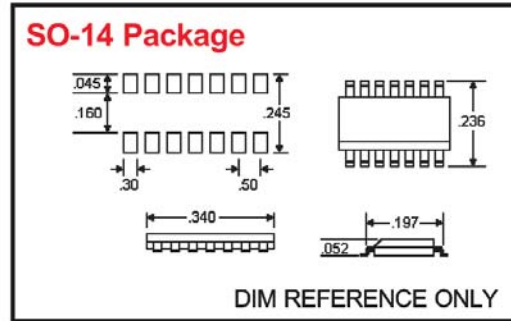
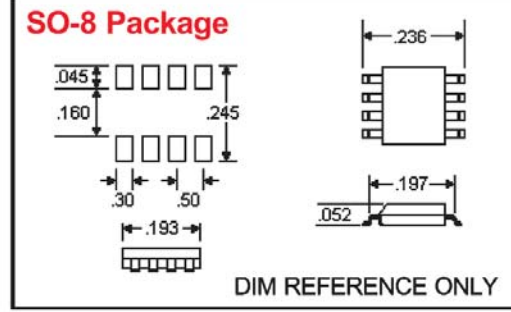

Fig 1

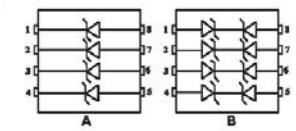

Fig 2

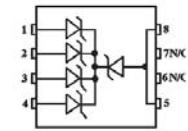

Fig 3

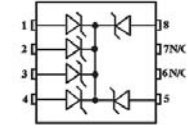

Fig 4

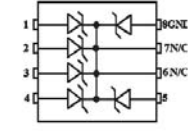

Fig 5

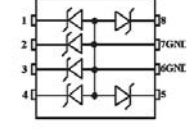
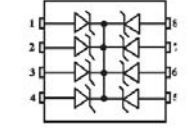

Fig 6



**Note**  
All devices provide board protection from transients caused by electrostatic discharge (ESD) as defined in IEC 1000-4-2, electrical fast transients (EFT) per IEC 1000-4-4 and secondary lightning.

**Protects**  
3.0/3.3 thru 24V  
Components

| Fig                                                                                      | Part Number | Stand-off Voltage $V_{VM}$ (V) MAX | Breakdown Voltage $V_{BR}$ @ $V_{IS}=1mA$ (V) MIN | Clamping Voltage $V_C$ @1 Amp (V) MAX | Standby Current $I_o$ @ $V_{VM}$ ( $\mu A$ ) MAX | Capacitance ( $f=1$ MHz) @0V (pF) TYP | Temperature Coefficient of $V_{BR}$ @ $V_{IS}$ (mV/°C) MAX |
|------------------------------------------------------------------------------------------|-------------|------------------------------------|---------------------------------------------------|---------------------------------------|--------------------------------------------------|---------------------------------------|------------------------------------------------------------|
| <b>USB08XX (2 LINE UNIDIRECTIONAL LOW CAP 5 pF) 500 W 8/20 <math>\mu s</math></b>        |             |                                    |                                                   |                                       |                                                  |                                       |                                                            |
| 7A                                                                                       | USB0803     | 3.3                                | 4                                                 | 8                                     | 200                                              | 5                                     | -5                                                         |
| 7A                                                                                       | USB0805     | 5.0                                | 6                                                 | 10.8                                  | 20                                               | 5                                     | 1                                                          |
| 7A                                                                                       | USB0812     | 12.0                               | 13.3                                              | 19                                    | 1                                                | 5                                     | 8                                                          |
| 7A                                                                                       | USB0815     | 15.0                               | 16.7                                              | 24                                    | 1                                                | 5                                     | 11                                                         |
| 7A                                                                                       | USB0824     | 24.0                               | 26.7                                              | 43                                    | 1                                                | 5                                     | 28                                                         |
| <b>USB08XX (2 LINE BIDIRECTIONAL LOW CAP 5 pF) 500 W 8/20 <math>\mu s</math></b>         |             |                                    |                                                   |                                       |                                                  |                                       |                                                            |
| 7B                                                                                       | USB0803C    | 3.3                                | 4                                                 | 8                                     | 200                                              | 5                                     | -5                                                         |
| 7B                                                                                       | USB0805C    | 5.0                                | 6                                                 | 10.8                                  | 40                                               | 5                                     | 1                                                          |
| 7B                                                                                       | USB0812C    | 12.0                               | 13.3                                              | 19                                    | 1                                                | 5                                     | 8                                                          |
| 7B                                                                                       | USB0815C    | 15.0                               | 16.7                                              | 24                                    | 1                                                | 5                                     | 11                                                         |
| 7B                                                                                       | USB0824C    | 24.0                               | 26.7                                              | 43                                    | 1                                                | 5                                     | 28                                                         |
| <b>USB508XX (2 LINE UNIDIRECTIONAL ULTRA LOW CAP 3 pF) 500 W 8/20 <math>\mu s</math></b> |             |                                    |                                                   |                                       |                                                  |                                       |                                                            |
| 7A                                                                                       | USB50803    | 3.3                                | 4                                                 | 8                                     | 200                                              | 3                                     | -5                                                         |
| 7A                                                                                       | USB50805    | 5.0                                | 6                                                 | 10.8                                  | 20                                               | 3                                     | 1                                                          |
| 7A                                                                                       | USB50812    | 12.0                               | 13.3                                              | 19                                    | 1                                                | 3                                     | 8                                                          |
| 7A                                                                                       | USB50815    | 15.0                               | 16.7                                              | 25                                    | 1                                                | 3                                     | 11                                                         |
| 7A                                                                                       | USB50824    | 24.0                               | 26.7                                              | 44                                    | 1                                                | 3                                     | 28                                                         |
| <b>USB508XX (2 LINE BIDIRECTIONAL ULTRA LOW CAP 3 pF) 500 W 8/20 <math>\mu s</math></b>  |             |                                    |                                                   |                                       |                                                  |                                       |                                                            |
| 7B                                                                                       | USB50803C   | 3.3                                | 4                                                 | 8                                     | 200                                              | 3                                     | -5                                                         |
| 7B                                                                                       | USB50805C   | 5.0                                | 6                                                 | 10.8                                  | 40                                               | 3                                     | 1                                                          |
| 7B                                                                                       | USB50812C   | 12.0                               | 13.3                                              | 19                                    | 1                                                | 3                                     | 8                                                          |
| 7B                                                                                       | USB50815C   | 15.0                               | 16.7                                              | 24                                    | 1                                                | 3                                     | 11                                                         |
| 7B                                                                                       | USB50824C   | 24.0                               | 26.7                                              | 43                                    | 1                                                | 3                                     | 28                                                         |
| <b>GBITXXC (2 LINE BIDIRECTIONAL LOW CAP 5pF) 500 W 8/20 <math>\mu s</math></b>          |             |                                    |                                                   |                                       |                                                  |                                       |                                                            |
| 7B                                                                                       | GBIT03C     | 3.3                                | 4                                                 | 8                                     | 200                                              | 5                                     | -5                                                         |
| 7B                                                                                       | GBIT05C     | 5.0                                | 6                                                 | 10.8                                  | 40                                               | 5                                     | 1                                                          |
| 7B                                                                                       | GBIT12C     | 12.0                               | 13.3                                              | 19                                    | 1                                                | 5                                     | 8                                                          |
| 7B                                                                                       | GBIT15C     | 15.0                               | 16.7                                              | 24                                    | 1                                                | 5                                     | 11                                                         |
| 7B                                                                                       | GBIT24C     | 24.0                               | 26.7                                              | 43                                    | 1                                                | 5                                     | 28                                                         |
| <b>SM8LCXX (8 LINE BIDIRECTIONAL) 300 W 8/20 <math>\mu s</math></b>                      |             |                                    |                                                   |                                       |                                                  |                                       |                                                            |
| 7B                                                                                       | SM8LC03     | 3.3                                | 4                                                 | 7                                     | 200                                              | 25                                    | -5                                                         |
| 7B                                                                                       | SM8LC05     | 5.0                                | 6                                                 | 9.8                                   | 40                                               | 25                                    | 1                                                          |
| 7B                                                                                       | SM8LC12     | 12.0                               | 13.3                                              | 19                                    | 1                                                | 25                                    | 8                                                          |
| 7B                                                                                       | SM8LC15     | 15.0                               | 16.7                                              | 24                                    | 1                                                | 25                                    | 11                                                         |
| 7B                                                                                       | SM8LC24     | 24.0                               | 26.7                                              | 43                                    | 1                                                | 25                                    | 28                                                         |
| <b>SMDAXX-8 (8 LINE BIDIRECTIONAL) 300 W 8/20 <math>\mu s</math></b>                     |             |                                    |                                                   |                                       |                                                  |                                       |                                                            |
| 8                                                                                        | SMDA03C-8   | 3.3                                | 4                                                 | 7                                     | 200                                              | 300                                   | -5                                                         |
| 8                                                                                        | SMDA05C-8   | 5.0                                | 6                                                 | 9.8                                   | 40                                               | 200                                   | 1                                                          |
| 8                                                                                        | SMDA12C-8   | 12.0                               | 13.3                                              | 19                                    | 1                                                | 75                                    | 8                                                          |
| 8                                                                                        | SMDA15C-8   | 15.0                               | 16.7                                              | 24                                    | 1                                                | 50                                    | 11                                                         |
| 8                                                                                        | SMDA24C-8   | 24.0                               | 26.7                                              | 43                                    | 1                                                | 35                                    | 28                                                         |
| <b>SM16XX (8 LINE UNIDIRECTIONAL) 300 W 8/20 <math>\mu s</math></b>                      |             |                                    |                                                   |                                       |                                                  |                                       |                                                            |
| 9                                                                                        | SM1603      | 3.3                                | 4                                                 | 7                                     | 125                                              | 850                                   | -3                                                         |
| 9                                                                                        | SM1605      | 5.0                                | 6                                                 | 9.8                                   | 20                                               | 880                                   | 3                                                          |
| 9                                                                                        | SM1612      | 12.0                               | 13.3                                              | 19                                    | 1                                                | 440                                   | 10                                                         |
| 9                                                                                        | SM1615      | 15.0                               | 16.7                                              | 24                                    | 1                                                | 400                                   | 13                                                         |
| 9                                                                                        | SM1624      | 24.0                               | 26.7                                              | 43                                    | 1                                                | 275                                   | 30                                                         |
| <b>SM16XXC (8 LINE BIDIRECTIONAL) 300 W 8/20 <math>\mu s</math></b>                      |             |                                    |                                                   |                                       |                                                  |                                       |                                                            |
| 10                                                                                       | SM1603C     | 3.3                                | 4                                                 | 7                                     | 200                                              | 425                                   | -5                                                         |
| 10                                                                                       | SM1605C     | 5.0                                | 6                                                 | 9.8                                   | 40                                               | 440                                   | 1                                                          |
| 10                                                                                       | SM1612C     | 12.0                               | 13.3                                              | 19                                    | 1                                                | 220                                   | 8                                                          |
| 10                                                                                       | SM1615C     | 15.0                               | 16.7                                              | 24                                    | 1                                                | 200                                   | 11                                                         |
| 10                                                                                       | SM1624C     | 24.0                               | 26.7                                              | 43                                    | 1                                                | 137                                   | 28                                                         |
| <b>SM16LCXX (8 LINE UNIDIRECTIONAL LOW CAP 25pF) 300 W 8/20 <math>\mu s</math></b>       |             |                                    |                                                   |                                       |                                                  |                                       |                                                            |
| 11                                                                                       | SM16LC03    | 3.3                                | 4                                                 | 7                                     | 200                                              | 25                                    | -5                                                         |
| 11                                                                                       | SM16LC05    | 5.0                                | 6                                                 | 9.8                                   | 20                                               | 25                                    | 1                                                          |
| 11                                                                                       | SM16LC12    | 12.0                               | 13.3                                              | 19                                    | 1                                                | 25                                    | 8                                                          |
| 11                                                                                       | SM16LC15    | 15.0                               | 16.7                                              | 24                                    | 1                                                | 25                                    | 11                                                         |
| 11                                                                                       | SM16LC24    | 24.0                               | 26.7                                              | 43                                    | 1                                                | 25                                    | 28                                                         |
| <b>SM16LCXXC (8 LINE UNIDIRECTIONAL LOW CAP 25pF) 300 W 8/20 <math>\mu s</math></b>      |             |                                    |                                                   |                                       |                                                  |                                       |                                                            |
| 12                                                                                       | SM16LC03C   | 3.3                                | 4                                                 | 7                                     | 200                                              | 25                                    | -5                                                         |
| 12                                                                                       | SM16LC05C   | 5.0                                | 6                                                 | 9.8                                   | 20                                               | 25                                    | 1                                                          |
| 12                                                                                       | SM16LC08C   | 8.0                                | 8.5                                               | 13.4                                  | 1                                                | 25                                    | 5                                                          |
| 12                                                                                       | SM16LC12C   | 12.0                               | 13.3                                              | 19                                    | 1                                                | 25                                    | 8                                                          |
| 12                                                                                       | SM16LC15C   | 15.0                               | 16.7                                              | 24                                    | 1                                                | 25                                    | 11                                                         |
| 12                                                                                       | SM16LC24C   | 24.0                               | 26.7                                              | 43                                    | 1                                                | 25                                    | 28                                                         |

Fig 7

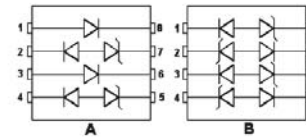

SO-8 Package

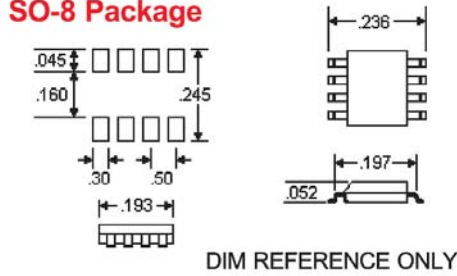
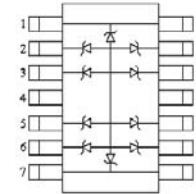

Fig 8



SO-14 Package

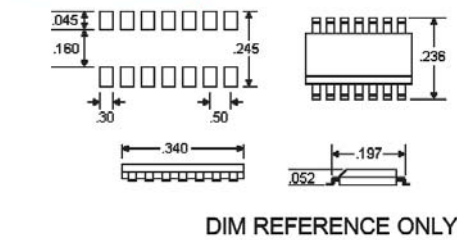
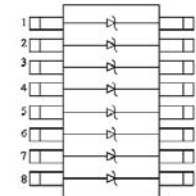

Fig 9



SO-16 Package

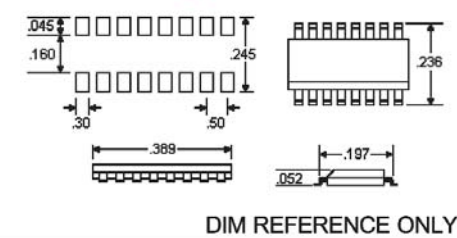

Fig 10

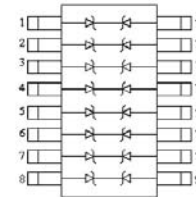

Fig 11

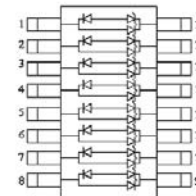
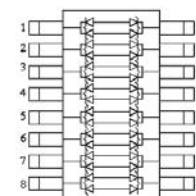

Fig 12





# TVSarray®

Series SO-8 and SO-16

| USB6B1 500W @ 8/20 μs   |             |                                             |                                                                       |                                                               |                                                               |                                                               |                                                                                |
|-------------------------|-------------|---------------------------------------------|-----------------------------------------------------------------------|---------------------------------------------------------------|---------------------------------------------------------------|---------------------------------------------------------------|--------------------------------------------------------------------------------|
| Fig                     | Part Number | Stand-off Voltage<br>V <sub>WM</sub><br>(V) | Breakdown Voltage<br>V <sub>BR</sub><br>@V <sub>BR</sub> =1mA<br>(V)  | Clamping Voltage<br>V <sub>C</sub><br>@1 Amp<br>(V)           | Standby Current<br>I <sub>0</sub><br>@V <sub>WM</sub><br>(μA) | Capacitance<br>(f=1 MHz)<br>@0V<br>(pF)                       | Temperature Coefficient<br>of V <sub>(BR)</sub><br>a <sub>(VBR)</sub><br>mV/°C |
|                         |             | MAX                                         | MIN                                                                   | MAX                                                           | MAX                                                           | TYP                                                           | MAX                                                                            |
| 1                       | USB6B1      | 5.0                                         | 6.0                                                                   | 9.8                                                           | 5                                                             | 5                                                             | 3                                                                              |
| SMP6LC5.0 thru SMP6LC12 |             |                                             |                                                                       |                                                               |                                                               |                                                               |                                                                                |
| Fig                     | Part Number | Stand-off Voltage<br>V <sub>WM</sub><br>(V) | Breakdown Voltage<br>V <sub>BR</sub><br>@V <sub>BR</sub> =10mA<br>(V) | Clamping Voltage<br>V <sub>C</sub><br>@I <sub>pp</sub><br>(V) | Standby Current<br>I <sub>0</sub><br>@V <sub>WM</sub><br>(μA) | Peak Pulse Current<br>@ 10/1000 μs<br>I <sub>pp</sub><br>AMPS | Capacitance<br>(f=1 MHz)<br>@0V<br>(pF)                                        |
|                         |             | MAX                                         | MIN                                                                   | MAX                                                           | MAX                                                           | MAX                                                           | TYP                                                                            |
| 2                       | SMP6LC5.0   | 5.0                                         | 6.0                                                                   | 9.6                                                           | 300                                                           | 10                                                            | 30                                                                             |
| 2                       | SMP6LC6.5   | 6.5                                         | 7.22                                                                  | 12.4                                                          | 300                                                           | 10                                                            | 30                                                                             |
| 2                       | SMP6LC12    | 12                                          | 13.3                                                                  | 19.9                                                          | 300                                                           | 10                                                            | 30                                                                             |

### I/O Port Protection USB6B1

This drawing illustrates protection of one line by one diode pair within the SO-8 package. Positive going spikes on pin 3 are diverted to ground through d1 and the TVS chip and also to the Vbus. Negative spikes are diverted through diode d2 to ground. Two lines can be common-mode protected with one USB6B1 SO-8 package.

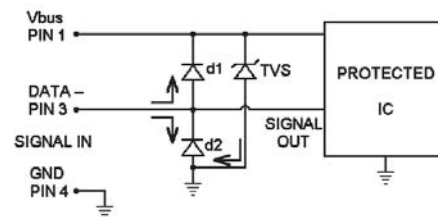

### Telecom Line Protection SMP6LCXX

This rugged 600 W device provides protection for a 10/1000 μs surge. The combination of low capacitance diodes and TVS provides an integrated product suited for T1/E1 applications. The size of the SO-16 array allows integration of protection on crowded PC boards. Protects two line pair in differential mode or one line pair in common mode.

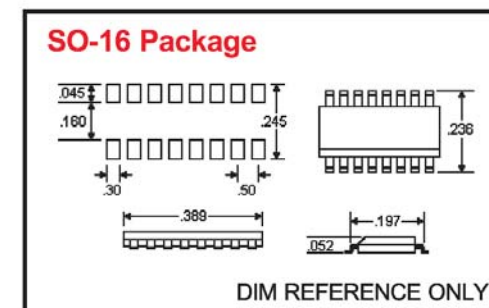
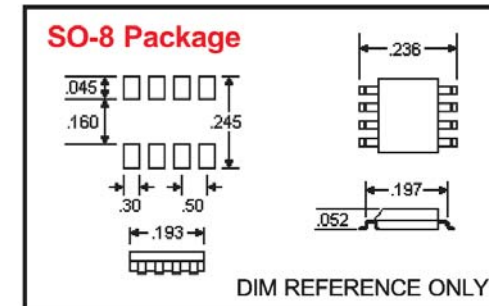
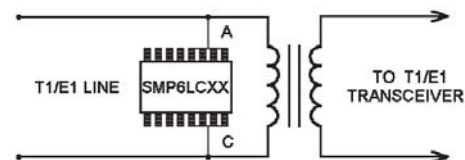

Fig 1

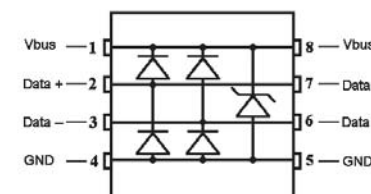
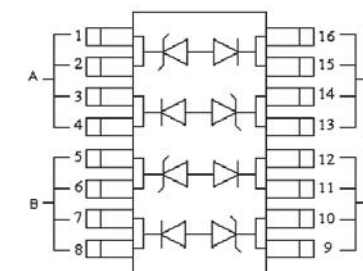

Fig 2



### High Speed Data Line Protectors

USB6B1 500W 8/20 μs  
SMP6LCXX 600W 10/1000 μs

Provide voltage spike protection for DATA and TELECOM, I/O Ports originating from ESD, EFT, and induced lightning.

# TVSarray<sup>®</sup> Applications

| Application                                                                                                                                                                              | Transient Voltage Suppression Arrays for Single and Multiple Line Protection ESD to 500 Watts 8/20 |                                     |                  |                                                      |                |                     |                        |                      |                       |                      |
|------------------------------------------------------------------------------------------------------------------------------------------------------------------------------------------|----------------------------------------------------------------------------------------------------|-------------------------------------|------------------|------------------------------------------------------|----------------|---------------------|------------------------|----------------------|-----------------------|----------------------|
|                                                                                                                                                                                          | SMXX<br>SOT-23<br>SMDA/B<br>SOIC-8                                                                 | SLXX<br>SOT-23<br>SM8LCXX<br>SOIC-8 | USB6B1<br>SOIC-8 | USB04XX<br>USB04XXC<br>SOT-143<br>USB08XXC<br>SOIC08 | GBIT<br>SOIC-8 | SMDAXXC-8<br>SOIC14 | SM-16XX-XXC<br>SOIC-16 | SM-16LCXX<br>SOIC-16 | SM-16LCXXC<br>SOIC-16 | SMP6LC6,5<br>SOIC-16 |
| <b>Max Data Rate</b>                                                                                                                                                                     | •                                                                                                  | 10 Mbps                             | 500 Mbps         | 500 Mbps                                             | 500 Mbps       | •                   | •                      | 10 Mbps              | 10M bps               | 1 Mbps ••            |
| <b>Hardware Applications</b>                                                                                                                                                             |                                                                                                    |                                     |                  |                                                      |                |                     |                        |                      |                       |                      |
| Desktop PC                                                                                                                                                                               |                                                                                                    | X                                   | X                | X                                                    | X              |                     |                        |                      |                       |                      |
| Notebook PC                                                                                                                                                                              |                                                                                                    | X                                   | X                | X                                                    | X              |                     |                        |                      |                       |                      |
| Laptop PC                                                                                                                                                                                |                                                                                                    | X                                   | X                | X                                                    | X              |                     |                        |                      |                       |                      |
| Palm Top PC                                                                                                                                                                              |                                                                                                    | X                                   | X                | X                                                    | X              |                     |                        |                      |                       |                      |
| Keyboards                                                                                                                                                                                | X                                                                                                  | X                                   |                  | X                                                    | X              |                     | X                      |                      |                       |                      |
| PC Ports                                                                                                                                                                                 |                                                                                                    | X                                   | X                | X                                                    | X              |                     |                        |                      |                       | X                    |
| Video Equipment                                                                                                                                                                          |                                                                                                    |                                     |                  | X                                                    | X              |                     |                        |                      |                       |                      |
| Printers                                                                                                                                                                                 |                                                                                                    | X                                   |                  |                                                      |                |                     |                        | X                    | X                     |                      |
| Disk Drives                                                                                                                                                                              |                                                                                                    |                                     |                  |                                                      |                |                     |                        |                      |                       |                      |
| Scanners                                                                                                                                                                                 | X                                                                                                  | X                                   | X                | X                                                    | X              |                     | X                      |                      |                       |                      |
| Alarm Systems                                                                                                                                                                            | X                                                                                                  | X                                   |                  | X                                                    | X              | X                   | X                      |                      | X                     |                      |
| Cellular Phones                                                                                                                                                                          |                                                                                                    | X                                   |                  | X                                                    | X              |                     |                        |                      |                       |                      |
| Postage Machines                                                                                                                                                                         | X                                                                                                  |                                     |                  |                                                      |                | X                   |                        |                      | X                     |                      |
| Stamp Machines                                                                                                                                                                           | X                                                                                                  |                                     |                  |                                                      |                | X                   |                        |                      | X                     | X                    |
| Data Logger                                                                                                                                                                              | X                                                                                                  | X                                   | X                |                                                      |                | X                   | X                      | X                    |                       |                      |
| Numerical Controllers                                                                                                                                                                    | X                                                                                                  |                                     |                  | X                                                    | X              | X                   | X                      |                      | X                     |                      |
| Charge Card Verifiers                                                                                                                                                                    | X                                                                                                  |                                     |                  | X                                                    | X              | X                   |                        |                      |                       |                      |
| Portable Medical Equipment                                                                                                                                                               | X                                                                                                  |                                     |                  |                                                      |                | X                   | X                      |                      | X                     | X                    |
| Slot Machines                                                                                                                                                                            | X                                                                                                  |                                     |                  | X                                                    | X              | X                   |                        |                      |                       |                      |
| POS Systems                                                                                                                                                                              | X                                                                                                  |                                     |                  | X                                                    | X              |                     |                        |                      |                       | X                    |
| Netw orks                                                                                                                                                                                | X                                                                                                  |                                     |                  | X                                                    | X              |                     | X                      | X                    |                       |                      |
| ATM Machines                                                                                                                                                                             | X                                                                                                  |                                     |                  | X                                                    | X              | X                   |                        |                      |                       |                      |
| <b>Communications Applications</b> Digital and Analog Data Streams                                                                                                                       |                                                                                                    |                                     |                  |                                                      |                |                     |                        |                      |                       |                      |
| T1/E1                                                                                                                                                                                    |                                                                                                    | X                                   |                  |                                                      |                |                     |                        |                      |                       |                      |
| T3/E3,DS3                                                                                                                                                                                |                                                                                                    |                                     | X                |                                                      |                |                     |                        |                      |                       | X                    |
| Servers                                                                                                                                                                                  | X                                                                                                  |                                     | X                |                                                      |                |                     | X                      | X                    |                       |                      |
| EIA -RS232 Date Rate 19.6kbs                                                                                                                                                             | X                                                                                                  | X                                   |                  |                                                      |                | X                   | X                      |                      | X                     |                      |
| EIA -RS422 Date Rate 10M bs                                                                                                                                                              | X                                                                                                  | X                                   |                  |                                                      |                | X                   | X                      |                      |                       |                      |
| EIA -RS423 Date Rate 100kbs                                                                                                                                                              | X                                                                                                  | X                                   |                  |                                                      |                | X                   | X                      |                      |                       |                      |
| EIA -RS485 V.35 Date Rate 5M bs                                                                                                                                                          |                                                                                                    | X                                   | X                | X                                                    | X              |                     | X                      | X                    |                       | X                    |
| 10/100 Ethernet                                                                                                                                                                          |                                                                                                    |                                     | X                | X                                                    | X              |                     | X                      |                      |                       | X                    |
| 10 Base T Ethernet                                                                                                                                                                       |                                                                                                    | X                                   | X                | X                                                    | X              |                     | X                      |                      |                       | X                    |
| USB Date Rate 12.5M bs                                                                                                                                                                   |                                                                                                    | X                                   | X                | X                                                    | X              |                     | X                      | X                    |                       |                      |
| Telecom Modems Date Rate 60kb/1.5M bs                                                                                                                                                    |                                                                                                    |                                     |                  |                                                      |                |                     |                        |                      |                       | X                    |
| IEEE-1394 Fire Wire Date Rate 125M bs                                                                                                                                                    |                                                                                                    |                                     | X                | X                                                    | X              |                     |                        |                      |                       |                      |
| CATV Date Rate up to 1Gbs                                                                                                                                                                |                                                                                                    |                                     | X                | X                                                    | X              |                     |                        |                      |                       |                      |
| <ul style="list-style-type: none"> <li>• Data rate varies with device operating voltage.</li> <li>•• Also provides protection for secondary lighting up to 600W at 10/100 μs.</li> </ul> |                                                                                                    |                                     |                  |                                                      |                |                     |                        |                      |                       |                      |



# TVSarray®

## Mini Array Series

| Fig                                                          | Part Number | Stand-off Voltage<br>V <sub>WM</sub><br>(V)<br>MAX | Breakdown Voltage<br>V <sub>BR</sub><br>@V <sub>WR</sub> =1mA<br>(V)<br>MIN | Clamping Voltage<br>V <sub>c</sub><br>@1 Amp<br>(V)<br>MAX | Standby Current<br>I <sub>b</sub><br>@V <sub>WM</sub><br>(μA)<br>MAX | Capacitance<br>(f=1 MHz)<br>@0V<br>(pF)<br>TYP | Temperature Coefficient<br>of V <sub>BR</sub><br>α <sub>(VBR)</sub><br>mV/°C<br>MAX |    |    |
|--------------------------------------------------------------|-------------|----------------------------------------------------|-----------------------------------------------------------------------------|------------------------------------------------------------|----------------------------------------------------------------------|------------------------------------------------|-------------------------------------------------------------------------------------|----|----|
| <b>SOT-143 UNIDIRECTIONAL 300 W 8/20 μs CAPACITANCE 5 pF</b> |             |                                                    |                                                                             |                                                            |                                                                      |                                                |                                                                                     |    |    |
| 1                                                            | USB0403     | 3.3                                                | 4                                                                           | 8                                                          | 200                                                                  | 5                                              | -5                                                                                  |    |    |
| 1                                                            | USB0405     | 5.0                                                | 6                                                                           | 10.8                                                       | 20                                                                   | 5                                              | 1                                                                                   |    |    |
| 1                                                            | USB0412     | 12.0                                               | 13.3                                                                        | 19                                                         | 1                                                                    | 5                                              | 8                                                                                   |    |    |
| 1                                                            | USB0415     | 15.0                                               | 16.7                                                                        | 24                                                         | 1                                                                    | 5                                              | 11                                                                                  |    |    |
| 1                                                            | USB0424     | 24.0                                               | 26.7                                                                        | 43                                                         | 1                                                                    | 5                                              | 28                                                                                  |    |    |
| <b>SOT-143 BIDIRECTIONAL 300 W 8/20 μs CAPACITANCE 5 pF</b>  |             |                                                    |                                                                             |                                                            |                                                                      |                                                |                                                                                     |    |    |
| 2                                                            | USB0403C    | 3.3                                                | 4                                                                           | 8                                                          | 200                                                                  | 5                                              | -5                                                                                  |    |    |
| 2                                                            | USB0405C    | 5.0                                                | 6                                                                           | 10.8                                                       | 40                                                                   | 5                                              | 1                                                                                   |    |    |
| 2                                                            | USB0412C    | 12.0                                               | 13.3                                                                        | 19                                                         | 1                                                                    | 5                                              | 8                                                                                   |    |    |
| 2                                                            | USB0415C    | 15.0                                               | 16.7                                                                        | 24                                                         | 1                                                                    | 5                                              | 11                                                                                  |    |    |
| 2                                                            | USB0424C    | 24.0                                               | 26.7                                                                        | 43                                                         | 1                                                                    | 5                                              | 28                                                                                  |    |    |
| <b>SOT-143 UNIDIRECTIONAL 500 W 8/20 μs CAPACITANCE 3 pF</b> |             |                                                    |                                                                             |                                                            |                                                                      |                                                |                                                                                     |    |    |
| 1                                                            | USB50403    | 3.3                                                | 4                                                                           | 8                                                          | 200                                                                  | 3                                              | -5                                                                                  |    |    |
| 1                                                            | USB50405    | 5.0                                                | 6                                                                           | 10.8                                                       | 20                                                                   | 3                                              | 1                                                                                   |    |    |
| 1                                                            | USB50412    | 12.0                                               | 13.3                                                                        | 19                                                         | 1                                                                    | 3                                              | 8                                                                                   |    |    |
| 1                                                            | USB50415    | 15.0                                               | 16.7                                                                        | 24                                                         | 1                                                                    | 3                                              | 11                                                                                  |    |    |
| 1                                                            | USB50424    | 24.0                                               | 26.7                                                                        | 43                                                         | 1                                                                    | 3                                              | 28                                                                                  |    |    |
| <b>SOT-143 BIDIRECTIONAL 500 W 8/20 μs CAPACITANCE 3 pF</b>  |             |                                                    |                                                                             |                                                            |                                                                      |                                                |                                                                                     |    |    |
| 2                                                            | USB50403C   | 3.3                                                | 4                                                                           | 8                                                          | 200                                                                  | 3                                              | -5                                                                                  |    |    |
| 2                                                            | USB50405C   | 5.0                                                | 6                                                                           | 10.8                                                       | 40                                                                   | 3                                              | 1                                                                                   |    |    |
| 2                                                            | USB50412C   | 12.0                                               | 13.3                                                                        | 19                                                         | 1                                                                    | 3                                              | 8                                                                                   |    |    |
| 2                                                            | USB50415C   | 15.0                                               | 16.7                                                                        | 24                                                         | 1                                                                    | 3                                              | 11                                                                                  |    |    |
| 2                                                            | USB50424C   | 24.0                                               | 26.7                                                                        | 43                                                         | 1                                                                    | 3                                              | 28                                                                                  |    |    |
| <b>SOT-23 UNIDIRECTIONAL 300 W 8/20 μs CAPACITANCE 5 pF</b>  |             |                                                    |                                                                             |                                                            |                                                                      |                                                |                                                                                     |    |    |
| 3                                                            | SL03        | 3.3                                                | 4                                                                           | 8                                                          | 200                                                                  | 3                                              | -5                                                                                  |    |    |
| 3                                                            | SL05        | 5.0                                                | 6                                                                           | 10.8                                                       | 20                                                                   | 3                                              | 1                                                                                   |    |    |
| 3                                                            | SL12        | 12.0                                               | 13.3                                                                        | 19                                                         | 1                                                                    | 3                                              | 8                                                                                   |    |    |
| 3                                                            | SL15        | 15.0                                               | 16.7                                                                        | 24                                                         | 1                                                                    | 3                                              | 11                                                                                  |    |    |
| 3                                                            | SL24        | 24.0                                               | 26.7                                                                        | 43                                                         | 1                                                                    | 3                                              | 28                                                                                  |    |    |
| <b>SOT-23 UNIDIRECTIONAL OR BIDIRECTIONAL 300 W 8/20 μs</b>  |             |                                                    |                                                                             |                                                            |                                                                      |                                                |                                                                                     |    |    |
| 4                                                            | SM03        | 3.3                                                | 4                                                                           | 7                                                          | 125                                                                  | 800                                            | 400                                                                                 | -3 | -5 |
| 4                                                            | SM05        | 5.0                                                | 6                                                                           | 9.8                                                        | 20                                                                   | 600                                            | 300                                                                                 | 3  | 1  |
| 4                                                            | SM12        | 12.0                                               | 13.3                                                                        | 19                                                         | 1                                                                    | 185                                            | 93                                                                                  | 10 | 8  |
| 4                                                            | SM15        | 15.0                                               | 16.7                                                                        | 24                                                         | 1                                                                    | 140                                            | 70                                                                                  | 13 | 11 |
| 4                                                            | SM24        | 24.0                                               | 26.7                                                                        | 43                                                         | 1                                                                    | 88                                             | 44                                                                                  | 30 | 28 |
| 4                                                            | SM36        | 36.0                                               | 40                                                                          | 60                                                         | 1                                                                    | 78                                             | 36                                                                                  | 37 | 35 |

Data sheets can be viewed at: [www.microsemi.com](http://www.microsemi.com)

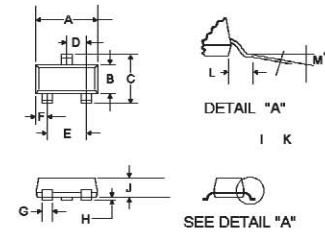

Fig 1

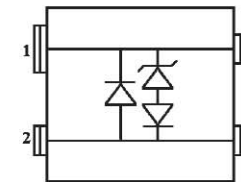

Fig 2

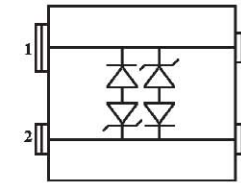

Fig 3

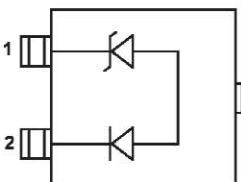
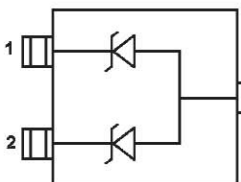
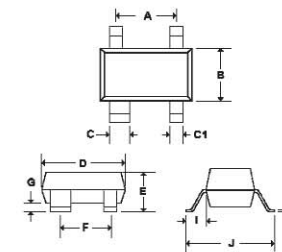

Fig 4



| DIM | INCHES |      | MILLIMETERS |       |
|-----|--------|------|-------------|-------|
|     | MIN    | MAX  | MIN         | MAX   |
| A   | .110   | .119 | 2.794       | 3.023 |
| B   | .047   | .055 | 1.194       | 1.397 |
| C   | .083   | .104 | 2.108       | 2.642 |
| D   | .035   | .040 | .889        | 1.016 |
| E   | .070   | .081 | 1.778       | 2.057 |
| F   | .017   | .024 | .432        | .610  |
| G   | .014   | .020 | .356        | .508  |
| H   | .0005  | .004 | .013        | .102  |
| J   | .034   | .040 | .864        | 1.016 |
| K   | .003   | .007 | .076        | .178  |
| L   | --     | .022 | --          | .559  |
| M   | --     | 8°   | --          | 8°    |



| DIM | INCHES |      | MILLIMETERS |       |
|-----|--------|------|-------------|-------|
|     | MIN    | MAX  | MIN         | MAX   |
| A   | .070   | .080 | 1.778       | 2.032 |
| B   | .047   | .055 | 1.194       | 1.397 |
| C   | .030   | .037 | .762        | .940  |
| C1  | .015   | .020 | .381        | .508  |
| D   | .110   | .119 | 2.794       | 3.023 |
| E   | .035   | .044 | .889        | 1.118 |
| F   | .071   | .079 | 1.803       | 2.007 |
| G   | .0006  | .006 | .015        | .152  |
| H   | .003   | .007 | .076        | .178  |
| I   | .018   | .023 | .457        | .584  |
| J   | .083   | .093 | 2.108       | 2.362 |

### Note

All devices provide board protection from transients caused by electrostatic discharge (ESD) as defined in IEC 1000-4-2, electrical fast transients (EFT) per IEC 1000-4-4 and secondary lightning.

**Protects**  
3.0/3.3 thru 24V  
Components

# TVSarray<sup>®</sup>

Series SOT-23 and SOT-143

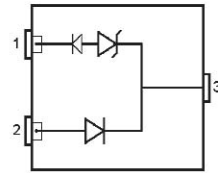

### SOT-23 SLVU2.8SK

- 400 W 8/20  $\mu$ s
- Unidirectional
- Protects 1 line
- Stand Off Voltage 2.8 V
- Capacitance Typ 5 pF Max 10 pF

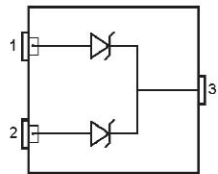

### SOT-23 MMBZ15VDLTI

- 40 W 10/1000  $\mu$ s
- Bidirectional
- Protects 1 line
- Stand Off Voltages

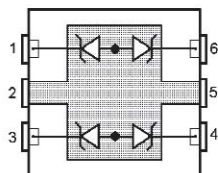

### SOT-23-6L SMSX

- 180 W 8/20  $\mu$ s
- Unidirectional
- Protects 4 lines
- Stand Off Voltages 5, 15, 24

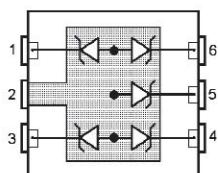

### SOT-23-6L SMSXC

- 180 W 8/20  $\mu$ s
- Bidirectional
- Protects 4 lines or five lines unidirectional
- Stand Off Voltages 5, 15, 24

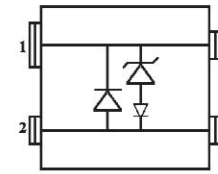

### SOT-143 SLVG2.8SK

- 400 W 8/20  $\mu$ s
- Unidirectional protects 1 line
- Stand Off Voltage 2.8 V
- Capacitance 50 pF
- Standby current 1  $\mu$ a Max

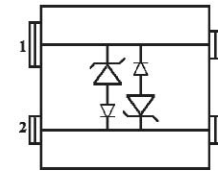

### SOT-143 SLVE2.8SK

- 400 W 8/20  $\mu$ s
- Bidirectional protects 1 line
- Stand Off Voltage 2.8 V
- Capacitance 100 pF
- Standby current 1  $\mu$ a Max

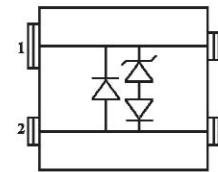

### SOT-143 USB0402.8SK

- 400 W 8/20  $\mu$ s
- Unidirectional protects 1 line
- Stand Off Voltage 2.8 V
- Capacitance 3 pF
- Standby current 0.1  $\mu$ a Max

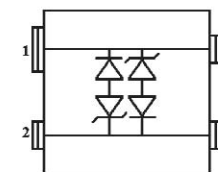

### SOT-143 USB0402.8CSK

- 400 W 8/20  $\mu$ s
- Bidirectional protects 1 line
- Stand Off Voltage 2.8 V
- Capacitance 3 pF
- Standby current 0.1  $\mu$ a Max



# Protecting USB Data I/O Ports

Computers operating with two-wire USB systems transfer data at up to 200 Mbs for peripherals. This speed is made possible by CMOS components that are inherently sensitive to damage from electrostatic discharge (ESD), a problem confirmed by the Reliability Analysis Center in Rome, NY.



Figure 1 illustrates the USB50805C's electrical configuration. A single wire protector consists of two antiparallel devices in parallel.

The low capacitance feature is achieved by placing a high voltage rectifier chip of inherently low capacitance in series with the high capacitance low voltage

TVS chip. This combination suppresses only in one direction, making it necessary to place a second set of identical chips antiparallel to the first. Pins 1 & 2 must be tied together, as well as pins 7 & 8, to create a single bidirectional protector. Pins 3 & 4 form a common tie point along with 5 & 6, creating the second protector. Each TVS for a single communication wire has a capacitance of <math><3\text{ pF}</math> per line, substantially lower than possible with MOV technology.

Since the TVS is electrically bidirectional, either end of the pair can be connected to the protected line, providing the designer with flexible layout options. Two alternatives are shown in Figure 2.

- Capacitance of <math><3\text{ pF}</math> per line
- Nanosecond response
- Low parasitic inductance
- 300W peak pulse power @ 8/20 us
- Standby current <math><50\text{ nA}</math> @ 3.5 V

Note that direct connective paths of the traces are taken to the suppressor mounting pads, to minimize parasitic inductance in the surge current conductive path. This minimizes  $L(di/dt)$  effects as described in MicroNote Number 111. Each trace effectively has a Kelvin contact with the pad to which the TVS is connected.

Nominal inductive values of a PCB trace are approximately 20 nH/cm. This value may seem small, but an apparent "short length" of trace may be sufficient to produce significant  $L(di/dt)$  effects with fast rise-time ESD spikes.

For optimum performance, the ground termination pads should be connected directly to a ground plane on the board. A single trace ground conductor will not provide an effective path for fast rise-time transient events including ESD due to parasitic inductance.

Mount the TVS as close as possible to the I/O socket to reduce radiation originating from the transient as it is routed to ground.

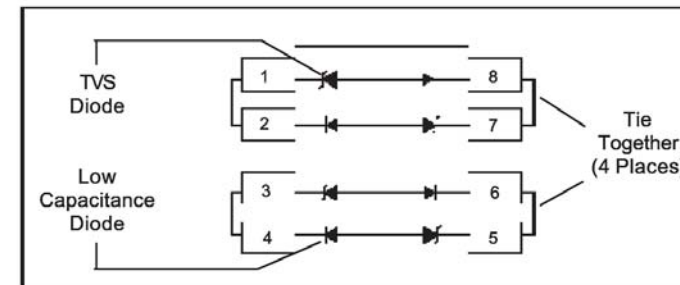

Figure 1. Electrical Configuration.

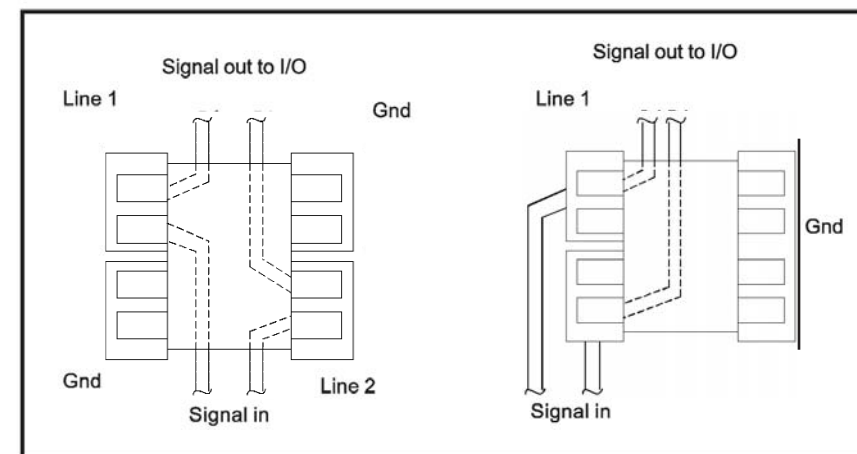

Figure 2. Options for Board Mounting on Four Pads.

# LoCAP

## TVS Devices

Transient voltage protection across high data rate and RF lines

Early communications systems, with RS-232 ambling along at 19.6 kbps, were compatible with the capacitance of silicon TVS devices of that era. No significant signal attenuation was encountered because of their relatively low data transmission rates.

Today, with signals pushing into the Gbps range, TVS capacitance becomes a significant issue. Designers face the real challenge of finding protective devices compatible with high data rates such as those used on Universal Serial Bus lines up to 200 Mbps, IEEE-1394 (FireWire) at >100 Mbps, and CATV rates up to 1 GHz.

To meet this need, Microsemi has developed a broad range of LoCAP™ low capacitance silicon TVS devices designed specifically to prevent signal attenuation across data lines operating at these high transmission rates.

Electrostatic discharge (ESD) is the most significant threat, with induced lightning and load switching also common offenders behind the failures of I/O port components. Often overlooked is the possibility of latch-up or latent failures that occur weeks, even months, after the actual electrical overstress event.

### Designing LoCAP TVS Devices

Low capacitance is achieved for high data rates by inserting a high voltage rectifier chip (of inherently low capacitance) in series with, and in opposite polarity to, the TVS chip. Selection of the proper diode chip provides the required capacitance and sufficient cross sectional area to withstand the rated surge current.

Higher powered LoCAP TVS devices are inherently higher in capacitance from the larger chip sizes required to withstand the associated higher surge currents. Rules for diode capacitance reduction are basically those governing capacitors in series and parallel as shown in Figure 1.

High doping levels of the starting silicon material produces lower breakdown voltage TVS devices. Figure 1a illustrates typical capacitance values for a 500 W, 10 V TVS and with an appropriate rectifier chip for fabricating a 10 V low capacitance silicon TVS, while figure 2b illustrates their polarity relationship.

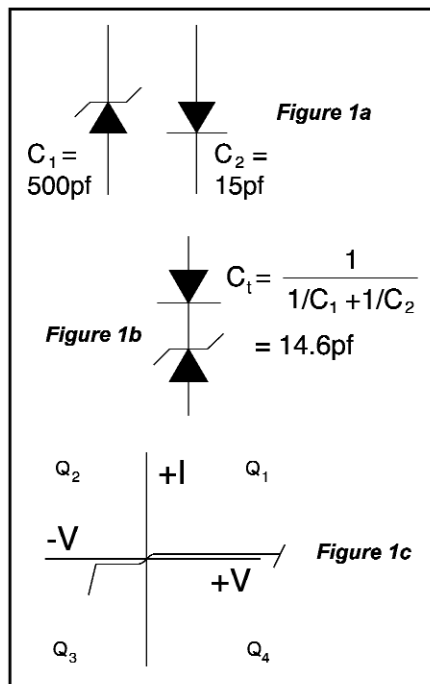

Figure 1. Capacitance of TVS & Low Capacitance Rectifier Chips

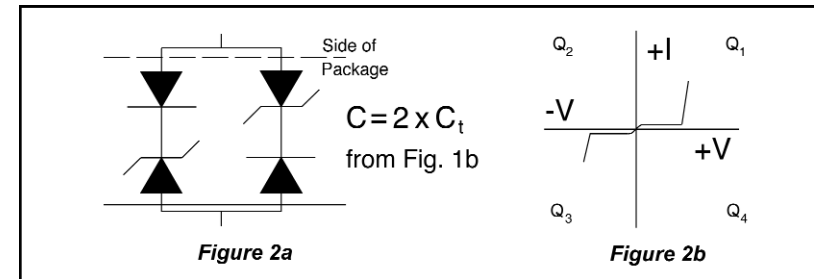

Figure 2. Configuration of Microsemi's Bidirectional LoCap TVS

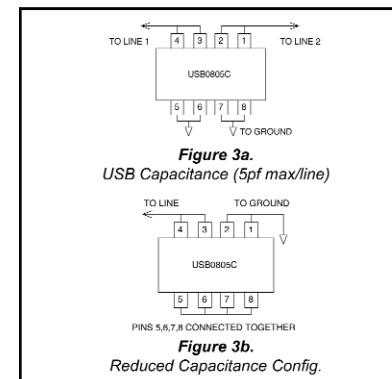
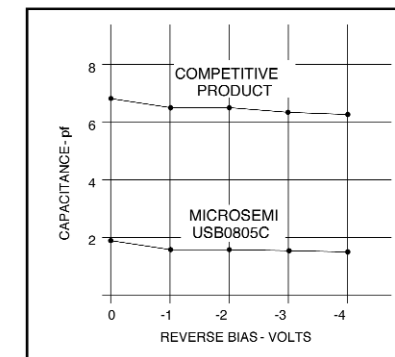

Figure 3. Configuration of USB50805C



With more than an order of magnitude between the value of the series capacitance of the two chips, the total value is calculated to be slightly less than the smallest value, which is 14.6 pf in this example.

Figure 1c illustrates the V/I curve of the low capacitance rectifier chip combined with the TVS. Note that clamping protection is provided in only one direction, the third quadrant, with the first quadrant containing the reverse breakdown of the rectifier. Hence, it becomes necessary to place two rectifier/TVS strings in antiparallel to form the functionally bidirectional LoCAP, low capacitance element shown in Figure 2a.

Figure 2b illustrates the resultant electrical characteristics of the symmetrical V/I curve with clamping protection for both positive and negative transient voltage excursions.

The bidirectional LoCAP TVS is bilaterally symmetrical, having the same electrical characteristics in both the 1<sup>st</sup> and 3<sup>rd</sup> quadrants, as show in Figure 2b. This feature accommodates signals having both positive and negative excursions. Most LoCAP devices connect the "legs" externally to the package.

Microsemi offers the broadest line of LoCap silicon TVS devices in the industry, including those shown in Table A. Microsemi lists its capacitance values very conservatively. For example, the SAC and SMBJSAC series typically measure 13-17 pf and the USB Series typically ranges from 1.8-2.0 pf. The USB50805C (5V operating voltage) is configured in Figure 3b to reduce capacitance to approximately 1 pf across rf amplifier lines of up to 750 MHz, with no noticeable attenuation.



Elements of the USB0805C are wired in series to reduce capacitance by one-half, normally about 1 pf. Figure 4 depicts capacitance values for the Microsemi USB50805C configured in Figure 3a, from 0V through -4 V bias. Note how the Microsemi TVS compares with a competitive device: the competitive suppressor's capacitance is 2 pf over while the Microsemi device about 3 pf under the maximum limit of 5 pf per protected line. *These devices have identical data sheet specifications!*

## Applications

Most rf and data I/O signal inputs are sensitive to electrical overstress. During Operation *Desert Watch* inputs on solid state receivers reportedly failed at an alarming rate. This was attributed to static electricity generated when wind-blown desert sand blasted external antennas.

For data rates >50 kbs, low capacitance TVS devices are often needed to minimize signal attenuation while simultaneously providing overvoltage protection. Early standards calling out maximum bit rates no longer apply as maximum operating limits. RS-232 originally specified a maximum bit rate of 19.6 kbs, but some users are demanding (and getting) operating capability up to 300 kbs.

Typical data transmission/reception specifications:

| Signal Type    | Data Rate      |
|----------------|----------------|
| EIA — 232      | 19.6 kbs       |
| EIA — 422      | 10 Mbs         |
| EIA — 423      | 100 kbs        |
| EIA — 485      | 5 Mbs          |
| USB            | 200 Mbs        |
| Telecom/modems | 60 kbs/1.5 Mbs |
| IEEE — 1394    | 125 Mbs        |
| CATV           | up to 1 Gbs    |

The maximum rates listed here represent minimum load capacitance using 10 meters or less of interconnecting cable. (Speed is reduced significantly as cable length increases.) IEEE — 485 is subject to a number of boundary conditions governing its maximum data rate. USB runs from 1.5 to 200 Mbs depending upon the signal type transmitted. Cable lengths are normally less than 3 meters. Computer modems normally transmit at rates of 60 kbs or 1.5 Mbs, depending upon the modem's capability.

To illustrate the advantages of speed, a computer program that requires 10 minutes to download at 60 kbs, is completed in less than a half minute at 1.5 Mbs.

Applications for IEEE1394 transmission are still sufficiently rare that specific protection requirements have yet to be

**Table A**

| Device Series | Surge Power | Waveform   | Capacitance | Package      | Voltage Range |
|---------------|-------------|------------|-------------|--------------|---------------|
| LC6.5         | 1.5KW       | 10/1000 µs | 50pf        | DO-13        | 6.5 V - 170 V |
| LCE6.5        | 1.5KW       |            | 50pf        | Axial lead   | 6.5 V - 170 V |
| SAC5          | 500W        |            | 25pf        | Axial lead   | 5.0 V - 50 V  |
| SMCJLCE5.0    | 1.5KW       |            | 50pf        | SMT/DO-214AB | 5.0 V - 50 V  |
| SMBJSAC5.0    | 500W        |            | 25pf        | SMT/DO-214AA | 5.0 V - 50 V  |
| SMP6LC6.5     | 600W        |            | 30pf        | SO-16        | 6.5V          |
| SM8LC03       | 300W        | 8/20 µs    | 25pf        | SO-8         | 3.0 V- 24 V   |
| SM16LC03      | 300W        |            | 25pf        | SO-16        | 3.0 V - 24 V  |
| USB0403C      | 300W        |            | 5pf         | SO-4         | 3.0V - 24 V   |
| USB0803C      | 300W        |            | 5pf         | SO-8         | 3.0V - 24 V   |

determined. Internet access offered on CATV at about 100 Mbs is almost two orders of magnitude faster than the fastest telecom modems. Some computers in development are said to operate well into the Gbps range. Their sensitive interfacing I/O ports will require external protection for their sub-micron on-chip components.

## Protection Guidelines

Table B provides suggested Microsemi TVS devices for common applications having a range of upper limit speeds from 250 kb to 1 Gb. Successful application also depends upon the amount of signal distortion a system will tolerate. In harsh lightning environments, a gas discharge tube may also be required to provide high surge withstand capability.

## Summary

High internal capacitance is inherent in low voltage TVS devices due to the low resistivity silicon substrate required to produce low voltage breakdown pn junctions. This high capacitance is due to the very thin

region of space charge in low voltage pn junctions. Effective capacitance can be reduced by orders of magnitude by placing a rectifier chip, which inherently has low capacitance, in series but in opposite polarity with the TVS chip. Microsemi offers the broadest selection of these LoCap silicon TVS devices for virtually all applications having data rates up through 1 Gbps.



**Table B**

| UPPER LIMITS | PRIMARY THREATS |             |           | RECOMMENDED TVS | SURGE  |
|--------------|-----------------|-------------|-----------|-----------------|--------|
|              | ESD             | Load Switch | Lightning | Family          | Power  |
| 250 kb       | *               | *           | *         | LC6.5           | 1.5 kW |
| 250 kb       | *               | *           | *         | LCE6.5          | 1.5 kW |
| 250 kb       | *               | *           | *         | SMCJLC5.0       | 1.5 kW |
| 1.5 Mb       | *               | *           | *         | SAC5.0          | 600 W  |
| 1.5 Mb       | *               | *           | *         | SMBJSAC5.0      | 600 W  |
| 1.5 Mb       | *               | *           | *         | SMP6LC6.5       | 600 W  |
| 5 Mb         | *               |             |           | SM8LC03         | 300 W  |
| 5 Mb         | *               |             |           | SM16LC03C       | 300 W  |
| 12.5 Mb      | *               |             |           | USB0403C        | 300 W  |
| 12.5 Mb      | *               |             |           | USB0803C        | 300 W  |
| 125 Mb       | *               |             |           | USB0403C        | 300 W  |
| 125 Mb       | *               |             |           | USB0403C        | 300W   |
| 1 Gb         | *               |             |           | USB0803C (1)    | 300 W  |

(1) only when both elements of the TVS are in series for reduced capacitance figure 3b.

# TVSarray®

## Cross Reference

| Part Number | Microsemi TVSArray® | Package   | Part Number | Microsemi TVSArray® | Package   | Part Number | Microsemi TVSArray® | Package | Part Number  | Microsemi TVSArray® | Package  |
|-------------|---------------------|-----------|-------------|---------------------|-----------|-------------|---------------------|---------|--------------|---------------------|----------|
| CSPEMI204   | <b>LX7206</b>       | FLIP CHIP | PSMDA05C-4  | <b>SMDA05C-4</b>    | SO-8      | SM16LC05    | <b>SM16LC05</b>     | SO-16   | SMDA24C      | <b>SMDA24C</b>      | SO-8     |
| CSPEMI205   | <b>LX7205</b>       | FLIP CHIP | PSMDA12C-4  | <b>SMDA12C-4</b>    | SO-8      | SM16LC05C   | <b>SM16LC05C</b>    | SO-16   | SMDA24C-4    | <b>SMDA24C-4</b>    | SO-8     |
| Eclamp2340C | <b>LX7207</b>       | FLIP CHIP | PSMDA15C-4  | <b>SMDA15C-4</b>    | SO-8      | SM16LC12    | <b>SM16LC12</b>     | SO-16   | SMDA24C-5    | <b>SMDA24C-5</b>    | SO-8     |
| ESDA6V1L    | <b>SM5.0</b>        | SOT-23    | PSMDA24C-4  | <b>SMDA24C-4</b>    | SO-8      | SM16LC12C   | <b>SM16LC12C</b>    | SO-16   | SMDA24C-7    | <b>SMDA24C-7</b>    | SO-8     |
| ESDA6V1SC6  | <b>SMS5.0</b>       | SOT23-6   | PSOT03      | <b>SL03</b>         | SOT-23    | SM16LC15    | <b>SM16LC15</b>     | SO-16   | SMDA24C-8    | <b>SMDA24C-8</b>    | SO-14    |
| ESDA6V1U1   | <b>SMDA05-6</b>     | SO-8      | PSOT03C     | <b>SM03</b>         | SOT-23    | SM16LC15C   | <b>SM16LC15C</b>    | SO-16   | SMDB05       | <b>SMDB05C</b>      | SO-8     |
| ESDA6W1U1   | <b>SMDA05C-5</b>    | SO-8      | PSOT05      | <b>SL05</b>         | SOT-23    | SM16LC24    | <b>SM16LC24</b>     | SO-16   | SMDB12       | <b>SMDB12</b>       | SO-8     |
| ESDA6V1B1   | <b>SMDA05C-7</b>    | SO-8      | PSOT05C     | <b>SM05</b>         | SOT-23    | SM16LC24C   | <b>SM16LC24C</b>    | SO-16   | SMDB12C      | <b>SMDB12C</b>      | SO-8     |
| ESDA25B1    | <b>SMDA24C-7</b>    | SO-8      | PSOT12      | <b>SL12</b>         | SOT-23    | SM24        | <b>SM24</b>         | SOT-23  | SMDB15       | <b>SMDB15</b>       | SO-8     |
| ESDA25B2    | <b>SMDA24C-8</b>    | SO-14     | PSOT12C     | <b>SM12</b>         | SOT-23    | SM36        | <b>SM36</b>         | SOT-23  | SMDB15C      | <b>SMDB15C</b>      | SO-8     |
| ITA6V5B1    | <b>SMDA05C-4-2</b>  | SO-8      | PSOT15      | <b>SL15</b>         | SOT-23    | SM8LC05     | <b>SM8LC05</b>      | SO-8    | SMDB24       | <b>SMDB24</b>       | SO-8     |
| ITA18B1     | <b>SMDA15C-4-2</b>  | SO-8      | PSOT15C     | <b>SM15</b>         | SOT-23    | SM8LC12     | <b>SM8LC12</b>      | SO-8    | SMDB24C      | <b>SMDB24C</b>      | SO-8     |
| ITA18C1     | <b>SMDA15C-4-2</b>  | SO-8      | PSOT24      | <b>SL24</b>         | SOT-23    | SM8LC15     | <b>SM8LC15</b>      | SO-8    | SMP6LC5.0-2P | <b>SMP6LC05</b>     | SO-16    |
| ITA25B1     | <b>SMDA24C-4-2</b>  | SO-8      | PSOT24C     | <b>SM24</b>         | SOT-23    | SM8LC24     | <b>SM8LC24</b>      | SO-8    | SMP6LC6.5-2P | <b>SMP6LC6.5</b>    | SO-16    |
| ITA25C1     | <b>SMDA24C-4-2</b>  | SO-8      | SD05        | <b>SD05</b>         | SOD-323   | SMDA03C-8   | <b>SMDA03C-8</b>    | SO-14   | SMP6LC12-2P  | <b>SMP6LC12</b>     | SO-16    |
| ITA6V1U1    | <b>SMDA05-6</b>     | SO-8      | SD05C       | <b>LX7150</b>       | SOD-323   | SMDA05      | <b>SMDA05</b>       | SO-8    | SMS05        | <b>SMS05</b>        | SOT-23-6 |
| LC01-6      | <b>LC01-6</b>       | SO-16W    | SD12        | <b>SD12</b>         | SOD-323   | SMDA05-6    | <b>SMDA05-6</b>     | SO-8    | SMS05C       | <b>SMS05C</b>       | SOT-23-6 |
| LCDxx       | <b>SM16LCxx</b>     | SO-16     | SFC2280-10  | <b>LX7205</b>       | FLIP CHIP | SMDA05C     | <b>SMDA05C</b>      | SO-8    | SR05         | <b>SRLC05</b>       | SOT-143  |
| LCDAxxC     | <b>USB508xxC</b>    | SO-8      | SFC2280-68  | <b>LX7206</b>       | FLIP CHIP | SMDA05C-4   | <b>SMDA05C-4</b>    | SO-8    | SRDA70-4     | <b>SRDA70-4</b>     | SO-8     |
| LCDAxxC-1   | <b>USB504xxC</b>    | SOT-143   | SL05        | <b>SL05</b>         | SOT-23    | SMDA05C-5   | <b>SMDA05C-5</b>    | SO-8    | STF201       | <b>LX7201</b>       | SOT-23-6 |
| LCDAxxC-8   | <b>SM16LCxxC</b>    | SO-16     | SL12        | <b>SL12</b>         | SOT-23    | SMDA05C-7   | <b>SMDA05C-7</b>    | SO-8    | STF202       | <b>LX7202</b>       | SOT-23-6 |
| PLCDA03     | <b>USB50803C</b>    | SO-8      | SL15        | <b>SL15</b>         | SOT-23    | SMDA05C-8   | <b>SMDA05C-8</b>    | SO-14   | STF203       | <b>LX7203</b>       | SC70-6   |
| PLCDA03-1   | <b>USB50403C</b>    | SOT-143   | SL24        | <b>SL24</b>         | SOT-23    | SMDA12      | <b>SMDA12</b>       | SO-8    | USB6B1       | <b>USB6B1</b>       | SO-8     |
| PLCDA05     | <b>USB50805C</b>    | SO-8      | SLVU2.8     | <b>SLVU2.8K</b>     | SOT-23    | SMDA12C     | <b>SMDA12C</b>      | SO-8    |              |                     |          |
| PLCDA05-1   | <b>USB50405C</b>    | SOT-143   | SLVU2.8-4   | <b>SLVU2.8K-4</b>   | SO-8      | SMDA12C-4   | <b>SMDA12C-4</b>    | SO-8    |              |                     |          |
| PLCDA12     | <b>USB50812C</b>    | SO-8      | SM05        | <b>SM05</b>         | SOT-23    | SMDA12C-5   | <b>SMDA12C-5</b>    | SO-8    |              |                     |          |
| PLCDA12-1   | <b>USB50412C</b>    | SOT-143   | SM12        | <b>SM12</b>         | SOT-23    | SMDA12C-7   | <b>SMDA12C-7</b>    | SO-8    |              |                     |          |
| PLCDA15     | <b>USB50815C</b>    | SO-8      | SM14LV1.7C  | <b>SM14LV1.7C</b>   | SO-14     | SMDA12C-8   | <b>SMDA12C-8</b>    | SO-14   |              |                     |          |
| PLCDA15-1   | <b>USB50415C</b>    | SOT-143   | SM14M24C    | <b>SMDA24C-8</b>    | SO-14     | SMDA15      | <b>SMDA15</b>       | SO-8    |              |                     |          |
| PLCDA24     | <b>USB50824C</b>    | SO-8      | SM15        | <b>SM15</b>         | SOT-23    | SMDA15C     | <b>SMDA15C</b>      | SO-8    |              |                     |          |
| PLCDA24-1   | <b>USB50424C</b>    | SOT-143   | SM14M05C    | <b>SMDA05C-8</b>    | SO-14     | SMDA15C-4   | <b>SMDA15C-4</b>    | SO-8    |              |                     |          |
| PLC496      | <b>MLC496</b>       | SO-8      | SM14M12C    | <b>SMDA12C-8</b>    | SO-14     | SMDA15C-5   | <b>SMDA15C-5</b>    | SO-8    |              |                     |          |
| PSM05       | <b>SMS05</b>        | SOT-23-6  | SM14M15C    | <b>SMDA15C-8</b>    | SO-14     | SMDA15C-7   | <b>SMDA15C-7</b>    | SO-8    |              |                     |          |
| PSMS05C     | <b>SMS05C</b>       | SOT-23-6  | SM14M24C    | <b>SMDA24C-8</b>    | SO-14     | SMDA15C-8   | <b>SMDA15C-8</b>    | SO-14   |              |                     |          |
| PSMDA05-6   | <b>SMDA05-6</b>     | SO-8      | SM15        | <b>SM15</b>         | SOT-23    | SMDA24      | <b>SMDA24</b>       | SO-8    |              |                     |          |

Revision 7 1/1/2006

For RoHS compliance, add "e3" suffix to existing part number: ie: SMDA05Ce3

xx = 03, 05, 12, 15, 18, 24, 36 standard voltages

**Note:** Other voltages available



Protection Products  
8700 E. Thomas Road  
Scottsdale, AZ 85251  
Phone: (480) 941-6300  
Fax: (480) 947-1503

TVS Array  
Applications Engineering  
(480) 941-6524  
(480) 941-6433

[www.microsemi.com](http://www.microsemi.com)

