

AVX Film Chip Capacitors



Version 13.12

AVX
A KYOCERA GROUP COMPANY

Contents

- Total Quality Policy Film SMD Capacitors. 2**
- Characteristics of Film SMD Capacitors. 3**
- Typical Selection Guide 4**
- Applications Guide 5**
- How to Order, Dimensions and Construction. 6**
- Electrical Properties and Test Conditions – CB Series 7**
- AECQ Documentation – CB Series 8**
- Packaging – CB Series 9**
- CB: PET-HT Dielectric – Lead Free Version. 10-19**
 - General Description. 10
 - Capacitance Values & Nominal Voltages 11-14
 - Mounting and Soldering Recommendations. 15
 - Electrical Characteristics versus Temperature and Frequency 16
 - RMS Voltage and Current versus Frequency. 17-18
 - RoHS 19
- CB: PEN Dielectric – Lead Free Version 20-38**
 - General Description. 20
 - Capacitance Values & Nominal Voltages 21-33
 - Mounting and Soldering Recommendations. 34
 - Electrical Characteristics versus Temperature and Frequency 35
 - RMS Voltage and Current versus Frequency. 36-37
 - RoHS 38
- CB: PPS Dielectric – Lead Free Version. 39-46**
 - General Description. 39
 - Capacitance Values & Nominal Voltages 40-42
 - Mounting and Soldering Recommendations. 43
 - Electrical Characteristics versus Temperature and Frequency 44
 - RMS Voltage and Current versus Frequency 45
 - RoHS 46
- CL: High Surge Voltage SMD Film Capacitors – Lead Free Version ADSL 47-49**
 - General Description. 47
 - Capacitance Values & Nominal Voltages. 48
 - Mounting and Soldering Recommendations. 49
 - RoHS 50

Film Chip Capacitors



Total Quality Policy Film SMD Capacitors



ISO/TS 16949
TS 95138

QUALITY

AVX, with AVX Sales and Marketing support, will be recognized by our customers as a “preferred” supplier for the quality and reliability of our products and services.

AVX has adopted a Quality policy based on continuous improvement, the satisfaction of our customers, collaborators, partners and shareholders.

The objectives and measures are:

- To satisfy the customer's needs and requirements by supplying competitive and reliable products with:
 - zero defect, zero claim
 - 100 % on time delivery.
- To control all processes and improve performance:
 - maximize productivity and yield,
 - reduce non quality cost,
 - monitor process indicators.
- To manage this policy, AVX promotes:
 - empowerment and responsibility of all the staff,
 - involvement of our suppliers and partners,
 - a Quality Management System meeting ISO 9001, ISO/TS 16949 standards, customers and AVX requirements

Quality is measured by the level of our customer's satisfaction.

ENVIRONMENTAL



Protecting the environment is becoming more and more necessary every day. Therefore, this is a duty of the Company to its employees, neighbors customers and the next generations.

AVX Policy is implemented with an environmental management system according to ISO 14001 standard and international standards for the design of the film chips.

RELIABILITY

The reliability of film chips components is measured by accelerated testing methods which meet international standards such as CECC, CEI AEC Q200 and all customer specific requirements.

After initial qualification, we perform periodical accelerated tests to assure to our customer and their application the level of reliability required (Failure In Time, lambda).

Film Chip Capacitors



Characteristics of Film SMD Capacitors





	PET-HT (MKT)	PEN (MKN)	PPS (MKN)	NPO	X7R	Tantalum
Operating temperature (°C)	-55/125	-55/125	-55/140	-55/125	-55/125	-55/125
ΔC/C with temperature (%)	-6/8	-2/3	±1.5	±1	±15	±10
DC voltage coefficient (%)	no.	no.	no.	no.	-60	no.
ΔC aging rate (%/h dec.)	negl.	negl.	negl.	negl.	1	n.a.
Dissipation factor (%) 1 kHz 10 kHz 100 kHz	1 1.5 3.0	1 1.5 3.0	0.5 0.25 0.5	0.10 0.10 0.10	2.5	4 to 6
IR (MΩ. μF) 25°C 85°C	10000 1000	5000 1000	1000 1000	10000 1000	1000 500	100000 1000
Dielectric absorption (%)	0.5	1	0.05	0.6	2.5	n.a.
Capacitance range from (pF) to (μF)	1000 4.7	1000 4.7	1000 0.18	10 0.047	100 4.7	100000 1000
Capacitance tolerance (±%)	5 10 20	5 10 20	2 5 10	1 5 10	5 10 20	10 20
Self-healing	yes	yes	no	no	no	no
Typical failure mode	open	open	open	short	short	short
Reliability	high	high	high	high	moderate	high
Piezoelectric effect	no	no	no	no	yes	no
Resistance to thermal and mechanical shock	high	high	high	moderate to low*	moderate to low*	high
Non-linear distortion (3 rd harmonic)	very low	very low	very low	low	high	n.a.
Polarity	no	no	no	no	no	yes

* possible cracking in the MLCC body

Film Chip Capacitors



Typical Selection Guide

Presentation	Type	Dielectric	Size	Nominal Voltage VR-(V)	Capacitance Range (C _R)	Tolerance on C _R (Series)
SMD 	CB	PET-HT	2220	63...630	10nF... 1μF	±5% ±10%
			2824	63...630	22nF...1.5μF	
			4030	63...630	47nF...2.2μF	
			5040	100...630	82nF...2.2μF	
			6054	63...630	120nF...4.7μF	
SMD 	CB	PEN	1206	25...100	1nF...22nF	±5% ±10%
			1210	25...100	12nF...100nF	
			1812	63...400	1nF...220nF	
			2220	63...400	5.6nF.. 680nF	
			2824	63...400	22nF...820nF	
			4030	63...630	47nF.. 2.2μF	
			5040	63...630	82nF.. 2.7μF	
			6054	63...630	180nF.. 4.7μF	
SMD 	CB	PPS	1206	16...50	1nF...39nF	±2% ±5% ±10%
			1210	16...50	12nF...100nF	
			1812	16...50	47nF...150nF	
 SMD 	CL	PEN	2824	630V	6.8nF....18nF	±5% ±10%
			2840	630V	22nF....33nF	
SMD with Lead	CA	PET-HT-PEN & PPS	UPON REQUEST			

Film Chip Capacitors



Applications Guide

Market Selector	Application	Short Description	Selection Criteria	Typical AVX SMD Film Solution
T E L E C O M	ADSL (XDSL) Network devices	Regarding Broadband Access systems (DSLAM, Access Hub...), for filtering stage and/or splitters, due to high speed communication, telecom standards require very accurate filters and even surge voltage pulse capability	<ul style="list-style-type: none"> • Good filtering capability (Low ESR&ESL) • Trend is SMD preferred • Specific size can be offered • Surge voltage capability (CT) 	CB or CL Series in Polyester 10nF to 100nF 250 to 630Vdc
	Modem - Gateway ADSL	Due to high speed communication, telecom standards require very accurate filters. Film chip is the most convenient solution.	<ul style="list-style-type: none"> • Good filtering capability (Low ESR&ESL) • Capacitance stability • SMD preferred • Specific size can be offered 	CB Series in Polyester 10nF to 470nF / 63Vdc to 400Vdc in PPS 10nF to 100 nF / 16Vdc to 50Vdc
	Phone, DECT Handset, fax	Film chips used in ringing circuits as a tip & ring device	<ul style="list-style-type: none"> • Capacitance stability • Good filtering capability (Low ESR&ESL) • SMD version 	CB Series in Polyester 470nF to 1 µF / 63Vdc to 250Vdc
	Wireless Communication (GSM, Bluetooth systems...)	PPS Film chip is a convenient alternative to NPO ceramic for time constant, filtering or oscillation and resonance function within the PLL circuit	<ul style="list-style-type: none"> • Capacitance stability • Tight tolerance (2%) • Good filtering capability (Low ESR&ESL) • SMD version needed 	CB Series in PPS 1.5nF to 33nF 16Vdc
	Base station	Film chips can be used as an interesting solution for filtering device	<ul style="list-style-type: none"> • Capacitance stability • Good filtering capability (Low ESR&ESL) • SMD version 	CB Series in Polyester 10nF to 470nF 63Vdc to 250Vdc
A U T O M O T I V E	Electronic Fuel Injection Calculator (ECU/EMU)	Film chips used in differential amplifier which processes information from the engine speed sensors	<ul style="list-style-type: none"> • Capacitance stability • Tight Tol and low DF • SMD required <ul style="list-style-type: none"> • Open failure mode • Harsh conditions 	CB Series in Polyester 10nF to 1µF 63Vdc
	HID Headlamp system	For integration reason, Film caps in SMD version are preferred to be used in HID modules at 2 different stages : Ballast (DC/DC convertor) and Lamp Ignition	<ul style="list-style-type: none"> • Good filtering capability (Low ESR&ESL) • Trend is SMD preferred • Specific size can be offered • Surge voltage capability (CT) 	CB or CL Series in Polyester 70nF to 1.5µF 250 to 630Vdc
	Safety Airbag/SB tensioners	Film chip can be part of the control circuit of the ignition system	<ul style="list-style-type: none"> • Capacitance stability • Specific size can be offered • SMD required <ul style="list-style-type: none"> • Open failure mode • Harsh conditions 	CB Series in Polyester 330nF to 680nF 63Vdc
	DC motors noise suppression	Film chip can be integrated into DC motors modules for wipers or window winder for high frequency noise suppression	<ul style="list-style-type: none"> • Capacitance stability • Good filtering capability (Low ESR&ESL) • Harsh conditions <ul style="list-style-type: none"> • Open failure mode • SMD required 	CB Series in Polyester 10nF to 2.2µF 63Vdc
	Car Audio systems	Usually, Film caps technology is well appreciated in audio systems for filtering and especially when it comes to automotive applications	<ul style="list-style-type: none"> • Capacitance stability • Tight Tol and low DF • SMD required <ul style="list-style-type: none"> • Open failure mode • No piezoelectric effect 	CB Series in Polyester 10nF to 1µF 63Vdc
	"Infotainment applications"	For integration reason, Film caps in SMD version could be used in different application stages as backlight circuits, car amplifiers or PLL for navigation systems	<ul style="list-style-type: none"> • Good filtering capability (Low ESR&ESL) • Capacitance stability • Specific size can be offered • SMD preferred 	CB Series in Polyester 10nF to 470nF / 63Vdc to 400Vdc in PPS 10nF to 100nF / 16Vdc to 50Vdc
I N D U S T R I A L	DC/DC convertor	Film chips used in the input filtering stage for high density modular power supplies	<ul style="list-style-type: none"> • Capacitance stability • Good filtering capability (Low ESR&ESL) • SMD version <ul style="list-style-type: none"> • Open failure mode 	CB Series in Polyester 1µF to 4.7µF 100Vdc
	Electronic Ballast	Where miniaturization is required SMD version of Film capacitors can be used for usual interference suppression and filtering functions	<ul style="list-style-type: none"> • Capacitance stability • Good filtering capability (Low ESR&ESL) • SMD version <ul style="list-style-type: none"> • Open failure mode 	CB Series in Polyester 10nF to 1µF 63Vdc to 400Vdc
	Industrial switch	Film chip could be the suitable solution for interference suppression function as it could survive peak voltage requirement without protection device.	<ul style="list-style-type: none"> • Capacitance stability • Good filtering capability (Low ESR&ESL) • SMD version <ul style="list-style-type: none"> • Open failure mode 	CB Series in Polyester 47nF to 470nF 250Vdc to 630Vdc
	Smoke detector	Where miniaturization is required SMD version of Film capacitors can be used for usual filtering functions	<ul style="list-style-type: none"> • Good filtering capability (Low ESR&ESL) • Capacitance stability • Specific size can be offered • SMD preferred 	CB Series in Polyester 100nF to 2.2µF 63Vdc to 250Vdc
	Industrial circuit breaker	PPS Film chip is a convenient alternative to NPO ceramic for filtering circuit stage	<ul style="list-style-type: none"> • Capacitance stability • Good filtering capability (Low ESR&ESL) • SMD version needed <ul style="list-style-type: none"> • Tight tolerance (2%) 	CB Series in PPS 1.0nF to 150nF 16Vdc to 50Vdc
C O N S U M E R & E D P	LCD Monitor	PPS Film chip is a convenient alternative to NPO ceramic in the inverter stage to drive the LCD display	<ul style="list-style-type: none"> • Capacitance stability • Good filtering capability (Low ESR&ESL) • SMD version needed <ul style="list-style-type: none"> • Tight tolerance (2%) 	CB Series in PPS 1.0nF to 150nF 16Vdc to 50Vdc
	Display Backlight Inverter (notebooks, PDA)	PPS Film chip is a convenient alternative to NPO ceramic in the inverter stage to drive the LCD display	<ul style="list-style-type: none"> • Capacitance stability • Good filtering capability (Low ESR&ESL) • SMD version needed <ul style="list-style-type: none"> • Tight tolerance (2%) 	CB Series in PPS or Polyester 47nF to 100nF 50Vdc
	Multimedia set top boxes	Where miniaturization is required SMD version of Film capacitors can be used for usual interference suppression and filtering functions	<ul style="list-style-type: none"> • Good filtering capability (Low ESR&ESL) • Capacitance stability • Specific size can be offered • SMD preferred 	CB Series in Polyester 10nF to 470nF / 63Vdc to 400Vdc in PPS 10nF to 100nF / 16Vdc to 50Vdc



Film Chip Capacitors

How to Order, Dimensions and Construction

HOW TO ORDER

CB	04	2	G	0104	K	--
Type	Size	Dielectric	Voltage	Capacitance	Tolerance EIA Code	Suffix Packaging
CB: SMD Lead Free CL: ADSL SMD leadfree CA: SMD lead	01: 1206 02: 1210 03: 1812 04: 2220 05: 2824 95: 2840 16: 4030 17: 5040 18: 6054	2 = PET-HT 8 = PPS 7 = PEN	B = 16V C = 25V D = 50/63V E = 100V G = 250V I = 400V K = 630V	1st digit: 0 2nd & 3rd: the 2nd significant figures of the capacitance value. 4th digit: the number of zeros to be added to the capacitance value.	G ⁽¹⁾ = 2% J = 5% K = 10%	-- = bulk BA = tape & reel diameter: 180mm BC = tape & reel diameter: 330mm

Example of an order: How to order a chip film PET-HT 100nF ±10% 250V bulk packaging.

⁽¹⁾: Tolerance G available only for PPS Series.

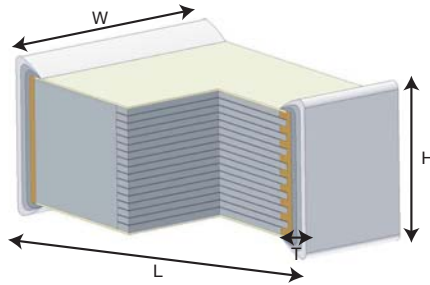

CASE DIMENSIONS: millimeters (inches)

Size Code	Equivalent size	Length (L)	Width (W)	Termination Return
01	1206	3.30±0.30 (0.130±0.012)	1.60±0.30 (0.063±0.012)	0.50±0.30 (0.020±0.012)
02	1210	3.30±0.30 (0.130±0.012)	2.50±0.30 (0.098±0.012)	0.50±0.30 (0.020±0.012)
03	1812 ⁽¹⁾	4.50±0.50 (0.177±0.020)	3.20±0.50 (0.126±0.020)	0.60±0.40 (0.024±0.157)
04	2220	5.80±0.50 (0.228±0.020)	5.00±0.50 (0.197±0.020)	0.80±0.60 (0.032±0.024)
05	2824 ⁽²⁾	7.20±0.50 (0.283±0.020)	6.10±0.50 (0.240±0.020)	0.80±0.60 (0.032±0.024)
95	2840	7.20±0.50 (0.283±0.020)	10.0±0.80 (0.343±0.031)	0.80±0.60 (0.032±0.024)
16	4030	10.5±0.60 (0.413±0.024)	7.60±0.80 (0.299±0.031)	0.80±0.60 (0.032±0.024)
17	5040	12.8±0.60 (0.504±0.024)	10.2±0.80 (0.401±0.031)	0.80±0.60 (0.032±0.024)
18	6054	15.3±0.60 (0.602±0.024)	13.7±0.80 (0.539±0.031)	0.80±0.60 (0.032±0.024)

⁽¹⁾ size 1812 for PEN dielectric L = 4.7 ± 0.5 mm

⁽²⁾ size 2824 for PEN dielectric & voltage 50 & 100V L = 7.3 +0,7/-0,3 mm

STACKED FILM CONSTRUCTION

Our SMD Film capacitors (CB series) are using stacked technology with metallized plastic film, which forms the basis for the capacitive element. Combined with the naked design choice, it gives our products an again better self-healing capability as well as a very good capacitance per volume ratio. This also means that internal construction of the multilayer stack, usually hidden in encapsulated film capacitors design, is visible at the cut edges in the surface mount configuration. In a typical film capacitor stack, hundreds of film layers are compacted during manufacturing. Under a magnifying glass these have the appearance of pages in a book. Sometimes, microgaps can be visible between film layers due to structure and process. Subsequent manufacturing and pcb assembly

processes allow a small amount of relaxation in these layers. In some cases, small gaps between layers may become bigger. These are referred to as microgaps, and their occurrence is a standard feature of this technology. Even if it can be considered an cosmetic issue, presence of these gaps has no effect at all on mechanical or electrical performance or reliability. (Detailed report is available upon request.)

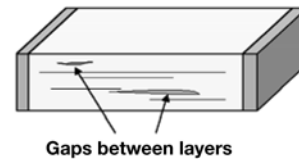

Film Chip Capacitors



Electrical Properties and Test Conditions – CB Series

STANDARDIZATION

Reference Standard is CECC 32201

Test	Description	Performance
Capacitance C	Measurement frequency 1 KHz 20°C	Shall be within tolerance of the rated value
Dissipation Factor DF	Measurement frequency 1 KHz 20°C	DF < 100.10 ⁻⁴
Insulation Resistance IR	Voltage applied 60 sec.: 10V for Vr < 100V 100V for Vr > = 100V	IR > 1000 Mohms for C < = 0.33µF IR x C > 400 sec. For C > 0.33µF
Dielectric Strength	Surge Voltage = 1.4Vr applied for 1 minute between terminals	There shall be no direct breakdown
Mounting	Board = 1.6mm (0.063") thick epoxy glass laminated or alumina substrate	C = within ± 2% of initial value Delta DF = < = 50.10 ⁻⁴ at 1 KHz IR = within initial limit
Adhesion	Force of 5 N applied for 10 secs.	No visible damage
Board Bending Test	Bending of 1 mm(0.039") for 90 mm (3.543") length	C = within ± 2% of initial value No visible damage
Thermal Shock	500 cycles -55/+125°C	C = within ± 5% of initial value ESR = no more than 3 times initial value IR = not less than 50% of the initial limit
Damp Heat Steady State	40°C 93% RH / no voltage / 56 days	C = within ± 7% of initial value Delta DF = < = 50.10 ⁻⁴ at 1 KHz IR = not less than 50% of the initial limit
Accelerated Damp Heat (Load Humidity)	85°C 85% RH 1.5V-500H	C = within ± 7% of initial value Delta DF = < = 70.10 ⁻⁴ at 1 KHz IR = not less than 50% of the initial limit
Life Test	85°C / 1.25Vr / 1000H measuring 2 hours after test conclusion	C = within ± 8% of initial value Delta DF = < = 50.10 ⁻⁴ at 1 KHz IR = not less than 50% of the initial limit
Life Test	105°C / Vr/1,000 Hours 125°C / Vr/1,000 Hours measuring 2 hours after test conclusion	C = within ± 7% of initial value Delta DF = < = 50.10 ⁻⁴ at 1 KHz IR = not less than 50% of the initial limit
Charge/Discharge	10,000 cycle / Vr	C = within ± 5% of initial value Delta DF = < = 50.10 ⁻⁴ at 1 KHz IR = not less than 50% of the initial limit

Film Chip Capacitors



AECQ Documentation – CB Series

AECQ 200

Test	Page #	Reference	Sample size per lot	Tests Description	Criterion
High Temperature Exposure (Storage)	3	Mil-std-202 method 108	77	1000h at rated operating temperature (125°C) Unpowered Measurement 24h after test conclusion	C = within ± 7% of initial value Delta DF < or = 50.10 ⁻⁴ at 1kHz * IR = not less than 50% of initial limit
Temperature Cycling	4	JESD22 method JA-104	77	1000 cycles (-55°C to +125°C) 1 cycles per hour - gradient 15°C/minute Measurement after 24h at 100°C	C = within ± 5% of initial value Delta DF < or = 50.10 ⁻⁴ at 1kHz * IR = not less than 50% of initial limit
Moisture resistance	6	Mil-std-202 method 106	77	t=24 hours/cycle. Note Steps 7A and 7B not required - Unpowered Measurement after 24h at 100°C	C = within ± 8% of initial value Delta DF < or = 70.10 ⁻⁴ at 1kHz * IR = not less than 50% of initial limit
Biased humidity	7	Mil-std-202 method 103	77	1000 hours 40°C/93%RH 0.5 Un or 48V max Measurement after 24h at 100°C	C = within ± 8% of initial value Delta DF < or = 70.10 ⁻⁴ at 1kHz * IR = not less than 50% of initial limit
Operational Life	8	Mil-std-202 method 108	77	1000 hours at 125°C 100% of Rated Voltage Measurement 24h after test conclusion	C = within ± 7% of initial value Delta DF < or = 50.10 ⁻⁴ at 1kHz * IR = not less than 50% of initial limit
Resistance to solvents	12	Mil-std-202 method 215	5	OKEM clean or equivalent	No visible damage
Mechanical shock	13	Mil-std-202 method 213	30	18 shocks Condition C 1/2 sinusoid 6 msec. 100g's	C = within ± 2% of initial value Delta DF < or = 50.10 ⁻⁴ at 1kHz * IR = not less than 50% of initial limit
Vibration	14	Mil-std-202 method 204	30	12 cycles each of 3 orientations 5g's for 20 minutes Test from 10-2000 Hz	C = within ± 2% of initial value Delta DF < or = 50.10 ⁻⁴ at 1kHz * IR = not less than 50% of initial limit
Resistance to soldering heat	15	Mil-std-202 method 210	30	for SMD use Procedure 2 (235°C / 30 sec.) 3 times	C = within ± 5% of initial value Delta DF < or = 50.10 ⁻⁴ at 1kHz * IR = not less than 50% of initial limit
Thermal Shock	16	Mil-std-202 method 107	30	-55°C/+125°C 300 cycles - transfert 20 sec. max Dwell Time =15minutes Measurement 24h after test conclusion	C= within ± 5% of initial value Delta DF < or = 50.10 ⁻⁴ at 1kHz * IR = not less than 50% of initial limit
ESD	17	AEC-Q200-002	15	Ongoing	
Solderability	18	J-STD-002 replaced by: JESD22-B102D	15	dipping in solder bath SnPb at 235°C during 3 or 5 sec. depending on case size	95% solder coverage minimum
Electrical Characterization	19	User spec.	30	Electrical characteristics measured at : -55°C / +25°C / +125°C	Summary to show Min, Max, Mean and standard deviation at room, Min and Max operating temperatures.
Flammability	20	UL-94	10	20 mm vertical burning test V-0, V-1 or V-2 Electrical Test not required	V-0 or V-1 are acceptable
Board Flex	21	AEC-Q200-005	30	2mm minimum	C = within ± 2% of initial value No visible damage
Terminal Strength	22	AEC-Q200-006	30	a force of 1.8 kg for 60s sec.	No visible damage

* For PPS: Delta DF= 10 x 10⁻⁴

Film Chip Capacitors



Packaging – CB Series

TAPE & REEL DIMENSIONS

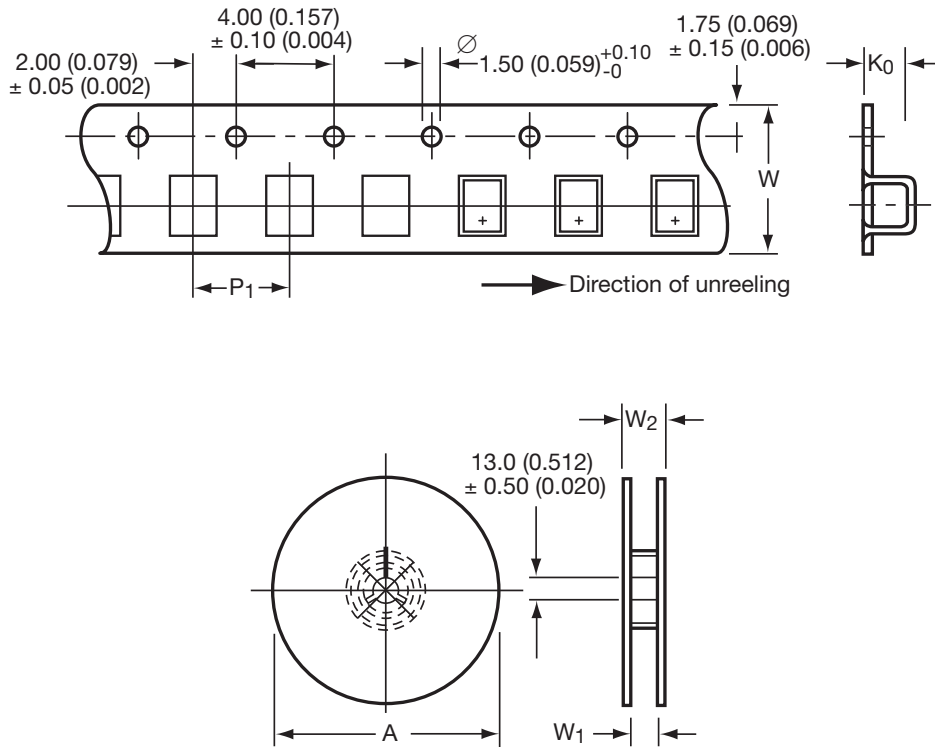

MARKING ON PACKAGING ONLY

Example of a label for chip film PET-HT 100nF ±10% 250V BULK packaging



TAPE & REEL CHARACTERISTICS

In accordance with IEC 286 and EIA 481, the material used:

- Carrier tape: Antistatic Material
- Cover tape: Polyester
- Reel: Recyclable Material

Parts in bulk or on reel are packed in hermetically sealed plastic bags.

RECOMMENDATIONS

Once the sealed bag is opened, the capacitors must be stored in a dry atmosphere until soldering.

Recommended storage conditions are:

- PET & PEN: < 30°C and R.H.<60% for a maximum of 168 hours
- PPS: < 30°C and R.H.<60% for a maximum of 4 weeks

The use-by date is 3 years if kept in origin plastic bags.

In case of storage outside the conditions recommended above the capacitors must be dried prior to soldering.

Recommended drying conditions are:

- 96 hours minimum at 60°C and RH < 10%.

MSL:

- PEN & PET-HT = 3
- PPS = 2a

Standard IPC/JEDEC J-STD-033

Film Chip Capacitors

PET-HT DIELECTRIC – CB Series

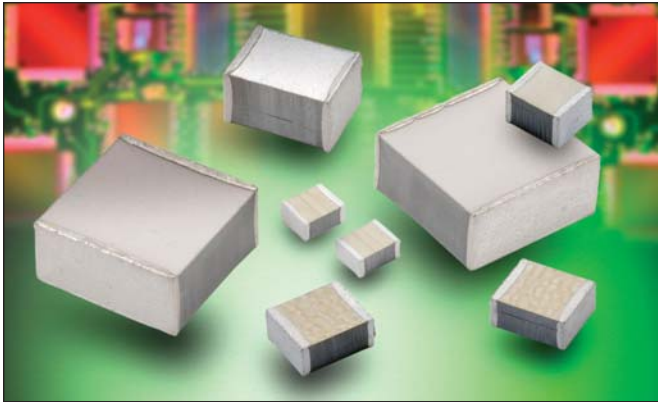

GENERAL DESCRIPTION

Film chip capacitor using a naked and stacked construction with metallized High Temperature PET (polyethylene terephthalate).

ADVANTAGES

- Use of high temperature dielectric films makes these capacitors suitable for IR or vapor phase reflow processes. This chip is built without specific encapsulation.
- The intrinsic elasticity of the dielectric film allows an excellent compatibility of the capacitor with all types of material for printed circuit boards.
- The self-healing property of film technology results to a safety open failure mode and better overall reliability.
- Excellent thermal shock resistance.
- Low dissipation factor ESR & ESL.
- No piezoelectric effect.
- Available in tape and reel suitable for automatic placement.
- Non-polar construction.

APPLICATIONS

General purpose function in low voltage applications where miniaturization and SMD is required. Typical applications would be:

- Automotive (Airbag, Fuel injection calculator...)
- Telecom (Public switching systems, modems, telephone set, cordless, mobile)
- Industrial (SMPS, Power convertor module...)

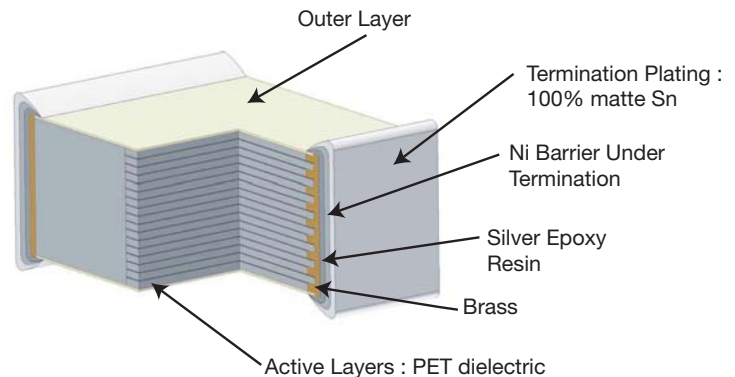

PERFORMANCE CHARACTERISTICS

Climatic Category	55/125/56
Capacitance Range	10nF to 4.7μF
Tolerance on C _R	±5%, ±10%
Nominal Voltages	63Vdc to 630Vdc
Test Voltage	1.4Vr 2 sec. at 25°C
Soldering methods	IR or vapor phase reflow (not suitable for wave soldering)
Tangent of Loss Angle at 1kHz (DF)	< 100 x 10 ⁻⁴
Insulation resistance minimum : IR	for C ≤ 0.33μF IR > 1000 MΩ at 20°C for 1 min. charge at 10Vdc for VR < 100Vdc and 100Vdc for VR ≥ 100Vdc for C > 0.33μF IR C > 400 sec. at 20°C for 1 min. charge at 10Vdc for VR < 100Vdc and 100Vdc for VR ≥ 100Vdc
Temperature range	-55°C to 125°C with voltage derating of 1.25%/°C between 105°C and 125°C
A.C. applications	for high frequency A.C. application please check with AVX

Film Chip Capacitors

PET-HT DIELECTRIC – CB Series



CAPACITANCE VALUES (CR) AND NOMINAL VOLTAGES (VR)

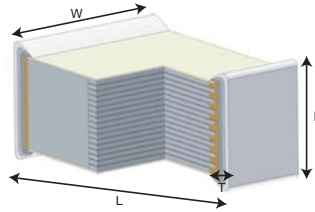

millimeters (inches)

Capacitance Range (CR)	Ordering Code	VOLTAGE Vdc: 63V Vac: 40V												
		Chip Dimensions *Tolerances (page 6)				Tape Dimensions			Reel Dimensions			Packaging Unit		Reel Pkg Code
		L	W	H max	T	W	P1	K0	A	W1	W2 max	Bulk	Reel	
0.270µF	CB042D0274+ --	5.8 (0.228)	5.0 (0.195)	2.8 (0.110)	0.8 (0.032)	12.0 (0.472)	8.0 (0.315)	3.1 (0.122)	330 (12.99)	12.4 (0.488)	18.4 (0.724)	1500	3000	BC
0.330µF	CB042D0334+ --	5.80 (0.228)	5.00 (0.195)	3.30 (0.130)	0.80 (0.032)	12.0 (0.472)	8.00 (0.315)	3.45 (0.136)	330 (12.99)	12.4 (0.488)	18.4 (0.724)	1500	2800	BC
0.390	CB042D0394++ --	5.80 (0.228)	5.00 (0.195)	3.40 (0.134)	0.80 (0.032)	12.0 (0.472)	8.00 (0.315)	3.45 (0.136)	330 (12.99)	12.4 (0.488)	18.4 (0.724)	1500	2800	BC
0.470	CB042D0474+ --	5.80 (0.228)	5.00 (0.195)	3.50 (0.138)	0.80 (0.032)	12.0 (0.472)	8.00 (0.315)	4.10 (0.162)	330 (12.99)	12.4 (0.488)	18.4 (0.724)	1500	2300	BC
0.560	CB042D0564+ --	5.80 (0.228)	5.00 (0.195)	3.50 (0.138)	0.80 (0.032)	12.0 (0.472)	8.00 (0.315)	4.10 (0.162)	330 (12.99)	12.4 (0.488)	18.4 (0.724)	1500	2300	BC
0.680	CB042D0684+ --	5.80 (0.228)	5.00 (0.195)	4.00 (0.158)	0.80 (0.032)	12.0 (0.472)	8.00 (0.315)	4.10 (0.162)	330 (12.99)	12.4 (0.488)	18.4 (0.724)	1500	2300	BC
0.820	CB052D0824+ --	7.2 (0.283)	6.1 (0.24)	3.7 (0.146)	0.8 (0.032)	24.0 (0.944)	12 (0.472)	3.8 (0.149)	330 (12.99)	24.4 (0.96)	30.4 (1.196)	1000	2250	BC
1µF	CB052D0105+ --	7.2 (0.283)	6.1 (0.24)	3.7 (0.146)	0.8 (0.032)	24.0 (0.944)	12 (0.472)	3.8 (0.149)	330 (12.99)	24.4 (0.96)	30.4 (1.196)	1000	2250	BC
1.5	CB052D0155+ --	7.20 (0.283)	6.10 (0.240)	5.30 (0.209)	0.80 (0.032)	16.0 (0.629)	12.0 (0.472)	5.50 (0.216)	330 (12.99)	16.4 (0.645)	22.4 (0.881)	1000	1000	BC
2.2	CB162D0225+ --	10.5 (0.413)	7.6 (0.299)	5.8 (0.229)	0.8 (0.032)	24.0 (0.944)	12 (0.472)	6.19 (0.244)	330 (12.99)	24.4 (0.96)	30.4 (1.196)	500	900	BC
3.3	CB172D0335+ --	12.8 (0.503)	10.2 (0.401)	5.50 (0.216)	0.80 (0.032)	24.0 (0.944)	16.0 (0.629)	5.70 (0.224)	330 (12.99)	24.4 (0.961)	30.4 (1.196)	300	700	BC
4.7µF	CB182D0475+ --	15.3 (0.601)	13.7 (0.539)	4.90 (0.193)	0.80 (0.032)	24.0 (0.944)	24.0 (0.944)	5.50 (0.216)	330 (12.99)	24.4 (0.961)	30.4 (1.196)	300	500	BC
VOLTAGE Vdc: 100V Vac: 63V														
0.180µF	CB042E0184+ --	5.8 (0.228)	5.0 (0.195)	2.3 (0.091)	0.8 (0.032)	12.0 (0.472)	8.0 (0.315)	2.43 (0.096)	330 (12.99)	12.4 (0.488)	18.4 (0.724)	1500	3500	BC
0.220µF	CB042E0224+ --	5.80 (0.228)	5.00 (0.195)	3.30 (0.130)	0.80 (0.032)	12.0 (0.472)	8.00 (0.315)	3.45 (0.136)	330 (12.99)	12.4 (0.488)	18.4 (0.724)	1500	3000	BC
0.270µF	CB042E0274+++	5.8 (0.228)	5.0 (0.195)	3.4 (0.134)	0.8 (0.032)	12.0 (0.472)	8.0 (0.315)	3.45 (0.136)	330 (12.99)	12.4 (0.488)	18.4 (0.724)	1500	2800	BC
0.330	CB042E0334+ --	5.80 (0.228)	5.00 (0.195)	4.00 (0.158)	0.80 (0.032)	12.0 (0.472)	8.00 (0.315)	4.10 (0.161)	330 (12.99)	12.4 (0.488)	18.4 (0.724)	1500	2300	BC
0.390	CB042E0394+ --	5.80 (0.228)	5.00 (0.195)	3.90 (0.154)	0.80 (0.032)	12.0 (0.472)	8.00 (0.315)	4.10 (0.161)	330 (12.99)	12.4 (0.488)	18.4 (0.724)	1500	2300	BC
0.470	CB042E0474+ --	5.80 (0.228)	5.00 (0.195)	4.30 (0.169)	0.80 (0.032)	12.0 (0.472)	8.0 (0.315)	4.50 (0.177)	330 (12.99)	12.4 (0.488)	18.4 (0.724)	1500	1900	BC
0.560	CB052E0564+ --	7.20 (0.283)	6.10 (0.240)	4.20 (0.165)	0.80 (0.032)	16.0 (0.629)	12.0 (0.472)	4.80 (0.189)	330 (12.99)	16.4 (0.645)	22.4 (0.881)	1000	1800	BC
0.680	CB052E0684+ --	7.20 (0.283)	6.10 (0.240)	5.00 (0.197)	0.80 (0.032)	16.0 (0.629)	12.0 (0.472)	5.23 (0.206)	330 (12.99)	16.4 (0.645)	22.4 (0.881)	1000	1100	BC
0.820	CB052E0824+ --	7.20 (0.283)	6.10 (0.240)	4.70 (0.185)	0.80 (0.032)	16.0 (0.629)	12.0 (0.472)	4.80 (0.189)	330 (12.99)	16.4 (0.645)	22.4 (0.881)	1000	1800	BC
1µF	CB052E0105+ --	7.20 (0.283)	6.10 (0.240)	5.70 (0.224)	0.80 (0.032)	16.0 (0.629)	12.0 (0.472)	5.90 (0.232)	330 (12.99)	16.4 (0.645)	22.4 (0.881)	1000	900	BC
1.5	CB162E0155+ --	10.5 (0.413)	7.60 (0.299)	6.10 (0.240)	0.80 (0.032)	24.0 (0.944)	12.0 (0.472)	6.19 (0.244)	330 (12.99)	24.4 (0.961)	30.4 (1.196)	500	900	BC

Replace the + by the tolerance code: J = 5% or K = 10%
 Replace the -- by the packaging suffix: -- = bulk
 BC = tape & reel



Film Chip Capacitors



PET-HT DIELECTRIC – CB Series

CAPACITANCE VALUES (CR) AND NOMINAL VOLTAGES (VR)



millimeters (inches)

Capacitance Range (CR)	Ordering Code	VOLTAGE Vdc: 100V Vac: 63V												
		Chip Dimensions *Tolerances (page 6)				Tape Dimensions			Reel Dimensions			Packaging Unit		Reel Pkg Code
		L	W	H max	T	W	P1	K0	A	W1	W2 max	Bulk	Reel	
2.2	CB172E0225+ --	12.8 (0.503)	10.2 (0.401)	5.50 (0.216)	0.80 (0.032)	24.0 (0.944)	16.0 (0.629)	5.70 (0.224)	330 (12.99)	24.4 (0.961)	30.4 (1.196)	300	700	BC
3.3	CB182E0335+ --	15.3 (0.601)	13.7 (0.539)	5.20 (0.204)	0.80 (0.032)	24.0 (0.944)	24.0 (0.944)	5.50 (0.216)	330 (12.99)	24.4 (0.961)	30.4 (1.196)	300	500	BC
4.7µF	CB182E0475+ --	15.3 (0.601)	13.7 (0.539)	7.10 (0.279)	0.80 (0.032)	24.0 (0.944)	24.0 (0.944)	7.60 (0.299)	330 (12.99)	24.4 (0.961)	30.4 (1.196)	300	300	BC
VOLTAGE Vdc: 250V Vac: 160V														
0.047µF	CB042G0473+ --	5.80 (0.228)	5.00 (0.195)	3.00 (0.118)	0.80 (0.032)	12.0 (0.472)	8.00 (0.315)	3.10 (0.122)	330 (12.99)	12.4 (0.488)	18.4 (0.724)	1500	3000	BC
0.056	CB042G0563+ --	5.80 (0.228)	5.00 (0.195)	3.60 (0.142)	0.80 (0.032)	12.0 (0.472)	8.00 (0.315)	4.10 (0.161)	330 (12.99)	12.4 (0.488)	18.4 (0.724)	1500	2300	BC
0.068	CB042G0683+ --	5.80 (0.228)	5.00 (0.195)	4.00 (0.158)	0.80 (0.032)	12.0 (0.472)	8.00 (0.315)	4.10 (0.161)	330 (12.99)	12.4 (0.488)	18.4 (0.724)	1500	2300	BC
0.082	CB042G0823+ --	5.80 (0.228)	5.00 (0.195)	4.00 (0.158)	0.80 (0.032)	12.0 (0.472)	8.00 (0.315)	4.10 (0.161)	330 (12.99)	12.4 (0.488)	18.4 (0.724)	1500	2300	BC
0.1µF	CB042G0104+ --	5.80 (0.228)	5.00 (0.195)	4.00 (0.158)	0.80 (0.032)	12.0 (0.472)	8.00 (0.315)	4.10 (0.161)	330 (12.99)	12.4 (0.448)	18.4 (0.724)	1500	2300	BC
0.120	CB052G0124+ --	7.20 (0.283)	6.10 (0.240)	4.30 (0.169)	0.80 (0.032)	16.0 (0.629)	12.0 (0.472)	4.80 (0.189)	330 (12.99)	16.4 (0.645)	22.4 (0.881)	1000	1800	BC
0.150	CB052G0154+ --	7.20 (0.283)	6.10 (0.240)	4.30 (0.169)	0.80 (0.032)	16.0 (0.629)	12.0 (0.472)	4.80 (0.189)	330 (12.99)	16.4 (0.645)	22.4 (0.881)	1000	1800	BC
0.180	CB052G0184+ --	7.20 (0.283)	6.10 (0.240)	5.10 (0.200)	0.80 (0.032)	16.0 (0.629)	12.0 (0.472)	5.23 (0.206)	330 (12.99)	16.4 (0.645)	22.4 (0.881)	1000	1100	BC
0.220	CB052G0224+ --	7.20 (0.283)	6.10 (0.240)	4.90 (0.193)	0.80 (0.032)	16.0 (0.629)	12.0 (0.472)	5.23 (0.206)	330 (12.99)	16.4 (0.645)	22.4 (0.881)	1000	1100	BC
0.270	CB162G0274+ --	10.5 (0.413)	7.60 (0.299)	4.80 (0.189)	0.80 (0.032)	24.0 (0.944)	12.0 (0.472)	6.19 (0.244)	330 (12.99)	24.4 (0.961)	30.4 (1.196)	500	1100	BC
0.330	CB162G0334+ --	10.5 (0.413)	7.60 (0.299)	5.60 (0.220)	0.80 (0.032)	24.0 (0.944)	12.0 (0.472)	6.19 (0.244)	330 (12.99)	24.4 (0.961)	30.4 (1.196)	500	900	BC
0.390	CB162G0394+ --	10.5 (0.413)	7.60 (0.299)	5.40 (0.213)	0.80 (0.032)	24.0 (0.944)	12.0 (0.472)	6.19 (0.244)	330 (12.99)	24.4 (0.961)	30.4 (1.196)	500	900	BC
0.470	CB162G0474+ --	10.5 (0.413)	7.6 (0.299)	6.15 (0.241)	0.80 (0.032)	24.0 (0.944)	12.0 (0.472)	6.19 (0.244)	330 (12.99)	24.4 (0.961)	30.4 (1.196)	500	900	BC
0.560	CB172G0564+ --	12.8 (0.503)	10.2 (0.402)	5.60 (0.220)	0.80 (0.032)	24.0 (0.944)	16.0 (0.629)	5.70 (0.225)	330 (12.99)	24.4 (0.961)	30.4 (1.196)	300	700	BC
0.680	CB172G0684+ --	12.8 (0.503)	10.2 (0.402)	6.50 (0.255)	0.80 (0.032)	24.0 (0.944)	16.0 (0.629)	7.00 (0.275)	330 (12.99)	24.4 (0.961)	30.4 (1.196)	300	600	BC
0.820	CB182G0824+ --	15.3 (0.601)	13.7 (0.539)	5.10 (0.201)	0.80 (0.032)	24.0 (0.944)	24.0 (0.944)	5.50 (0.217)	330 (12.99)	24.4 (0.961)	30.4 (1.196)	300	500	BC
1µF	CB182G0105+ --	15.3 (0.601)	13.7 (0.539)	6.00 (0.236)	0.80 (0.032)	24.0 (0.944)	24.0 (0.944)	6.30 (0.248)	330 (12.99)	24.4 (0.961)	30.4 (1.196)	300	400	BC
1.5	CB182G0155+ --	15.3 (0.601)	13.7 (0.539)	7.00 (0.276)	0.80 (0.0315)	24.0 (0.944)	24.0 (0.944)	7.60 (0.299)	330 (12.99)	24.4 (0.961)	30.4 (1.196)	300	300	BC

Replace the + by the tolerance code: J = 5% or K = 10%
 Replace the -- by the packaging suffix: -- = bulk
 BC = tape & reel



Film Chip Capacitors

PET-HT DIELECTRIC – CB Series



CAPACITANCE VALUES (CR) AND NOMINAL VOLTAGES (VR)

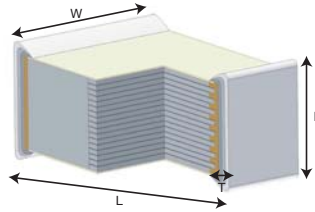

millimeters (inches)

Capacitance Range (CR)	Ordering Code	VOLTAGE Vdc: 400V Vac: 200V											Packaging Unit		Reel Pkg Code
		Chip Dimensions *Tolerances (page 6)				Tape Dimensions			Reel Dimensions						
		L	W	H max	T	W	P1	K0	A	W1	W2 max	Bulk	Reel		
0.010µF	CB042I0103+ --	5.80 (0.228)	5.00 (0.195)	3.00 (0.017)	0.80 (0.032)	12.0 (0.472)	8.00 (0.315)	3.10 (0.122)	330 (12.99)	12.4 (0.488)	18.4 (0.724)	1500	3000	BC	
0.012	CB042I0123+ --	5.80 (0.228)	5.00 (0.195)	2.40 (0.095)	0.80 (0.032)	12.0 (0.472)	8.00 (0.315)	2.43 (0.096)	330 (12.99)	12.4 (0.488)	18.4 (0.724)	1500	3500	BC	
0.015	CB042I0153+ --	5.80 (0.228)	5.00 (0.195)	4.00 (0.158)	0.80 (0.032)	12.0 (0.472)	8.00 (0.315)	4.10 (0.161)	330 (12.99)	12.4 (0.488)	18.4 (0.724)	1500	2300	BC	
0.018	CB052I0183+ --	7.2 (0.283)	6.1 (0.240)	2.8 (0.110)	0.8 (0.032)	16.0 (0.629)	12 (0.472)	3.8 (0.150)	330 (12.99)	16.4 (0.645)	22.4 (0.881)	1000	2250	BC	
0.022	CB052I0223+ --	7.2 (0.283)	6.1 (0.240)	3.5 (0.138)	0.8 (0.032)	16.0 (0.629)	12 (0.472)	3.8 (0.150)	330 (12.99)	16.4 (0.645)	22.4 (0.881)	1000	2250	BC	
0.027	CB052I0273+ --	7.2 (0.283)	6.1 (0.240)	2.8 (0.110)	0.8 (0.032)	16.0 (0.629)	12 (0.472)	3.8 (0.150)	330 (12.99)	16.4 (0.645)	22.4 (0.881)	1000	2250	BC	
0.033	CB052I0333+ --	7.2 (0.283)	6.1 (0.240)	3.3 (0.130)	0.8 (0.032)	16.0 (0.629)	12 (0.472)	3.8 (0.150)	330 (12.99)	16.4 (0.645)	22.4 (0.881)	1000	2250	BC	
0.047	CB052I0473+ --	7.20 (0.283)	6.10 (0.240)	4.50 (0.177)	0.80 (0.032)	16.0 (0.629)	12.0 (0.472)	4.80 (0.189)	330 (12.99)	16.4 (0.645)	22.4 (0.881)	1000	1800	BC	
0.056	CB162I0563+ --	10.5 (0.413)	7.60 (0.299)	3.10 (0.122)	0.80 (0.032)	24.0 (0.944)	12.0 (0.472)	3.93 (0.155)	330 (12.99)	24.4 (0.961)	30.4 (1.196)	500	1400	BC	
0.068	CB162I0683+ --	10.5 (0.413)	7.60 (0.299)	3.60 (0.141)	0.80 (0.032)	24.0 (0.944)	12.0 (0.472)	3.93 (0.155)	330 (12.99)	24.4 (0.961)	30.4 (1.196)	500	1400	BC	
0.082	CB162I0823+ --	10.5 (0.413)	7.60 (0.299)	4.20 (0.165)	0.80 (0.032)	24.0 (0.944)	12.0 (0.472)	6.19 (0.244)	330 (12.99)	24.4 (0.961)	30.4 (1.196)	500	900	BC	
0.100µF	CB162I0104+ --	10.5 (0.413)	7.60 (0.299)	4.70 (0.185)	0.80 (0.032)	24.0 (0.944)	12.0 (0.472)	6.19 (0.244)	330 (12.99)	24.4 (0.961)	30.4 (1.196)	500	900	BC	
0.120	CB172I0124+ --	12.8 (0.503)	10.2 (0.402)	3.90 (0.154)	0.80 (0.032)	24.0 (0.944)	16.0 (0.629)	4.00 (0.157)	330 (12.99)	24.4 (0.961)	30.4 (1.196)	300	1100	BC	
0.150	CB172I0154+ --	12.8 (0.503)	10.2 (0.402)	4.60 (0.181)	0.80 (0.032)	24.0 (0.944)	16.0 (0.629)	4.70 (0.185)	330 (12.99)	24.4 (0.961)	30.4 (1.196)	300	900	BC	
0.180	CB172I0184+ --	12.8 (0.503)	10.2 (0.402)	5.60 (0.220)	0.80 (0.032)	24.0 (0.944)	16.0 (0.629)	7.00 (0.274)	330 (12.99)	24.4 (0.961)	30.4 (1.196)	300	600	BC	
0.220	CB172I0224+ --	12.8 (0.503)	10.2 (0.402)	6.80 (0.265)	0.80 (0.032)	24.0 (0.944)	16.0 (0.629)	7.00 (0.274)	330 (12.99)	24.4 (0.961)	30.4 (1.196)	300	600	BC	
0.270	CB172I0274+ --	12.8 (0.503)	10.2 (0.402)	6.80 (0.265)	0.80 (0.032)	24.0 (0.944)	16.0 (0.629)	7.00 (0.274)	330 (12.99)	24.4 (0.961)	30.4 (1.196)	300	600	BC	
0.330	CB182I0334+ --	15.3 (0.601)	13.7 (0.539)	5.60 (0.220)	0.80 (0.032)	24.0 (0.944)	24.0 (0.944)	6.30 (0.248)	330 (12.99)	24.4 (0.961)	30.4 (1.196)	300	400	BC	
0.470µF	CB182I0474+ --	15.3 (0.601)	13.7 (0.539)	6.20 (0.244)	0.80 (0.032)	24.0 (0.944)	24.0 (0.944)	6.30 (0.248)	330 (12.99)	24.4 (0.961)	30.4 (1.196)	300	400	BC	
VOLTAGE Vdc: 630V Vac: 250V															
0.010µF	CB042K0103+ --	5.80 (0.228)	5.00 (0.195)	2.80 (0.110)	0.80 (0.032)	12.0 (0.472)	8.00 (0.315)	3.10 (0.122)	330 (12.99)	12.4 (0.488)	18.4 (0.724)	1500	3000	BC	
0.012	CB042K0123+ --	5.80 (0.228)	5.00 (0.195)	3.30 (0.130)	0.80 (0.032)	12.0 (0.472)	8.00 (0.315)	3.10 (0.122)	330 (12.99)	12.4 (0.488)	18.4 (0.724)	1500	2800	BC	
0.015	CB042K0153+ --	5.80 (0.228)	5.00 (0.195)	4.00 (0.158)	0.80 (0.032)	12.0 (0.472)	8.00 (0.315)	4.10 (0.161)	330 (12.99)	12.4 (0.488)	18.4 (0.724)	1500	2300	BC	
0.018	CB052K0183+ --	5.80 (0.228)	6.10 (0.240)	2.80 (0.110)	0.80 (0.032)	24.0 (0.944)	12.0 (0.472)	3.80 (0.149)	330 (12.99)	24.4 (0.961)	30.4 (1.196)	1000	2250	BC	

Replace the + by the tolerance code: J = 5% or K = 10%
 Replace the -- by the packaging suffix: -- = bulk
 BC = tape & reel



Film Chip Capacitors



PET-HT DIELECTRIC – CB Series

CAPACITANCE VALUES (CR) AND NOMINAL VOLTAGES (VR)

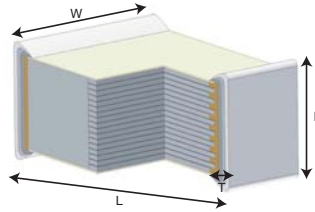

millimeters (inches)

Capacitance Range (CR)	Ordering Code	VOLTAGE Vdc: 630V Vac: 250V											Packaging Unit		Reel Pkg Code
		Chip Dimensions *Tolerances (page 6)				Tape Dimensions			Reel Dimensions			Bulk	Reel		
		L	W	H max	T	W	P1	K0	A	W1	W2 max				
0.022	CB052K0223+ --	7.20 (0.283)	6.10 (0.240)	3.50 (0.138)	0.80 (0.032)	24.0 (0.944)	12.0 (0.472)	3.80 (0.149)	330 (12.99)	24.4 (0.961)	30.4 (1.196)	1000	2250	BC	
0.027	CB052K0273+ --	7.20 (0.283)	6.10 (0.240)	4.10 (0.161)	0.80 (0.032)	16.0 (0.629)	12.0 (0.472)	4.80 (0.189)	330 (12.99)	16.4 (0.645)	22.4 (0.881)	1000	1800	BC	
0.033	CB052K0333+ --	7.20 (0.283)	6.10 (0.240)	5.00 (0.197)	0.80 (0.032)	16.0 (0.629)	12.0 (0.472)	4.80 (0.189)	330 (12.99)	16.4 (0.645)	22.4 (0.881)	1000	1100	BC	
0.047	CB162K0473+ --	10.5 (0.413)	7.60 (0.299)	3.60 (0.141)	0.80 (0.032)	24.0 (0.944)	12.0 (0.472)	3.93 (0.155)	330 (12.99)	24.4 (0.961)	30.4 (1.196)	500	1400	BC	
0.056	CB162K0563+ --	10.5 (0.413)	7.60 (0.299)	4.30 (0.169)	0.80 (0.032)	24.0 (0.944)	12.0 (0.472)	6.19 (0.244)	330 (12.99)	24.4 (0.961)	30.4 (1.196)	500	900	BC	
0.068	CB162K0683+ --	10.5 (0.413)	7.60 (0.299)	5.20 (0.205)	0.80 (0.032)	24.0 (0.944)	12.0 (0.472)	6.19 (0.244)	330 (12.99)	24.4 (0.961)	30.4 (1.196)	500	900	BC	
0.082	CB172K0823+ --	12.8 (0.503)	10.2 (0.402)	4.30 (0.169)	0.80 (0.032)	24.0 (0.944)	16.0 (0.629)	4.70 (0.185)	330 (12.99)	24.4 (0.961)	30.4 (1.196)	300	900	BC	
0.100µF	CB172K0104+ --	12.8 (0.503)	10.2 (0.402)	5.00 (0.197)	0.80 (0.032)	24.0 (0.944)	16.0 (0.629)	5.70 (0.225)	330 (12.99)	24.4 (0.961)	30.4 (1.196)	300	700	BC	
0.120	CB172K0124+ --	12.8 (0.503)	10.2 (0.402)	5.60 (0.220)	0.80 (0.032)	24.0 (0.944)	16.0 (0.629)	5.70 (0.225)	330 (12.99)	24.4 (0.961)	30.4 (1.196)	300	700	BC	
0.150	CB172K0154+ --	12.8 (0.503)	10.2 (0.402)	6.90 (0.271)	0.80 (0.032)	24.0 (0.944)	16.0 (0.629)	7.00 (0.275)	330 (12.99)	24.4 (0.961)	30.4 (1.196)	300	600	BC	
0.180	CB182K0184+ --	15.3 (0.601)	13.7 (0.539)	5.00 (0.197)	0.80 (0.032)	24.0 (0.944)	24.0 (0.944)	5.50 (0.217)	330 (12.99)	24.4 (0.961)	30.4 (1.196)	300	500	BC	
0.220	CB182K0224+ --	15.3 (0.601)	13.7 (0.539)	5.80 (0.229)	0.80 (0.032)	24.0 (0.944)	24.0 (0.944)	6.30 (0.248)	330 (12.99)	24.4 (0.961)	30.4 (1.196)	300	400	BC	
0.270µF	CB182K0274+ --	15.3 (0.601)	13.7 (0.539)	7.20 (0.284)	0.80 (0.032)	24.0 (0.944)	24.0 (0.944)	7.60 (0.299)	330 (12.99)	24.4 (0.961)	30.4 (1.196)	300	300	BC	

Replace the + by the tolerance code: J = 5% or K = 10%
 Replace the -- by the packaging suffix: -- = bulk
 BC = tape & reel



Film Chip Capacitors



PET-HT DIELECTRIC – CB Series

MOUNTING AND SOLDERING RECOMMENDATIONS

SOLDERING PROFILE

The capacitors can be mounted using infrared and vapor phase soldering following recommended below. They are NOT suitable for wave soldering.

All temperature refer to topside of the package, measured on the package body surface.

Profile Feature	2220 to 2824	4030 to 6054
Ramp-Up (T_s max to T_p)	3°C / second max	3°C / second max
Preheat		
- Temperature Min (T_s min)	150°C	150°C
- Temperature Min (T_s max)	200°C	200°C
- Time (t_s min to t_s max)	180 sec. max	180 sec. max
Time maintained above		
- Temperature (T_L)	217°C	217°C
- Time (t_L)	60 sec. max	75 sec. max
Peak temperature (T_p)	240°C	245°C
Time within 5°C of peak temperature (t_p)	10 sec.	10 sec.
Ramp-Down	6°C / sec.	6°C / sec.

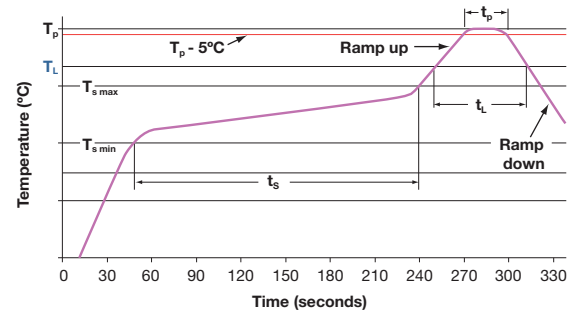

*Reflow soldering referring to JEDEC Standard with some limitations
*JEDEC J-Std 020C

RECOMMENDED SOLDER PASTE THICKNESS

For optimum solderability, the recommended soldering paste thickness:
2220 to 2824 :150 to 200µm
4030 to 6054 :200 to 300µm

In case of hand soldering, the temperature of the soldering iron should not be above 250°C. Special care must be taken to avoid touching the capacitor body with the iron tip.

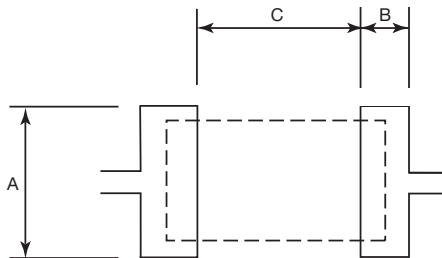

PAD DIMENSIONS: millimeters (inches)

Size Code	Case Size	A	B	C
04	2220	5.00 (0.195)	1.90 (0.075)	4.50 (0.178)
05	2824	6.00 (0.234)	2.50 (0.098)	5.70 (0.224)
16	4030	7.50 (0.295)	3.00 (0.118)	8.00 (0.315)
17	5040	11.2 (0.441)	3.50 (0.137)	10.3 (0.406)
18	6064	14.6 (0.575)	3.60 (0.147)	12.6 (0.496)

RECOMMENDED CLEANING

To clean flux from the PC board assembly, the recommended products are: ethanol, isopropyl alcohol, and deionized water wash. The cleaning products to avoid are: Toluene, Xylene, Trichloroethylene, Terpene Cleaner EC-7, surface active agent. In case of using another solvent, please contact us.

OTHER CAUTIONS

Flame retardancy: the dielectric film is not a flame retardant material.

Environment: contact us when chips are used in humid or gas atmosphere and /or when using resin.

Recommended handling: do not use edged tools, so not to damage the capacitors.

TIN WHISKERS TESTS : JEDEC STANDARD NO 22A121

Stress Type	Ref. Spec.	Test Conditions	Analysis	Results
Temperature cycling	JESD22-A104	-55°C +85(+10/-0)°C air 5 to 10 minutes soak 3 cycles/hour	SEM x 1000	Pass
Ambient Temperature / Humidity Storage		30+/-2°C - 60+/-3% RH -2000H	SEM x 1000	Pass
High Temperature / Humidity Storage		70+/-5°C - 93+3/-2% RH -1000H	SEM x 1000	Pass



Film Chip Capacitors

PET-HT DIELECTRIC – CB Series



ELECTRICAL CHARACTERISTICS VERSUS TEMPERATURE AND FREQUENCY

ELECTRICAL CHARACTERISTICS

Capacitance

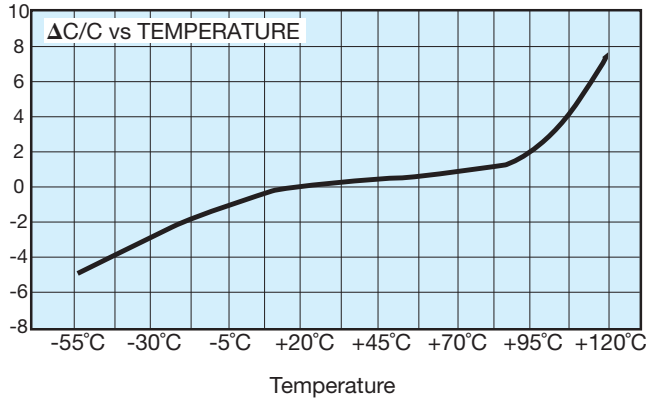

FREQUENCY CHARACTERISTICS

Capacitance

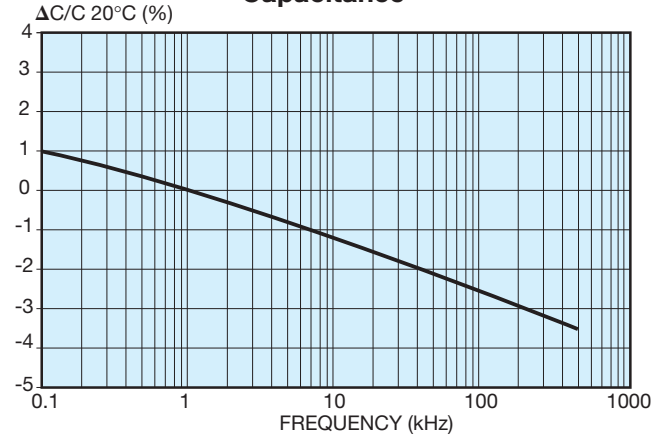

Dissipation Factor

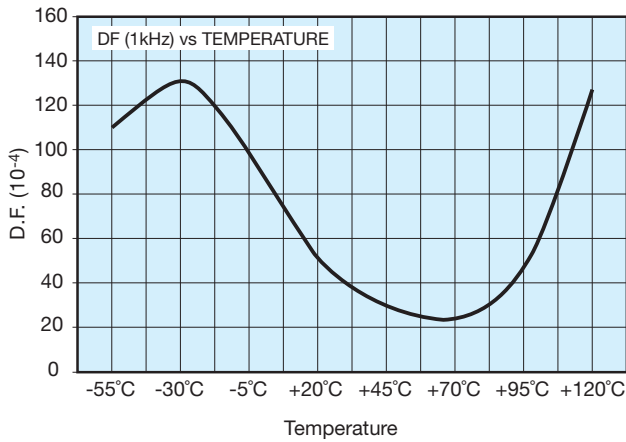

Dissipation Factor

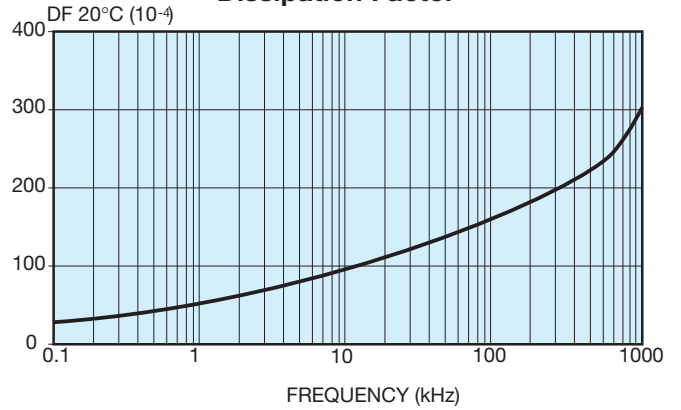

Insulation Resistance

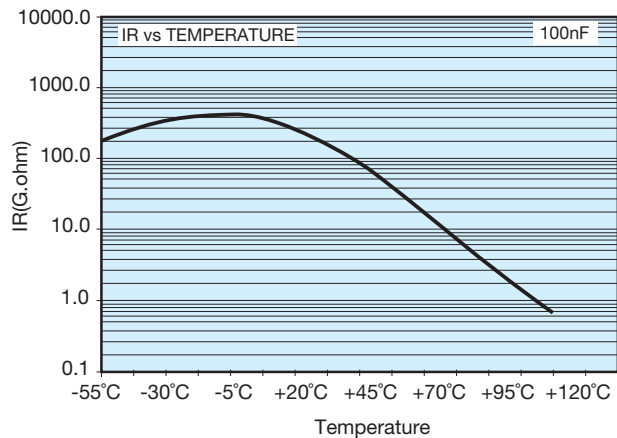

Impedance

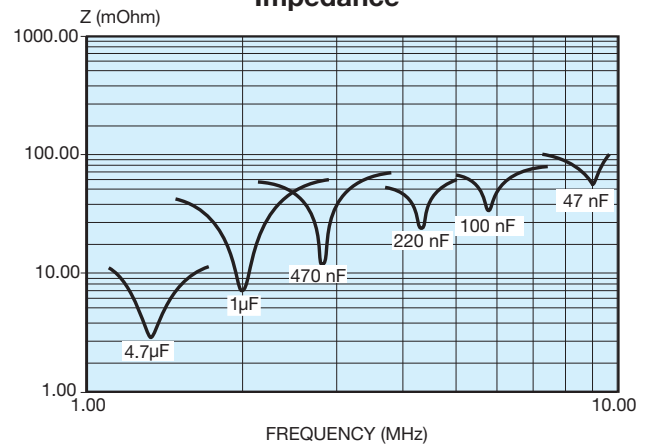

RMS VOLTAGE AND CURRENT VERSUS FREQUENCY

MAXIMUM VOLTAGE (V_{RMS}) AND CURRENT (I_{RMS}) VS FREQUENCY

Typical curves results from measurement carried out at ambient temperature (25°C) and sinusoidal wave-forms (for size CB04 to CB18)

63Vdc / 40 Vac

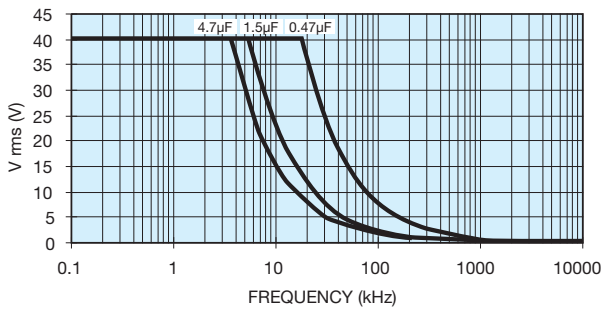

63Vdc / 40 Vac

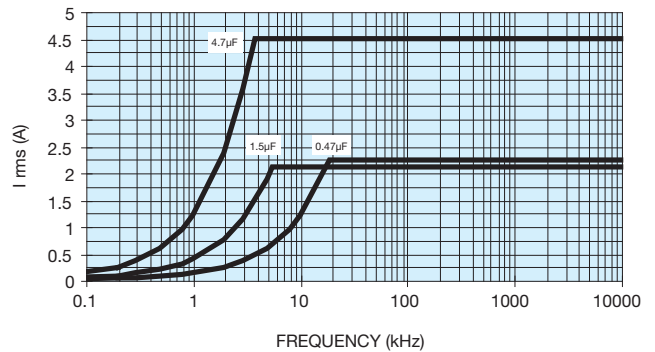

100 Vdc / 63 Vac

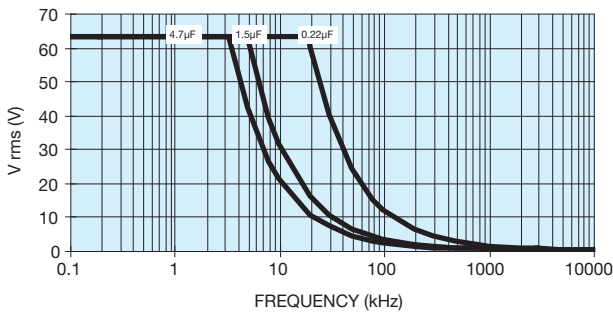

100 Vdc / 63 Vac

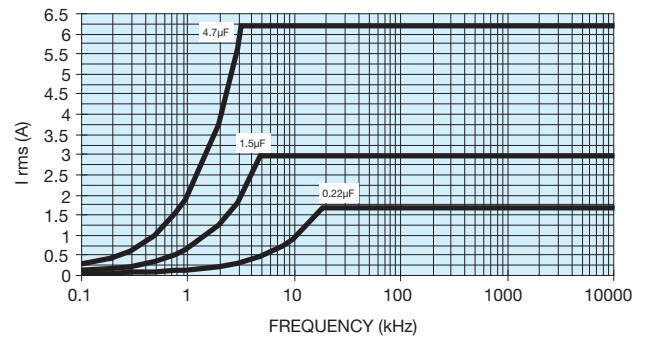

250 Vdc / 160 Vac

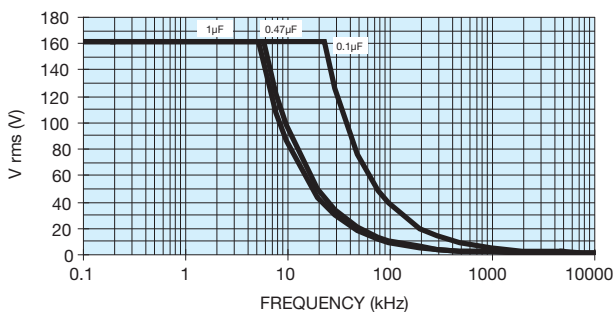

250 Vdc / 160 Vac

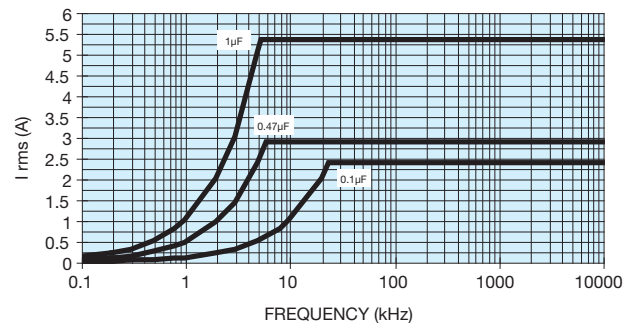

Film Chip Capacitors

PET-HT DIELECTRIC – CB Series



RMS VOLTAGE AND CURRENT VERSUS FREQUENCY

MAXIMUM VOLTAGE (V_{RMS}) AND CURRENT (I_{RMS}) VS FREQUENCY

Typical curves results from measurement carried out at ambient temperature (25°C) and sinusoidal wave-forms (for size CB04 to CB18)

400 Vdc / 200 Vac

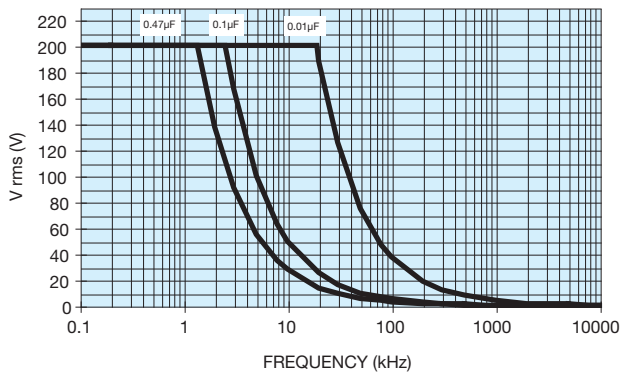

400 Vdc / 200 Vac

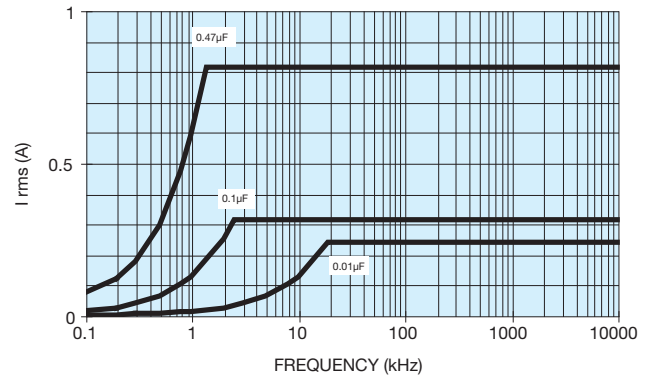

630 Vdc / 250 Vac

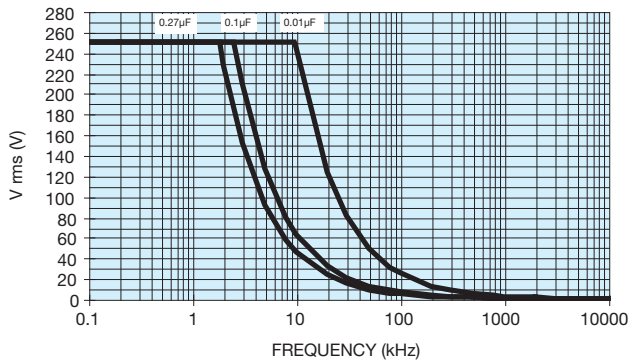

630 Vdc / 250 Vac

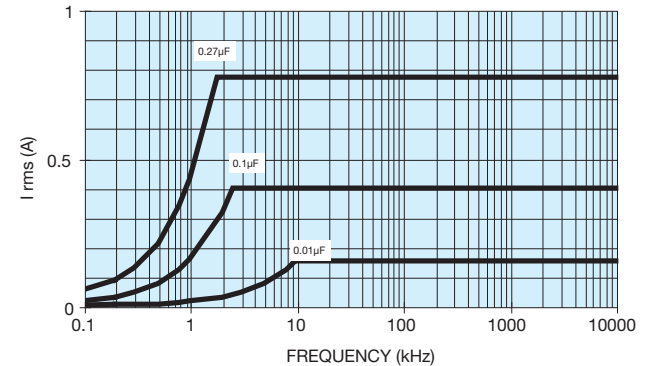

MAXIMUM PULSE RISE TIME (DV/DT)

Voltage Range	63	100	250	400	630
Dv/dt max. (V/µsec)	40	50	150	200	250

Film Chip Capacitors



PET-HT DIELECTRIC – CB Series – RoHS

MATERIALS CONTROLLED BY ROHS (PPM BY WEIGHT):

Mass / unit (g)	Lead	Mercury	Cadmium	Hexavalent Chromium	PBB	PBDE
CB range	0	0	0	0	0	0
RoHS Limit (ppm)	1000	1000	100	1000	1000	1000
Pass/Fail	Pass	Pass	Pass	Pass	Pass	Pass

This product has been tested and found to be compliant with all requirements, provisions, and exemptions of EU Directive 2002/95/EC of the European Parliament and Council of January 27, 2003. On the Restriction of use of certain Hazardous Substances (RoHS) in electrical and electronic equipment and EU Directive 2000/53/EC regarding ELV or End of Life Vehicle.

<p>ROHS / ELV STATUS</p> <p>External Plating 100% Matte Sn as standard</p>	<p>LEAD-FREE STATUS / MOISTURE SENSITIVITY RANKING</p> <p>Pb Free Reflow Solder compliant, MSL = 3. Reflow soldering referring to Jedec Standard with some limitations. Additional JESD-97 data to be phased in MSL e3 termination.</p>
---------------------------------------------------------------------------------------	----------------------------------------------------------------------------------------------------------------------------------------------------------------------------------------------------------------------------------------------------

PRODUCT LABELING:

(For informational purposes only to be phased in on reel and container.)

PRODUCT TRACEABILITY:

Full internal material traceability by reference to unique lot number marked on reel and external package.

Pb Free:



RoHS Compliant:



Film Chip Capacitors



PEN DIELECTRIC – CB Series

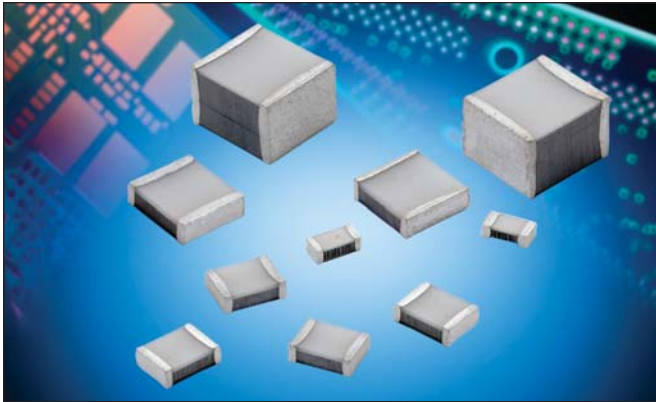

GENERAL DESCRIPTION

Film chip capacitor using a naked and stacked construction with metallized PEN (polyethylene naphthalate).

ADVANTAGES

- Use of high temperature dielectric films make these capacitors suitable for IR or vapor phase reflow processes. This chip is built without specific encapsulation.
- The intrinsic elasticity of the dielectric film allows an excellent compatibility of the capacitor with all types of material for printed circuit boards.
- The self-healing property of film technology results to a safety open failure mode and better overall reliability.
- Excellent thermal shock resistance.
- Low dissipation factor ESR & ESL.
- No piezoelectric effect.
- Available in tape and reel suitable for automatic placement.
- Non-polar construction.

APPLICATIONS

General purpose function in low voltage applications where miniaturization and SMD is required. Typical applications would be:

- Automotive (Airbag, Fuel injection calculator...)
- Telecom (Public switching systems, modems, telephone set, cordless, mobile)
- Industrial (SMPS, Power convertor module...)

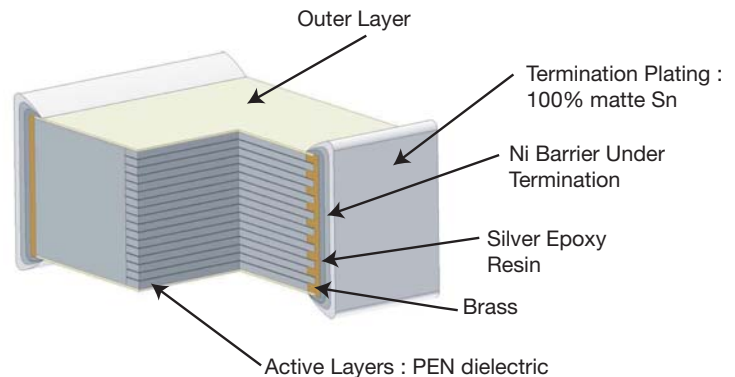

PERFORMANCE CHARACTERISTICS

Climatic Category	55/125/56
Capacitance Range	1nF to 4.7 μ F
Tolerance on C _R	\pm 5%, \pm 10%
Nominal Voltages	25Vdc to 630Vdc
Test Voltage	1.4Vr 2 sec. at 25°C
Soldering methods	IR or vapor phase reflow (not suitable for wave soldering)
Tangent of Loss Angle at 1kHz (DF)	< 100 x 10 ⁻⁴
Insulation resistance minimum : IR	for C \leq 0.33 μ F IR > 1000 M Ω at 20°C for 1 min. charge at 10Vdc for VR < 100Vdc and 100Vdc for VR \geq 100Vdc for C > 0.33 μ F IR C > 400 sec. at 20°C for 1 min. charge at 10Vdc for VR < 100Vdc and 100Vdc for VR \geq 100Vdc
Temperature range	-55°C to 125°C with voltage derating of 1.25%/°C between 105°C and 125°C
A.C. applications	For high frequency A.C. application please check with AVX

Film Chip Capacitors



PEN DIELECTRIC – CB Series

CAPACITANCE VALUES (CR) AND NOMINAL VOLTAGES (VR)

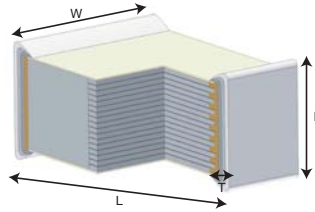

millimeters (inches)

Capacitance Range (CR)	Ordering Code	VOLTAGE Vdc: 25V Vac: 16V											Packaging Unit		Reel Pkg Code
		Chip Dimensions *Tolerances (page 6)				Tape Dimensions			Reel Dimensions			Bulk	Reel		
		L	W	H max	T	W	P1	K0	A	W1	W2 max				
0.001µF	CB017C0102+ --	3.30 (0.130)	1.60 (0.063)	1.15 (0.045)	0.50 (0.020)	8.00 (0.315)	4.00 (0.158)	1.20 (0.047)	180 (7.087)	8.40 (0.331)	14.4 (0.567)	2000	3900	BA	
0.0012	CB017C0122+ --	3.30 (0.130)	1.60 (0.063)	1.15 (0.045)	0.50 (0.020)	8.00 (0.315)	4.00 (0.158)	1.20 (0.047)	180 (7.087)	8.40 (0.331)	14.4 (0.567)	2000	3900	BA	
0.0015	CB017C0152+ --	3.30 (0.130)	1.60 (0.063)	1.15 (0.045)	0.50 (0.020)	8.00 (0.315)	4.00 (0.158)	1.20 (0.047)	180 (7.087)	8.40 (0.331)	14.4 (0.567)	2000	3900	BA	
0.0018	CB017C0182+ --	3.30 (0.130)	1.60 (0.063)	1.15 (0.045)	0.50 (0.020)	8.00 (0.315)	4.00 (0.158)	1.20 (0.047)	180 (7.087)	8.40 (0.331)	14.4 (0.567)	2000	3900	BA	
0.0022	CB017C0222+ --	3.30 (0.130)	1.60 (0.063)	1.15 (0.045)	0.50 (0.020)	8.00 (0.315)	4.00 (0.158)	1.20 (0.047)	180 (7.087)	8.40 (0.331)	14.4 (0.567)	2000	3900	BA	
0.0027	CB017C0272+ --	3.30 (0.130)	1.60 (0.063)	1.15 (0.045)	0.50 (0.020)	8.00 (0.315)	4.00 (0.158)	1.20 (0.047)	180 (7.087)	8.40 (0.331)	14.4 (0.567)	2000	3900	BA	
0.0033	CB017C0332+ --	3.30 (0.130)	1.60 (0.063)	1.15 (0.045)	0.50 (0.020)	8.00 (0.315)	4.00 (0.158)	1.20 (0.047)	180 (7.087)	8.40 (0.331)	14.4 (0.567)	2000	3900	BA	
0.0047	CB017C0472+ --	3.30 (0.130)	1.60 (0.063)	1.15 (0.045)	0.50 (0.020)	8.00 (0.315)	4.00 (0.158)	1.20 (0.047)	180 (7.087)	8.40 (0.331)	14.4 (0.567)	2000	3900	BA	
0.0056	CB017C0562+ --	3.30 (0.130)	1.60 (0.063)	1.15 (0.045)	0.50 (0.020)	8.00 (0.315)	4.00 (0.158)	1.20 (0.047)	180 (7.087)	8.40 (0.331)	14.4 (0.567)	2000	3900	BA	
0.0068	CB017C0682+ --	3.30 (0.130)	1.60 (0.063)	1.15 (0.045)	0.50 (0.020)	8.00 (0.315)	4.00 (0.158)	1.20 (0.047)	180 (7.087)	8.40 (0.331)	14.4 (0.567)	2000	3900	BA	
0.0082	CB017C0822+ --	3.30 (0.130)	1.60 (0.063)	1.15 (0.045)	0.50 (0.020)	8.00 (0.315)	4.00 (0.158)	1.20 (0.047)	180 (7.087)	8.40 (0.331)	14.4 (0.567)	2000	3900	BA	
0.010µF	CB017C0103+ --	3.30 (0.130)	1.60 (0.063)	1.15 (0.045)	0.50 (0.020)	8.00 (0.315)	4.00 (0.158)	1.20 (0.047)	180 (7.087)	8.40 (0.331)	14.4 (0.567)	2000	3900	BA	
0.012	CB017C0123+ --	3.30 (0.130)	1.60 (0.063)	1.15 (0.045)	0.50 (0.020)	8.00 (0.315)	4.00 (0.158)	1.20 (0.047)	180 (7.087)	8.40 (0.331)	14.4 (0.567)	2000	3900	BA	
0.015	CB017C0153+ --	3.30 (0.130)	1.60 (0.063)	1.15 (0.045)	0.50 (0.020)	8.00 (0.315)	4.00 (0.158)	1.20 (0.047)	180 (7.087)	8.40 (0.331)	14.4 (0.567)	2000	3900	BA	
0.018	CB017C0183+ --	3.30 (0.130)	1.60 (0.063)	1.15 (0.045)	0.50 (0.020)	8.00 (0.315)	4.00 (0.158)	1.20 (0.047)	180 (7.087)	8.40 (0.331)	14.4 (0.567)	2000	3900	BA	
0.022	CB017C0223+ --	3.30 (0.130)	1.60 (0.063)	1.15 (0.045)	0.50 (0.020)	8.00 (0.315)	4.00 (0.158)	1.20 (0.047)	180 (7.087)	8.40 (0.331)	14.4 (0.567)	2000	3900	BA	
0.027	CB027C0273+ --	3.30 (0.130)	2.50 (0.098)	1.80 (0.071)	0.50 (0.020)	8.00 (0.315)	4.00 (0.158)	1.90 (0.075)	180 (7.087)	8.40 (0.331)	14.4 (0.567)	2000	2500	BA	
0.033	CB027C0333+ --	3.30 (0.130)	2.50 (0.098)	1.80 (0.071)	0.50 (0.020)	8.00 (0.315)	4.00 (0.158)	1.90 (0.075)	180 (7.087)	8.40 (0.331)	14.4 (0.567)	2000	2500	BA	
0.047	CB027C0473+ --	3.30 (0.130)	2.50 (0.098)	1.80 (0.071)	0.50 (0.020)	8.00 (0.315)	4.00 (0.158)	1.90 (0.075)	180 (7.087)	8.40 (0.331)	14.4 (0.567)	2000	2500	BA	
0.056	CB027C0563+ --	3.30 (0.130)	2.50 (0.098)	1.80 (0.071)	0.50 (0.020)	8.00 (0.315)	4.00 (0.158)	1.90 (0.075)	180 (7.087)	8.40 (0.331)	14.4 (0.567)	2000	2500	BA	
0.068	CB027C0683+ --	3.30 (0.130)	2.50 (0.098)	1.80 (0.071)	0.50 (0.020)	8.00 (0.315)	4.00 (0.158)	1.90 (0.075)	180 (7.087)	8.40 (0.331)	14.4 (0.567)	2000	2500	BA	
0.082	CB027C0823+ --	3.30 (0.130)	2.50 (0.098)	2.20 (0.087)	0.50 (0.020)	8.00 (0.315)	4.00 (0.158)	2.33 (0.092)	180 (7.087)	8.40 (0.331)	14.4 (0.567)	2000	2000	BA	
0.100µF	CB027C0104+ --	3.30 (0.130)	2.50 (0.098)	2.30 (0.091)	0.50 (0.020)	8.00 (0.315)	4.00 (0.158)	2.33 (0.092)	180 (7.087)	8.40 (0.331)	14.4 (0.567)	2000	2000	BA	

For other Values: upon request

Replace the + by the tolerance code: J = 5% or K = 10%

Replace the -- by the packaging suffix: -- = bulk

BA = tape & reel



Film Chip Capacitors



PEN DIELECTRIC – CB Series

CAPACITANCE VALUES (CR) AND NOMINAL VOLTAGES (VR)

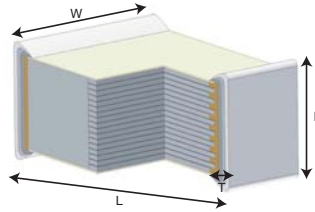

millimeters (inches)

Capacitance Range (CR)	Ordering Code	VOLTAGE Vdc: 50V Vac: 40V											Packaging Unit		Reel Pkg Code
		Chip Dimensions *Tolerances (page 6)				Tape Dimensions			Reel Dimensions			Bulk	Reel		
		L	W	H max	T	W	P1	K0	A	W1	W2 max				
0.001µF	CB017D0102+ --	3.30 (0.130)	1.60 (0.063)	1.15 (0.045)	0.50 (0.020)	8.00 (0.315)	4.00 (0.158)	1.20 (0.047)	180 (7.087)	8.40 (0.331)	14.4 (0.567)	2000	3900	BA	
0.0012	CB017D0122+ --	3.30 (0.130)	1.60 (0.063)	1.15 (0.045)	0.50 (0.020)	8.00 (0.315)	4.00 (0.158)	1.20 (0.047)	180 (7.087)	8.40 (0.331)	14.4 (0.567)	2000	3900	BA	
0.0015	CB017D0152+ --	3.30 (0.130)	1.60 (0.063)	1.15 (0.045)	0.50 (0.020)	8.00 (0.315)	4.00 (0.158)	1.20 (0.047)	180 (7.087)	8.40 (0.331)	14.4 (0.567)	2000	3900	BA	
0.0018	CB017D0182+ --	3.30 (0.130)	1.60 (0.063)	1.15 (0.045)	0.50 (0.020)	8.00 (0.315)	4.00 (0.158)	1.20 (0.047)	180 (7.087)	8.40 (0.331)	14.4 (0.567)	2000	3900	BA	
0.0022	CB017D0222+ --	3.30 (0.130)	1.60 (0.063)	1.15 (0.045)	0.50 (0.020)	8.00 (0.315)	4.00 (0.158)	1.20 (0.047)	180 (7.087)	8.40 (0.331)	14.4 (0.567)	2000	3900	BA	
0.0027	CB017D0272+ --	3.30 (0.130)	1.60 (0.063)	1.15 (0.045)	0.50 (0.020)	8.00 (0.315)	4.00 (0.158)	1.20 (0.047)	180 (7.087)	8.40 (0.331)	14.4 (0.567)	2000	3900	BA	
0.0033	CB017D0332+ --	3.30 (0.130)	1.60 (0.063)	1.15 (0.045)	0.50 (0.020)	8.00 (0.315)	4.00 (0.158)	1.20 (0.047)	180 (7.087)	8.40 (0.331)	14.4 (0.567)	2000	3900	BA	
0.0047	CB017D0472+ --	3.30 (0.130)	1.60 (0.063)	1.15 (0.045)	0.50 (0.020)	8.00 (0.315)	4.00 (0.158)	1.20 (0.047)	180 (7.087)	8.40 (0.331)	14.4 (0.567)	2000	3900	BA	
0.0056	CB017D0562+ --	3.30 (0.130)	1.60 (0.063)	1.15 (0.045)	0.50 (0.020)	8.00 (0.315)	4.00 (0.158)	1.20 (0.047)	180 (7.087)	8.40 (0.331)	14.4 (0.567)	2000	3900	BA	
0.0068	CB017D0682+ --	3.30 (0.130)	1.60 (0.063)	1.15 (0.045)	0.50 (0.020)	8.00 (0.315)	4.00 (0.158)	1.20 (0.047)	180 (7.087)	8.40 (0.331)	14.4 (0.567)	2000	3900	BA	
0.0082	CB017D0822+ --	3.30 (0.130)	1.60 (0.063)	1.15 (0.045)	0.50 (0.020)	8.00 (0.315)	4.00 (0.158)	1.20 (0.047)	180 (7.087)	8.40 (0.331)	14.4 (0.567)	2000	3900	BA	
0.010µF	CB017D0103+ --	3.30 (0.130)	1.60 (0.063)	1.15 (0.045)	0.50 (0.020)	8.00 (0.315)	4.00 (0.158)	1.20 (0.047)	180 (7.087)	8.40 (0.331)	14.4 (0.567)	2000	3900	BA	
0.012	CB017D0123+ --	3.30 (0.130)	1.60 (0.063)	1.15 (0.045)	0.50 (0.020)	8.00 (0.315)	4.00 (0.158)	1.20 (0.047)	180 (7.087)	8.40 (0.331)	14.4 (0.567)	2000	3900	BA	
0.015	CB017D0153+ --	3.30 (0.130)	1.60 (0.063)	1.15 (0.045)	0.50 (0.020)	8.00 (0.315)	4.00 (0.158)	1.20 (0.047)	180 (7.087)	8.40 (0.331)	14.4 (0.567)	2000	3900	BA	
0.018	CB017D0183+ --	3.30 (0.130)	1.60 (0.063)	1.15 (0.045)	0.50 (0.020)	8.00 (0.315)	4.00 (0.158)	1.20 (0.047)	180 (7.087)	8.40 (0.331)	14.4 (0.567)	2000	3900	BA	
0.022	CB017D0223+ --	3.30 (0.130)	1.60 (0.063)	1.15 (0.045)	0.50 (0.020)	8.00 (0.315)	4.00 (0.158)	1.20 (0.047)	180 (7.087)	8.40 (0.331)	14.4 (0.567)	2000	3900	BA	
0.027	CB027D0273+ --	3.30 (0.130)	2.50 (0.098)	1.80 (0.071)	0.50 (0.020)	8.00 (0.315)	4.00 (0.158)	1.90 (0.075)	180 (7.087)	8.40 (0.331)	14.4 (0.567)	2000	2500	BA	
0.033	CB027D0333+ --	3.30 (0.130)	2.50 (0.098)	1.80 (0.071)	0.50 (0.020)	8.00 (0.315)	4.00 (0.158)	1.90 (0.075)	180 (7.087)	8.40 (0.331)	14.4 (0.567)	2000	2500	BA	
0.047	CB027D0473+ --	3.30 (0.130)	2.50 (0.098)	1.80 (0.071)	0.50 (0.020)	8.00 (0.315)	4.00 (0.158)	1.90 (0.075)	180 (7.087)	8.40 (0.331)	14.4 (0.567)	2000	2500	BA	
0.056	CB027D0563+ --	3.30 (0.130)	2.50 (0.098)	1.80 (0.071)	0.50 (0.020)	8.00 (0.315)	4.00 (0.158)	1.90 (0.075)	180 (7.087)	8.40 (0.331)	14.4 (0.567)	2000	2500	BA	
0.068	CB027D0683+ --	3.30 (0.130)	2.50 (0.098)	1.80 (0.071)	0.50 (0.020)	8.00 (0.315)	4.00 (0.158)	1.90 (0.075)	180 (7.087)	8.40 (0.331)	14.4 (0.567)	2000	2500	BA	
0.082	CB027D0823+ --	3.30 (0.130)	2.50 (0.098)	2.20 (0.087)	0.50 (0.020)	8.00 (0.315)	4.00 (0.158)	2.33 (0.092)	180 (7.087)	8.40 (0.331)	14.4 (0.567)	2000	2000	BA	
0.100µF	CB027D0104+ --	3.30 (0.130)	2.50 (0.098)	2.30 (0.091)	0.50 (0.020)	8.00 (0.315)	4.00 (0.158)	2.33 (0.092)	180 (7.087)	8.40 (0.331)	14.4 (0.567)	2000	2000	BA	

For other Values: upon request

Replace the + by the tolerance code: J = 5% or K = 10%

Replace the -- by the packaging suffix: -- = bulk

BA = tape & reel



Film Chip Capacitors



PEN DIELECTRIC – CB Series

CAPACITANCE VALUES (CR) AND NOMINAL VOLTAGES (VR)

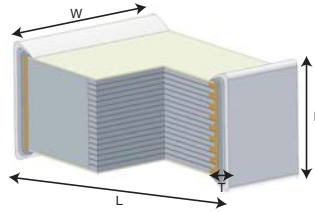

millimeters (inches)

Capacitance Range (CR)	Ordering Code	VOLTAGE Vdc: 63V Vac: 40V												
		Chip Dimensions *Tolerances (page 6)				Tape Dimensions			Reel Dimensions			Packaging Unit		Reel Pkg Code
		L	W	H max	T	W	P1	K0	A	W1	W2 max	Bulk	Reel	
0.001μF	CB037D0102+ --	4.70 (0.185)	3.20 (0.126)	1.90 (0.075)	0.60 (0.024)	12.0 (0.472)	8.00 (0.315)	2.06 (0.081)	180 (7.09)	12.4 (0.488)	18.4 (0.724)	1500	1200	BA
		4.70 (0.185)	3.20 (0.126)	1.90 (0.075)	0.60 (0.024)	12.0 (0.472)	8.00 (0.315)	2.06 (0.081)	330 (12.99)	12.4 (0.488)	18.4 (0.724)	1500	4500	BC
0.0012	CB037D0122+ --	4.70 (0.185)	3.20 (0.126)	1.90 (0.075)	0.60 (0.024)	12.0 (0.472)	8.00 (0.315)	2.06 (0.081)	180 (7.09)	12.4 (0.488)	18.4 (0.724)	1500	1200	BA
		4.70 (0.185)	3.20 (0.126)	1.90 (0.075)	0.60 (0.024)	12.0 (0.472)	8.00 (0.315)	2.06 (0.081)	330 (12.99)	12.4 (0.488)	18.4 (0.724)	1500	4500	BC
0.0015	CB037D0152+ --	4.70 (0.185)	3.20 (0.126)	1.90 (0.075)	0.60 (0.024)	12.0 (0.472)	8.00 (0.315)	2.06 (0.081)	180 (7.09)	12.4 (0.488)	18.4 (0.724)	1500	1200	BA
		4.70 (0.185)	3.20 (0.126)	1.90 (0.075)	0.60 (0.024)	12.0 (0.472)	8.00 (0.315)	2.06 (0.081)	330 (12.99)	12.4 (0.488)	18.4 (0.724)	1500	4500	BC
0.0018	CB037D0182+ --	4.70 (0.185)	3.20 (0.126)	1.90 (0.075)	0.6 (0.024)	12.0 (0.472)	8.0 (0.315)	2.06 (0.081)	180 (7.09)	12.4 (0.488)	18.4 (0.724)	1500	1200	BA
		4.70 (0.185)	3.20 (0.126)	1.90 (0.075)	0.60 (0.024)	12.0 (0.472)	8.00 (0.315)	2.06 (0.081)	330 (12.99)	12.4 (0.488)	18.4 (0.724)	1500	4500	BC
0.0022	CB037D0222+ --	4.70 (0.185)	3.20 (0.126)	1.90 (0.075)	0.60 (0.024)	12.0 (0.472)	8.00 (0.315)	2.06 (0.081)	180 (7.09)	12.4 (0.488)	18.4 (0.724)	1500	1200	BA
		4.70 (0.185)	3.20 (0.126)	1.90 (0.075)	0.60 (0.024)	12.0 (0.472)	8.00 (0.315)	2.06 (0.081)	330 (12.99)	12.4 (0.488)	18.4 (0.724)	1500	4500	BC
0.0027	CB037D0272+ --	4.70 (0.185)	3.20 (0.126)	1.90 (0.075)	0.6 (0.024)	12.0 (0.472)	8.00 (0.315)	2.06 (0.081)	180 (7.09)	12.4 (0.488)	18.4 (0.724)	1500	1200	BA
		4.70 (0.185)	3.20 (0.126)	1.90 (0.075)	0.60 (0.024)	12.0 (0.472)	8.00 (0.315)	2.06 (0.081)	330 (12.99)	12.4 (0.488)	18.4 (0.724)	1500	4500	BC
0.0033	CB037D0332+ --	4.70 (0.185)	3.20 (0.126)	1.90 (0.075)	0.60 (0.024)	12.0 (0.472)	8.00 (0.315)	2.06 (0.081)	180 (7.09)	12.4 (0.488)	18.4 (0.724)	1500	1200	BA
		4.70 (0.185)	3.20 (0.126)	1.90 (0.075)	0.60 (0.024)	12.0 (0.472)	8.00 (0.315)	2.06 (0.081)	330 (12.99)	12.4 (0.488)	18.4 (0.724)	1500	4500	BC
0.0047	CB037D0472+ --	4.70 (0.185)	3.20 (0.126)	2.00 (0.079)	0.60 (0.024)	12.0 (0.472)	8.00 (0.315)	2.06 (0.081)	180 (7.09)	12.4 (0.488)	18.4 (0.724)	1500	1200	BA
		4.70 (0.185)	3.20 (0.126)	2.00 (0.079)	0.60 (0.024)	12.0 (0.472)	8.00 (0.315)	2.06 (0.081)	330 (12.99)	12.4 (0.488)	18.4 (0.724)	1500	4500	BC
0.0056	CB037D0562+ --	4.70 (0.185)	3.20 (0.126)	1.90 (0.075)	0.60 (0.024)	12.0 (0.472)	8.00 (0.315)	2.06 (0.081)	180 (7.09)	12.4 (0.488)	18.4 (0.724)	1500	1200	BA
		4.70 (0.185)	3.20 (0.126)	1.90 (0.075)	0.60 (0.024)	12.0 (0.472)	8.00 (0.315)	2.06 (0.081)	330 (12.99)	12.4 (0.488)	18.4 (0.724)	1500	4500	BC
0.0068	CB037D0682+ --	4.70 (0.185)	3.20 (0.126)	2.00 (0.079)	0.60 (0.024)	12.0 (0.472)	8.00 (0.315)	2.06 (0.081)	180 (7.09)	12.4 (0.488)	18.4 (0.724)	1500	1200	BA
		4.70 (0.185)	3.20 (0.126)	2.00 (0.079)	0.60 (0.024)	12.0 (0.472)	8.00 (0.315)	2.06 (0.081)	330 (12.99)	12.4 (0.488)	18.4 (0.724)	1500	4500	BC
0.0082	CB037D0822+ --	4.70 (0.185)	3.20 (0.126)	1.90 (0.075)	0.6 (0.024)	12.0 (0.472)	8.00 (0.315)	2.06 (0.081)	180 (7.09)	12.4 (0.488)	18.4 (0.724)	1500	1200	BA
		4.70 (0.185)	3.20 (0.126)	1.90 (0.075)	0.60 (0.024)	12.0 (0.472)	8.00 (0.315)	2.06 (0.081)	330 (12.99)	12.4 (0.488)	18.4 (0.724)	1500	4500	BC
0.010μF	CB037D0103+ --	4.70 (0.185)	3.20 (0.126)	2.00 (0.079)	0.60 (0.024)	12.0 (0.472)	8.00 (0.315)	2.06 (0.081)	180 (7.09)	12.4 (0.488)	18.4 (0.724)	1500	1200	BA

For other Values: upon request

Replace the + by the tolerance code: J = 5% or K = 10%

Replace the -- by the packaging suffix: -- = bulk

BA or BC = tape & reel



Film Chip Capacitors



PEN DIELECTRIC – CB Series

CAPACITANCE VALUES (CR) AND NOMINAL VOLTAGES (VR)

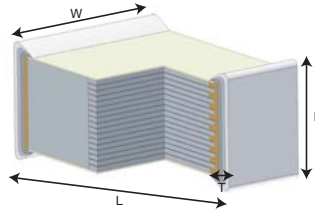

Capacitance Range (CR)	Ordering Code	VOLTAGE Vdc: 63V Vac: 40V												
		Chip Dimensions *Tolerances (page 6)				Tape Dimensions			Reel Dimensions			Packaging Unit		Reel Pkg Code
		L	W	H max	T	W	P1	K0	A	W1	W2 max	Bulk	Reel	
0.010µF	CB037D0103+ --	4.70 (0.185)	3.20 (0.126)	2.00 (0.079)	0.60 (0.024)	12.0 (0.472)	8.0 (0.315)	2.06 (0.081)	330 (12.99)	12.4 (0.488)	18.4 (0.724)	1500	4500	BC
0.012	CB037D0123+ --	4.70 (0.185)	3.20 (0.126)	2.00 (0.079)	0.60 (0.024)	12.0 (0.472)	8.00 (0.315)	2.06 (0.081)	180 (7.09)	12.4 (0.488)	18.4 (0.724)	1500	1200	BA
		4.70 (0.185)	3.20 (0.126)	2.00 (0.079)	0.60 (0.024)	12.0 (0.472)	8.00 (0.315)	2.06 (0.081)	330 (12.99)	12.4 (0.488)	18.4 (0.724)	1500	4500	BC
0.015	CB037D0153+ --	4.70 (0.185)	3.20 (0.126)	2.40 (0.095)	0.60 (0.024)	12.0 (0.472)	8.00 (0.315)	2.60 (0.102)	180 (7.09)	12.4 (0.488)	18.4 (0.724)	1500	900	BA
		4.70 (0.185)	3.20 (0.126)	2.40 (0.095)	0.60 (0.024)	12.0 (0.472)	8.00 (0.315)	2.60 (0.102)	330 (12.99)	12.4 (0.488)	18.4 (0.724)	1500	3600	BC
0.018	CB037D0183+ --	4.70 (0.185)	3.20 (0.126)	2.50 (0.099)	0.60 (0.024)	12.0 (0.472)	8.00 (0.315)	2.60 (0.102)	180 (7.09)	12.4 (0.488)	18.4 (0.724)	1500	900	BA
		4.70 (0.185)	3.20 (0.126)	2.50 (0.099)	0.60 (0.024)	12.0 (0.472)	8.00 (0.315)	2.60 (0.102)	330 (12.99)	12.4 (0.488)	18.4 (0.724)	1500	3600	BC
0.022	CB037D0223+ --	4.70 (0.185)	3.20 (0.126)	2.00 (0.079)	0.60 (0.024)	12.0 (0.472)	8.00 (0.315)	2.06 (0.081)	180 (7.09)	12.4 (0.488)	18.4 (0.724)	1500	1200	BA
		4.70 (0.185)	3.20 (0.126)	2.00 (0.079)	0.60 (0.024)	12.0 (0.472)	8.00 (0.315)	2.06 (0.081)	330 (12.99)	12.4 (0.488)	18.4 (0.724)	1500	4500	BC
0.027	CB037D0273+ --	4.70 (0.185)	3.20 (0.126)	1.90 (0.075)	0.60 (0.024)	12.0 (0.472)	8.00 (0.315)	2.06 (0.081)	180 (7.09)	12.4 (0.488)	18.4 (0.724)	1500	1200	BA
		4.70 (0.185)	3.20 (0.126)	1.90 (0.075)	0.60 (0.024)	12.0 (0.472)	8.00 (0.315)	2.06 (0.081)	330 (12.99)	12.4 (0.488)	18.4 (0.724)	1500	4500	BC
0.033	CB037D0333+ --	4.70 (0.185)	3.20 (0.126)	2.00 (0.079)	0.60 (0.024)	12.0 (0.472)	8.00 (0.315)	2.06 (0.081)	180 (7.09)	12.4 (0.488)	18.4 (0.724)	1500	1200	BA
		4.70 (0.185)	3.20 (0.126)	2.00 (0.079)	0.60 (0.024)	12.0 (0.472)	8.00 (0.315)	2.06 (0.081)	330 (12.99)	12.4 (0.488)	18.4 (0.724)	1500	4500	BC
0.047	CB037D0473+ --	4.70 (0.185)	3.20 (0.126)	2.70 (0.107)	0.60 (0.024)	12.0 (0.472)	8.00 (0.315)	3.10 (0.122)	180 (7.09)	12.4 (0.488)	18.4 (0.724)	1500	700	BA
		4.70 (0.185)	3.20 (0.126)	2.70 (0.107)	0.60 (0.024)	12.0 (0.472)	8.00 (0.315)	3.10 (0.122)	330 (12.99)	12.4 (0.488)	18.4 (0.724)	1500	3000	BC
0.056	CB037D0563+ --	4.70 (0.185)	3.20 (0.126)	2.30 (0.091)	0.60 (0.024)	12.0 (0.472)	8.00 (0.315)	2.60 (0.102)	180 (7.09)	12.4 (0.488)	18.4 (0.724)	1500	900	BA
		4.70 (0.185)	3.20 (0.126)	2.30 (0.091)	0.60 (0.024)	12.0 (0.472)	8.00 (0.315)	2.60 (0.102)	330 (12.99)	12.4 (0.488)	18.4 (0.724)	1500	3600	BC
0.068	CB037D0683+ --	4.70 (0.185)	3.20 (0.126)	2.00 (0.079)	0.60 (0.024)	12.0 (0.472)	8.00 (0.315)	2.06 (0.081)	180 (7.09)	12.4 (0.488)	18.4 (0.724)	1500	1200	BA
		4.70 (0.185)	3.20 (0.126)	2.00 (0.079)	0.60 (0.024)	12.0 (0.472)	8.00 (0.315)	2.06 (0.081)	330 (12.99)	12.4 (0.488)	18.4 (0.724)	1500	4500	BC
0.082	CB037D0823+ --	4.70 (0.185)	3.20 (0.126)	2.50 (0.099)	0.60 (0.024)	12.0 (0.472)	8.00 (0.315)	2.60 (0.102)	180 (7.09)	12.4 (0.488)	18.4 (0.724)	1500	900	BA
		4.70 (0.185)	3.20 (0.126)	2.50 (0.099)	0.60 (0.024)	12.0 (0.472)	8.00 (0.315)	2.60 (0.102)	330 (12.99)	12.4 (0.488)	18.4 (0.724)	1500	3600	BC
0.100µF	CB037D0104+ --	4.70 (0.185)	3.20 (0.126)	2.80 (0.111)	0.60 (0.024)	12.0 (0.472)	8.00 (0.315)	3.10 (0.122)	180 (7.09)	12.4 (0.488)	18.4 (0.724)	1500	700	BA
		4.70 (0.185)	3.20 (0.126)	2.80 (0.111)	0.60 (0.024)	12.0 (0.472)	8.00 (0.315)	3.10 (0.122)	330 (12.99)	12.4 (0.488)	18.4 (0.724)	1500	3000	BC

For other Values: upon request
 Replace the + by the tolerance code: J = 5% or K = 10%
 Replace the -- by the packaging suffix: -- = bulk
 BA or BC = tape & reel



Film Chip Capacitors



PEN DIELECTRIC – CB Series

CAPACITANCE VALUES (CR) AND NOMINAL VOLTAGES (VR)

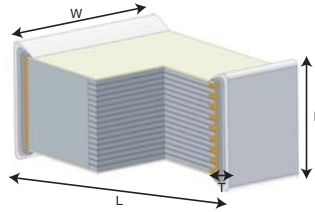

Capacitance Range (CR)	Ordering Code	VOLTAGE Vdc: 63V Vac: 40V												
		Chip Dimensions *Tolerances (page 6)				Tape Dimensions			Reel Dimensions			Packaging Unit		Reel Pkg Code
		L	W	H max	T	W	P1	K0	A	W1	W2 max	Bulk	Reel	
0.120	CB037D0124+ --	4.70 (0.185)	3.20 (0.126)	2.30 (0.091)	0.60 (0.024)	12.0 (0.472)	8.00 (0.315)	2.60 (0.102)	180 (7.087)	12.4 (0.488)	18.4 (0.724)	1500	900	BA
		4.70 (0.185)	3.20 (0.126)	2.30 (0.091)	0.60 (0.024)	12.0 (0.472)	8.00 (0.315)	2.60 (0.102)	330 (12.99)	12.4 (0.488)	18.4 (0.724)	1500	3600	BC
0.150	CB037D0154+ --	4.70 (0.185)	3.20 (0.126)	2.00 (0.079)	0.60 (0.024)	12.0 (0.472)	8.00 (0.315)	2.06 (0.081)	180 (7.087)	12.4 (0.488)	18.4 (0.724)	1500	1200	BA
		4.70 (0.185)	3.20 (0.126)	2.00 (0.079)	0.60 (0.024)	12.0 (0.472)	8.00 (0.315)	2.06 (0.081)	330 (12.99)	12.4 (0.488)	18.4 (0.724)	1500	4500	BC
0.180	CB037D0184+ --	4.70 (0.185)	3.20 (0.126)	2.40 (0.095)	0.60 (0.024)	12.0 (0.472)	8.00 (0.315)	2.60 (0.102)	180 (7.087)	12.4 (0.488)	18.4 (0.724)	1500	900	BA
		4.70 (0.185)	3.20 (0.126)	2.40 (0.095)	0.60 (0.024)	12.0 (0.472)	8.00 (0.315)	2.60 (0.102)	330 (12.99)	12.4 (0.488)	18.4 (0.724)	1500	3600	BC
0.220	CB037D0224+ --	4.70 (0.185)	3.20 (0.126)	3.00 (0.118)	0.60 (0.024)	12.0 (0.472)	8.00 (0.315)	3.10 (0.122)	180 (7.087)	12.4 (0.488)	18.4 (0.724)	1500	700	BA
		4.70 (0.185)	3.20 (0.126)	3.00 (0.118)	0.60 (0.024)	12.0 (0.472)	8.00 (0.315)	3.10 (0.122)	330 (12.99)	12.4 (0.488)	18.4 (0.724)	1500	3000	BC
0.330	CB047D0334+ --	5.80 (0.228)	5.00 (0.195)	4.00 (0.158)	0.80 (0.031)	16.0 (0.629)	8.00 (0.315)	4.10 (0.162)	330 (12.99)	12.4 (0.488)	18.4 (0.724)	1500	2300	BC
0.470	CB047D0474+ --	5.80 (0.228)	5.00 (0.195)	4.00 (0.158)	0.80 (0.031)	12.0 (0.472)	8.00 (0.315)	4.10 (0.162)	330 (12.99)	12.4 (0.488)	18.4 (0.724)	1500	2300	BC
0.560	CB047D0564+ --	5.80 (0.228)	5.00 (0.195)	2.50 (0.099)	0.80 (0.031)	12.0 (0.472)	8.00 (0.315)	3.10 (0.122)	330 (12.99)	12.4 (0.488)	18.4 (0.724)	1500	3000	BC
0.680	CB047D0684+ --	5.80 (0.228)	5.00 (0.195)	3.90 (0.154)	0.80 (0.031)	12.0 (0.472)	8.00 (0.315)	4.10 (0.162)	330 (12.99)	12.4 (0.488)	18.4 (0.724)	1500	2300	BC
0.82*	CB057D0824+ --	7.30 (0.287)	6.10 (0.240)	4.40 (0.173)	0.80 (0.031)	16.0 (0.629)	12.0 (0.472)	5.23 (0.206)	330 (12.99)	16.4 (0.645)	22.4 (0.881)	1000	1100	BC
1µF*	CB057D0105+ --	7.30 (0.287)	6.10 (0.240)	4.70 (0.185)	0.80 (0.031)	16.0 (0.629)	12.0 (0.472)	4.80 (0.189)	330 (12.99)	16.4 (0.645)	22.4 (0.881)	1000	1800	BC
1.5*	CB057D0155+ --	7.30 (0.287)	6.10 (0.240)	4.70 (0.185)	0.80 (0.031)	16.0 (0.629)	12.0 (0.472)	4.80 (0.189)	330 (12.99)	16.4 (0.645)	22.4 (0.881)	1000	1800	BC
2.2	CB167D0225+ --	10.5 (0.413)	7.60 (0.299)	6.10 (0.240)	0.80 (0.032)	24.0 (0.944)	12.0 (0.472)	6.19 (0.244)	330 (12.99)	24.4 (0.961)	30.4 (1.196)	500	900	BC
2.7	CB177D0275+ --	12.8 (0.503)	10.2 (0.402)	6.70 (0.264)	0.80 (0.032)	24.0 (0.944)	16.0 (0.629)	7.00 (0.274)	330 (12.99)	24.4 (0.961)	30.4 (1.196)	300	600	BC
3.3	CB187D0335+ --	15.3 (0.601)	13.7 (0.539)	5.30 (0.209)	0.80 (0.032)	24.0 (0.944)	24.0 (0.944)	6.30 (0.248)	330 (12.99)	24.4 (0.961)	30.4 (1.196)	300	400	BC
4.7	CB187D0475+ --	15.3 (0.601)	13.7 (0.539)	7.20 (0.283)	0.80 (0.032)	24.0 (0.944)	24.0 (0.944)	7.60 (0.299)	330 (12.99)	24.4 (0.961)	30.4 (1.196)	300	300	BC
VOLTAGE Vdc: 100V Vac: 63V														
0.001µF	CB017E0102+ --	3.30 (0.130)	1.60 (0.063)	1.15 (0.045)	0.50 (0.020)	8.00 (0.315)	4.00 (0.158)	1.20 (0.047)	180 (7.087)	8.40 (0.331)	14.4 (0.567)	2000	3900	BA
0.0012	CB017E0122+ --	3.30 (0.130)	1.60 (0.063)	1.15 (0.045)	0.50 (0.020)	8.00 (0.315)	4.00 (0.158)	1.20 (0.047)	180 (7.087)	8.40 (0.331)	14.4 (0.567)	2000	3900	BA
0.0015	CB017E0152+ --	3.30 (0.130)	1.60 (0.063)	1.15 (0.045)	0.50 (0.020)	8.00 (0.315)	4.00 (0.158)	1.20 (0.047)	180 (7.087)	8.40 (0.331)	14.4 (0.567)	2000	3900	BA
0.0018	CB017E0182+ --	3.30 (0.130)	1.60 (0.063)	1.15 (0.045)	0.50 (0.020)	8.00 (0.315)	4.00 (0.158)	1.20 (0.047)	180 (7.087)	8.40 (0.331)	14.4 (0.567)	2000	3900	BA

For other Values: upon request

Replace the + by the tolerance code: J = 5% or K = 10%

Replace the -- by the packaging suffix: -- = bulk

BA or BC = tape & reel

*Special length: 7.3 +0.7/-0.3 (0.287 +0.026/-0.012)



Film Chip Capacitors



PEN DIELECTRIC – CB Series

CAPACITANCE VALUES (CR) AND NOMINAL VOLTAGES (VR)



millimeters (inches)

Capacitance Range (CR)	Ordering Code	VOLTAGE Vdc: 100V Vac: 63V											Packaging Unit		Reel Pkg Code
		Chip Dimensions *Tolerances (page 6)				Tape Dimensions			Reel Dimensions			Bulk	Reel		
		L	W	H max	T	W	P1	K0	A	W1	W2 max				
0.0022	CB017E0222+ --	3.30 (0.130)	1.60 (0.063)	1.15 (0.045)	0.50 (0.020)	8.00 (0.315)	4.00 (0.158)	1.20 (0.047)	180 (7.087)	8.40 (0.331)	14.4 (0.567)	2000	3900	BA	
0.0027	CB017E0272+ --	3.30 (0.130)	1.60 (0.063)	1.15 (0.045)	0.50 (0.020)	8.00 (0.315)	4.00 (0.158)	1.20 (0.047)	180 (7.087)	8.40 (0.331)	14.4 (0.567)	2000	3900	BA	
0.0033	CB017E0332+ --	3.30 (0.130)	1.60 (0.063)	1.15 (0.045)	0.50 (0.020)	8.00 (0.315)	4.00 (0.158)	1.20 (0.047)	180 (7.087)	8.40 (0.331)	14.4 (0.567)	2000	3900	BA	
0.0047	CB017E0472+ --	3.30 (0.130)	1.60 (0.063)	1.15 (0.045)	0.50 (0.020)	8.00 (0.315)	4.00 (0.158)	1.20 (0.047)	180 (7.087)	8.40 (0.331)	14.4 (0.567)	2000	3900	BA	
0.0056	CB017E0562+ --	3.30 (0.130)	1.60 (0.063) ¹	1.15 (0.045)	0.50 (0.020)	8.00 (0.315)	4.00 (0.158)	1.20 (0.047)	180 (7.087)	8.40 (0.331)	14.4 (0.567)	2000	3900	BA	
0.0068	CB017E0682+ --	3.30 (0.130)	1.60 (0.063)	1.15 (0.045)	0.50 (0.020)	8.00 (0.315)	4.00 (0.158)	1.20 (0.047)	180 (7.087)	8.40 (0.331)	14.4 (0.567)	2000	3900	BA	
0.0082	CB017E0822+ --	3.30 (0.130)	1.60 (0.063)	1.15 (0.045)	0.50 (0.020)	8.00 (0.315)	4.00 (0.158)	1.20 (0.047)	180 (7.087)	8.40 (0.331)	14.4 (0.567)	2000	3900	BA	
0.010μF	CB017E0103+ --	3.30 (0.130)	1.60 (0.063)	1.15 (0.045)	0.50 (0.020)	8.00 (0.315)	4.00 (0.158)	1.20 (0.047)	180 (7.087)	8.40 (0.331)	14.4 (0.567)	2000	3900	BA	
0.012	CB027E0123+ --	3.30 (0.130)	2.50 (0.098)	1.80 (0.071)	0.50 (0.020)	8.00 (0.315)	4.00 (0.158)	1.90 (0.075)	180 (7.087)	8.40 (0.331)	14.4 (0.567)	2000	2500	BA	
0.015	CB027E0153+ --	3.30 (0.130)	2.50 (0.098)	1.80 (0.071)	0.50 (0.020)	8.00 (0.315)	4.00 (0.158)	1.90 (0.075)	180 (7.087)	8.40 (0.331)	14.4 (0.567)	2000	2500	BA	
0.018	CB027E0183+ --	3.30 (0.130)	2.50 (0.098)	1.80 (0.071)	0.50 (0.020)	8.0 (0.315)	4.00 (0.158)	1.90 (0.075)	180 (7.087)	8.40 (0.331)	14.4 (0.567)	2000	2500	BA	
0.022	CB027E0223+ --	3.30 (0.130)	2.50 (0.098)	1.80 (0.071)	0.50 (0.020)	8.00 (0.315)	4.00 (0.158)	1.90 (0.075)	180 (7.087)	8.40 (0.331)	14.4 (0.567)	2000	2500	BA	
0.027	CB037E0273+ --	4.70 (0.185)	3.20 (0.126)	2.20 (0.087)	0.60 (0.024)	12.0 (0.472)	8.00 (0.315)	2.60 (0.1024)	180 (7.087)	12.4 (0.488)	18.4 (0.724)	1500	900	BA	
		4.70 (0.185)	3.20 (0.126)	2.20 (0.087)	0.60 (0.024)	12.0 (0.472)	8.00 (0.315)	2.60 (0.1024)	330 (12.99)	12.4 (0.488)	18.4 (0.724)	1500	3600	BC	
0.033	CB037E0333+ --	4.70 (0.185)	3.20 (0.126)	2.00 (0.079)	0.60 (0.024)	12.0 (0.472)	8.00 (0.315)	2.06 (0.081)	180 (7.087)	12.4 (0.488)	18.4 (0.724)	1500	1200	BA	
		4.70 (0.185)	3.20 (0.126)	2.00 (0.079)	0.60 (0.024)	12.0 (0.472)	8.00 (0.315)	2.06 (0.081)	330 (12.99)	12.4 (0.488)	18.4 (0.724)	1500	4500	BC	
0.047	CB037E0473+ --	4.70 (0.185)	3.20 (0.126)	2.60 (0.102)	0.60 (0.024)	12.0 (0.472)	8.00 (0.315)	3.10 (0.122)	180 (7.087)	12.4 (0.488)	18.4 (0.724)	1500	700	BA	
		4.70 (0.185)	3.20 (0.126)	2.60 (0.102)	0.60 (0.024)	12.0 (0.472)	8.00 (0.315)	3.10 (0.122)	330 (12.99)	12.4 (0.488)	18.4 (0.724)	1500	3000	BC	
0.056	CB037E0563+ --	4.70 (0.185)	3.20 (0.126)	2.50 (0.099)	0.60 (0.024)	12.0 (0.472)	8.00 (0.315)	2.60 (0.102)	180 (7.087)	12.4 (0.488)	18.4 (0.724)	1500	900	BA	
		4.70 (0.185)	3.20 (0.126)	2.50 (0.099)	0.60 (0.024)	12.0 (0.472)	8.00 (0.315)	2.60 (0.102)	330 (12.99)	12.4 (0.488)	18.4 (0.724)	1500	3600	BC	
0.068	CB037E0683+ --	4.70 (0.185)	3.20 (0.126)	2.00 (0.079)	0.60 (0.024)	12.0 (0.472)	8.00 (0.315)	2.06 (0.081)	180 (7.087)	12.4 (0.488)	18.4 (0.724)	1500	1200	BA	
		4.70 (0.185)	3.20 (0.126)	2.00 (0.079)	0.60 (0.024)	12.0 (0.472)	8.00 (0.315)	2.06 (0.081)	330 (12.99)	12.4 (0.488)	18.4 (0.724)	1500	4500	BC	
0.082	CB037E0823+ --	4.70 (0.185)	3.20 (0.126)	2.50 (0.099)	0.60 (0.024)	12.0 (0.472)	8.00 (0.315)	2.60 (0.102)	180 (7.087)	12.4 (0.488)	18.4 (0.724)	1500	900	BA	

For other Values: upon request
 Replace the + by the tolerance code: J = 5% or K = 10%
 Replace the -- by the packaging suffix: -- = bulk
 BA or BC = tape & reel



Film Chip Capacitors



PEN DIELECTRIC – CB Series

CAPACITANCE VALUES (CR) AND NOMINAL VOLTAGES (VR)



millimeters (inches)

Capacitance Range (CR)	Ordering Code	VOLTAGE Vdc: 100V Vac: 63V												
		Chip Dimensions *Tolerances (page 6)				Tape Dimensions			Reel Dimensions			Packaging Unit		Reel Pkg Code
		L	W	H max	T	W	P1	K0	A	W1	W2 max	Bulk	Reel	
0.082	CB037E0823+ --	4.70 (0.185)	3.20 (0.126)	2.50 (0.099)	0.60 (0.024)	12.0 (0.472)	8.00 (0.315)	2.60 (0.102)	330 (12.99)	12.4 (0.488)	18.4 (0.724)	1500	3600	BC
0.100µF	CB037E0104+ --	4.70 (0.185)	3.20 (0.126)	3.00 (0.118)	0.60 (0.024)	12.0 (0.472)	8.00 (0.315)	3.10 (0.122)	180 (7.087)	12.4 (0.488)	18.4 (0.724)	1500	700	BA
		4.70 (0.185)	3.20 (0.126)	3.00 (0.118)	0.60 (0.024)	12.0 (0.472)	8.00 (0.315)	3.10 (0.122)	330 (12.99)	12.4 (0.488)	18.4 (0.724)	1500	3000	BC
0.120	CB047E0124+ --	5.80 (0.228)	5.00 (0.195)	4.00 (0.158)	0.80 (0.032)	12.0 (0.472)	8.00 (0.315)	4.10 (0.162)	330 (12.99)	12.4 (0.488)	18.4 (0.724)	1500	2300	BC
0.150	CB047E0154+ --	5.80 (0.228)	5.00 (0.195)	3.30 (0.130)	0.80 (0.032)	12.0 (0.472)	8.00 (0.315)	3.45 (0.136)	330 (12.99)	12.4 (0.488)	18.4 (0.724)	1500	2800	BC
0.180	CB047E0184+ --	5.80 (0.228)	5.00 (0.195)	3.00 (0.118)	0.80 (0.032)	12.0 (0.472)	8.00 (0.315)	3.10 (0.122)	330 (12.99)	12.4 (0.488)	18.4 (0.724)	1500	3000	BC
0.220	CB047E0224+ --	5.80 (0.228)	5.00 (0.195)	4.00 (0.158)	0.80 (0.032)	12.0 (0.472)	8.00 (0.315)	4.10 (0.162)	330 (12.99)	12.4 (0.488)	18.4 (0.724)	1500	2300	BC
0.330	CB047E0334+ --	5.80 (0.228)	5.00 (0.195)	4.00 (0.158)	0.80 (0.032)	16.0 (0.629)	8.00 (0.315)	4.10 (0.162)	330 (12.99)	16.4 (0.645)	22.4 (0.881)	1500	2300	BC
0.47*	CB057E0474+ --	7.30 (0.287)	6.10 (0.240)	4.50 (0.177)	0.80 (0.032)	16.0 (0.629)	12.0 (0.472)	4.80 (0.189)	330 (12.99)	16.4 (0.645)	22.4 (0.881)	1000	1800	BC
0.56*	CB057E0564+ --	7.30 (0.287)	6.10 (0.240)	4.00 (0.158)	0.80 (0.032)	16.0 (0.629)	12.0 (0.472)	4.10 (0.162)	330 (12.99)	16.4 (0.645)	22.4 (0.881)	1000	2300	BC
0.68*	CB057E0684+ --	7.30 (0.287)	6.10 (0.240)	4.50 (0.177)	0.80 (0.032)	16.0 (0.629)	12.0 (0.472)	4.80 (0.189)	330 (12.99)	16.4 (0.645)	22.4 (0.881)	1000	1800	BC
0.82	CB167E0824+ --	10.5 (0.413)	7.6 (0.299)	5.80 (0.229)	0.80 (0.032)	24.0 (0.944)	12.0 (0.472)	6.19 (0.244)	330 (12.99)	24.4 (0.961)	30.4 (1.196)	500	900	BC
1	CB167E0105+ --	10.5 (0.413)	7.60 (0.299)	6.00 (0.237)	0.80 (0.032)	24.0 (0.944)	12.0 (0.472)	6.19 (0.244)	330 (12.99)	24.4 (0.961)	30.4 (1.196)	500	900	BC
1.5	CB177E0155+ --	12.8 (0.503)	10.2 (0.402)	5.50 (0.217)	0.80 (0.032)	24.0 (0.944)	16.0 (0.629)	5.70 (0.224)	330 (12.99)	24.4 (0.961)	30.4 (1.196)	300	700	BC
2.2	CB177E0225+ --	12.8 (0.503)	10.2 (0.402)	6.90 (0.272)	0.80 (0.032)	24.0 (0.944)	16.0 (0.629)	7.00 (0.274)	330 (12.99)	24.4 (0.961)	30.4 (1.196)	300	600	BC
3.3	CB187E0335+ --	15.3 (0.601)	13.7 (0.539)	7.10 (0.280)	0.80 (0.032)	24.0 (0.944)	24.0 (0.944)	7.60 (0.299)	330 (12.99)	24.4 (0.961)	30.4 (1.196)	300	300	BC
VOLTAGE Vdc: 250V Vac: 160V														
0.001µF	CB037G0102+ --	4.70 (0.185)	3.20 (0.126)	2.00 (0.079)	0.60 (0.024)	12.0 (0.472)	8.00 (0.315)	2.06 (0.081)	180 (7.087)	12.4 (0.488)	18.4 (0.724)	1500	1200	BA
		4.70 (0.185)	3.20 (0.126)	2.00 (0.079)	0.60 (0.024)	12.0 (0.472)	8.00 (0.315)	2.06 (0.081)	330 (12.99)	12.4 (0.488)	18.4 (0.724)	1500	4500	BC
0.0012	CB037G0122+ --	4.70 (0.185)	3.20 (0.126)	2.00 (0.079)	0.60 (0.024)	12.0 (0.472)	8.00 (0.315)	2.06 (0.081)	180 (7.087)	12.4 (0.488)	18.4 (0.724)	1500	1200	BA
		4.70 (0.185)	3.20 (0.126)	2.00 (0.079)	0.60 (0.024)	12.0 (0.472)	8.00 (0.315)	2.06 (0.081)	330 (12.99)	12.4 (0.488)	18.4 (0.724)	1500	4500	BC
0.0015	CB037G0152+ --	4.70 (0.185)	3.20 (0.126)	2.00 (0.079)	0.60 (0.024)	12.0 (0.472)	8.00 (0.315)	2.06 (0.081)	180 (7.087)	12.4 (0.488)	18.4 (0.724)	1500	1200	BA
		4.70 (0.185)	3.20 (0.126)	2.00 (0.079)	0.60 (0.024)	12.0 (0.472)	8.00 (0.315)	2.06 (0.081)	330 (12.99)	12.4 (0.488)	18.4 (0.724)	1500	4500	BC
0.0018	CB037G0182+ --	4.70 (0.185)	3.20 (0.126)	2.00 (0.079)	0.60 (0.024)	12.0 (0.472)	8.00 (0.315)	2.06 (0.081)	180 (7.087)	12.4 (0.488)	18.4 (0.724)	1500	1200	BA

For other Values: upon request

Replace the + by the tolerance code: J = 5% or K = 10%

Replace the -- by the packaging suffix: -- = bulk

BA or BC = tape & reel

*Special length: 7.3 +0.7/-0.3 (0.287 +0.026/-0.012)



Film Chip Capacitors



PEN DIELECTRIC – CB Series

CAPACITANCE VALUES (CR) AND NOMINAL VOLTAGES (VR)



millimeters (inches)

Capacitance Range (CR)	Ordering Code	VOLTAGE Vdc: 250V Vac: 160V												
		Chip Dimensions *Tolerances (page 6)				Tape Dimensions			Reel Dimensions			Packaging Unit		Reel Pkg Code
		L	W	H max	T	W	P1	K0	A	W1	W2 max	Bulk	Reel	
0.0018	CB037G0182+ --	4.70 (0.185)	3.20 (0.126)	2.00 (0.079)	0.60 (0.024)	12.0 (0.472)	8.00 (0.315)	2.06 (0.081)	330 (12.99)	12.4 (0.488)	18.4 (0.724)	1500	4500	BC
0.0022	CB037G0222+ --	4.70 (0.185)	3.20 (0.126)	2.00 (0.079)	0.60 (0.024)	12.0 (0.472)	8.00 (0.315)	2.06 (0.081)	180 (7.087)	12.4 (0.488)	18.4 (0.724)	1500	1200	BA
		4.70 (0.185)	3.20 (0.126)	2.00 (0.079)	0.60 (0.024)	12.0 (0.472)	8.00 (0.315)	2.06 (0.081)	330 (12.99)	12.4 (0.488)	18.4 (0.724)	1500	4500	BC
0.0027	CB037G0272+ --	4.70 (0.185)	3.20 (0.126)	2.00 (0.079)	0.60 (0.024)	12.0 (0.472)	8.00 (0.315)	2.06 (0.081)	180 (7.087)	12.4 (0.488)	18.4 (0.724)	1500	1200	BA
		4.70 (0.185)	3.20 (0.126)	2.00 (0.079)	0.60 (0.024)	12.0 (0.472)	8.00 (0.315)	2.06 (0.081)	330 (12.99)	12.4 (0.488)	18.4 (0.724)	1500	4500	BC
0.0033	CB037G0332+ --	4.70 (0.185)	3.20 (0.126)	2.00 (0.079)	0.60 (0.024)	12.0 (0.472)	8.00 (0.315)	2.06 (0.081)	180 (7.087)	12.4 (0.488)	18.4 (0.724)	1500	1200	BA
		4.70 (0.185)	3.20 (0.126)	2.00 (0.079)	0.60 (0.024)	12.0 (0.472)	8.00 (0.315)	2.06 (0.081)	330 (12.99)	12.4 (0.488)	18.4 (0.724)	1500	4500	BC
0.0047	CB037G0472+ --	4.70 (0.185)	3.20 (0.126)	2.00 (0.079)	0.60 (0.024)	12.0 (0.472)	8.00 (0.315)	2.06 (0.081)	180 (7.087)	12.4 (0.488)	18.4 (0.724)	1500	1200	BA
		4.70 (0.185)	3.20 (0.126)	2.00 (0.079)	0.60 (0.024)	12.0 (0.472)	8.00 (0.315)	2.06 (0.081)	330 (12.99)	12.4 (0.488)	18.4 (0.724)	1500	4500	BC
0.0056	CB037G0562+ --	4.70 (0.185)	3.20 (0.126)	2.00 (0.079)	0.60 (0.024)	12.0 (0.472)	8.00 (0.315)	2.06 (0.081)	180 (7.087)	12.4 (0.488)	18.4 (0.724)	1500	1200	BA
		4.70 (0.185)	3.20 (0.126)	2.00 (0.079)	0.60 (0.024)	12.0 (0.472)	8.00 (0.315)	2.06 (0.081)	330 (12.99)	12.4 (0.488)	18.4 (0.724)	1500	4500	BC
0.0068	CB037G0682+ --	4.70 (0.185)	3.20 (0.126)	2.00 (0.079)	0.60 (0.024)	12.0 (0.472)	8.00 (0.315)	2.06 (0.081)	180 (7.087)	12.4 (0.488)	18.4 (0.724)	1500	1200	BA
		4.70 (0.185)	3.20 (0.126)	2.00 (0.079)	0.60 (0.024)	12.0 (0.472)	8.00 (0.315)	2.06 (0.081)	330 (12.99)	12.4 (0.488)	18.4 (0.724)	1500	4500	BC
0.0082	CB037G0822+ --	4.70 (0.185)	3.20 (0.126)	2.00 (0.079)	0.60 (0.024)	12.0 (0.472)	8.00 (0.315)	2.06 (0.081)	180 (7.087)	12.4 (0.488)	18.4 (0.724)	1500	1200	BA
		4.70 (0.185)	3.20 (0.126)	2.00 (0.079)	0.60 (0.024)	12.0 (0.472)	8.00 (0.315)	2.06 (0.081)	330 (12.99)	12.4 (0.488)	18.4 (0.724)	1500	4500	BC
0.010µF	CB037G0103+ --	4.70 (0.185)	3.20 (0.126)	2.00 (0.079)	0.60 (0.024)	12.0 (0.472)	8.00 (0.315)	2.06 (0.081)	180 (7.087)	12.4 (0.488)	18.4 (0.724)	1500	1200	BA
		4.70 (0.185)	3.20 (0.126)	2.00 (0.079)	0.60 (0.024)	12.0 (0.472)	8.00 (0.315)	2.06 (0.081)	330 (12.99)	12.4 (0.488)	18.4 (0.724)	1500	4500	BC
0.012	CB037G0123+ --	4.70 (0.185)	3.20 (0.126)	2.00 (0.079)	0.60 (0.024)	12.0 (0.472)	8.00 (0.315)	2.06 (0.081)	180 (7.087)	12.4 (0.488)	18.4 (0.724)	1500	1200	BA
		4.70 (0.185)	3.20 (0.126)	2.00 (0.079)	0.60 (0.024)	12.0 (0.472)	8.00 (0.315)	2.06 (0.081)	330 (12.99)	12.4 (0.488)	18.4 (0.724)	1500	4500	BC
0.015	CB037G0153+ --	4.70 (0.185)	3.20 (0.126)	2.40 (0.094)	0.60 (0.024)	12.0 (0.472)	8.00 (0.315)	2.60 (0.102)	180 (7.087)	12.4 (0.488)	18.4 (0.724)	1500	900	BA
		4.70 (0.185)	3.20 (0.126)	2.40 (0.094)	0.60 (0.024)	12.0 (0.472)	8.00 (0.315)	2.60 (0.102)	330 (12.99)	12.4 (0.488)	18.4 (0.724)	1500	3600	BC
0.018	CB037G0183+ --	4.70 (0.185)	3.20 (0.126)	2.50 (0.099)	0.60 (0.024)	12.0 (0.472)	8.00 (0.315)	2.60 (0.102)	180 (7.087)	12.4 (0.488)	18.4 (0.724)	1500	900	BA
		4.70 (0.185)	3.20 (0.126)	2.50 (0.099)	0.60 (0.024)	12.0 (0.472)	8.00 (0.315)	2.60 (0.102)	330 (12.99)	12.4 (0.488)	18.4 (0.724)	1500	3600	BC

For other Values: upon request

Replace the + by the tolerance code: J = 5% or K = 10%

Replace the -- by the packaging suffix: -- = bulk

BA or BC = tape & reel



Film Chip Capacitors



PEN DIELECTRIC – CB Series

CAPACITANCE VALUES (CR) AND NOMINAL VOLTAGES (VR)

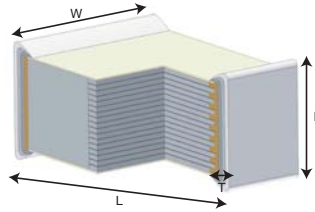

millimeters (inches)

Capacitance Range (CR)	Ordering Code	VOLTAGE Vdc: 250V Vac: 160V												
		Chip Dimensions *Tolerances (page 6)				Tape Dimensions			Reel Dimensions			Packaging Unit		Reel Pkg Code
		L	W	H max	T	W	P1	K0	A	W1	W2 max	Bulk	Reel	
0.022	CB037G0223+ --	4.70 (0.185)	3.20 (0.126)	2.90 (0.114)	0.60 (0.024)	12.0 (0.472)	8.00 (0.315)	3.10 (0.122)	180 (7.087)	12.4 (0.488)	18.4 (0.724)	1500	700	BA
		4.70 (0.185)	3.20 (0.126)	2.90 (0.114)	0.60 (0.024)	12.0 (0.472)	8.00 (0.315)	3.10 (0.122)	330 (12.99)	12.4 (0.488)	18.4 (0.724)	1500	3000	BC
0.027	CB047G0273+ --	5.80 (0.228)	5.00 (0.195)	1.80 (0.071)	0.80 (0.032)	12.0 (0.472)	8.00 (0.315)	2.43 (0.096)	330 (12.99)	12.4 (0.488)	18.4 (0.724)	1500	3500	BC
0.033	CB047G0333+ --	5.80 (0.228)	5.00 (0.195)	2.20 (0.087)	0.80 (0.032)	12.0 (0.472)	8.00 (0.315)	2.43 (0.096)	330 (12.99)	12.4 (0.488)	18.4 (0.724)	1500	3500	BC
0.047	CB047G0473+ --	5.80 (0.228)	5.00 (0.195)	2.90 (0.114)	0.80 (0.032)	12.0 (0.472)	8.00 (0.315)	3.10 (0.122)	330 (12.99)	12.4 (0.488)	18.4 (0.724)	1500	3000	BC
0.056	CB047G0563+ --	5.80 (0.228)	5.00 (0.195)	2.90 (0.114)	0.80 (0.032)	12.0 (0.472)	8.00 (0.315)	3.10 (0.122)	330 (12.99)	12.4 (0.488)	18.4 (0.724)	1500	3000	BC
0.068	CB047G0683+ --	5.80 (0.228)	5.00 (0.195)	4.00 (0.158)	0.80 (0.032)	12.0 (0.472)	8.00 (0.315)	4.10 (0.161)	330 (12.99)	12.4 (0.488)	18.4 (0.724)	1500	2300	BC
0.082	CB047G0823+ --	5.80 (0.228)	5.00 (0.195)	4.50 (0.177)	0.80 (0.032)	16.0 (0.629)	8.00 (0.315)	4.60 (0.181)	330 (12.99)	16.4 (0.645)	22.4 (0.881)	1500	1900	BC
0.100µF	CB047G0104+ --	5.80 (0.228)	5.00 (0.195)	4.50 (0.177)	0.80 (0.032)	16.0 (0.629)	8.00 (0.315)	4.60 (0.181)	330 (12.99)	16.4 (0.645)	22.4 (0.881)	1500	1900	BC
0.120	CB057G0124+ --	7.20 (0.283)	6.10 (0.240)	3.90 (0.153)	0.80 (0.032)	24.0 (0.944)	12.0 (0.472)	4.80 (0.189)	330 (12.99)	24.4 (0.961)	30.4 (1.196)	1000	1800	BC
0.150	CB057G0154+ --	7.20 (0.283)	6.10 (0.240)	4.70 (0.185)	0.80 (0.032)	16.0 (0.629)	12.0 (0.472)	4.80 (0.189)	330 (12.99)	16.4 (0.645)	22.4 (0.881)	1000	1800	BC
0.180	CB057G0184+ --	7.20 (0.283)	6.10 (0.240)	5.00 (0.197)	0.80 (0.032)	16.0 (0.629)	12.0 (0.472)	5.23 (0.206)	330 (12.99)	16.4 (0.645)	22.4 (0.881)	1000	1100	BC
0.22µF	CB057G0224+ --	7.20 (0.283)	6.10 (0.240)	5.70 (0.225)	0.80 (0.032)	16.0 (0.629)	12.0 (0.472)	5.90 (0.232)	330 (12.99)	16.4 (0.645)	22.4 (0.881)	1000	900	BC
0.330	CB167G0334+ --	10.5 (0.413)	7.60 (0.299)	6.10 (0.240)	0.80 (0.032)	24.0 (0.944)	12.0 (0.472)	6.19 (0.244)	330 (12.99)	24.4 (0.961)	30.4 (1.196)	500	900	BC
0.470	CB177G0474+ --	12.8 (0.503)	10.2 (0.402)	5.50 (0.205)	0.80 (0.032)	24.0 (0.944)	16.0 (0.629)	5.70 (0.224)	330 (12.99)	24.4 (0.961)	30.4 (1.196)	300	700	BC
0.560	CB177G0564+ --	12.8 (0.503)	10.2 (0.402)	6.00 (0.236)	0.80 (0.032)	24.0 (0.944)	16.0 (0.629)	5.70 (0.224)	330 (12.99)	24.4 (0.961)	30.4 (1.196)	300	700	BC
0.680	CB187G0684+ --	15.3 (0.601)	13.7 (0.539)	4.30 (0.169)	0.80 (0.032)	24.0 (0.944)	24.0 (0.944)	4.50 (0.177)	330 (12.99)	24.4 (0.961)	30.4 (1.196)	300	600	BC
1µF	CB187G0105+ --	15.3 (0.601)	13.7 (0.539)	6.40 (0.252)	0.80 (0.032)	24.0 (0.944)	24.0 (0.944)	6.30 (0.248)	330 (12.99)	24.4 (0.961)	30.4 (1.196)	300	400	BC
VOLTAGE Vdc: 400V Vac: 200V														
0.001µF	CB037I0102+ --	4.70 (0.185)	3.20 (0.126)	2.00 (0.079)	0.60 (0.024)	12.0 (0.472)	8.00 (0.315)	2.06 (0.081)	180 (7.09)	12.4 (0.488)	18.4 (0.724)	1500	1200	BA
		4.70 (0.185)	3.20 (0.126)	2.00 (0.079)	0.60 (0.024)	12.0 (0.472)	8.00 (0.315)	2.06 (0.081)	330 (12.99)	12.4 (0.488)	18.4 (0.724)	1500	4500	BC
0.0012	CB037I0122+ --	4.70 (0.185)	3.20 (0.126)	2.00 (0.079)	0.60 (0.024)	12.0 (0.472)	8.00 (0.315)	2.06 (0.081)	180 (7.09)	12.4 (0.488)	18.4 (0.724)	1500	1200	BA
		4.70 (0.185)	3.20 (0.126)	2.00 (0.079)	0.60 (0.024)	12.0 (0.472)	8.00 (0.315)	2.06 (0.081)	330 (12.99)	12.4 (0.488)	18.4 (0.724)	1500	4500	BC
0.0015	CB037I0152+ --	4.70 (0.185)	3.20 (0.126)	2.00 (0.079)	0.60 (0.024)	12.0 (0.472)	8.00 (0.315)	2.06 (0.081)	180 (7.09)	12.4 (0.488)	18.4 (0.724)	1500	1200	BA

For other Values: upon request

Replace the + by the tolerance code: J = 5% or K = 10%

Replace the -- by the packaging suffix: -- = bulk

BA or BC = tape & reel



Film Chip Capacitors



PEN DIELECTRIC – CB Series

CAPACITANCE VALUES (CR) AND NOMINAL VOLTAGES (VR)

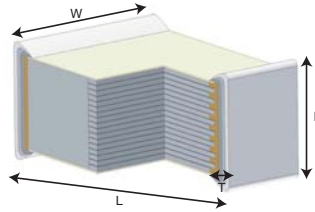

millimeters (inches)

Capacitance Range (CR)	Ordering Code	VOLTAGE Vdc: 400V Vac: 200V												
		Chip Dimensions *Tolerances (page 6)				Tape Dimensions			Reel Dimensions			Packaging Unit		Reel Pkg Code
		L	W	H max	T	W	P1	K0	A	W1	W2 max	Bulk	Reel	
0.0015	CB037I0152+ --	4.70 (0.185)	3.20 (0.126)	2.00 (0.079)	0.60 (0.024)	12.0 (0.472)	8.00 (0.315)	2.06 (0.081)	330 (12.99)	12.4 (0.488)	18.4 (0.724)	1500	4500	BC
0.0018	CB037I0182+ --	4.70 (0.185)	3.20 (0.126)	2.00 (0.079)	0.60 (0.024)	12.0 (0.472)	8.00 (0.315)	2.06 (0.081)	180 (7.09)	12.4 (0.488)	18.4 (0.724)	1500	1200	BA
		4.70 (0.185)	3.20 (0.126)	2.00 (0.079)	0.60 (0.024)	12.0 (0.472)	8.00 (0.315)	2.06 (0.081)	330 (12.99)	12.4 (0.488)	18.4 (0.724)	1500	4500	BC
0.0022	CB037I0222+ --	4.70 (0.185)	3.20 (0.126)	2.00 (0.079)	0.60 (0.024)	12.0 (0.472)	8.00 (0.315)	2.06 (0.081)	180 (7.09)	12.4 (0.488)	18.4 (0.724)	1500	1200	BA
		4.70 (0.185)	3.20 (0.126)	2.00 (0.079)	0.60 (0.024)	12.0 (0.472)	8.00 (0.315)	2.06 (0.081)	330 (12.99)	12.4 (0.488)	18.4 (0.724)	1500	4500	BC
0.0027	CB037I0272+ --	4.70 (0.185)	3.20 (0.126)	2.00 (0.079)	0.60 (0.024)	12.0 (0.472)	8.00 (0.315)	2.06 (0.081)	180 (7.09)	12.4 (0.488)	18.4 (0.724)	1500	1200	BA
		4.70 (0.185)	3.20 (0.126)	2.00 (0.079)	0.60 (0.024)	12.0 (0.472)	8.00 (0.315)	2.06 (0.081)	330 (12.99)	12.4 (0.488)	18.4 (0.724)	1500	4500	BC
0.0033	CB037I0332+ --	4.70 (0.185)	3.20 (0.126)	2.00 (0.079)	0.60 (0.024)	12.0 (0.472)	8.00 (0.315)	2.06 (0.081)	180 (7.09)	12.4 (0.488)	18.4 (0.724)	1500	1200	BA
		4.70 (0.185)	3.20 (0.126)	2.00 (0.079)	0.60 (0.024)	12.0 (0.472)	8.00 (0.315)	2.06 (0.081)	330 (12.99)	12.4 (0.488)	18.4 (0.724)	1500	4500	BC
0.0047	CB037I0472+ --	4.70 (0.185)	3.20 (0.126)	2.00 (0.079)	0.60 (0.024)	12.0 (0.472)	8.00 (0.315)	2.06 (0.081)	180 (7.09)	12.4 (0.488)	18.4 (0.724)	1500	1200	BA
		4.70 (0.185)	3.20 (0.126)	2.00 (0.079)	0.60 (0.024)	12.0 (0.472)	8.00 (0.315)	2.06 (0.081)	330 (12.99)	12.4 (0.488)	18.4 (0.724)	1500	4500	BC
0.0056	CB037I0562+ --	4.70 (0.185)	3.20 (0.126)	2.00 (0.079)	0.60 (0.024)	12.0 (0.472)	8.00 (0.315)	2.06 (0.081)	180 (7.09)	12.4 (0.488)	18.4 (0.724)	1500	1200	BA
		4.70 (0.185)	3.20 (0.126)	2.00 (0.079)	0.60 (0.024)	12.0 (0.472)	8.00 (0.315)	2.06 (0.081)	330 (12.99)	12.4 (0.488)	18.4 (0.724)	1500	4500	BC
0.0068	CB037I0682+ --	4.70 (0.185)	3.20 (0.126)	2.00 (0.079)	0.60 (0.024)	12.0 (0.472)	8.00 (0.315)	2.06 (0.081)	180 (7.09)	12.4 (0.488)	18.4 (0.724)	1500	1200	BA
		4.70 (0.185)	3.20 (0.126)	2.00 (0.079)	0.60 (0.024)	12.0 (0.472)	8.00 (0.315)	2.06 (0.081)	330 (12.99)	12.4 (0.488)	18.4 (0.724)	1500	4500	BC
0.0082	CB037I0822+ --	4.70 (0.185)	3.20 (0.126)	2.00 (0.079)	0.60 (0.024)	12.0 (0.472)	8.00 (0.315)	2.06 (0.081)	180 (7.09)	12.4 (0.488)	18.4 (0.724)	1500	1200	BA
		4.70 (0.185)	3.20 (0.126)	2.00 (0.079)	0.60 (0.024)	12.0 (0.472)	8.00 (0.315)	2.06 (0.081)	330 (12.99)	12.4 (0.488)	18.4 (0.724)	1500	4500	BC
0.010μF	CB047I0103+ --	5.80 (0.228)	5.00 (0.195)	1.90 (0.075)	0.80 (0.032)	12.0 (0.472)	8.00 (0.315)	2.10 (0.083)	330 (12.99)	12.4 (0.488)	18.4 (0.724)	1500	4400	BC
0.012	CB047I0123+ --	5.80 (0.228)	5.00 (0.195)	2.20 (0.087)	0.80 (0.032)	12.0 (0.472)	8.00 (0.315)	2.43 (0.096)	330 (12.99)	12.4 (0.488)	18.4 (0.724)	1500	3500	BC
0.015	CB047I0153+ --	5.80 (0.228)	5.00 (0.224)	2.00 (0.079)	0.80 (0.087)	12.0 (0.472)	8.00 (0.315)	2.43 (0.096)	330 (12.99)	12.4 (0.488)	18.4 (0.724)	1500	4400	BC
0.018	CB047I0183+ --	5.80 (0.228)	5.00 (0.195)	2.30 (0.091)	0.80 (0.032)	12.0 (0.472)	8.00 (0.315)	2.43 (0.096)	330 (12.99)	12.4 (0.488)	18.4 (0.724)	1500	3500	BC
0.022	CB047I0223+ --	5.80 (0.228)	5.00 (0.195)	2.80 (0.110)	0.80 (0.032)	12.0 (0.472)	8.00 (0.315)	3.10 (0.122)	330 (12.99)	12.4 (0.488)	18.4 (0.724)	1500	3000	BC
0.027	CB047I0273+ --	5.80 (0.228)	5.00 (0.195)	3.30 (0.130)	0.80 (0.032)	12.0 (0.472)	8.00 (0.315)	3.45 (0.136)	330 (12.99)	12.4 (0.488)	18.4 (0.724)	1500	2800	BC

For other Values: upon request

Replace the + by the tolerance code: J = 5% or K = 10%

Replace the -- by the packaging suffix: -- = bulk

BA or BC = tape & reel



Film Chip Capacitors



PEN DIELECTRIC – CB Series

CAPACITANCE VALUES (CR) AND NOMINAL VOLTAGES (VR)

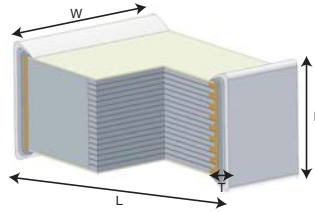

millimeters (inches)

Capacitance Range (CR)	Ordering Code	VOLTAGE Vdc: 400V Vac: 200V												
		Chip Dimensions *Tolerances (page 6)				Tape Dimensions			Reel Dimensions			Packaging Unit		Reel Pkg Code
		L	W	H max	T	W	P1	K0	A	W1	W2 max	Bulk	Reel	
0.033	CB047I0333+ --	5.80 (0.228)	5.00 (0.195)	3.90 (0.154)	0.80 (0.032)	12.0 (0.472)	8.00 (0.315)	4.10 (0.162)	330 (12.99)	12.4 (0.488)	18.4 (0.724)	1500	2300	BC
0.047	CB057I0473+ --	7.20 (0.283)	6.10 (0.24)	3.20 (0.126)	0.80 (0.032)	24.0 (0.944)	12.0 (0.472)	3.80 (0.149)	330 (12.99)	24.4 (0.96)	30.4 (1.196)	1000	2250	BC
0.056	CB057I0563+ --	7.20 (0.283)	6.10 (0.24)	3.70 (0.146)	0.80 (0.032)	24.0 (0.944)	12.0 (0.472)	3.80 (0.149)	330 (12.99)	16.4 (0.645)	22.4 (0.881)	1000	2250	BC
0.068	CB057I0683+ --	7.20 (0.283)	6.10 (0.24)	4.40 (0.173)	0.80 (0.032)	24.0 (0.944)	12.0 (0.472)	4.80 (0.189)	330 (12.99)	16.4 (0.645)	22.4 (0.881)	1000	1800	BC
0.082	CB167I0823+ --	10.5 (0.413)	7.60 (0.299)	4.50 (0.177)	0.80 (0.032)	24.0 (0.944)	12.0 (0.472)	4.90 (0.193)	330 (12.99)	24.4 (0.961)	30.4 (1.196)	500	1100	BC
0.100µF	CB167I0104+ --	10.5 (0.413)	7.60 (0.299)	4.00 (0.158)	0.80 (0.032)	24.0 (0.944)	12.0 (0.472)	4.90 (0.193)	330 (12.99)	24.4 (0.961)	30.4 (1.196)	500	1100	BC
0.120	CB167I0124+ --	10.5 (0.413)	7.60 (0.299)	5.00 (0.196)	0.80 (0.032)	24.0 (0.944)	12.0 (0.472)	6.19 (0.244)	330 (12.99)	24.4 (0.961)	30.4 (1.196)	500	900	BC
0.150	CB167I0154+ --	10.5 (0.413)	7.60 (0.299)	6.00 (0.235)	0.80 (0.032)	24.0 (0.944)	12.0 (0.472)	6.19 (0.244)	330 (12.99)	24.4 (0.961)	30.4 (1.196)	500	900	BC
0.180	CB177I0184+ --	12.8 (0.503)	10.2 (0.402)	5.10 (0.200)	0.80 (0.032)	24.0 (0.944)	16.0 (0.629)	5.70 (0.225)	330 (12.99)	24.4 (0.961)	30.4 (1.196)	300	700	BC
0.220	CB177I0224+ --	12.8 (0.503)	10.2 (0.402)	5.00 (0.196)	0.80 (0.032)	24.0 (0.944)	16.0 (0.629)	5.70 (0.225)	330 (12.99)	24.4 (0.961)	30.4 (1.196)	300	700	BC
0.270	CB177I0274+ --	12.8 (0.503)	10.2 (0.402)	6.50 (0.255)	0.80 (0.032)	24.0 (0.944)	16.0 (0.629)	7.00 (0.275)	330 (12.99)	24.4 (0.961)	30.4 (1.196)	300	600	BC
0.330	CB187I0334+ --	15.3 (0.601)	13.7 (0.539)	4.20 (0.165)	0.80 (0.032)	24.0 (0.944)	24.0 (0.944)	4.50 (0.178)	330 (12.99)	24.4 (0.961)	30.4 (1.196)	300	600	BC
0.390	CB187I0394+ --	15.3 (0.601)	13.7 (0.539)	5.80 (0.228)	0.80 (0.032)	24.0 (0.944)	24.0 (0.944)	6.30 (0.248)	330 (12.99)	24.4 (0.961)	30.4 (1.196)	300	400	BC
0.470	CB187I0474+ --	15.3 (0.601)	13.7 (0.539)	6.50 (0.255)	0.80 (0.0315)	24.0 (0.944)	24.0 (0.944)	7.60 (0.299)	330 (12.99)	24.4 (0.961)	30.4 (1.196)	300	300	BC
VOLTAGE Vdc: 630V Vac: 250V														
0.001µF	CB037K0102+ --	4.70 (0.185)	3.20 (0.126)	2.00 (0.079)	0.60 (0.024)	12.0 (0.472)	8.00 (0.315)	2.06 (0.081)	180 (7.09)	12.4 (0.488)	18.4 (0.724)	1500	1200	BA
		4.70 (0.185)	3.20 (0.126)	2.00 (0.079)	0.60 (0.024)	12.0 (0.472)	8.00 (0.315)	2.06 (0.081)	330 (12.99)	12.4 (0.488)	18.4 (0.724)	1500	4500	BC
0.0012	CB037K0122+ --	4.70 (0.185)	3.20 (0.126)	2.00 (0.079)	0.60 (0.024)	12.0 (0.472)	8.00 (0.315)	2.06 (0.081)	180 (7.09)	12.4 (0.488)	18.4 (0.724)	1500	1200	BA
		4.70 (0.185)	3.20 (0.126)	2.00 (0.079)	0.60 (0.024)	12.0 (0.472)	8.00 (0.315)	2.06 (0.081)	330 (12.99)	12.4 (0.488)	18.4 (0.724)	1500	4500	BC
0.0015	CB037K0152+ --	4.70 (0.185)	3.20 (0.126)	2.00 (0.079)	0.60 (0.024)	12.0 (0.472)	8.00 (0.315)	2.06 (0.081)	180 (7.09)	12.4 (0.488)	18.4 (0.724)	1500	1200	BA
		4.70 (0.185)	3.20 (0.126)	2.00 (0.079)	0.60 (0.024)	12.0 (0.472)	8.00 (0.315)	2.06 (0.081)	330 (12.99)	12.4 (0.488)	18.4 (0.724)	1500	4500	BC
0.0018	CB037K0182+ --	4.70 (0.185)	3.20 (0.126)	2.00 (0.079)	0.60 (0.024)	12.0 (0.472)	8.00 (0.315)	2.06 (0.081)	180 (7.09)	12.4 (0.488)	18.4 (0.724)	1500	1200	BA
		4.70 (0.185)	3.20 (0.126)	2.00 (0.079)	0.60 (0.024)	12.0 (0.472)	8.00 (0.315)	2.06 (0.081)	330 (12.99)	12.4 (0.488)	18.4 (0.724)	1500	4500	BC
0.0022	CB037K0222+ --	4.70 (0.185)	3.20 (0.126)	2.00 (0.079)	0.60 (0.024)	12.0 (0.472)	8.00 (0.315)	2.06 (0.081)	180 (7.09)	12.4 (0.488)	18.4 (0.724)	1500	1200	BA

For other Values: upon request

Replace the + by the tolerance code: J = 5% or K = 10%

Replace the -- by the packaging suffix: -- = bulk

BA or BC = tape & reel



Film Chip Capacitors



PEN DIELECTRIC – CB Series

CAPACITANCE VALUES (CR) AND NOMINAL VOLTAGES (VR)

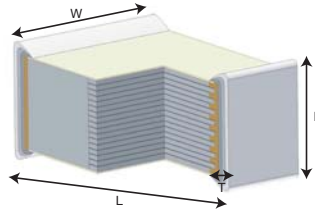

millimeters (inches)

Capacitance Range (CR)	Ordering Code	VOLTAGE Vdc: 630V Vac: 250V												
		Chip Dimensions *Tolerances (page 6)				Tape Dimensions			Reel Dimensions			Packaging Unit		Reel Pkg Code
		L	W	H max	T	W	P1	K0	A	W1	W2 max	Bulk	Reel	
0.0022	CB037K0222+ --	4.70 (0.185)	3.20 (0.126)	2.00 (0.079)	0.60 (0.024)	12.0 (0.472)	8.00 (0.315)	2.06 (0.081)	330 (12.99)	12.4 (0.488)	18.4 (0.724)	1500	4500	BC
0.0027	CB037K0272+ --	4.70 (0.185)	3.20 (0.126)	2.00 (0.079)	0.60 (0.024)	12.0 (0.472)	8.00 (0.315)	2.06 (0.081)	180 (7.09)	12.4 (0.488)	18.4 (0.724)	1500	1200	BA
		4.70 (0.185)	3.20 (0.126)	2.00 (0.079)	0.60 (0.024)	12.0 (0.472)	8.00 (0.315)	2.06 (0.081)	330 (12.99)	12.4 (0.488)	18.4 (0.724)	1500	4500	BC
0.0033	CB037K0332+ --	4.70 (0.185)	3.20 (0.126)	2.00 (0.079)	0.60 (0.024)	12.0 (0.472)	8.00 (0.315)	2.06 (0.081)	180 (7.09)	12.4 (0.488)	18.4 (0.724)	1500	1200	BA
		4.70 (0.185)	3.20 (0.126)	2.00 (0.079)	0.60 (0.024)	12.0 (0.472)	8.00 (0.315)	2.06 (0.081)	330 (12.99)	12.4 (0.488)	18.4 (0.724)	1500	4500	BC
0.0047	CB037K0472+ --	4.70 (0.185)	3.20 (0.126)	2.50 (0.099)	0.60 (0.024)	12.0 (0.472)	8.00 (0.315)	2.06 (0.081)	180 (7.09)	12.4 (0.488)	18.4 (0.724)	1500	1201	BA
		4.70 (0.185)	3.20 (0.126)	2.50 (0.099)	0.60 (0.024)	12.0 (0.472)	8.00 (0.315)	2.06 (0.081)	180 (7.09)	12.4 (0.488)	18.4 (0.724)	1500	4500	BC
0.0056	CB047K0562+ --	5.80 (0.228)	5.00 (0.195)	2.00 (0.079)	0.80 (0.032)	12.0 (0.472)	8.00 (0.315)	2.10 (0.083)	330 (12.99)	12.4 (0.488)	18.4 (0.724)	1500	4400	BC
0.0068	CB047K0682+ --	5.80 (0.228)	5.00 (0.195)	2.00 (0.079)	0.80 (0.032)	12.0 (0.472)	8.0 (0.315)	2.10 (0.083)	330 (12.99)	12.4 (0.488)	18.4 (0.724)	1500	4400	BC
0.0082	CB047K0822+ --	5.80 (0.228)	5.00 (0.195)	2.20 (0.086)	0.80 (0.032)	12.0 (0.472)	8.0 (0.315)	2.43 (0.096)	330 (12.99)	12.4 (0.488)	18.4 (0.724)	1500	3500	BC
0.010µF	CB047K0103+ --	5.80 (0.228)	5.00 (0.195)	2.00 (0.079)	0.80 (0.032)	12.0 (0.472)	8.00 (0.315)	2.10 (0.083)	330 (12.99)	12.4 (0.488)	18.4 (0.724)	1500	4400	BC
0.012	CB047K0123+ --	5.80 (0.228)	5.00 (0.195)	3.00 (0.118)	0.80 (0.032)	12.0 (0.472)	8.00 (0.315)	3.10 (0.122)	330 (12.99)	12.4 (0.488)	18.4 (0.724)	1500	3000	BC
0.015	CB047K0153+ --	5.80 (0.228)	5.00 (0.195)	3.40 (0.136)	0.80 (0.032)	12.0 (0.472)	8.00 (0.315)	3.45 (0.136)	330 (12.99)	12.4 (0.488)	18.4 (0.724)	1500	2800	BC
0.018	CB047K0183+ --	5.80 (0.228)	5.00 (0.195)	4.00 (0.157)	0.80 (0.032)	12.0 (0.472)	8.00 (0.315)	4.10 (0.162)	330 (12.99)	12.4 (0.488)	18.4 (0.724)	1500	2300	BC
0.022	CB057K0223+ --	7.20 (0.283)	6.10 (0.240)	3.40 (0.136)	0.80 (0.032)	24.0 (0.944)	12.0 (0.472)	3.80 (0.149)	330 (12.99)	16.4 (0.645)	22.4 (0.881)	1000	2250	BC
0.027	CB057K0273+ --	7.20 (0.283)	6.10 (0.240)	4.00 (0.157)	0.80 (0.032)	24.0 (0.944)	12.0 (0.472)	4.80 (0.189)	330 (12.99)	16.4 (0.645)	22.4 (0.881)	1000	1800	BC
0.033	CB057K0333+ --	7.20 (0.283)	6.10 (0.240)	4.80 (0.189)	0.8 (0.032)	16.0 (0.629)	12.0 (0.472)	5.23 (0.206)	330 (12.99)	16.4 (0.645)	22.4 (0.881)	1000	1100	BC
0.047	CB167K0473+ --	10.5 (0.413)	7.60 (0.299)	3.80 (0.150)	0.80 (0.032)	24.0 (0.944)	12.0 (0.472)	3.93 (0.155)	330 (12.99)	24.4 (0.961)	30.4 (1.196)	500	1400	BC
0.056	CB167K0563+ --	10.5 (0.413)	7.60 (0.299)	4.60 (0.181)	0.80 (0.032)	24.0 (0.944)	12.0 (0.472)	6.19 (0.244)	330 (12.99)	24.4 (0.961)	30.4 (1.196)	500	900	BC
0.068	CB167K0683+ --	10.5 (0.413)	7.60 (0.299)	5.50 (0.216)	0.80 (0.032)	24.0 (0.944)	12.0 (0.472)	6.19 (0.244)	330 (12.99)	24.4 (0.961)	30.4 (1.196)	500	900	BC
0.082	CB177K0823+ --	12.8 (0.503)	10.2 (0.402)	4.50 (0.177)	0.80 (0.032)	24.0 (0.944)	16.0 (0.629)	4.70 (0.185)	330 (12.99)	24.4 (0.961)	30.4 (1.196)	300	900	BC
0.100µF	CB177K0104+ --	12.8 (0.503)	10.2 (0.402)	4.60 (0.181)	0.80 (0.032)	24.0 (0.944)	16.0 (0.629)	4.70 (0.185)	330 (12.99)	24.4 (0.961)	30.4 (1.196)	300	900	BC

For other Values: upon request

Replace the + by the tolerance code: J = 5% or K = 10%

Replace the -- by the packaging suffix: -- = bulk

BA or BC = tape & reel

Film Chip Capacitors



PEN DIELECTRIC – CB Series

CAPACITANCE VALUES (CR) AND NOMINAL VOLTAGES (VR)

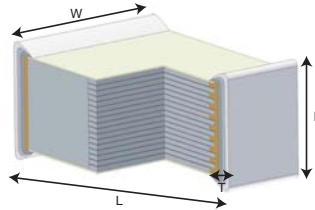

millimeters (inches)

Capacitance Range (CR)	Ordering Code	VOLTAGE Vdc: 630V Vac: 250V											Packaging Unit		Reel Pkg Code
		Chip Dimensions *Tolerances (page 6)				Tape Dimensions			Reel Dimensions						
		L	W	H max	T	W	P1	K0	A	W1	W2 max	Bulk	Reel		
0.120	CB177K0124+ --	12.8 (0.503)	10.2 (0.402)	6.00 (0.236)	0.80 (0.032)	24.0 (0.944)	16.0 (0.629)	7.00 (0.275)	330 (12.99)	24.4 (0.961)	30.4 (1.196)	300	600	BC	
0.15*	CB177K0154K --	12.8 (0.503)	10.2 (0.402)	6.90 (0.271)	0.80 (0.032)	24.0 (0.944)	16.0 (0.629)	7.00 (0.275)	330 (12.99)	24.4 (0.961)	30.4 (1.196)	300	600	BC	
0.180	CB187K0184+ --	15.3 (0.601)	13.7 (0.539)	5.60 (0.220)	0.80 (0.032)	24.0 (0.944)	24.0 (0.944)	6.30 (0.248)	330 (12.99)	24.4 (0.961)	30.4 (1.196)	300	400	BC	
0.220	CB187K0224+ --	15.3 (0.601)	13.7 (0.539)	6.00 (0.236)	0.80 (0.032)	24.0 (0.944)	24.0 (0.944)	6.30 (0.248)	330 (12.99)	24.4 (0.961)	30.4 (1.196)	300	400	BC	

For other Values: upon request

Replace the + by the tolerance code: J = 5% or K = 10%

Replace the -- by the packaging suffix: -- = bulk

BA or BC = tape & reel

*Only available in tolerance ±10%

Film Chip Capacitors



PEN DIELECTRIC – CB Series

MOUNTING AND SOLDERING RECOMMENDATIONS SOLDERING PROFILE

The capacitors can be mounted using infrared and vapor phase soldering following recommended below. They are NOT suitable for wave soldering.

All temperature refer to topside of the package, measured on the package body surface.

Profile Feature	1206 to 1812	2220 to 6054
Ramp-Up (T_s max to T_p)	3°C / second max	3°C / second max
Preheat		
- Temperature Min (T_s min)	150°C	150°C
- Temperature Min (T_s max)	200°C	200°C
- Time (t_s min to t_s max)	180 sec. max	180 sec. max
Time maintained above		
- Temperature (T_L)	217°C	217°C
- Time (t_L)	60 sec. max	75 sec. max
Peak temperature (T_p)	250°C	255°C
Time within 5°C of peak temperature (t_p)	10 sec.	10 sec.
Ramp-Down	6°C / sec.	6°C / sec.

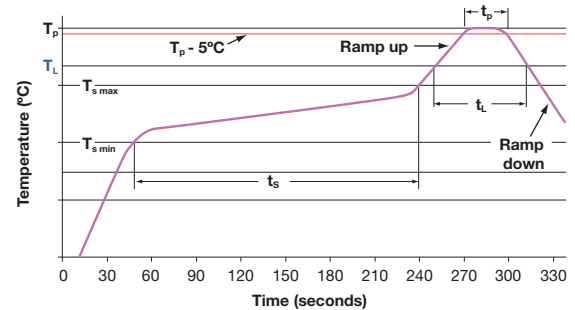

*Reflow soldering referring to JEDEC Standard with some limitations
*JEDEC J-Std 020C

RECOMMENDED SOLDER PASTE THICKNESS

For optimum solderability, the recommended soldering paste thickness: 1206 to 2824 :150 to 200µm

In case of hand soldering, the temperature of the soldering iron should not be above 250°C. Special care must be taken to avoid touching the capacitor body with the iron tip.

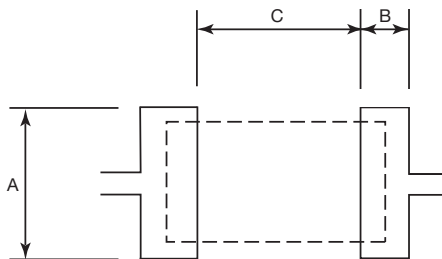

PAD DIMENSIONS: millimeters (inches)

Size Code	Case Size	A	B	C
01	1206	1.30 (0.051)	1.30 (0.051)	2.20 (0.087)
02	1210	2.00 (0.079)	1.30 (0.051)	2.20 (0.087)
03	1812	3.00 (0.118)	1.50 (0.059)	3.50 (0.137)
04	2220	5.00 (0.195)	1.90 (0.075)	4.50 (0.178)
05	2824	6.00 (0.234)	2.50 (0.098)	5.70 (0.224)
16	4030	7.50 (0.295)	3.00 (0.118)	8.00 (0.315)
17	5040	11.2 (0.441)	3.50 (0.137)	10.3 (0.406)
18	6054	14.6 (0.575)	3.60 (0.147)	12.6 (0.496)

RECOMMENDED CLEANING

To clean flux from the PC board assembly, the recommended products are: ethanol, isopropyl alcohol, and deionized water wash. The cleaning products to avoid are: Toluene, Xylene, Trichloroethylene, Terpene Cleaner EC-7, surface active agent. In case of using another solvent, please contact us.

OTHER CAUTIONS

Flame retardancy: the dielectric film is not a flame retardant material.

Environment: contact us when chips are used in humid or gas atmosphere and /or when using resin.

Recommended handling: do not use edged tools, so not to damage the capacitors.

TIN WHISKERS TESTS : JEDEC STANDARD NO 22A121

Stress Type	Ref. Spec.	Test Conditions	Analysis	Results
Temperature cycling	JESD22-A104	-55°C +85(+10/-0)°C air 5 to 10 minutes soak 3 cycles/hour	SEM x 1000	Pass
Ambient Temperature / Humidity Storage		30+/-2°C - 60+/-3% RH -2000H	SEM x 1000	Pass
High Temperature / Humidity Storage		70+/-5°C - 93+3/-2% RH -1000H	SEM x 1000	Pass

Film Chip Capacitors



PEN DIELECTRIC – CB Series

ELECTRICAL CHARACTERISTICS VERSUS TEMPERATURE AND FREQUENCY

ELECTRICAL CHARACTERISTICS

Capacitance

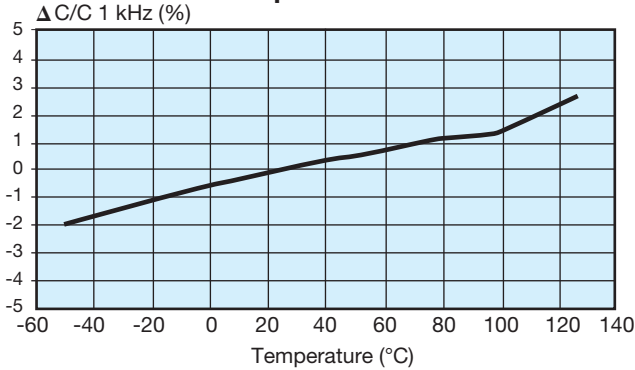

Dissipation Factor

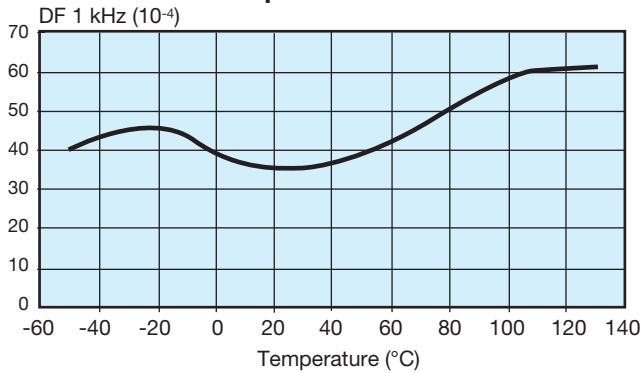

Insulation Resistance

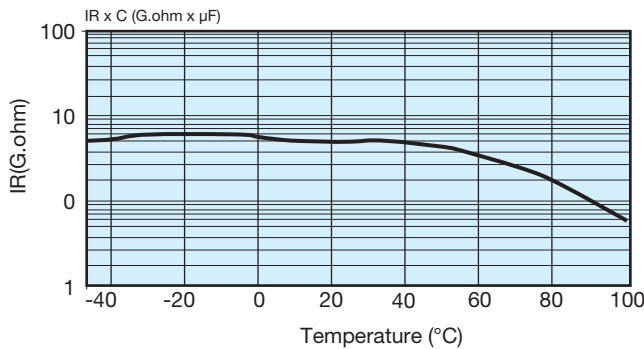

FREQUENCY CHARACTERISTICS

Capacitance

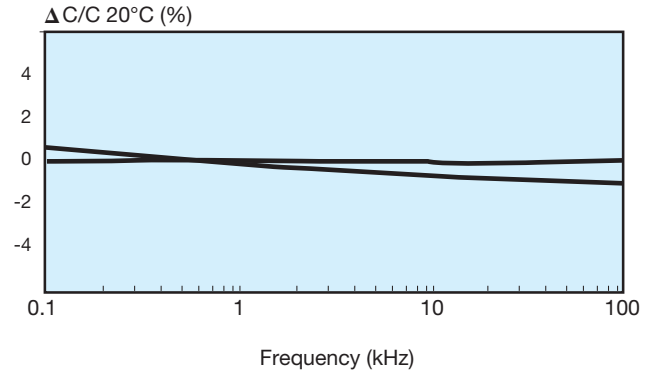

Dissipation Factor

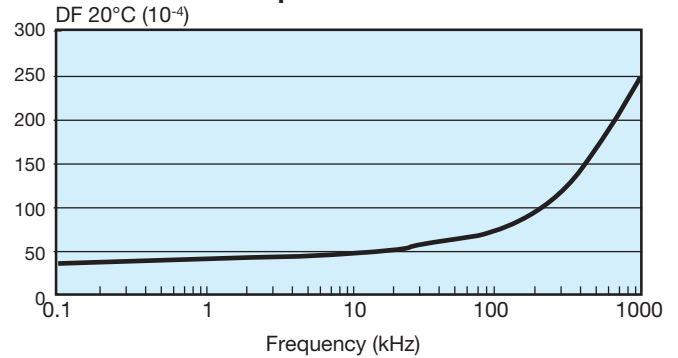

Impedance

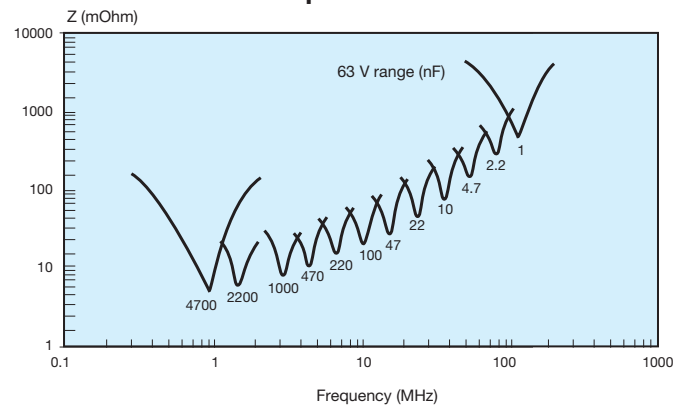

RMS VOLTAGE AND CURRENT VERSUS FREQUENCY

MAXIMUM VOLTAGE (V_{RMS}) AND CURRENT (I_{RMS}) VS FREQUENCY

Typical curves results from measurement carried out at ambient temperature (25°C) and sinusoidal wave-forms (for size CB01 to CB05)

63 Vdc / 40 Vac

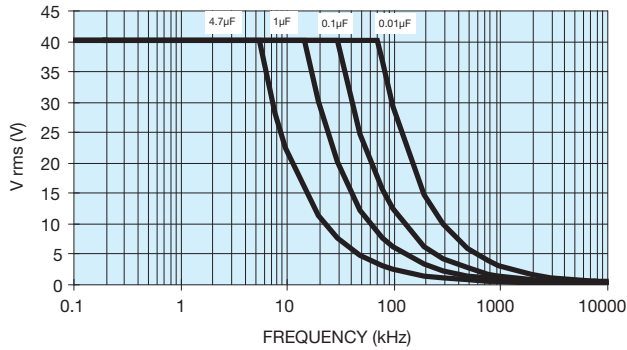

63 Vdc / 40 Vac

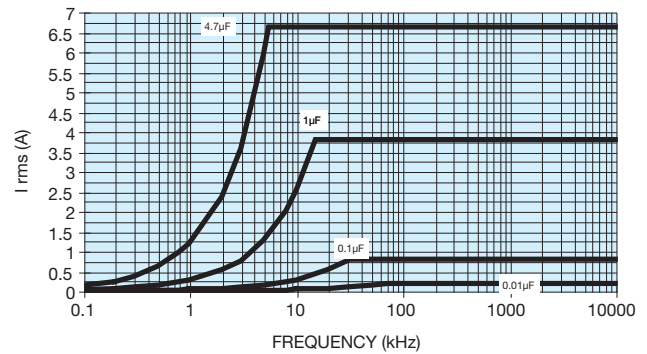

100 Vdc / 63 Vac

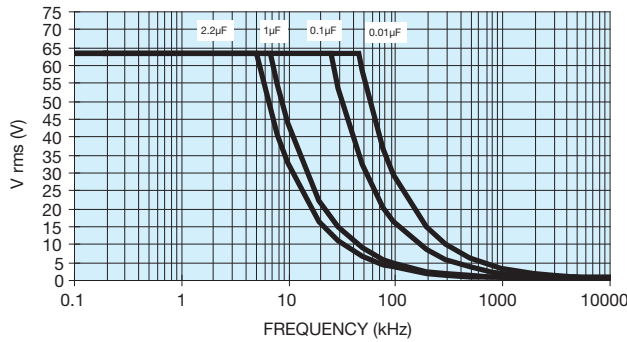

100 Vdc / 63 Vac

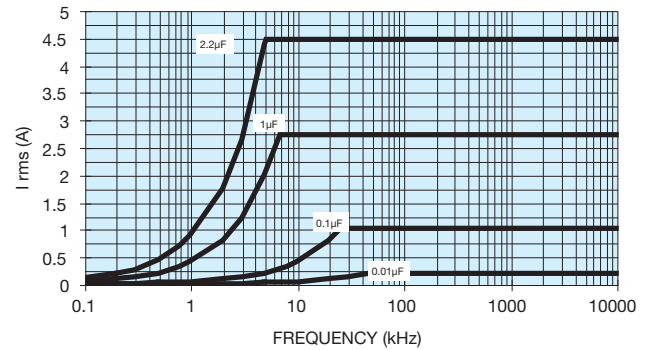

250 Vdc / 160 Vac

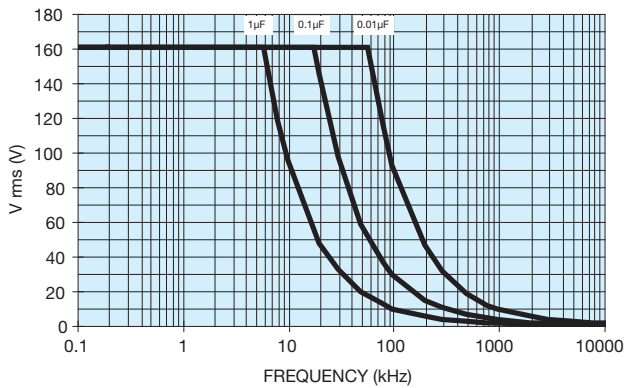

250 Vdc / 160 Vac

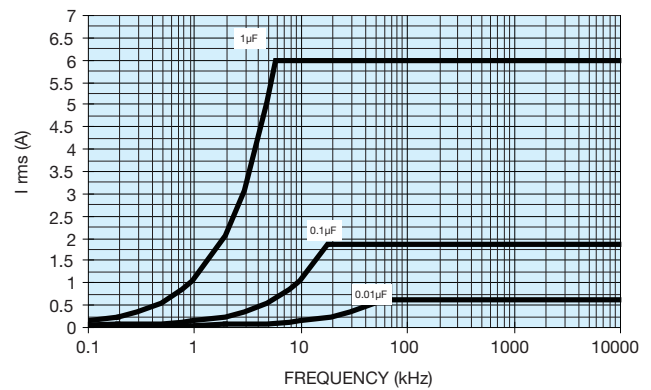

RMS VOLTAGE AND CURRENT VERSUS FREQUENCY

MAXIMUM VOLTAGE (V_{RMS}) AND CURRENT (I_{RMS}) VS FREQUENCY

Typical curves results from measurement carried out at ambient temperature (25°C) and sinusoidal wave-forms (for size CB03 to CB05)

400 Vdc / 200 Vac

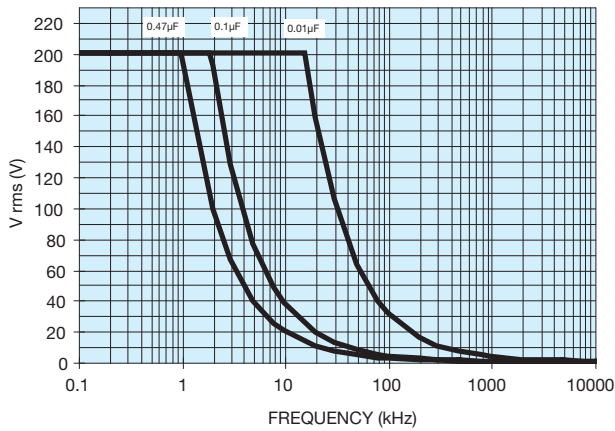

400 Vdc / 200 Vac

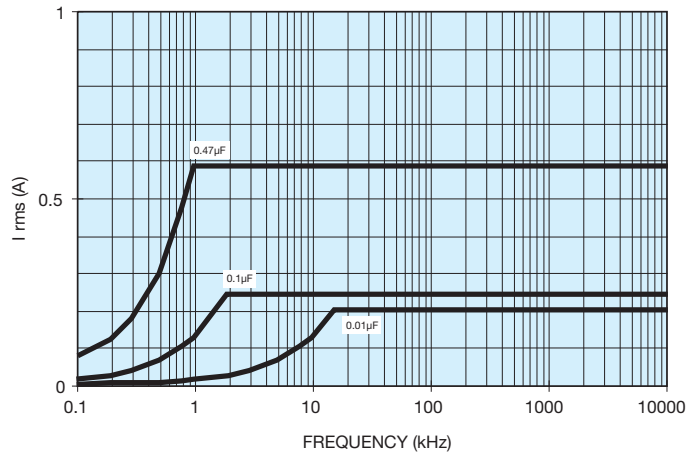

630 Vdc / 250 Vac

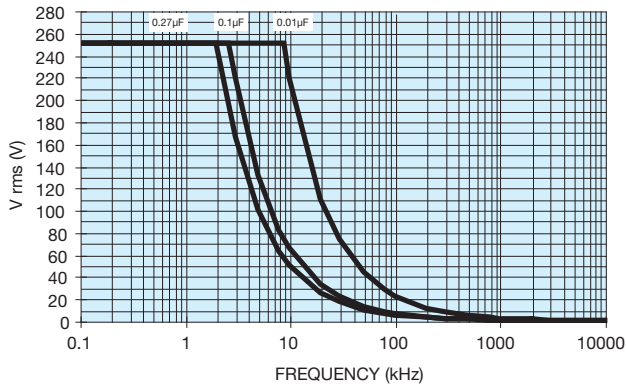

630 Vdc / 250 Vac

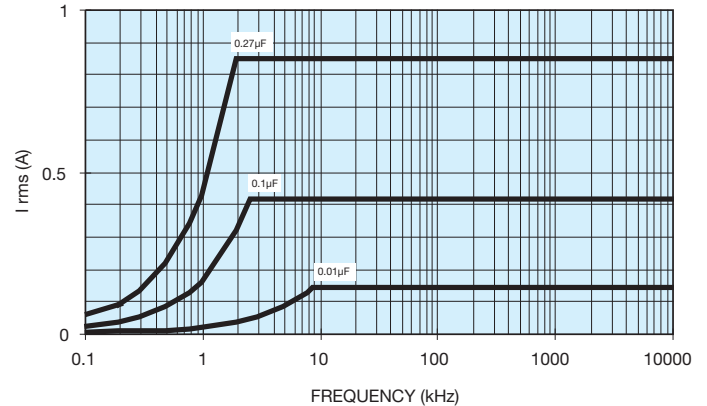

MAXIMUM PULSE RISE TIME (DV/DT)

Voltage Range	25	50	63	100	250	400	630
Dv/dt max. (V/µsec)	15	40	40	50	150	200	250

Film Chip Capacitors



PEN DIELECTRIC – CB Series – RoHS

MATERIALS CONTROLLED BY ROHS (PPM BY WEIGHT):

Mass / unit (g)	Lead	Mercury	Cadmium	Hexavalent Chromium	PBB	PBDE
CB range	0	0	0	0	0	0
RoHS Limit (ppm)	1000	1000	100	1000	1000	1000
Pass/Fail	Pass	Pass	Pass	Pass	Pass	Pass

This product has been tested and found to be compliant with all requirements, provisions, and exemptions of EU Directive 2002/95/EC of the European Parliament and Council of January 27, 2003. On the Restriction of use of certain Hazardous Substances (RoHS) in electrical and electronic equipment and EU Directive 2000/53/EC regarding ELV or End of Life Vehicle.

ROHS / ELV STATUS

External Plating
100% Matte Sn as standard

LEAD-FREE STATUS / MOISTURE SENSITIVITY RANKING

Pb Free Reflow Solder compliant, MSL = 3.
Reflow soldering referring to Jedec Standard with some limitations. Additional JESD-97 data to be phased in MSL e3 termination.

PRODUCT LABELING:

(For informational purposes only to be phased in on reel and container.)

PRODUCT TRACEABILITY:

Full internal material traceability by reference to unique lot number marked on reel and external package.

Pb Free:



RoHS Compliant:



Film Chip Capacitors



PPS DIELECTRIC – CB Series

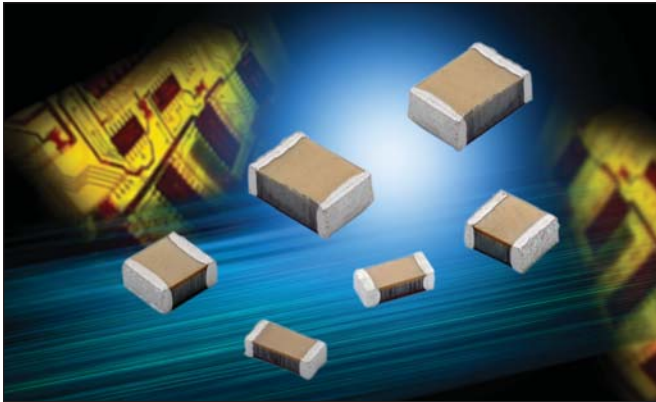

GENERAL DESCRIPTION

Film chip capacitor using a naked and stacked construction with metallized PolyPhenylene Sulfide film (PPS)

ADVANTAGES

- Applicable for both flow and reflow soldering.
- Very constant Capacitance value with temperature.
- Low dielectric absorption.
- The intrinsic elasticity of the dielectric film provides an excellent compatibility of the capacitor with all types of material for printed circuit boards.
- Excellent thermal shock resistance.
- Low dissipation factor, ESR and ESL.
- No piezoelectric effect.
- Available in tape and reel suitable for automatic placement.
- Non-polar construction.

APPLICATIONS

General purpose function in low voltage applications:

- Filtering, coupling, decoupling
- Time-constant
- Oscillation timing circuit

Typical applications would be:

- Automotive (navigation system ...)
- Telecom (GSM PLL circuit, ADSL system ...)
- Industrial (Lighting and power supplies...)

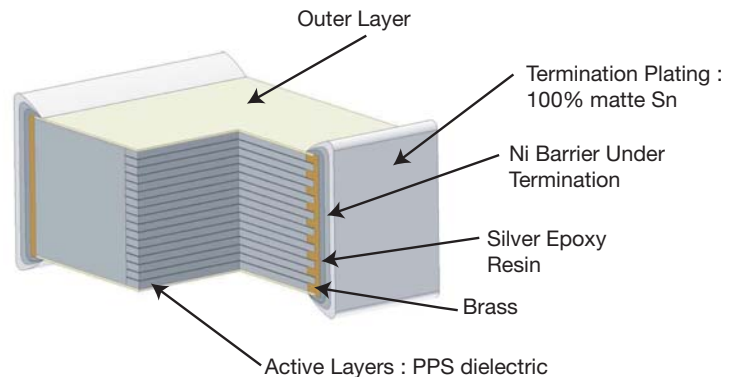

PERFORMANCE CHARACTERISTICS

Climatic Category	55/125/56
Capacitance Range	1nF to 180nF
Tolerance on C_R	$\pm 2\%$, $\pm 5\%$, $\pm 10\%$
Nominal Voltages	16Vdc to 50Vdc
Test Voltage	1.4Vr 2 sec. at 25°C
Soldering methods	IR vapor phase reflow
Tangent of Loss Angle at 1kHz (DF)	$< 50 \times 10^{-4}$
Insulation resistance minimum: IR	for $C \leq 0.33\mu\text{F}$ IR $> 1000 \text{ M}\Omega$ at 20°C for 1 min. charge at 10VDC for VR $< 100\text{VDC}$
Temperature range	-55°C to 125°C
A.C. applications	for high frequency A.C. application please check with AVX

No self-healing properties

Film Chip Capacitors



PPS DIELECTRIC – CB Series

CAPACITANCE VALUES (CR) AND NOMINAL VOLTAGES (VR)

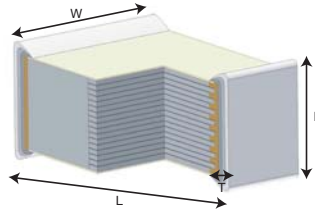

millimeters (inches)

Capacitance Range (CR)	Ordering Code	VOLTAGE Vdc: 16V Vac: 10V											Packaging Unit		Reel Pkg Code
		Chip Dimensions *Tolerances (page 6)				Tape Dimensions			Reel Dimensions						
		L	W	H max	T	W	P1	K0	A	W1	W2 max	Bulk	Reel		
0.001µF	CB018B0102+ --	3.30 (0.130)	1.60 (0.063)	1.15 (0.045)	0.50 (0.020)	8.00 (0.315)	4.00 (0.158)	1.20 (0.047)	180 (7.087)	8.40 (0.331)	14.4 (0.567)	2000	3900	BA	
0.0012	CB018B0122+ --	3.30 (0.130)	1.60 (0.063)	1.15 (0.045)	0.50 (0.020)	8.00 (0.315)	4.00 (0.158)	1.20 (0.047)	180 (7.087)	8.40 (0.331)	14.4 (0.567)	2000	3900	BA	
0.0015	CB018B0152+ --	3.30 (0.130)	1.60 (0.063)	1.15 (0.045)	0.50 (0.020)	8.00 (0.315)	4.00 (0.158)	1.20 (0.047)	180 (7.087)	8.40 (0.331)	14.4 (0.567)	2000	3900	BA	
0.0018	CB018B0182+ --	3.30 (0.130)	1.60 (0.063)	1.15 (0.045)	0.50 (0.020)	8.00 (0.315)	4.00 (0.158)	1.20 (0.047)	180 (7.087)	8.40 (0.331)	14.4 (0.567)	2000	3900	BA	
0.0022	CB018B0222+ --	3.30 (0.130)	1.60 (0.063)	1.15 (0.045)	0.50 (0.020)	8.00 (0.315)	4.00 (0.158)	1.20 (0.047)	180 (7.087)	8.40 (0.331)	14.4 (0.567)	2000	3900	BA	
0.0027	CB018B0272+ --	3.30 (0.130)	1.60 (0.063)	1.15 (0.045)	0.50 (0.020)	8.00 (0.315)	4.00 (0.158)	1.20 (0.047)	180 (7.087)	8.40 (0.331)	14.4 (0.567)	2000	3900	BA	
0.0033	CB018B0332+ --	3.30 (0.130)	1.60 (0.063)	1.15 (0.045)	0.50 (0.020)	8.00 (0.315)	4.00 (0.158)	1.20 (0.047)	180 (7.087)	8.40 (0.331)	14.4 (0.567)	2000	3900	BA	
0.0047	CB018B0472+ --	3.30 (0.130)	1.60 (0.063)	1.15 (0.045)	0.50 (0.020)	8.00 (0.315)	4.00 (0.158)	1.20 (0.047)	180 (7.087)	8.40 (0.331)	14.4 (0.567)	2000	3900	BA	
0.0056	CB018B0562+ --	3.30 (0.130)	1.60 (0.063)	1.15 (0.045)	0.50 (0.020)	8.00 (0.315)	4.00 (0.158)	1.20 (0.047)	180 (7.087)	8.40 (0.331)	14.4 (0.567)	2000	3900	BA	
0.0068	CB018B0682+ --	3.30 (0.130)	1.60 (0.063)	1.15 (0.045)	0.50 (0.020)	8.00 (0.315)	4.00 (0.158)	1.20 (0.047)	180 (7.087)	8.40 (0.331)	14.4 (0.567)	2000	3900	BA	
0.0082	CB018B0822+ --	3.30 (0.130)	1.60 (0.063)	1.15 (0.045)	0.50 (0.020)	8.00 (0.315)	4.00 (0.158)	1.20 (0.047)	180 (7.087)	8.40 (0.331)	14.4 (0.567)	2000	3900	BA	
0.010µF	CB018B0103+ --	3.30 (0.130)	1.60 (0.063)	1.15 (0.045)	0.50 (0.020)	8.00 (0.315)	4.00 (0.158)	1.20 (0.047)	180 (7.087)	8.40 (0.331)	14.4 (0.567)	2000	3900	BA	
0.012	CB018B0123+ --	3.30 (0.130)	1.60 (0.063)	1.15 (0.045)	0.50 (0.020)	8.00 (0.315)	4.00 (0.158)	1.20 (0.047)	180 (7.087)	8.40 (0.331)	14.4 (0.567)	2000	3900	BA	
0.015	CB018B0153+ --	3.30 (0.130)	1.60 (0.063)	1.15 (0.045)	0.50 (0.020)	8.00 (0.315)	4.00 (0.158)	1.20 (0.047)	180 (7.087)	8.40 (0.331)	14.4 (0.567)	2000	3900	BA	
0.018	CB018B0183+ --	3.30 (0.130)	1.60 (0.063)	1.15 (0.045)	0.50 (0.020)	8.00 (0.315)	4.00 (0.158)	1.20 (0.047)	180 (7.087)	8.40 (0.331)	14.4 (0.567)	2000	3900	BA	
0.022	CB018B0223+ --	3.30 (0.130)	1.60 (0.063)	1.15 (0.045)	0.50 (0.020)	8.00 (0.315)	4.00 (0.158)	1.20 (0.047)	180 (7.087)	8.40 (0.331)	14.4 (0.567)	2000	3900	BA	
0.027	CB018B0273+ --	3.30 (0.130)	1.60 (0.063)	1.15 (0.045)	0.50 (0.020)	8.00 (0.315)	4.00 (0.158)	1.20 (0.047)	180 (7.087)	8.40 (0.331)	14.4 (0.567)	2000	3900	BA	
0.033	CB018B0333+ --	3.30 (0.130)	1.60 (0.063)	1.15 (0.045)	0.50 (0.020)	8.00 (0.315)	4.00 (0.158)	1.20 (0.047)	180 (7.087)	8.40 (0.331)	14.4 (0.567)	2000	3900	BA	
0.039	CB018B0393+ --	3.30 (0.130)	1.60 (0.063)	1.15 (0.045)	0.50 (0.020)	8.00 (0.315)	4.00 (0.158)	1.20 (0.047)	180 (7.087)	8.40 (0.331)	14.4 (0.567)	2000	3900	BA	
0.047	CB028B0473+ --	3.30 (0.130)	2.50 (0.098)	1.80 (0.071)	0.50 (0.020)	8.00 (0.315)	4.00 (0.158)	1.90 (0.075)	180 (7.087)	8.40 (0.331)	14.4 (0.567)	2000	2500	BA	
0.056	CB028B0563+ --	3.30 (0.130)	2.50 (0.098)	1.80 (0.098)	0.50 (0.020)	8.00 (0.315)	4.00 (0.158)	1.90 (0.075)	180 (7.087)	8.40 (0.331)	14.4 (0.567)	2000	2500	BA	
0.068	CB028B0683+ --	3.30 (0.130)	2.50 (0.098)	1.80 (0.071)	0.50 (0.020)	8.00 (0.315)	4.00 (0.158)	1.90 (0.075)	180 (7.087)	8.40 (0.331)	14.4 (0.567)	2000	2500	BA	
0.082	CB028B0823+ --	3.30 (0.130)	2.50 (0.098)	1.80 (0.071)	0.50 (0.020)	8.00 (0.315)	4.00 (0.158)	1.90 (0.075)	180 (7.087)	8.40 (0.331)	14.4 (0.567)	2000	2500	BA	

For other Values: upon request

Replace the + by the tolerance code: G = 2%, J = 5% or K = 10%

Replace the -- by the packaging suffix: -- = bulk

BA or BC = tape & reel



Film Chip Capacitors



PPS DIELECTRIC – CB Series

CAPACITANCE VALUES (CR) AND NOMINAL VOLTAGES (VR)

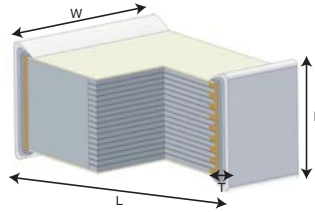

millimeters (inches)

Capacitance Range (CR)	Ordering Code	VOLTAGE Vdc: 16V Vac: 10V												
		Chip Dimensions *Tolerances (page 6)				Tape Dimensions			Reel Dimensions			Packaging Unit		Reel Pkg Code
		L	W	H max	T	W	P1	K0	A	W1	W2 max	Bulk	Reel	
0.100µF	CB028B0104+ --	3.30 (0.130)	2.50 (0.098)	2.10 (0.083)	0.50 (0.020)	8.00 (0.315)	4.00 (0.158)	2.33 (0.092)	180 (7.087)	8.4 (0.331)	14.4 (0.567)	2000	2000	BA
0.120	CB038B0124+ --	4.50 (0.177)	3.20 (0.126)	2.30 (0.091)	0.60 (0.024)	12.0 (0.472)	8.00 (0.315)	2.60 (0.102)	180 (7.087)	12.4 (0.488)	18.4 (0.724)	1500	900	BA
		4.50 (0.177)	3.20 (0.126)	2.30 (0.091)	0.60 (0.024)	12.0 (0.472)	8.00 (0.315)	2.60 (0.102)	330 (12.99)	12.4 (0.488)	18.4 (0.724)	1500	3600	BC
0.150	CB038B0154+ --	4.50 (0.177)	3.20 (0.126)	2.30 (0.091)	0.60 (0.024)	12.0 (0.472)	8.00 (0.315)	2.60 (0.102)	180 (7.087)	12.4 (0.488)	18.4 (0.724)	1500	900	BA
		4.50 (0.177)	3.20 (0.126)	2.30 (0.091)	0.60 (0.024)	12.0 (0.472)	8.00 (0.315)	2.60 (0.102)	330 (12.99)	12.4 (0.488)	18.4 (0.724)	1500	3600	BC
0.180	CB038B0184+ --	4.50 (0.177)	3.20 (0.126)	2.50 (0.098)	0.60 (0.024)	12.0 (0.472)	8.00 (0.315)	2.60 (0.102)	180 (7.09)	12.4 (0.488)	18.4 (0.724)	1500	900	BA
		4.50 (0.177)	3.20 (0.126)	2.50 (0.098)	0.60 (0.024)	12.0 (0.472)	8.00 (0.315)	2.60 (0.102)	330 (12.99)	12.4 (0.488)	18.4 (0.724)	1500	3600	BC
VOLTAGE Vdc: 50V Vac: 40V														
0.001µF	CB018D0102+ --	3.30 (0.130)	1.60 (0.063)	1.15 (0.045)	0.50 (0.020)	8.00 (0.315)	4.00 (0.158)	1.20 (0.047)	180 (7.087)	8.40 (0.331)	14.4 (0.567)	2000	3900	BA
0.0012	CB018D0122+ --	3.30 (0.130)	1.60 (0.063)	1.15 (0.045)	0.50 (0.020)	8.00 (0.315)	4.00 (0.158)	1.20 (0.047)	180 (7.087)	8.40 (0.331)	14.4 (0.567)	2000	3900	BA
0.0015	CB018D0152+ --	3.30 (0.130)	1.60 (0.063)	1.15 (0.045)	0.50 (0.020)	8.00 (0.315)	4.00 (0.158)	1.20 (0.147)	180 (7.087)	8.40 (0.331)	14.4 (0.567)	2000	3900	BA
0.0018	CB018D0182+ --	3.30 (0.130)	1.60 (0.063)	1.15 (0.045)	0.50 (0.020)	8.00 (0.315)	4.00 (0.158)	1.20 (0.047)	180 (7.087)	8.40 (0.331)	14.4 (0.567)	2000	3900	BA
0.0022	CB018D0222+ --	3.30 (0.130)	1.60 (0.063)	1.15 (0.045)	0.50 (0.020)	8.00 (0.315)	4.00 (0.158)	1.20 (0.047)	180 (7.087)	8.40 (0.331)	14.4 (0.567)	2000	3900	BA
0.0027	CB018D0272+ --	3.30 (0.130)	1.60 (0.063)	1.15 (0.045)	0.50 (0.020)	8.00 (0.315)	4.00 (0.158)	1.20 (0.047)	180 (7.087)	8.40 (0.331)	14.4 (0.567)	2000	3900	BA
0.0033	CB018D0332+ --	3.30 (0.130)	1.60 (0.063)	1.15 (0.045)	0.50 (0.020)	8.00 (0.315)	4.00 (0.158)	1.20 (0.047)	180 (7.087)	8.40 (0.331)	14.4 (0.567)	2000	3900	BA
0.0047	CB018D0472+ --	3.30 (0.130)	1.60 (0.063)	1.15 (0.045)	0.50 (0.020)	8.00 (0.315)	4.00 (0.158)	1.20 (0.047)	180 (7.087)	8.40 (0.331)	14.4 (0.567)	2000	3900	BA
0.0056	CB018D0562+ --	3.30 (0.130)	1.60 (0.063)	1.15 (0.045)	0.50 (0.020)	8.00 (0.315)	4.00 (0.158)	1.20 (0.047)	180 (7.087)	8.40 (0.331)	14.4 (0.567)	2000	3900	BA
0.0068	CB018D0682+ --	3.30 (0.130)	1.60 (0.063)	1.15 (0.045)	0.50 (0.020)	8.00 (0.315)	4.00 (0.158)	1.20 (0.047)	180 (7.087)	8.40 (0.331)	14.4 (0.567)	2000	3900	BA
0.0082	CB018D0822+ --	3.30 (0.130)	1.60 (0.063)	1.15 (0.045)	0.50 (0.020)	8.00 (0.315)	4.00 (0.158)	1.20 (0.047)	180 (7.087)	8.40 (0.331)	14.4 (0.567)	2000	3900	BA
0.010µF	CB018D0103+ --	3.30 (0.130)	1.60 (0.063)	1.15 (0.045)	0.50 (0.020)	8.00 (0.315)	4.00 (0.158)	1.20 (0.047)	180 (7.087)	8.40 (0.331)	14.4 (0.567)	2000	3900	BA
0.012	CB028D0123+ --	3.30 (0.130)	2.50 (0.098)	1.80 (0.071)	0.50 (0.020)	8.00 (0.315)	4.00 (0.158)	1.90 (0.075)	180 (7.087)	8.40 (0.331)	14.4 (0.567)	2000	2500	BA
0.015	CB028D0153+ --	3.30 (0.130)	2.50 (0.098)	1.80 (0.071)	0.50 (0.020)	8.00 (0.315)	4.00 (0.158)	1.90 (0.158)	180 (7.087)	8.40 (0.331)	14.4 (0.567)	2000	2500	BA
0.018	CB028D0183+ --	3.30 (0.130)	2.50 (0.098)	1.80 (0.071)	0.50 (0.020)	8.00 (0.315)	4.00 (0.158)	1.90 (0.075)	180 (7.087)	8.40 (0.331)	14.4 (0.567)	2000	2500	BA
0.022	CB028D0223+ --	3.30 (0.130)	2.50 (0.098)	1.80 (0.071)	0.50 (0.020)	8.00 (0.315)	4.00 (0.158)	1.90 (0.075)	180 (7.087)	8.40 (0.331)	14.4 (0.567)	2000	2500	BA

For other Values: upon request

Replace the + by the tolerance code: G = 2%, J = 5% or K = 10%

Replace the -- by the packaging suffix: -- = bulk

BA or BC = tape & reel



Film Chip Capacitors



PPS DIELECTRIC – CB Series

CAPACITANCE VALUES (CR) AND NOMINAL VOLTAGES (VR)



millimeters (inches)

Capacitance Range (CR)	Ordering Code	VOLTAGE Vdc: 50V Vac: 40V											Packaging Unit		Reel Pkg Code
		Chip Dimensions *Tolerances (page 6)				Tape Dimensions			Reel Dimensions			Bulk	Reel		
		L	W	H max	T	W	P1	K0	A	W1	W2 max				
0.027	CB028D0273+ --	3.30 (0.130)	2.50 (0.098)	2.10 (0.083)	0.50 (0.020)	8.00 (0.315)	4.00 (0.158)	2.30 (0.091)	180 (7.087)	8.40 (0.331)	14.4 (0.567)	2000	2000	BA	
0.033	CB028D0333+ --	3.30 (0.130)	2.50 (0.098)	2.10 (0.083)	0.50 (0.020)	8.00 (0.315)	4.00 (0.158)	2.30 (0.091)	180 (7.087)	8.40 (0.331)	14.4 (0.567)	2000	2000	BA	
0.039	CB028D0393+ --	3.30 (0.130)	2.50 (0.098)	2.1 (0.083)	0.50 (0.020)	8.00 (0.315)	4.00 (0.158)	2.30 (0.091)	181 (7.087)	8.40 (0.331)	14.4 (0.567)	2000	2000	BA	
0.047	CB038D0473+ --	4.50 (0.1777)	3.20 (0.126)	2.4 (0.095)	0.60 (0.024)	12.0 (0.472)	8.00 (0.315)	2.60 (0.102)	180 (7.087)	12.4 (0.488)	18.4 (0.724)	1500	900	BA	
		4.50 (0.177)	3.20 (0.126)	2.4 (0.095)	0.60 (0.024)	12.0 (0.472)	8.00 (0.315)	2.60 (0.102)	330 (12.99)	12.4 (0.488)	18.4 (0.724)	1500	3600	BC	
0.056	CB038D0563+ --	4.50 (0.177)	3.20 (0.126)	2.40 (0.095)	0.60 (0.024)	12.0 (0.472)	8.00 (0.315)	2.60 (0.102)	180 (7.087)	12.4 (0.488)	18.4 (0.724)	1500	900	BA	
		4.50 (0.177)	3.20 (0.126)	2.40 (0.095)	0.60 (0.024)	12.0 (0.472)	8.00 (0.315)	2.60 (0.102)	330 (12.99)	12.4 (0.488)	18.4 (0.724)	1500	3600	BC	
0.068	CB038D0683+ --	4.50 (0.177)	3.20 (0.126)	2.40 (0.095)	0.60 (0.024)	12.0 (0.472)	8.00 (0.315)	2.60 (0.102)	180 (7.087)	12.4 (0.488)	18.4 (0.724)	1500	900	BA	
		4.50 (0.177)	3.20 (0.126)	2.40 (0.095)	0.60 (0.024)	12.0 (0.472)	8.00 (0.315)	2.60 (0.102)	330 (12.99)	12.4 (0.488)	18.4 (0.724)	1500	3600	BC	
0.082	CB038D0823+ --	4.50 (0.177)	3.20 (0.126)	2.40 (0.095)	0.60 (0.024)	12.0 (0.472)	8.00 (0.315)	2.60 (0.102)	180 (7.087)	12.4 (0.488)	18.4 (0.724)	1500	900	BA	
		4.50 (0.177)	3.20 (0.126)	2.40 (0.095)	0.60 (0.024)	12.0 (0.472)	8.00 (0.315)	2.60 (0.102)	330 (12.99)	12.4 (0.488)	18.4 (0.724)	1500	3600	BC	
0.100μF	CB038D0104+ --	4.50 (0.177)	3.20 (0.126)	2.40 (0.095)	0.60 (0.024)	12.0 (0.472)	8.00 (0.315)	2.60 (0.102)	180 (7.087)	12.4 (0.488)	18.4 (0.724)	1500	900	BA	
		4.50 (0.177)	3.20 (0.126)	2.40 (0.095)	0.60 (0.024)	12.0 (0.472)	8.00 (0.315)	2.60 (0.102)	330 (12.99)	12.4 (0.488)	18.4 (0.724)	1500	3600	BC	

For other Values: upon request

Replace the + by the tolerance code: G = 2%, J = 5% or K = 10%

Replace the -- by the packaging suffix: -- = bulk

BA or BC = tape & reel

Film Chip Capacitors



PPS DIELECTRIC – CB Series

MOUNTING AND SOLDERING RECOMMENDATIONS

SOLDERING PROFILE

The capacitors can be mounted using infrared and vapor phase soldering following recommended below. They are NOT suitable for wave soldering.

All temperature refer to topside of the package, measured on the package body surface.

Profile Feature	1206 to 1812
Ramp-Up (T_s max to T_p)	3°C / second max
Preheat	
- Temperature Min (T_s min)	150°C
- Temperature Min (T_s max)	200°C
- Time (t_s min to t_s max)	180 sec. max
Time maintained above	
- Temperature (T_L)	217°C
- Time (t_L)	90 sec. max
Peak temperature (T_p)	260°C
Time within 5°C of peak temperature (t_p)	10 sec.
Ramp-Down	6°C / sec.

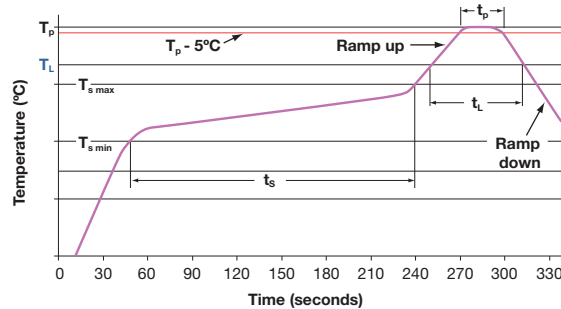

*Reflow soldering referring to JEDEC Standard with some limitations
*JEDEC J-Std 020C

RECOMMENDED SOLDER PASTE THICKNESS

For optimum solderability, the recommended soldering paste thickness: 1206 to 1812 :150 to 200µm

In case of hand soldering, the temperature of the soldering iron should not be above 250°C. Special care must be taken to avoid touching the capacitor body with the iron tip.

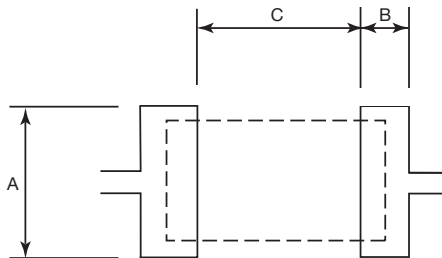

PAD DIMENSIONS: millimeters (inches)

Size Code	Case Size	A	B	C
01	1206	1.30 (0.051)	1.30 (0.051)	2.20 (0.087)
02	1210	2.00 (0.079)	1.30 (0.051)	2.20 (0.087)
03	1812	3.00 (0.118)	1.50 (0.059)	3.50 (0.137)

RECOMMENDED CLEANING

To clean flux from the PC board assembly, the recommended products are: ethanol, isopropyl alcohol, and deionized water wash. The cleaning products to avoid are: Toluene, Xylene, Trichloroethylene, Terpene Cleaner EC-7, surface active agent. In case of using another solvent, please contact us.

OTHER CAUTIONS

Flame retardancy: the dielectric film is not a flame retardant material.

Environment: contact us when chips are used in humid or gas atmosphere and /or when using resin.

Recommended handling: do not use edged tools, so not to damage the capacitors.

TIN WHISKERS TESTS : JEDEC STANDARD NO 22A121

Stress Type	Ref. Spec.	Test Conditions	Analysis	Results
Temperature cycling	JESD22-A104	-55°C +85(+10/-0)°C air 5 to 10 minutes soak 3 cycles/hour	SEM x 1000	Pass
Ambient Temperature / Humidity Storage		30+/-2°C - 60+/-3% RH -2000H	SEM x 1000	Pass
High Temperature / Humidity Storage		70+/-5°C - 93+3/-2% RH -1000H	SEM x 1000	Pass



Film Chip Capacitors



PPS DIELECTRIC – CB Series

ELECTRICAL CHARACTERISTICS VERSUS TEMPERATURE AND FREQUENCY

ELECTRICAL CHARACTERISTICS

Capacitance

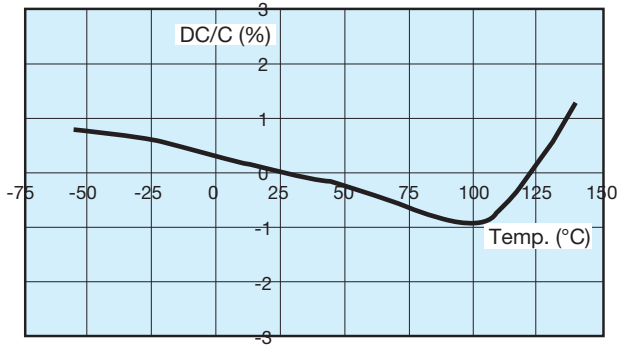

Dissipation Factor

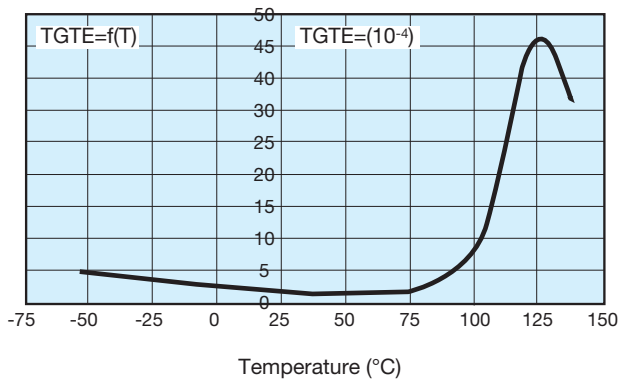

Insulation Resistance

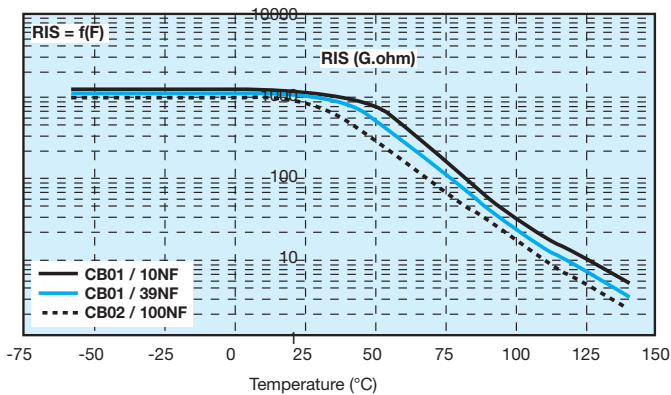

FREQUENCY CHARACTERISTICS

Capacitance

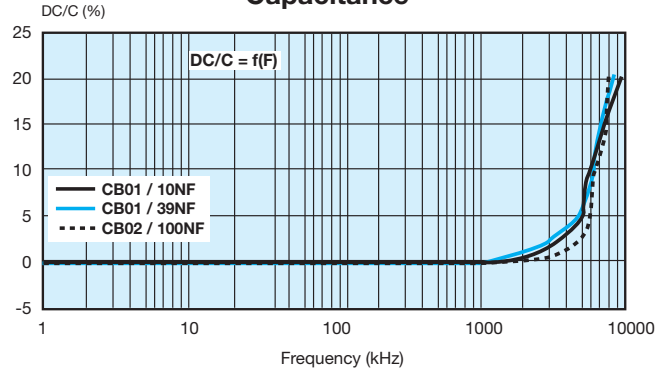

Dissipation Factor

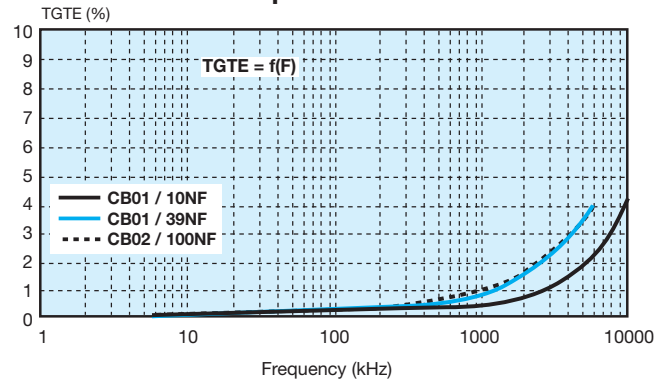

Impedance

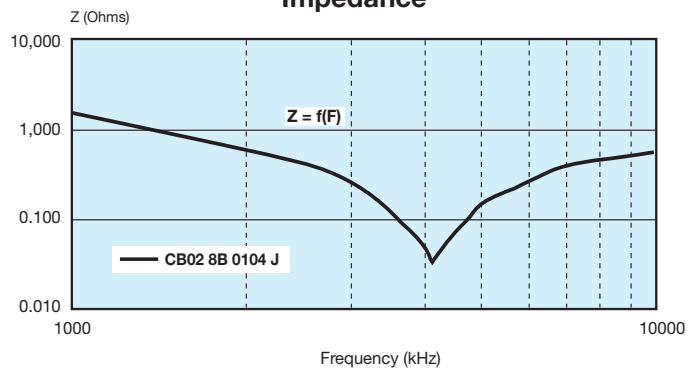

RMS VOLTAGE AND CURRENT VERSUS FREQUENCY

MAXIMUM VOLTAGE (VRMS) AND CURRENT (IRMS) VS FREQUENCY

Typical curves results from measurement carried out at ambient temperature (25°C) and sinusoidal wave-forms (for size CB01 to CB03)

16 Vdc

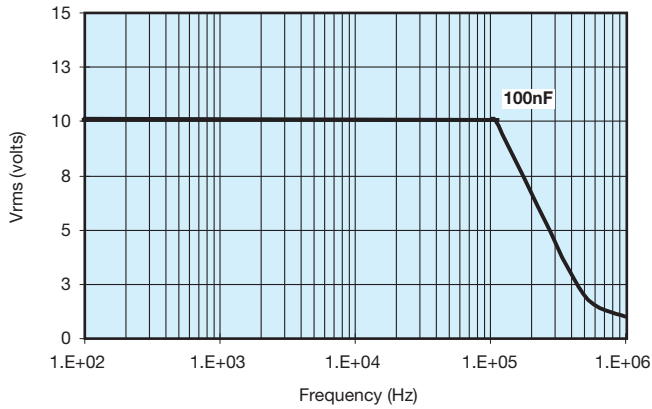

16 Vdc

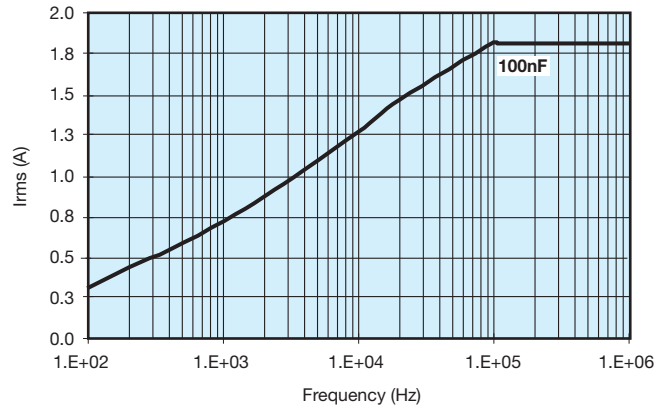

50 Vdc

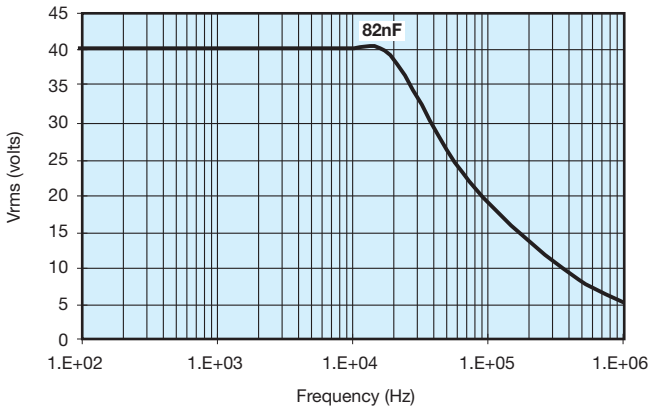

50 Vdc

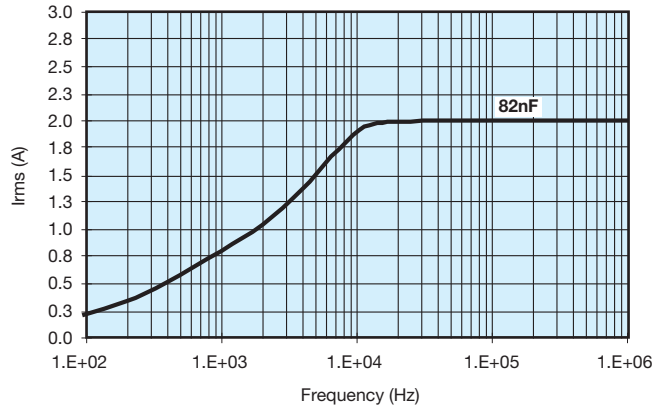

Film Chip Capacitors



PPS DIELECTRIC – CB Series – RoHS

MATERIALS CONTROLLED BY ROHS (PPM BY WEIGHT):

Mass / unit (g)	Lead	Mercury	Cadmium	Hexavalent Chromium	PBB	PBDE
CB range	0	0	0	0	0	0
RoHS Limit (ppm)	1000	1000	100	1000	1000	1000
Pass/Fail	Pass	Pass	Pass	Pass	Pass	Pass

This product has been tested and found to be compliant with all requirements, provisions, and exemptions of EU Directive 2002/95/EC of the European Parliament and Council of January 27, 2003. On the Restriction of use of certain Hazardous Substances (RoHS) in electrical and electronic equipment and EU Directive 2000/53/EC regarding ELV or End of Life Vehicle.

ROHS / ELV STATUS

External Plating
100% Matte Sn as standard

LEAD-FREE STATUS / MOISTURE SENSITIVITY RANKING

Pb Free Reflow Solder compliant, MSL = 2a.
Reflow soldering referring to Jedec Standard with some limitations. Additional JESD-97 data to be phased in MSL e3 termination.

PRODUCT LABELING:

(For informational purposes only to be phased in on reel and container.)

PRODUCT TRACEABILITY:

Full internal material traceability by reference to unique lot number marked on reel and external package.

Pb Free:



RoHS Compliant:



Film Chip Capacitors



High Surge Voltage SMD Film Capacitors – CL Series

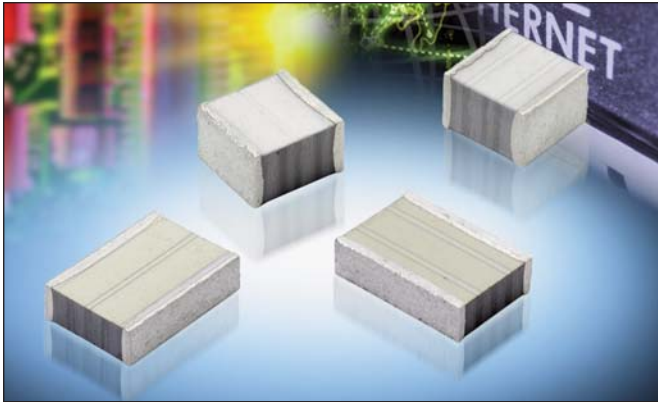

GENERAL DESCRIPTION

Film chip capacitor using a naked and stacked construction with metallized Polyethylene Naphtalate film (PEN) Usage of a multitrack technology results to an equivalent serial construction which gives better high voltage surge handling capability.

ADVANTAGES

- Surge Voltage up to 1500V (10/700 μ s)
- Self healing
- Safe open failure mode
- Low ESR
- Surface Mount (IR/Vapor reflow) solution

APPLICATIONS

This new version of our High Voltage SMD range has been developed to withstand high line surges common in telecom application.

These capacitors meet the telecom lightning strike protection standards.

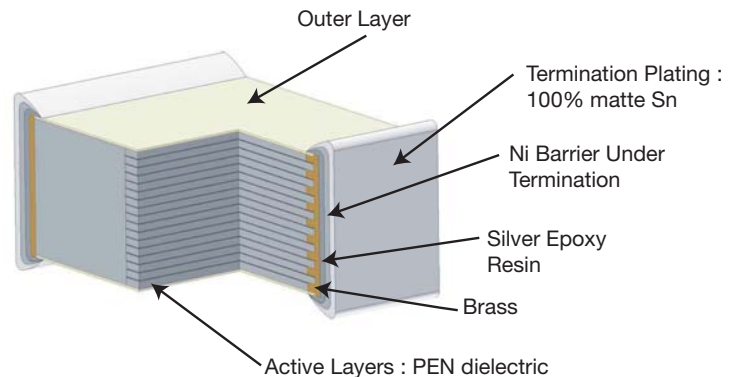

PERFORMANCE CHARACTERISTICS

Climatic Category	55/125/56
Capacitance Range	6.8nF to 33nF
Tolerance on C_R	$\pm 5\%$, $\pm 10\%$
Nominal Voltages	630Vdc
Test Voltage	1500V (10/700 μ sec.)
Soldering methods	IR or vapor phase reflow (not suitable for wave soldering)
Tangent of Loss Angle at 1kHz (DF)	$< 100 \times 10^{-4}$
Insulation resistance minimum: IR	for $C \leq 0.33\mu F$ IR $> 1000 M\Omega$ at 20°C for 1 min.charge at 100VDC
Temperature range	-55°C to 125°C with voltage derating of 1.25%/°C between 105°C and 125°C

Film Chip Capacitors



High Surge Voltage SMD Film Capacitors – CL Series

CAPACITANCE VALUES (CR) AND NOMINAL VOLTAGES (VR)

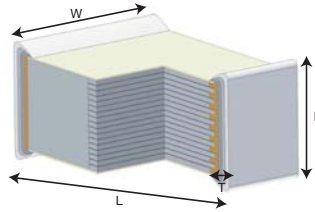

millimeters (inches)

Capacitance Range (CR)	Ordering Code	VOLTAGE Vdc: 630V												Reel Pkg Code	
		Chip Dimensions *Tolerances (page 6)				Tape Dimensions			Reel Dimensions			Packaging Unit		Reel Pkg Code	
		L	W	H max	T	W	P1	K0	A	W1	W2 max	Bulk	Reel		
0.0068μF	CL057K0682+ --	7.20 (0.283)	6.10 (0.240)	2.40 (0.094)	0.80 (0.032)	24.0 (0.944)	12.0 (0.472)	3.80 (0.149)	330 (12.99)	24.4 (0.961)	30.4 (1.196)	1000	2250	BC	
0.0082	CL057K0822+ --	7.20 (0.283)	6.10 (0.240)	2.30 (0.090)	0.80 (0.032)	24.0 (0.944)	12.0 (0.472)	3.80 (0.149)	330 (12.99)	24.4 (0.961)	30.4 (1.196)	1000	2250	BC	
0.010μF	CL057K0103+ --	7.20 (0.283)	6.10 (0.240)	2.80 (0.110)	0.80 (0.032)	24.0 (0.944)	12.0 (0.472)	3.80 (0.149)	330 (12.99)	24.4 (0.961)	30.4 (1.196)	1000	2250	BC	
0.012	CL057K0123+ --	7.20 (0.283)	6.10 (0.240)	2.40 (0.094)	0.80 (0.032)	24.0 (0.944)	12.0 (0.472)	3.80 (0.149)	330 (12.99)	24.4 (0.961)	30.4 (1.196)	1000	2250	BC	
0.015	CL057K0153+ --	7.20 (0.283)	6.10 (0.240)	2.90 (0.114)	0.80 (0.032)	24.0 (0.944)	12.0 (0.472)	3.80 (0.149)	330 (12.99)	24.4 (0.961)	30.4 (1.196)	1000	2250	BC	
0.018	CL057K0183+ --	7.20 (0.283)	6.10 (0.240)	3.40 (0.134)	0.80 (0.032)	16.0 (0.629)	12.0 (0.472)	3.80 (0.149)	330 (12.99)	16.4 (0.645)	22.4 (0.881)	1000	2250	BC	
0.022	CL957K0223+ --	7.20 (0.283)	10.0 (0.394)	3.00 (0.118)	0.80 (0.032)	16.0 (0.629)	12.0 (0.472)	4.80 (0.189)	330 (12.99)	16.4 (0.645)	22.4 (0.881)	1000	1300	BC	
0.027	CL957K0273+ --	7.20 (0.283)	10.0 (0.394)	3.70 (0.146)	0.80 (0.032)	16.0 (0.629)	12.0 (0.472)	4.80 (0.189)	330 (12.99)	16.4 (0.645)	22.4 (0.881)	1000	1300	BC	
0.033μF	CL957K0333+ --	7.20 (0.283)	10.0 (0.394)	4.00 (0.158)	0.80 (0.032)	16.0 (0.629)	12.0 (0.472)	5.23 (0.206)	330 (12.99)	16.4 (0.645)	22.4 (0.881)	1000	1100	BC	

For other Values: upon request

Replace the + by the tolerance code: J = 5% or K = 10%

Replace the -- by the packaging suffix: -- = bulk

BC = tape & reel

Film Chip Capacitors



High Surge Voltage SMD Film Capacitors – CL Series

MOUNTING AND SOLDERING RECOMMENDATIONS

SOLDERING PROFILE

The capacitors can be mounted using infrared and vapor phase soldering following recommended below. They are NOT suitable for wave soldering.

All temperature refer to topside of the package, measured on the package body surface.

Profile Feature	2824 to 2840
Ramp-Up (T_s max to T_p)	3°C / second max
Preheat	
- Temperature Min (T_s min)	150°C
- Temperature Min (T_s max)	200°C
- Time (t_s min to t_s max)	180 sec. max
Time maintained above	
- Temperature (T_L)	217°C
- Time (t_L)	75 sec. max
Peak temperature (T_p)	255°C
Time within 5°C of peak temperature (t_p)	10 sec.
Ramp-Down	6°C / sec.

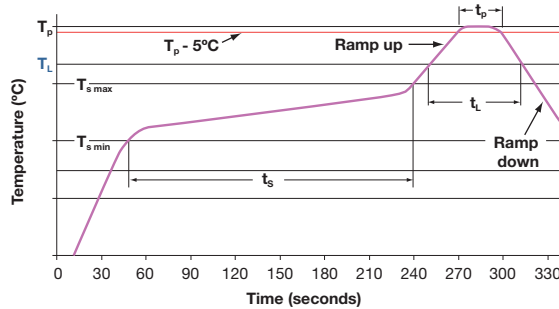

*Reflow soldering referring to JEDEC Standard with some limitations
*JEDEC J-Std 020C

RECOMMENDED SOLDER PASTE THICKNESS

For optimum solderability, the recommended soldering paste thickness: 1206 to 1812 :150 to 200µm

In case of hand soldering, the temperature of the soldering iron should not be above 250°C. Special care must be taken to avoid touching the capacitor body with the iron tip.

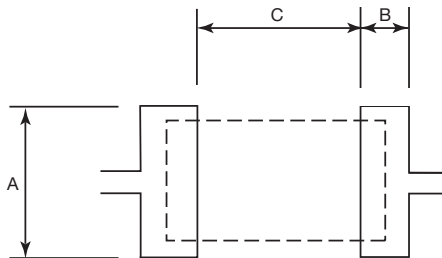

PAD DIMENSIONS: millimeters (inches)

Size Code	Case Size	A	B	C
05	2824	6.00 (0.234)	2.50 (0.098)	5.70 (0.224)
95	2840	11.2 (0.440)	2.50 (0.098)	5.70 (0.224)

RECOMMENDED CLEANING

To clean flux from the PC board assembly, the recommended products are: ethanol, isopropyl alcohol, and deionized water wash. The cleaning products to avoid are: Toluene, Xylene, Trichloroethylene, Terpene Cleaner EC-7, surface active agent. In case of using another solvent, please contact us.

OTHER CAUTIONS

Flame retardancy: the dielectric film is not a flame retardant material.

Environment: contact us when chips are used in humid or gas atmosphere and /or when using resin.

Recommended handling: do not use edged tools, so not to damage the capacitors.

TIN WHISKERS TESTS : JEDEC STANDARD NO 22A121

Stress Type	Ref. Spec.	Test Conditions	Analysis	Results
Temperature cycling	JESD22-A104	-55°C +85(+10/-0)°C air 5 to 10mn soak 3 cycles/hour	SEM x 1000	Pass
Ambient Temperature / Humidity Storage		30+/-2°C - 60+/-3% RH -2000H	SEM x 1000	Pass
High Temperature / Humidity Storage		70+/-5°C - 93+3/-2% RH -1000H	SEM x 1000	Pass



Film Chip Capacitors



High Surge Voltage SMD Film Capacitors – CL Series – RoHS

MATERIALS CONTROLLED BY ROHS (PPM BY WEIGHT):

Mass / unit (g)	Lead	Mercury	Cadmium	Hexavalent Chromium	PBB	PBDE
CB range	0	0	0	0	0	0
RoHS Limit (ppm)	1000	1000	100	1000	1000	1000
Pass/Fail	Pass	Pass	Pass	Pass	Pass	Pass

This product has been tested and found to be compliant with all requirements, provisions, and exemptions of EU Directive 2002/95/EC of the European Parliament and Council of January 27, 2003. On the Restriction of use of certain Hazardous Substances (RoHS) in electrical and electronic equipment and EU Directive 2000/53/EC regarding ELV or End of Life Vehicle.

ROHS / ELV STATUS

External Plating
100% Matte Sn as standard

LEAD-FREE STATUS / MOISTURE SENSITIVITY RANKING

Pb Free Reflow Solder compliant, MSL = 3.
Reflow soldering referring to Jedec Standard with some limitations. Additional JESD-97 data to be phased in MSL e3 termination.

PRODUCT LABELING:

(For informational purposes only to be phased in on reel and container.)

PRODUCT TRACEABILITY:

Full internal material traceability by reference to unique lot number marked on reel and external package.

Pb Free:



RoHS Compliant:



AMERICAS

AVX Greenville, SC
Tel: 864-967-2150

AVX Northwest, WA
Tel: 360-699-8746

AVX Midwest, IN
Tel: 317-861-9184

AVX Mid/Pacific, CA
Tel: 408-988-4900

AVX Northeast, MA
Tel: 617-479-0345

AVX Southwest, CA
Tel: 949-859-9509

AVX Canada
Tel: 905-238-3151

AVX South America
Tel: +55-11-4688-1960

EUROPE

AVX Limited, England
Tel: +44-1276-697000

AVX S.A.S., France
Tel: +33-1-69-18-46-00

AVX GmbH, Germany
Tel: +49-0811-95949-0

AVX SRL, Italy
Tel: +39-02-614-571

AVX Czech Republic
Tel: +420-57-57-57-521

AVX/ELCO UK
Tel: +44-1638-675000

ELCO Europe GmbH
Tel: +49-2741-299-0

AVX S.A., Spain
Tel: +34-91-63-97-197

AVX Benelux
Tel: +31-187-489-337

ASIA-PACIFIC

**AVX/Kyocera (S) Pte Ltd.,
Singapore**
Tel: +65-6286-7555

**AVX/Kyocera, Asia, Ltd.,
Hong Kong**
Tel: +852-2363-3303

**AVX/Kyocera Yuhan Hoesa,
South Korea**
Tel: +82-2785-6504

**AVX/Kyocera HK Ltd.,
Taiwan**
Tel: +886-2-2656-0258

**AVX/Kyocera (M) Sdn Bhd,
Malaysia**
Tel: +60-4228-1190

**AVX/Kyocera International
Trading Co. Ltd.,
Shanghai**
Tel: +86-21-3255 1933

**AVX/Kyocera Asia Ltd.,
Shenzen**
Tel: +86-755-3336-0615

**AVX/Kyocera International
Trading Co. Ltd.,
Beijing**
Tel: +86-10-6588-3528

**AVX/Kyocera India
Liaison Office**
Tel: +91-80-6450-0715

ASIA-KED (KYOCERA Electronic Devices)

KED Hong Kong Ltd.
Tel: +852-2305-1080/1223

**KED Hong Kong Ltd.
Shenzen**
Tel: +86-755-3398-9600

**KED Company Ltd.
Shanghai**
Tel: +86-21-3255-1833

**KED Hong Kong Ltd.
Beijing**
Tel: +86-10-5869-4655

KED Taiwan Ltd.
Tel: +886-2-2950-0268

**KED Korea Yuhan Hoesa,
South Korea**
Tel: +82-2-783-3604/6126

**KED (S) Pte Ltd.
Singapore**
Tel: +65-6509-0328

**Kyocera Corporation
Japan**
Tel: +81-75-604-3449

Contact:



<http://www.avx.com>

S-FCC0M1213-C