

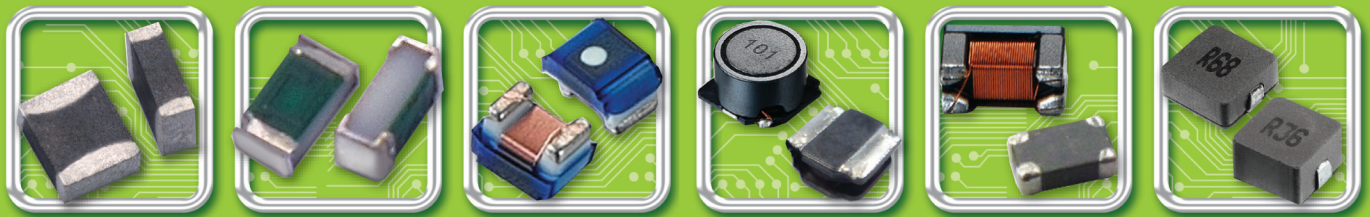

Total Solution Provider for EMI, Power and RF.

Inductors SMD Components



HEI Series



Power inductor takes an important part in the efficiency performance of DC/DC converter, and HEI products is designed to take care of both PFM and PWM application performance. Therefore, for HEI product, the Q(Rac) value at light load and the RDC value at heavy load are both superior to other competitors. Furthermore, the saturated current performance is also great, so it helps to get the ripple current lower and enhance the efficiency result.

Features

- High Efficiency
- Small Sizes in 2.0*1.2*0.8mm
- High Saturated Current
- High Q / Low Rac
- Low Rdc

Applications

- Smart phones
- Bluetooth Headsets
- Tablet PCs
- PND
- PC peripheral devices
- DSC, Camcorders

Product Identification

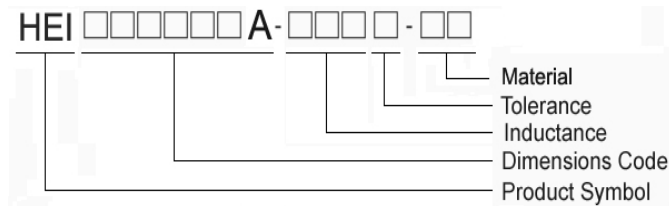

Shape and Dimensions

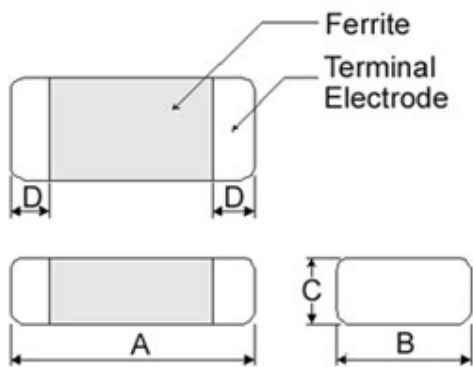

Dimensions in mm

TYPE	A	B	C	D
201208A	2.0±0.2	1.25±0.2	0.8Max	0.5±0.3
201210A	2.0±0.2	1.25±0.2	1.0Max	0.5±0.3
201610A	2.0±0.2	1.60±0.2	1.0Max	0.5±0.3
252010A	2.5±0.3	2.00±0.3	1.0Max	0.6±0.3
252012A	2.5±0.3	2.00±0.3	1.2Max	0.6±0.3
322510A	3.2±0.3	2.50±0.3	1.0Max	0.5±0.3
322512A	3.2±0.3	2.50±0.3	1.2Max	0.5±0.3

Recommended Pattern

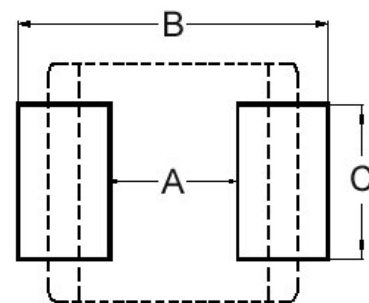

Dimensions in mm

TYPE	A	B	C
201208A	0.8~1.2	2.3~2.9	1.0~1.4
201210A	0.8~1.2	2.3~2.9	1.0~1.4
201610A	0.9	2.0	1.6
252010A	1.2	2.8	2.0
252012A	1.2	2.8	2.0
322510A	1.7	3.2	2.5
322512A	1.7	3.2	2.5

Electrical Characteristics

Part Number	Inductance	Tolerance	Test Frequency	I _{rms} (A)	I _{sat} (A)	RDC(mΩ)
	(μH)	(±%)	(MHz)	Max(Typ)	Max(Typ)	Max(Typ)
HEI201208A-R24M-Q8	0.24	20	2	4.2(4.8)	4.8(5.4)	25(19)
HEI201208A-R47M-Q8	0.47	20	2	3.0(3.4)	3.2(3.6)	48(40)

- I_{rms} DC current (A) that will cause an approximate ΔT of 40°C.
- I_{sat} DC current (A) that will cause L to drop approximately 30%
- Tolerance : M = ±20%
- L : Agilent E4991/HP4287A+16197A, 2MHz 0.2V
- R_{dc} : CHEN HWA502
- I_{sat} : Agilent E4980A+HP42841A
- I_{rms} : Agilent 6641 SYSTEM DC POWER SUPPLY
- Operating temperature range from -40°C to 125°C. (Including self - temperature rise)

Test Instruments : E4991A Impedance / Material Analyzer

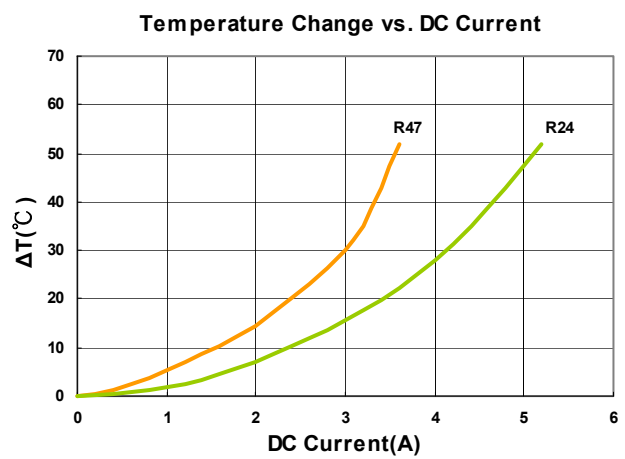
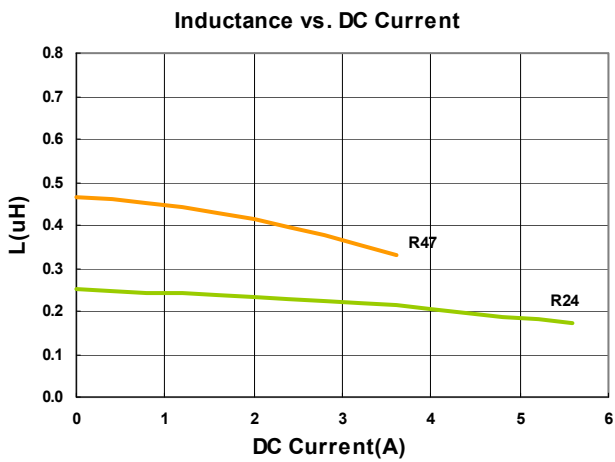

Electrical Characteristics

Part Number	Inductance	Tolerance	Test Frequency	Irms(A)	Isat(A)	RDC(mΩ)
	(uH)	(±%)	(MHz)	Max(Typ)	Max(Typ)	Max(Typ)
HEI201210A-R24M-Q8	0.24	20	2	3.7(4.6)	4.5(5.7)	28(22)
HEI201210A-R47M-Q8	0.47	20	2	3.0(3.7)	3.3(4.2)	42(33)
HEI201210A-1R0M-Q8	1.0	20	2	2.2(2.7)	2.3(2.8)	78(69)
HEI201210A-1R5M-Q8	1.5	20	2	1.8(2.2)	1.9(2.3)	112(94)
HEI201210A-2R2M-Q8	2.2	20	2	1.5(1.8)	1.6(2.0)	168(153)

- **Irms** DC current (A) that will cause an approximate ΔT of 40°C.
- **Isat** DC current (A) that will cause L to drop approximately 30%
- Tolerance : M = ±20%
- L : Agilent E4991/HP4287A+16197A, 2MHz 0.2V
- Rdc : CHEN HWA502
- Isat : Agilent E4980A+HP42841A
- Irms : Agilent 6641 SYSTEM DC POWER SUPPLY
- Operating temperature range from -40°C to 125°C. (Including self - temperature rise)

Test Instruments : E4991A Impedance / Material Analyzer

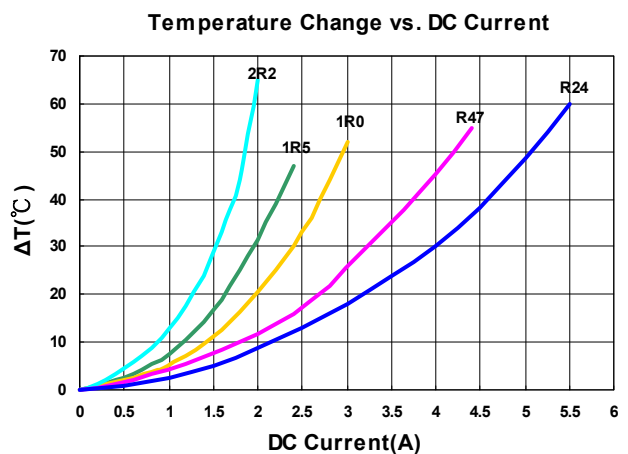
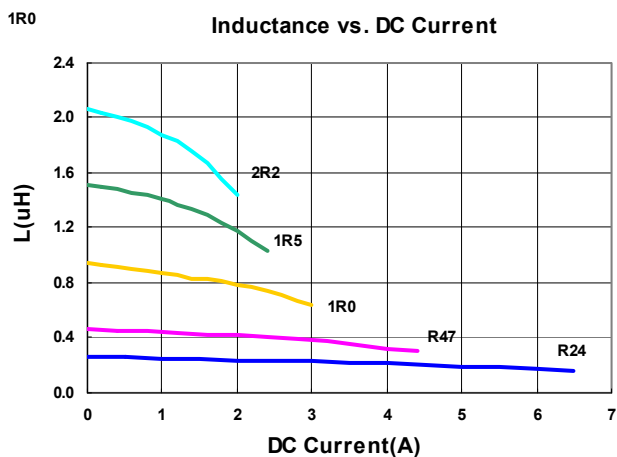

Electrical Characteristics

Part Number	Inductance	Tolerance	Test Frequency	I _{rms} (A)	I _{sat} (A)	RDC(mΩ)
	(μH)	(±%)	(MHz)	Max(Typ)	Max(Typ)	Max(Typ)
HEI201610A-R24M-Q8	0.24	20	2	3.9(4.8)	5.6(7.0)	27(21)
HEI201610A-R47M-Q8	0.47	20	2	3.5(4.2)	3.9(4.8)	42(33)
HEI201610A-R68M-Q8	0.68	20	2	2.7(3.4)	3.2(4.0)	56(43)
HEI201610A-1R0M-Q8	1.0	20	2	2.5(3.1)	2.9(3.6)	65(53)
HEI201610A-1R5M-Q8	1.5	20	2	2.3(2.7)	2.5(2.8)	85(75)
HEI201610A-2R2M-Q8	2.2	20	2	1.8(2.2)	2.4(2.7)	135(112)

- I_{rms} DC current (A) that will cause an approximate ΔT of 40°C.
- I_{sat} DC current (A) that will cause L to drop approximately 30%
- Tolerance : M = ±20%
- L : Agilent E4991/HP4287A+16197A, 2MHz 0.2V
- R_{dc} : CHEN HWA502
- I_{sat} : Agilent E4980A+HP42841A
- I_{rms} : Agilent 6641 SYSTEM DC POWER SUPPLY
- Operating temperature range from -40°C to 125°C. (Including self - temperature rise)

Test Instruments : E4991A Impedance / Material Analyzer

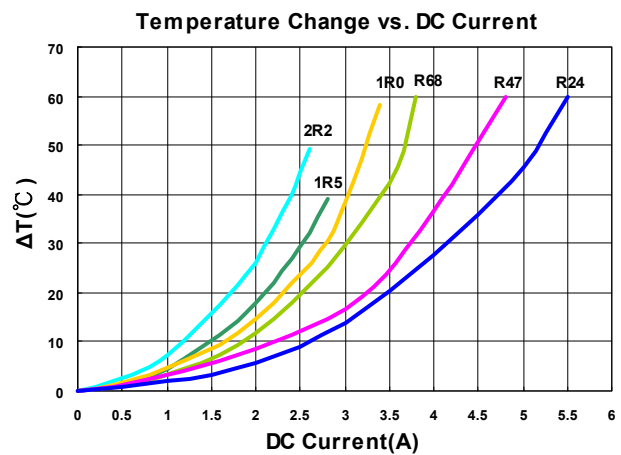
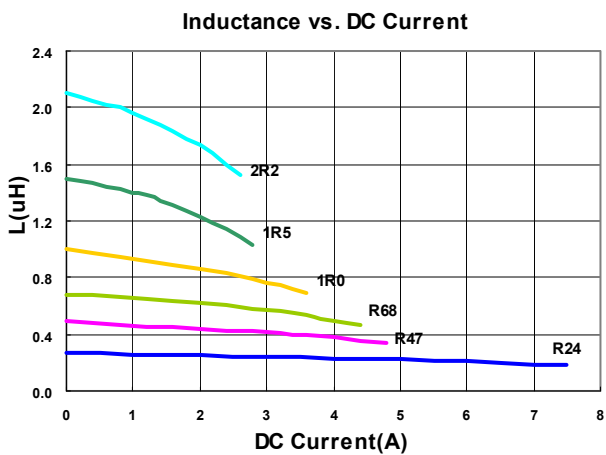

Electrical Characteristics

Part Number	Inductance	Tolerance	Test Frequency	Irms(A)	Isat(A)	RDC(mΩ)
	(uH)	(±%)	(MHz)	Max(Typ)	Max(Typ)	Max(Typ)
HEI252010A-R24M-Q8	0.24	20	2	5.5(6.5)	8.0(9.5)	18(13)
HEI252010A-R33M-Q8	0.33	20	2	4.8(5.5)	6.5(8.0)	24(18)
HEI252010A-R47M-Q8	0.47	20	2	3.9(4.5)	5.0(6.2)	35(27)
HEI252010A-R68M-Q8	0.68	20	2	3.7(4.2)	4.5(5.6)	40(32)
HEI252010A-1R0M-Q8	1.0	20	2	3.0(3.5)	3.7(4.6)	53(45)
HEI252010A-1R5M-Q8	1.5	20	2	2.4(2.8)	3.1(3.8)	75(68)
HEI252010A-2R2M-Q8	2.2	20	2	2.2(2.5)	2.5(3.0)	97(87)

- Irms DC current (A) that will cause an approximate ΔT of 40°C.
- Isat DC current (A) that will cause L to drop approximately 30%
- Tolerance : M = ±20%
- L : Agilent E4991/HP4287A+16197A, 2MHz 0.2V
- Rdc : CHEN HWA502
- Isat : Agilent E4980A+HP42841A
- Irms : Agilent 6641 SYSTEM DC POWER SUPPLY
- Operating temperature range from -40°C to 125°C. (Including self - temperature rise)

Test Instruments : E4991A Impedance / Material Analyzer

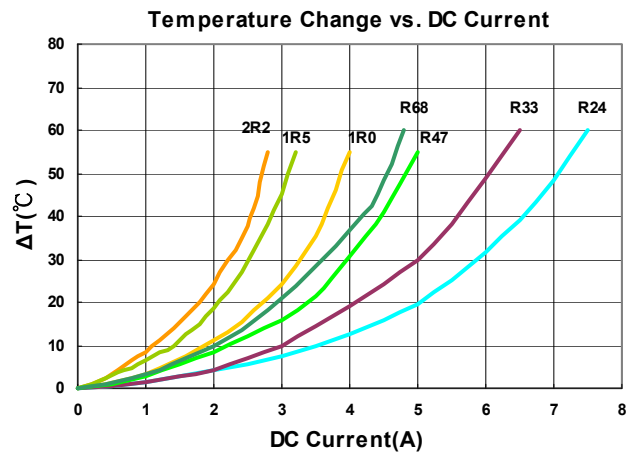
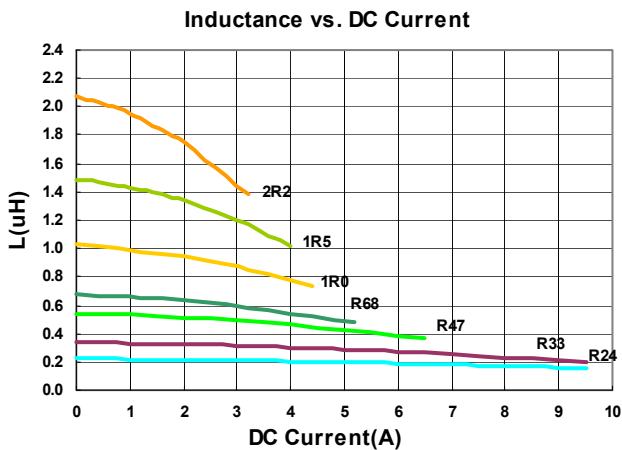

Electrical Characteristics

Part Number	Inductance	Tolerance	Test Frequency	Irms(A)	Isat(A)	RDC(mΩ)
	(uH)	(±%)	(MHz)	Max(Typ)	Max(Typ)	Max(Typ)
HEI252012A-R24M-Q8	0.24	20	2	6.2(7.3)	9.5(12)	15(11.5)
HEI252012A-R33M-Q8	0.33	20	2	5.8(6.4)	8.5(10)	18(14.5)
HEI252012A-R47M-Q8	0.47	20	2	3.8(4.5)	5.6(7.0)	33(28)
HEI252012A-R68M-Q8	0.68	20	2	3.8(4.4)	5.0(6.2)	36(30)
HEI252012A-1R0M-Q8	1.0	20	2	3.6(4.1)	4.4(5.5)	42(35)
HEI252012A-1R5M-Q8	1.5	20	2	2.7(3.1)	3.4(4.2)	65(57)
HEI252012A-2R2M-Q8	2.2	20	2	2.5(2.9)	3.0(3.7)	83(74)

- Irms DC current (A) that will cause an approximate ΔT of 40°C.
- Isat DC current (A) that will cause L to drop approximately 30%
- Tolerance : M = ±20%
- L : Agilent E4991/HP4287A+16197A, 2MHz 0.2V
- Rdc : CHEN HWA502
- Isat : Agilent E4980A+HP42841A
- Irms : Agilent 6641 SYSTEM DC POWER SUPPLY
- Operating temperature range from -40°C to 125°C. (Including self - temperature rise)

Test Instruments : E4991A Impedance / Material Analyzer

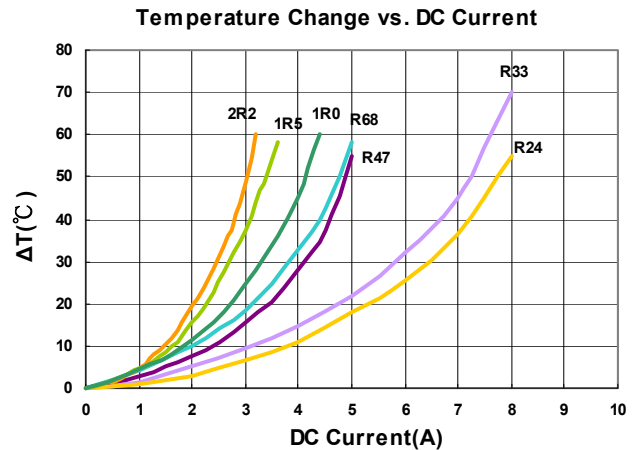
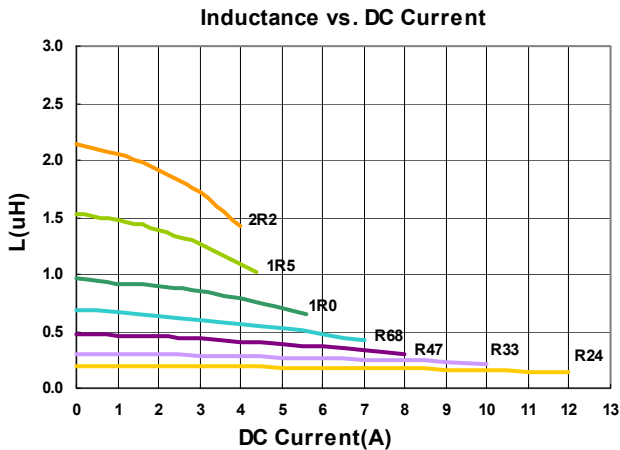

Electrical Characteristics

Part Number	Inductance	Tolerance	Test Frequency	Irms(A)	Isat(A)	RDC(mΩ)
	(uH)	(±%)	(MHz)	Max(Typ)	Max(Typ)	Max(Typ)
HEI322510A-R24M-Q8	0.24	20	2	6.0(6.8)	9.0(11.5)	16(12)
HEI322510A-R33M-Q8	0.33	20	2	5.8(6.5)	8.0(9.5)	17(12.5)
HEI322510A-R47M-Q8	0.47	20	2	4.5(5.4)	6.0(7.3)	24(19)
HEI322510A-1R0M-Q8	1.0	20	2	3.3(3.7)	4.1(4.7)	46(39)
HEI322510A-1R5M-Q8	1.5	20	2	3.2(3.5)	3.5(4.0)	58(50)
HEI322510A-2R2M-Q8	2.2	20	2	2.5(2.8)	3.0(3.5)	85(73)

- **Irms** DC current (A) that will cause an approximate ΔT of 40°C.
- **Isat** DC current (A) that will cause L to drop approximately 30%
- Tolerance : M = ±20%
- L : Agilent E4991/HP4287A+16197A, 2MHz 0.2V
- Rdc : CHEN HWA502
- Isat : Agilent E4980A+HP42841A
- Irms : Agilent 6641 SYSTEM DC POWER SUPPLY
- Operating temperature range from -40°C to 125°C. (Including self - temperature rise)

Test Instruments : E4991A Impedance / Material Analyzer

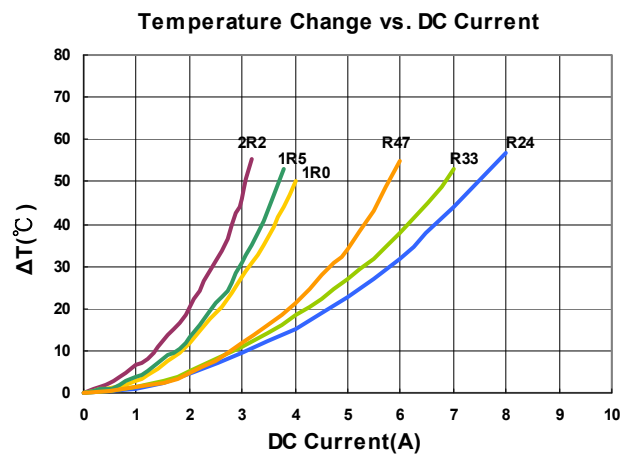
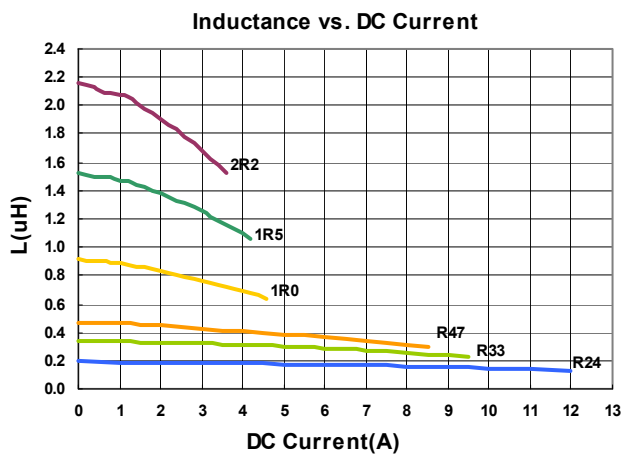

Electrical Characteristics

Part Number	Inductance	Tolerance	Test Frequency	Irms(A)	Isat(A)	RDC(mΩ)
	(uH)	(±%)	(MHz)	Max(Typ)	Max(Typ)	Max(Typ)
HEI322512A-R47M-Q8	0.47	20	2	4.6(5.2)	7.0(8.2)	25(19)
HEI322512A-1R0M-Q8	1.0	20	2	3.7(4.2)	5.7(6.5)	34(27.5)
HEI322512A-1R5M-Q8	1.5	20	2	2.8(3.2)	4.0(4.6)	59(51)
HEI322512A-2R2M-Q8	2.2	20	2	2.7(3.0)	3.5(4.0)	73(64)

- **Irms** DC current (A) that will cause an approximate ΔT of 40°C.
- **Isat** DC current (A) that will cause L to drop approximately 30%
- Tolerance : M = ±20%
- L : Agilent E4991/HP4287A+16197A, 2MHz 0.2V
- Rdc : CHEN HWA502
- Isat : Agilent E4980A+HP42841A
- Irms : Agilent 6641 SYSTEM DC POWER SUPPLY
- Operating temperature range from -40°C to 125°C. (Including self - temperature rise)

Test Instruments : E4991A Impedance / Material Analyzer

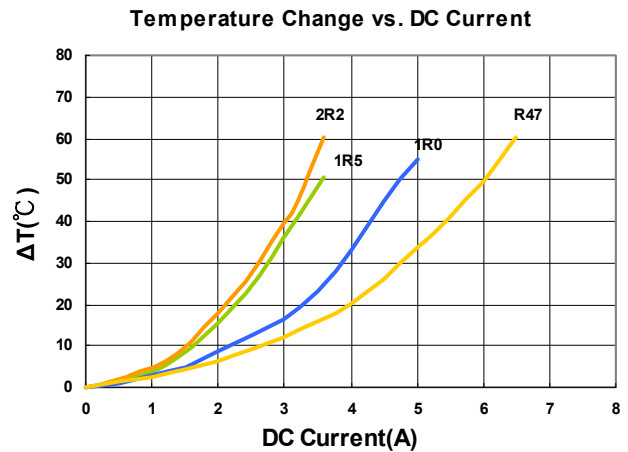
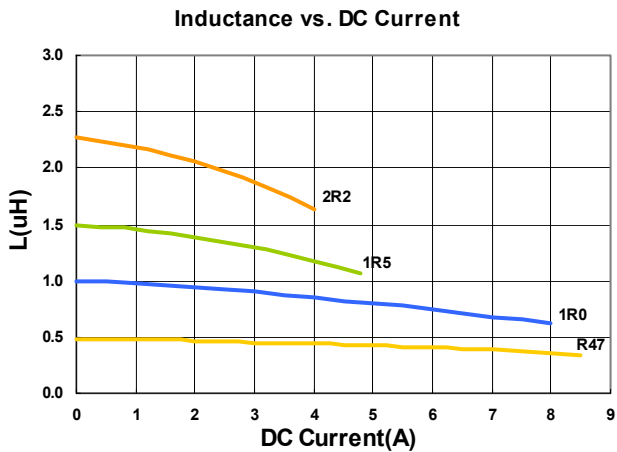

Packaging Specifications

Tape Dimensions

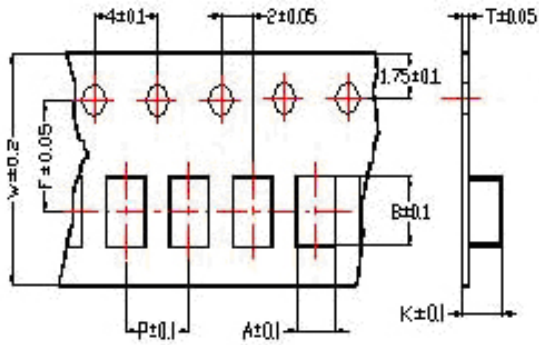

Tape Material

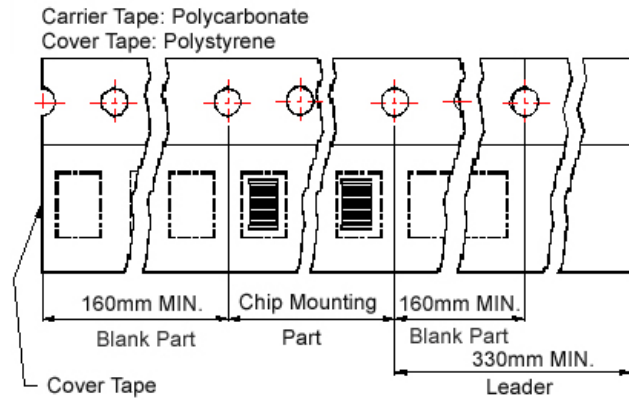

Reel Dimensions

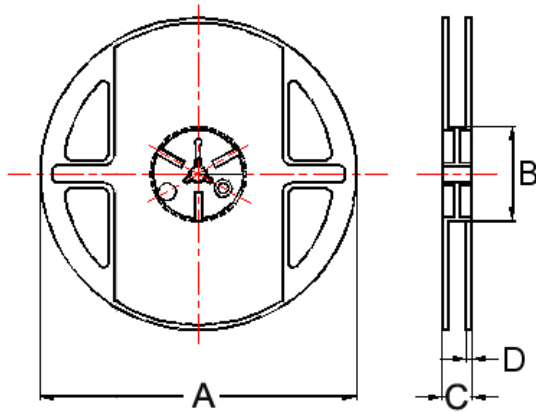

Dimensions in mm

TYPE	Tape Dimensions							Reel Dimensions				Quantity PCS / REEL
	A	B	T	W	P	F	K	A	B	C	D	
201208A	1.45	2.25	0.22	8	4	3.5	1.04	178	60	12	1.5	3000
201210A	1.50	2.25	0.22	8	4	3.5	1.15	178	60	12	1.5	3000
201610A	1.80	2.20	0.22	8	4	3.5	1.15	178	60	12	1.5	3000
252010A	2.25	2.80	0.22	8	4	3.5	1.35	178	60	12	1.5	3000
252012A	2.25	2.80	0.22	8	4	3.5	1.35	178	60	12	1.5	3000
322510A	2.80	3.55	0.23	8	4	3.5	1.20	178	60	12	1.5	3000
322512A	2.80	3.50	0.23	8	4	3.5	1.34	178	60	12	1.5	3000

MHCD Series

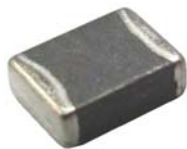

Chilisin's MHCD Series provides high current and low DCR in compact sizing with magnetically shielded construction. This power inductor is an excellent power solution for space-limited devices.

Features

- Monolithic, magnetically shielded
- Compact high saturation current
- Minimum height=1.0mm Max

Applications

- Smartphone
- Tablet PC
- Hard disk of ultrabook
- LTE module
- Portable device

Product Identification

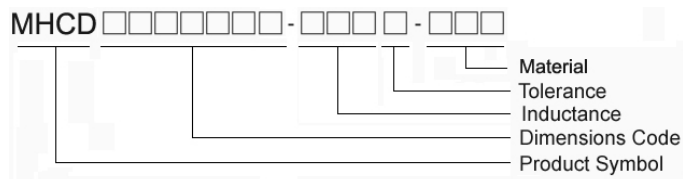

Shape and Dimensions

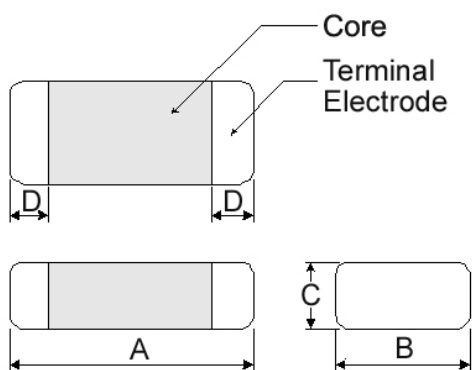

Dimensions in mm

TYPE	A	B	C	D
201210	2.0±0.2	1.25±0.2	1.0Max	0.5±0.3
201610	2.0±0.2	1.6±0.2	1.0Max	0.5±0.3
201612	2.0±0.2	1.6±0.2	1.2Max	0.5±0.3
252010	2.5±0.2	2.0±0.2	1.0Max	0.6±0.3
252012	2.5±0.2	2.0±0.2	1.2Max	0.6±0.3
322510	3.2±0.3	2.5±0.3	1.0Max	0.5±0.3
322512	3.2±0.3	2.5±0.3	1.2Max	0.5±0.3

Recommended Pattern

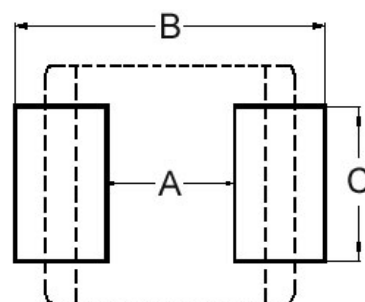

Dimensions in mm

TYPE	A	B	C
201210	0.8~1.2	2.3~2.9	1.0~1.4
201610	0.9	2.0	1.6
201612	0.9	2.0	1.6
252010	1.2	2.8	2.0
252012	1.2	2.8	2.0
322510	1.7	3.2	2.5
322512	1.7	3.2	2.5

Electrical Characteristics

Part Number	Inductance (μH)	Tolerance ($\pm\%$)	Test Frequency (MHz)	Irms(A)	Isat(A)	RDC($\text{m}\Omega$)
				Max(Typ)	Max(Typ)	Max(Typ)
MHCD201210A-R33M-A8S	0.33	20	2	2.4(3.0)	3.6(4.2)	75(58)
MHCD201210A-R47M-A8S	0.47	20	2	2.2(2.8)	3.2(4.0)	80(61)
MHCD201210A-R68M-A8S	0.68	20	2	2.0(2.5)	3.0(3.6)	105(82)
MHCD201210A-1R0M-A8S	1.0	20	2	1.6(2.0)	2.0(2.6)	155(137)

- **Irms** DC current (A) that will cause an approximate ΔT of 40°C .
- **Isat** DC current (A) that will cause L to drop approximately 30%
- Tolerance : M = $\pm 20\%$
- L : Agilent E4991A/HP4287A+16197A, 2MHz 0.2V
- Rdc : CHEN HWA502
- Isat : Agilent E4980A+HP42841A
- Irms : Agilent 6641 SYSTEM DC POWER SUPPLY
- Operating temperature range from -40°C to 125°C . (Including self - temperature rise)

Test Instruments : E4991A Impedance / Material Analyzer

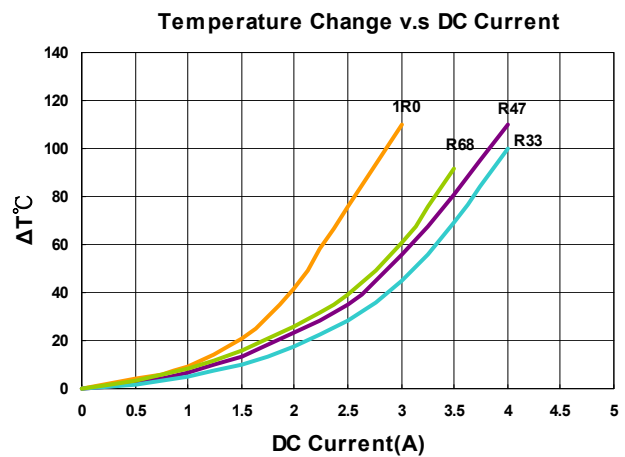
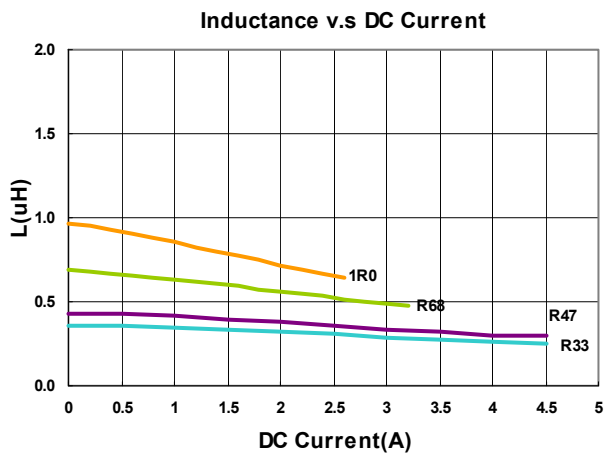

Electrical Characteristics

Part Number	Inductance (μH)	Tolerance ($\pm\%$)	Test Frequency (MHz)	I _{rms} (A)		I _{sat} (A)		RDC($\text{m}\Omega$)	
				Max(Typ)	Max(Typ)	Max(Typ)	Max(Typ)	Max(Typ)	Max(Typ)
MHCD201610A-R24M-A8S	0.24	20	2	4.0(4.5)	4.2(6.0)	40(28)			
MHCD201610A-R33M-A8S	0.33	20	2	3.5(3.8)	4.0(5.5)	48(40)			
MHCD201610A-R47M-A8S	0.47	20	2	3.0(3.6)	3.2(5.0)	54(44)			
MHCD201610A-R56M-A8S	0.56	20	2	2.8(3.3)	2.8(4.6)	59(46)			
MHCD201610A-R68M-A8S	0.68	20	2	2.4(3.0)	2.7(4.2)	72(55)			
MHCD201610A-1R0M-A8S	1.0	20	2	2.0(2.3)	2.2(3.4)	96(81)			
MHCD201610A-1R5M-A8S	1.5	20	2	1.6(2.0)	2.1(2.8)	150(122)			
MHCD201610A-2R2M-A8S	2.2	20	2	1.3(1.6)	2.0(2.4)	204(170)			

- I_{rms} DC current (A) that will cause an approximate ΔT of 40°C.
- I_{sat} DC current (A) that will cause L to drop approximately 30%
- Tolerance : M = $\pm 20\%$
- L : Agilent E4991/HP4287A+16197A, 2MHz 0.2V
- Rdc : CHEN HWA502
- I_{sat} : Agilent E4980A+HP42841A
- I_{rms} : Agilent 6641 SYSTEM DC POWER SUPPLY
- Operating temperature range from -40°C to 125°C. (Including self - temperature rise)

Test Instruments : E4991A Impedance / Material Analyzer

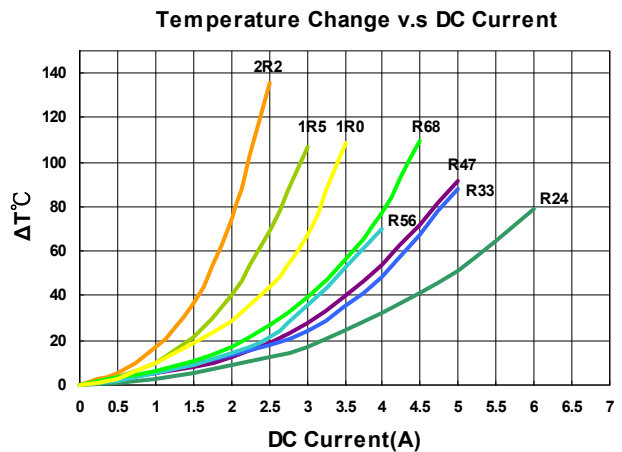
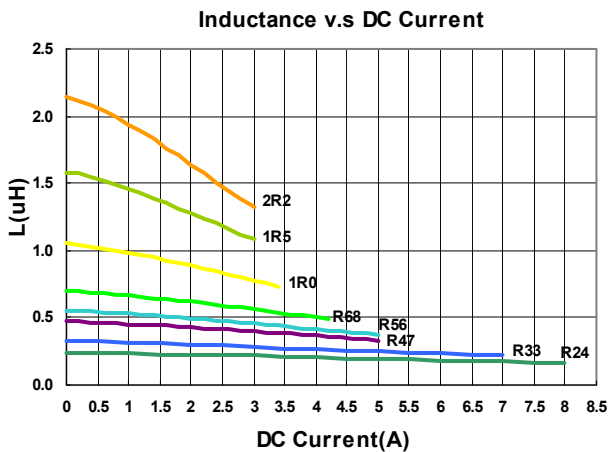

Electrical Characteristics

Part Number	Inductance (μH)	Tolerance ($\pm\%$)	Test Frequency (MHz)	Irms(A)	Isat(A)	RDC($\text{m}\Omega$)
				Max(Typ)	Max(Typ)	Max(Typ)
MHCD201610B-R24M-A8L	0.24	20	2	3.8(4.4)	5.0(6.0)	30(23)
MHCD201610B-R47M-A8L	0.47	20	2	2.9(3.3)	4.0(4.5)	41(34)
MHCD201610B-R68M-A8L	0.68	20	2	2.5(2.9)	3.3(3.6)	53(44)
MHCD201610B-1R0M-A8L	1.0	20	2	2.2(2.5)	2.8(3.2)	72(60)
MHCD201610B-2R2M-A8L	2.2	20	2	1.5(1.7)	1.8(2.1)	170(142)

- **Irms** DC current (A) that will cause an approximate ΔT of 40°C .
- **Isat** DC current (A) that will cause L to drop approximately 30%
- Tolerance : M = $\pm 20\%$
- L : Agilent E4991/HP4287A+16197A, 2MHz 0.2V
- Rdc : CHEN HWA502
- Isat : Agilent E4980A+HP42841A
- Irms : Agilent 6641 SYSTEM DC POWER SUPPLY
- Operating temperature range from -40°C to 125°C . (Including self - temperature rise)

Test Instruments : E4991A Impedance / Material Analyzer

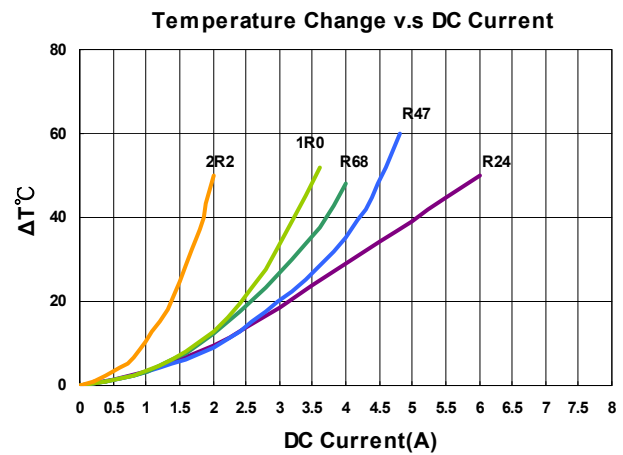
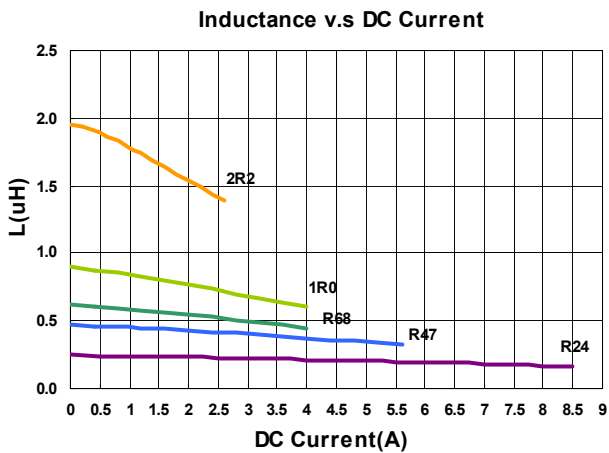

Electrical Characteristics

Part Number	Inductance (μH)	Tolerance ($\pm\%$)	Test Frequency (MHz)	Irms(A)	Isat(A)	RDC($\text{m}\Omega$)
				Max(Typ)	Max(Typ)	Max(Typ)
MHCD201612A-R24M-A8S	0.24	20	2	4.2(4.8)	5.5(6.5)	35(25)
MHCD201612A-R47M-A8S	0.47	20	2	3.2(3.8)	3.8(5.1)	52(40)
MHCD201612A-R68M-A8S	0.68	20	2	2.6(3.2)	3.3(4.8)	70(53)
MHCD201612A-1R0M-A8S	1.0	20	2	2.3(2.7)	3.1(3.9)	82(67)
MHCD201612A-1R5M-A8S	1.5	20	2	2.2(2.6)	2.6(3.2)	120(95)
MHCD201612A-2R2M-A8S	2.2	20	2	1.3(1.7)	2.0(2.6)	195(165)

- **Irms** DC current (A) that will cause an approximate ΔT of 40°C .
- **Isat** DC current (A) that will cause L to drop approximately 30%
- Tolerance : M = $\pm 20\%$
- L : Agilent E4991A/HP4287A+16197A, 2MHz 0.2V
- Rdc : CHEN HWA502
- Isat : Agilent E4980A+HP42841A
- Irms : Agilent 6641 SYSTEM DC POWER SUPPLY
- Operating temperature range from -40°C to 125°C . (Including self - temperature rise)

Test Instruments : E4991A Impedance / Material Analyzer

Inductance v.s DC Current

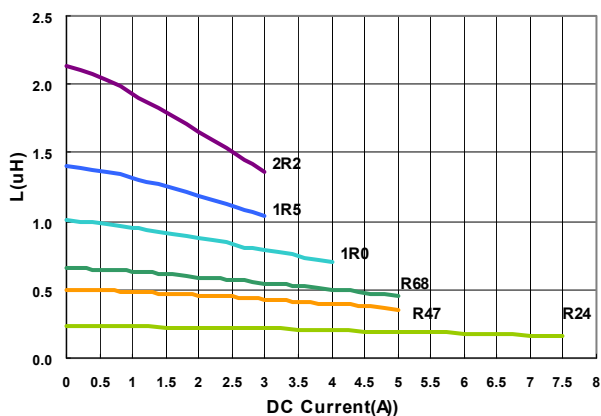

Temperature Change v.s DC Current

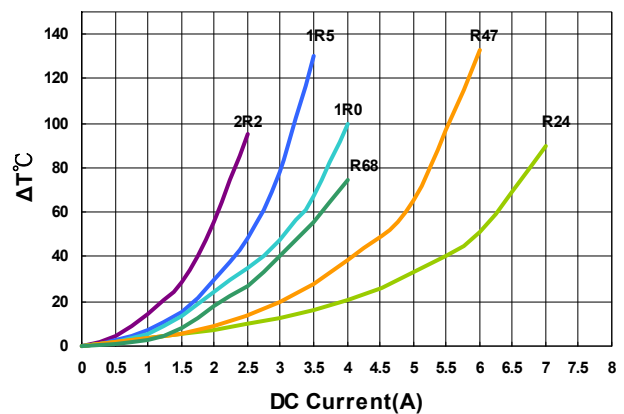

Electrical Characteristics

Part Number	Inductance (μH)	Tolerance ($\pm\%$)	Test Frequency (MHz)	Irms(A)	Isat(A)	RDC($\text{m}\Omega$)
				Max(Typ)	Max(Typ)	Max(Typ)
MHCD252010A-R24M-A8S	0.24	20	2	4.5(5.0)	7.5(9.5)	40(24)
MHCD252010A-R47M-A8S	0.47	20	2	3.1(3.6)	5.2(6.5)	46(36)
MHCD252010A-R68M-A8S	0.68	20	2	2.9(3.3)	3.8(5.0)	65(49)
MHCD252010A-1R0M-A8S	1.0	20	2	2.5(3.0)	3.4(4.3)	78(60)
MHCD252010A-1R5M-A8S	1.5	20	2	2.2(2.9)	3.2(4.0)	105(82)
MHCD252010A-2R2M-A8S	2.2	20	2	1.4(1.8)	2.6(3.2)	156(130)

- **Irms** DC current (A) that will cause an approximate ΔT of 40°C .
- **Isat** DC current (A) that will cause L to drop approximately 30%
- Tolerance : M = $\pm 20\%$
- L : Agilent E4991A/HP4287A+16197A, 2MHz 0.2V
- Rdc : CHEN HWA502
- Isat : Agilent E4980A+HP42841A
- Irms : Agilent 6641 SYSTEM DC POWER SUPPLY
- Operating temperature range from -40°C to 125°C . (Including self - temperature rise)

Test Instruments : E4991A Impedance / Material Analyzer

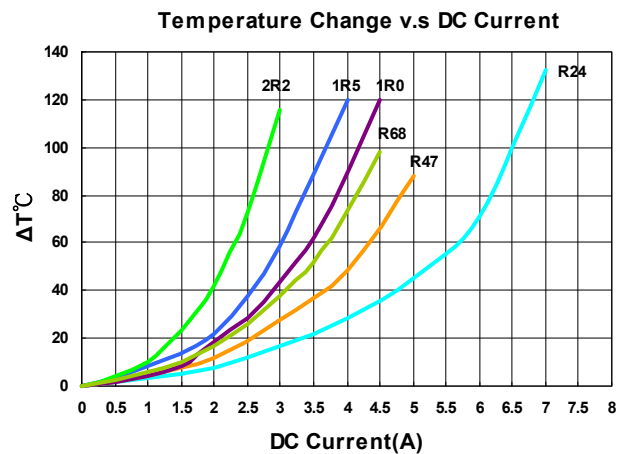
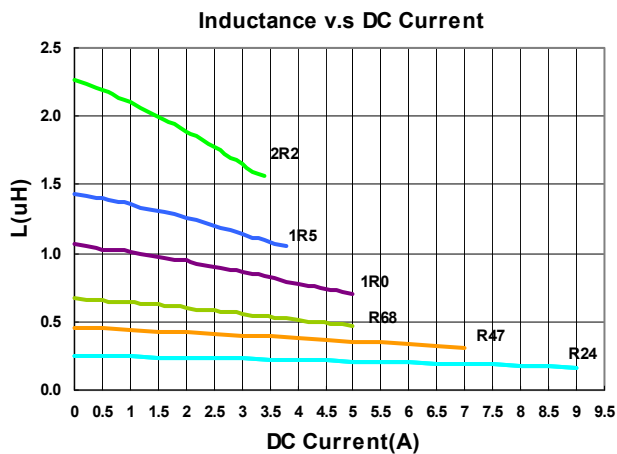

Electrical Characteristics

Part Number	Inductance (μH)	Tolerance ($\pm\%$)	Test Frequency (MHz)	Irms(A)	Isat(A)	RDC($\text{m}\Omega$)
				Max(Typ)	Max(Typ)	Max(Typ)
MHCD252010B-R33M-A8L	0.33	20	2	3.8(4.4)	5.0(6.0)	31(25)
MHCD252010B-R47M-A8L	0.47	20	2	3.4(3.9)	4.2(4.7)	35(29)
MHCD252010B-1R0M-A8L	1.0	20	2	2.6(3.0)	3.2(3.6)	65(54)
MHCD252010B-1R5M-A8L	1.5	20	2	2.1(2.4)	2.9(3.3)	94(78)
MHCD252010B-2R2M-A8L	2.2	20	2	1.8(2.1)	2.3(2.7)	120(100)
MHCD252010B-4R7M-A8L	4.7	20	2	1.1(1.3)	1.8(2.1)	250(208)

- **Irms** DC current (A) that will cause an approximate ΔT of 40°C .
- **Isat** DC current (A) that will cause L to drop approximately 30%
- Tolerance : M = $\pm 20\%$
- L : Agilent E4991A/HP4287A+16197A, 2MHz 0.2V
- Rdc : CHEN HWA502
- Isat : Agilent E4980A+HP42841A
- Irms : Agilent 6641 SYSTEM DC POWER SUPPLY
- Operating temperature range from -40°C to 125°C . (Including self - temperature rise)

Test Instruments : E4991A Impedance / Material Analyzer

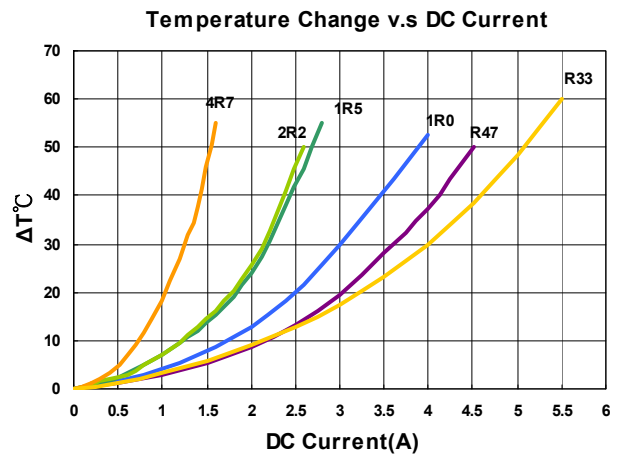
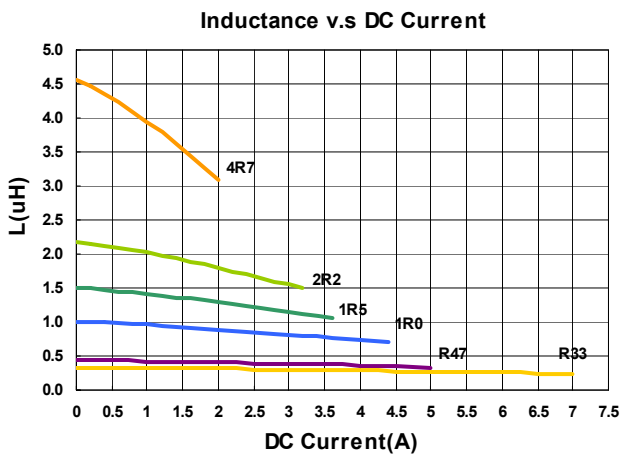

Electrical Characteristics

Part Number	Inductance (μH)	Tolerance ($\pm\%$)	Test Frequency (MHz)	Irms(A)	Isat(A)	RDC($\text{m}\Omega$)
				Max(Typ)	Max(Typ)	Max(Typ)
MHCD252012A-R33M-A8S	0.33	20	2	4.0(4.6)	6.8(8.5)	35(27)
MHCD252012A-R47M-A8S	0.47	20	2	3.7(4.4)	6.2(7.8)	39(29)
MHCD252012A-R68M-A8S	0.68	20	2	3.3(3.7)	5.5(6.5)	46(40)
MHCD252012A-1R0M-A8S	1.0	20	2	3.0(3.5)	4.0(5.0)	59(45)
MHCD252012A-1R5M-A8S	1.5	20	2	2.5(2.7)	3.4(4.0)	70(62)
MHCD252012A-2R2M-A8S	2.2	20	2	2.0(2.3)	3.3(3.8)	115(102)
MHCD252012A-3R3M-A8S	3.3	20	2	1.8(2.1)	2.5(2.8)	158(143)
MHCD252012A-4R7M-A8S	4.7	20	2	1.7(2.1)	2.1(2.7)	240(200)

- **Irms** DC current (A) that will cause an approximate ΔT of 40°C .
- **Isat** DC current (A) that will cause L to drop approximately 30%
- Tolerance : M = $\pm 20\%$
- L : Agilent E4991A/HP4287A+16197A, 2MHz 0.2V
- Rdc : CHEN HWA502
- Isat : Agilent E4980A+HP42841A
- Irms : Agilent 6641 SYSTEM DC POWER SUPPLY
- Operating temperature range from -40°C to 125°C . (Including self - temperature rise)

Test Instruments : E4991A Impedance / Material Analyzer

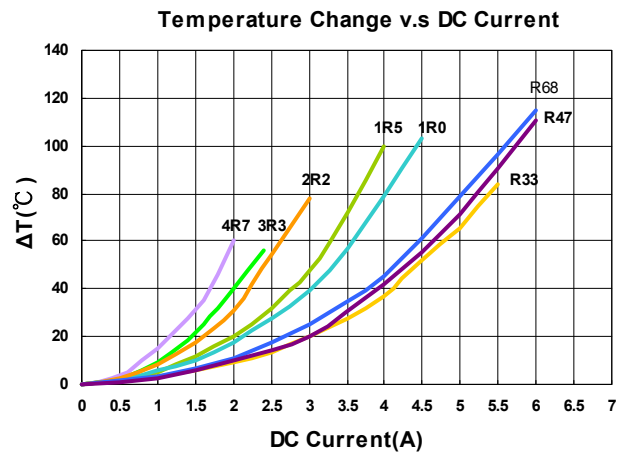
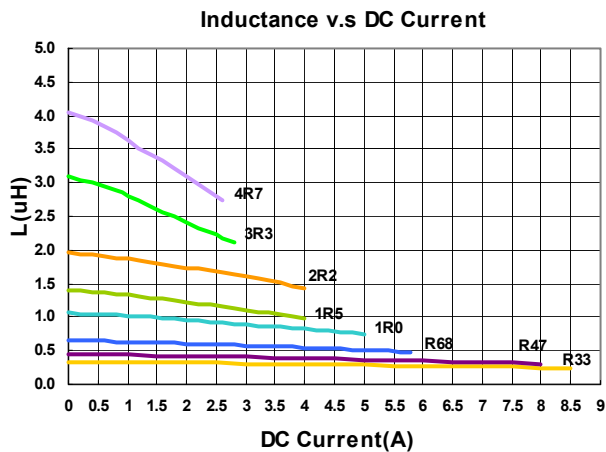

Electrical Characteristics

Part Number	Inductance	Tolerance	Test Frequency	I _{rms} (A)	I _{sat} (A)	RDC(mΩ)
	(uH)	(±%)	(MHz)	Max(Typ)	Max(Typ)	Max(Typ)
MHCD322510A-R47M-A8S	0.47	20	2	3.6(4.2)	5.8(6.6)	37(30)
MHCD322510A-1R0M-A8S	1.0	20	2	3.0(3.3)	4.0(4.6)	56(49)
MHCD322510A-1R5M-A8S	1.5	20	2	2.6(3.0)	3.4(4.0)	75(66)
MHCD322510A-2R2M-A8S	2.2	20	2	2.2(2.5)	2.7(3.2)	108(95)

- I_{rms} DC current (A) that will cause an approximate ΔT of 40°C.
- I_{sat} DC current (A) that will cause L to drop approximately 30%
- Tolerance : M = ±20%
- L : Agilent E4991A/HP4287A+16197A, 2MHz 0.2V
- R_{dc} : CHEN HWA502
- I_{sat} : Agilent E4980A+HP42841A
- I_{rms} : Agilent 6641 SYSTEM DC POWER SUPPLY
- Operating temperature range from -40°C to 125°C. (Including self - temperature rise)

Test Instruments : E4991A Impedance / Material Analyzer

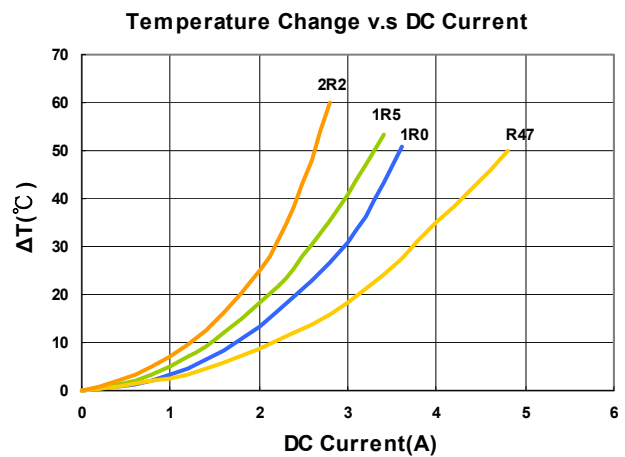
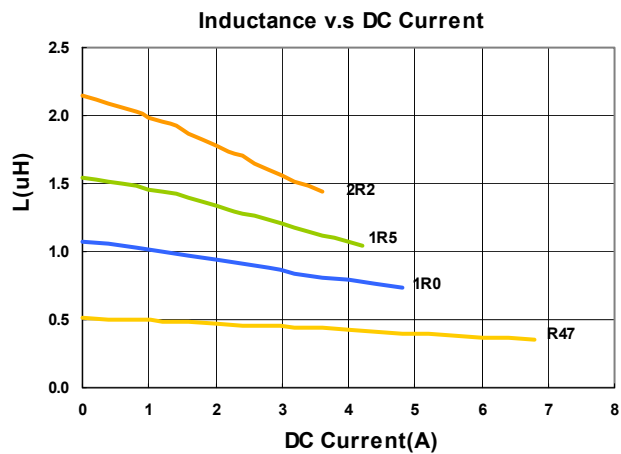

Electrical Characteristics

Part Number	Inductance	Tolerance	Test Frequency	Irms(A)	Isat(A)	RDC(mΩ)
	(uH)	(±%)	(MHz)	Max(Typ)	Max(Typ)	Max(Typ)
MHCD322512A-R47M-A8S	0.47	20	2	5.0(5.8)	8.0(9.0)	27(21)
MHCD322512A-1R0M-A8S	1.0	20	2	3.8(4.2)	5.8(6.3)	42(34)
MHCD322512A-1R5M-A8S	1.5	20	2	2.8(3.2)	4.0(4.5)	68(58)
MHCD322512A-2R2M-A8S	2.2	20	2	2.4(2.7)	3.6(4.0)	85(75)

- **Irms** DC current (A) that will cause an approximate ΔT of 40°C.
- **Isat** DC current (A) that will cause L to drop approximately 30%
- Tolerance : M = ±20%
- L : Agilent E4991A/HP4287A+16197A, 2MHz 0.2V
- Rdc : CHEN HWA502
- Isat : Agilent E4980A+HP42841A
- Irms : Agilent 6641 SYSTEM DC POWER SUPPLY
- Operating temperature range from -40°C to 125°C. (Including self - temperature rise)

Test Instruments : E4991A Impedance / Material Analyzer

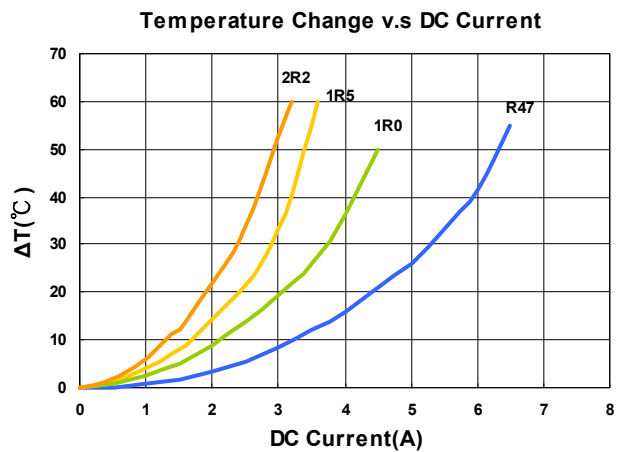
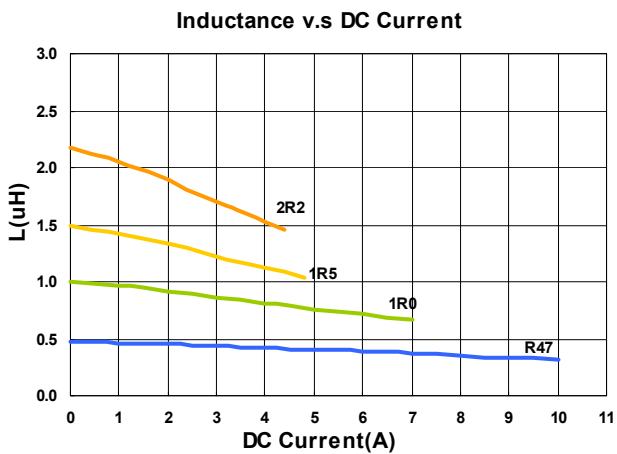

Packaging Specifications

Tape Dimensions

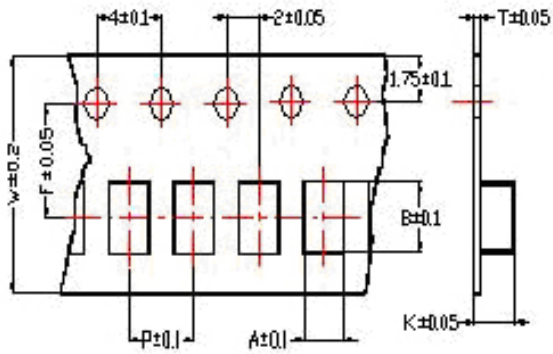

Tape Material

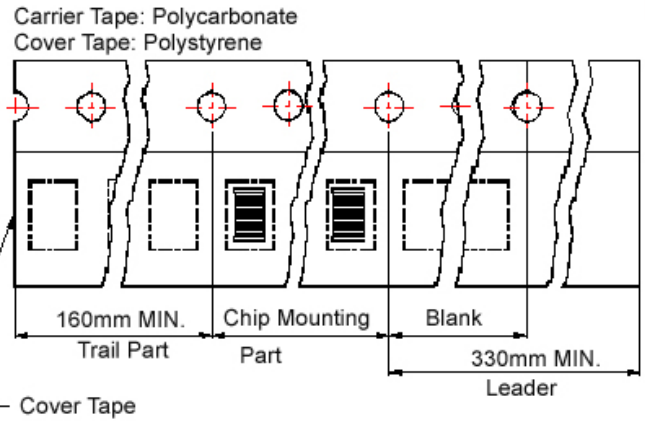

Reel Dimensions

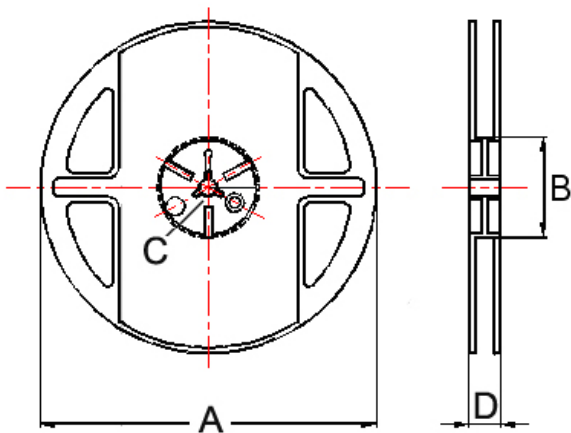

Dimensions in mm

TYPE	Tape Dimensions							Reel Dimensions				Quantity PCS / REEL
	A	B	T	W	P	F	K	A	B	C	D	
201210	1.45	2.25	0.22	8	4	3.5	1.04	178	60	12	1.5	3000
201610	1.80	2.20	0.22	8	4	3.5	1.15	178	60	12	1.5	3000
201612	1.80	2.20	0.22	8	4	3.5	1.35	178	60	12	1.5	3000
252010	2.25	2.80	0.22	8	4	3.5	1.15	178	60	12	1.5	3000
252012	2.25	2.80	0.22	8	4	3.5	1.35	178	60	12	1.5	3000
322510	2.80	3.55	0.23	8	4	3.5	1.20	178	60	12	1.5	3000
322512	2.80	3.50	0.23	8	4	3.5	1.34	178	60	12	1.5	3000

Multilayer Power Inductors



The MPx Series is a miniature type of multilayer power inductor constructed using low-loss ferrite material to support high-speed switching frequencies. The compact size and high efficiency is ideal for DC-DC converter applications in space-limited boards.

Features

- RoHS compliant
- Small size
- Low profile
- High current
- Magnetically shielded configuration allowing for high density mounting

Applications

- DC-DC converters
- Power modules
- Cellular phones
- DSC, PND, DVD
- Wireless card and other electronic devices

Product Identification

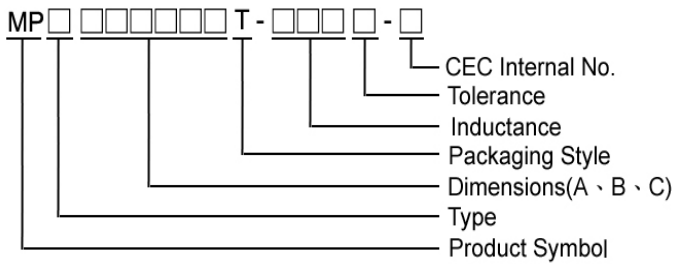

- Product Symbol : MPA, MPB
- Type : A : General , B : Low RDC
- Packaging : T : Tape and Reel , B : Bulk
- Tolerance : M = $\pm 20\%$, T = $\pm 30\%$

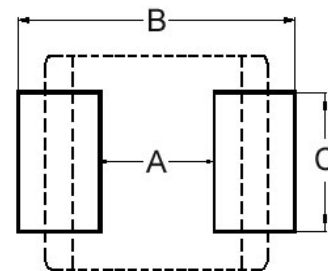
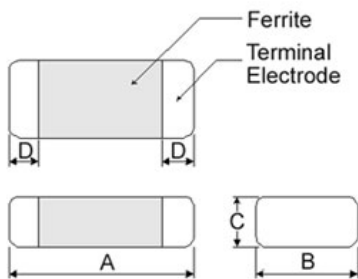

Dimensions in mm

TYPE	A	B	C	D
160808	1.6 \pm 0.15	0.8 \pm 0.15	0.8 \pm 0.15	0.3 \pm 0.2
201205	2.0 \pm 0.20	1.25 \pm 0.20	0.55 Max	0.5 \pm 0.3
201210	2.0 \pm 0.20	1.25 \pm 0.20	1.0 Max	0.5 \pm 0.3
201610	2.0 \pm 0.20	1.6 \pm 0.20	1.0 Max	0.5 \pm 0.3
252010	2.5 \pm 0.20	2.0 \pm 0.20	1.0 Max	0.6 \pm 0.2
252012	2.5 \pm 0.20	2.0 \pm 0.20	1.2 Max	0.6 \pm 0.2

Dimensions in mm

TYPE	A	B	C
160808	0.7 ~ 0.8	1.8 ~ 2.0	0.6 ~ 0.8
201205	0.8 ~ 1.2	2.3 ~ 2.9	1.0 ~ 1.4
201210	0.8 ~ 1.2	2.3 ~ 2.9	1.0 ~ 1.4
201610	0.8 ~ 1.2	2.1 ~ 2.7	1.6 ~ 2.0
252010	1.3 ~ 1.9	2.7 ~ 3.5	2.0 ~ 2.6
252012	1.3 ~ 1.9	2.7 ~ 3.5	2.0 ~ 2.6

Electrical Characteristics

MPA : General Series

Part Number	Inductance (uH)	Test Frequency (MHz)	Tolerance (±%)	RDC (Ω) ±30%	Rated current (mA) Max
MPA201210T-1R0□-N	1.0	1	20, 30	0.18	1100
MPA201210T-1R5□-N	1.5	1	20, 30	0.19	1000
MPA201210T-2R2□-N	2.2	1	20, 30	0.22	900
MPA201210T-3R3□-N	3.3	1	20, 30	0.25	700
MPA201210T-4R7□-N	4.7	1	20, 30	0.35	600

- Tolerance : M = ±20% , T = ±30%
- Packaging: Clear tape and reel {standard}.
- L : Agilent/HP4287A+16197A, 1MHz 200mV
- RDC : HP 4338B, or equivalent
- Rated Current : Applied the current to coils, the temperature rise shall not be more than 40°C
- Operating temperature range from -55°C to 125°C. (Including self - temperature rise)

Test Instruments : HP4287A Inductance / Material Analyzer

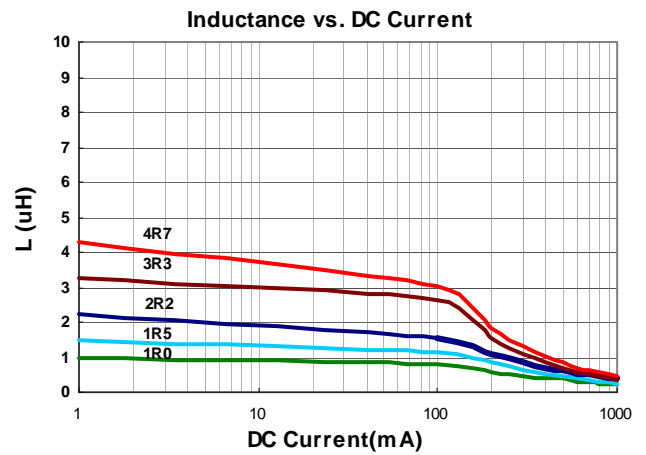
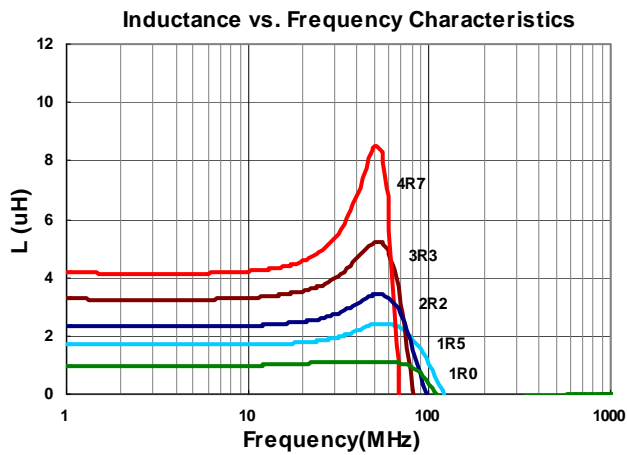

Electrical Characteristics

MPA : General Series

Part Number	Inductance (uH)	Test Frequency (MHz)	Tolerance (±%)	RDC (Ω) ±30%	Rated current (mA) Max
MPA252010T-1R0□-N	1.0	1	20, 30	0.11	1200
MPA252010T-1R5□-N	1.5	1	20, 30	0.13	1100
MPA252010T-2R2□-N	2.2	1	20, 30	0.15	1000
MPA252010T-3R3□-N	3.3	1	20, 30	0.18	1000
MPA252010T-4R7□-N	4.7	1	20, 30	0.25	900

- Tolerance : M = ±20% , T = ±30%
- Packaging: Clear tape and reel {standard}.
- L : Agilent/HP4287A+16197A, 1MHz 200mV
- RDC : HP 4118B, or equivalent
- Rated Current : Applied the current to coils, the temperature rise shall not be more than 40°C
- Operating temperature range from -55°C to 125°C . (Including self - temperature rise)

Test Instruments : HP4287A Inductance / Material Analyzer

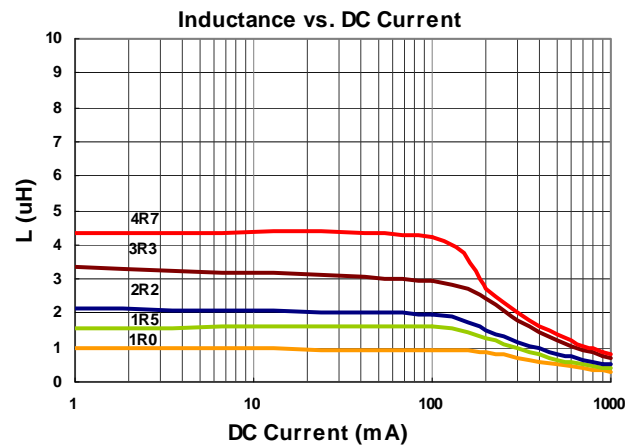
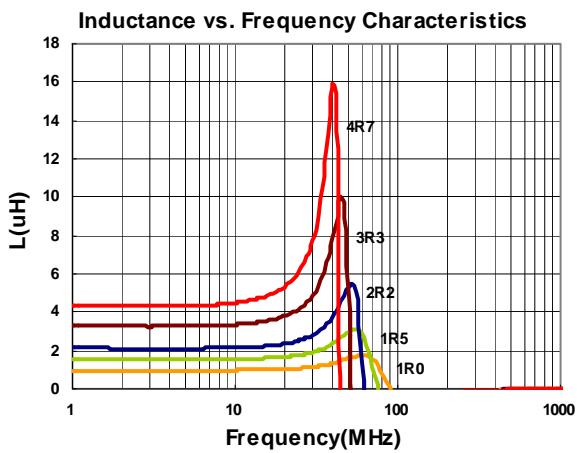

Electrical Characteristics

MPB : Low RDC Series

Part Number	Inductance (uH)	Test Frequency (MHz)	Tolerance (±%)	RDC (Ω) ±30%	Rated current (mA) Max
MPB160808T-R47□-NA2	0.47	3	20, 30	0.15	1100
MPB160808T-1R0□-NA2	1.0	3	20, 30	0.20	950
MPB160808T-2R2□-NA2	2.2	3	20, 30	0.30	750

- Tolerance : M = ±20% , T = ±30%
- Packaging: Clear tape and reel {standard}.
- L : Agilent/HP4287A+16197A, 3MHz 200mV
- RDC : HP 4338B, or equivalent
- Rated Current : Applied the current to coils, the temperature rise shall not be more than 40°C
- Operating temperature range from -55°C to 125°C. (Including self - temperature rise)

Test Instruments : HP4287A Inductance / Material Analyzer

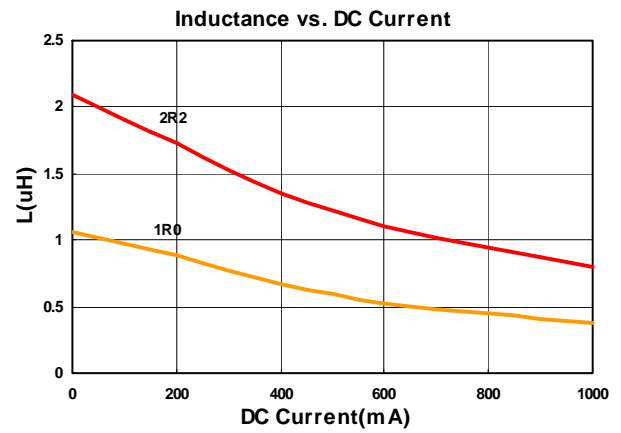
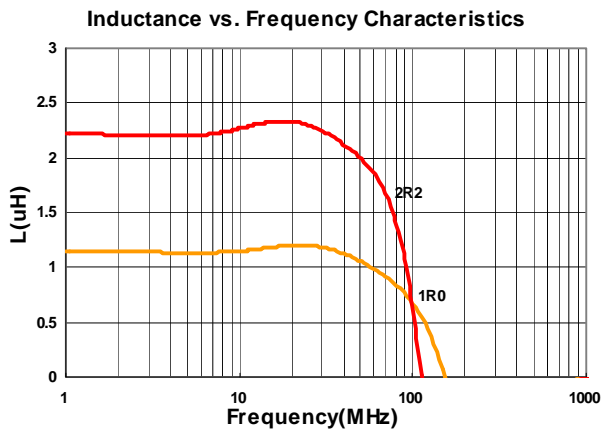

Electrical Characteristics

MPB : Low RDC Series

Part Number	Inductance (uH)	Test Frequency (MHz)	Tolerance (±%)	RDC (Ω) ±30%	Rated current (mA) Max
MPB201205T-R47□-NA2	0.47	3	20, 30	0.11	1200
MPB201205T-1R0□-NA2	1.0	3	20, 30	0.16	900
MPB201205T-1R5□-NA2	1.5	3	20, 30	0.18	800
MPB201206T-2R2□-NA2	2.2	3	20, 30	0.29	600

- Tolerance : M = ±20% , T = ±30%
- Packaging: Clear tape and reel {standard}
- L : Agilent/HP4287A+16197A, 3MHz 200mV
- RDC : HP 4338B, or equivalent
- Rated Current : Applied the current to coils, the temperature rise shall not be more than 40°C
- Operating temperature range from -55°C to 125°C . (Including self - temperature rise)

Test Instruments : HP4287A Inductance / Material Analyzer

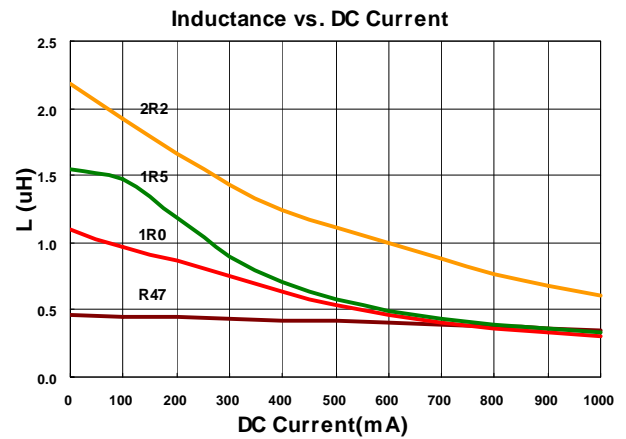
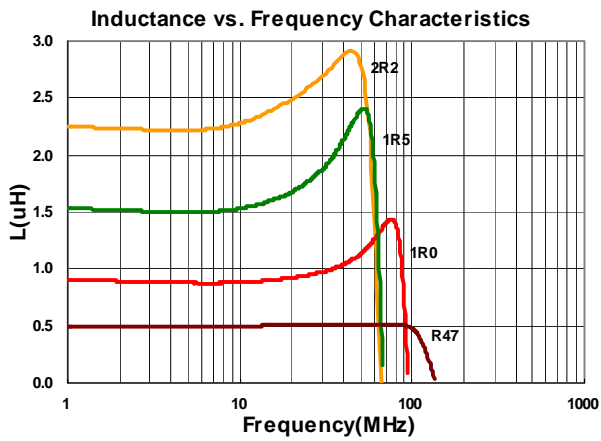

Electrical Characteristics

MPB : Low RDC Series

Part Number	Inductance (uH)	Test Frequency (MHz)	Tolerance (±%)	RDC (Ω) ±30%	Rated current (mA) Max
MPB201210T-R47□-NA2	0.47	3	20, 30	0.09	1300
MPB201210T-1R0□-NA2	1.0	3	20, 30	0.12	1200
MPB201210T-1R5□-NA2	1.5	3	20, 30	0.15	1100
MPB201210T-2R2□-NA2	2.2	3	20, 30	0.19	1100
MPB201210T-3R3□-NA2	3.3	3	20, 30	0.24	800
MPB201210T-4R7□-NA2	4.7	3	20, 30	0.26	700

- Tolerance : M = ±20% ,T = ±30%
- Packaging: Clear tape and reel {standard}.
- L : Agilent/HP4287A+16197A, 3MHz 200mV
- RDC : HP 4338B, or equivalent
- Rated Current : Applied the current to coils, the temperature rise shall not be more than 40°C
- Operating temperature range from -55°C to 125°C . (Including self - temperature rise)

Test Instruments : HP4287A Inductance / Material Analyzer

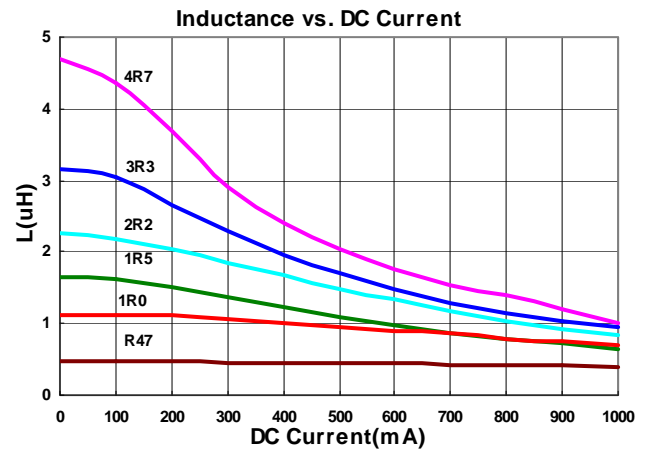
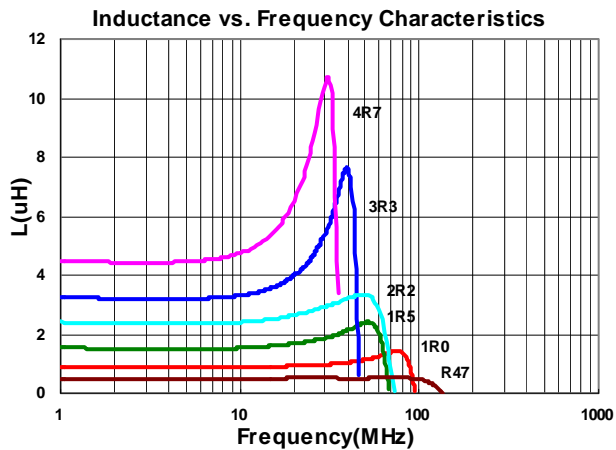

Electrical Characteristics

MPB : Low RDC Series

Part Number	Inductance (uH)	Test Frequency (MHz)	Tolerance (±%)	RDC (Ω) ±30%	Rated current (mA) Max
MPB201610T-R47□-NA2	0.47	3	20, 30	0.06	1600
MPB201610T-1R0□-NA2	1.0	3	20, 30	0.09	1300
MPB201610T-2R2□-NA2	2.2	3	20, 30	0.13	1000
MPB201610T-3R3□-NA2	3.3	3	20, 30	0.17	850
MPB201610T-4R7□-NA2	4.7	3	20, 30	0.21	800

- Tolerance : M = ±20% , T = ±30%
- Packaging: Clear tape and reel {standard}.
- L : Agilent/HP4287A+16197A, 3MHz 200mV
- RDC : HP 4338B, or equivalent
- Rated Current : Applied the current to coils, the temperature rise shall not be more than 40°C
- Operating temperature range from -55°C to 125°C. (Including self - temperature rise)

Test Instruments : HP4287A Inductance / Material Analyzer

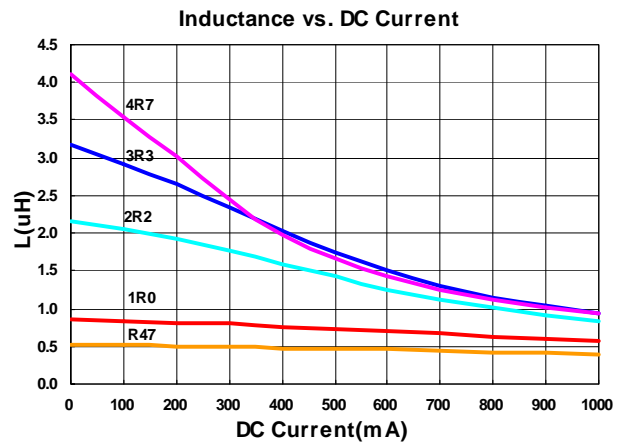
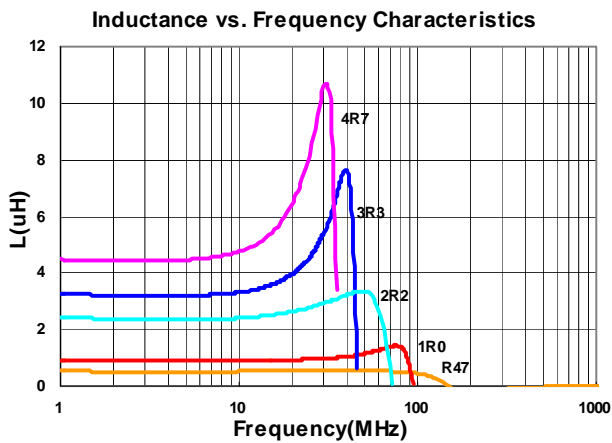

Electrical Characteristics

MPB : Low RDC Series

Part Number	Inductance (uH)	Test Frequency (MHz)	Tolerance (±%)	RDC (Ω) ±30%	Rated current (mA) Max
MPB252010T-R47□-NA2	0.47	3	20, 30	0.04	1800
MPB252010T-1R0□-NA2	1.0	3	20, 30	0.06	1500
MPB252010T-1R5□-NA2	1.5	3	20, 30	0.07	1400
MPB252010T-2R2□-NA2	2.2	3	20, 30	0.10	1200
MPB252010T-3R3□-NA2	3.3	3	20, 30	0.12	1100
MPB252010T-4R7□-NA2	4.7	3	20, 30	0.14	1000

- Tolerance : M = ±20% ,T = ±30%
- Packaging: Clear tape and reel {standard}.
- L : Agilent/HP4287A+16197A, 3MHz 200mV
- RDC : HP 4338B, or equivalent
- Rated Current : Applied the current to coils, the temperature rise shall not be more than 40°C
- Operating temperature range from -55°C to 125°C . (Including self - temperature rise)

Test Instruments : HP4287A Inductance / Material Analyzer

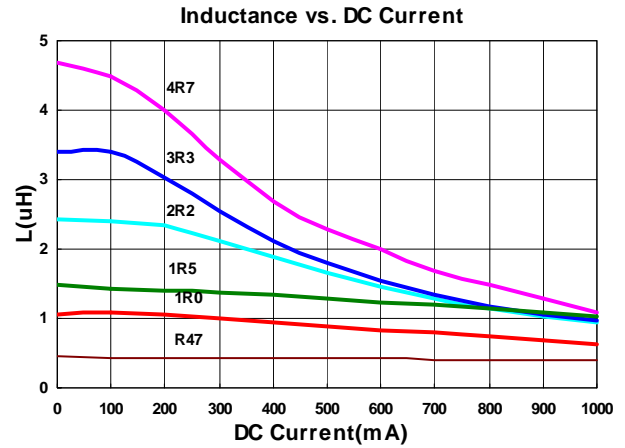
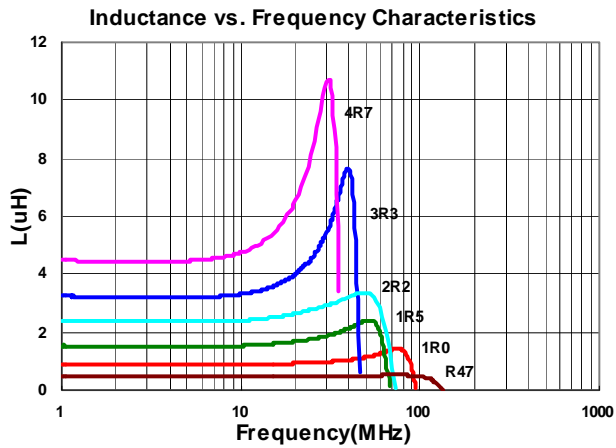

Electrical Characteristics

MPB : Low RDC Series

Part Number	Inductance (uH)	Test Frequency (MHz)	Tolerance (±%)	RDC (Ω) ±30%	Rated current (mA) Max
MPB252012T-R47□-NA2	0.47	3	20, 30	0.04	1800
MPB252012T-1R0□-NA2	1.0	3	20, 30	0.05	1600
MPB252012T-1R5□-NA2	1.5	3	20, 30	0.07	1400
MPB252012T-2R2□-NA2	2.2	3	20, 30	0.10	1200
MPB252012T-3R3□-NA2	3.3	3	20, 30	0.12	1100
MPB252012T-4R7□-NA2	4.7	3	20, 30	0.14	1000
MPB252012T-6R8□-NA2	6.8	3	20, 30	0.16	900

- Tolerance : M = ±20% , T = ±30%
- Packaging: Clear tape and reel {standard}.
- L : Agilent/HP4287A+16197A, 3MHz 200mV
- RDC : HP 4338B, or equivalent
- Rated Current : Applied the current to coils, the temperature rise shall not be more than 40°C
- Operating temperature range from -55°C to 125°C. (Including self - temperature rise)

Test Instruments : HP4287A Inductance / Material Analyzer

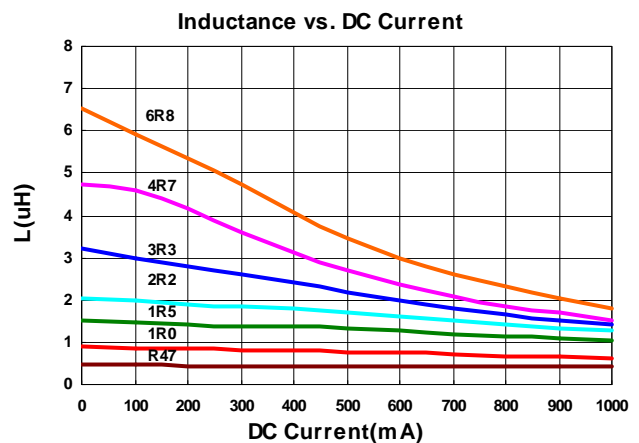
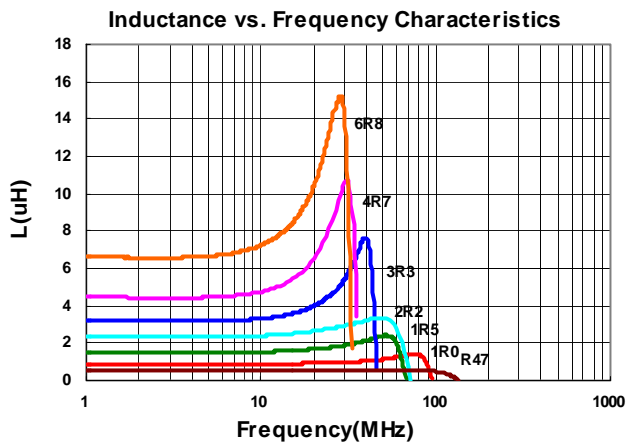

Packaging Specifications

Tape Dimensions

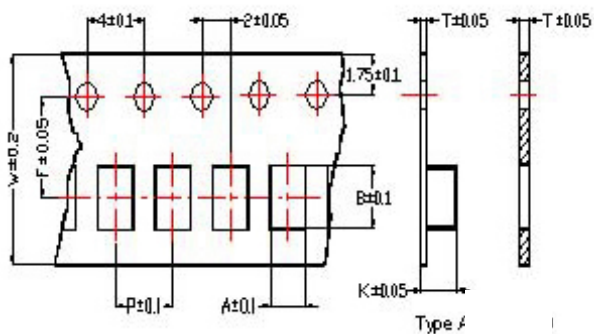

Tape Material

Carrier Tape: Polycarbonate (Tape A)
 Carrier Tape: Paper (Tape B)
 Cover Tape: Polystyrene

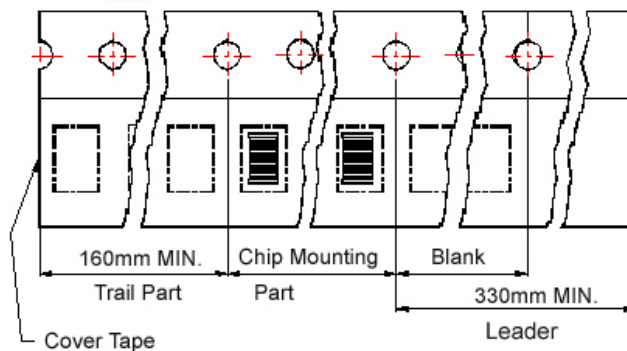

Reel Dimensions

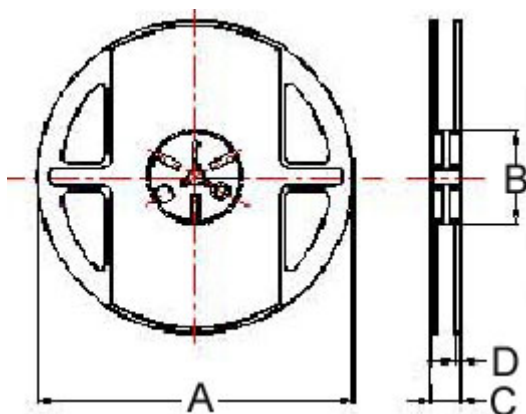

Dimensions in mm

TYPE	Tape Dimensions								Reel Dimensions				Quantity PCS / REEL
	A	B	T	W	P	F	K	Tape Type	A	B	C	D	
160808	1.05	1.85	0.95	8.0	4.0	3.5	0.80	B	178	60	12	1.5	4000
201205	1.42	2.25	0.22	8.0	4.0	3.5	0.80	A	178	60	12	1.5	4000
201210	1.45	2.25	0.22	8.0	4.0	3.5	1.04	A	178	60	12	1.5	3000
201610	1.80	2.20	0.22	8.0	4.0	3.5	1.15	A	178	60	12	1.5	3000
252010	2.25	2.8	0.25	8.0	4.0	3.5	1.35	A	178	60	12	1.5	3000
252012	2.25	2.8	0.25	8.0	4.0	3.5	1.35	A	178	60	12	1.5	3000

MHCC、MHCI Series



MHCC series is designed for low profile type with low RDC and ultra large current. Its molded magnetic shielded type is suitable for high-density mounting and ultra low buzz noise. Soldering conditions can be easily confirmed when mounting onto the board. This series also provides customers with embossed carrier type packaging for automatic mounting machine.

Features

- RoHS compliant
- Low profile type
- Shielded construction
- Ultra low buzz noise due to molding construction

Applications

- High density DC/DC converters
- POL converters
- High current VRM/VRD for notebook / Server / desktop CPUs
- High speed charger
- For thickness less than 1.2mm, suitable for low profile applications e.g., Ultra thin NB/Monitor/TV/Tablet

Product Identification

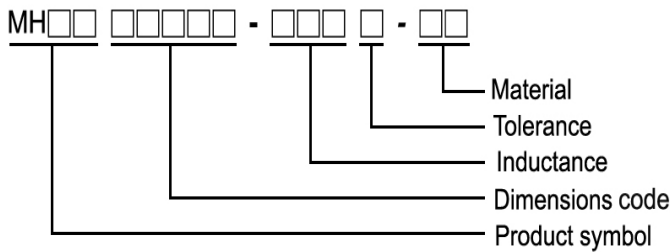

Shape and Dimensions

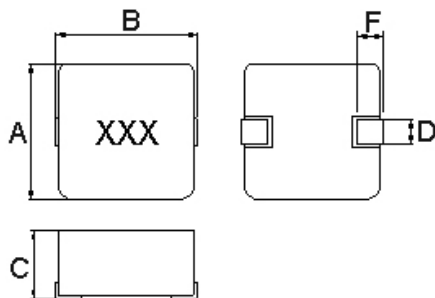

Dimensions in mm

TYPE	A	B Max	C Max	D	F
04012	4.1±0.2	4.6±0.2	1.2	1.5±0.3	1.0±0.5
04015	4.1±0.2	4.6±0.2	1.5	1.5±0.3	1.0±0.5
04020	4.1±0.2	4.6±0.2	2.0	1.5±0.3	1.0±0.5
05012	5.4±0.35	5.7±0.2	1.2	2.0±0.3	1.5±0.3
05015	5.4±0.35	5.7±0.2	1.5	2.0±0.3	1.5±0.3
05018	5.4±0.35	5.7±0.2	1.8	2.0±0.3	1.5±0.3
05020	5.4±0.35	5.7±0.2	1.8±0.2	2.0±0.3	1.5±0.3
05030	5.4±0.35	5.7±0.2	3.0	2.0±0.3	1.5±0.3
06012	6.6±0.2	7.3	1.2	2.9	1.6±0.5
06015	6.6±0.2	7.3	1.3±0.2	2.9	1.6±0.5
06018	6.6±0.2	7.3	1.6±0.2	2.9	1.6±0.5
06024	6.6±0.2	7.3	2.4	2.9	1.6±0.5
06030	6.6±0.2	7.3	3.0	2.9	1.6±0.5
10030	10.1±0.3	11.6	3.0	3.0	2.5±0.5
10040	10.1±0.3	11.6	4.0	3.0	2.5±0.5
12035	12.6±0.2	13.8	3.5	3.7	2.7±0.7
12050	12.6±0.2	13.8	5.0	3.7	2.7±0.7
12060	12.6±0.2	13.8	6.0	3.7	2.7±0.7

Recommended Pattern

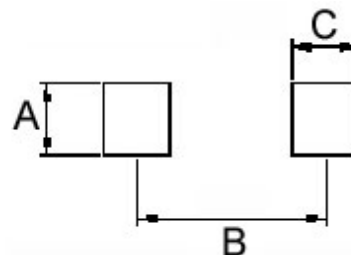

Dimensions in mm

TYPE	A	B	C
04012	2.5	3.7	1.5
04015	2.5	3.7	1.5
04020	2.5	3.7	1.5
05012	2.5	4.1	1.9
05015	2.5	4.1	1.9
05018	2.5	4.1	1.9
05020	2.5	4.1	1.9
05030	2.5	4.1	1.9
06012	3.5	6.05	2.35
06015	3.5	6.05	2.35
06018	3.5	6.05	2.35
06024	3.5	6.05	2.35
06030	3.5	6.05	2.35
10030	4.0	9.5	3.5
10040	4.0	9.5	3.5
12035	5.0	10.5	4.0
12050	5.0	10.5	4.0
12060	5.0	10.5	4.0

Electrical Characteristics

Part Number	Inductance (μH)	Tolerance ($\pm\%$)	Test Frequency (KHz)	I _{rms} (A)Typ.	I _{sat} (A)Typ.	RDC ($\text{m}\Omega$)Max
MHCI04012-R22M-R8	0.22	20	100	8.5	11.5	12
MHCI04012-R47M-R8	0.47	20	100	5.0	7.0	25
MHCI04012-R68M-R8	0.68	20	100	4.5	6.0	36
MHCI04012-1R0M-R8	1.0	20	100	4.2	5.2	47
MHCI04012-2R2M-R8	2.2	20	100	2.75	3.5	83.5
MHCI04012-4R7M-R8	4.7	20	100	1.8	2.8	195

- I_{rms} DC current (A) that will cause an approximate ΔT of 40°C
- I_{sat} DC current (A) that will cause L to drop approximately 30%
- Tolerance : M= $\pm 20\%$
- L : WK 3260B, 100KHz 0.5V
- R_{dc} : CHEN HWA 502
- Operating temperature range from -55°C to 125°C. (Including self - temperature rise)

Test Instruments : WK3260B Impedance / Material Analyzer

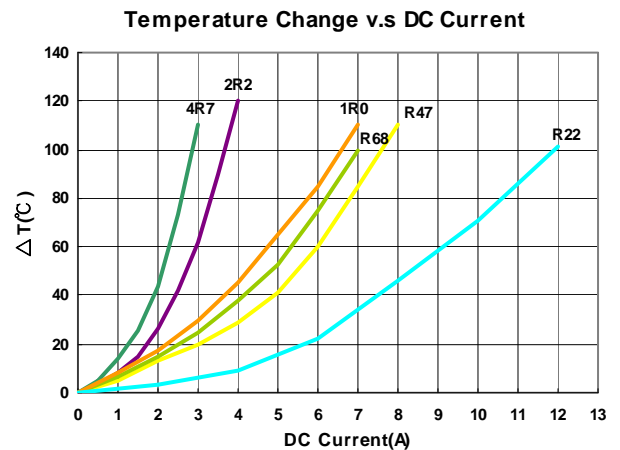
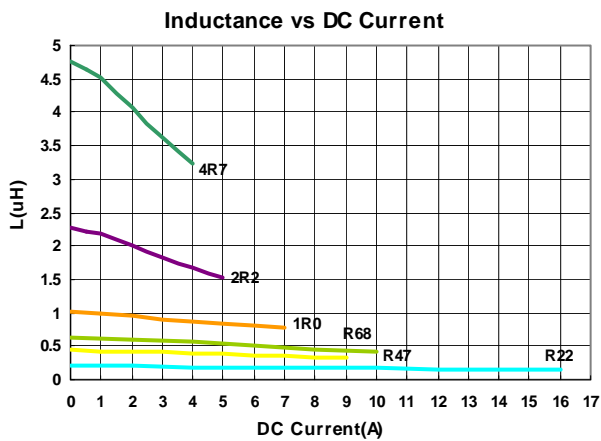

Electrical Characteristics

Part Number	Inductance (μH)	Tolerance ($\pm\%$)	Test Frequency (KHz)	I _{rms} (A)Typ.	I _{sat} (A)Typ.	RDC ($\text{m}\Omega$)Max
MHCI04015-1R0M-R8	1.0	20	100	4	7	42
MHCI04015-1R5M-R8	1.5	20	100	3.5	6	50
MHCI04015-2R2M-R8	2.2	20	100	3	5	79
MHCI04015-3R3M-R8	3.3	20	100	2.3	4.5	132
MHCI04015-4R7M-R8	4.7	20	100	2	4	146

- I_{rms} DC current (A) that will cause an approximate ΔT of 40°C
- I_{sat} DC current (A) that will cause L to drop approximately 30%
- Tolerance : M= $\pm 20\%$
- L : WK 3260B, 100KHz 0.5V
- R_{dc} : CHEN HWA 502
- Operating temperature range from -55°C to 125°C. (Including self - temperature rise)

Test Instruments : WK3260B Impedance / Material Analyzer

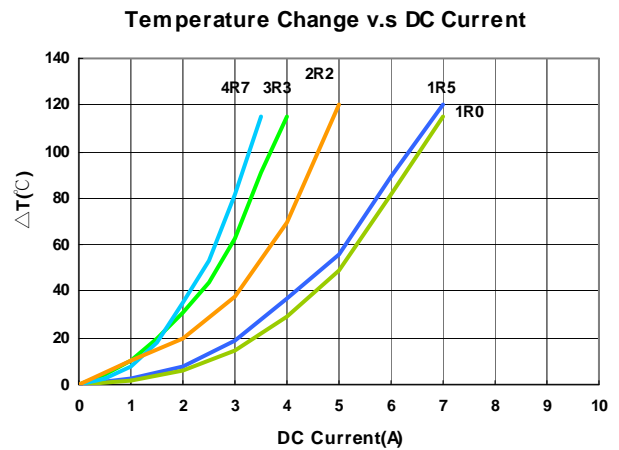
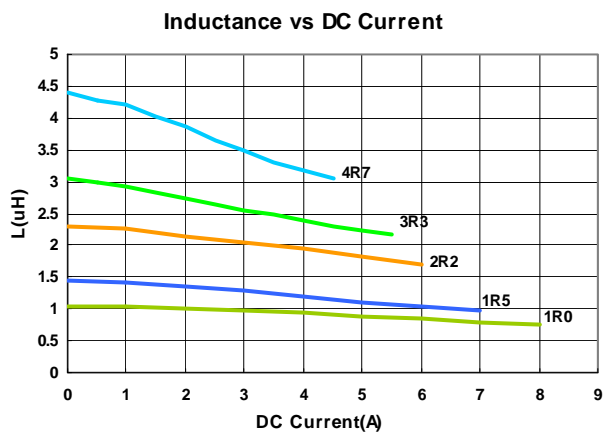

Electrical Characteristics

Part Number	Inductance (μH)	Tolerance ($\pm\%$)	Test Frequency (KHz)	I _{rms} (A)Typ.	I _{sat} (A)Typ.	RDC ($\text{m}\Omega$)Max
MHCI04020-R10M-R8	0.10	20	100	12.0	25	4
MHCI04020-R22M-R8	0.22	20	100	9.0	12.5	6.6
MHCI04020-R47M-R8	0.47	20	100	7.0	9.5	14
MHCI04020-1R0M-R8	1.0	20	100	4.5	7.0	27
MHCI04020-1R5M-R8	1.5	20	100	4.0	6.0	46
MHCI04020-2R2M-R8	2.2	20	100	3.0	5.0	58
MHCI04020-3R3M-R8	3.3	20	100	2.5	4.0	87
MHCI04020-4R7M-R8	4.7	20	100	2.2	3.0	105
MHCI04020-6R8M-R8	6.8	20	100	2.0	2.5	135
MHCI04020-8R2M-R8	8.2	20	100	2.0	2.5	216
MHCI04020-100M-R8	10	20	100	1.6	2.0	258

- I_{rms} DC current (A) that will cause an approximate ΔT of 40°C
- I_{sat} DC current (A) that will cause L to drop approximately 30%
- Tolerance : M= $\pm 20\%$
- L : WK 3260B, 100KHz 0.5V
- R_{dc} : CHEN HWA 502
- Operating temperature range from -55°C to 125°C. (Including self - temperature rise)

Test Instruments : WK3260B Impedance / Material Analyzer

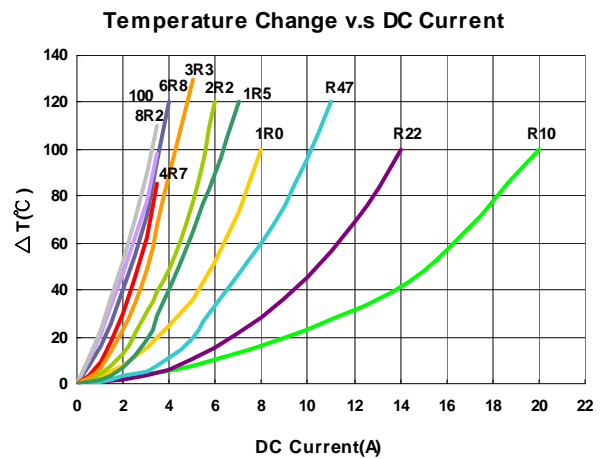
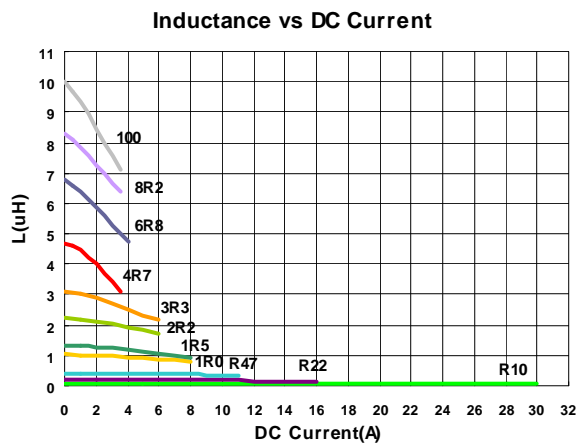

Electrical Characteristics

Part Number	Inductance (μH)	Tolerance ($\pm\%$)	Test Frequency (KHz)	I _{rms} (A)Typ.	I _{sat} (A)Typ.	RDC ($\text{m}\Omega$)Max
MHCI05012-2R2M-R8A	2.2	20	100	3.5	4	76
MHCI05012-6R8M-R8A	6.8	20	100	2.0	2.3	250

- I_{rms} current (A) that will cause an approximate ΔT of 40°C
- I_{sat} current (A) that will cause L to drop approximately 30%
- Tolerance : M= $\pm 20\%$
- L : WK 3260B, 100KHz 0.5V
- R_{dc} : CHEN HWA 502
- Operating temperature range from -55°C to 125°C. (Including self - temperature rise)

Test Instruments : WK3260B Impedance / Material Analyzer

Inductance vs DC Current

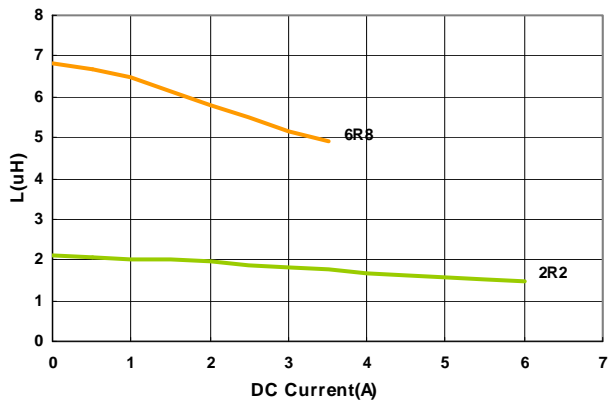

Temperature Change v.s DC Current

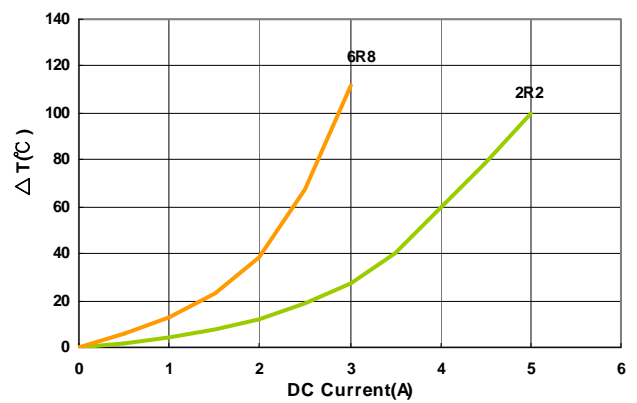

Electrical Characteristics

Part Number	Inductance (μH)	Tolerance ($\pm\%$)	Test Frequency (KHz)	I _{rms} (A)Typ.	I _{sat} (A)Typ.	RDC ($\text{m}\Omega$)Max
MHCI05015-R68M-R8	0.68	20	100	6.0	10	23
MHCI05015-1R0M-R8	1.0	20	100	5.0	8.0	33
MHCI05015-1R5M-R8	1.5	20	100	4.0	6.0	50
MHCI05015-2R2M-R8	2.2	20	100	3.3	6.0	68
MHCI05015-3R3M-R8	3.3	20	100	3.0	5.0	84
MHCI05015-4R7M-R8	4.7	20	100	2.5	4.0	135
MHCI05015-5R6M-R8	5.6	20	100	2.2	3.5	175
MHCI05015-6R8M-R8	6.8	20	100	2.0	3.0	192
MHCI05015-100M-R8	10	20	100	1.5	2.0	195

- I_{rms} DC current (A) that will cause an approximate ΔT of 40°C
- I_{sat} DC current (A) that will cause L to drop approximately 30%
- Tolerance : M= $\pm 20\%$
- L : WK 3260B, 100KHz 0.5V
- R_{dc} : CHEN HWA 502
- Operating temperature range from -55°C to 125°C. (Including self - temperature rise)

Test Instruments : WK3260B Impedance / Material Analyzer

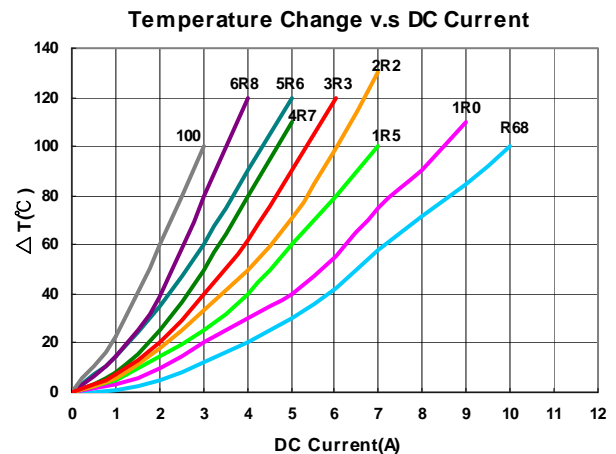
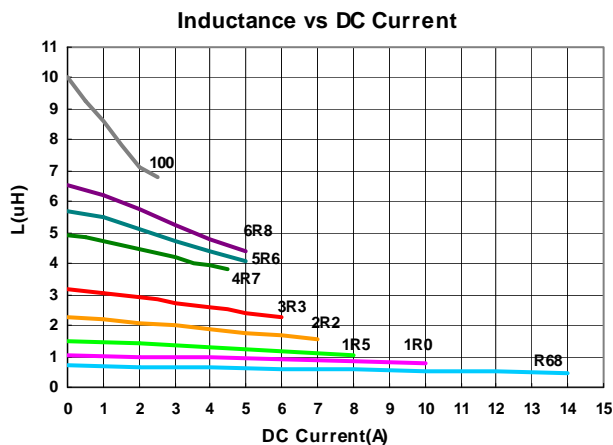

Electrical Characteristics

Part Number	Inductance (μH)	Tolerance ($\pm\%$)	Test Frequency (KHz)	I _{rms} (A)Typ.	I _{sat} (A)Typ.	RDC (m Ω)Max
MHCI05018-R47M-R8A	0.47	20	100	10.5	15.5	9.0
MHCI05018-1R0M-R8A	1.0	20	100	8.0	9.0	17
MHCI05018-2R2M-R8A	2.2	20	100	5.0	6.5	35
MHCI05018-6R8M-R8A	6.8	20	100	2.8	3.4	120

- I_{rms} DC current (A) that will cause an approximate ΔT of 40°C
- I_{sat} DC current (A) that will cause L to drop approximately 30%
- Tolerance : M= $\pm 20\%$
- L : WK 3260B, 100KHz 0.5V
- R_{dc} : CHEN HWA 502
- Operating temperature range from -55°C to 125°C. (Including self - temperature rise)

Test Instruments : WK3260B Impedance / Material Analyzer

Inductance vs DC Current

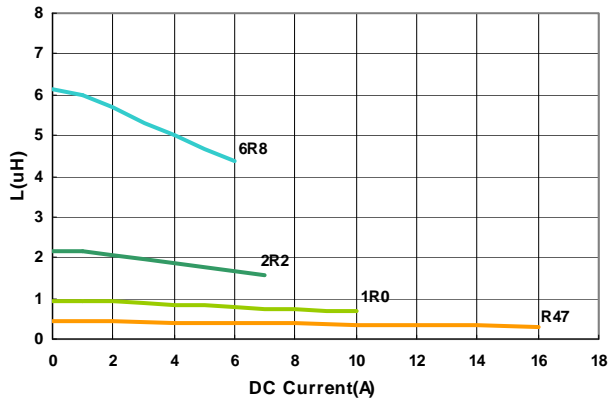

Temperature Change v.s DC Current

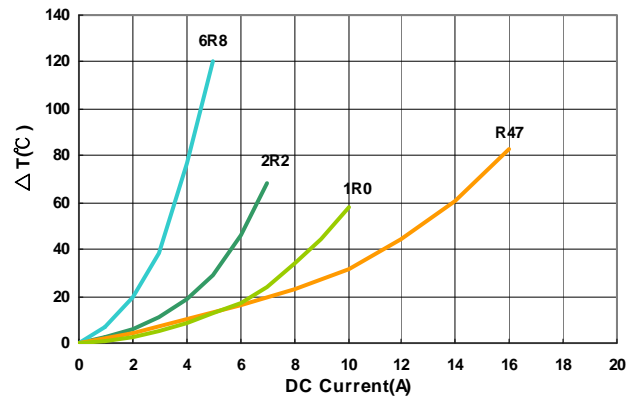

Electrical Characteristics

Part Number	Inductance (μH)	Tolerance ($\pm\%$)	Test Frequency (KHz)	I _{rms} (A)Typ.	I _{sat} (A)Typ.	RDC ($\text{m}\Omega$)Max
MHCI05020-R47M-R8	0.47	20	100	10.5	15.5	9
MHCI05020-1R0M-R8	1.0	20	100	6.0	7.0	30
MHCI05020-1R5M-R8	1.5	20	100	5.5	6.5	35
MHCI05020-2R2M-R8	2.2	20	100	4.0	6.0	45
MHCI05020-3R3M-R8	3.3	20	100	3.5	5.5	60
MHCI05020-4R7M-R8	4.7	20	100	3.0	5.0	90
MHCI05020-5R6M-R8	5.6	20	100	2.8	4.5	120
MHCI05020-6R8M-R8	6.8	20	100	2.8	4.5	125
MHCI05020-100M-R8	10	20	100	2.3	4.0	180

- I_{rms} DC current (A) that will cause an approximate ΔT of 40°C
- I_{sat} DC current (A) that will cause L to drop approximately 30%
- Tolerance : M= $\pm 20\%$
- L : WK 3260B, 100KHz 0.5V
- R_{dc} : CHEN HWA 502
- Operating temperature range from -55°C to 125°C. (Including self - temperature rise)

Test Instruments : WK3260B Impedance / Material Analyzer

Inductance v.s DC Current

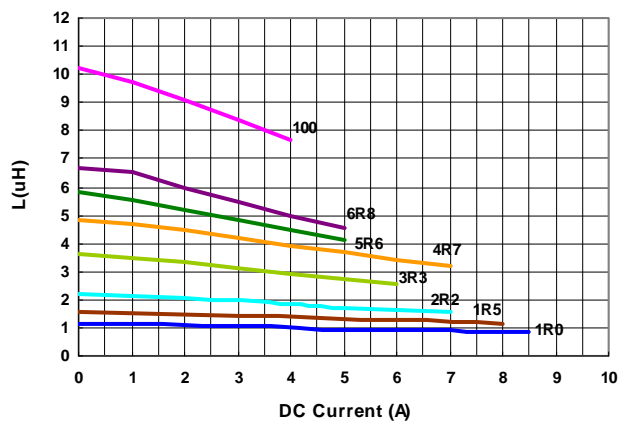

Temperature Change v.s DC Current

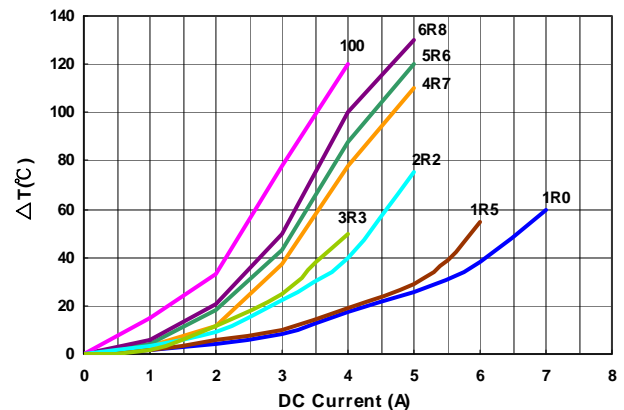

Electrical Characteristics

Part Number	Inductance (μH)	Tolerance ($\pm\%$)	Test Frequency (KHz)	I _{rms} (A)Typ.	I _{sat} (A)Typ.	RDC ($\text{m}\Omega$)Max
MHCI05030-R47M-R8	0.47	20	100	10.0	14	8
MHCI05030-R68M-R8	0.68	20	100	8.0	14	12
MHCI05030-1R0M-R8	1.0	20	100	7.0	11	15
MHCI05030-1R2M-R8	1.2	20	100	6.5	11	15
MHCI05030-1R5M-R8	1.5	20	100	6.0	10	25
MHCI05030-2R2M-R8	2.2	20	100	5.0	8	35
MHCI05030-3R3M-R8	3.3	20	100	4.5	7	46
MHCI05030-4R7M-R8	4.7	20	100	4.0	6	60

- I_{rms} DC current (A) that will cause an approximate ΔT of 40°C
- I_{sat} DC current (A) that will cause L to drop approximately 30%
- Tolerance : M= $\pm 20\%$
- L : WK 3260B, 100KHz 0.5V
- Rdc : CHEN HWA 502
- Operating temperature range from -55°C to 125°C . (Including self - temperature rise)

Test Instruments : WK3260B Impedance / Material Analyzer

Inductance v.s DC Current

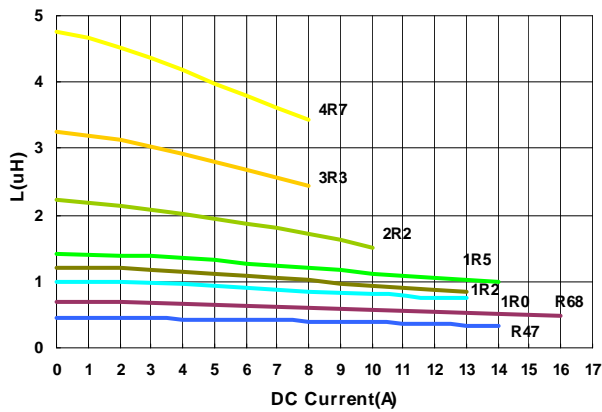

Temperature Change v.s DC Current

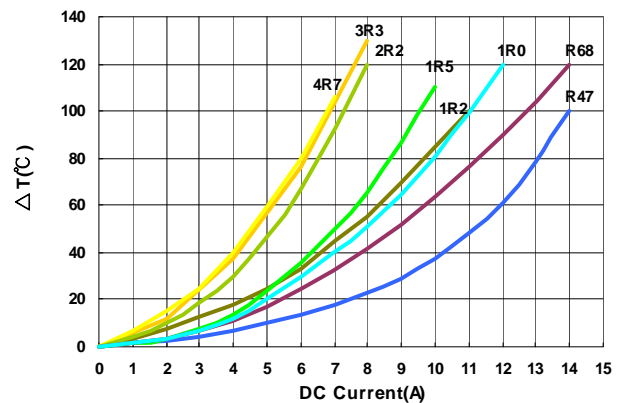

Electrical Characteristics

Part Number	Inductance (μH)	Tolerance ($\pm\%$)	Test Frequency (KHz)	I _{rms} (A)Typ.	I _{sat} (A)Typ.	RDC (m Ω)Max
MHCI06012-6R8M-R8A	6.8	20	100	2.2	2.8	210

- I_{rms} DC current (A) that will cause an approximate ΔT of 40°C
- I_{sat} DC current (A) that will cause L to drop approximately 30%
- Tolerance : M= $\pm 20\%$
- L : WK 3260B, 100KHz 0.5V
- R_{dc} : CHEN HWA 502
- Operating temperature range from -55°C to 125°C. (Including self - temperature rise)

Test Instruments : WK3260B Impedance / Material Analyzer

Inductance vs DC Current

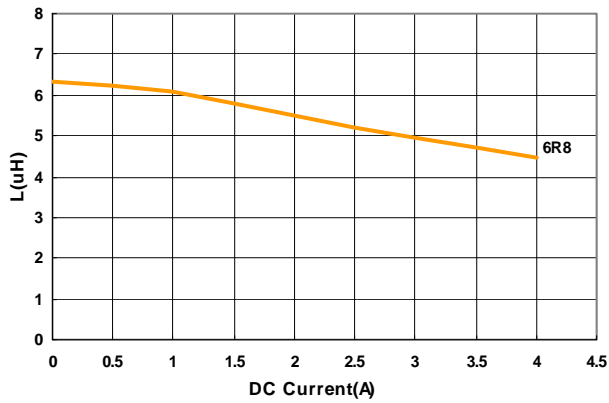

Temperature Change v.s DC Current

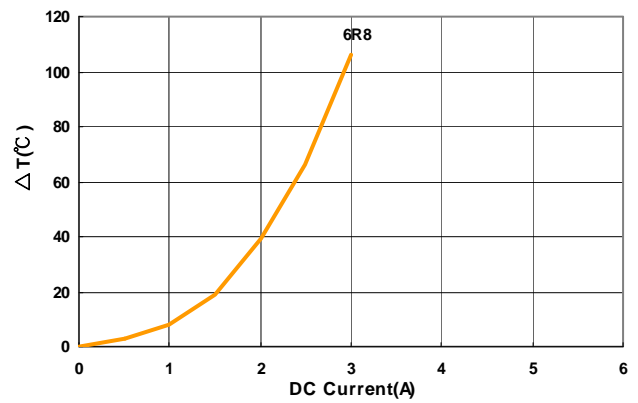

Electrical Characteristics

Part Number	Inductance (μH)	Tolerance ($\pm\%$)	Test Frequency (KHz)	I _{rms} (A)Typ.	I _{sat} (A)Typ.	RDC ($\text{m}\Omega$)Max
MHCI06015-1R0M-R8	1.0	20	100	5.5	9.0	25
MHCI06015-2R2M-R8	2.2	20	100	3.5	6.0	54
MHCI06015-3R3M-R8	3.3	20	100	3.3	5.5	63
MHCI06015-4R7M-R8	4.7	20	100	3.2	4.5	105
MHCI06015-6R8M-R8	6.8	20	100	2.5	4.0	140

- I_{rms} DC current (A) that will cause an approximate ΔT of 40°C
- I_{sat} DC current (A) that will cause L to drop approximately 30%
- Tolerance : M= $\pm 20\%$
- L : WK 3260B, 100KHz 0.5V
- Rdc : CHEN HWA 502
- Operating temperature range from -55°C to 125°C. (Including self - temperature rise)

Test Instruments : WK3260B Impedance / Material Analyzer

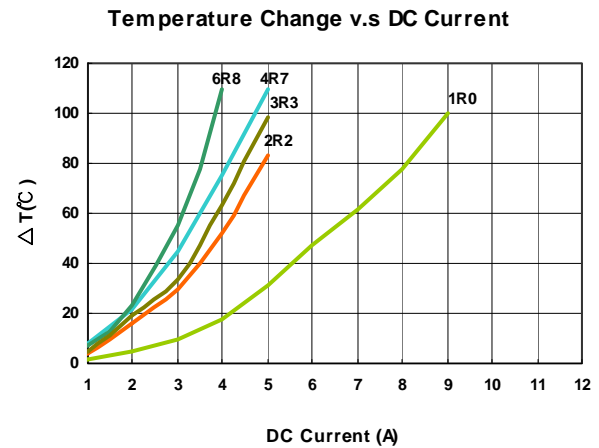
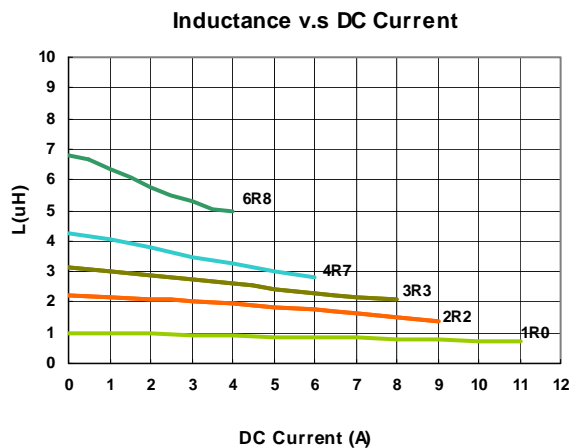

Electrical Characteristics

Part Number	Inductance (μH)	Tolerance ($\pm\%$)	Test Frequency (KHz)	I _{rms} (A)Typ.	I _{sat} (A)Typ.	RDC ($\text{m}\Omega$)Max
MHCI06018-1R0M-R8	1.0	20	100	7.0	10.0	17
MHCI06018-1R5M-R8	1.5	20	100	5.0	10.5	28
MHCI06018-2R2M-R8	2.2	20	100	5.0	8.0	35
MHCI06018-3R3M-R8	3.3	20	100	3.5	8.0	60
MHCI06018-4R7M-R8	4.7	20	100	3.5	5.0	72
MHCI06018-6R8M-R8	6.8	20	100	2.8	3.5	110

- I_{rms} DC current (A) that will cause an approximate ΔT of 40°C
- I_{sat} DC current (A) that will cause L to drop approximately 30%
- Tolerance : M= $\pm 20\%$
- L : WK 3260B, 100KHz 0.5V
- Rdc : CHEN HWA 502
- Operating temperature range from -55°C to 125°C . (Including self - temperature rise)

Test Instruments : WK3260B Impedance / Material Analyzer

Inductance v.s DC Current

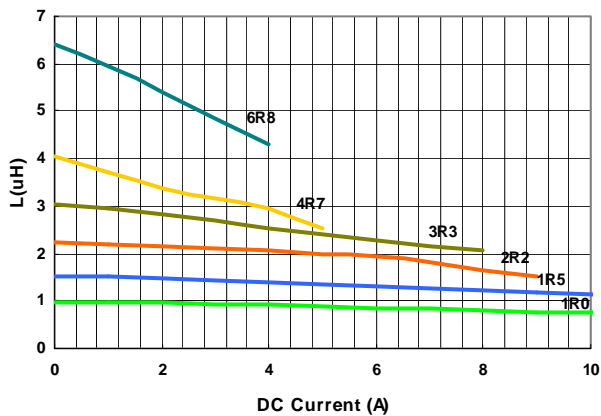

Temperature Change v.s DC Current

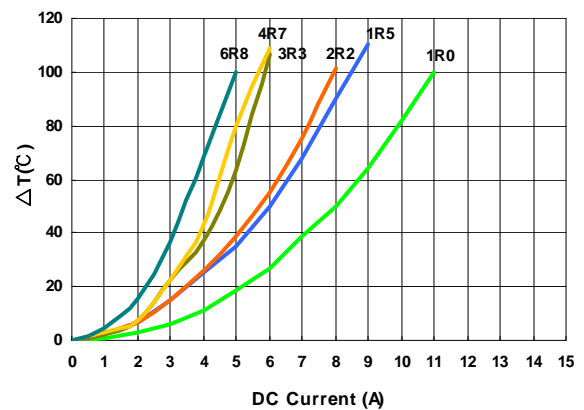

Electrical Characteristics

Part Number	Inductance (μH)	Tolerance ($\pm\%$)	Test Frequency (KHz)	I _{rms} (A)Typ.	I _{sat} (A)Typ.	RDC ($\text{m}\Omega$)Max
MHCI06018-R22M-R8A	0.22	20	100	14	29	5.2
MHCI06018-R33M-R8A	0.33	20	100	12	22	6.8
MHCI06018-R47M-R8A	0.47	20	100	11	18	8.4
MHCI06018-R68M-R8A	0.68	20	100	9	17	12.7
MHCI06018-1R0M-R8A	1.0	20	100	7	14	17
MHCI06018-1R5M-R8A	1.5	20	100	6.5	12	26
MHCI06018-2R2M-R8A	2.2	20	100	6.0	10	35
MHCI06018-4R7M-R8A	4.7	20	100	3.5	5	70
MHCI06018-6R8M-R8A	6.8	20	100	2.8	3.5	110
MHCI06018-100M-R8A	10	20	100	2.3	2.5	155

- I_{rms} DC current (A) that will cause an approximate ΔT of 40°C
- I_{sat} DC current (A) that will cause L to drop approximately 30%
- Tolerance : M= $\pm 20\%$
- L : WK 3260B, 100KHz 0.5V
- R_{dc} : CHEN HWA 502
- Operating temperature range from -55°C to 125°C. (Including self - temperature rise)

Test Instruments : WK3260B Impedance / Material Analyzer

Inductance vs DC Current

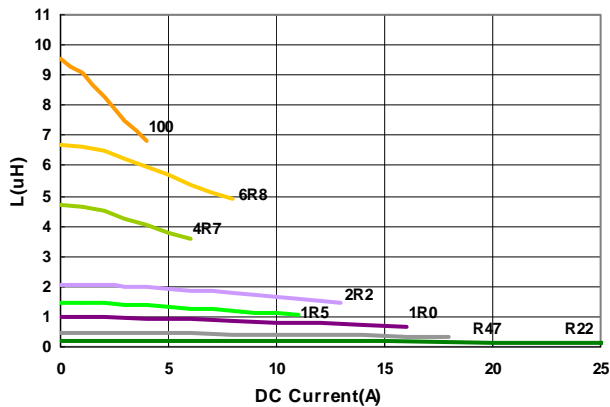

Temperature Change v.s DC Current

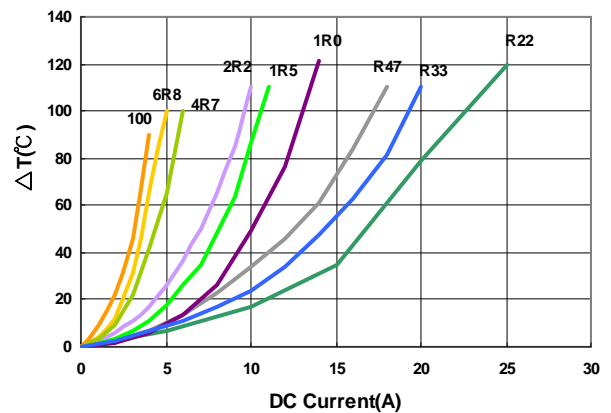

Electrical Characteristics

Part Number	Inductance (μH)	Tolerance ($\pm\%$)	Test Frequency (MHz)	I _{rms} (A)Typ.	I _{sat} (A)Typ.	RDC ($\text{m}\Omega$)Max
MHCI06024-1R0M-R8	1.0	20	100	9.0	16	13.5
MHCI06024-2R2M-R8	2.2	20	100	6.0	12	28
MHCI06024-6R8M-R8	6.8	20	100	3.5	4	66
MHCI06024-100M-R8	10	20	100	3.1	4	101

- I_{rms} DC current (A) that will cause an approximate ΔT of 40°C
- I_{sat} DC current (A) that will cause L to drop approximately 30%
- Tolerance : M= $\pm 20\%$
- L : WK 3260B, 100KHz 0.5V
- R_{dc} : CHEN HWA 502
- Operating temperature range from -55°C to 125°C. (Including self - temperature rise)

Test Instruments : WK3260B Impedance / Material Analyzer

Inductance v.s DC Current

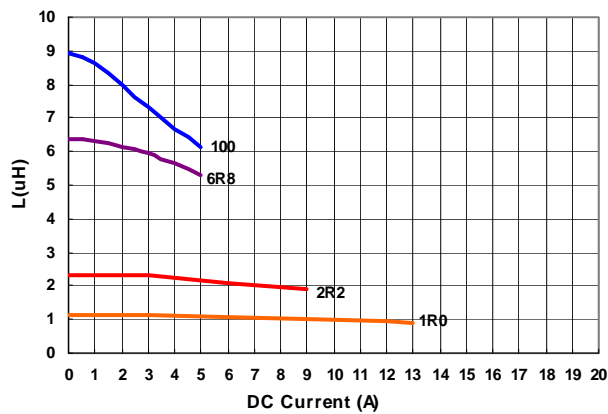

Temperature Change v.s DC Current

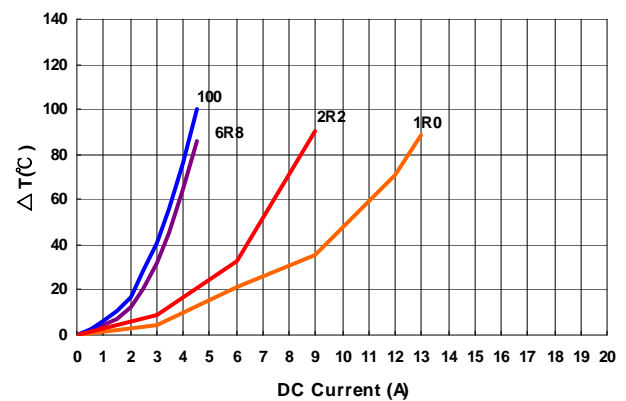

Electrical Characteristics

Part Number	Inductance (μH)	Tolerance ($\pm\%$)	Test Frequency (MHz)	I _{rms} (A)Typ.	I _{sat} (A)Typ.	RDC (m Ω)Max
MHCI06024-R22M-R8A	0.22	20	100	21	34	3.2
MHCI06024-R33M-R8A	0.33	20	100	18	24.5	4.1
MHCI06024-R47M-R8A	0.47	20	100	15	22	5.1
MHCI06024-1R0M-R8A	1.0	20	100	9	16	13.5
MHCI06024-1R5M-R8A	1.5	20	100	9	15	20
MHCI06024-2R2M-R8A	2.2	20	100	7	14	28
MHCI06024-4R7M-R8A	4.7	20	100	5	10	50
MHCI06024-100M-R8A	10	20	100	3.1	4.0	101
MHCI06024-150M-R8A	15	20	100	2.5	3.3	160

- I_{rms} DC current (A) that will cause an approximate ΔT of 40°C
- I_{sat} DC current (A) that will cause L to drop approximately 30%
- Tolerance : M= $\pm 20\%$
- L : WK 3260B, 100KHz 0.5V
- R_{dc} : CHEN HWA 502
- Operating temperature range from -55°C to 125°C. (Including self - temperature rise)

Test Instruments : WK3260B Impedance / Material Analyzer

Inductance vs DC Current

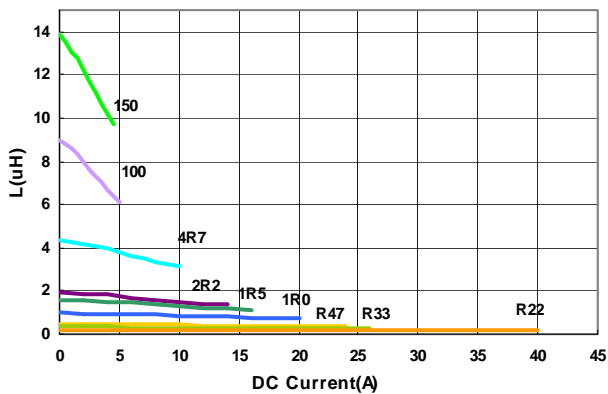

Temperature Change v.s DC Current

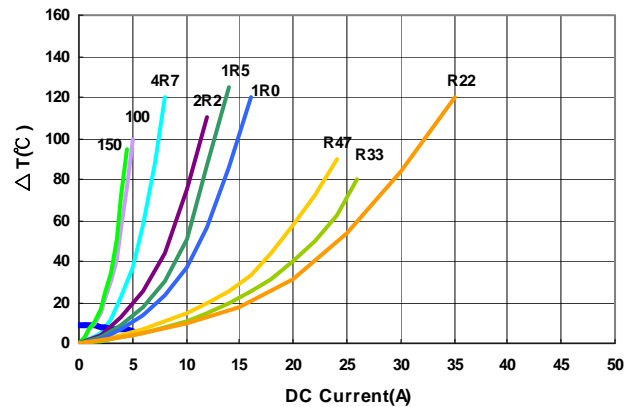

Electrical Characteristics

Part Number	Inductance (μH)	Tolerance ($\pm\%$)	Test Frequency (KHz)	I _{rms} (A)Typ.	I _{sat} (A)Typ.	RDC (m Ω)Max
MHCI06030-R10M-R8	0.10	20	100	37	45	1.5
MHCI06030-R22M-R8	0.22	20	100	23	40	2.8
MHCI06030-R33M-R8	0.33	20	100	20	33	4.2
MHCI06030-R47M-R8	0.47	20	100	16.5	27	5.5
MHCI06030-R68M-R8	0.68	20	100	15	24	6.3
MHCI06030-R82M-R8	0.82	20	100	13	23	8.0
MHCI06030-1R0M-R8	1.0	20	100	12	22	10
MHCI06030-1R5M-R8	1.5	20	100	9.5	18	15
MHCI06030-2R2M-R8	2.2	20	100	8.5	14	20
MHCI06030-3R3M-R8	3.3	20	100	6.0	12	35
MHCI06030-4R7M-R8	4.7	20	100	5.5	9	40
MHCI06030-6R8M-R8	6.8	20	100	4.5	8	60
MHCC06030-8R2M-R7	8.2	20	100	4.5	6	60
MHCC06030-100M-R7	10	20	100	4.0	5.5	68

- I_{rms} DC current (A) that will cause an approximate ΔT of 40°C
- I_{sat} DC current (A) that will cause L to drop approximately 30%
- Tolerance : M= $\pm 20\%$
- L : WK 3260B, 100KHz 0.5V
- Rdc : CHEN HWA 502
- Operating temperature range from -55°C to 125°C. (Including self - temperature rise)

Test Instruments : WK3260B Impedance / Material Analyzer

Inductance v.s DC Current

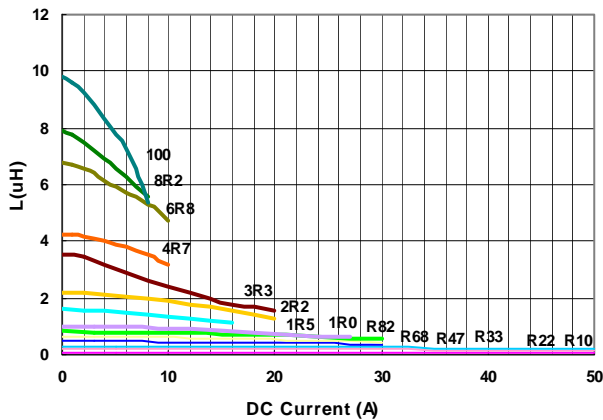

Temperature Change v.s DC Current

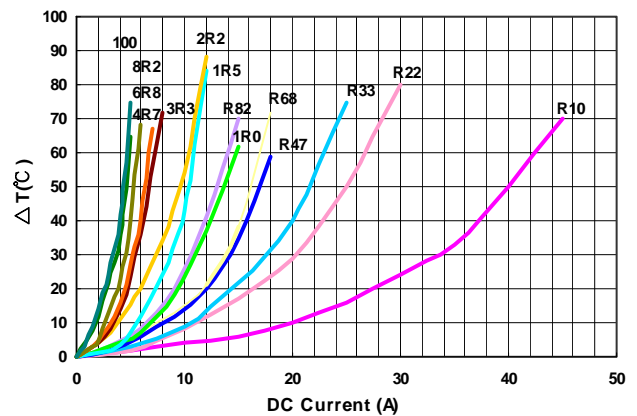

Electrical Characteristics

Part Number	Inductance (μH)	Tolerance ($\pm\%$)	Test Frequency (KHz)	I _{rms} (A)Typ.	I _{sat} (A)Typ.	RDC ($\text{m}\Omega$)Max
MHCI06030-R10M-R8A	0.10	20	100	32.5	60	1.7
MHCI06030-R22M-R8A	0.22	20	100	23	34	3.0
MHCI06030-R68M-R8A	0.68	20	100	16	17	5.3
MHCI06030-1R0M-R8A	1.0	20	100	12	15	7.4
MHCI06030-1R2M-R8A	1.2	20	100	10	14	10
MHCI06030-1R5M-R8A	1.5	20	100	10	14	12.1
MHCI06030-2R2M-R8A	2.2	20	100	8	10	15
MHCI06030-3R3M-R8A	3.3	20	100	6.5	9.5	22
MHCI06030-4R7M-R8A	4.7	20	100	5.5	6.5	33
MHCI06030-6R8M-R8A	6.8	20	100	4.5	6	50
MHCI06030-100M-R8A	10	20	100	4	5.5	68

- I_{rms} DC current (A) that will cause an approximate ΔT of 40°C
- I_{sat} DC current (A) that will cause L to drop approximately 30%
- Tolerance : M= $\pm 20\%$
- L : WK 3260B, 100KHz 0.5V
- Rdc : CHEN HWA 502
- Operating temperature range from -55°C to 125°C. (Including self - temperature rise)

Test Instruments : WK3260B Impedance / Material Analyzer

Inductance vs DC Current

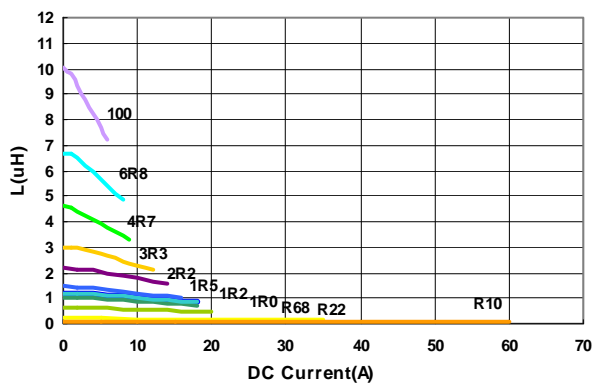

Temperature Change v.s DC Current

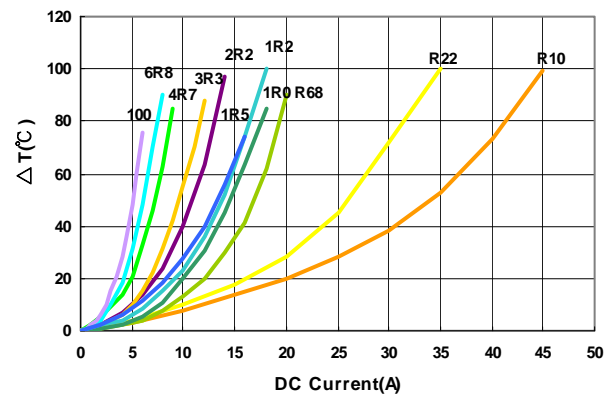

Electrical Characteristics

Part Number	Inductance (μH)	Tolerance ($\pm\%$)	Test Frequency (KHz)	I _{rms} (A)Typ.	I _{sat} (A)Typ.	RDC ($\text{m}\Omega$)Max
MHCC10030-R33M-R7A	0.33	20	100	23	32	1.6
MHCC10030-1R0M-R7A	1.0	20	100	15	21	6.0

- I_{rms} current (A) that will cause an approximate ΔT of 40°C
- I_{sat} current (A) that will cause L to drop approximately 30%
- Tolerance : M= $\pm 20\%$
- L : WK 3260B, 100KHz 0.5V
- R_{dc} : CHEN HWA 502
- Operating temperature range from -55°C to 125°C. (Including self - temperature rise)

Test Instruments : WK3260B Impedance / Material Analyzer

Inductance vs DC Current

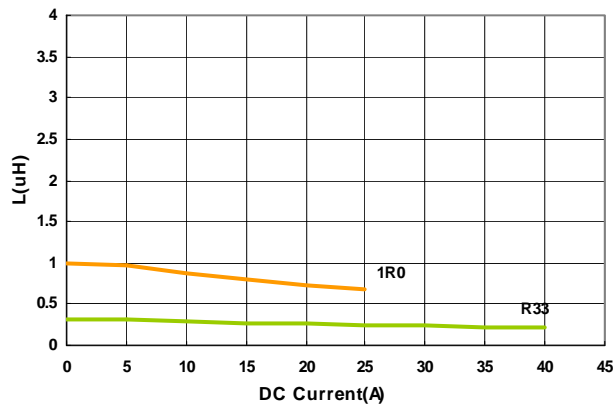

Temperature Change v.s DC Current

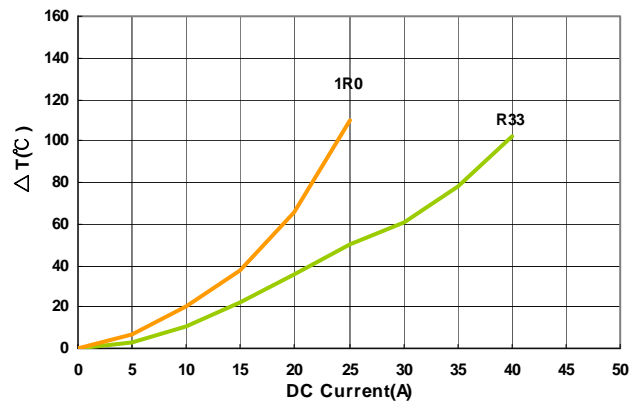

Molding Power Choke – MHCC/MHCI Series

Electrical Characteristics

Part Number	Inductance (μH)	Tolerance ($\pm\%$)	Test Frequency (KHz)	I _{rms} (A)Typ.	I _{sat} (A)Typ.	RDC (m Ω)Max
MHCC10040-R22M-R7	0.22	20	100	35	45	0.6
MHCC10040-R36M-R7	0.36	20	100	34	42	1.2
MHCC10040-R47M-R7	0.47	20	100	33	38	1.2
MHCC10040-R56M-R7	0.56	20	100	27	32	1.55
MHCC10040-R68M-R7	0.68	20	100	27	30	1.55
MHCC10040-1R0M-R7	1.0	20	100	20	26	3.1
MHCC10040-1R5M-R7	1.5	20	100	16	22	4.2
MHCC10040-1R8M-R7	1.8	20	100	15.3	16	5
MHCC10040-2R2M-R7	2.2	20	100	14	16	7
MHCC10040-3R3M-R7	3.3	20	100	11	12	13.2
MHCI10040-4R7M-R8	4.7	20	100	10	13	16.5
MHCC10040-6R8M-R7	6.8	20	100	6	10	25
MHCC10040-8R2M-R7	8.2	20	100	6	9	30
MHCC10040-100M-R7	10	20	100	6.5	7	30
MHCC10040-150M-R7	15	20	100	5	6	53
MHCC10040-220M-R7	22	20	100	4.5	4.5	64

- I_{rms} DC current (A) that will cause an approximate ΔT of 40°C
- I_{sat} DC current (A) that will cause L to drop approximately 30%
- Tolerance : M= $\pm 20\%$
- L : WK 3260B, 100KHz 0.5V
- R_{dc} : CHEN HWA 502
- Operating temperature range from -55°C to 125°C. (Including self - temperature rise)

Test Instruments : WK3260B Impedance / Material Analyzer

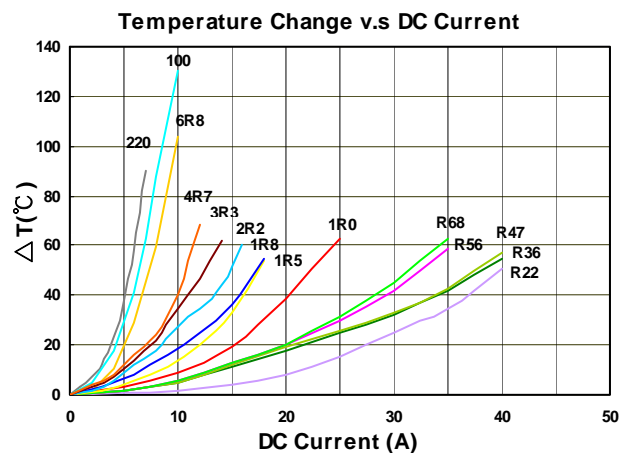
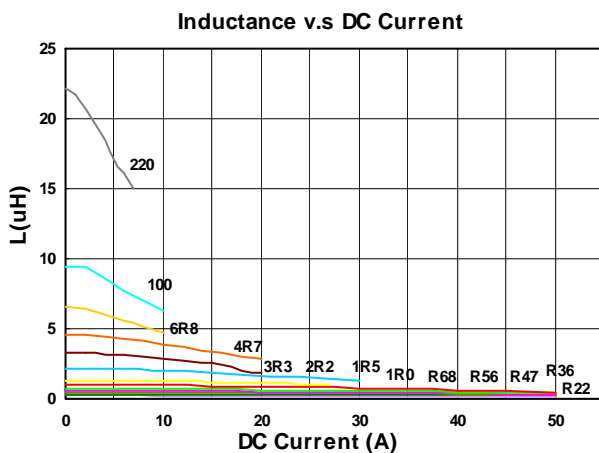

Electrical Characteristics

Part Number	Inductance (μH)	Tolerance ($\pm\%$)	Test Frequency (KHz)	I _{rms} (A)Typ.	I _{sat} (A)Typ.	RDC ($\text{m}\Omega$)Max
MHCC12035-1R0M-R7	1.0	20	100	27	28	2.5

- I_{rms} DC current (A) that will cause an approximate ΔT of 40°C
- I_{sat} DC current (A) that will cause L to drop approximately 20%
- Tolerance : M= $\pm 20\%$
- L : WK 3260B, 100KHz 0.5V
- R_{dc} : CHEN HWA 502
- Operating temperature range from -55°C to 125°C . (Including self - temperature rise)

Test Instruments : WK3260B Impedance / Material Analyzer

Inductance v.s DC Current

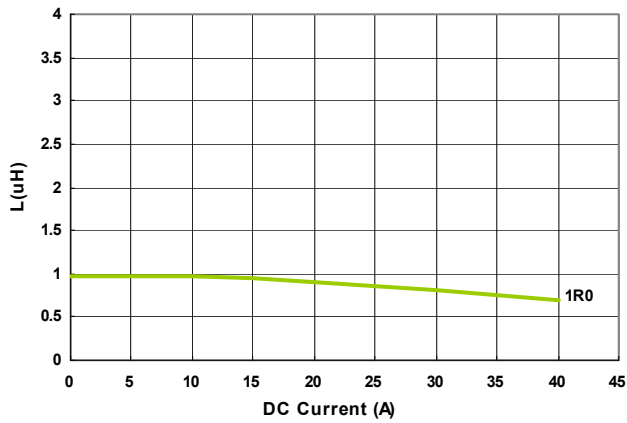

Temperature Change v.s DC Current

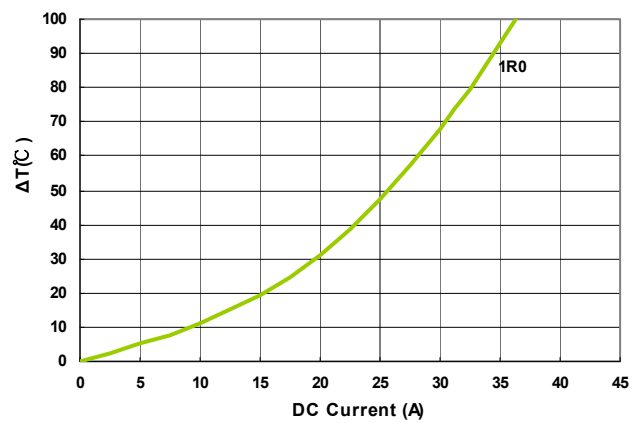

Electrical Characteristics

Part Number	Inductance (μH)	Tolerance ($\pm\%$)	Test Frequency (KHz)	I _{rms} (A)Typ.	I _{sat} (A)Typ.	RDC ($\text{m}\Omega$)Max
MHCC12050-R47M-R7	0.47	20	100	37	46	1.2
MHCC12050-1R0M-R7	1.0	20	100	29	37	2.5
MHCC12050-4R7M-R7	4.7	20	100	11	16	11.5
MHCC12050-6R8M-R7	6.8	20	100	9	14	22
MHCC12050-100M-R7	10	20	100	7	13	35

- I_{rms} current (A) that will cause an approximate ΔT of 40°C
- I_{sat} current (A) that will cause L to drop approximately 30%
- Tolerance : M= $\pm 20\%$
- L : WK 3260B, 100KHz 0.5V
- Rdc : CHEN HWA 502
- Operating temperature range from -55°C to 125°C. (Including self - temperature rise)

Test Instruments : WK3260B Impedance / Material Analyzer

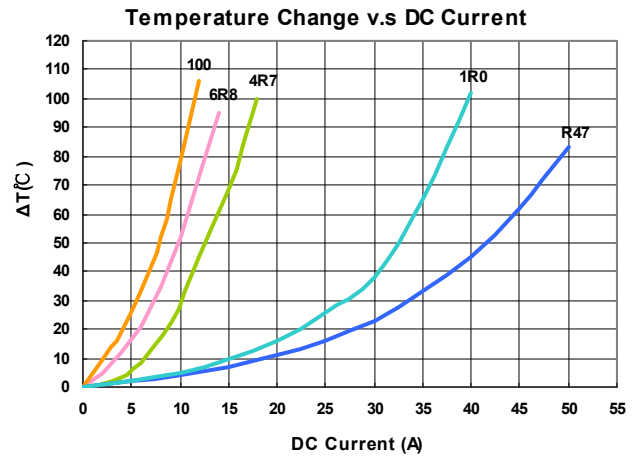
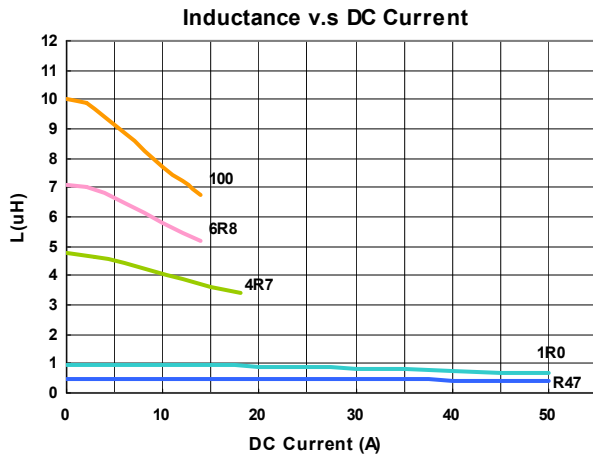

Electrical Characteristics

Part Number	Inductance (uH)	Tolerance (±%)	Test Frequency (KHz)	I _{rms} (A)Typ.	I _{sat} (A)Typ.	RDC (mΩ)Max
MHCC12060-100M-R7A	10	20	100	10	12.5	20.7
MHCC12060-150M-R7A	15	20	100	6.0	9.0	29.0
MHCC12060-220M-R7A	22	20	100	5.0	7.5	39.5
MHCC12060-330M-R7A	33	20	100	4.0	6.0	75
MHCC12060-680M-R7A	68	20	100	3.0	4.5	140

- I_{rms} current (A) that will cause an approximate ΔT of 40°C
- I_{sat} current (A) that will cause L to drop approximately 30%
- Tolerance : M= ±20%
- L : WK 3260B, 100KHz 0.5V
- Rdc : CHEN HWA 502
- Operating temperature range from -55°C to 125°C. (Including self - temperature rise)

Test Instruments : WK3260B Impedance / Material Analyzer

Inductance vs DC Current

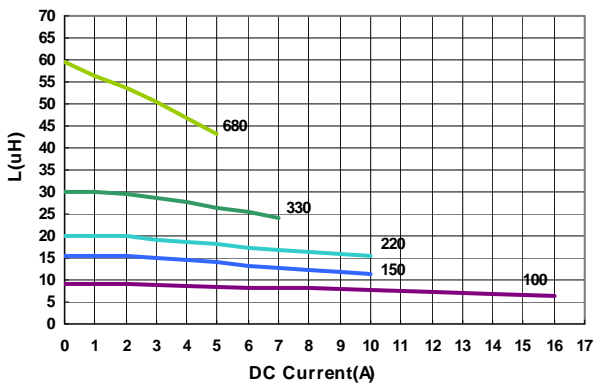

Temperature Change v.s DC Current

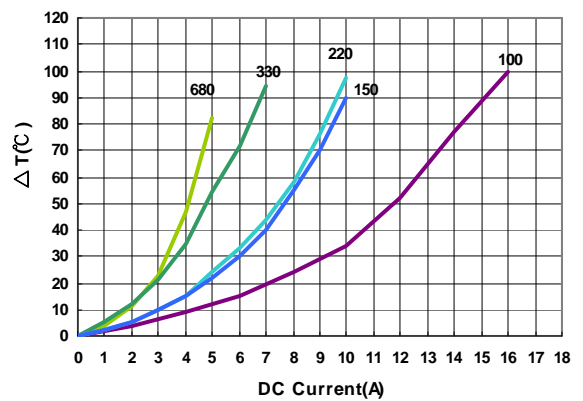

Packaging Specifications

Tape Dimensions

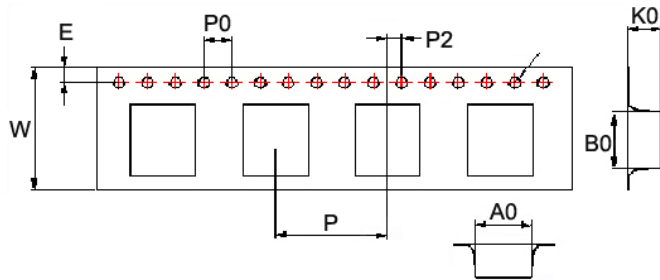

Tape Material

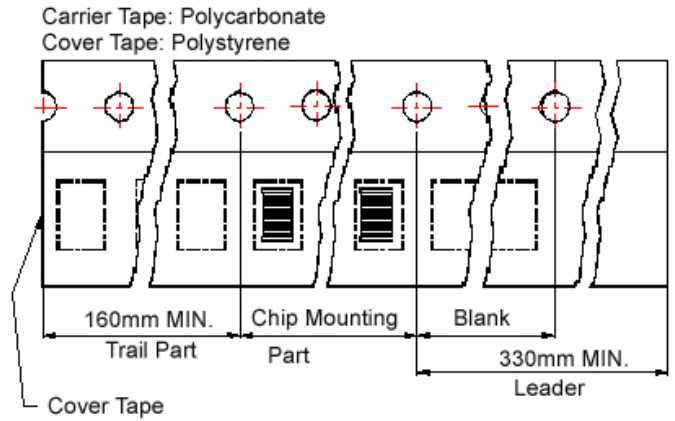

Reel Dimensions

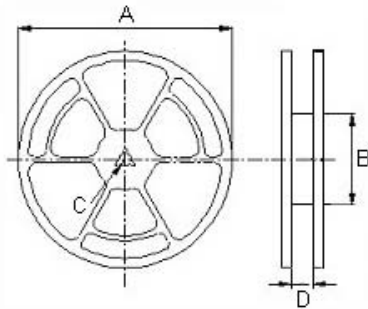

Dimensions in mm

TYPE	Tape Dimensions									Reel Dimensions				Quantity
	A0	B0	K0	D	E	W	P	P0	P2	A	B	C	D	PCS / REEL
04012	4.6	5.0	1.5	1.55	1.75	12	8	4	2	330	100	13	13.4	2000
04015	4.4	4.9	1.8	1.55	1.75	12	8	4	2	330	100	13	13.4	2000
04020	4.3	4.9	2.4	1.55	1.75	12	8	4	2	330	100	13	13.4	2000
05012	5.9	6.2	1.5	1.55	1.75	16	12	4	2	330	100	13	17.4	1000
05015	5.9	6.2	1.9	1.55	1.75	16	12	4	2	330	100	13	17.4	1000
05018	5.9	6.2	2.2	1.55	1.75	16	12	4	2	330	100	13	17.4	1000
05020	5.9	6.2	2.4	1.55	1.75	16	12	4	2	330	100	13	17.4	1000
05030	5.9	6.2	3.4	1.55	1.75	16	12	4	2	330	100	13	17.4	1000
06012	6.9	7.6	1.6	1.55	1.75	16	12	4	2	330	100	13	17.4	1000
06015	6.9	7.6	1.9	1.55	1.75	16	12	4	2	330	100	13	17.4	1000
06018	6.9	7.6	2.2	1.55	1.75	16	12	4	2	330	100	13	17.4	1000
06024	6.9	7.6	2.9	1.55	1.75	16	12	4	2	330	100	13	17.4	1000
06030	6.9	7.6	3.4	1.55	1.75	16	12	4	2	330	100	13	17.4	1000
10030	10.6	11.7	3.25	1.55	1.75	24	16	4	2	330	100	13	24.4	500
10040	10.6	11.7	4.25	1.55	1.75	24	16	4	2	330	100	13	24.4	500
12035	13	14	3.7	1.55	1.75	24	16	4	2	330	100	13	24.4	500
12050	13	14	5.25	1.55	1.75	24	16	4	2	330	100	13	24.4	500
12060	13	14	6.25	1.55	1.75	24	16	4	2	330	100	13	24.4	500



MHCB Series



MHCB series is designed for low profile type with low RDC and ultra large current. Its molded magnetic shielded type is suitable for high-density mounting and ultra low buzz noise. Soldering conditions can be easily confirmed when mounting onto the board. This series also provides customers with embossed carrier type packaging for automatic mounting machine.

Features

- RoHS compliant
- Low profile type
- Shielded construction
- Ultra low buzz noise due to molding construction

Applications

- High density DC/DC converters
- POL converters
- High current VRM/VRD for notebook / Server / desktop CPUs
- High speed charger
- For thickness less than 1.2mm, suitable for low profile applications e.g., Ultra thin NB/Monitor/TV/Tablet

Product Identification

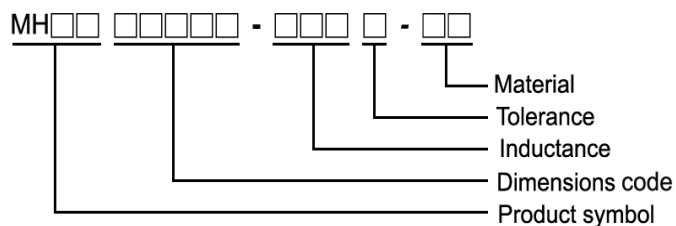

Shape and Dimensions

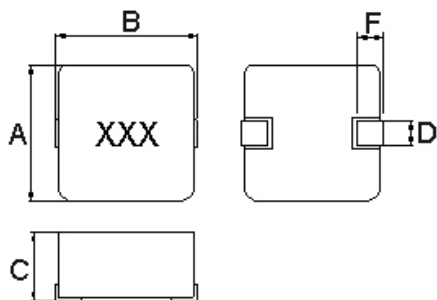

Dimensions in mm

TYPE	A	B	C	D	F
06030	6.6±0.2	6.95±0.35	2.8±0.2	3.0±0.3	1.6±0.5

Recommended Pattern

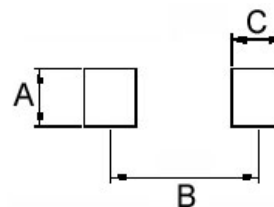

Dimensions in mm

TYPE	A	B	C
06030	3.5	6.05	2.35

Electrical Characteristics

Part Number	Inductance (μH)	Tolerance ($\pm\%$)	Test Frequency (KHz)	I _{rms} (A)Typ.	I _{sat} (A)Typ.	RDC ($\text{m}\Omega$)Max
MHCB06030-R10M-C1	0.10	20	100	32.5	60	1.7
MHCB06030-R68M-C1	0.68	20	100	15.5	25	5.5
MHCB06030-R82M-C1	0.82	20	100	13.0	24	8.0
MHCB06030-1R0M-C1	1.0	20	100	11.0	22	10
MHCB06030-1R5M-C1	1.50	20	100	9.0	18	15
MHCB06030-2R2M-C1	2.2	20	100	8.0	14	20
MHCB06030-3R3M-C1	3.3	20	100	6.0	13.5	30
MHCB06030-4R7M-C1	4.7	20	100	5.5	10.0	40
MHCB06030-6R8M-C1	6.8	20	100	4.5	8.0	60

- I_{rms} DC current (A) that will cause an approximate ΔT of 40°C
- I_{sat} DC current (A) that will cause L to drop approximately 20%
- Tolerance : M= $\pm 20\%$
- L : WK 3260B, 100KHz 0.5V
- Rdc : CHEN HWA 502
- Operating temperature range from -55°C to 125°C. (Including self - temperature rise)

Test Instruments : WK3260B Impedance / Material Analyzer

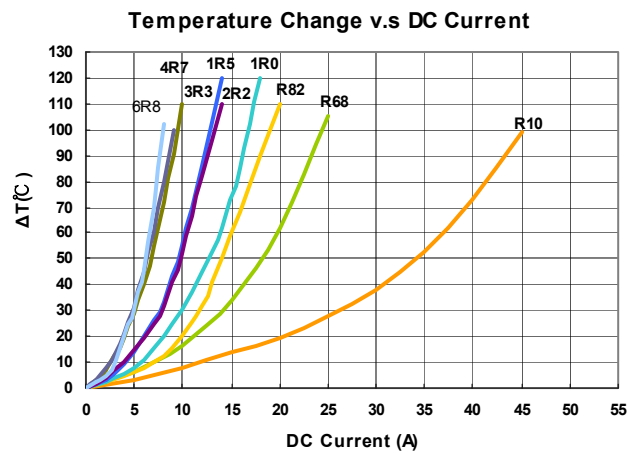
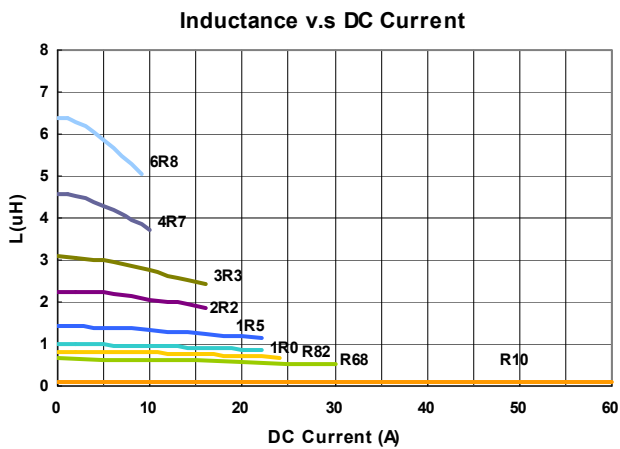

Packaging Specifications

Tape Dimensions

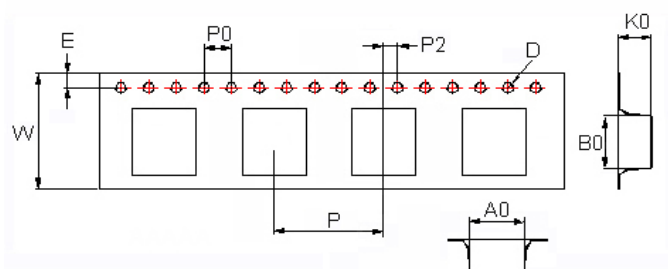

Tape Material

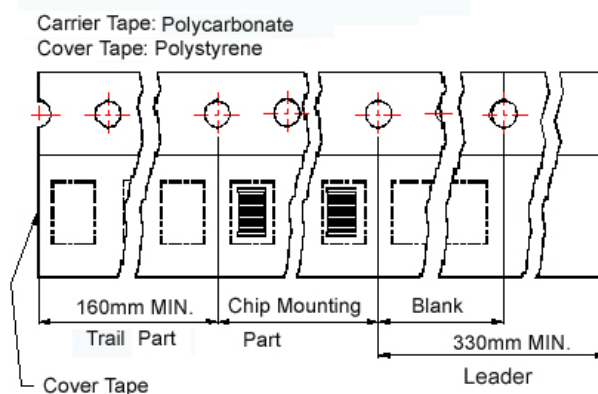

Reel Dimensions

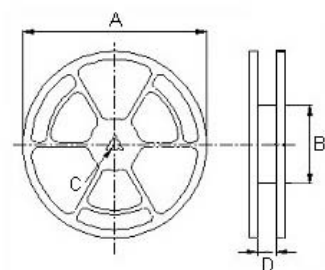

Dimensions in mm

TYPE	Tape Dimensions									Reel Dimensions				Quantity
	A0	B0	K0	D	E	W	P	P0	P2	A	B	C	D	PCS / REEL
06030	6.9	7.6	3.4	1.55	1.75	16	12	4	2	330	100	13	17.4	1000

MHSC Series



MHSC series is designed for low profile type with low DCR and ultra large current, especially for height limited boards. Its molded magnetic shielded type is suitable for high-density mounting and ultra low buzz noise. Soldering conditions can be easily confirmed when mounting onto board. This series also provides customers with embossed carrier type packaging for automatic mounting machine.

Features

- RoHS compliant
- Ultra low profile on board
- Shielded construction
- Ultra low buzz noise due to molding construction

Applications

- High density DC/DC converter in height limited board
- POL converters
- High current VRM/VDR for notebook / server / desktop CPU
- High current DC/DC converter in distributed power system
- High speed charger

Product Identification

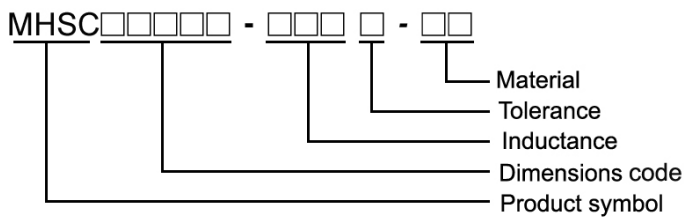

Shape and Dimensions

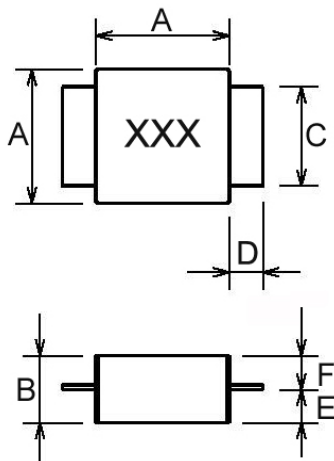

Dimensions in mm

TYPE	A	B	C	D	E	F
04020	4.2±0.2	2.0 ^{+0.2} _{-0.3}	1.5±0.2	1.2±0.3	1.2	1.0
06022	6.6±0.2	2.2 ^{+0.2} _{-0.3}	3.0±0.2	1.5±0.3	1.4	1.0
06036	6.6±0.2	3.6 ^{+0.2} _{-0.3}	3.0±0.2	1.5±0.3	2.3	1.5
08036	8.0±0.2	3.6 ^{+0.2} _{-0.3}	6.0±0.2	2.0±0.3	2.3	1.3±0.2

Recommended Pattern

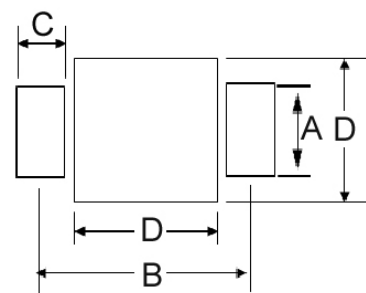

Dimensions in mm

TYPE	A	B	C	D
04020	2.0	6.5	1.8	4.5
06022	3.5	9.5	2.2	6.9
06036	3.5	9.5	2.2	6.9
08036	6.0	11.9	3.0	8.4

Electrical Characteristics

Part Number	Inductance (μH)	Tolerance ($\pm\%$)	Test Frequency (KHz)	I _{rms} (A)Typ.	I _{sat} (A)Typ.	RDC ($\text{m}\Omega$)Max
MHSC04020-R33M-R8	0.33	20	100	8.5	16	10
MHSC04020-R47M-R8	0.47	20	100	8	14	11

- I_{rms} DC current (A) that will cause an approximate ΔT of 40°C
- I_{sat} DC current (A) that will cause L to drop approximately 30%
- Tolerance : M= $\pm 20\%$
- L : WK 3260B, 100KHz 0.5V
- R_{dc} : CHEN HWA 502
- Operating temperature range from -55°C to 125°C . (Including self - temperature rise)

Test Instruments : WK3260B Impedance / Material Analyzer

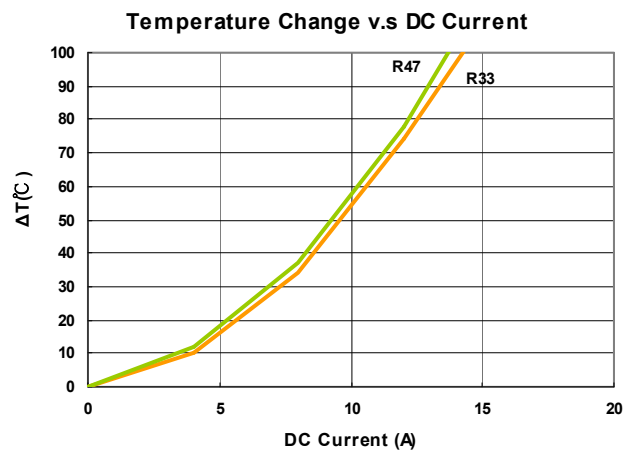
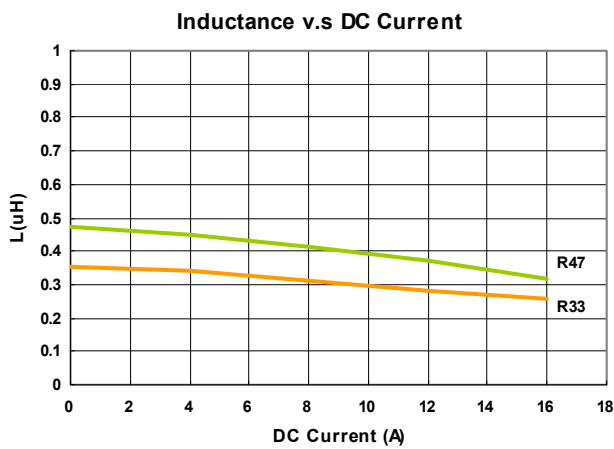

Electrical Characteristics

Part Number	Inductance (μH)	Tolerance ($\pm\%$)	Test Frequency (KHz)	I _{rms} (A)Typ.	I _{sat} (A)Typ.	RDC ($\text{m}\Omega$)Max
MHSC06022-R22M-R8	0.22	20	100	18	28	6
MHSC06022-R82M-R8	0.82	20	100	9.5	18	13.8
MHSC06022-1R0M-R8	1.0	20	100	9	16	15.4
MHSC06022-2R2M-R8	2.2	20	100	6	10.5	29.8

- I_{rms} DC current (A) that will cause an approximate ΔT of 40°C
- I_{sat} DC current (A) that will cause L to drop approximately 30%
- Tolerance : M= $\pm 20\%$
- L : WK 3260B, 100KHz 0.5V
- R_{dc} : CHEN HWA 502
- Operating temperature range from -55°C to 125°C . (Including self - temperature rise)

Test Instruments : WK3260B Impedance / Material Analyzer

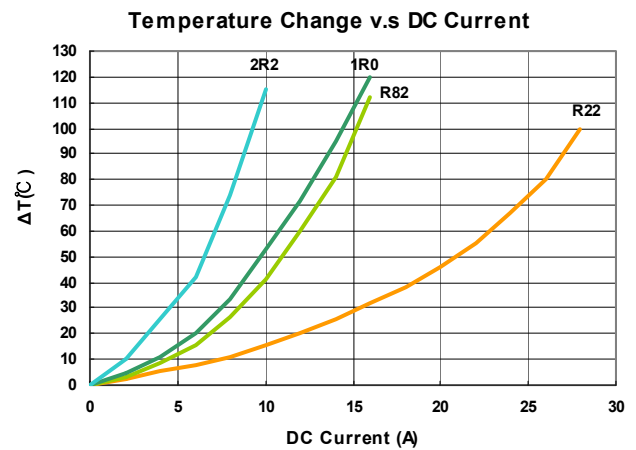
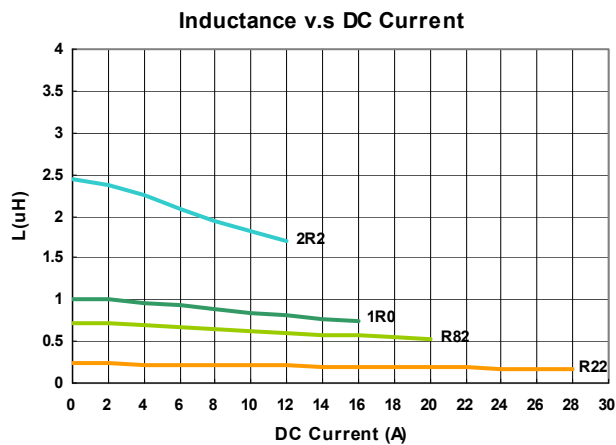

Electrical Characteristics

Part Number	Inductance (μH)	Tolerance ($\pm\%$)	Test Frequency (KHz)	I _{rms} (A)Typ.	I _{sat} (A)Typ.	RDC ($\text{m}\Omega$)Max
MHSC06036-R82M-R8	0.82	20	100	14	20	6.8
MHSC06036-1R0M-R8	1.0	20	100	12	19	8.2
MHSC06036-2R2M-R8	2.2	20	100	9.5	14	14.5
MHSC06036-6R8M-R8	6.8	20	100	5.5	7	44.5
MHSC06036-100M-R8	10	20	100	4.5	6.5	66

- I_{rms} DC current (A) that will cause an approximate ΔT of 40°C
- I_{sat} DC current (A) that will cause L to drop approximately 30%
- Tolerance : M= $\pm 20\%$
- L : WK 3260B, 100KHz 0.5V
- Rdc : CHEN HWA 502
- Operating temperature range from -55°C to 125°C . (Including self - temperature rise)

Test Instruments : WK3260B Impedance / Material Analyzer

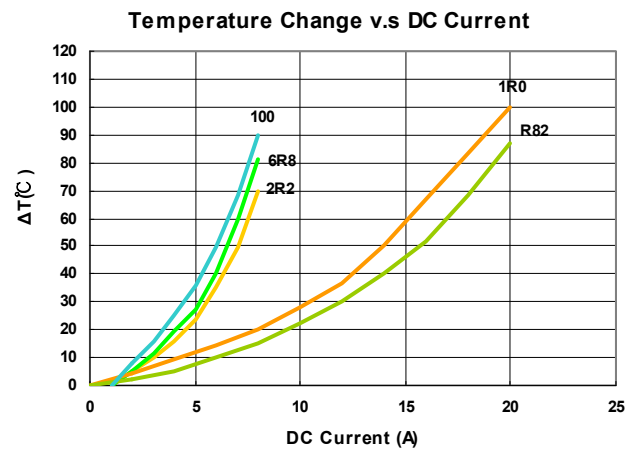
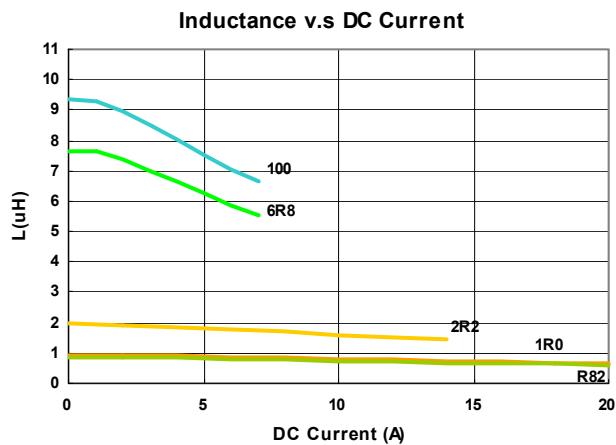

Electrical Characteristics

Part Number	Inductance (μH)	Tolerance ($\pm\%$)	Test Frequency (KHz)	I _{rms} (A)Typ.	I _{sat} (A)Typ.	RDC ($\text{m}\Omega$)Max
MHSC08036-R22M-R8	0.22	20	100	23	40	1.6
MHSC08036-R33M-R8	0.33	20	100	20	38	2.5

- I_{rms} DC current (A) that will cause an approximate ΔT of 40°C
- I_{sat} DC current (A) that will cause L to drop approximately 30%
- Tolerance : M= $\pm 20\%$
- L : WK 3260B, 100KHz 0.5V
- R_{dc} : CHEN HWA 502
- Operating temperature range from -55°C to 125°C . (Including self - temperature rise)

Test Instruments : WK3260B Impedance / Material Analyzer

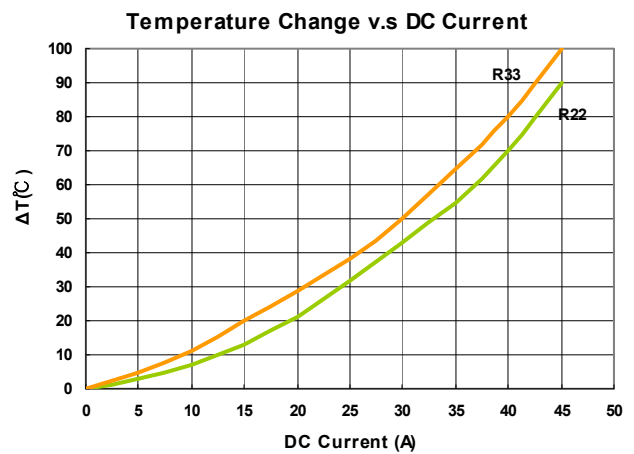
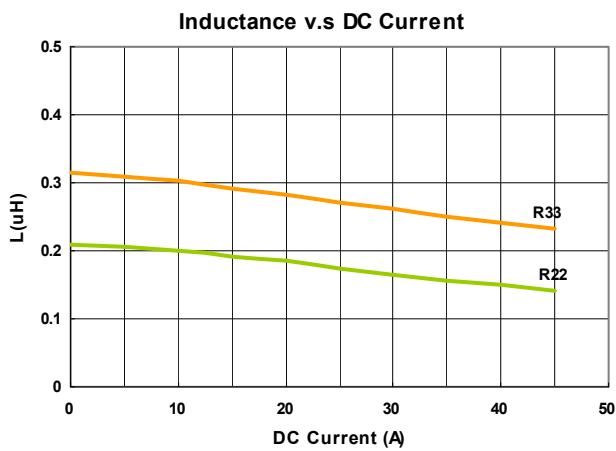

Packaging Specifications

Tape Dimensions

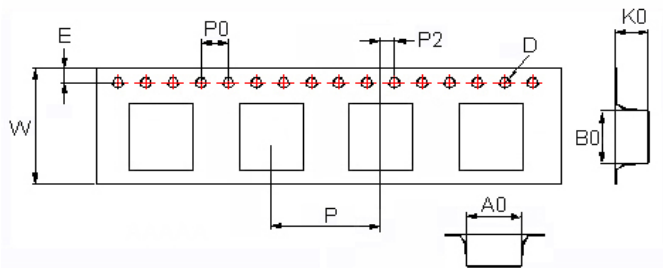

Tape Material

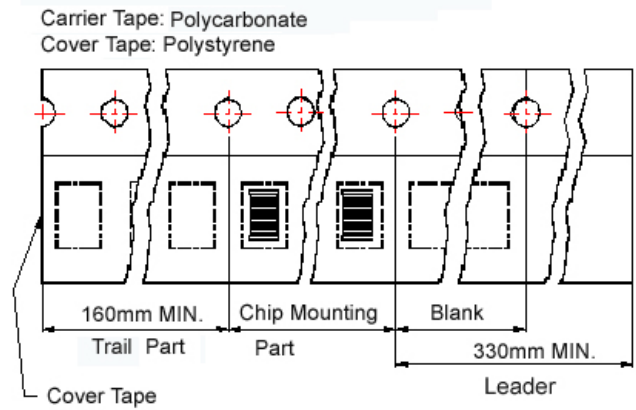

Reel Dimensions

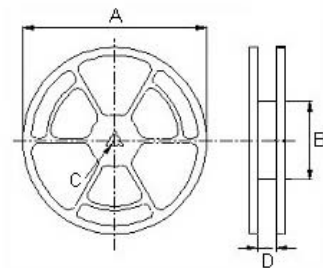

Dimensions in mm

TYPE	Tape Dimensions									Reel Dimensions				Quantity
	A0	B0	K0	D	E	W	P	P0	P2	A	B	C	D	PCS / REEL
04020	4.6	7.2	2.4	1.55	1.75	16	12	4	2	330	100	13	16.0	1000
06022	6.9	10.2	2.6	1.55	1.75	16	12	4	2	330	100	13	16.0	1000
06036	6.9	10.2	4.0	1.55	1.75	16	12	4	2	330	100	13	16.0	1000
08036	8.4	12.6	4.0	1.55	1.75	24	16	4	2	330	100	13	24.4	500

LVS Series



LVS series, an automatic assembly constructed power inductor, is shielded with magnetic resin and suitable for the portable DC-DC converter applications.

Features

- RoHS compliant
- Highly accurate dimensions
- Terminals are highly resistant to external forces
- Highly reliable in environments of sudden temperature change and humidity
- Superior EMI characteristics with ultra low radiation comparing to conventional shielded power inductors

Applications

- LCD TV
- Monitor
- Ap router
- STB and smart phone
- Touch panel
- DSC
- Game console and other electronic devices

Product Identification

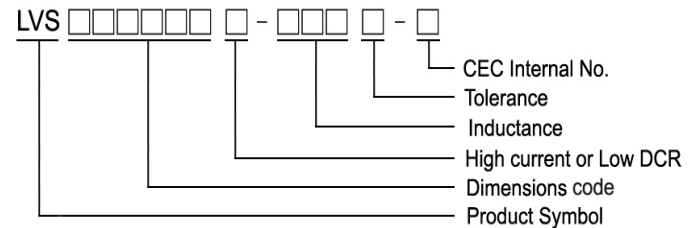
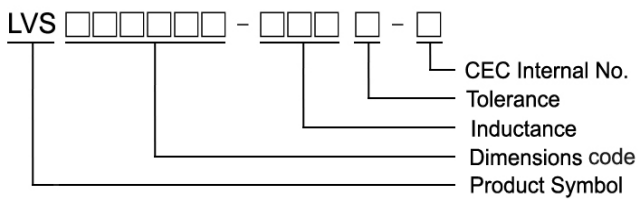

Shape and Dimensions

Figure 1

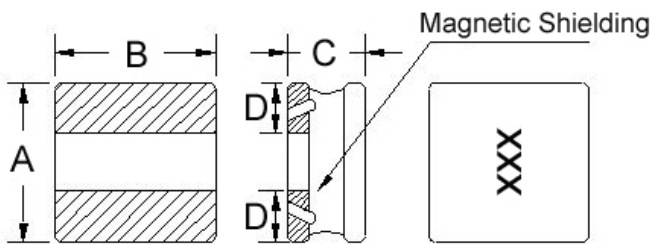

Recommended Pattern

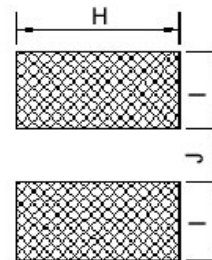

Dimensions in mm

TYPE	FIG	A	B	C	D	H	I	J
LVS404012	2	4.0±0.2	4.0±0.2	1.20±0.1	1.5	4.2	1.5	1.2

Shape and Dimensions

Recommended Pattern

Figure 2

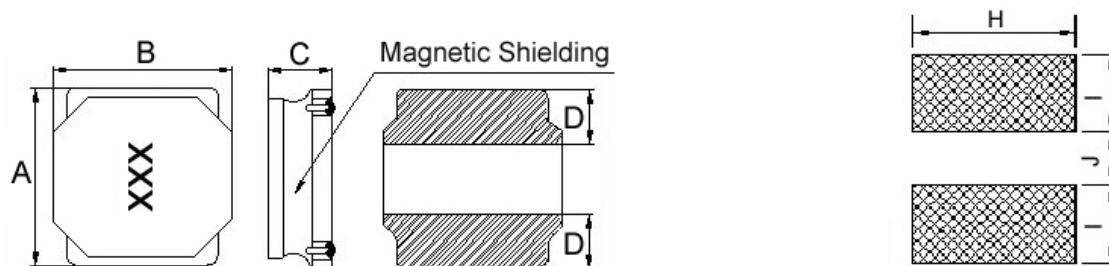

Dimensions in mm

TYPE	FIG	A	B	C	D	H	I	J
LVS404018	2	4.0±0.2	4.0±0.2	1.8 ^{+0.2} _{-0.30}	1.3±0.3	3.7	1.2	1.6
LVS404026	2	4.0±0.2	4.0±0.2	2.6±0.2	1.4	3.7	1.2	1.6
LVS606028	2	6.0±0.2	6.0±0.2	2.8 ^{+0.2} _{-0.30}	1.9±0.3	5.7	1.6	2.9

Shape and Dimensions

Recommended Pattern

Figure 3

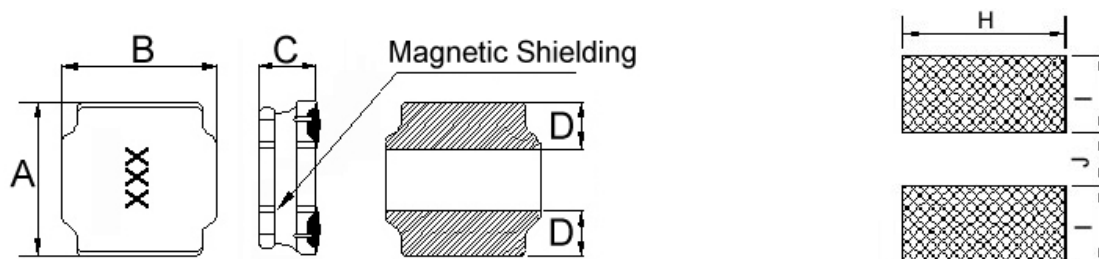

Dimensions in mm

TYPE	FIG	A	B	C	D	H	I	J
LVS505020	3	5.0±0.2	5.0±0.2	2.0 ^{+0.2} _{-0.30}	1.8±0.3	4.0	1.5	2.1
LVS505040	3	5.0±0.2	5.0±0.2	4.0 ^{+0.2} _{-0.30}	1.6±0.3	4.0	1.5	2.1
LVS606020	3	6.0±0.2	6.0±0.2	2.0 ^{+0.2} _{-0.30}	1.7±0.3	5.7	1.6	2.9
LVS606045	3	6.0±0.2	6.0±0.2	4.5 ^{+0.2} _{-0.30}	1.8±0.3	5.7	2.0	2.4
LVS606045L	3	6.0±0.2	6.0±0.2	4.5 ^{+0.2} _{-0.30}	1.8±0.3	5.7	2.0	2.4
LVS808040	3	8.0±0.2	8.0±0.2	4.0 ^{+0.2} _{-0.30}	2.3±0.3	7.5	2.5	3.4
LVS808040L	3	8.0±0.2	8.0±0.2	4.0 ^{+0.2} _{-0.30}	2.3±0.3	7.5	2.5	3.4

Electrical Characteristics

Part Number	Inductance (uH)	Test Frequency (KHz)	Tolerance (±%)	RDC (mΩ) ±30%	Isat (A) Typ. (Max)	Irms (A) Typ. (Max)	Marking
LVS404012-1R0□-N	1.0	100	30	48	2.50(2.25)	1.70(1.53)	1R0
LVS404012-1R5□-N	1.5	100	30	58	2.10(1.89)	1.60(1.44)	1R5
LVS404012-2R2□-N	2.2	100	20, 30	65	1.70(1.53)	1.50(1.35)	2R2
LVS404012-3R3□-N	3.3	100	20, 30	90	1.30(1.17)	1.40(1.26)	3R3
LVS404012-4R7□-N	4.7	100	20, 30	110	1.10(0.99)	1.20(1.08)	4R7
LVS404012-6R8□-N	6.8	100	20, 30	135	0.90(0.81)	1.05(0.94)	6R8
LVS404012-100□-N	10	100	20, 30	190	0.78(0.70)	0.90(0.81)	100
LVS404012-150□-N	15	100	20, 30	250	0.65(0.58)	0.85(0.76)	150
LVS404012-220□-N	22	100	20, 30	400	0.52(0.46)	0.75(0.67)	220
LVS404012-330□-N	33	100	20, 30	600	0.44(0.39)	0.70(0.63)	330
LVS404012-470□-N	47	100	20, 30	930	0.35(0.31)	0.50(0.45)	470

- When ordering, please specify tolerance and packaging codes
- Tolerance : M = ±20% , T = ±30%
- L : Agilent/HP 4284A + Agilent/HP 16334A, 100KHz with 1V
- Isat & I rms : Agilent/HP 4284A, 100KHz with 1V
- Rdc : Digital Milliohm Meter Chroma 16502, or equivalent
- Isat for Inductance drop 30% from its value without current
- I rms for a 40°C rise above 25°C ambient
- Operating temperature range from -55°C to 125°C. (Including self - temperature rise)

Test Instruments : HP4284A Material/Impedance Analyzer

Inductance vs. DC Current

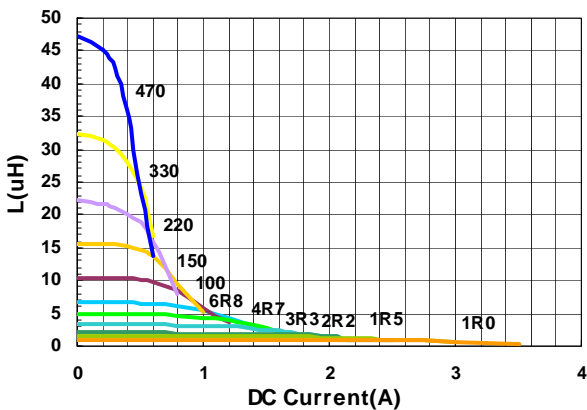

Temperature Change vs. DC Current

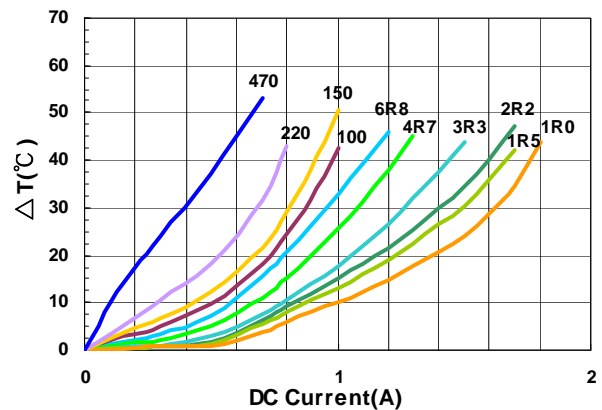

Electrical Characteristics

Part Number	Inductance (uH)	Test Frequency (KHz)	Tolerance (±%)	RDC (mΩ) ±20%	Isat (A) Typ. (Max)	Irms (A) Typ. (Max)	Marking
LVS404018-1R0□-N	1.0	100	20, 30	32	4.10(3.69)	2.80(2.52)	1R0
LVS404018-1R5□-N	1.5	100	20, 30	40	3.30(2.97)	2.60(2.34)	1R5
LVS404018-1R8□-N	1.8	100	20, 30	55	2.80(2.50)	2.50(2.20)	1R8
LVS404018-2R2□-N	2.2	100	20, 30	60	2.80(2.52)	2.50(2.25)	2R2
LVS404018-2R3□-N	2.3	100	20, 30	60	2.80(2.52)	2.50(2.25)	2R3
LVS404018-3R3□-N	3.3	100	20, 30	70	2.20(1.98)	2.10(1.89)	3R3
LVS404018-3R6□-N	3.6	100	20, 30	75	2.10(1.89)	1.90(1.71)	3R6
LVS404018-3R9□-N	3.9	100	20, 30	75	2.10(1.89)	1.90(1.71)	3R9
LVS404018-4R7□-N	4.7	100	20, 30	90	2.00(1.80)	1.70(1.53)	4R7
LVS404018-6R8□-N	6.8	100	20, 30	110	1.60(1.44)	1.50(1.35)	6R8
LVS404018-100□-N	10	100	20, 30	170	1.40(1.26)	1.20(1.08)	100
LVS404018-150□-N	15	100	20, 30	250	1.00(0.90)	1.00(0.90)	150
LVS404018-220□-N	22	100	20, 30	350	0.90(0.81)	0.85(0.76)	220
LVS404018-330□-N	33	100	20, 30	530	0.80(0.72)	0.70(0.63)	330
LVS404018-470□-N	47	100	20, 30	720	0.70(0.63)	0.56(0.50)	470
LVS404018-680□-N	68	100	20, 30	1000	0.56(0.50)	0.45(0.40)	680
LVS404018-101□-N	100	100	20, 30	1500	0.46(0.41)	0.38(0.34)	101
LVS404018-151□-N	150	100	20, 30	2500	0.35(0.31)	0.30(0.27)	151
LVS404018-221□-N	220	100	20, 30	4000	0.28(0.25)	0.23(0.20)	221

- When ordering, please specify tolerance and packaging codes
- Tolerance : M = ±20% , T = ±30%
- L : Agilent/HP 4284A + Agilent/HP 16334A, 100KHz with 1V
- Isat & I rms : Agilent/HP 4284A, 100KHz with 1V
- Rdc : Digital Milliohm Meter Chroma 16502, or equivalent
- Isat for Inductance drop 30% from its value without current
- I rms for a 40°C rise above 25°C ambient
- Operating temperature range from -55°C to 125°C. (Including self - temperature rise)

Test Instruments : HP4284A Material/Impedance Analyzer

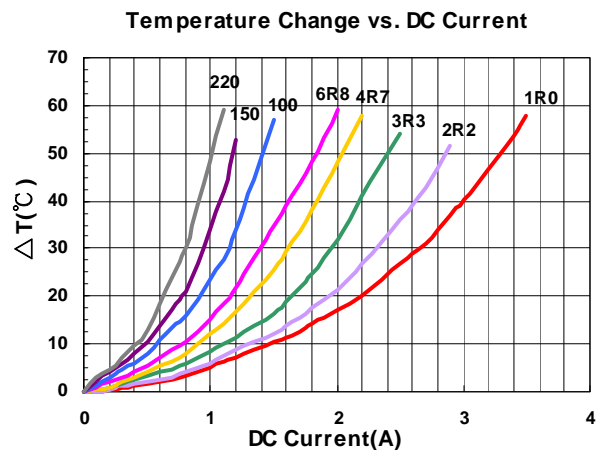
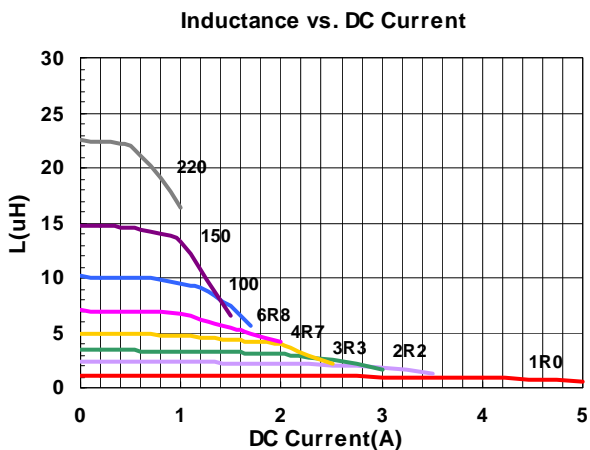

Electrical Characteristics

Part Number	Inductance (uH)	Test Frequency (KHz)	Tolerance (±%)	RDC (mΩ) ±30%	Isat (A) Typ. (Max)	Irms (A) Typ. (Max)	Marking
LVS404026-1R2□-N	1.2	100	20, 30	30	3.50(3.15)	3.30(2.97)	1R2
LVS404026-3R3□-N	3.3	100	20, 30	45	2.50(2.25)	2.50(2.25)	3R3
LVS404026-4R7□-N	4.7	100	20, 30	60	1.80(1.62)	1.80(1.62)	4R7
LVS404026-220□-N	22	100	20, 30	230	0.86(0.77)	1.00(0.90)	220

- When ordering, please specify tolerance and packaging codes
- Tolerance : M = ±20% , T = ±30%
- L : Agilent/HP 4284A + Agilent/HP 16334A, 100KHz with 1V
- Isat & Irms : Agilent/HP 4284A , 100KHz with 1V
- Rdc : Digital Milliohm Meter Chroma 16502, or equivalent
- Isat for Inductance drop 30% from its value without current
- Irms for a 40°C rise above 25°C ambient
- Operating temperature range from -55°C to 125°C. (Including self - temperature rise)

Test Instruments : HP4284A Material/Impedance Analyzer

Inductance vs. DC Current

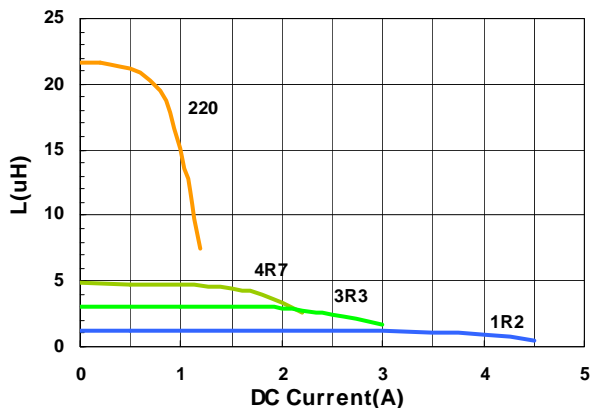

Temperature Change vs. DC Current

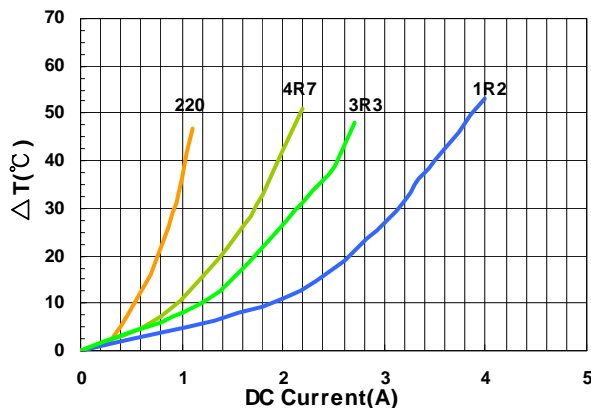

Electrical Characteristics

Part Number	Inductance (uH)	Test Frequency (KHz)	Tolerance (±%)	RDC (mΩ) ±20%	Isat (A) Typ. (Max)	Irms (A) Typ. (Max)	Marking
LVS505020-1R0□-N	1.0	100	30	21	5.1(4.59)	4.0(3.60)	1R0
LVS505020-1R2□-N	1.2	100	30	21	4.8(4.32)	3.8(3.42)	1R2
LVS505020-1R5□-N	1.5	100	30	26	4.2(3.78)	3.5(3.15)	1R5
LVS505020-2R2□-N	2.2	100	20, 30	35	3.4(3.06)	3.2(2.88)	2R2
LVS505020-3R3□-N	3.3	100	20, 30	48	3.0(2.70)	2.8(2.52)	3R3
LVS505020-4R7□-N	4.7	100	20, 30	60	2.2(1.98)	2.2(1.98)	4R7
LVS505020-5R6□-N	5.6	100	20, 30	82	2.05(1.84)	2.0(1.80)	5R6
LVS505020-6R8□-N	6.8	100	20, 30	90	2.0(1.80)	1.8(1.62)	6R8
LVS505020-100□-N	10	100	20, 30	120	1.6(1.44)	1.6(1.44)	100
LVS505020-150□-N	15	100	20, 30	190	1.3(1.17)	1.2(1.08)	150
LVS505020-220□-N	22	100	20, 30	260	1.0(0.90)	1.0(0.90)	220
LVS505020-330□-N	33	100	20, 30	460	0.8(0.72)	0.75(0.67)	330
LVS505020-470□-N	47	100	20, 30	580	0.65(0.58)	0.65(0.60)	470

- When ordering, please specify tolerance and packaging codes
- Tolerance : M = ±20% , T = ±30%
- L : Agilent/HP 4284A + Agilent/HP 16334A, 100KHz with 1V
- Isat & Irms : Agilent/HP 4284A, 100KHz with 1V
- Rdc : Digital Milliohm Meter Chroma 16502, or equivalent
- Isat for Inductance drop 30% from its value without current
- Irms for a 40°C rise above 25°C ambient
- Operating temperature range from -55°C to 125°C. (Including self - temperature rise)

Test Instruments : HP4284A Material/Impedance Analyzer

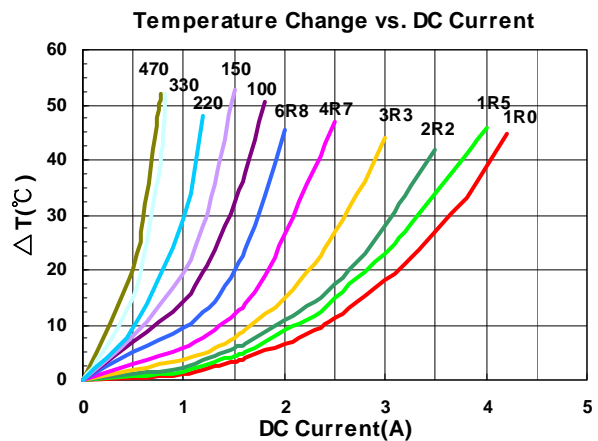
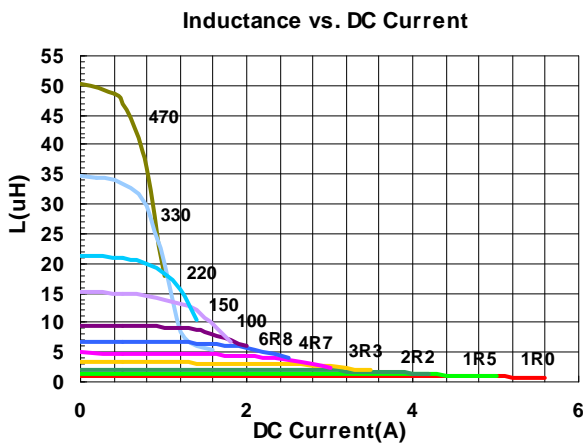

Electrical Characteristics

Part Number	Inductance (uH)	Test Frequency (KHz)	Tolerance (±%)	RDC (mΩ) ±30%	Isat (A) Typ. (Max)	Irms (A) Typ. (Max)	Marking
LVS505040-1R0□-N	1.0	100	30	14	7.5(6.75)	4.6(4.14)	1R0
LVS505040-1R2□-N	1.2	100	30	15	7.4(6.66)	4.5(4.05)	1R2
LVS505040-1R5□-N	1.5	100	30	16	7.1(6.39)	4.4(3.96)	1R5
LVS505040-2R2□-N	2.2	100	20, 30	21	5.7(5.13)	3.7(3.33)	2R2
LVS505040-3R3□-N	3.3	100	20, 30	26	4.8(4.32)	3.5(3.15)	3R3
LVS505040-4R7□-N	4.7	100	20, 30	32	4.2(3.78)	3.2(2.88)	4R7
LVS505040-6R8□-N	6.8	100	20, 30	50	3.3(2.97)	2.4(2.16)	6R8
LVS505040-100□-N	10	100	20, 30	60	2.8(2.52)	2.2(1.98)	100
LVS505040-150□-N	15	100	20, 30	90	2.3(2.07)	1.8(1.62)	150
LVS505040-220□-N	22	100	20, 30	135	1.8(1.62)	1.4(1.26)	220
LVS505040-270□-N	27	100	20, 30	180	1.6(1.44)	1.2(1.08)	270
LVS505040-330□-N	33	100	20, 30	190	1.5(1.35)	1.1(0.99)	330
LVS505040-470□-N	47	100	20, 30	310	1.2(1.08)	0.9(0.81)	470
LVS505040-101□-N	100	100	20, 30	800	0.7(0.60)	0.6(0.50)	101

- When ordering, please specify tolerance and packaging codes
- Tolerance : M = ±20% , T = ±30%
- L : Agilent/HP 4284A + Agilent/HP 16334A, 100KHz with 1V
- Isat & I rms : Agilent/HP 4284A, 100KHz with 1V
- Rdc : Digital Milliohm Meter Chroma 16502, or equivalent
- Isat for Inductance drop 30% from its value without current
- I rms for a 40°C rise above 25°C ambient
- Operating temperature range from -55°C to 125°C. (Including self - temperature rise)

Test Instruments : HP4284A Material/Impedance Analyzer

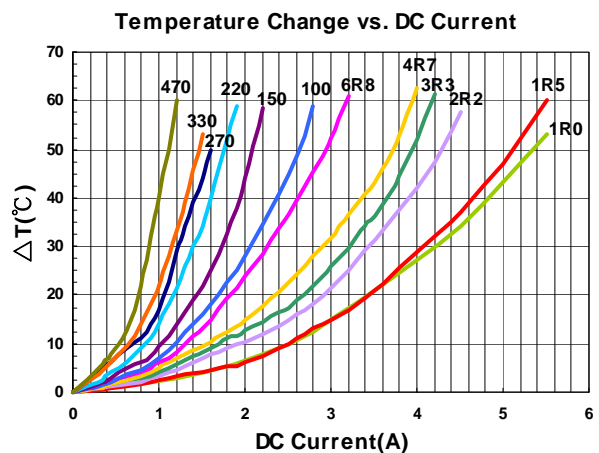
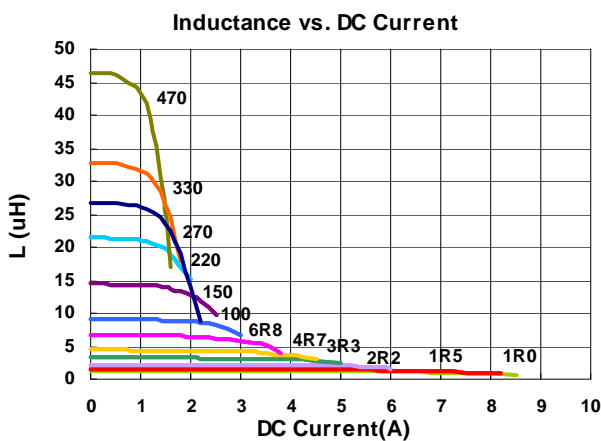

Electrical Characteristics

Part Number	Inductance (uH)	Test Frequency (KHz)	Tolerance (±%)	RDC (mΩ) ±30%	Isat (A) Typ. (Max)	Irms (A) Typ. (Max)	Marking
LVS606020-R50□-N	0.5	100	30	13	8.0(7.20)	5.3(4.77)	R50
LVS606020-R90□-N	0.9	100	30	18	6.3(5.67)	4.2(3.78)	R90
LVS606020-1R0□-N	1.0	100	30	19	6.2(5.58)	4.1(3.69)	1R0
LVS606020-1R5□-N	1.5	100	20, 30	26	5.0(4.50)	3.6(3.24)	1R5
LVS606020-2R2□-N	2.2	100	20, 30	34	4.2(3.78)	3.2(2.88)	2R2
LVS606020-3R3□-N	3.3	100	20, 30	40	3.2(2.88)	2.7(2.43)	3R3
LVS606020-4R7□-N	4.7	100	20, 30	58	2.5(2.25)	2.2(1.98)	4R7
LVS606020-6R8□-N	6.8	100	20, 30	85	2.2(1.98)	1.8(1.62)	6R8
LVS606020-100□-N	10	100	20, 30	125	2.0(1.80)	1.6(1.44)	100
LVS606020-150□-N	15	100	20, 30	190	1.3(1.17)	1.3(1.17)	150
LVS606020-220□-N	22	100	20, 30	260	1.1(0.99)	1.1(0.99)	220

- When ordering, please specify tolerance and packaging codes
- Tolerance : M = ±20% , T = ±30%
- L : Agilent/HP 4284A + Agilent/HP 16334A, 100KHz with 1V
- Isat & Irms : Agilent/HP 4284A, 100KHz with 1V
- Rdc : Digital Milliohm Meter Chroma 16502, or equivalent
- Isat for Inductance drop 30% from its value without current
- Irms for a 40°C rise above 25°C ambient
- Operating temperature range from -55°C to 125°C. (Including self - temperature rise)

Test Instruments : HP4284A Material/Impedance Analyzer

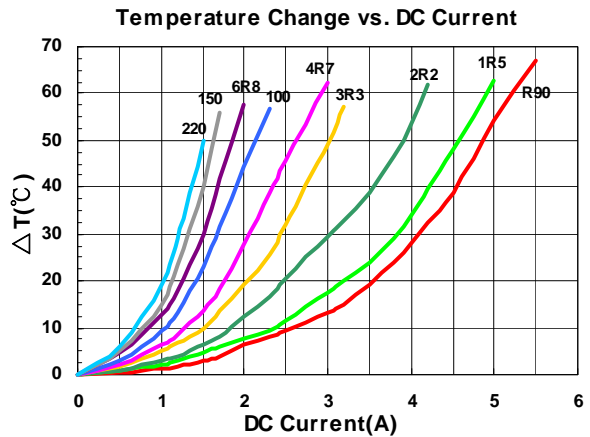
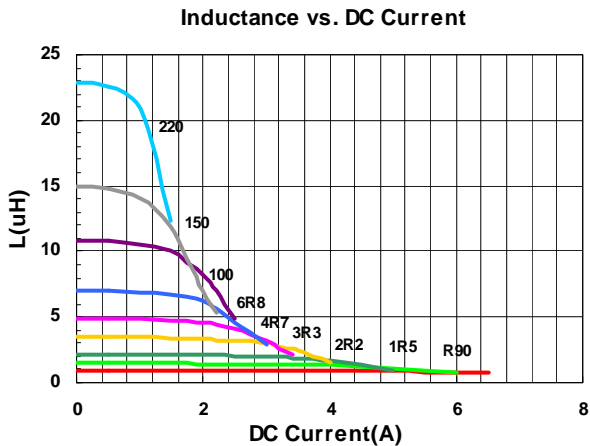

Electrical Characteristics

Part Number	Inductance (uH)	Test Frequency (KHz)	Tolerance (±%)	RDC (mΩ) ±30%	Isat (A) Typ. (Max)	Irms (A) Typ. (Max)	Marking
LVS606028-1R0□-N	1.0	100	30	13	7.6(6.84)	5.2(4.68)	1R0
LVS606028-1R5□-N	1.5	100	30	16	6.3(5.67)	4.8(4.32)	1R5
LVS606028-2R2□-N	2.2	100	20, 30	20	5.4(4.86)	4.0(3.60)	2R2
LVS606028-2R7□-N	2.7	100	20, 30	26	4.9(4.41)	3.7(3.33)	2R7
LVS606028-3R3□-N	3.3	100	20, 30	28	4.3(3.87)	3.5(3.15)	3R3
LVS606028-4R7□-N	4.7	100	20, 30	38	3.7(3.33)	3.2(2.88)	4R7
LVS606028-6R0□-N	6.0	100	20, 30	45	3.3(2.97)	2.8(2.52)	6R0
LVS606028-6R8□-N	6.8	100	20, 30	50	3.1(2.79)	2.7(2.43)	6R8
LVS606028-100□-N	10	100	20, 30	65	2.5(2.25)	2.3(2.07)	100
LVS606028-150□-N	15	100	20, 30	95	2.0(1.80)	1.8(1.62)	150
LVS606028-220□-N	22	100	20, 30	135	1.6(1.44)	1.5(1.35)	220
LVS606028-330□-N	33	100	20, 30	220	1.3(1.17)	1.4(1.26)	330
LVS606028-470□-N	47	100	20, 30	320	1.1(0.99)	1.0(0.90)	470
LVS606028-680□-N	68	100	20, 30	420	0.98(0.88)	0.9(0.81)	680
LVS606028-101□-N	100	100	20, 30	600	0.82(0.73)	0.8(0.72)	101

- When ordering, please specify tolerance and packaging codes
- Tolerance : M = ±20% , T = ±30%
- L : Agilent/HP 4284A + Agilent/HP 16334A, 100KHz with 1V
- Isat & Irms : Agilent/HP 4284A, 100KHz with 1V
- Rdc : Digital Milliohm Meter Chroma 16502, or equivalent
- Isat for Inductance drop 30% from its value without current
- Irms for a 40°C rise above 25°C ambient
- Operating temperature range from -55°C to 125°C. (Including self - temperature rise)

Test Instruments : HP4284A Material/Impedance Analyzer

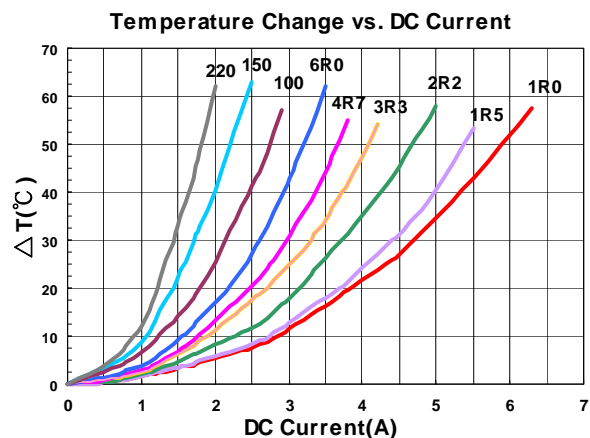
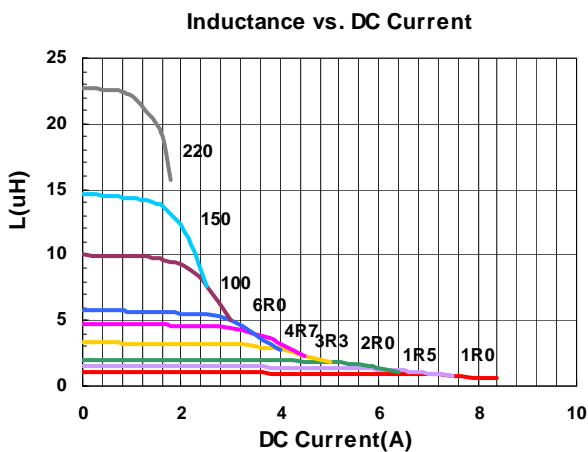

Electrical Characteristics

Part Number	Inductance (uH)	Test Frequency (KHz)	Tolerance (±%)	RDC (mΩ) ±30%	Isat (A) Typ. (Max)	Irms (A) Typ. (Max)	Marking
LVS606045-1R0□-N	1.0	100	20, 30	12	12.2(10.98)	6.5(5.85)	1R0
LVS606045-1R5□-N	1.5	100	30	15	10.4(9.36)	5.9(5.31)	1R5
LVS606045-1R8□-N	1.8	100	20, 30	17	9.6(8.64)	5.6(5.04)	1R8
LVS606045-2R2□-N	2.2	100	20, 30	18.4	8.8(7.92)	5.1(4.59)	2R2
LVS606045-2R3□-N	2.3	100	20, 30	19	8.8(7.92)	5.0(4.50)	2R3
LVS606045-3R0□-N	3.0	100	20, 30	22	7.8(7.02)	4.4(3.96)	3R0
LVS606045-3R3□-N	3.3	100	20, 30	24	7.5(6.75)	4.3(3.87)	3R3
LVS606045-3R6□-N	3.6	100	20, 30	24	7.5(6.75)	4.3(3.87)	3R6
LVS606045-3R9□-N	3.9	100	20, 30	26	7.0(6.30)	4.0(3.60)	3R9
LVS606045-4R5□-N	4.5	100	20, 30	31	6.7(6.03)	3.9(3.51)	4R5
LVS606045-4R7□-N	4.7	100	20, 30	31	6.7(6.03)	3.9(3.51)	4R7
LVS606045-5R1□-N	5.1	100	20, 30	33	6.0(5.40)	3.5(3.15)	5R1
LVS606045-6R3□-N	6.3	100	20, 30	40	5.5(4.95)	3.3(2.97)	6R3
LVS606045-6R8□-N	6.8	100	20, 30	43	5.3(4.77)	3.2(2.88)	6R8
LVS606045-100□-N	10	100	20, 30	57	4.5(4.05)	2.7(2.43)	100
LVS606045-150□-N	15	100	20, 30	80	3.4(3.06)	2.2(1.98)	150
LVS606045-180□-N	18	100	20, 30	100	3.1(2.79)	1.8(1.62)	180
LVS606045-220□-N	22	100	20, 30	125	3.0(2.70)	1.9(1.71)	220
LVS606045-270□-N	27	100	20, 30	160	2.5(2.25)	1.3(1.17)	270
LVS606045-330□-N	33	100	20, 30	165	2.3(2.07)	1.4(1.26)	330
LVS606045-470□-N	47	100	20, 30	245	1.9(1.71)	1.2(1.08)	470
LVS606045-680□-N	68	100	20, 30	330	1.6(1.44)	1.0(0.90)	680
LVS606045-101□-N	100	100	20, 30	500	1.3(1.17)	0.8(0.72)	101
LVS606045-221□-N	220	100	20, 30	1300	0.8(0.73)	0.38(0.34)	221
LVS606045-331□-N	330	100	20, 30	1800	0.7(0.63)	0.35(0.31)	331
LVS606045-102□-N	1000	100	20, 30	6000	0.4(0.36)	0.22(0.19)	102

- When ordering, please specify tolerance and packaging codes
- Tolerance : M = ±20% , T = ±30%
- L : Agilent/HP 4284A + Agilent/HP 16334A, 100KHz with 1V
- Isat & Irms : Agilent/HP 4284A, 100KHz with 1V
- Rdc : Digital Milliohm Meter Chroma 16502, or equivalent
- Isat for Inductance drop 30% from its value without current
- Irms for a 40°C rise above 25°C ambient
- Operating temperature range from -55°C to 125°C. (Including self - temperature rise)

Test Instruments : HP4284A Material/Impedance Analyzer

Inductance vs. DC Current

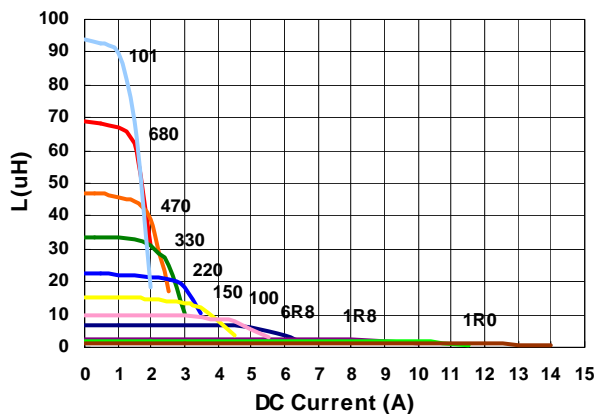

Temperature Change vs. DC Current

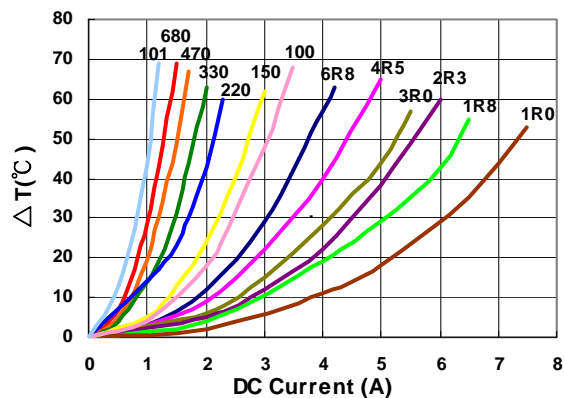

Electrical Characteristics

Part Number	Inductance (uH)	Test Frequency (KHz)	Tolerance (±%)	RDC (mΩ) Max	Isat (A) Typ. (Max)	Irms (A) Typ. (Max)	Marking
LVS606045L-R50□-N	0.5	100	30	9	11(9.90)	8.0(7.20)	R50
LVS606045L-2R2□-N	2.2	100	20, 30	17	6.8(6.12)	5.5(4.95)	2R2
LVS606045L-3R3□-N	3.3	100	20, 30	24	5.5(4.95)	4.7(4.23)	3R3
LVS606045L-4R7□-N	4.7	100	20, 30	30	4.6(4.14)	4.0(3.60)	4R7
LVS606045L-6R8□-N	6.8	100	20, 30	40	4.0(3.60)	3.5(3.15)	6R8
LVS606045L-100□-N	10	100	20, 30	50	3.2(2.88)	3.2(2.88)	100
LVS606045L-150□-N	15	100	20, 30	80	2.6(2.34)	2.5(2.25)	150
LVS606045L-220□-N	22	100	20, 30	120	2.1(1.89)	2.0(1.80)	220
LVS606045L-330□-N	33	100	20, 30	170	1.7(1.53)	1.6(1.44)	330
LVS606045L-101□-N	100	100	20, 30	595	0.95(0.85)	0.92(0.82)	101

- When ordering, please specify tolerance and packaging codes
- Tolerance : M = ±20% , T = ±30%
- L : Agilent/HP 4284A + Agilent/HP 16334A, 100KHz with 1V
- Isat & Irms : Agilent/HP 4284A, 100KHz with 1V
- Rdc : Digital Milliohm Meter Chroma 16502, or equivalent
- Isat for Inductance drop 30% from its value without current
- Irms for a 40°C rise above 25°C ambient
- Operating temperature range from -55°C to 125°C. (Including self - temperature rise)

Test Instruments : HP4284A Material/Impedance Analyzer

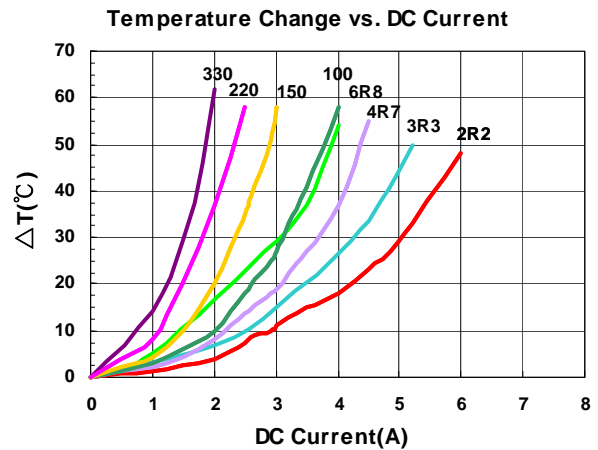
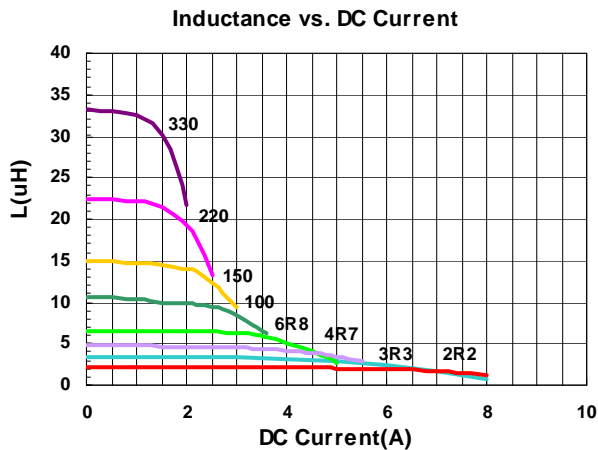

Electrical Characteristics

Part Number	Inductance (uH)	Test Frequency (KHz)	Tolerance (±%)	RDC (mΩ) ±30%	Isat (A) Typ. (Max)	Irms (A) Typ. (Max)	Marking
LVS808040-R90□-N	0.9	100	30	7	13.8(12.42)	8.05(7.24)	R90
LVS808040-1R0□-N	1.0	100	30	7.5	13.0(11.70)	7.95(7.15)	1R0
LVS808040-1R4□-N	1.4	100	30	9	10.8(9.72)	7.8(7.02)	1R4
LVS808040-1R5□-N	1.5	100	30	9.5	10.08(9.07)	7.7(6.93)	1R5
LVS808040-2R0□-N	2.0	100	20, 30	11	9.6(8.64)	7.4(6.66)	2R0
LVS808040-2R2□-N	2.2	100	20, 30	11.5	9.2(8.28)	7.2(6.48)	2R2
LVS808040-2R5□-N	2.5	100	20, 30	13	8.2(7.38)	6.3(5.67)	2R5
LVS808040-3R3□-N	3.3	100	20, 30	15	7.5(6.75)	6.0(5.40)	3R3
LVS808040-4R7□-N	4.7	100	20, 30	18	6.0(5.40)	5.5(4.95)	4R7
LVS808040-5R6□-N	5.6	100	20, 30	23	5.7(5.13)	5.2(4.68)	5R6
LVS808040-6R8□-N	6.8	100	20, 30	25	5.4(4.86)	5.1(4.59)	6R8
LVS808040-100□-N	10	100	20, 30	38	4.3(3.87)	3.8(3.42)	100
LVS808040-120□-N	12	100	20, 30	45	3.8(3.42)	3.5(3.15)	120
LVS808040-150□-N	15	100	20, 30	50	3.6(3.24)	3.2(2.88)	150
LVS808040-180□-N	18	100	20, 30	68	3.1(2.79)	2.7(2.43)	180
LVS808040-220□-N	22	100	20, 30	80	2.8(2.52)	2.6(2.34)	220
LVS808040-330□-N	33	100	20, 30	110	2.3(2.07)	2.0(1.80)	330
LVS808040-470□-N	47	100	20, 30	160	1.9(1.71)	1.75(1.57)	470
LVS808040-680□-N	68	100	20, 30	240	1.7(1.53)	1.45(1.30)	680
LVS808040-101□-N	100	100	20, 30	340	1.4(1.26)	1.10(0.99)	101
LVS808040-121□-N	120	100	20, 30	425	1.1(0.99)	1.0(0.90)	121
LVS808040-151□-N	150	100	20, 30	480	1.0(0.90)	0.9(0.81)	151
LVS808040-221□-N	220	100	20, 30	670	0.94(0.84)	0.60(0.54)	221
LVS808040-271□-N	270	100	20, 30	900	0.83(0.74)	0.55(0.49)	271
LVS808040-821□-N	820	100	20, 30	2800	0.40(0.36)	0.38(0.34)	821

- When ordering, please specify tolerance and packaging codes
- Tolerance : T = ±30% , M = ±20%
- L : Agilent/HP4284A+ Agilent/HP16334A, 100KHz, 1V
- RDC : Digital Milliohm Meter Chroma 16502, or equivalent
- Isat & Irms : Agilent/HP4284A, 100KHz, 1V
- Isat for Inductance drop 30% from its value without current
- Irms for a 40°C rise above 25°C ambient
- Operating temperature range from -55to 125°C . (Including self - temperature rise)

Test Instruments : HP4284A Material/Impedance Analyzer

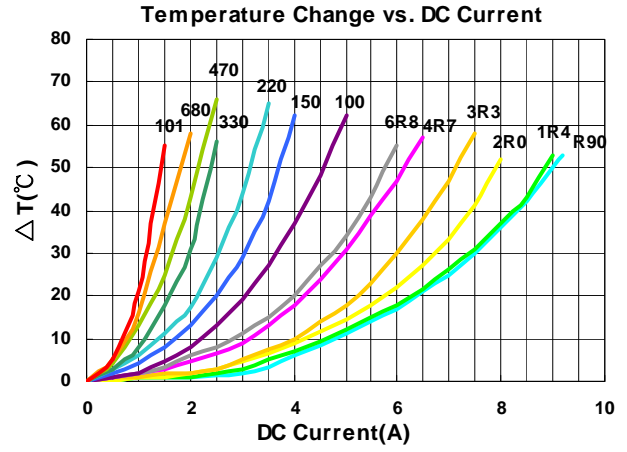
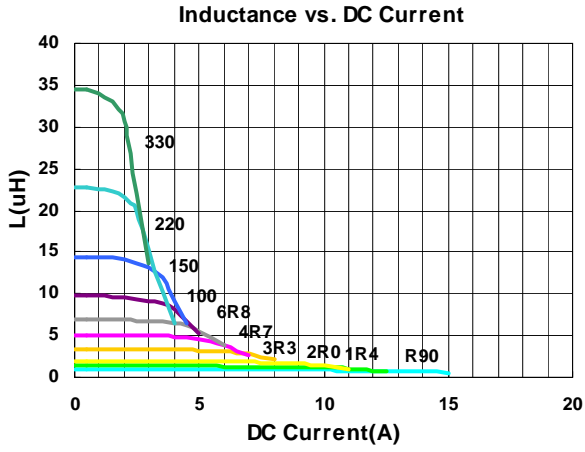

Electrical Characteristics

Part Number	Inductance (uH)	Test Frequency (KHz)	Tolerance (±%)	RDC (mΩ) Max	Isat (A) Typ. (Max)	Irms (A) Typ. (Max)	Marking
LVS808040L-1R0□-N	1.0	100	30	10	9.5(8.55)	8.5(7.65)	1R0
LVS808040L-2R2□-N	2.2	100	20,30	12	7.2(6.48)	7.3(6.57)	2R2
LVS808040L-3R3□-N	3.3	100	20,30	19	5.6(5.04)	6.0(5.40)	3R3
LVS808040L-4R7□-N	4.7	100	20,30	22	4.4(3.96)	5.0(4.50)	4R7
LVS808040L-8R2□-N	8.2	100	20,30	37	3.6(3.24)	3.8(3.42)	8R2
LVS808040L-100□-N	10	100	20,30	42	3.1(2.79)	3.5(3.15)	100
LVS808040L-150□-N	15	100	20,30	58	2.5(2.25)	3.0(2.70)	150
LVS808040L-220□-N	22	100	20,30	85	2.0(1.80)	2.5(2.25)	220

- When ordering, please specify tolerance and packaging codes
- Tolerance : T = ±30% , M = ±20%
- L : Agilent/HP4284A+ Agilent/HP16334A, 100KHz, 1V
- RDC : Digital Milliohm Meter Chroma 16502, or equivalent
- Isat & Irms : Agilent/HP4284A, 100KHz, 1V
- Isat for Inductance drop 30% from its value without current
- Irms for a 40°C rise above 25°C ambient
- Operating temperature range from -55to 125°C. (Including self - temperature rise)

Test Instruments : HP4284A Material/Impedance Analyzer

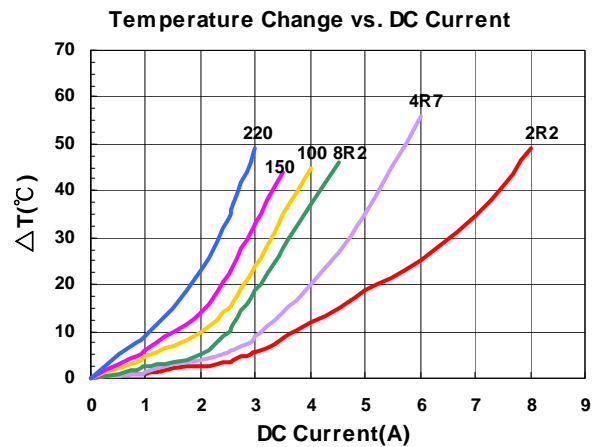
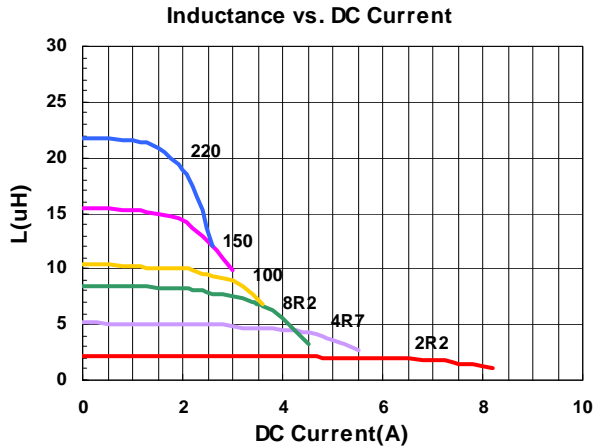

Packaging Specifications

Tape Dimensions

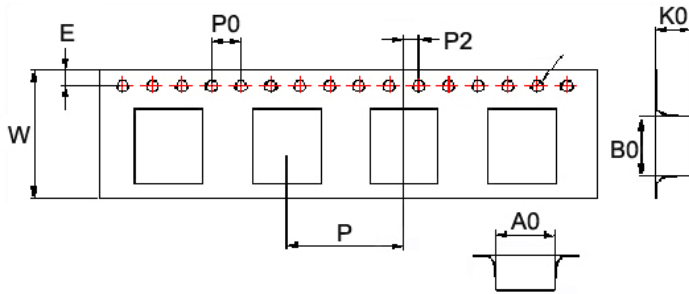

Reel Dimensions

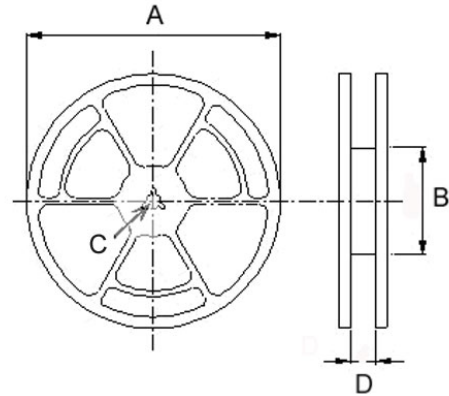

Dimensions in mm

TYPE	Tape Dimensions											Reel Dimensions				Quantity PCS / Reel
	A0	B0	K0	D	E	F	W	P	P0	P2	A	B	C	D		
LVS404012	4.25	4.25	1.30	1.55	1.75	5.5	12	8	4	2	180	60	13	13.2	1000	
LVS404018	4.25	4.25	2.10	1.55	1.75	5.5	12	8	4	2	180	60	13	13.2	800	
LVS404026	4.25	4.25	3.00	1.55	1.75	5.5	12	8	4	2	180	60	13	13.2	500	
LVS505020	5.25	5.25	2.20	1.55	1.75	5.5	12	8	4	2	330	100	13	13.4	2000	
LVS505040	5.20	5.20	4.20	1.55	1.75	5.5	12	8	4	2	330	100	13	13.4	1500	
LVS606020	6.25	6.25	2.20	1.55	1.75	7.5	16	12	4	2	330	100	13	17.4	2000	
LVS606028	6.25	6.25	3.00	1.55	1.75	7.5	16	12	4	2	330	100	13	17.4	1500	
LVS606045	6.25	6.25	4.65	1.55	1.75	7.5	16	12	4	2	330	100	13	17.4	1000	
LVS808040	8.25	8.25	4.15	1.55	1.75	7.5	16	12	4	2	330	100	13	17.4	1000	

LVF Series

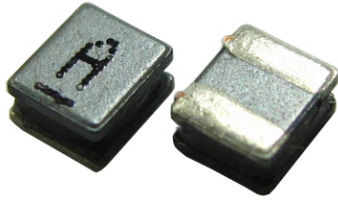

LVF series, an automatic assembly constructed power inductor, is shielded with magnetic resin and suitable for portable DC-DC converter applications.

Features

- RoHS compliant
- Low DC resistance and high current
- Highly accurate dimensions
- Superior EMI characteristics with ultra low radiation comparing to conventional shielded power inductors
- Halogen free

Applications

- Smart phone
- DSC
- Tablet PC and other portable devices
- DC/DC converters

Product Identification

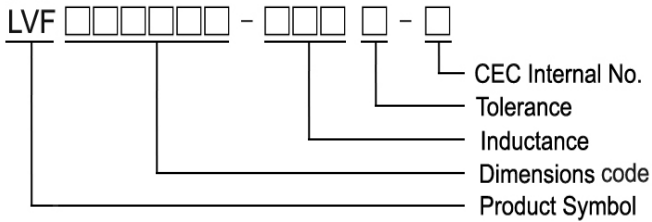

Shape and Dimensions

Figure 1

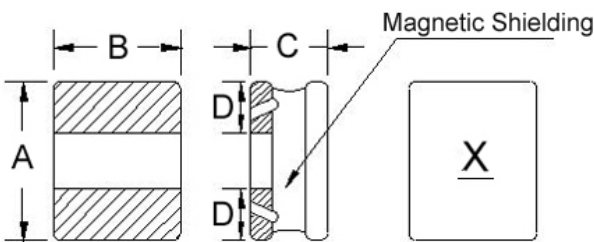
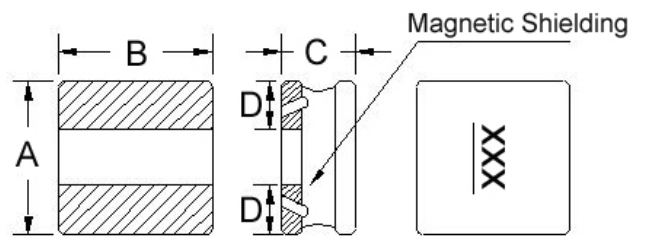

Figure 2



Dimensions in mm

TYPE	FIG	A	B	C	D	H	I	J
LVF201B12	1	2.0±0.25	1.6±0.25	1.2±0.05	0.6	1.8	0.8	0.8
LVF252A10	1	2.5±0.25	2.0±0.25	1.02 Max	0.8	2.2	0.85	0.8
LVF252A12	1	2.5±0.25	2.0±0.25	1.2±0.05	0.8	2.2	0.85	0.8
LVF303010	2	3.0±0.20	3.0±0.20	1.02 Max	1.0	3.2	1.1	1.0
LVF303012	2	3.0±0.20	3.0±0.20	1.2 Max	1.0	3.2	1.1	1.0
LVF303015	2	3.0±0.20	3.0±0.20	1.5 Max	1.0	3.2	1.1	1.0
LVF404012	2	4.0±0.20	4.0±0.20	1.2±0.1	1.5	4.2	1.5	1.2

Recommended Pattern

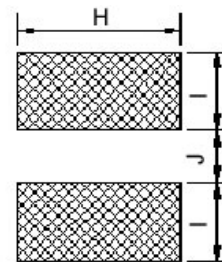

Shape and Dimensions

Recommended Pattern

Figure 3

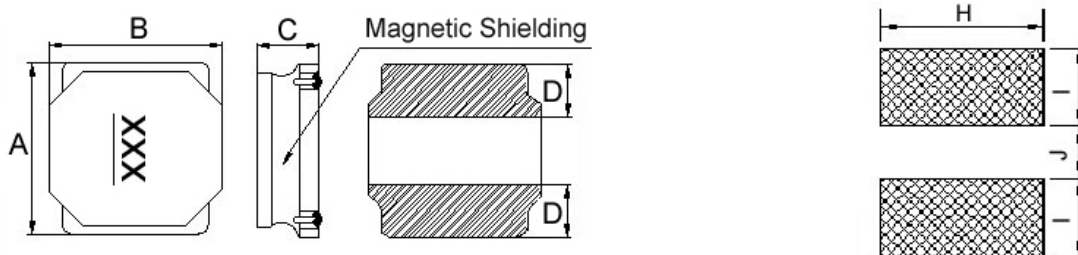

Dimensions in mm

TYPE	FIG	A	B	C	D	H	I	J
LVF404015	3	4.0±0.25	4.0±0.25	1.5±0.2	1.3	3.7	1.5	1.2
LVF404018	3	4.0±0.20	4.0±0.20	1.8±0.2	1.3	3.7	1.5	1.2
LVF404026	3	4.0±0.20	4.0±0.25	2.6±0.2	1.4	3.7	1.6	1.2
LVF606028	3	6.0±0.20	6.0±0.20	2.8±0.2	1.9±0.3	5.7	1.8	2.6

Shapes and Dimensions

Recommended Pattern

Figure 4

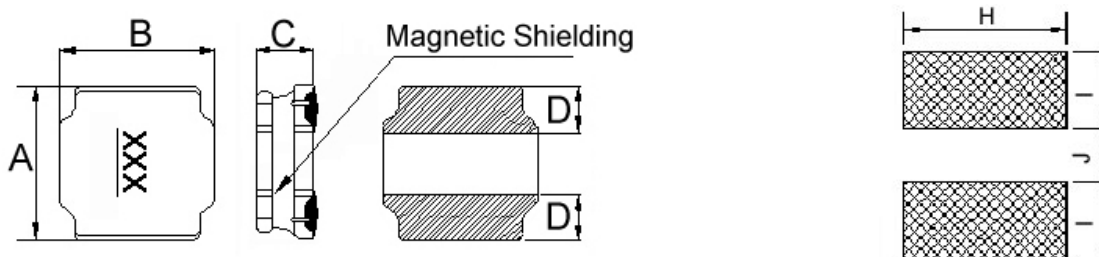

Dimensions in mm

TYPE	FIG	A	B	C	D	H	I	J
LVF505020	4	5.0±0.20	5.0±0.20	2.0±0.2	1.8	4.2	1.6	2.0
LVF606020	4	6.0±0.20	6.0±0.20	2.0±0.2	1.7±0.3	5.7	1.7	2.8
LVF808040	4	8.0±0.20	8.0±0.20	4.0 ^{+0.2} _{-0.30}	2.3±0.3	7.5	2.5	3.4

Electrical Characteristics

Part Number	Inductance (uH)	Test Frequency (MHz)	Tolerance (±%)	RDC (Ω) ±30%	Isat (A) Typ. (Max)	Irms (A) Typ. (Max)	Marking
LVF201B12-R47□-N	0.47	1	20, 30	0.051	2.70(2.43)	2.30(2.07)	A
LVF201B12-R68□-N	0.68	1	20, 30	0.074	2.20(1.98)	2.00(1.80)	L
LVF201B12-1R5□-N	1.5	1	20, 30	0.130	1.60(1.44)	1.45(1.30)	D
LVF201B12-6R8□-N	6.8	1	20, 30	0.465	0.82(0.73)	0.78(0.70)	H

- When ordering, please specify tolerance and packaging codes
- Tolerance : T = ±30% , M = ±20%
- L : Agilent/HP4287A+ Agilent/HP16197A, 1MHz 200mV
- RDC : Digital Milliohm Meter Chroma 16502, or equivalent
- Isat & Irms : Agilent/HP4284A, 1MHz 200mV
- Isat for Inductance drop 30% from its value without current
- Irms for a 40°C rise above 25°C ambient
- Operating temperature range from -55°C to 125°C. (Including self - temperature rise)

Test Instruments : HP4284A Material/Impedance Analyzer

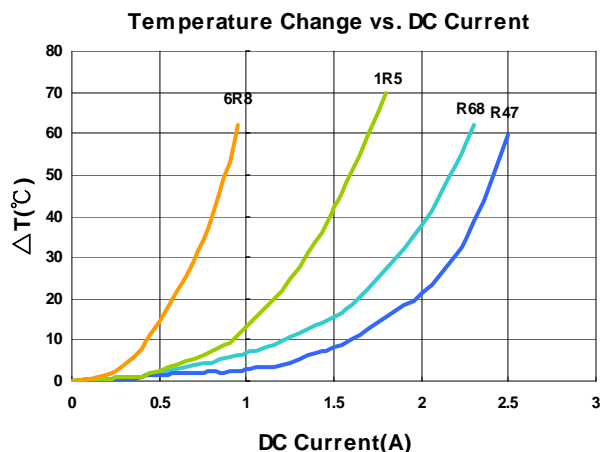
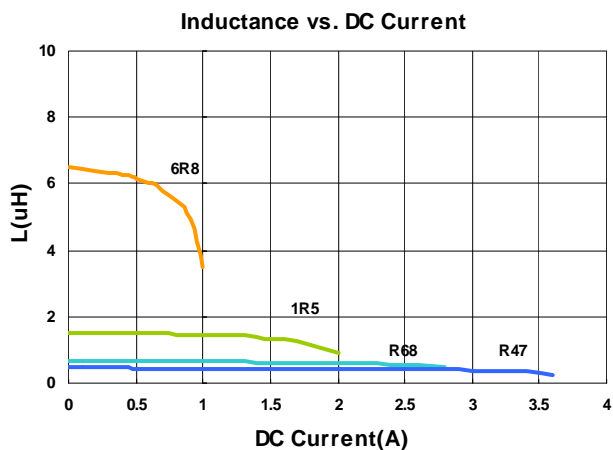

Electrical Characteristics

Part Number	Inductance (uH)	Test Frequency (MHz)	Tolerance (±%)	RDC (Ω) ±30%	Isat (A) Typ. (Max)	Irms (A) Typ. (Max)	Marking
LVF252A10-R47□-N	0.47	1	20, 30	0.045	2.80(2.52)	2.30(2.07)	A
LVF252A10-1R0□-N	1.0	1	20, 30	0.066	1.98(1.78)	2.05(1.84)	B
LVF252A10-1R5□-N	1.5	1	20, 30	0.095	1.70(1.53)	1.85(1.66)	C
LVF252A10-4R7□-N	4.7	1	20, 30	0.285	0.92(0.82)	0.95(0.85)	F
LVF252A10-100□-N	10	1	20, 30	0.535	0.60(0.54)	0.70(0.63)	H
LVF252A10-150□-N	15	1	20, 30	0.810	0.50(0.45)	0.55(0.49)	I
LVF252A10-220□-N	22	1	20, 30	1.200	0.40(0.36)	0.44(0.39)	J

- When ordering, please specify tolerance and packaging codes
- Tolerance : T = ±30% , M = ±20%
- L : Agilent/HP4287A+ Agilent/HP16197A, 1MHz 200mV
- RDC : Digital Milliohm Meter Chroma 16502, or equivalent
- Isat & Irms : Agilent/HP4284A, 1MHz 200mV
- Isat for Inductance drop 30% from its value without current
- Irms for a 40°C rise above 25°C ambient
- Operating temperature range from -55°C to 125°C . (Including self - temperature rise)

Test Instruments : HP4284A Material/Impedance Analyzer

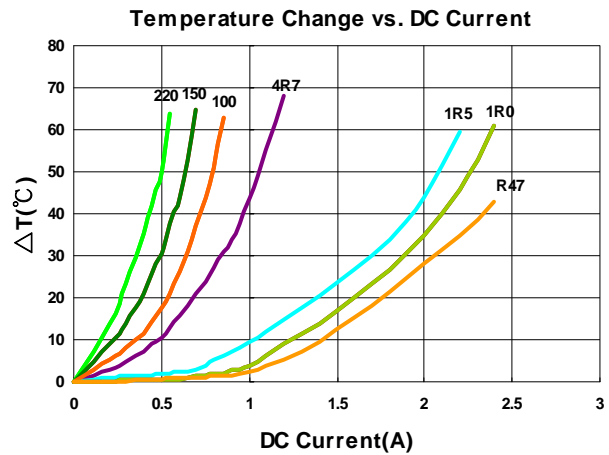
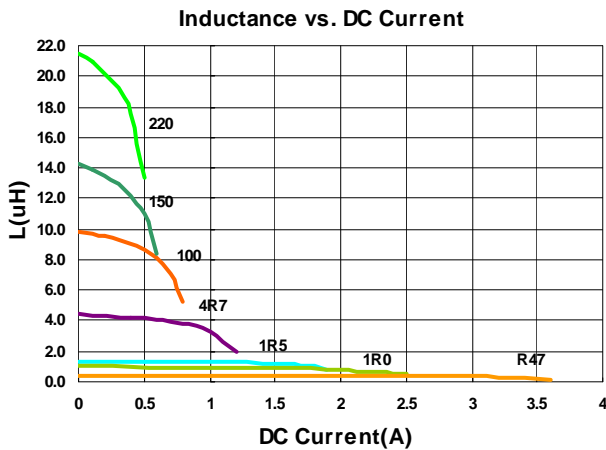

Electrical Characteristics

Part Number	Inductance (uH)	Test Frequency (MHz)	Tolerance (±%)	RDC (Ω) ±30%	Isat (A) Typ. (Max)	Irms (A) Typ. (Max)	Marking
LVF252A12-R50□-N	0.50	1	20, 30	0.028	3.50(3.15)	3.00(2.70)	B
LVF252A12-1R0□-N	1.0	1	20, 30	0.050	2.50(2.25)	2.40(2.16)	C
LVF252A12-1R2□-N	1.2	1	20, 30	0.053	2.10(1.89)	2.35(2.11)	D
LVF252A12-1R5□-N	1.5	1	20, 30	0.068	1.95(1.75)	2.30(2.07)	E
LVF252A12-2R2□-N	2.2	1	20, 30	0.080	1.80(1.62)	1.80(1.62)	F
LVF252A12-3R3□-N	3.3	1	20, 30	0.130	1.45(1.30)	1.50(1.35)	G
LVF252A12-4R7□-N	4.7	1	20, 30	0.190	1.10(0.99)	1.10(0.99)	H
LVF252A12-5R6□-N	5.6	1	20, 30	0.210	1.05(0.94)	1.00(0.90)	I
LVF252A12-6R8□-N	6.8	1	20, 30	0.300	0.95(0.85)	0.80(0.72)	J
LVF252A12-100□-N	10	1	20, 30	0.385	0.88(0.79)	0.70(0.63)	K
LVF252A12-150□-N	15	1	20, 30	0.570	0.68(0.61)	0.62(0.55)	L
LVF252A12-220□-N	22	1	20, 30	0.810	0.55(0.49)	0.53(0.47)	M

- When ordering, please specify tolerance and packaging codes
- Tolerance : T = ±30% , M = ±20%
- L : Agilent/HP4287A+ Agilent/HP16197A, 1MHz 200mV
- RDC : Digital Milliohm Meter Chroma 16502, or equivalent
- Isat & I rms : Agilent/HP4284A, 1MHz 200mV
- Isat for Inductance drop 30% from its value without current
- I rms for a 40°C rise above 25°C ambient
- Operating temperature range from -55°C to 125°C. (Including self - temperature rise)

Test Instruments : HP4284A Material/Impedance Analyzer

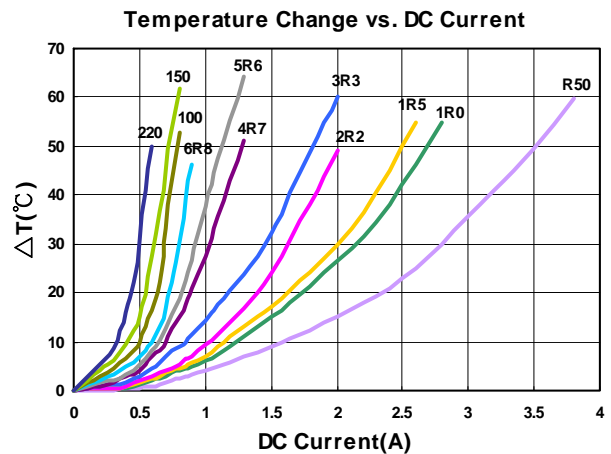
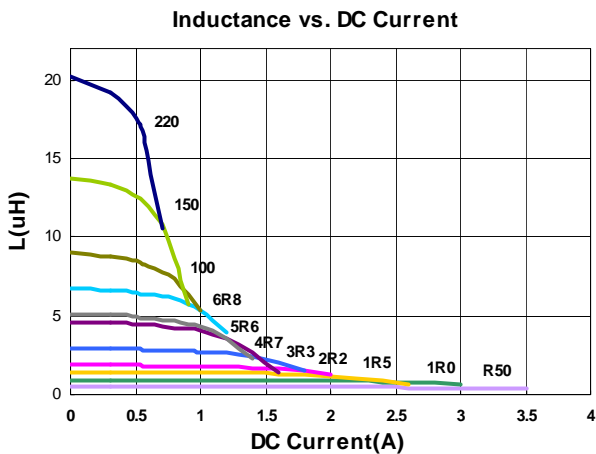

Electrical Characteristics

Part Number	Inductance (uH)	Test Frequency (MHz)	Tolerance (±%)	RDC (Ω) ±30%	Isat (A) Typ. (Max)	Irms (A) Typ. (Max)	Marking
LVF303010-1R5□-N	1.5	1	20, 30	0.085	1.80(1.62)	1.70(1.53)	1R5
LVF303010-2R2□-N	2.2	1	20, 30	0.100	1.50(1.35)	1.40(1.26)	2R2
LVF303010-4R7□-N	4.7	1	20, 30	0.205	1.00(0.90)	0.95(0.85)	4R7
LVF303010-6R8□-N	6.8	1	20, 30	0.310	0.87(0.78)	0.85(0.76)	6R8
LVF303010-100□-N	10	1	20, 30	0.430	0.64(0.57)	0.63(0.56)	100
LVF303010-150□-N	15	1	20, 30	0.625	0.56(0.50)	0.55(0.49)	150
LVF303010-220□-N	22	1	20, 30	0.870	0.47(0.42)	0.46(0.41)	220

- When ordering, please specify tolerance and packaging codes
- Tolerance : T = ±30% , M = ±20%
- L : Agilent/HP4287A+ Agilent/HP16197A, 1MHz 200mV
- RDC : Digital Milliohm Meter Chroma 16502, or equivalent
- Isat & Irms : Agilent/HP4284A, 1MHz 200mV
- Isat for Inductance drop 30% from its value without current
- Irms for a 40°C rise above 25°C ambient
- Operating temperature range from -55°C to 125°C. (Including self - temperature rise)

Test Instruments : HP4284A Material/Impedance Analyzer

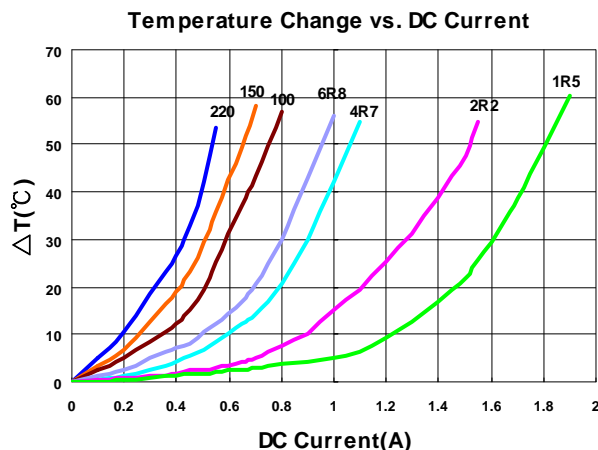
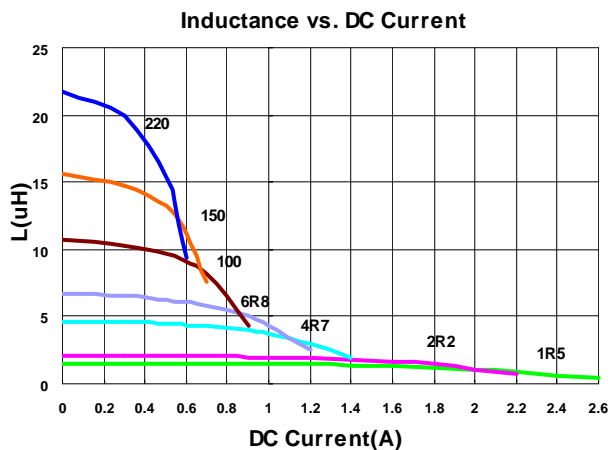

Electrical Characteristics

Part Number	Inductance (uH)	Test Frequency (MHz)	Tolerance (±%)	RDC (Ω) ±30%	Isat (A) Typ. (Max)	Irms (A) Typ. (Max)	Marking
LVF303012-2R2□-N	2.2	1	20, 30	0.092	2.10(1.89)	2.00(1.80)	2R2
LVF303012-3R3□-N	3.3	1	20, 30	0.13	1.84(1.65)	1.80(1.62)	3R3
LVF303012-4R7□-N	4.7	1	20, 30	0.18	1.56(1.40)	1.52(1.36)	4R7
LVF303012-6R8□-N	6.8	1	20, 30	0.25	1.32(1.18)	1.30(1.17)	6R8
LVF303012-100□-N	10	1	20, 30	0.42	1.06(0.95)	1.00(0.90)	100
LVF303012-150□-N	15	1	20, 30	0.56	0.82(0.73)	0.80(0.72)	150
LVF303012-220□-N	22	1	20, 30	0.86	0.64(0.57)	0.62(0.55)	220

- When ordering, please specify tolerance and packaging codes
- Tolerance : T = ±30% , M = ±20%
- L : Agilent/HP4287A+ Agilent/HP16197A, 1MHz 200mV
- RDC : Digital Milliohm Meter Chroma 16502, or equivalent
- Isat & Irms : Agilent/HP4284A, 1MHz 200mV
- Isat for Inductance drop 30% from its value without current
- Irms for a 40°C rise above 25°C ambient
- Operating temperature range from -55°C to 125°C. (Including self - temperature rise)

Test Instruments : HP4284A Material/Impedance Analyzer

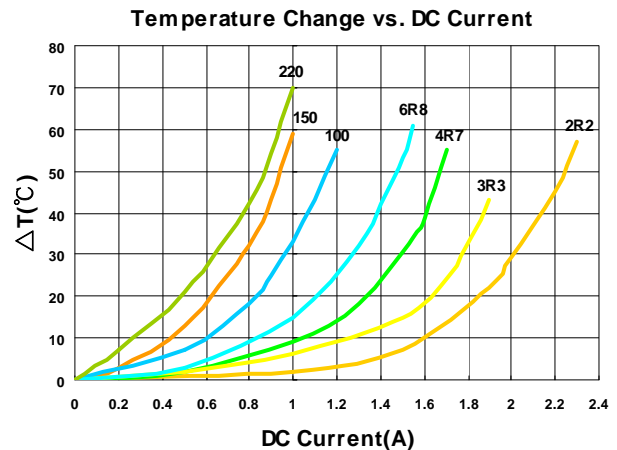
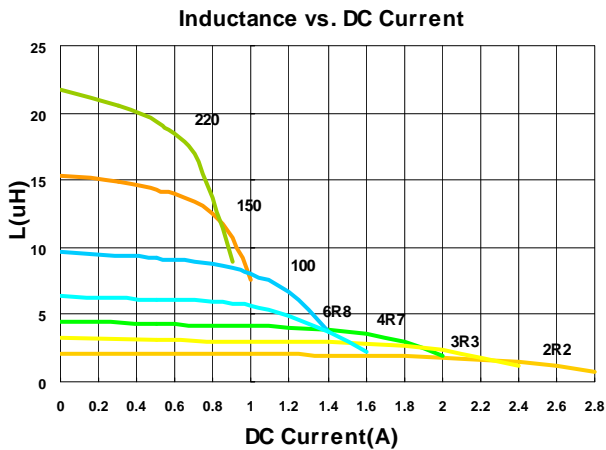

Electrical Characteristics

Part Number	Inductance (uH)	Test Frequency (MHz)	Tolerance (±%)	RDC (Ω) ±30%	Isat (A) Typ. (Max)	Irms (A) Typ. (Max)	Marking
LVF303015-R47□-N	0.47	1	20, 30	0.036	4.7(4.23)	4.0(3.60)	R47
LVF303015-1R0□-N	1.0	1	20, 30	0.054	3.4(3.06)	3.0(2.70)	1R0
LVF303015-1R5□-N	1.5	1	20, 30	0.063	3.0(2.70)	2.6(2.34)	1R5
LVF303015-2R2□-N	2.2	1	20, 30	0.090	2.3(2.07)	2.0(1.80)	2R2
LVF303015-3R3□-N	3.3	1	20, 30	0.125	1.9(1.71)	1.80(1.62)	3R3
LVF303015-4R7□-N	4.7	1	20, 30	0.170	1.58(1.42)	1.52(1.36)	4R7
LVF303015-6R8□-N	6.8	1	20, 30	0.235	1.34(1.20)	1.30(1.17)	6R8
LVF303015-100□-N	10	1	20, 30	0.360	1.06(0.95)	1.00(0.90)	100
LVF303015-150□-N	15	1	20, 30	0.550	0.90(0.81)	0.80(0.72)	150
LVF303015-220□-N	22	1	20, 30	0.770	0.76(0.68)	0.65(0.58)	220
LVF303015-470□-N	47	1	20, 30	1.500	0.52(0.46)	0.42(0.37)	470

- When ordering, please specify tolerance and packaging codes
- Tolerance : T = ±30% , M = ±20%
- L : Agilent/HP4287A+ Agilent/HP16197A, 1MHz 200mV
- RDC : Digital Milliohm Meter Chroma 16502, or equivalent
- Isat & I rms : Agilent/HP4284A, 1MHz 200mV
- Isat for Inductance drop 30% from its value without current
- I rms for a 40°C rise above 25°C ambient
- Operating temperature range from -55°C to 125°C. (Including self - temperature rise)

Test Instruments : HP4284A Material/Impedance Analyzer

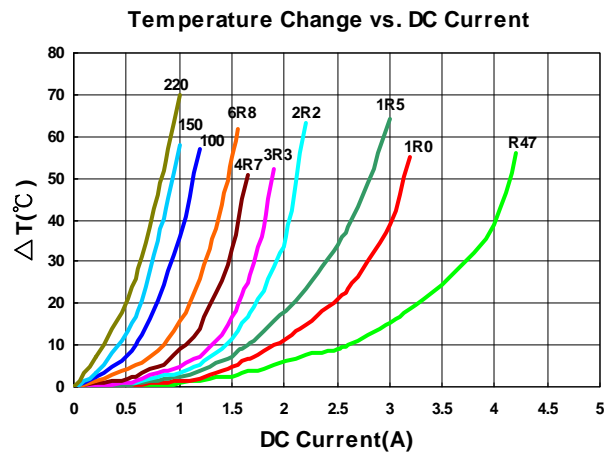
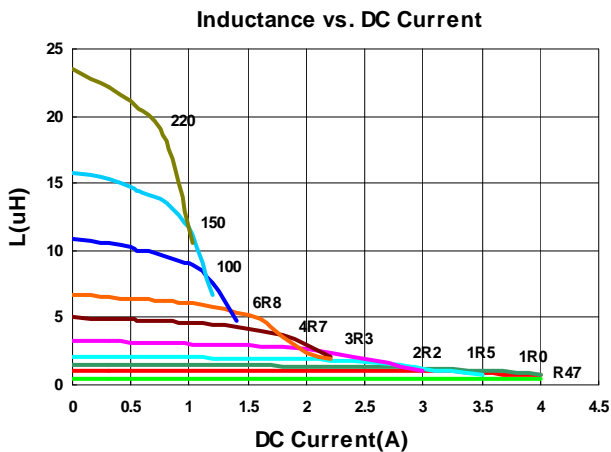

Electrical Characteristics

Part Number	Inductance (uH)	Test Frequency (MHz)	Tolerance (±%)	RDC (Ω) ±30%	Isat (A) Typ. (Max)	Irms (A) Typ. (Max)	Marking
LVF404012-3R3□-N	3.3	1	20, 30	0.072	1.52(1.36)	2.10(1.89)	3R3
LVF404012-100□-N	10	1	20, 30	0.190	0.90(0.81)	1.20(1.08)	100

- When ordering, please specify tolerance and packaging codes
- Tolerance : T = ±30% , M = ±20%
- L : Agilent/HP4287A+ Agilent/HP16197A, 1MHz 200mV
- RDC : Digital Milliohm Meter Chroma 16502, or equivalent
- Isat & I rms : Agilent/HP4284A, 1MHz 200mV
- Isat for Inductance drop 30% from its value without current
- I rms for a 40°C rise above 25°C ambient
- Operating temperature range from -55°C to 125°C. (Including self - temperature rise)

Test Instruments : HP4284A Material/Impedance Analyzer

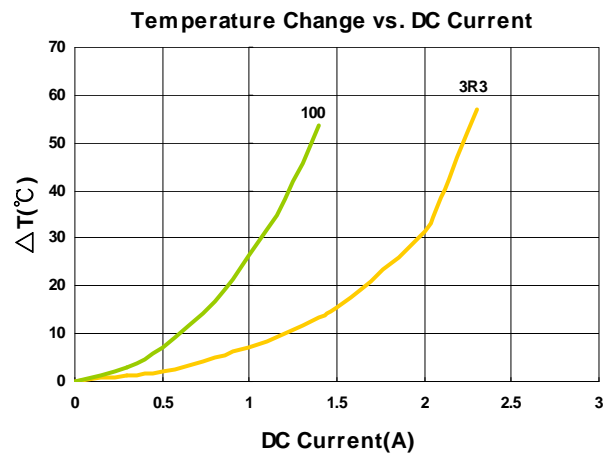
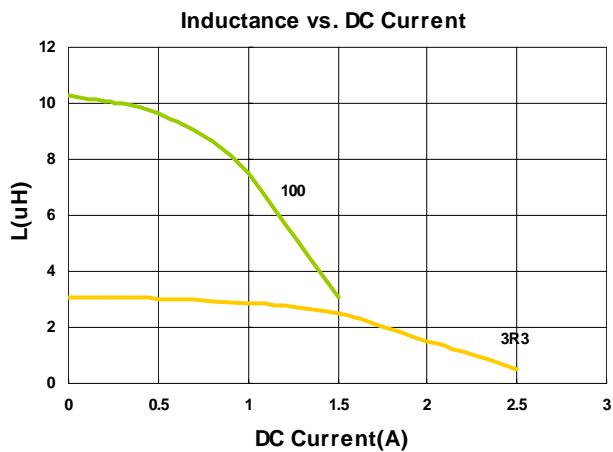

Electrical Characteristics

Part Number	Inductance (uH)	Test Frequency (MHz)	Tolerance (±%)	RDC (Ω) ±30%	Isat (A) Typ. (Max)	Irms (A) Typ. (Max)	Marking
LVF404015-1R5□-N	1.5	1	20, 30	0.041	3.00(2.70)	3.2(2.88)	1R5
LVF404015-2R2□-N	2.2	1	20, 30	0.054	2.30(2.07)	2.60(2.34)	2R2
LVF404015-4R7□-N	4.7	1	20, 30	0.100	1.60(1.44)	1.80(1.62)	4R7
LVF404015-6R8□-N	6.8	1	20, 30	0.138	1.40(1.26)	1.60(1.44)	6R8
LVF404015-100□-N	10	1	20, 30	0.200	1.00(0.90)	1.20(1.08)	100
LVF404015-150□-N	15	1	20, 30	0.300	0.92(0.82)	1.05(0.94)	150
LVF404015-220□-N	22	1	20, 30	0.400	0.72(0.64)	0.85(0.76)	220

- When ordering, please specify tolerance and packaging codes
- Tolerance : T = ±30% , M = ±20%
- L : Agilent/HP4287A+ Agilent/HP16197A, 1MHz 200mV
- RDC : Digital Milliohm Meter Chroma 16502, or equivalent
- Isat & I rms : Agilent/HP4284A, 1MHz 200mV
- Isat for Inductance drop 30% from its value without current
- I rms for a 40°C rise above 25°C ambient
- Operating temperature range from -55°C to 125°C. (Including self - temperature rise)

Test Instruments : HP4284A Material/Impedance Analyzer

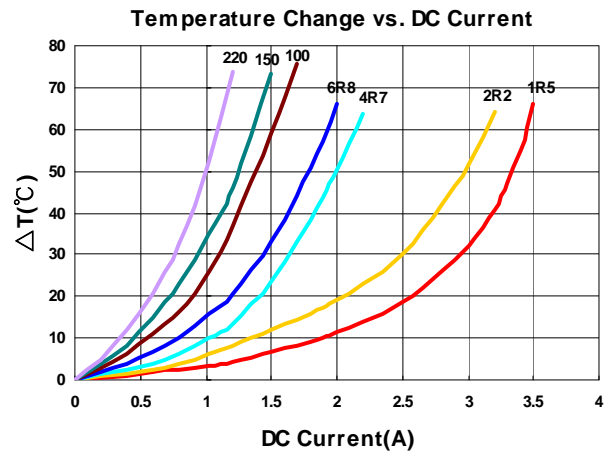
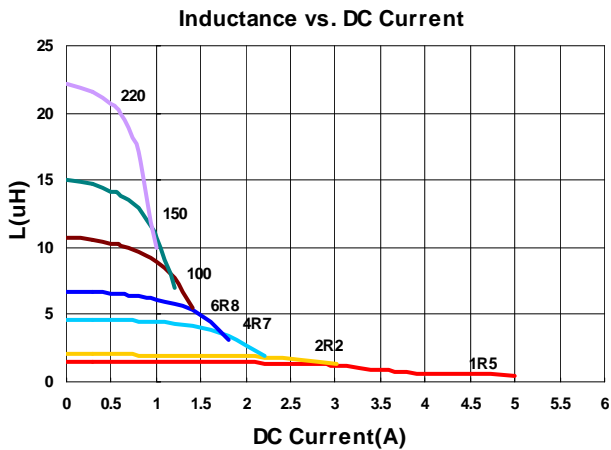

Electrical Characteristics

Part Number	Inductance (uH)	Test Frequency (KHz)	Tolerance (±%)	RDC (Ω) ±30%	Isat (A) Typ. (Max)	Irms (A) Typ. (Max)	Marking
LVF404018-1R0□-N	1.0	100	20, 30	0.0265	4.2(3.78)	3.8(3.42)	1R0
LVF404018-1R5□-N	1.5	100	20, 30	0.0370	3.5(3.15)	3.2(2.88)	1R5
LVF404018-2R2□-N	2.2	100	20, 30	0.0470	3.0(2.70)	2.7(2.43)	2R2
LVF404018-3R3□-N	3.3	100	20, 30	0.0625	2.3(2.07)	2.1(1.89)	3R3

- When ordering, please specify tolerance and packaging codes
- Tolerance : T = ±30% , M = ±20%
- L : Agilent/HP4284A+ Agilent/HP16334A, 100KHz, 1V
- RDC : Digital Milliohm Meter Chroma 16502, or equivalent
- Isat & Irms : Agilent/HP4284A, 100KHz 1V
- Isat for Inductance drop 30% from its value without current
- Irms for a 40°C rise above 25°C ambient
- Operating temperature range from -55°C to 125°C. (Including self - temperature rise)

Test Instruments : HP4284A Material/Impedance Analyzer

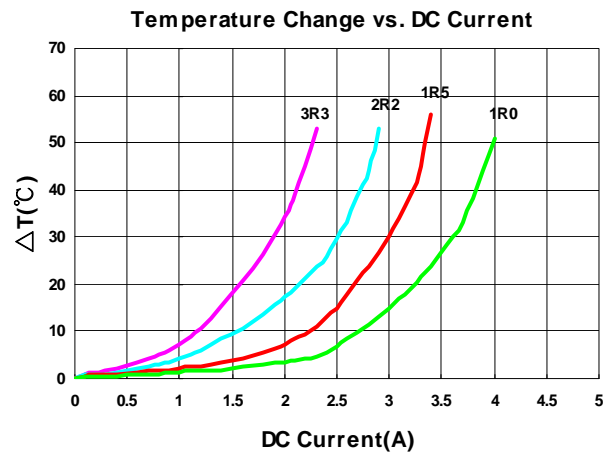
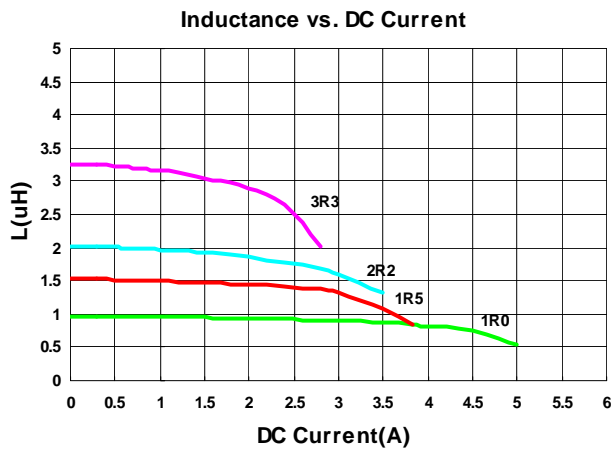

Electrical Characteristics

Part Number	Inductance (uH)	Test Frequency (KHz)	Tolerance (±%)	RDC (Ω) ±30%	Isat (A) Typ. (Max)	Irms (A) Typ. (Max)	Marking
LVF404026-1R0□-N	1.0	100	20, 30	0.030	5.00(4.50)	4.00(3.60)	1R0
LVF404026-1R5□-N	1.5	100	20, 30	0.035	4.20(3.78)	3.70(3.33)	1R5
LVF404026-2R2□-N	2.2	100	20, 30	0.045	3.80(3.42)	3.50(3.15)	2R2
LVF404026-3R3□-N	3.3	100	20, 30	0.067	3.00(2.70)	2.50(2.25)	3R3
LVF404026-4R7□-N	4.7	100	20, 30	0.092	2.60(2.34)	2.00(1.80)	4R7
LVF404026-5R6□-N	5.6	100	20, 30	0.110	2.30(2.07)	1.90(1.71)	5R6
LVF404026-6R8□-N	6.8	100	20, 30	0.130	2.00(1.80)	1.70(1.53)	6R8
LVF404026-100□-N	10	100	20, 30	0.188	1.90(1.71)	1.40(1.26)	100
LVF404026-150□-N	15	100	20, 30	0.240	1.45(1.30)	1.20(1.08)	150
LVF404026-220□-N	22	100	20, 30	0.330	1.22(1.09)	1.00(0.90)	220
LVF404026-330□-N	33	100	20, 30	0.480	1.00(0.90)	0.82(0.73)	330

- When ordering, please specify tolerance and packaging codes
- Tolerance : T = ±30% , M = ±20%
- L : Agilent/HP4284A+ Agilent/HP16334A, 100KHz, 1V
- RDC : Digital Milliohm Meter Chroma 16502, or equivalent
- Isat & I rms : Agilent/HP4284A, 100KHz 1V
- Isat for Inductance drop 30% from its value without current
- I rms for a 40°C rise above 25°C ambient
- Operating temperature range from -55°C to 125°C. (Including self - temperature rise)

Test Instruments : HP4284A Material/Impedance Analyzer

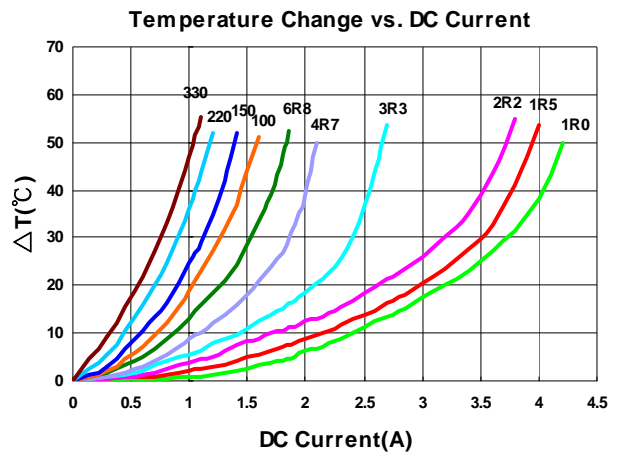
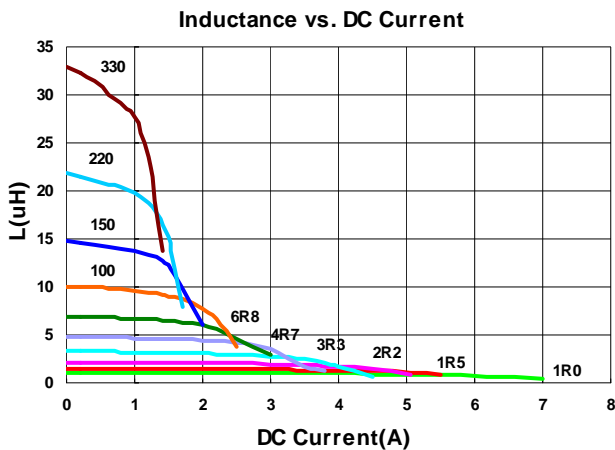

Electrical Characteristics

Part Number	Inductance (uH)	Test Frequency (KHz)	Tolerance (±%)	RDC (Ω) ±30%	Isat (A) Typ. (Max)	Irms (A) Typ. (Max)	Marking
LVF505020-1R0□-N	1.0	100	20, 30	0.018	6.0(5.40)	4.1(3.69)	1R0
LVF505020-1R5□-N	1.5	100	20, 30	0.023	4.9(4.41)	3.5(3.15)	1R5
LVF505020-2R2□-N	2.2	100	20, 30	0.030	4.0(3.60)	3.3(2.97)	2R2
LVF505020-3R6□-N	3.6	100	20, 30	0.050	3.1(2.70)	2.7(2.40)	3R6
LVF505020-3R9□-N	3.9	100	20, 30	0.053	2.9(2.61)	2.6(2.34)	3R9
LVF505020-4R7□-N	4.7	100	20, 30	0.060	2.7(2.43)	2.2(1.98)	4R7
LVF505020-6R8□-N	6.8	100	20, 30	0.093	2.2(1.98)	1.8(1.62)	6R8
LVF505020-100□-N	10	100	20, 30	0.125	1.8(1.62)	1.6(1.44)	100
LVF505020-150□-N	15	100	20, 30	0.195	1.4(1.26)	1.2(1.08)	150
LVF505020-220□-N	22	100	20, 30	0.265	1.2(1.08)	1.0(0.90)	220

- When ordering, please specify tolerance and packaging codes
- Tolerance : T = ±30% , M = ±20%
- L : Agilent/HP4284A+ Agilent/HP16334A, 100KHz, 1V
- RDC : Digital Milliohm Meter Chroma 16502, or equivalent
- Isat & Irms : Agilent/HP4284A, 100KHz 1V
- Isat for Inductance drop 30% from its value without current
- Irms for a 40°C rise above 25°C ambient
- Operating temperature range from -55°C to 125°C. (Including self - temperature rise)

Test Instruments : HP4284A Material/Impedance Analyzer

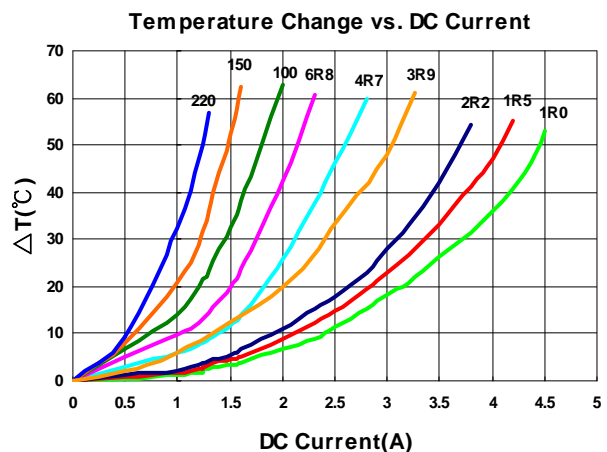
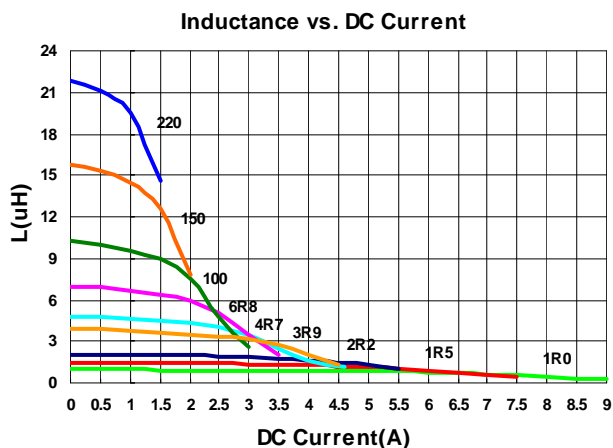

Electrical Characteristics

Part Number	Inductance (uH)	Test Frequency (KHz)	Tolerance (±%)	RDC (Ω) ±30%	Isat (A) Typ. (Max)	Irms (A) Typ. (Max)	Marking
LVF606020-4R7□-N	4.7	100	20, 30	0.058	3.0(2.70)	2.3(2.07)	4R7
LVF606020-100□-N	10	100	20, 30	0.130	2.1(1.89)	1.6(1.44)	100
LVF606020-150□-N	15	100	20, 30	0.195	1.6(1.44)	1.3(1.17)	150
LVF606020-220□-N	22	100	20, 30	0.260	1.3(1.17)	1.1(0.99)	220

- When ordering, please specify tolerance and packaging codes
- Tolerance : T = ±30% , M = ±20%
- L : Agilent/HP4284A+ Agilent/HP16334A, 100KHz, 1V
- RDC : Digital Milliohm Meter Chroma 16502, or equivalent
- Isat & Irms : Agilent/HP4284A, 100KHz 1V
- Isat for Inductance drop 30% from its value without current
- Irms for a 40°C rise above 25°C ambient
- Operating temperature range from -55°C to 125°C. (Including self - temperature rise)

Test Instruments : HP4284A Material/Impedance Analyzer

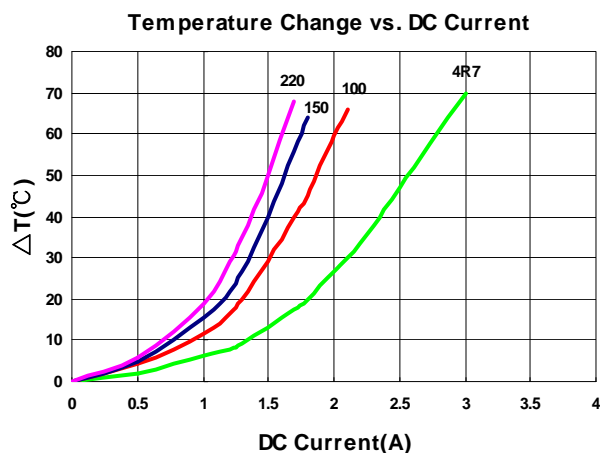
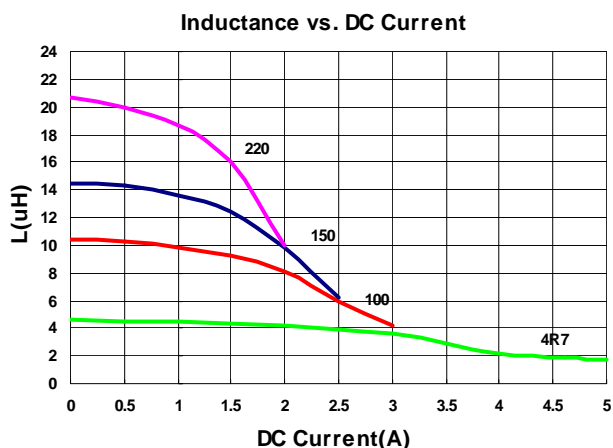

Electrical Characteristics

Part Number	Inductance (uH)	Test Frequency (KHz)	Tolerance (±%)	RDC (Ω) ±30%	Isat (A) Typ. (Max)	Irms (A) Typ. (Max)	Marking
LVF606028-1R0□-N	1.0	100	20, 30	0.012	7.9(7.11)	6.3(5.67)	1R0
LVF606028-1R5□-N	1.5	100	20, 30	0.015	7.0(6.30)	5.5(4.95)	1R5
LVF606028-2R2□-N	2.2	100	20, 30	0.020	6.0(5.40)	5.0(4.50)	2R2
LVF606028-4R7□-N	4.7	100	20, 30	0.036	4.0(3.60)	3.4(3.06)	4R7
LVF606028-6R8□-N	6.8	100	20, 30	0.048	3.2(2.88)	3.0(2.70)	6R8

- When ordering, please specify tolerance and packaging codes
- Tolerance : T = ±30% , M = ±20%
- L : Agilent/HP4284A+ Agilent/HP16334A, 100KHz, 1V
- RDC : Digital Milliohm Meter Chroma 16502, or equivalent
- Isat & Irms : Agilent/HP4284A, 100KHz 1V
- Isat for Inductance drop 30% from its value without current
- Irms for a 40°C rise above 25°C ambient
- Operating temperature range from -55°C to 125°C . (Including self - temperature rise)

Test Instruments : HP4284A Material/Impedance Analyzer

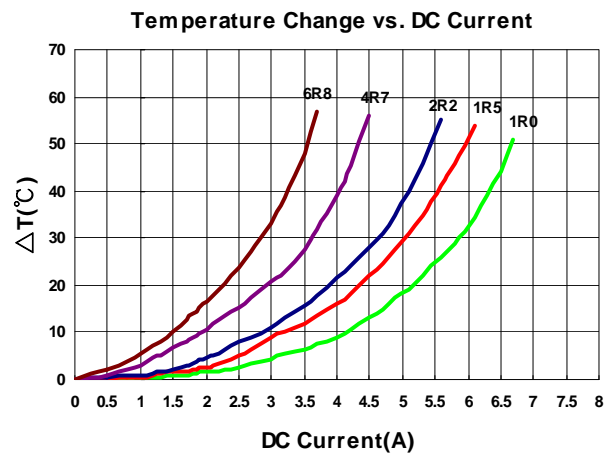
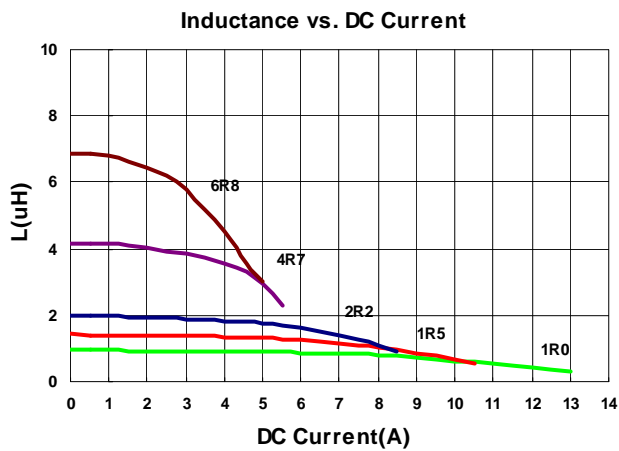

Electrical Characteristics

Part Number	Inductance (uH)	Test Frequency (KHz)	Tolerance (±%)	RDC (Ω) ±30%	Isat (A) Typ. (Max)	Irms (A) Typ. (Max)	Marking
LVF808040-4R7□-N	4.7	100	20, 30	0.020	6.8(6.12)	5.5(4.95)	4R7
LVF808040-100□-N	10	100	20, 30	0.038	5.0(4.50)	3.8(3.42)	100
LVF808040-150□-N	15	100	20, 30	0.057	4.0(3.60)	3.2(2.88)	150
LVF808040-220□-N	22	100	20, 30	0.082	3.4(3.06)	2.7(2.43)	220

- When ordering, please specify tolerance and packaging codes
- Tolerance : T = ±30% , M = ±20%
- L : Agilent/HP4284A+ Agilent/HP16334A, 100KHz, 1V
- RDC : Digital Milliohm Meter Chroma 16502, or equivalent
- Isat & Irms : Agilent/HP4284A, 100KHz 1V
- Isat for Inductance drop 30% from its value without current
- Irms for a 40°C rise above 25°C ambient
- Operating temperature range from -55°C to 125°C. (Including self - temperature rise)

Test Instruments : HP4284A Material/Impedance Analyzer

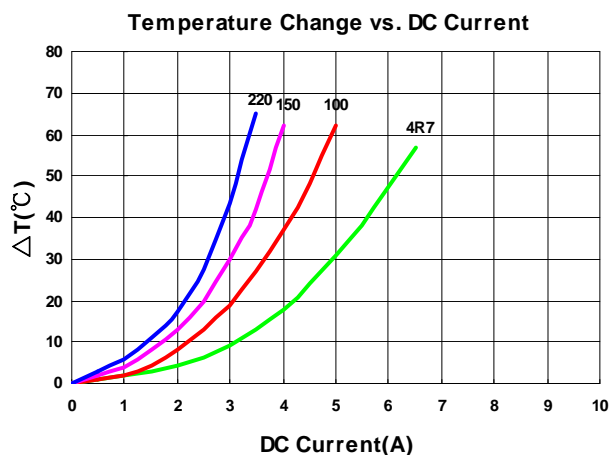
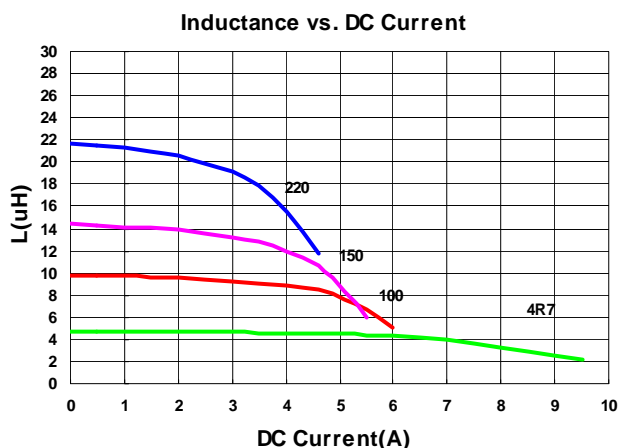

Packaging Specifications

Tape Dimensions

Figure 1

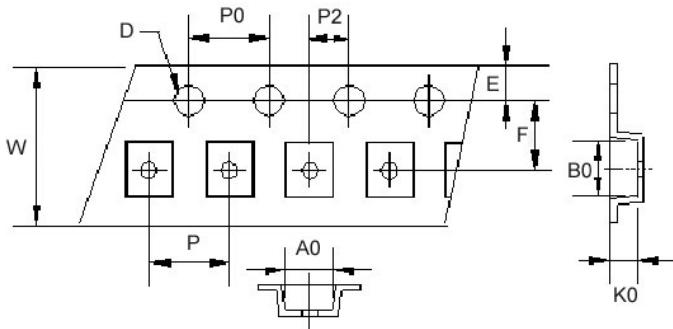

Reel Dimensions

Figure 1

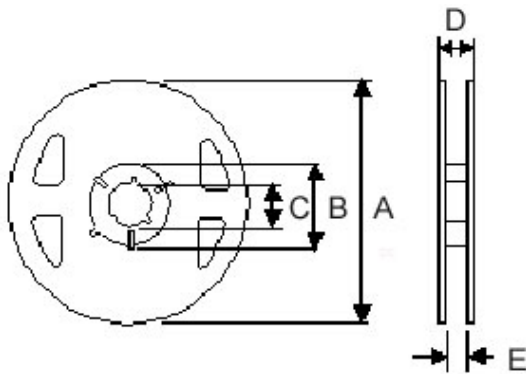

Tape Dimensions

Figure 2

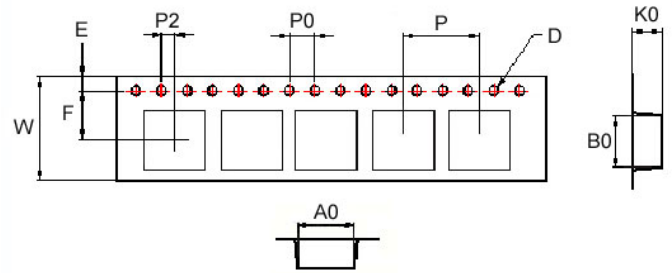

Reel Dimensions

Figure 2

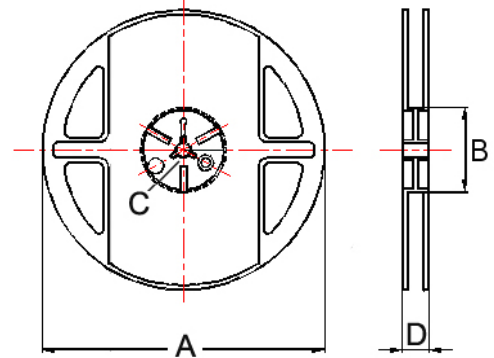

Dimensions in mm

TYPE	Fig	Tape Dimensions										Reel Dimensions					Quantity PCS / Reel
		A0	B0	K0	D	E	F	W	P	P0	P2	A	B	C	D	E	
LVF201B12	1	1.90	2.20	1.30	1.55	1.75	3.5	8	4	4	2	180	60	13	14.4	8.4	2000
LVF252A10	1	2.40	2.70	1.15	1.55	1.75	3.5	8	4	4	2	180	60	13	14.4	8.4	2000
LVF252A12	1	2.40	2.70	1.30	1.55	1.75	3.5	8	4	4	2	180	60	13	14.4	8.4	2000
LVF303010	1	3.20	3.20	1.40	1.55	1.75	3.5	8	4	4	2	180	60	13	14.4	8.4	2000
LVF303012	1	3.20	3.20	1.40	1.55	1.75	3.5	8	4	4	2	180	60	13	14.4	8.4	2000
LVF303015	1	3.15	3.15	1.60	1.55	1.75	3.5	8	4	4	2	180	60	13	14.4	8.4	2000
LVF404012	2	4.25	4.25	1.30	1.55	1.75	5.5	12	8	4	2	178	60	13	13.2	-	1000
LVF404015	2	4.25	4.25	1.70	1.55	1.75	5.5	12	8	4	2	178	60	13	13.2	-	1000
LVF404018	2	4.25	4.25	2.10	1.55	1.75	5.5	12	8	4	2	178	60	13	13.2	-	800
LVF404026	2	4.25	4.25	3.00	1.55	1.75	5.5	12	8	4	2	178	60	13	13.2	-	500
LVF505020	2	5.25	5.25	2.20	1.55	1.75	5.5	12	8	4	2	330	100	13	17.4	-	2000
LVF606020	2	6.25	6.25	2.20	1.55	1.75	5.5	16	8	4	2	330	100	13	17.4	-	2000
LVF606028	2	6.25	6.25	3.00	1.55	1.75	5.5	16	8	4	2	330	100	13	17.4	-	1500
LVF808040	2	8.25	8.25	4.15	1.55	1.75	5.5	16	8	4	2	330	100	13	17.4	-	1000

LVT Series

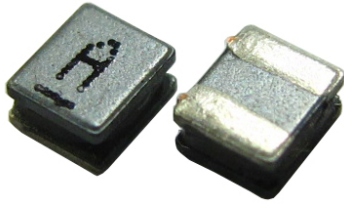

LVT series, an automatic assembly constructed power inductor, is shielded with magnetic resin and suitable for portable DC-DC converter applications.

Features

- RoHS compliant
- Low DC resistance and high current
- Highly accurate dimensions
- Superior EMI characteristics electrical with ultra low radiation comparing to conventional shielded power inductors
- Halogen free

Applications

- Smartphone
- DSC
- Tablet PC and other portable devices
- DC/DC converters

Product Identification

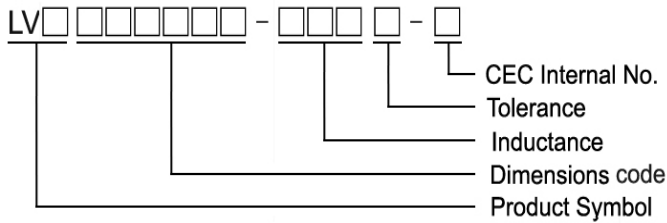

Shape and Dimensions

Figure 1

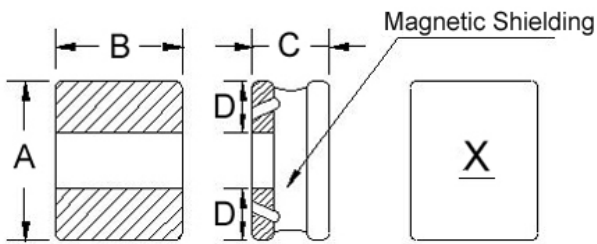
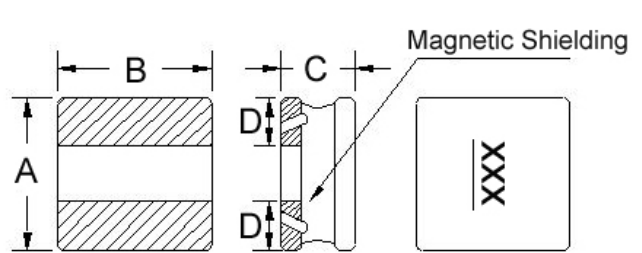

Figure 2



Dimensions in mm

TYPE	FIG	A	B	C	D	H	I	J
LVT201B10	1	2.0±0.25	1.6±0.25	1.02 Max	0.6	1.8	0.80	0.8
LVT252A10	1	2.5±0.25	2.0±0.25	1.02 Max	0.8	2.2	0.85	0.8
LVT252A12	1	2.5±0.25	2.0±0.25	1.2±0.05	0.8	2.2	0.85	0.8
LVT303010	2	3.0±0.20	3.0±0.20	1.02 Max	1.0	3.2	1.1	1.0
LVT303012	2	3.0±0.20	3.0±0.20	1.20 Max	1.0	3.2	1.1	1.0
LVT404012	2	4.0±0.20	4.0±0.20	1.2±0.1	1.5	4.2	1.5	1.2

Recommended Pattern

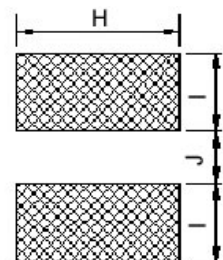

Shape and Dimensions

Figure 3

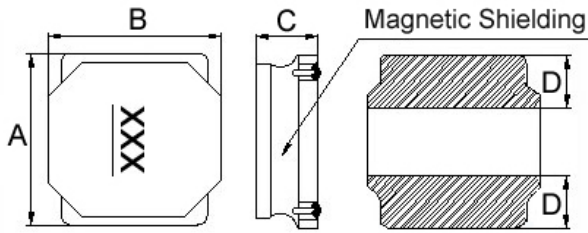

Recommended Pattern

Figure 4

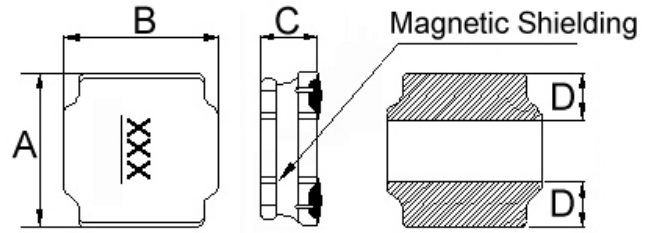

Dimensions in mm

TYPE	FIG	A	B	C	D	H	I	J
LVT404015	3	4.0±0.25	4.0±0.25	1.5±0.2	1.3	3.7	1.5	1.2
LVT404026	3	4.0±0.20	4.0±0.25	2.6±0.2	1.4	3.7	1.2	1.6
LVT505020	4	5.0±0.2	5.0±0.2	2.0±0.2	1.8±0.3	4.2	1.6	2.0
LVT606020	4	6.0±0.2	6.0±0.2	2.0±0.2	1.7±0.3	5.7	1.7	2.8
LVT808040	4	8.0±0.2	8.0±0.2	4.0 ^{+0.2} _{-0.30}	2.3±0.3	7.5	2.5	3.4

Recommended Pattern

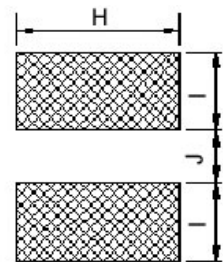

Electrical Characteristics

Part Number	Inductance (uH)	Test Frequency (MHz)	Tolerance (±%)	RDC (mΩ) ±30%	Isat (A) Typ. (Max)	Irms (A) Typ. (Max)	Marking
LVT201B10-R47□-N	0.47	1	20, 30	72	2.4(2.16)	2.4(2.16)	A

- When ordering, please specify tolerance and packaging codes
- Tolerance : T = ±30% , M = ±20%
- L : Agilent/HP4287A+ Agilent/HP16197A, 1MHz 200mV
- RDC : Digital Milliohm Meter Chroma 16502, or equivalent
- Isat & I rms : Agilent/HP4284A, 1MHz 200mV
- Isat for Inductance drop 30% from its value without current
- I rms for a 40°C rise above 25°C ambient
- Operating temperature range from -55°C to 125°C. (Including self - temperature rise)

Test Instruments : HP4284A Material/Impedance Analyzer

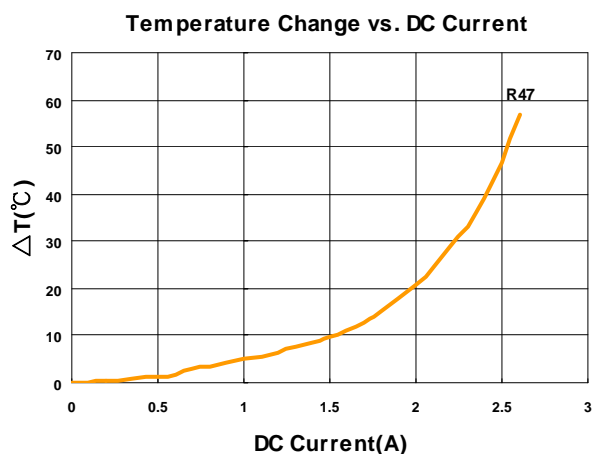
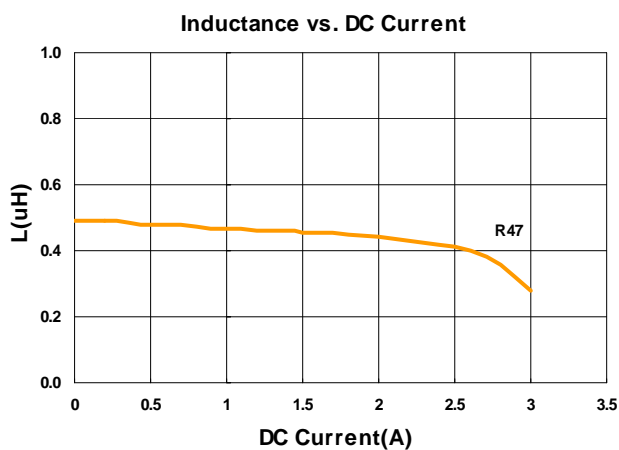

Electrical Characteristics

Part Number	Inductance (uH)	Test Frequency (MHz)	Tolerance (±%)	RDC (Ω) ±30%	Isat (A) Typ. (Max)	Irms (A) Typ. (Max)	Marking
LVT252A10-R68□-N	0.68	1	20, 30	0.050	2.40(2.160)	2.20(1.980)	K
LVT252A10-2R2□-N	2.2	1	20, 30	0.135	1.42(1.278)	1.55(1.395)	D
LVT252A10-3R3□-N	3.3	1	20, 30	0.220	1.12(1.008)	1.20(1.080)	E
LVT252A10-6R8□-N	6.8	1	20, 30	0.435	0.78(0.702)	0.84(0.756)	G

- When ordering, please specify tolerance and packaging codes
- Tolerance : T = ±30% , M = ±20%
- L : Agilent/HP4287A+ Agilent/HP16197A, 1MHz 200mV
- RDC : Digital Milliohm Meter Chroma 16502, or equivalent
- Isat & Irms : Agilent/HP4284A, 1MHz 200mV
- Isat for Inductance drop 30% from its value without current
- Irms for a 40°C rise above 25°C ambient
- Operating temperature range from -55°C to 125°C. (Including self - temperature rise)

Test Instruments : HP4284A Material/Impedance Analyzer

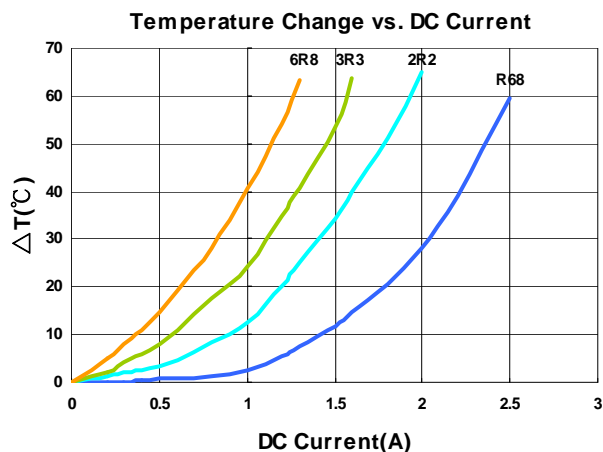
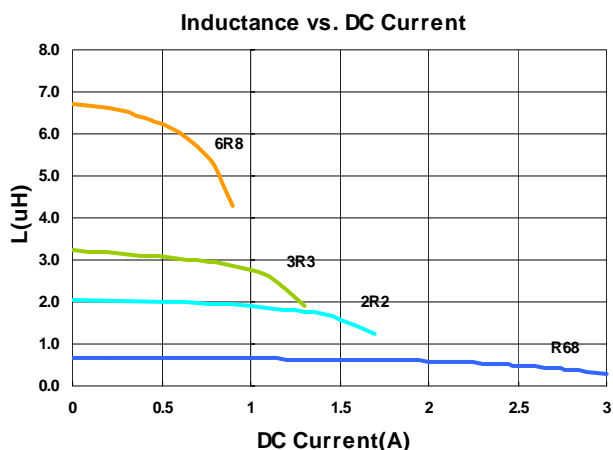

Electrical Characteristics

Part Number	Inductance (uH)	Test Frequency (MHz)	Tolerance (±%)	RDC (Ω) ±30%	Isat (A) Typ. (Max)	Irms (A) Typ. (Max)	Marking
LVT252A12-R47□-N	0.47	1	20, 30	0.027	3.70(3.330)	3.10(2.790)	A

- When ordering, please specify tolerance and packaging codes
- Tolerance : T = ±30% , M = ±20%
- L : Agilent/HP4287A+ Agilent/HP16197A, 1MHz 200mV
- RDC : Digital Milliohm Meter Chroma 16502, or equivalent
- Isat & I rms : Agilent/HP4284A, 1MHz 200mV
- Isat for Inductance drop 30% from its value without current
- I rms for a 40°C rise above 25°C ambient
- Operating temperature range from -55°C to 125°C. (Including self - temperature rise)

Test Instruments : HP4284A Material/Impedance Analyzer

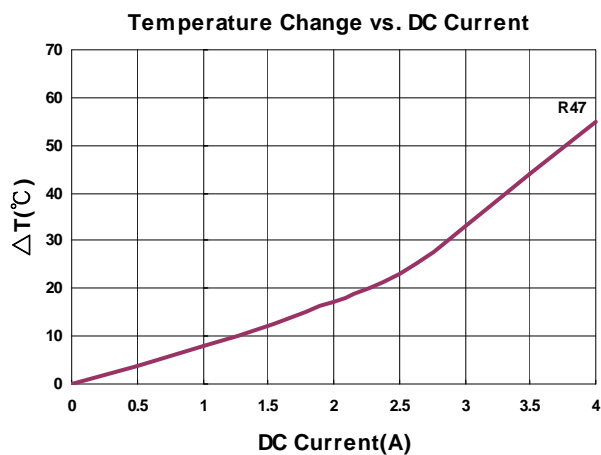
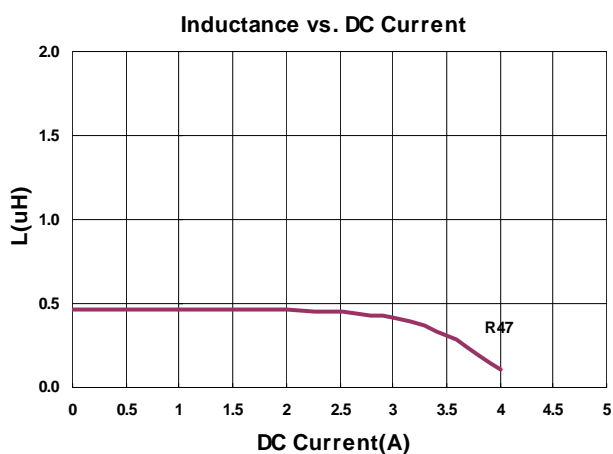

Electrical Characteristics

Part Number	Inductance (uH)	Test Frequency (MHz)	Tolerance (±%)	RDC (Ω) ±30%	Isat (A) Typ. (Max)	Irms (A) Typ. (Max)	Marking
LVT303010-1R0□-N	1.0	1	20, 30	0.063	2.4(2.16)	2.3(2.07)	1R0
LVT303010-3R3□-N	3.3	1	20, 30	0.165	1.2(1.08)	1.1(0.99)	3R3

- When ordering, please specify tolerance and packaging codes
- Tolerance : T = ±30% , M = ±20%
- L : Agilent/HP4287A+ Agilent/HP16197A, 1MHz 200mV
- RDC : Digital Milliohm Meter Chroma 16502, or equivalent
- Isat & Irms : Agilent/HP4284A, 1MHz 200mV
- Isat for Inductance drop 30% from its value without current
- Irms for a 40°C rise above 25°C ambient
- Operating temperature range from -55°C to 125°C. (Including self - temperature rise)

Test Instruments : HP4284A Material/Impedance Analyzer

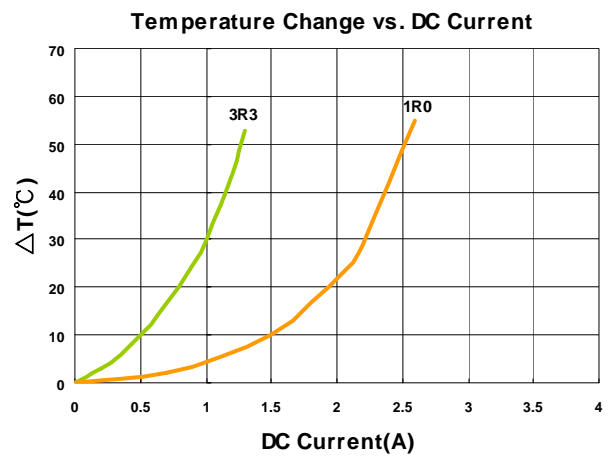
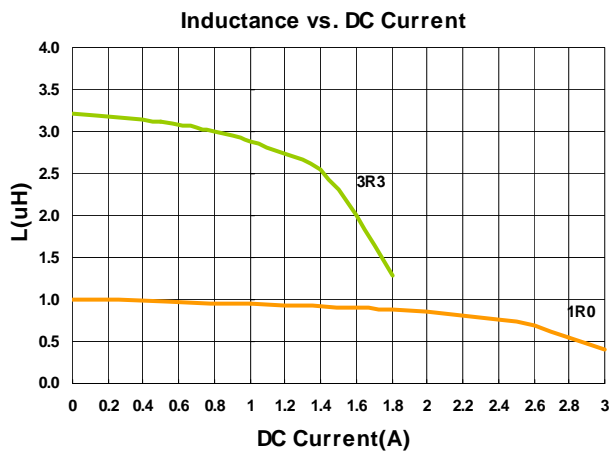

Electrical Characteristics

Part Number	Inductance (uH)	Test Frequency (MHz)	Tolerance (±%)	RDC (Ω) ±30%	Isat (A) Typ. (Max)	Irms (A) Typ. (Max)	Marking
LVT303012-R47□-N	0.47	1	20, 30	0.032	4.3(3.87)	4.0(3.60)	R47
LVT303012-1R0□-N	1.0	1	20, 30	0.060	3.1(2.79)	3.0(2.70)	1R0
LVT303012-1R5□-N	1.5	1	20, 30	0.072	2.7(2.43)	2.6(2.34)	1R5

- When ordering, please specify tolerance and packaging codes
- Tolerance : T = ±30% , M = ±20%
- L : Agilent/HP4287A+ Agilent/HP16197A, 1MHz 200mV
- RDC : Digital Milliohm Meter Chroma 16502, or equivalent
- Isat & I rms : Agilent/HP4284A, 1MHz 200mV
- Isat for Inductance drop 30% from its value without current
- I rms for a 40°C rise above 25°C ambient
- Operating temperature range from -55°C to 125°C . (Including self - temperature rise)

Test Instruments : HP4284A Material/Impedance Analyzer

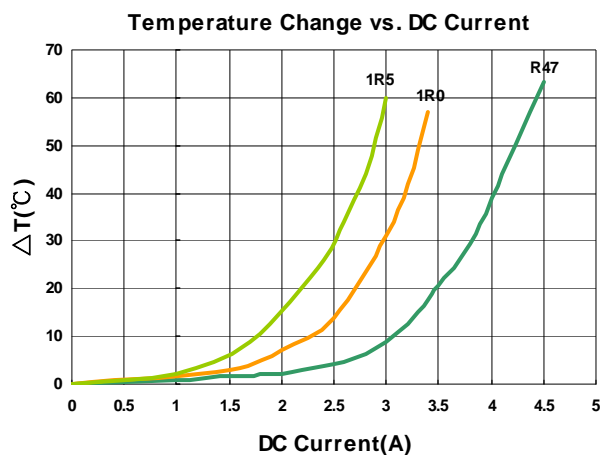
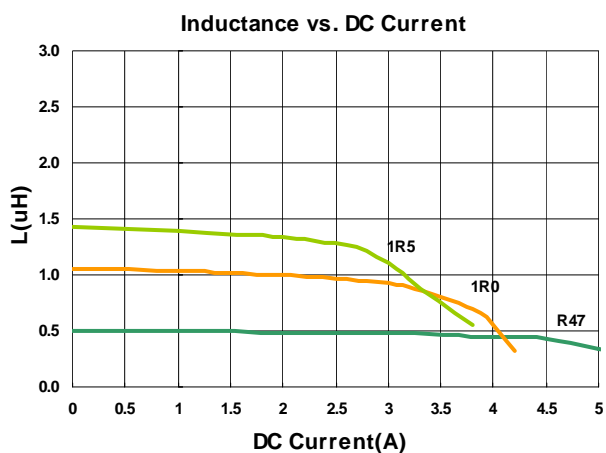

Electrical Characteristics

Part Number	Inductance (uH)	Test Frequency (MHz)	Tolerance (±%)	RDC (Ω) ±30%	Isat (A) Typ. (Max)	Irms (A) Typ. (Max)	Marking
LVT404012-R50□-N	0.5	1	20, 30	0.030	3.90(3.51)	3.50(3.15)	R50
LVT404012-1R0□-N	1.0	1	20, 30	0.040	2.90(2.61)	3.00(2.70)	1R0
LVT404012-1R5□-N	1.5	1	20, 30	0.051	2.30(2.07)	2.50(2.25)	1R5
LVT404012-2R2□-N	2.2	1	20, 30	0.060	1.90(1.71)	2.30(2.07)	2R2
LVT404012-4R7□-N	4.7	1	20, 30	0.094	1.32(1.18)	1.80(1.62)	4R7
LVT404012-6R8□-N	6.8	1	20, 30	0.135	1.08(0.97)	1.50(1.35)	6R8
LVT404012-150□-N	15	1	20, 30	0.260	0.78(0.70)	1.00(0.90)	150
LVT404012-220□-N	22	1	20, 30	0.390	0.62(0.55)	0.80(0.72)	220

- When ordering, please specify tolerance and packaging codes
- Tolerance : T = ±30% , M = ±20%
- L : Agilent/HP4287A+ Agilent/HP16197A, 1MHz 200mV
- RDC : Digital Milliohm Meter Chroma 16502, or equivalent
- Isat & Irms : Agilent/HP4284A, 1MHz 200mV
- Isat for Inductance drop 30% from its value without current
- Irms for a 40°C rise above 25°C ambient
- Operating temperature range from -55°C to 125°C. (Including self - temperature rise)

Test Instruments : HP4284A Material/Impedance Analyzer

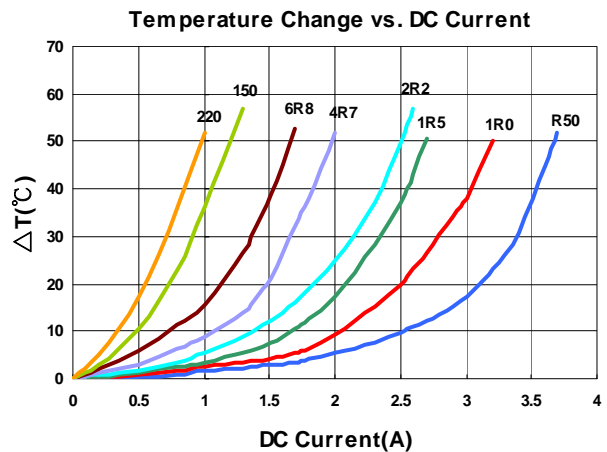
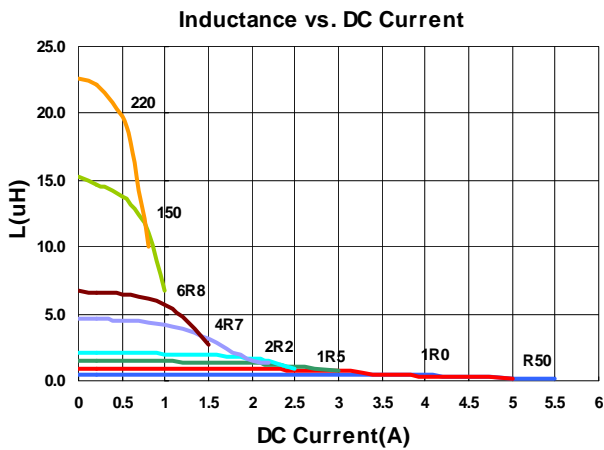

Electrical Characteristics

Part Number	Inductance (uH)	Test Frequency (MHz)	Tolerance (±%)	RDC (Ω) ±30%	Isat (A) Typ. (Max)	Irms (A) Typ. (Max)	Marking
LVT404015-1R0□-N	1.0	1	20, 30	0.034	3.60(3.24)	3.70(3.33)	1R0
LVT404015-3R3□-N	3.3	1	20, 30	0.080	2.00(1.80)	2.20(1.98)	3R3

- When ordering, please specify tolerance and packaging codes
- Tolerance : T = ±30% , M = ±20%
- L : Agilent/HP4287A+ Agilent/HP16197A, 1MHz 200mV
- RDC : Digital Milliohm Meter Chroma 16502, or equivalent
- Isat & I rms : Agilent/HP4284A, 1MHz 200mV
- Isat for Inductance drop 30% from its value without current
- I rms for a 40°C rise above 25°C ambient
- Operating temperature range from -55°C to 125°C. (Including self - temperature rise)

Test Instruments : HP4284A Material/Impedance Analyzer

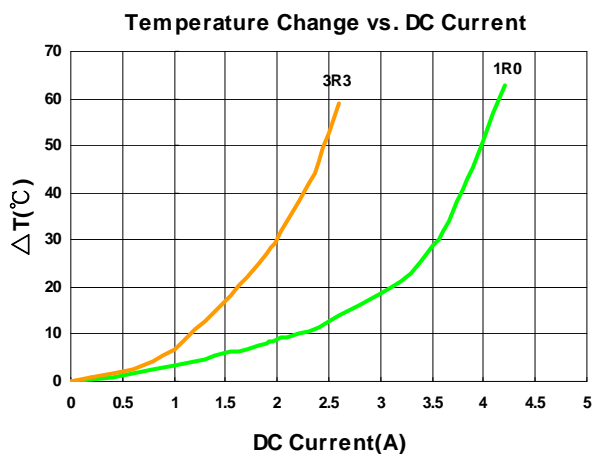
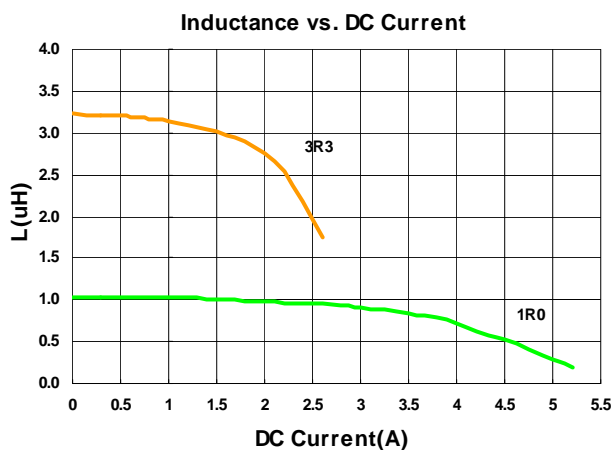

Electrical Characteristics

Part Number	Inductance (uH)	Test Frequency (KHz)	Tolerance (±%)	RDC (Ω) ±30%	Isat (A) Typ. (Max)	Irms (A) Typ. (Max)	Marking
LVT404026-R47□-N	0.47	100	20, 30	0.024	7.20(6.48)	4.80(4.32)	R47
LVT404026-R50□-N	0.50	100	20, 30	0.024	7.20(6.48)	4.80(4.32)	R50

- When ordering, please specify tolerance and packaging codes
- Tolerance : T = ±30% , M = ±20%
- L : Agilent/HP4284A+ Agilent/HP16334A, 100KHz ,1V
- RDC : Digital Milliohm Meter Chroma 16502, or equivalent
- Isat & Irms : Agilent/HP4284A, 100KHz 1V
- Isat for Inductance drop 30% from its value without current
- Irms for a 40°C rise above 25°C ambient
- Operating temperature range from -55°C to 125°C. (Including self - temperature rise)

Test Instruments : HP4284A Material/Impedance Analyzer

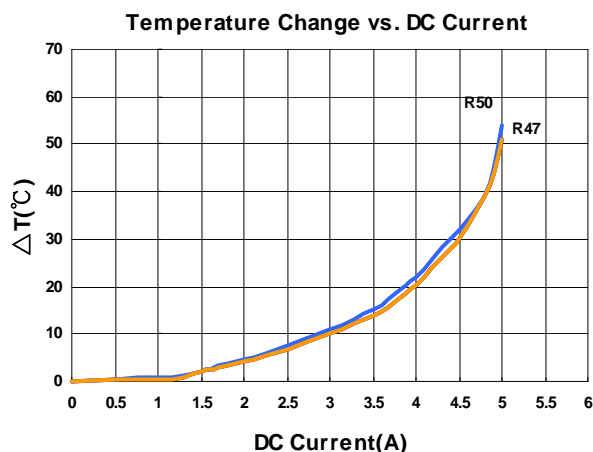
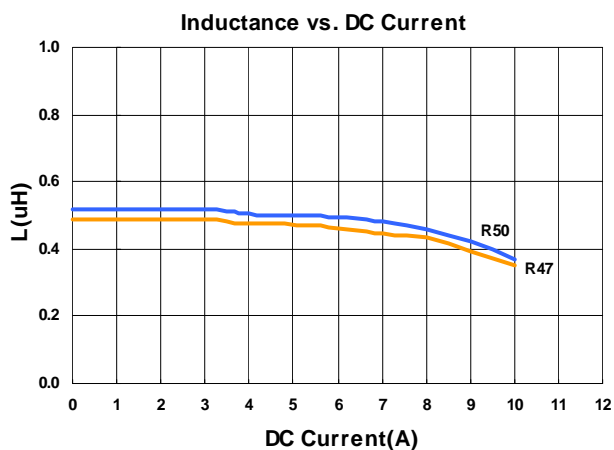

Electrical Characteristics

Part Number	Inductance (uH)	Test Frequency (KHz)	Tolerance (±%)	RDC (Ω) ±30%	Isat (A) Typ. (Max)	Irms (A) Typ. (Max)	Marking
LVT505020-3R3□-N	3.3	100	20, 30	0.050	3.4(3.06)	2.7(2.43)	3R3

- When ordering, please specify tolerance and packaging codes
- Tolerance : T = ±30% , M = ±20%
- L : Agilent/HP4284A+ Agilent/HP16334A, 100KHz 1V
- RDC : Digital Milliohm Meter Chroma 16502, or equivalent
- Isat & Irms : Agilent/HP4284A, 100KHz 1V
- Isat for Inductance drop 30% from its value without current
- Irms for a 40°C rise above 25°C ambient
- Operating temperature range from -55°C to 125°C. (Including self - temperature rise)

Test Instruments : HP4284A Material/Impedance Analyzer

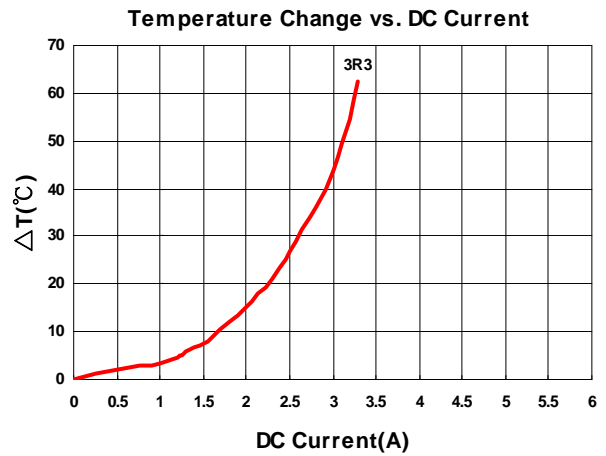
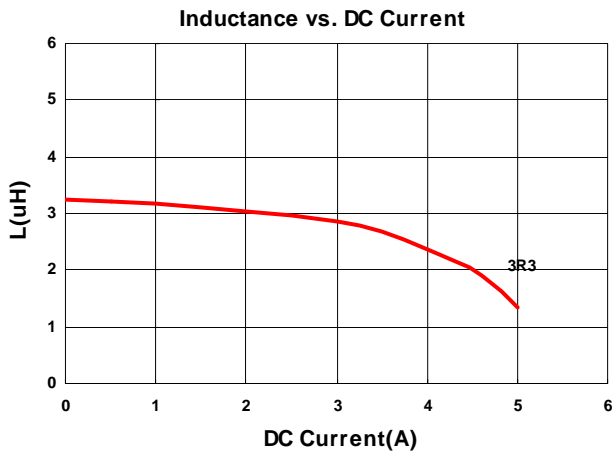

Electrical Characteristics

Part Number	Inductance (uH)	Test Frequency (KHz)	Tolerance (±%)	RDC (Ω) ±30%	Isat (A) Typ. (Max)	Irms (A) Typ. (Max)	Marking
LVT606020-1R0□-N	1.0	100	20, 30	0.019	6.4(5.76)	4.2(3.78)	1R0
LVT606020-1R5□-N	1.5	100	20, 30	0.026	5.4(4.86)	3.7(3.33)	1R5
LVT606020-2R2□-N	2.2	100	20, 30	0.034	4.5(4.05)	3.3(2.97)	2R2
LVT606020-3R3□-N	3.3	100	20, 30	0.045	3.6(3.24)	2.8(2.52)	3R3
LVT606020-6R8□-N	6.8	100	20, 30	0.085	2.6(2.34)	1.9(1.71)	6R8

- When ordering, please specify tolerance and packaging codes
- Tolerance : T = ±30% , M = ±20%
- L : Agilent/HP4284A+ Agilent/HP16334A, 100KHz 1V
- RDC : Digital Milliohm Meter Chroma 16502, or equivalent
- Isat & Irms : Agilent/HP4284A, 100KHz 1V
- Isat for Inductance drop 30% from its value without current
- Irms for a 40°C rise above 25°C ambient
- Operating temperature range from -55°C to 125°C . (Including self - temperature rise)

Test Instruments : HP4284A Material/Impedance Analyzer

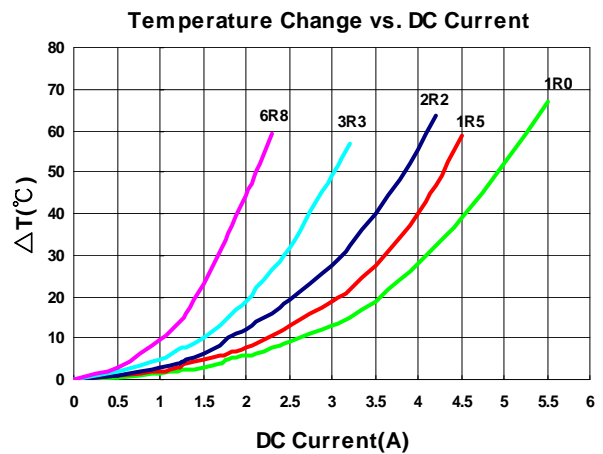
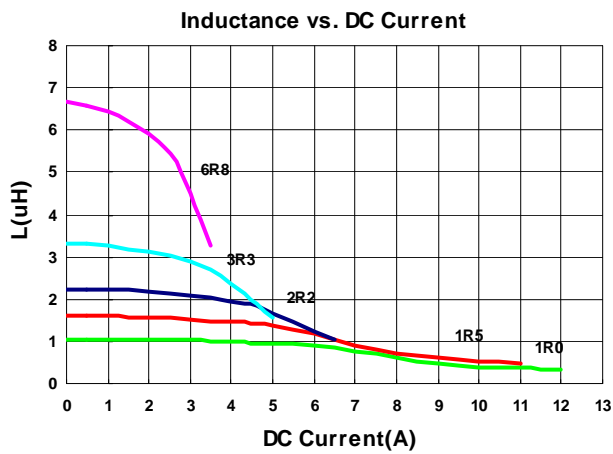

Electrical Characteristics

Part Number	Inductance (uH)	Test Frequency (KHz)	Tolerance (±%)	RDC (Ω) ±30%	Isat (A) Typ. (Max)	Irms (A) Typ. (Max)	Marking
LVT808040-1R0□-N	1.0	100	30	0.0075	13.5(12.15)	8.1(7.29)	1R0
LVT808040-1R5□-N	1.5	100	20, 30	0.0097	10.5(9.45)	7.7(6.93)	1R5
LVT808040-2R2□-N	2.2	100	20, 30	0.012	9.7(8.73)	7.2(6.48)	2R2
LVT808040-3R3□-N	3.3	100	20, 30	0.047	8.0(7.20)	5.9(5.31)	3R3
LVT808040-6R8□-N	6.8	100	20, 30	0.029	5.8(5.22)	4.9(4.41)	6R8

- When ordering, please specify tolerance and packaging codes
- Tolerance : T = ±30% , M = ±20%
- L : Agilent/HP4284A+ Agilent/HP16334A, 100KHz 1V
- RDC : Digital Milliohm Meter Chroma 16502, or equivalent
- Isat & Irms : Agilent/HP4284A, 100KHz 1V
- Isat for Inductance drop 30% from its value without current
- Irms for a 40°C rise above 25°C ambient
- Operating temperature range from -55°C to 125°C . (Including self - temperature rise)

Test Instruments : HP4284A Material/Impedance Analyzer

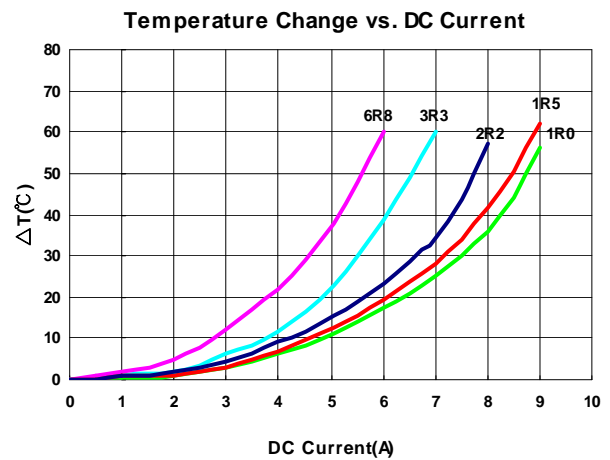
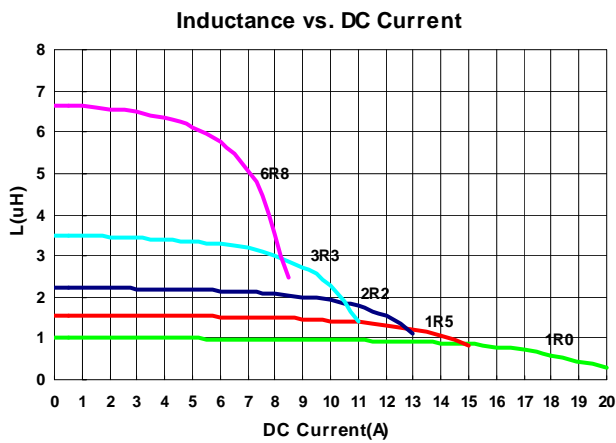

Packaging Specifications

Tape Dimensions

Figure 1

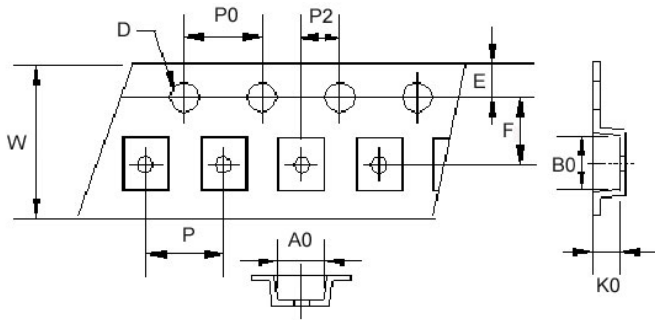

Tape Dimensions

Figure 2

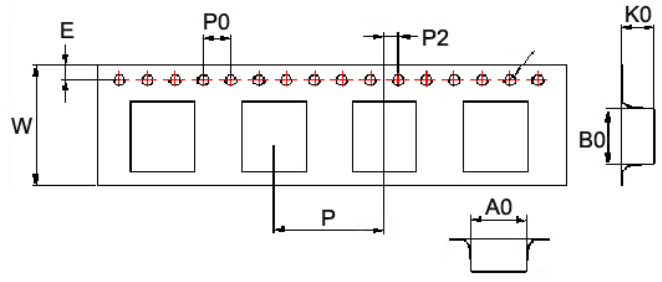

Reel Dimensions

Figure 1

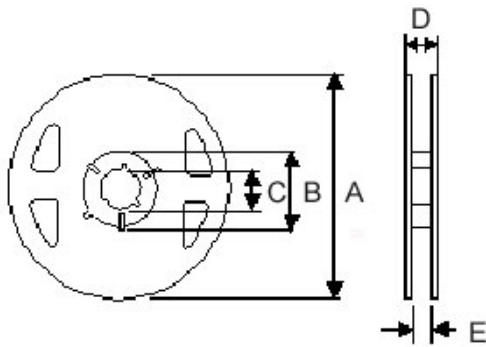

Reel Dimensions

Figure 2

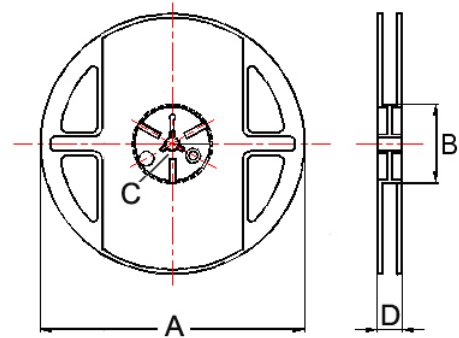

Dimensions in mm

TYPE	Fig	Tape Dimensions										Reel Dimensions					Quantity PCS / Reel
		A0	B0	K0	D	E	F	W	P	P0	P2	A	B	C	D	E	
LVT201B10	1	1.90	2.20	1.15	1.55	1.75	3.5	8	4	4	2	180	60	13	14.4	8.4	2000
LVT252A10	1	2.40	2.70	1.15	1.55	1.75	3.5	8	4	4	2	180	60	13	14.4	8.4	2000
LVT252A12	1	2.40	2.70	1.30	1.55	1.75	3.5	8	4	4	2	180	60	13	14.4	8.4	2000
LVT303010	1	3.20	3.20	1.40	1.55	1.75	3.5	8	4	4	2	180	60	13	14.4	8.4	2000
LVT303012	1	3.20	3.20	1.40	1.55	1.75	3.5	8	4	4	2	180	60	13	14.4	8.4	2000
LVT404012	2	4.25	4.25	1.30	1.55	1.75	5.5	12	8	4	2	178	60	13	13.2	-	1000
LVT404015	2	4.25	4.25	1.70	1.55	1.75	5.5	12	8	4	2	178	60	13	13.2	-	1000
LVT404026	2	4.25	4.25	3.00	1.55	1.75	5.5	12	8	4	2	178	60	13	13.2	-	500
LVT505020	2	5.25	5.25	2.20	1.55	1.75	5.5	12	8	4	2	330	100	13	13.4	-	2000
LVT606020	2	6.25	6.25	2.20	1.55	1.75	7.5	16	8	4	2	330	100	13	17.4	-	2000
LVT808040	2	8.25	8.25	4.15	1.55	1.75	7.5	16	12	4	2	330	100	13	17.4	-	1000

LVC Series

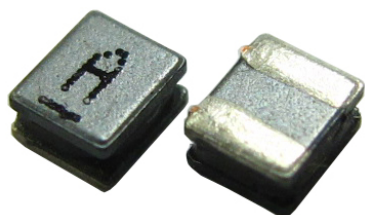

LVC series, an automatic assembly constructed power inductor, is shielded with magnetic resin and suitable for portable DC-DC converter application.

Features

- RoHS compliant
- Low DC resistance and high current
- Highly accurate dimensions
- Superior EMI characteristics with ultra low radiation comparing to conventional shielded power inductors
- Halogen free

Applications

- Smart phone
- DSC
- Tablet PC and other portable devices
- DC/DC converters

Product Identification

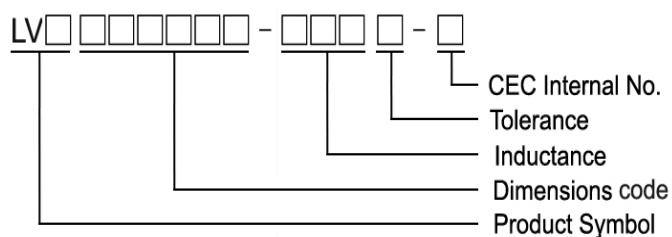

Shape and Dimensions

Figure 1

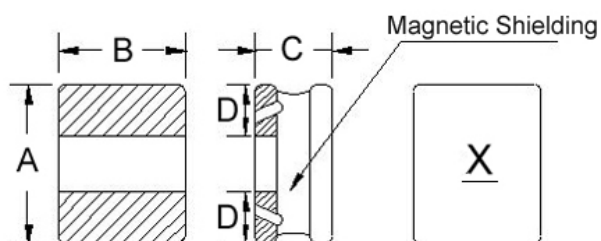

Recommended Pattern

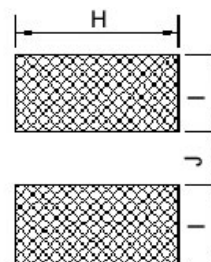

Dimensions in mm

TYPE	FIG	A	B	C	D	H	I	J
LVC201B10	1	2.0±0.25	1.6±0.25	1.02 Max	0.6	1.8	0.80	0.8
LVC201B12	1	2.0±0.25	1.6±0.25	1.2±0.05	0.6	1.8	0.80	0.8
LVC252A12	1	2.5±0.25	2.0±0.25	1.2±0.05	0.8	2.2	0.85	0.8

Shape and Dimensions

Figure 2

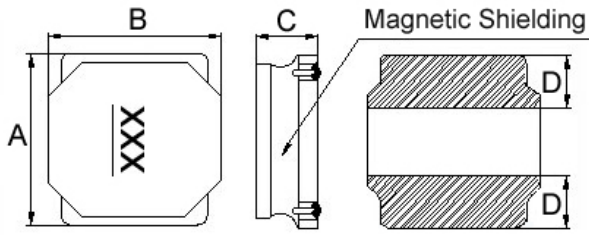

Recommended Pattern

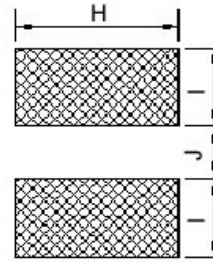

Dimensions in mm

TYPE	FIG	A	B	C	D	H	I	J
LVC404018	2	4.0±0.20	4.0±0.20	1.8±0.2	1.3	3.7	1.5	1.2
LVC606028	2	6.0±0.20	6.0±0.20	2.8±0.2	1.9±0.3	5.7	1.8	2.6

Shape and Dimensions

Figure 3

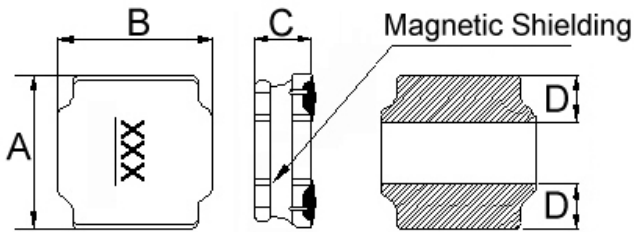

Recommended Pattern

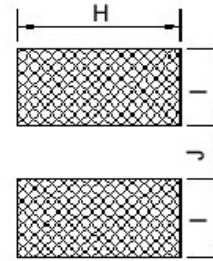

Dimensions in mm

TYPE	FIG	A	B	C	D	H	I	J
LVC505040	3	5.0±0.20	5.0±0.20	4.0±0.2	1.5	4.2	1.6	2.0
LVC606045	3	6.0±0.20	6.0±0.20	4.5 ^{+0.2} _{-0.30}	1.8±0.3	5.7	2.0	2.4

Electrical Characteristics

Part Number	Inductance (uH)	Test Frequency (MHz)	Tolerance (±%)	RDC (Ω) ±30%	Isat (A) Typ. (Max)	Irms (A) Typ. (Max)	Marking
LVC201B10-R24□-N	0.24	1	20, 30	0.026	3.20(2.88)	3.00(2.70)	M
LVC201B10-1R0□-N	1.0	1	20, 30	0.095	1.86(1.67)	1.86(1.67)	B
LVC201B10-1R5□-N	1.5	1	20, 30	0.140	1.64(1.47)	1.65(1.48)	C
LVC201B10-2R2□-N	2.2	1	20, 30	0.190	1.30(1.17)	1.30(1.17)	D
LVC201B10-3R3□-N	3.3	1	20, 30	0.295	0.96(0.86)	0.98(0.88)	E
LVC201B10-4R7□-N	4.7	1	20, 30	0.360	0.84(0.75)	0.90(0.81)	F
LVC201B10-6R8□-N	6.8	1	20, 30	0.640	0.66(0.59)	0.70(0.63)	G
LVC201B10-100□-N	10	1	20, 30	1.000	0.54(0.48)	0.56(0.50)	H
LVC201B10-150□-N	15	1	20, 30	1.500	0.39(0.35)	0.42(0.37)	K
LVC201B10-180□-N	18	1	20, 30	1.600	0.39(0.35)	0.41(0.36)	J
LVC201B10-220□-N	22	1	20, 30	1.700	0.38(0.34)	0.40(0.36)	I

- When ordering, please specify tolerance and packaging codes
- Tolerance : T = ±30% , M = ±20%
- L : Agilent/HP4287A+ Agilent/HP16197A, 1MHz 200mV
- RDC : Digital Milliohm Meter Chroma 16502, or equivalent
- Isat & Iirms : Agilent/HP4284A, 1MHz 200mV
- Isat for Inductance drop 30% from its value without current
- Iirms for a 40°C rise above 25°C ambient
- Operating temperature range from -55°C to 125°C . (Including self - temperature rise)

Test Instruments : HP4284A Material/Impedance Analyzer

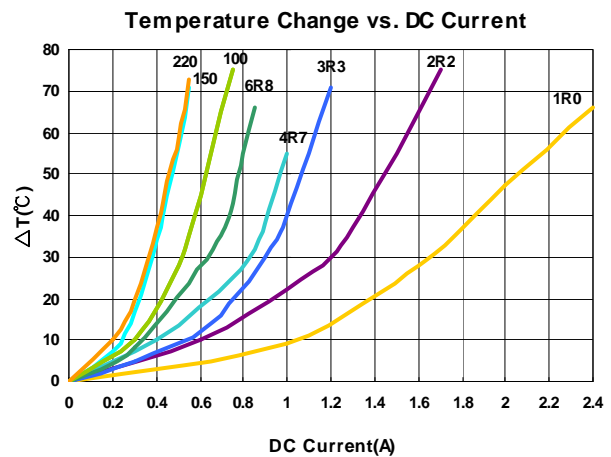
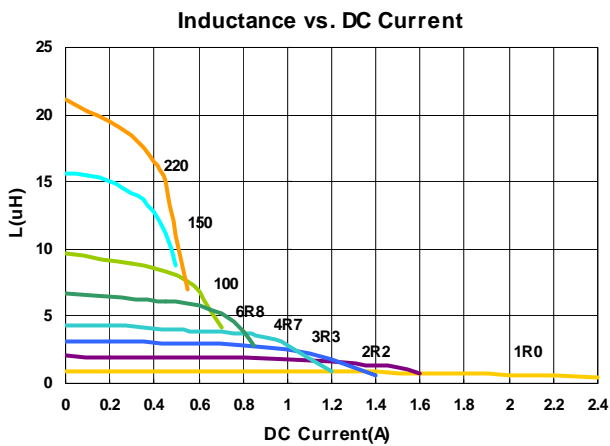

Electrical Characteristics

Part Number	Inductance (uH)	Test Frequency (MHz)	Tolerance (±%)	RDC (Ω) ±30%	Isat (A) Typ. (Max)	Irms (A) Typ. (Max)	Marking
LVC201B12-R50□-N	0.5	1	20, 30	0.051	2.60(2.34)	2.30(2.07)	B
LVC201B12-1R0□-N	1.0	1	20, 30	0.083	1.90(1.71)	1.80(1.62)	C
LVC201B12-2R2□-N	2.2	1	20, 30	0.159	1.36(1.22)	1.34(1.20)	E
LVC201B12-3R3□-N	3.3	1	20, 30	0.220	1.10(0.99)	1.06(0.95)	F
LVC201B12-4R7□-N	4.7	1	20, 30	0.330	0.92(0.82)	0.90(0.81)	G
LVC201B12-100□-N	10	1	20, 30	0.580	0.62(0.55)	0.58(0.52)	I
LVC201B12-150□-N	15	1	20, 30	0.900	0.48(0.43)	0.45(0.40)	J
LVC201B12-220□-N	22	1	20, 30	1.400	0.40(0.36)	0.40(0.36)	K

- When ordering, please specify tolerance and packaging codes
- Tolerance : T = ±30% , M = ±20%
- L : Agilent/HP4287A+ Agilent/HP16197A, 1MHz 200mV
- RDC : Digital Milliohm Meter Chroma 16502, or equivalent
- Isat & I rms : Agilent/HP4284A, 1MHz 200mV
- Isat for Inductance drop 30% from its value without current
- I rms for a 40°C rise above 25°C ambient
- Operating temperature range from -55°C to 125°C. (Including self - temperature rise)

Test Instruments : HP4284A Material/Impedance Analyzer

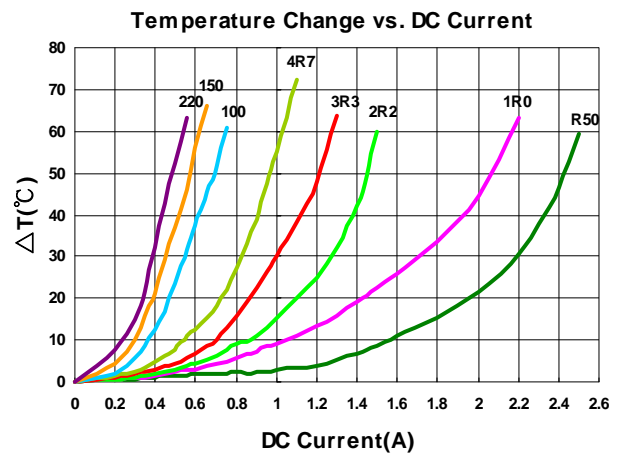
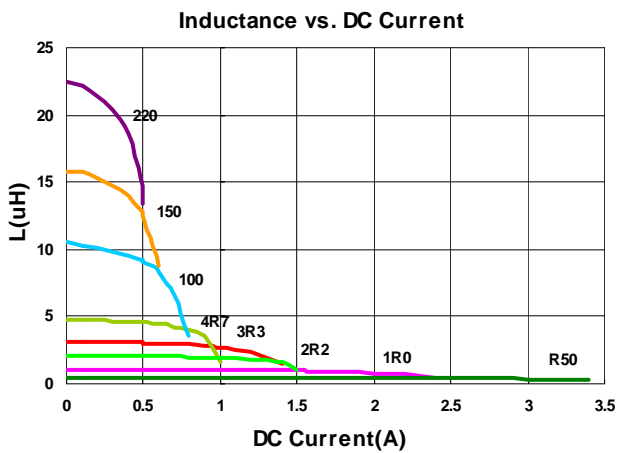

Electrical Characteristics

Part Number	Inductance (uH)	Test Frequency (MHz)	Tolerance (±%)	RDC (Ω) ±30%	Isat (A) Typ. (Max)	Irms (A) Typ. (Max)	Marking
LVC252A12-R68□-N	0.68	1	20, 30	0.035	2.80(2.52)	2.60(2.34)	N

- When ordering, please specify tolerance and packaging codes
- Tolerance : T = ±30% , M = ±20%
- L : Agilent/HP4287A+ Agilent/HP16197A, 1MHz 200mV
- RDC : Digital Milliohm Meter Chroma 16502, or equivalent
- Isat & I rms : Agilent/HP4284A, 1MHz 200mV
- Isat for Inductance drop 30% from its value without current
- I rms for a 40°C rise above 25°C ambient
- Operating temperature range from -55°C to 125°C. (Including self - temperature rise)

Test Instruments : HP4284A Material/Impedance Analyzer

Inductance vs. DC Current

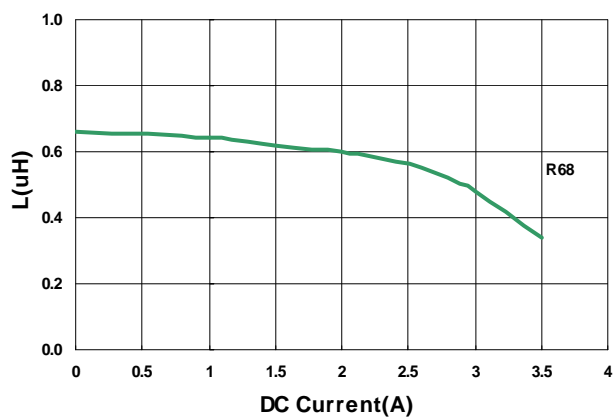

Temperature Change vs. DC Current

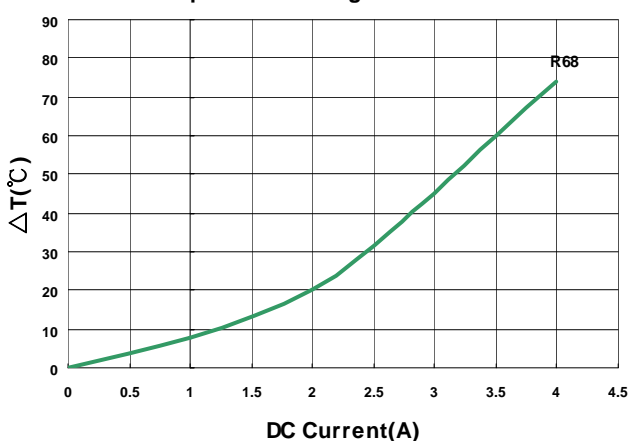

Electrical Characteristics

Part Number	Inductance (uH)	Test Frequency (KHz)	Tolerance (±%)	RDC (Ω) ±30%	Isat (A) Typ. (Max)	Irms (A) Typ. (Max)	Marking
LVC404018-4R7□-N	4.7	100	20, 30	0.077	2.00(1.80)	1.80(1.62)	4R7
LVC404018-6R8□-N	6.8	100	20, 30	0.105	1.50(1.35)	1.35(1.21)	6R8
LVC404018-100□-N	10	100	20, 30	0.160	1.40(1.26)	1.20(1.08)	100
LVC404018-150□-N	15	100	20, 30	0.245	1.05(0.94)	0.95(0.85)	150
LVC404018-220□-N	22	100	20, 30	0.335	0.90(0.81)	0.88(0.79)	220

- When ordering, please specify tolerance and packaging codes
- Tolerance : M = ±20% , T = ±30%
- L : Agilent/HP 4284A + Agilent/HP 16334A, 100KHz with 1V
- Isat & Irms : Agilent/HP 4284A, 100KHz with 1V
- Rdc : Digital Milliohm Meter Chroma 16502, or equivalent
- Isat for Inductance drop 30% from its value without current
- Irms for a 40°C rise above 25°C ambient
- Operating temperature range from -55°C to 125°C. (Including self - temperature rise)

Test Instruments : HP4284A Material/Impedance Analyzer

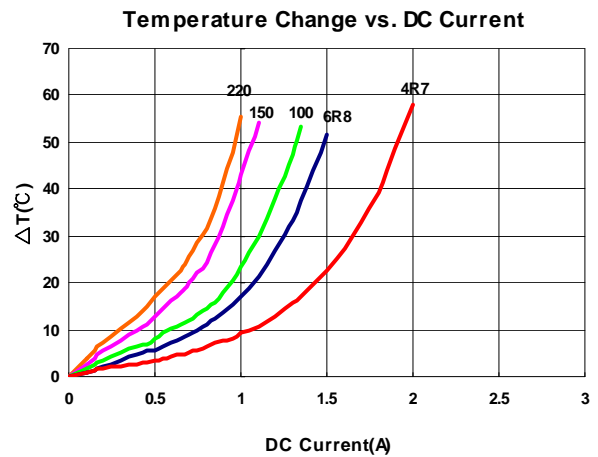
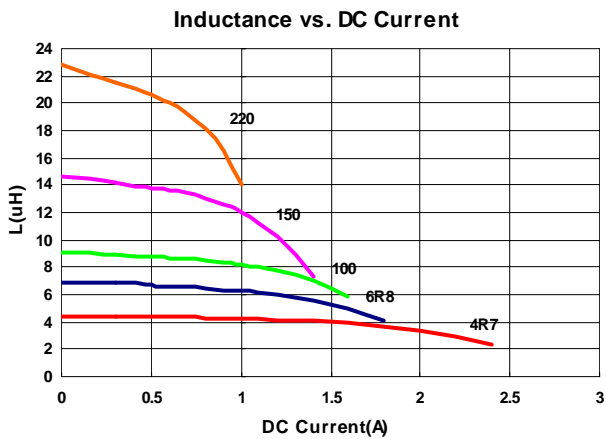

Electrical Characteristics

Part Number	Inductance (uH)	Test Frequency (KHz)	Tolerance (±%)	RDC (Ω ±30%)	Isat (A) Typ. (Max)	Irms (A) Typ. (Max)	Marking
LVC505040-1R0□-N	1.0	100	20, 30	0.012	8.8(7.92)	5.9(5.31)	1R0
LVC505040-1R5□-N	1.5	100	20,30	0.014	7.9(7.11)	5.4(4.86)	1R5
LVC505040-2R2□-N	2.2	100	20, 30	0.020	6.8(6.12)	4.5(4.05)	2R2
LVC505040-3R3□-N	3.3	100	20, 30	0.026	5.3(4.77)	4.2(3.78)	3R3
LVC505040-4R7□-N	4.7	100	20, 30	0.032	4.4(3.96)	3.2(2.88)	4R7
LVC505040-6R8□-N	6.8	100	20, 30	0.050	3.8(3.42)	3.0(2.70)	6R8
LVC505040-100□-N	10	100	20, 30	0.070	3.0(2.70)	2.3(2.07)	100
LVC505040-150□-N	15	100	20, 30	0.115	2.4(2.16)	1.8(1.62)	150
LVC505040-220□-N	22	100	20, 30	0.160	2.0(1.80)	1.6(1.44)	220

- When ordering, please specify tolerance and packaging codes
- Tolerance : M = ±20% , T = ±30%
- L : Agilent/HP 4284A + Agilent/HP 16334A, 100KHz with 1V
- Isat & Iirms : Agilent/HP 4284A, 100KHz with 1V
- Rdc : Digital Milliohm Meter Chroma 16502, or equivalent
- Isat for Inductance drop 30% from its value without current
- Iirms for a 40°C rise above 25°C ambient
- Operating temperature range from -55°C to 125°C. (Including self - temperature rise)

Test Instruments : HP4284A Material/Impedance Analyzer

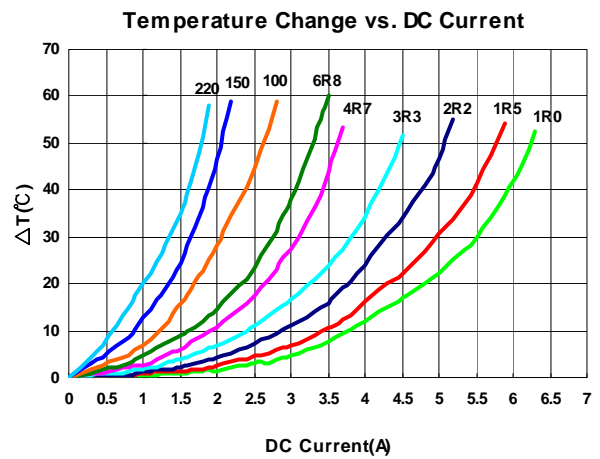
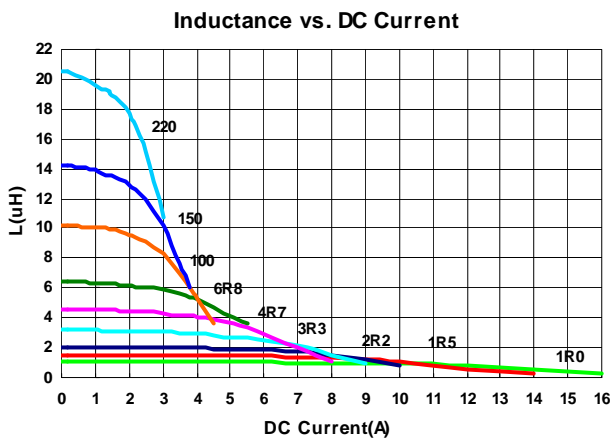

Electrical Characteristics

Part Number	Inductance (uH)	Test Frequency (KHz)	Tolerance (±%)	RDC (Ω ±30%)	Isat (A) Typ. (Max)	Irms (A) Typ. (Max)	Marking
LVC606028-3R3□-N	3.3	100	20, 30	0.027	4.5(4.05)	4.0(3.60)	3R3
LVC606028-100□-N	10	100	20, 30	0.065	2.6(2.34)	2.5(2.25)	100
LVC606028-150□-N	15	100	20, 30	0.093	2.1(1.89)	2.0(1.80)	150
LVC606028-220□-N	22	100	20, 30	0.135	1.7(1.53)	1.65(1.48)	220

- When ordering, please specify tolerance and packaging codes
- Tolerance : M = ±20% , T = ±30%
- L : Agilent/HP 4284A + Agilent/HP 16334A, 100KHz with 1V
- Isat & Irms : Agilent/HP 4284A, 100KHz with 1V
- Rdc : Digital Milliohm Meter Chroma 16502, or equivalent
- Isat for Inductance drop 30% from its value without current
- Irms for a 40°C rise above 25°C ambient
- Operating temperature range from -55°C to 125°C. (Including self - temperature rise)

Test Instruments : HP4284A Material/Impedance Analyzer

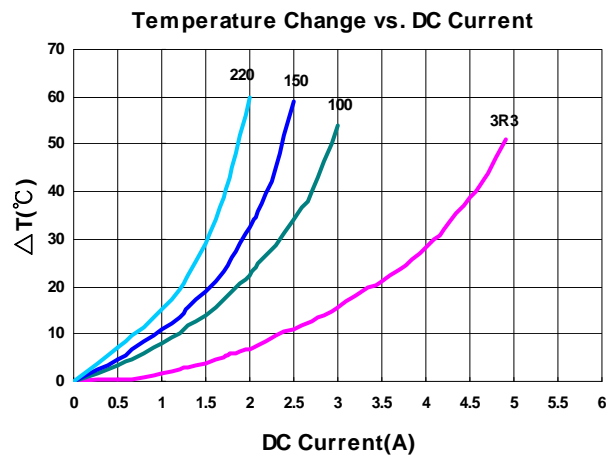
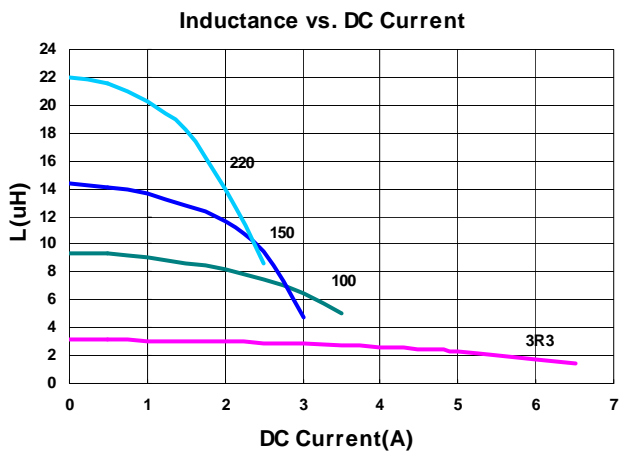

Electrical Characteristics

Part Number	Inductance (uH)	Test Frequency (KHz)	Tolerance (±%)	RDC (Ω) ±30%	Isat (A) Typ. (Max)	Irms (A) Typ. (Max)	Marking
LVC606045-1R0□-N	1.0	100	30	0.010	13(11.7)	7.3(6.57)	1R0
LVC606045-1R5□-N	1.5	100	20,30	0.012	12(10.8)	6.6(5.94)	1R5
LVC606045-2R2□-N	2.2	100	20, 30	0.018	9.5(8.55)	5.2(4.68)	2R2
LVC606045-3R3□-N	3.3	100	20, 30	0.022	7.8(7.02)	4.4(3.96)	3R3
LVC606045-4R7□-N	4.7	100	20, 30	0.030	6.8(6.12)	4.0(3.60)	4R7
LVC606045-6R8□-N	6.8	100	20, 30	0.042	5.7(5.13)	3.3(2.97)	6R8
LVC606045-100□-N	10	100	20, 30	0.060	4.6(4.14)	2.6(2.34)	100
LVC606045-150□-N	15	100	20, 30	0.090	3.8(3.42)	2.2(1.98)	150
LVC606045-220□-N	22	100	20, 30	0.130	3.3(2.97)	1.9(1.71)	220

- When ordering, please specify tolerance and packaging codes
- Tolerance : M = ±20% , T = ±30%
- L : Agilent/HP 4284A + Agilent/HP 16334A, 100KHz with 1V
- Isat & Irms : Agilent/HP 4284A, 100KHz with 1V
- Rdc : Digital Milliohm Meter Chroma 16502, or equivalent
- Isat for Inductance drop 30% from its value without current
- Irms for a 40°C rise above 25°C ambient
- Operating temperature range from -55°C to 125°C. (Including self - temperature rise)

Test Instruments : HP4284A Material/Impedance Analyzer

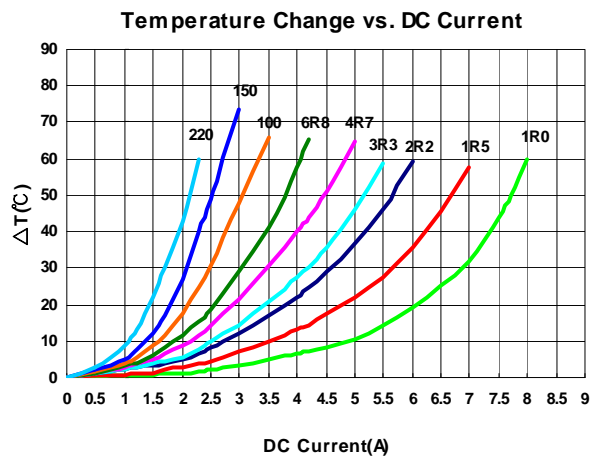
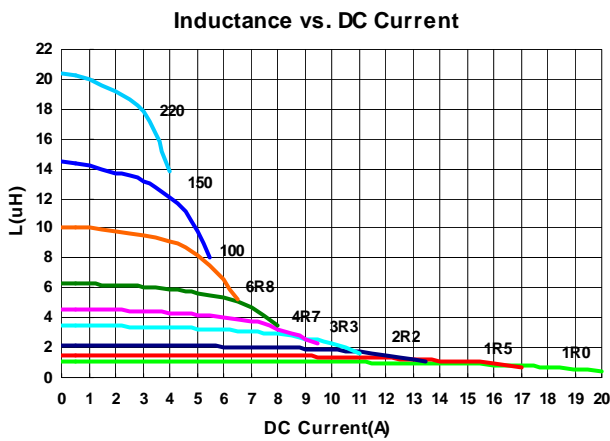

Packaging Specifications

Tape Dimensions

Figure 1

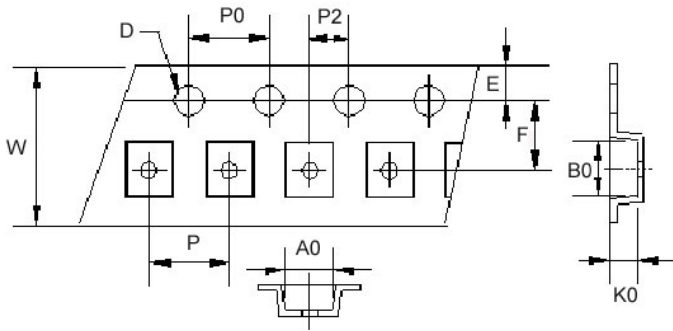
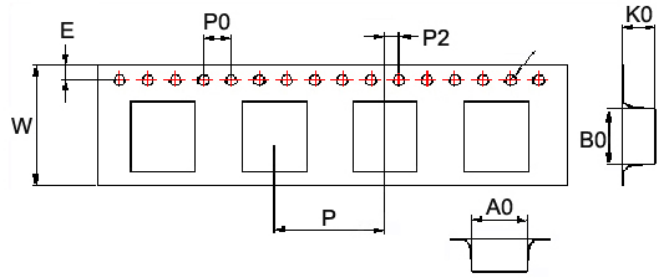

Figure 2



Reel Dimensions

Figure 1

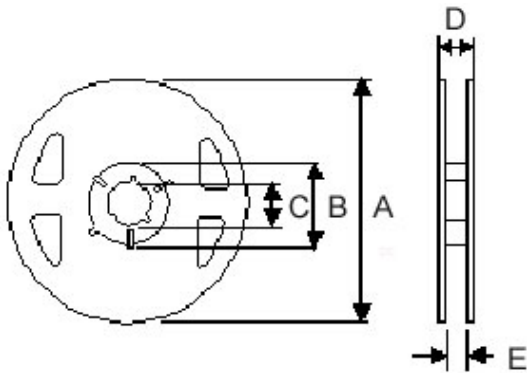
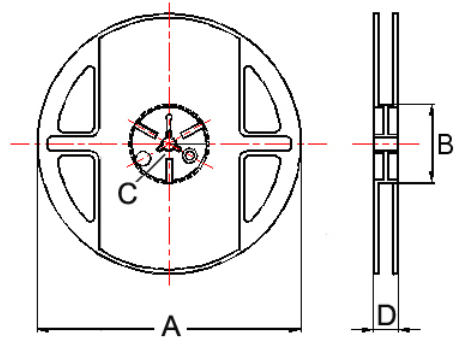

Figure 2



Dimensions in mm

TYPE	Fig	Tape Dimensions										Reel Dimensions					Quantity PCS / Reel
		A0	B0	K0	D	E	F	W	P	P0	P2	A	B	C	D	E	
LVC201B10	1	1.90	2.20	1.15	1.55	1.75	3.5	8	4	4	2	180	60	13	14.4	8.4	2000
LVC201B12	1	1.90	2.20	1.30	1.55	1.75	3.5	8	4	4	2	180	60	13	14.4	8.4	2000
LVC252A12	1	2.40	2.70	1.30	1.55	1.75	3.5	8	4	4	2	180	60	13	14.4	8.4	2000
LVC404018	2	4.25	4.25	2.10	1.55	1.75	5.5	12	8	4	2	178	60	13	13.2	-	800
LVC505040	2	5.30	5.30	4.40	1.55	1.75	5.5	12	8	4	2	330	100	13	13.4	-	1500
LVC606028	2	6.25	6.25	3.00	1.55	1.75	7.5	16	12	4	2	330	100	13	17.4	-	1500
LVC606045	2	6.25	6.25	4.65	1.55	1.75	7.5	16	12	4	2	330	100	13	17.4	-	1000

LVH Series

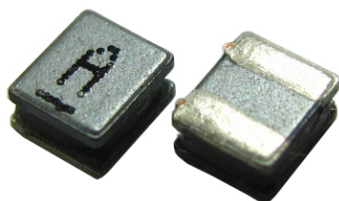

LVH series, an automatic assembly constructed power inductor, is shielded with magnetic resin and suitable for portable DC-DC converter applications.

Features

- RoHS compliant
- Low DC resistance and high current
- Highly accurate dimensions
- Superior EMI characteristics with ultra low radiation comparing to conventional shielded power inductors
- Halogen free

Applications

- Smart phone
- DSC
- Tablet PC and other portable devices
- DC/DC converters

Product Identification

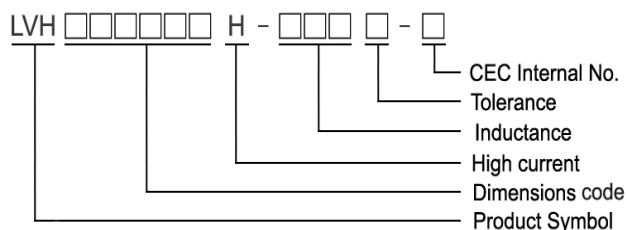
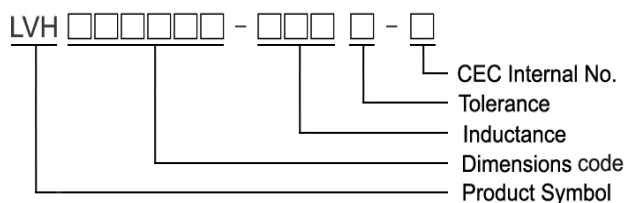

Shape and Dimensions

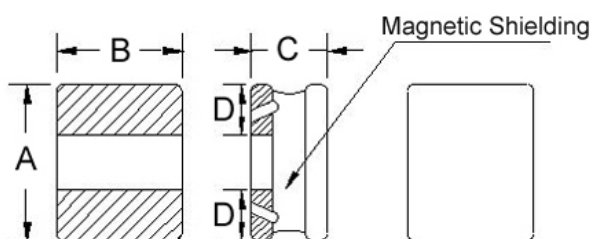

Recommended Pattern

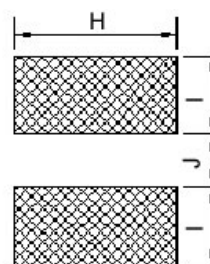

Dimensions in mm

TYPE	A	B	C	D	H	I	J
LVH201B10H	2.0±0.25	1.6±0.25	1.02 Max	0.6	1.8	0.8	0.8
LVH252A10H	2.5±0.25	2.0±0.25	1.02 Max	0.8	2.2	0.85	0.8
LVH252A12	2.5±0.25	2.0±0.25	1.2±0.05	0.8	2.2	0.85	0.8
LVH252A12H	2.5±0.25	2.0±0.25	1.2±0.05	0.8	2.2	0.85	0.8

Electrical Characteristics

Part Number	Inductance (uH)	Test Frequency (MHz)	Tolerance (±%)	RDC (Ω) ±30%	Isat (mA) Typ. (Max)	Irms (mA) Typ. (Max)
LVH201B10H-R24□-N	0.24	1	20, 30	0.048	3700(3300)	2500(2100)
LVH201B10H-R33□-N	0.33	1	20, 30	0.048	3400(3000)	2500(2100)
LVH201B10H-R47□-N	0.47	1	20, 30	0.072	2900(2600)	2100(1800)
LVH201B10H-R56□-N	0.56	1	20, 30	0.072	2700(2400)	2100(1800)
LVH201B10H-R68□-N	0.68	1	20, 30	0.092	2500(2200)	1800(1500)
LVH201B10H-1R0□-N	1.0	1	20, 30	0.110	2200(2000)	1500(1200)
LVH201B10H-2R2□-N	2.2	1	20, 30	0.205	1400(1200)	1150(970)
LVH201B10H-4R7□-N	4.7	1	20, 30	0.520	900(800)	800(680)
LVH201B10H-100□-N	10	1	20, 30	1.100	620(550)	450(380)

- When ordering, please specify tolerance and packaging codes
- Tolerance : T = ±30% , M = ±20%
- L : Agilent/HP4287A+ Agilent/HP16197A, 1MHz 200mV
- RDC : Digital Milliohm Meter Chroma 16502, or equivalent
- Isat & Irms : Agilent/HP4284A, 1MHz 200mV
- Isat for Inductance drop 30% from its value without current
- Irms for a 40°C rise above 25°C ambient.
- Operating temperature range from -55°C to 125°C. (Including self - temperature rise)

Test Instruments : HP4284A Material/Impedance Analyzer

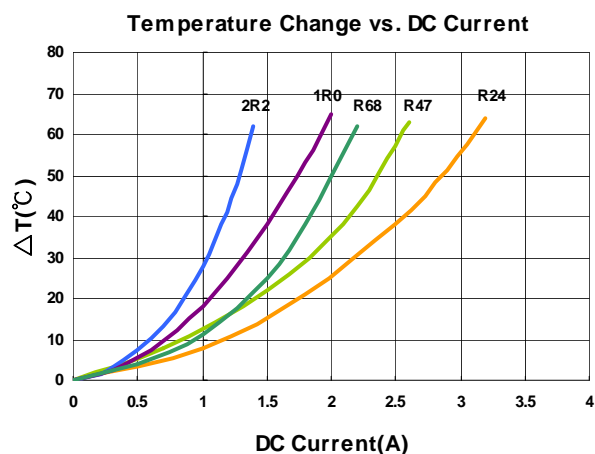
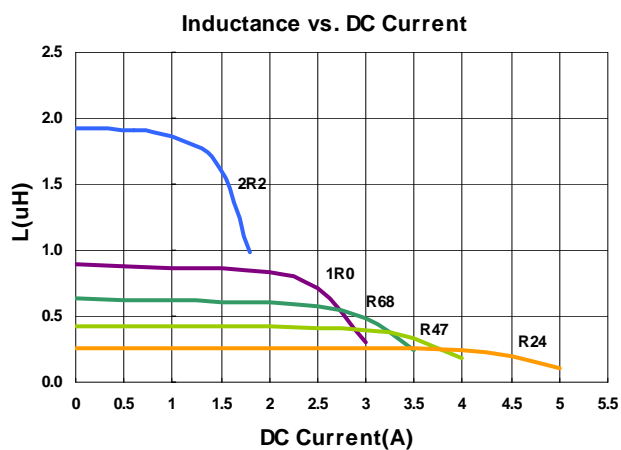

Electrical Characteristics

Part Number	Inductance (uH)	Test Frequency (MHz)	Tolerance (±%)	RDC (Ω) ±30%	Isat (mA) Typ. (Max)	Irms (mA) Typ. (Max)
LVH252A10H-R24□-N	0.24	1	20, 30	0.030	4700(4200)	3600(3000)
LVH252A10H-R47□-N	0.47	1	20, 30	0.043	3300(3000)	2700(2300)
LVH252A10H-R68□-N	0.68	1	20, 30	0.062	2800(2500)	2300(1900)
LVH252A10H-1R0□-N	1.0	1	20, 30	0.080	2300(2100)	1900(1600)
LVH252A10H-2R2□-N	2.2	1	20, 30	0.135	1600(1400)	1400(1100)
LVH252A10H-4R7□-N	4.7	1	20, 30	0.330	1000(900)	850(720)
LVH252A10H-100□-N	10	1	20, 30	0.670	720(640)	580(490)

- When ordering, please specify tolerance and packaging codes
- Tolerance : T = ±30% , M = ±20%
- L : Agilent/HP4287A+ Agilent/HP16197A, 1MHz 200mV
- RDC : Digital Milliohm Meter Chroma 16502, or equivalent
- Isat & Irms : Agilent/HP4284A, 1MHz 200mV
- Isat for Inductance drop 30% from its value without current
- Irms for a 40°C rise above 25°C ambient.
- Operating temperature range from -55°C to 125°C. (Including self - temperature rise)

Test Instruments : HP4284A Material/Impedance Analyzer

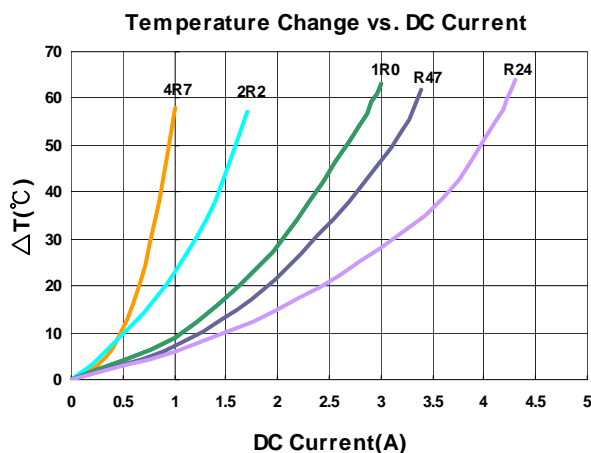
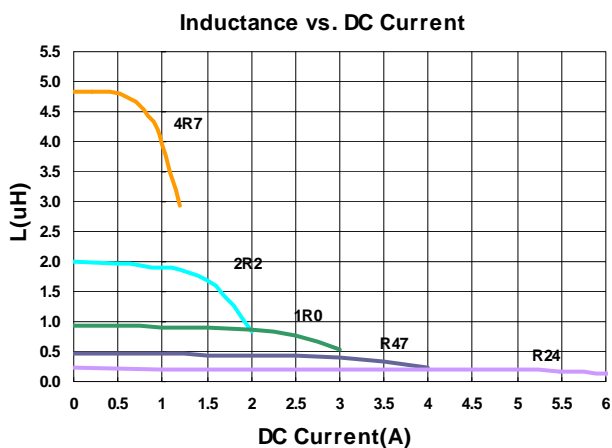

Electrical Characteristics

Part Number	Inductance (uH)	Test Frequency (MHz)	Tolerance (±%)	RDC (Ω) ±30%	Isat (mA) Typ. (Max)	Irms (mA) Typ. (Max)
LVH252A12H-R47□-N	0.47	1	20, 30	0.031	4100(3700)	3100(2600)
LVH252A12H-R68□-N	0.68	1	20, 30	0.031	3100(2900)	3100(2600)
LVH252A12H-1R0□-N	1.0	1	20, 30	0.049	3200(3000)	3000(2500)
LVH252A12H-1R5□-N	1.5	1	20, 30	0.088	2300(2100)	2200(1800)
LVH252A12H-2R2□-N	2.2	1	20, 30	0.099	2200(2000)	2000(1700)
LVH252A12H-3R3□-N	3.3	1	20, 30	0.190	1400(1200)	1200(1000)
LVH252A12H-4R7□-N	4.7	1	20, 30	0.235	1300(1100)	1100(930)
LVH252A12H-100□-N	10	1	20, 30	0.510	920(820)	800(680)

- When ordering, please specify tolerance and packaging codes
- Tolerance : T = ±30% , M = ±20%
- L : Agilent/HP4287A+ Agilent/HP16197A, 1MHz 200mV
- RDC : Digital Milliohm Meter Chroma 16502, or equivalent
- Isat & I rms : Agilent/HP4284A, 1MHz 200mV
- Isat for Inductance drop 30% from its value without current
- I rms for a 40°C rise above 25°C ambient.
- Operating temperature range from -55°C to 125°C. (Including self - temperature rise)

Test Instruments : HP4284A Material/Impedance Analyzer

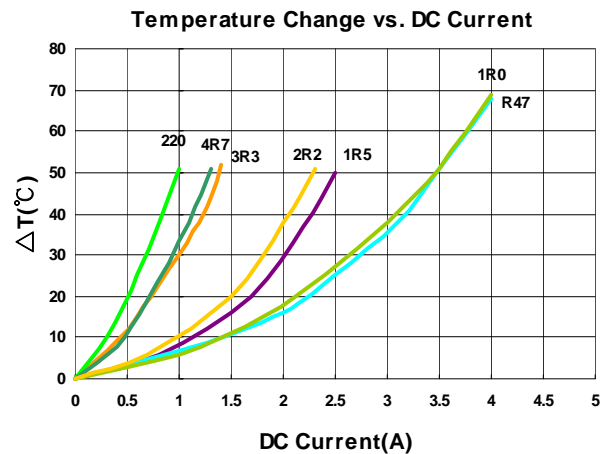
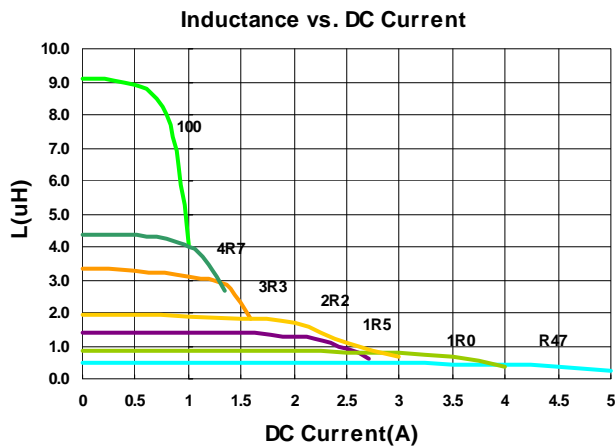

Electrical Characteristics

Part Number	Inductance (uH)	Test Frequency (MHz)	Tolerance (±%)	RDC (Ω) ±30%	Isat (mA) Typ. (Max)	Irms (mA) Typ. (Max)	Marking
LVH252A12-R24□-N	0.24	1	20, 30	0.021	4700(4200)	3800(3200)	E
LVH252A12-R33□-N	0.33	1	20, 30	0.027	4200(3700)	3000(2500)	G
LVH252A12-R50□-N	0.50	1	20, 30	0.027	3600(3400)	3000(2500)	D
LVH252A12-R68□-N	0.68	1	20, 30	0.036	2900(2600)	2800(2300)	H
LVH252A12-1R0□-N	1.0	1	20, 30	0.037	2700(2450)	2600(2200)	A
LVH252A12-1R5□-N	1.5	1	20, 30	0.075	2200(1900)	1900(1600)	I
LVH252A12-2R2□-N	2.2	1	20, 30	0.080	1900(1800)	1800(1500)	B
LVH252A12-4R7□-N	4.7	1	20, 30	0.195	1200(1000)	1100(930)	C
LVH252A12-100□-N	10	1	20, 30	0.400	900(800)	800(680)	F

- When ordering, please specify tolerance and packaging codes
- Tolerance : T = ±30% , M = ±20%
- L : Agilent/HP4287A+ Agilent/HP16197A, 1MHz 200mV
- RDC : Digital Milliohm Meter Chroma 16502, or equivalent
- Isat & Irms : Agilent/HP4284A, 1MHz 200mV
- Isat for Inductance drop 30% from its value without current
- Irms for a 40°C rise above 25°C ambient.
- Operating temperature range from -40to 125°C . (Including self - temperature rise)

Test Instruments : HP4284A Material/Impedance Analyzer

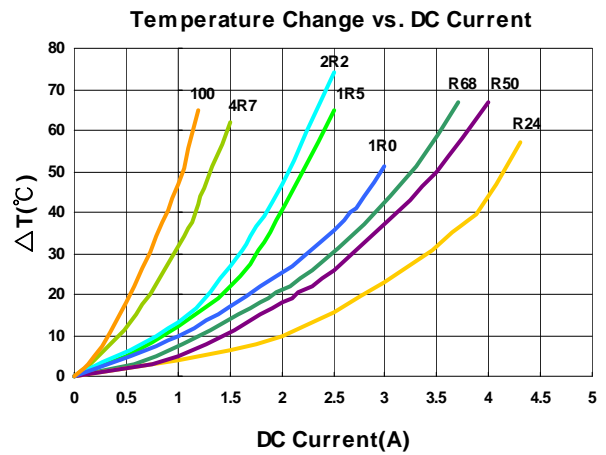
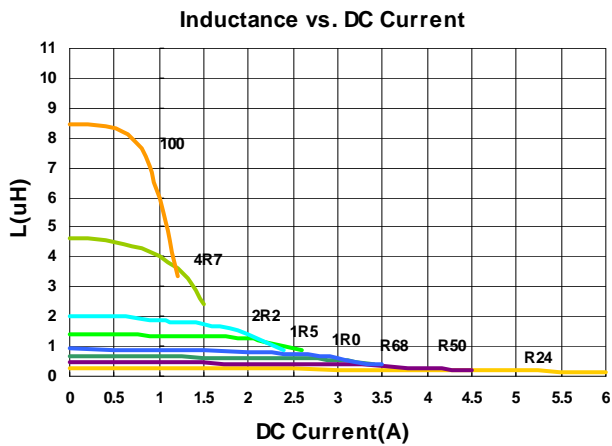

Packaging Specifications

Tape Dimensions

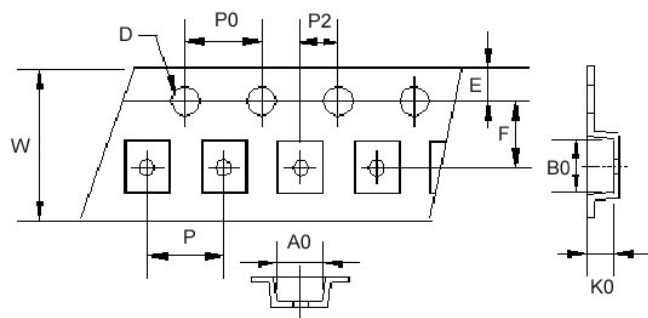

Reel Dimensions

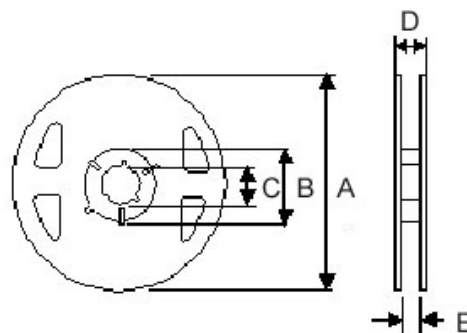

Dimensions in mm

TYPE	Tape Dimensions										Reel Dimensions					Quantity PCS / Reel
	A0	B0	K0	D	E	F	W	P	P0	P2	A	B	C	D	E	
LVH201B10H	1.80	2.20	1.15	1.55	1.75	3.5	8.1	4	4	2	180	60	13	14.4	8.4	2000
LVH252A10H	2.30	2.70	1.15	1.55	1.75	3.5	8.1	4	4	2	180	60	13	14.4	8.4	2000
LVH252A12H	2.30	2.70	1.30	1.55	1.75	3.5	8.1	4	4	2	180	60	13	14.4	8.4	2000
LVH252A12	2.30	2.70	1.30	1.55	1.75	3.5	8.1	4	4	2	180	60	13	14.4	8.4	2000

SF Series

Features

- Surface mount inductors designed for high speed, high current switch mode applications requiring lower inductance
- Gapped ferrite cores for maximum efficiency
- Inductance values from 0.100 uH to 0.200 uH
- Current up to 64 Amps
- Ferrite core material

Applications

- Voltage regulator modules (VRMs) for servers, microprocessors
- High frequency, high current switching power supplies

Product Identification

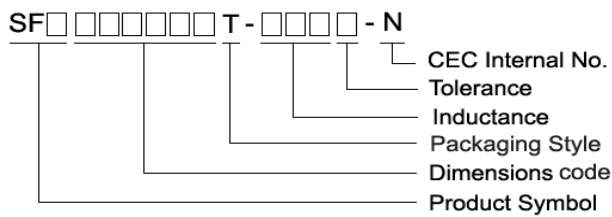

Shape and Dimensions

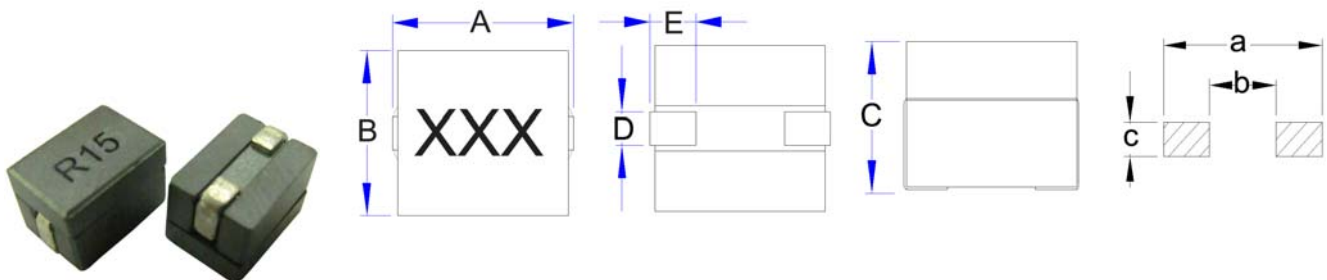

Dimensions in mm

TYPE	A	B	C	D	E	a	b	c
SFD100707	11.0 Max	7.5 Max	7.0 Max	1.6±0.2	2.6±0.3	11.0	4.3	2

Shape and Dimensions

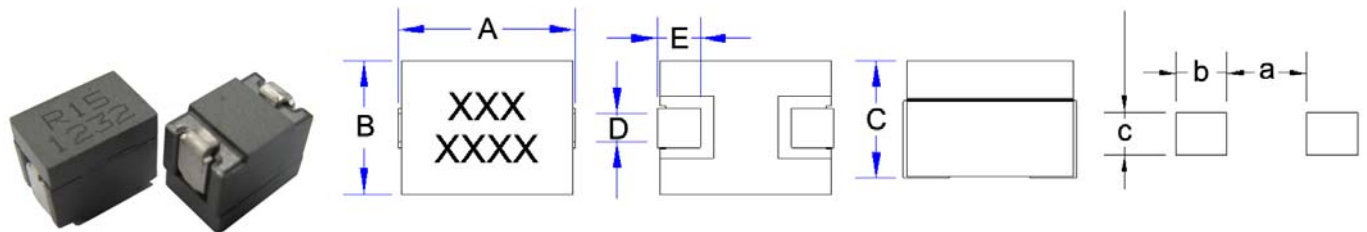

Dimensions in mm

TYPE	A	B	C	D	E	a	b	c
SFS100875	10.2±0.2	8.0 Max	7.3±0.2	2.2±0.2	2.54±0.5	4.7	3.0	2.5

Electrical Characteristics

Part Number	Inductance (uH)	Tolerance (±%)	Test Frequency (KHz)	RDC (mΩ) ±7%	Isat (A) Max	Irms (A) Max
SFD100707T-R12L-N	0.15	15	100	0.37	60	37
SFD100707T-R18L-N	0.17	15	100	0.37	50	37
SFD100707T-R22L-N	0.22	15	100	0.37	40	37
SFD100707T-R33L-N	0.27	15	100	0.37	28	37
SFD100707T-R40L-N	0.30	15	100	0.37	21	37

- Customized Specifications are available
- OCL (Open Circuit Inductance) Test parameters: 100KHz, 0.25Vrms, 0Adc & Isat @20°C
- DC current for an approximate ΔT of 40°C without core loss. Derating is necessary for AC currents. PCB layout, trace thickness and width, airflow, and proximity of other heat generating components will affect the temperature rise. It is recommended that the temperature of the part not exceed 155°C under worst case operating conditions verified in the end application.
- Operating ambient temperature range: -40°C to +125°C(Including self - temperature rise)
- Tested L: WK4237METER RDC:HK502BC METER Isat : WK3260B/ 3265B METER

Inductance vs. DC Current

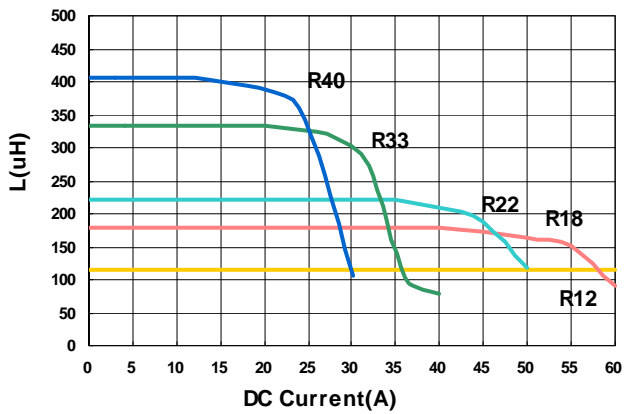

Temperature Change vs. DC Current

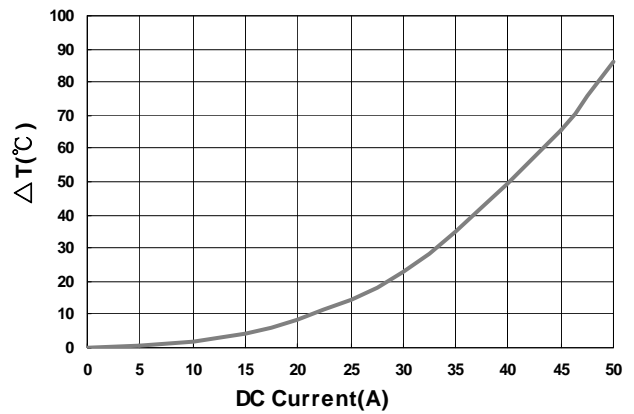

Electrical Characteristics

Part Number	Inductance (uH)	Tolerance (±%)	Test Frequency (KHz)	RDC (mΩ) ±6%	Isat (A) Max	Irms (A) Max
SFS100875T-R15K-N	0.15	10	100	0.29	76	56
SFS100875T-R17K-N	0.17	10	100	0.29	66	56
SFS100875T-R22K-N	0.22	10	100	0.29	50	56
SFS100875T-R27K-N	0.27	10	100	0.29	40	56
SFS100875T-R30K-N	0.30	10	100	0.29	35	56
SFS100875T-R40L-N	0.40	15	100	0.29	25	56

- Customized Specifications are available
- OCL (Open Circuit Inductance) Test parameters: 100KHz, 1Vrms, 0Adc & Isat @20°C
- DC current for an approximate ΔT of 40°C without core loss. Derating is necessary for AC currents. PCB layout, trace thickness and width, airflow, and proximity of other heat generating components will affect the temperature rise. It is recommended that the temperature of the part not exceed 155°C under worst case operating conditions verified in the end application.
- Operating ambient temperature range: -40°C to +125°C(Including self - temperature rise)
- Tested L: WK4237METER RDC:HK502BC METER Isat : WK3260B/ 3265B METER

Inductance vs. DC Current

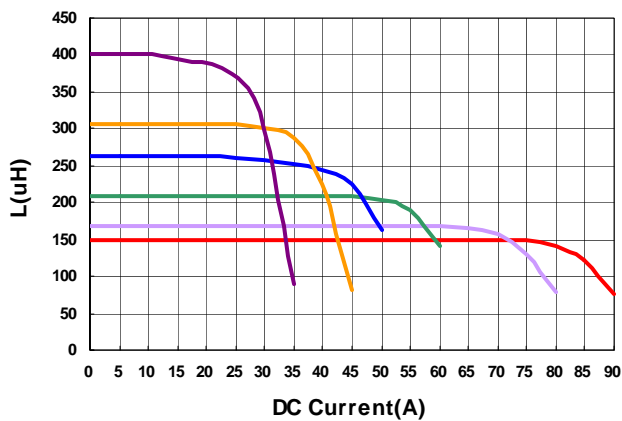

Temperature Change vs. DC Current

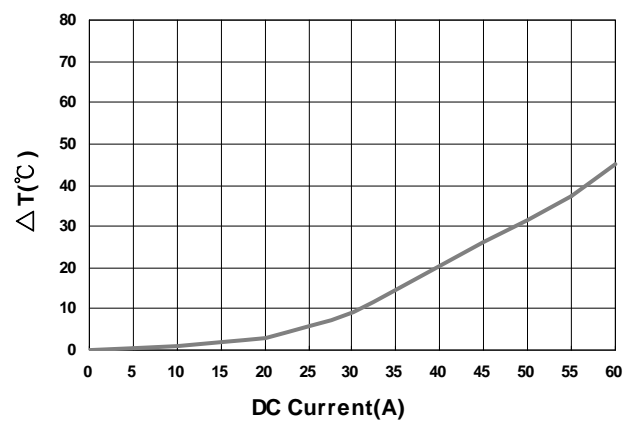

Packaging Specifications

Tape Dimensions

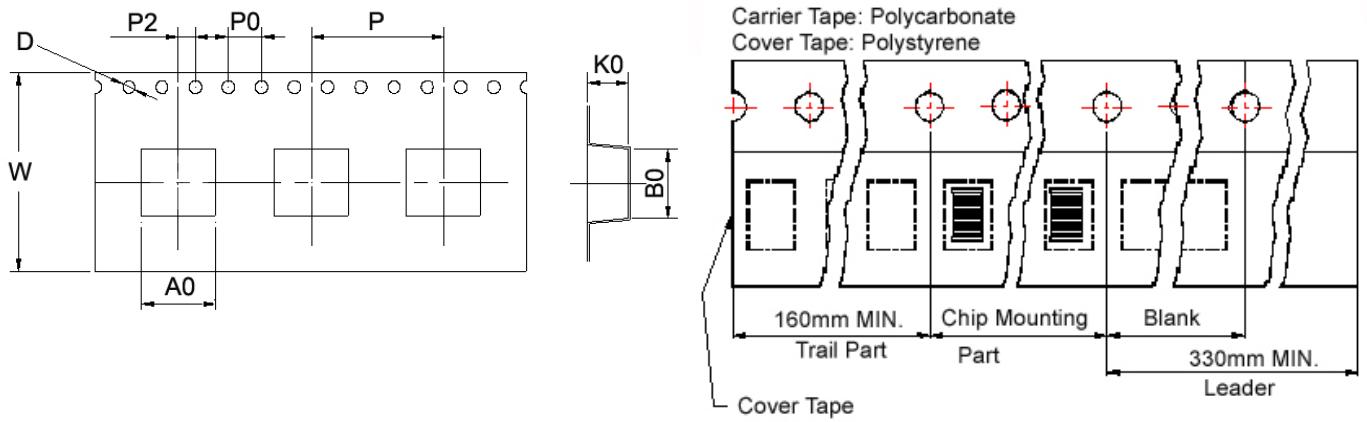

Reel Dimensions

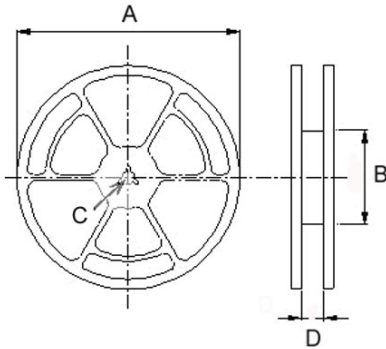

Dimensions in mm

TYPE	Tape Dimensions								Reel Dimensions				Quantity PCS / REEL
	A0	B0	K0	D	W	P	P0	P2	A	B	C	D	
SFD100707	7.4	10.6	7.6	1.5	24	12	4	2	330	100	13.5	24	640
SFS100875	8.0	10.3	7.7	1.5	24	12	4	2	330	100	13.5	24	700

CPUS Series



CPUS Series is designed for low RDC and ultra large current application. Its assembly model and magnetic shielding is suitable for high-density mounting and ultra low buzz noise. Soldering conditions can be easily confirmed when mounting onto board. This series also provides customers with embossed carrier type packaging for automatic mounting machine.

Features

- Lead free
- Excellent for power line DC-DC conversion applications
- Shielded construction
- Lowest DCR/uH in this package size
- Handle high transient current spikes without saturation
- Ultra low buzz noise due to composite construction
- Support halogen free product

Applications

- Power switching for personal computers and other handheld electronic devices

Product Identification

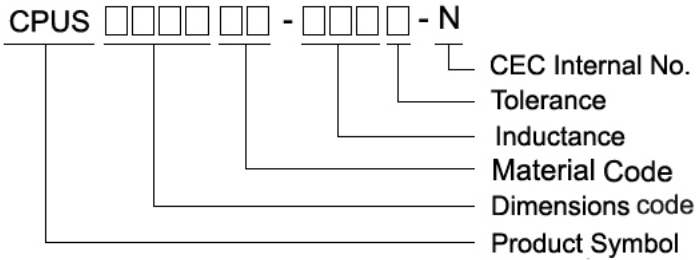

Shape and Dimensions

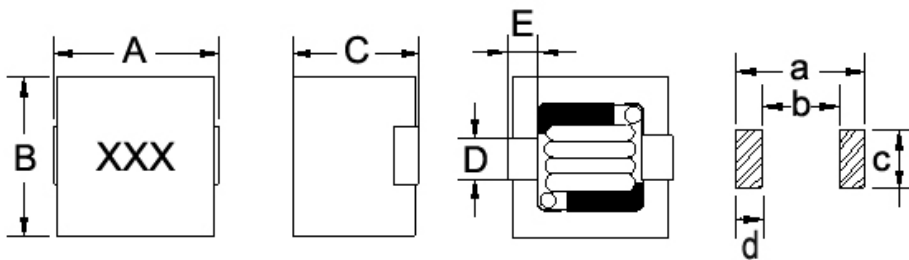

Dimensions in mm

TYPE	A	B	C	D	E	a	b	c	d
CPUS0807MN	8.8 ⁺⁰	8.4 ⁺⁰	7.5 ⁺⁰	2.3±0.2	1.5±0.2	9.2	4.4	3.0	2.3
CPUS1009MN	11.3 ⁺⁰	10.4 ⁺⁰	9.7 ⁺⁰	3.0±0.2	1.6±0.2	11.3	6.9	3.6	2.2
CPUS1210MN	12.3 ⁺⁰	11.7 ⁺⁰	10.0 ⁺⁰	3.5±0.2	2.0±0.2	12.8	7.0	5.4	2.9

Electrical Characteristics

Part Number	Inductance (μH)	Tolerance (±%)	Test Frequency (KHz)	RDC (mΩ) Max	Isat (A) Max	Irms (A) Max	Marking
CPUS0807MN-R30M-N	0.30	20	100	2.7	27	16	R30
CPUS0807MN-R47M-N	0.47	20	100	3.1	25	15	R47
CPUS0807MN-R56M-N	0.56	20	100	3.1	20	15	R56
CPUS0807MN-R68M-N	0.68	20	100	3.1	17	15	R68
CPUS0807MN-1R0M-N	1.0	20	100	4.3	15	13	1R0
CPUS0807MN-1R5M-N	1.5	20	100	6.2	11	10	1R5
CPUS0807MN-2R2M-N	2.2	20	100	6.2	8	10	2R2
CPUS0807MN-3R3M-N	3.3	20	100	9.0	5	8	3R3
CPUS1009MN-R22M-N	0.22	20	100	1.60	55	22	R22
CPUS1009MN-R33M-N	0.33	20	100	1.60	42	22	R33
CPUS1009MN-R47M-N	0.47	20	100	1.85	36	20	R47
CPUS1009MN-R56M-N	0.56	20	100	1.85	32	20	R56
CPUS1009MN-R68M-N	0.68	20	100	2.65	28	17	R68
CPUS1009MN-R82M-N	0.82	20	100	2.65	24	17	R82
CPUS1009MN-1R0M-N	1.0	20	100	2.65	21	17	1R0
CPUS1009MN-1R5M-N	1.5	20	100	4.00	17	13.5	1R5
CPUS1009MN-2R2M-N	2.2	20	100	5.30	14	12	2R2
CPUS1009MN-3R3M-N	3.3	20	100	7.70	10	11	3R3
CPUS1009MN-4R7M-N	4.7	20	100	10.8	8.5	10	4R7
CPUS1009MN-6R8M-N	6.8	20	100	16.9	7.0	9	6R8
CPUS1009MN-8R2M-N	8.2	20	100	16.9	6.0	9	8R2
CPUS1009MN-100M-N	10	20	100	26.0	5.0	7	100
CPUS1210MN-R22M-N	0.22	20	100	1.5	55	37	R22
CPUS1210MN-R33M-N	0.33	20	100	1.5	45	37	R33
CPUS1210MN-R47M-N	0.47	20	100	1.8	45	35	R47
CPUS1210MN-R56M-N	0.56	20	100	1.8	35	35	R56
CPUS1210MN-R68M-N	0.68	20	100	1.8	33	35	R68
CPUS1210MN-R82M-N	0.82	20	100	2.4	31	30	R82
CPUS1210MN-1R0M-N	1.0	20	100	2.4	28	30	1R0
CPUS1210MN-1R5M-N	1.5	20	100	3.5	24	25	1R5
CPUS1210MN-2R2M-N	2.2	20	100	4.7	18	21	2R2
CPUS1210MN-3R3M-N	3.3	20	100	6.3	14	15	3R3
CPUS1210MN-4R7M-N	4.7	20	100	8.8	11	12	4R7
CPUS1210MN-6R8M-N	6.8	20	100	12.5	9	10	6R8
CPUS1210MN-8R2M-N	8.2	20	100	13.0	7	9	8R2
CPUS1210MN-100M-N	10	20	100	18.7	6	8	100

- Isat for inductance drops 20% from its value without current
- I rms for a 40°C rise above 25°C ambient.
- Customized Specifications are available.
- Tested L: WK4237METER
RDC: HK502BC METER
Isat · I rms : WK3260B/ 3265B METER

Packaging Specifications

Tape Dimensions

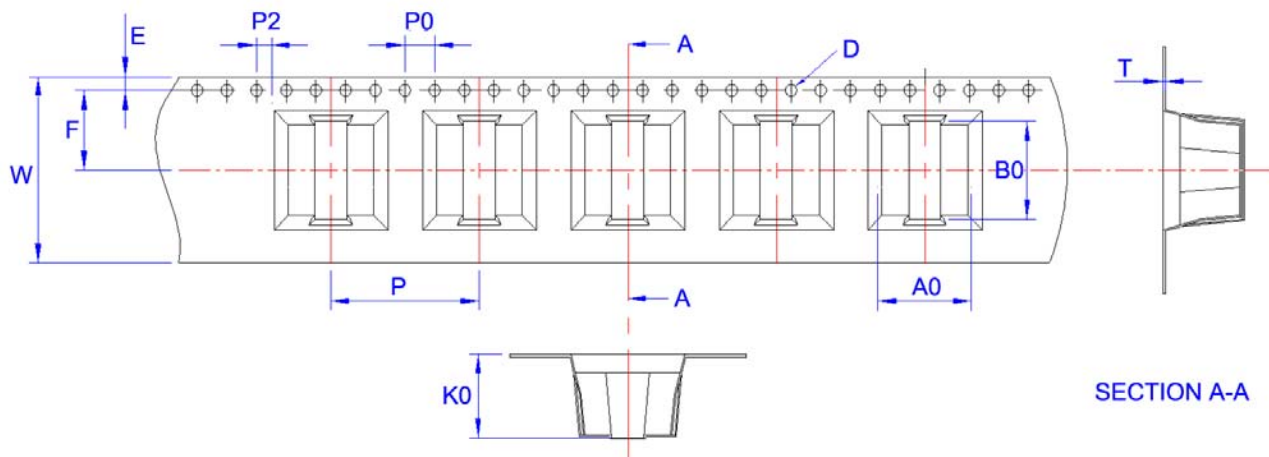

Reel Dimensions

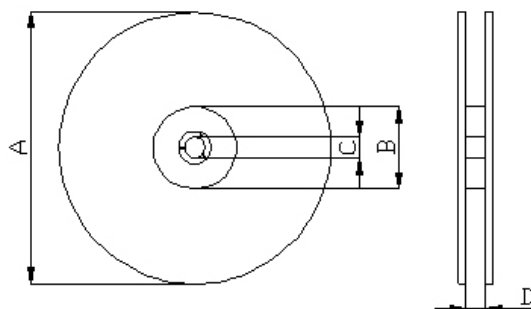

Dimensions in mm

TYPE	Tape Dimensions										Reel Dimensions				Quantity
	A0	B0	K0	D	E	W	T	P	P0	P2	A	B	C	D	PCS / REEL
CPUS0807MN	8.25	9.0	7.4	1.5	1.75	24	0.4	16	4	2	330	75	13.5	24	500
CPUS1009MN	10.4	11.3	9.8	1.5	1.75	24	0.4	16	4	2	330	75	13.5	24	400
CPUS1210MN	11.8	12.6	10.55	1.5	1.75	24	0.5	20	4	2	330	75	13.5	24	300

SCDS Series

Features

- RoHS compliant
- Available in magnetic shielding
- Low DC resistance
- Suitable for large currents
- Ideal for DC – DC converter inductor applications
- Available on tape and reel for auto surface mounting

Applications

- Power supply for VTRs
- OA equipment
- LCD televisions
- Notebook PCs
- Portable communication devices
- DC / DC converters, etc

Product Identification

SCDS

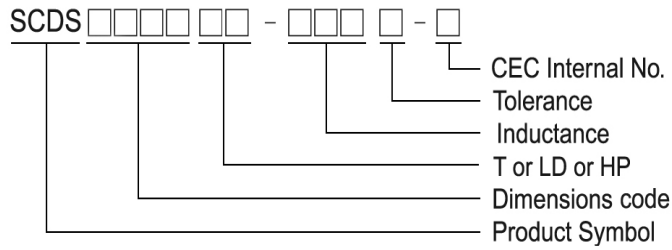

- T : Packaging: Tape and Reel
- HP : High Power
- LD : Low DCR
- CEC Internal No.: S: Base type terminals

SCDS3D16

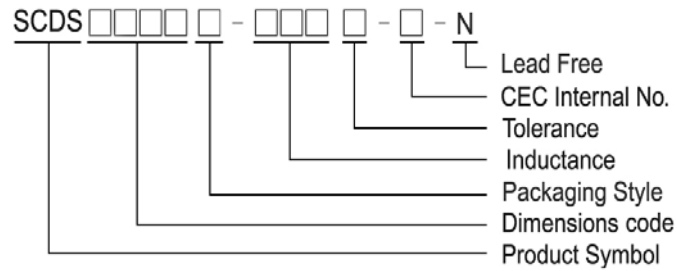

SCDS2D11/2D14/2D18LD/ 2D18HP

Shape and Dimensions

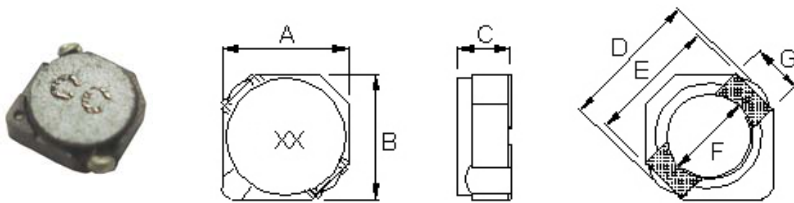

Recommended Pattern

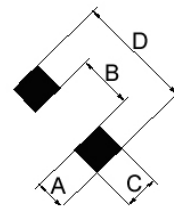

Dimension in mm

TYPE	A	B	C	D	E	F	G
SCDS2D11	3.2 ⁺⁰	3.2 ⁺⁰	1.2 ⁺⁰	4.5 ⁺⁰	3.3	2.1	1.0
SCDS2D14	3.2 ⁺⁰	3.2 ⁺⁰	1.55 ⁺⁰	4.5 ⁺⁰	3.3	2.1	1.0
SCDS2D18LD	3.2 ⁺⁰	3.2 ⁺⁰	2.0 ⁺⁰	4.5 ⁺⁰	3.3	2.1	1.0
SCDS2D18HP	3.2 ⁺⁰	3.2 ⁺⁰	2.0 ⁺⁰	4.5 ⁺⁰	3.3	2.1	1.0

Dimensions in mm

TYPE	A	B	C	D
SCDS2D11	1.3	1.7	1.3	4.3
SCDS2D14	1.3	1.7	1.3	4.3
SCDS2D18LD	1.3	1.7	1.3	4.3
SCDS2D18HP	1.3	1.7	1.3	4.3

SCDS3D11/3D11HP

Shape and Dimensions

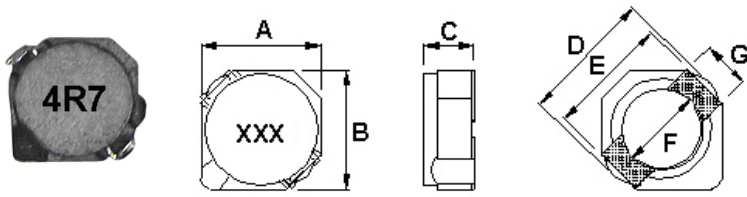

Dimension in mm

TYPE	A	B	C	D	E	F	G
SCDS3D11	4 ⁺⁰	4 ⁺⁰	1.2 ⁺⁰	5.2 ⁺⁰	4.4	2.8	1.1
SCDS3D11HP	4 ⁺⁰	4 ⁺⁰	1.2 ⁺⁰	5.2 ⁺⁰	4.4	2.8	1.1

Recommended Pattern

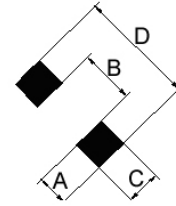

Dimensions in mm

TYPE	A	B	C	D
SCDS3D11	1.4	2.4	1.5	5.2
SCDS3D11HP	1.4	2.4	1.5	5.2

SCDS 3D16T-XXX-S1-N

Shape and Dimensions

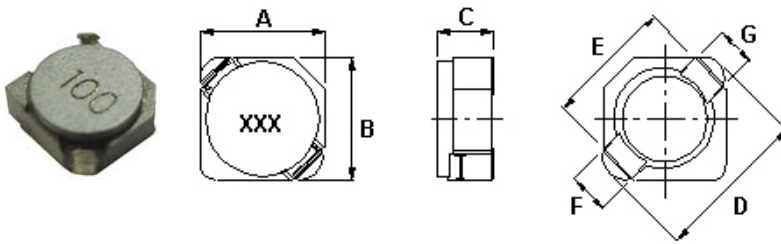

Dimensions in mm

TYPE	A	B	C	D	E	F	G
SCDS3D16	4 ⁺⁰	4 ⁺⁰	1.8 ⁺⁰	5.2 ⁺⁰	4.4Typ	1.4 ⁺⁰	1.1Typ

Recommended Pattern

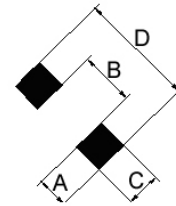

Dimension in mm

TYPE	A	B	C	D
SCDS3D16	1.4	2.4	1.5	5.2

SCDS3D28/3D28LD

Shape and Dimensions

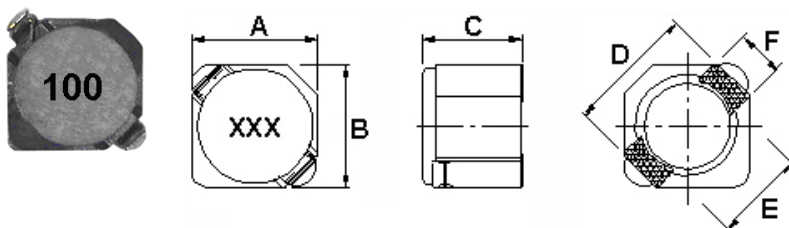

Dimension in mm

TYPE	A	B	C	D	E	F
SCDS3D28	4 ⁺⁰	4 ⁺⁰	3 ⁺⁰	4.4	2.8	1.1
SCDS3D28LD	4 ⁺⁰	4 ⁺⁰	3 ⁺⁰	4.4	2.8	1.1

Recommended Pattern

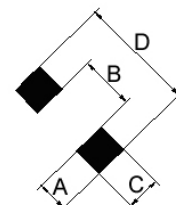

Dimensions in mm

TYPE	A	B	C	D
SCDS3D28	1.4	2.4	1.5	5.2
SCDS3D28LD	1.4	2.4	1.5	5.2

Standard Specifications

Stamp	Inductance (μ H)	RDC (m Ω) Max								
		SCDS 2D11	SCDS 2D14	SCDS 2D18LD	SCDS 2D18HP	SCDS 3D11	SCDS 3D11HP	SCDS 3D16	SCDS 3D28	SCDS 3D28LD
R60	0.6						59			
1R0	1.0							40		
1R2	1.2						82			
1R5	1.5	68	63				104	52		
1R7	1.7				44					
1R8	1.8		75							
2R2	2.2	98	94	41	60		143	72		
2R7	2.7		106			78				
3R3	3.3	123	125	54	86		182	85	72.1	
3R9	3.9		138							
4R7	4.7	170	169	78	140	123	234	105	88.3	
5R6	5.6		188					135		
6R3	6.3				160					
6R8	6.8	260	213	106		180	377	170	119	
8R2	8.2		281			204				
100	10	400	294	180	245	240	413	210	145	95
120	12		394			276	585			100
150	15			220	345	372	653	295	213	115
180	18					468	888			125
220	22			320		540	1010	430	335	145
270	27					726				175
330	33			460		822		675	481	215
390	39					942				225
470	47			660					599	305
560	56									325
680	68									470
820	82									540
101	100							2750		610
121	120									755
151	150									880
181	180									1130
221	220									1270

Test Freq. (L): SCDS 2D11/ 2D14/ 2D18LP/2D18HP/3D11/3D11HP/3D28/3D28LD (100KHz/ 1V)
SCDS 3D16 (100KHz/ 0.1V)

Other type: Rated current: Isat DC current (A) that will cause L to drop approximately 35% of it's nominal value or D.C. current when the temperature rising $\Delta t=40^{\circ}\text{C}$ lower, whichever is lower.

Test Instrument: L: Agilent/ E4980 or HP4284A

RDC: CH502BC

Rated Current: HP4284+42841A or WK3260B+WK3265B

Standard Specifications

Stamp	Inductance (μH)	Rated Current (A)								
		SCDS 2D11	SCDS 2D14	SCDS 2D18LD	SCDS 2D18HP	SCDS 3D11	SCDS 3D11HP	SCDS 3D16	SCDS 3D28	SCDS 3D28LD
R60	0.6						2.90			
1R0	1.0							1.60		
1R2	1.2						2.00			
1R5	1.5	0.90	1.80				1.85	1.55		
1R7	1.7				1.85					
1R8	1.8		1.65							
2R2	2.2	0.78	1.50	0.85	1.60		1.60	1.20		
2R7	2.7		1.35			0.53				
3R3	3.3	0.60	1.20	0.75	1.45		1.25	1.10	2.00	
3R9	3.9		1.10							
4R7	4.7	0.50	1.00	0.63	1.20	0.40	1.00	0.90	1.65	
5R6	5.6		0.95					0.80		
6R3	6.3				1.05					
6R8	6.8	0.44	0.85	0.52		0.34	0.85	0.73	1.24	
8R2	8.2		0.80			0.32				
100	10	0.35	0.70	0.43	0.85	0.28	0.80	0.55	1.05	0.50
120	12		0.62			0.25	0.64			0.45
150	15			0.35	0.70	0.23	0.58	0.45	0.90	0.40
180	18					0.21	0.52			0.35
220	22			0.30		0.19	0.45	0.40	0.76	0.33
270	27					0.17				0.29
330	33			0.24		0.15		0.32	0.58	0.28
390	39					0.14				0.25
470	47			0.20					0.48	0.23
560	56									0.20
680	68									0.185
820	82									0.172
101	100							0.13		0.160
121	120									0.136
151	150									0.124
181	180									0.119
221	220									0.116

Tolerance Of Inductors

- SCDS 2D11 1.5 ~ 10uH ± 30%
- SCDS 2D14 1.5 ~ 12μH ± 30%
- SCDS 2D18LD 2.2 ~ 47μH ± 30%
- SCDS 2D18HP 1.7 ~ 15μH ± 30%
- Tolerance : M = ±20% , T = ±30% , N = ⁺⁴⁰-.20%
- SCDS3D11 2.7 ~ 39 uH ± 30%
- SCDS3D11HP 0.6 ~ 22 uH ± 30%
- SCDS3D16 1.0 ~ 100 uH ± 30%
- SCDS3D28 3.3 ~ 47 uH ± 30%
- SCDS3D28LD 10 ~ 220 uH ± 30%

Packaging Specifications

Tape Dimensions

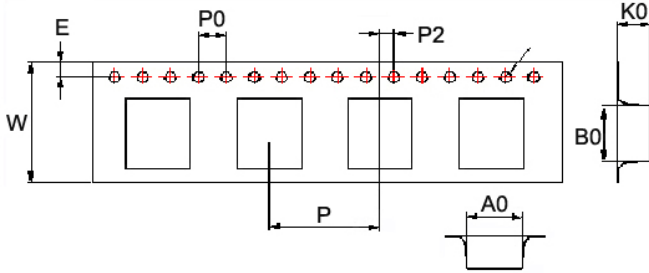

Tape Material

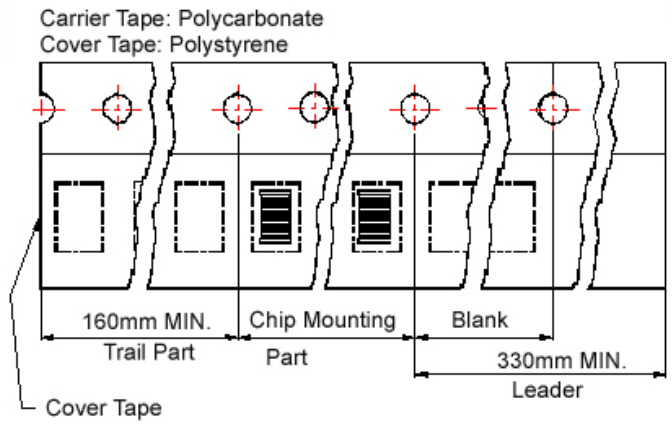

Reel Dimensions

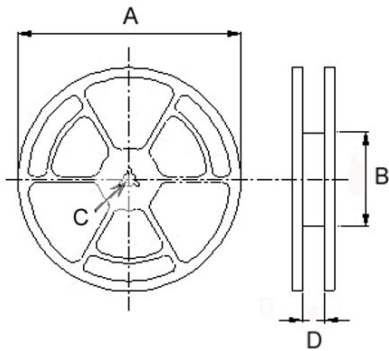

Dimensions in mm

TYPE	Tape Dimensions									Reel Dimensions				Quantity
	A0	B0	K0	D	E	W	P	P0	P2	A	B	C	D	PCS / REEL
SCDS 2D11	3.35	3.35	1.4	1.55	1.75	12	8	4	2	178	60	13	13.2	1000
SCDS 2D14	3.35	3.35	1.7	1.55	1.75	12	8	4	2	178	60	13	13.2	1000
SCDS 2D18	3.5	3.5	2.1	1.55	1.75	12	8	4	2	178	60	13	13.2	1000
SCDS 3D11	4.2	4.2	1.5	1.55	1.75	12	8	4	2	178	60	13	13.2	1000
SCDS 3D16	4.1	4.1	2.0	1.5	1.75	12	8	4	2	178	60	13	13.2	1000
SCDS 3D28	4.2	4.2	3.2	1.55	1.75	12	8	4	2	178	60	13	13.2	500

SCDS Series

Features

- RoHS compliant
- Available in magnetic shielding
- Low DC resistance
- Suitable for large currents
- Ideal for DC – DC converter inductor applications
- Available on tape and reel for automatic surface mounting

Applications

- Power supply for VTRs
- OA equipment
- LCD televisions
- Notebook PCs
- Portable communication devices
- DC / DC converters, etc

Product Identification

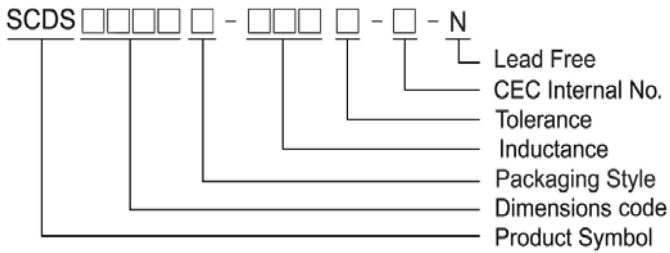

- T : Packaging: Tape and Reel
- CEC Internal No.: S: Base type terminals

SCDS 3D16T-XXXX-S-N

Shape and Dimensions

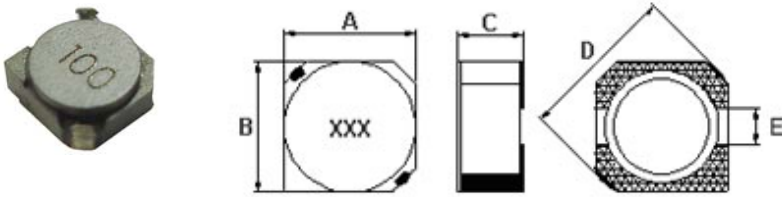

Recommended Pattern

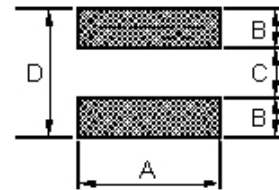

Dimensions in mm						Dimension in mm				
TYPE	A	B	C	D	E	TYPE	A	B	C	D
SCDS3D16	4 ⁺⁰	4 ⁺⁰	1.8 ⁺⁰	5.2 ⁺⁰	1.0	SCDS3D16	4.6	1.6	1.4	4.6

SCDS 4D18 ~ 6D38

Shape and Dimensions

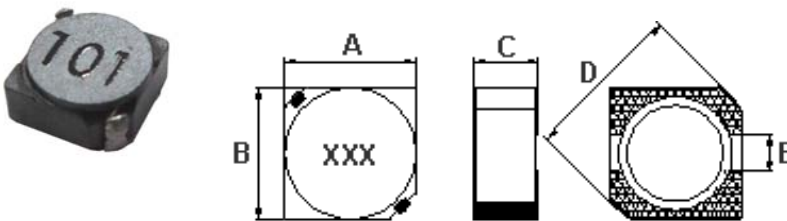

Recommended Pattern

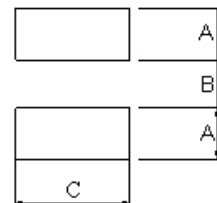

Dimension in mm						Dimension in mm			
TYPE	A	B	C	D	E	TYPE	A	B	C
SCDS4D18	4.7 ± 0.3	4.7 ± 0.3	2.0 ⁺⁰	6.9 ⁺⁰	1.5	SCDS4D18	1.9	1.5	5.3
SCDS4D28	4.7 ± 0.3	4.7 ± 0.3	3.0 ⁺⁰	6.9 ⁺⁰	1.5	SCDS4D28	1.9	1.5	5.3
SCDS4D40	4.7 ± 0.3	4.7 ± 0.3	4 ⁺⁰	6.9 ⁺⁰	1.5	SCDS4D40	1.9	1.5	5.3
SCDS5D18	5.7 ± 0.3	5.7 ± 0.3	2.0 ⁺⁰	8.2 ⁺⁰	2.0	SCDS5D18	2.15	2.0	6.3
SCDS5D28	5.7 ± 0.3	5.7 ± 0.3	3.0 ⁺⁰	8.2 ⁺⁰	2.0	SCDS5D28	2.15	2.0	6.3
SCDS6D28	6.7 ± 0.3	6.7 ± 0.3	3.0 ⁺⁰	9.5 ⁺⁰	2.0	SCDS6D28	2.65	2.0	7.3
SCDS6D38	7 ⁺⁰	7 ⁺⁰	4 ⁺⁰	9.5 ⁺⁰	2.0	SCDS6D38	2.65	2.0	7.3

SMD Shielded Power Inductors - SCDS Series

Standard Specifications

Stamp	Inductance (μ H)	RDC (m Ω) Max								Rated Current (A)							
		SCDS 3D16	SCDS 4D18	SCDS 4D28	SCDS 4D40	SCDS 5D18	SCDS 5D28	SCDS 6D28	SCDS 6D38	SCDS 3D16	SCDS 4D18	SCDS 4D28	SCDS 4D40	SCDS 5D18	SCDS 5D28	SCDS 6D28	SCDS 6D38
		1R0	1.0		45								1.72				
1R2	1.2			23.6								2.56					
1R5	1.5	52								1.55							
1R7	1.7																
1R8	1.8			27.5													
2R2	2.2	72	75	31.3	22					1.20	1.32	2.04	4.6				
2R5	2.5					18									2.60		
2R7	2.7		105	43.3							1.28	1.60					
3R0	3.0						24	24							2.40	3.00	
3R3	3.3	85	110	49.2	33				20	1.10	1.04	1.57	3.4				3.50
3R9	3.9		155	64.8							0.88	1.44				2.60	
4R1	4.1					57								1.95			
4R2	4.2						31								2.20		
4R7	4.7	105	162	72.0	44					0.90	0.84	1.32	2.8				
5R0	5.0							31	24							2.40	2.90
5R3	5.3						38								1.90		
5R4	5.4					76								1.60			
5R6	5.6		170	100.9							0.80	1.17					
6R0	6.0							35								2.25	
6R2	6.2					96	45		27						1.40	1.80	2.50
6R3	6.3																
6R8	6.8	170	200	108.9	46					0.73	0.76	1.12	2.6				
7R3	7.3								54							2.10	
7R4	7.4																2.30
8R2	8.2		245	117.5			53				0.68	1.04			1.60		
8R6	8.6							58								1.85	
8R7	8.7								34								2.20
8R9	8.9					116								1.25			
100	10	210	280	128.3	150	124	65	65	38	0.55	0.61	1.00	1.8	1.20	1.30	1.70	2.00
120	12		320	131.6		153	76	70	53		0.56	0.84		1.10	1.20	1.55	1.70
150	15	295	360	149.0	210	196	103	84	57	0.45	0.50	0.76	1.6	0.97	1.10	1.40	1.60
180	18		400	166.0		210	110	95	92		0.48	0.72		0.85	1.00	1.32	1.50
220	22	430	480	235.0	270	290	122	128	96	0.40	0.41	0.70	1.4	0.80	0.90	1.20	1.30
270	27		570	261.0		330	175	142	109		0.35	0.58		0.75	0.85	1.05	1.20
330	33	675	694	331.3		386	189	165	124	0.32	0.32	0.56		0.65	0.75	0.97	1.10
390	39		800	383.7		520	212	210	138		0.30	0.50		0.57	0.70	0.86	1.00
470	47		950	587.0		595	250	238	150		0.28	0.48		0.54	0.62	0.80	0.95
560	56		1080	624.5		665	305	277	202		0.26	0.41		0.50	0.58	0.73	0.85
680	68		1300	699.0		840	355	304	234		0.24	0.35		0.43	0.52	0.65	0.75
820	82			914.8		978	463	390	324			0.32		0.41	0.46	0.60	0.70
101	100			1020		1200	520	535	358			0.29		0.36	0.42	0.54	0.65
121	120			1270								0.27					
151	150			1350								0.24					
181	180			1540								0.22					

Packaging Specifications

Tape Dimensions

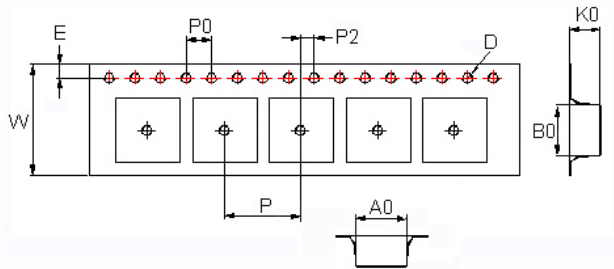

Tape Material

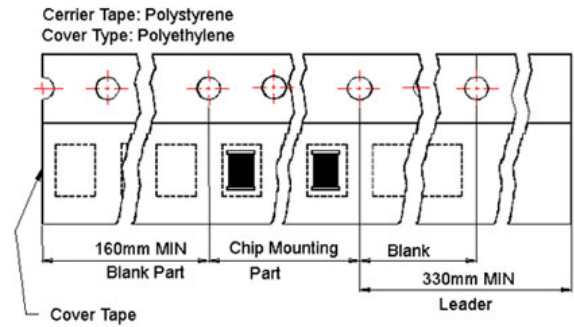

Reel Dimensions

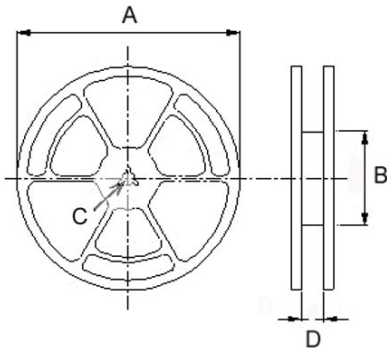

Dimensions in mm

TYPE	Tape Dimensions									Reel Dimensions				Quantity PCS / REEL
	A0	B0	K0	D	E	W	P	P0	P2	A	B	C	D	
SCDS 3D16	4.1	4.1	2.0	1.5	1.75	12	8	4	2	178	60	13	13.2	1000
SCDS 4D18	5.3	5.3	2.4	1.5	1.75	12	8	4	2	330	100	13	13.4	2000
SCDS 4D28	5.3	5.3	3.4	1.5	1.75	12	8	4	2	330	100	13	13.4	2000
SCDS 4D40	5.35	5.35	4.1	1.55	1.75	12	8	4	2	330	100	13	13.4	1000
SCDS 5D18	6.2	6.2	2.2	1.55	1.75	16	12	4	2	330	100	13	13.4	1500
SCDS 5D28	6.2	6.2	3.1	1.55	1.75	16	12	4	2	330	100	13	17.4	1500
SCDS 6D28	7.25	7.25	3.35	1.55	1.75	16	12	4	2	330	100	13	17.4	1500
SCDS 6D38	7.1	7.1	4.1	1.55	1.75	16	12	4	2	330	100	13	17.4	1000

SCDS Series

Features

- RoHS compliant
- Available in magnetically shielding
- Low DC resistance
- Suitable for large currents
- Ideal for DC – DC converter inductor applications
- Available on tape and reel for auto surface mounting

Applications

- Power supply for VTRs
- OA equipment
- LCD televisions
- Notebook PCs
- Portable communication devices
- DC / DC converters, etc

Product Identification

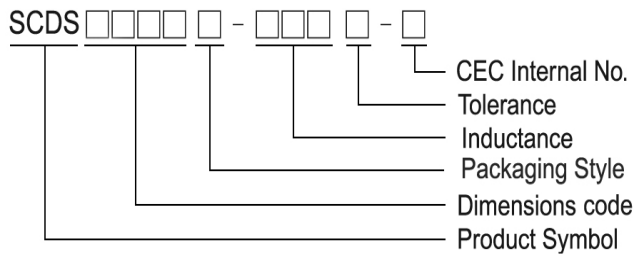

- T : Packaging: Tape and Reel

SCDS 62 / 64

Shape and Dimensions

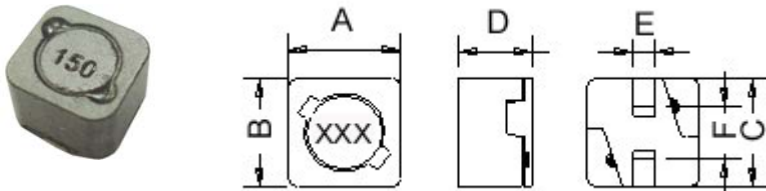

Dimensions in mm

TYPE	A	B	C	D	E	F
SCDS62	6.2±0.3	5.9±0.3	6.0±0.3	3 ⁺⁰	1.5	2.8
SCDS64	6.2±0.3	5.9±0.3	6.0±0.3	5 ⁺⁰	1.5	2.8

Recommended Pattern

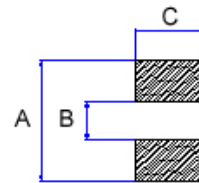

Dimensions in mm

TYPE	A	B	C
SCDS62	8.1	4	2.5
SCDS64	8.1	4	2.5

SCDS 73/ 74

Shape and Dimensions

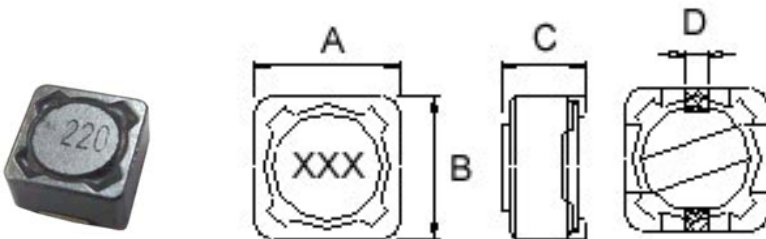

Dimension in mm

TYPE	A	B	C	D
SCDS73	7.3±0.2	7.3±0.2	3.4 ⁺⁰	1.8
SCDS74	7.3±0.2	7.3±0.2	4.5 ⁺⁰	1.8

Recommended Pattern

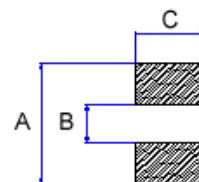

Dimension in mm

TYPE	A	B	C
SCDS73	8.4	4.4	2.2
SCDS74	8.4	4.4	2.2

SCDS 103R/ 104R/ 105R

Shape and Dimensions

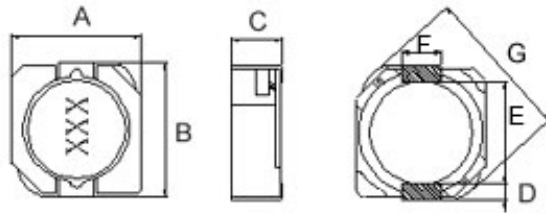

Dimensions in mm

TYPE	A	B	C	D	E	F	G
SCDS103R	10.3 ⁺⁰	10.5 ⁺⁰	3.1 ⁺⁰	1.2	7.7	3.0	13.5 ⁺⁰
SCDS104R	10.3 ⁺⁰	10.5 ⁺⁰	4 ⁺⁰	1.2	7.7	3.0	13.5 ⁺⁰
SCDS105R	10.3 ⁺⁰	10.5 ⁺⁰	5.1 ⁺⁰	1.2	7.7	3.0	13.5 ⁺⁰

Recommended Pattern

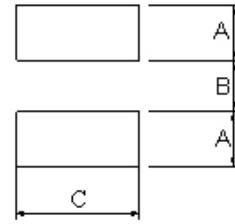

Dimension in mm

TYPE	A	B	C
SCDS103R	1.6	7.3	3.2
SCDS104R	1.6	7.3	3.2
SCDS105R	1.6	7.3	3.2

SCDS 124/125/127

Shape and Dimensions

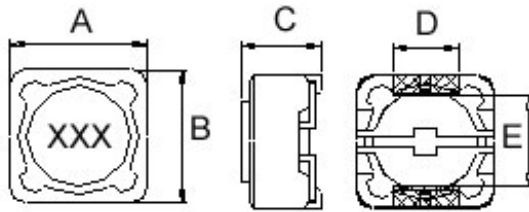

Dimensions in mm

TYPE	A	B	C	D	E
SCDS124	12.5 ⁺⁰	12.5 ⁺⁰	4.5 ⁺⁰	5	7.6
SCDS125	12.5 ⁺⁰	12.5 ⁺⁰	6 ⁺⁰	5	7.6
SCDS127	12.5 ⁺⁰	12.5 ⁺⁰	8 ⁺⁰	5	7.6

Recommended Pattern

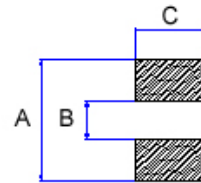

Dimensions in mm

TYPE	A	B	C
SCDS124	13	7	5.4
SCDS125	13	7	5.4
SCDS127	13	7	5.4

Standard Specifications

Stamp	Inductance (μH)	RDC (mΩ) Max									
		SCDS 62T	SCDS 64T	SCDS 73	SCDS 74	SCDS 103R	SCDS 104R	SCDS 105R	SCDS 124	SCDS 125	SCDS 127
R80	0.8							4.3			
1R2	1.2										7.0
1R5	1.5						8.1	5.8			
2R2	2.2							11			
2R4	2.4										11.5
2R5	2.5						10.5				
3R3	3.3	68						10.4			
3R5	3.5										13.5
3R8	3.8						13				
3R9	3.9								15		
4R7	4.7	80				30		12.3	18		15.8
5R2	5.2						22				
5R5	5.5	96									
6R1	6.1										17.6
6R8	6.8	100				35		18	23		
7R0	7.0						27				
7R6	7.6										20.0
8R2	8.2	100						20			
100	10	150	120	72	49	59	35	26	28	25	21.6
120	12	200	130	98	58			33	38	27	24.3
150	15	230	180	130	81	91	50	41	50	30	27.0
180	18	270	240	140	91			46	57	34	39.2
220	22	340	270	190	110		73	61	66	36	43.2
270	27	380	300	210	150			69	80	51	45.9
330	33	450	330	240	170	202	93	84	97	57	64.8
390	39	490	370	320	230			106	132	68	72.9
470	47	690	520	360	260		128	130	150	75	100
560	56	780	560	470	350			149	190	110	110
680	68	1070	630	520	380		213	201	220	120	140
820	82	1210	710	690	430			227	260	140	160
101	100	1390	1030	790	610			304	253	308	160
121	120	1900	1150	890	660				303	380	170
151	150	2180	1680	1270	880		506	370	530	230	280
181	180	2770	1870	1450	980			419	620	290	350
221	220	3120	2080	1650	1170			756	500	700	400
271	270	4380	2370	2310	1640				672	876	460
331	330	4940	2670	2620	1860		1.09	812	990	510	640
391	390		2940	2940	2850			953		690	700
471	470		3930	4180	3010			1289		770	980
561	560		5430	4670	3620			1430		860	1070
681	680		7320	5730	4630			1599		1200	1460
821	820		8240	6540	5200			1768		1340	1640
102	1000		9260	9440	6000			1989		1530	1820

Test Freq. (L): 103R/ 104R/ 105R/ 124 (100KHz/ 1V) , SCDS 127: 1.2~7.6μH (100KHz/ 1V) 10~1000μH (1KHz /1V)
 SCDS 62T: 3.3~8.2μH (7.96MHz/ 1V), 10~82μH (2.52MHz/ 1V), 100~330μH(1KHz/ 1V)
 SCDS 64T/ 73/ 74/ 125: (1KHz/ 1V)

Isat: DC current (A) that will cause L to drop approximately 35%

Test Instrument: L: Agilent/ E4980 or HP4284A (over 1MHz), HP4285A (under 1MHz)

RDC: CH502BC

Rated Current: HP4284+42841A or WK3260B+WK3265B

Standard Specifications

Stamp	Inductance (μH)	Isat (A)									
		SCDS 62	SCDS 64	SCDS 73	SCDS 74	SCDS 103R	SCDS 104R	SCDS 105R	SCDS 124	SCDS 125	SCDS 127
R80	0.8							13.5			
1R2	1.2										9.80
1R5	1.5						10.0	10.5			
2R2	2.2							9.25			
2R4	2.4										8.00
2R5	2.5						7.5				
3R3	3.3	1.94						7.8			
3R5	3.5										7.50
3R8	3.8						6.0				
3R9	3.9								6.50		
4R7	4.7	1.63				4.65		6.40	5.70		6.80
5R2	5.2						5.5				
5R5	5.5	1.40									
6R1	6.1										6.60
6R8	6.8	1.33				3.84		5.40	4.90		
7R0	7.0						4.8				
7R6	7.6										5.90
8R2	8.2	1.14						4.85			
100	10	1.10	1.35	1.68	1.84	3.18	4.4	4.45	4.50	4.00	5.40
120	12	1.00	1.22	1.52	1.71			4.00	4.00	3.50	4.90
150	15	0.90	1.11	1.33	1.47	2.60	3.6	3.60	3.20	3.30	4.50
180	18	0.80	1.02	1.20	1.31			3.20	3.10	3.00	3.90
220	22	0.74	0.91	1.07	1.23		2.9	2.95	2.90	2.80	3.60
270	27	0.66	0.82	0.96	1.12			2.70	2.80	2.30	3.40
330	33	0.59	0.74	0.91	0.96	1.74	2.3	2.50	2.70	2.10	3.00
390	39	0.54	0.69	0.77	0.91			2.30	2.10	2.00	2.75
470	47	0.50	0.62	0.76	0.88		2.1	2.00	1.90	1.80	2.50
560	56	0.46	0.58	0.68	0.75			1.90	1.80	1.70	2.35
680	68	0.42	0.51	0.61	0.69		1.5	1.65	1.50	1.50	2.10
820	82	0.38	0.46	0.57	0.61			1.50	1.30	1.40	1.95
101	100	0.34	0.42	0.50	0.60		1.35	1.35	1.20	1.30	1.70
121	120	0.31	0.38	0.49	0.52			1.28	1.10	1.10	1.60
151	150	0.28	0.35	0.43	0.46		1.15	1.12	0.95	1.00	1.42
181	180	0.26	0.32	0.39	0.42			1.04	0.85	0.90	1.30
221	220	0.23	0.29	0.35	0.36		0.92	0.94	0.80	0.80	1.16
271	270	0.22	0.26	0.32	0.34			0.84	0.60	0.75	1.06
331	330	0.19	0.23	0.28	0.32		0.70	0.75	0.50	0.68	0.95
391	390		0.22	0.26	0.29			0.70		0.65	0.88
471	470		0.20	0.24	0.26			0.60		0.58	0.79
561	560		0.18	0.22	0.23			0.54		0.54	0.73
681	680		0.17	0.19	0.22			0.52		0.48	0.67
821	820		0.15	0.18	0.20			0.50		0.43	0.60
102	1000		0.14	0.16	0.18			0.48		0.40	0.55

Tolerance Of Inductors

- SCDS 62T 3.3 ~ 330uH ± 20%
- SCDS 64T 10 ~ 1000uH ± 20%
- SCDS 73 10 ~ 1000uH ± 20%
- SCDS 74 10 ~ 1000uH ± 20%
- SCDS 103R 4.7~33uH ± 30%
- Tolerance : M = ±20%, T = ±30%, N = ⁺⁴⁰/₋₂₀%
- SCDS 104R 1.5 ~ 330uH ± 30%
- SCDS 105R 0.8 ~ 1000uH ± 30%
- SCDS 124 3.9 ~ 330uH ±20%
- SCDS 125 10 ~ 1000uH ± 20%
- SCDS 127 1.2 ~ 7.6uH ⁺⁴⁰/₋₂₀%
- SCDS 127 10 ~ 1000uH ± 20%

Curves of SCDS Series

Test Instruments : HP4294 Impedance / Material Analyzer

SCDS62

INDUCTANCE vs. FREQUENCY CHARACTERISTICS

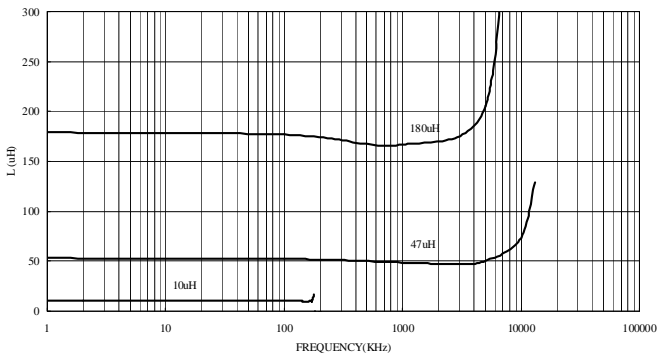

Inductance vs. DC Current

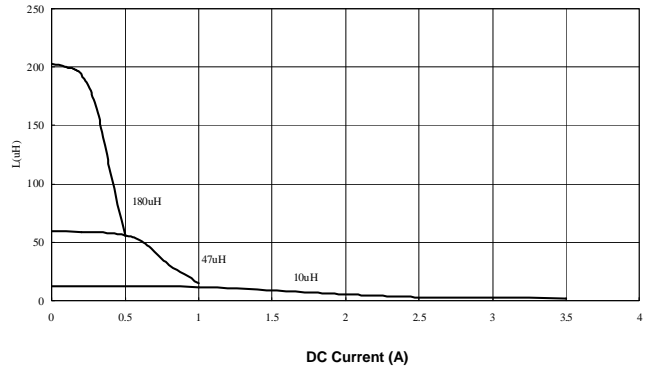

SCDS64

INDUCTANCE vs. FREQUENCY CHARACTERISTICS

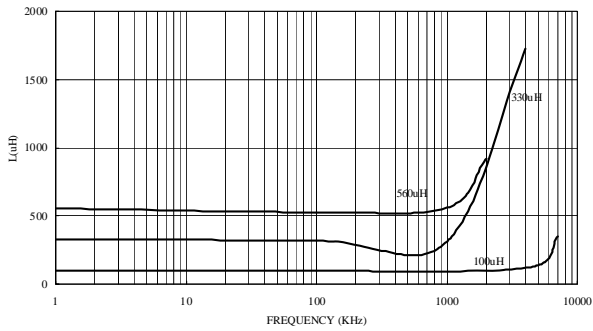

Inductance vs. DC Current

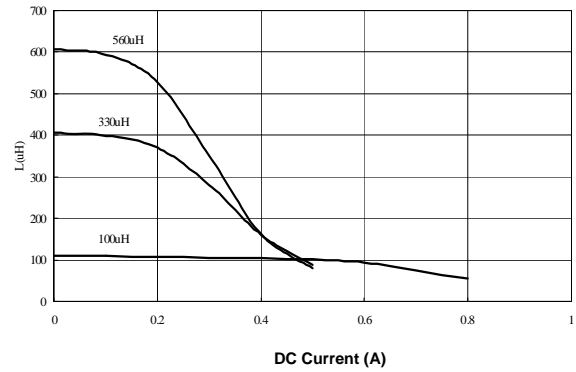

SCDS73

INDUCTANCE vs. FREQUENCY CHARACTERISTICS

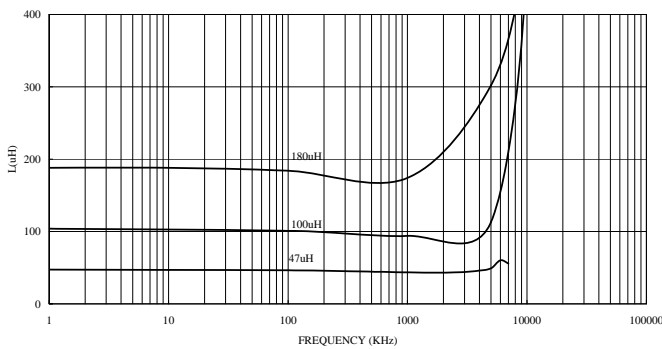

Inductance vs. DC Current

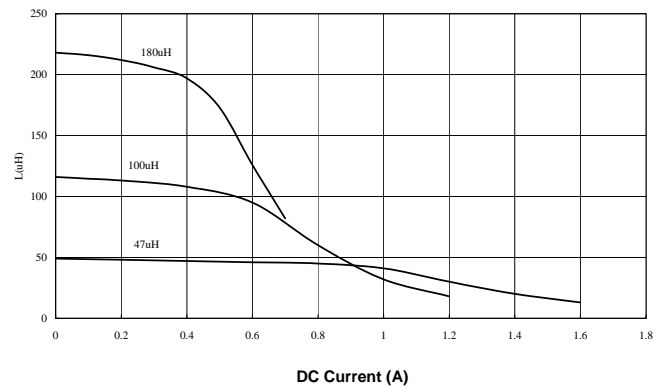

Test Instruments : HP4294 Impedance / Material Analyzer

SCDS74

INDUCTANCE vs. FREQUENCY CHARACTERISTICS

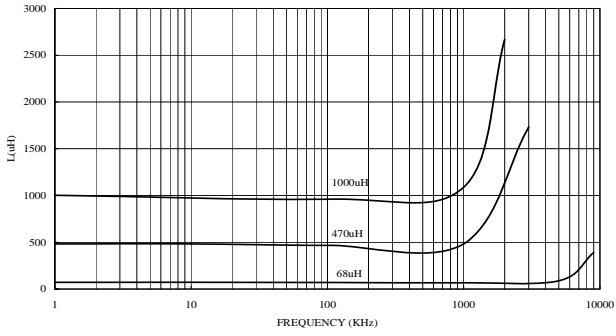

Inductance vs. DC Current

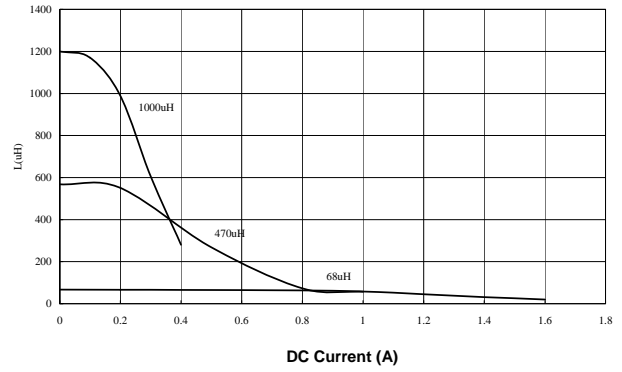

SCDS104R

SCDS104R-220M-N

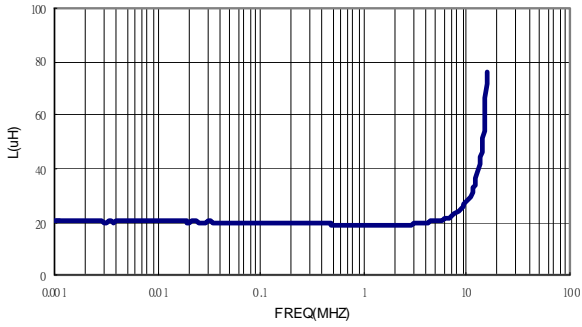

SCDS104R-220M-N

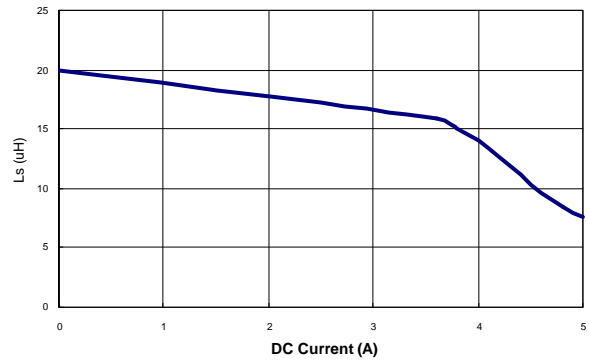

SCDS124

INDUCTANCE vs. FREQUENCY CHARACTERISTICS

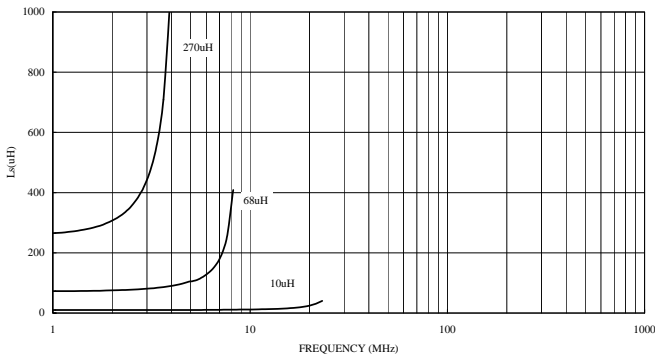

Inductance vs. DC Current

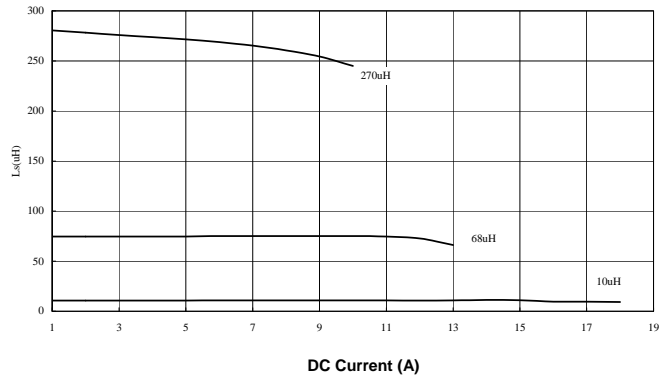

Test Instruments : HP4294 Impedance / Material Analyzer

SCDS125

INDUCTANCE vs. FREQUENCY CHARACTERISTICS

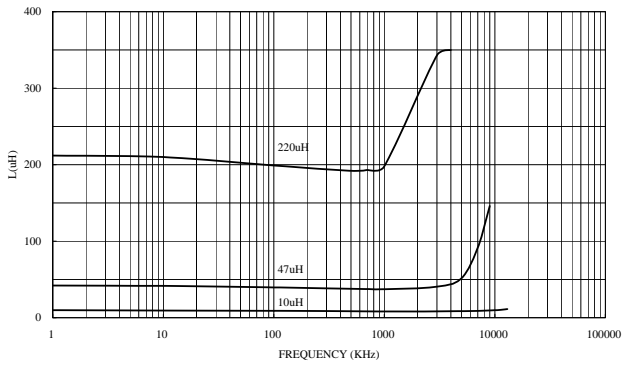

Inductance vs. DC Current

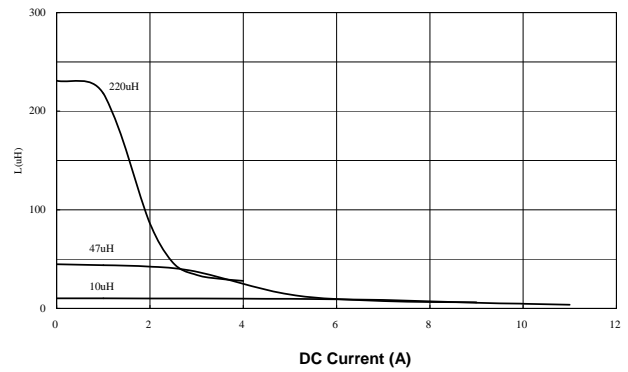

SCDS127

INDUCTANCE vs. FREQUENCY CHARACTERISTICS

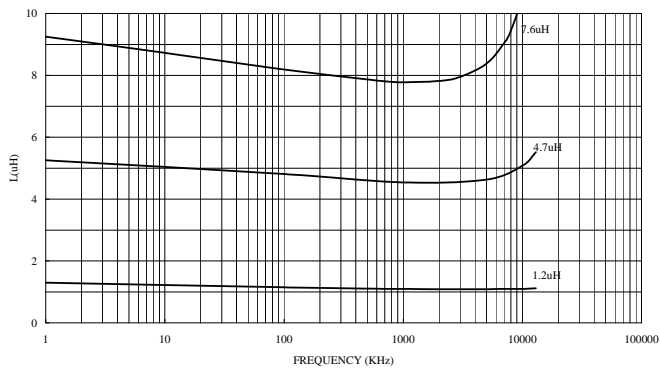

Inductance vs. DC Current

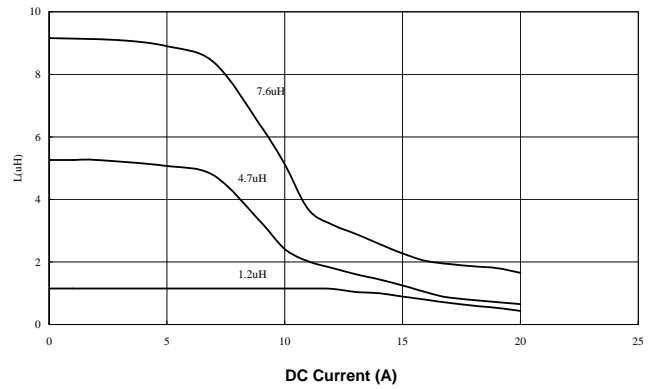

Packaging Specifications

Tape Dimensions

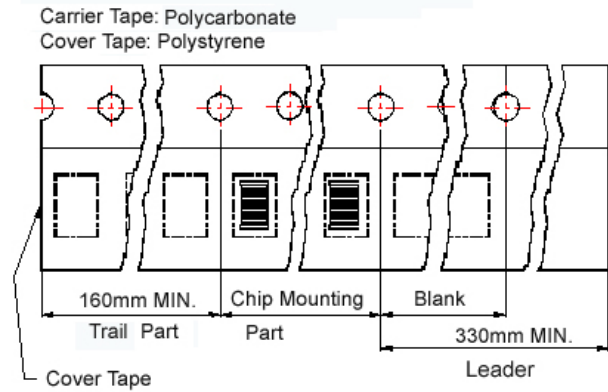
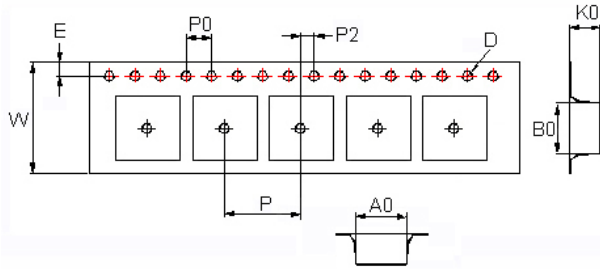

Reel Dimensions

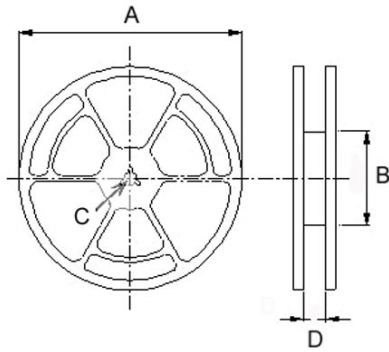

Dimensions in mm

TYPE	Tape Dimensions									Reel Dimensions				Quantity
	A0	B0	K0	D	E	W	P	P0	P2	A	B	C	D	PCS / REEL
SCDS 62	6.5	6.2	3.4	1.55	1.75	16	12	4	2	330	100	13	17.4	1500
SCDS 64	6.5	6.2	4.95	1.55	1.75	16	12	4	2	330	100	13	17.4	1000
SCDS 73	7.6	7.6	3.6	1.55	1.75	16	12	4	2	330	100	13	17.4	1600
SCDS 74	7.6	7.6	5.0	1.55	1.75	16	12	4	2	330	100	13	17.4	1000
SCDS 103R	10.6	10.75	4.2	1.55	1.75	24	16	4	2	300	100	13	24.4	1000
SCDS 104R	10.6	10.75	4.2	1.5	1.75	24	16	4	2	330	100	13	24.4	1000
SCDS 105R	10.6	10.6	5.0	1.5	1.75	24	16	4	2	330	100	13	24.4	500
SCDS 124	13.0	12.8	5.1	1.55	1.75	24	16	4	2	330	100	13	24.4	500
SCDS 125	12.6	12.6	6.7	1.55	1.75	24	16	4	2	330	100	13	24.4	600
SCDS 127	12.6	12.6	8.7	1.55	1.75	24	16	4	2	330	100	13	24.4	500

SCDS Series



Features

- RoHS compliant
- Available in magnetic shielding
- Low DC resistance
- Suitable for large currents
- Ideal for a variety of DC – DC converter inductor applications
- Available on tape and reel for auto surface mounting

Applications

- Power supply for VTRs
- OA equipment
- LCD televisions
- Notebook PCs
- Portable communication devices
- DC / DC converters, etc

Product Identification

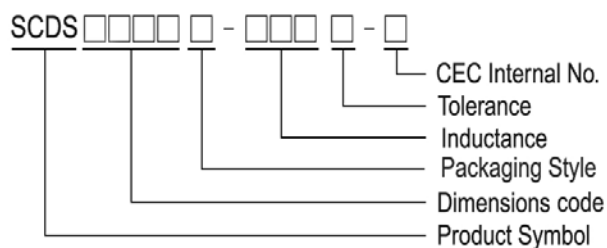

- T : Packaging: Tape and Reel

Shapes and Dimensions

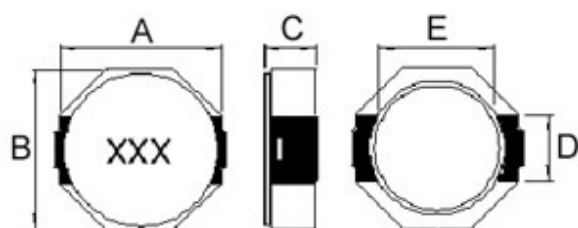

Recommended Pattern

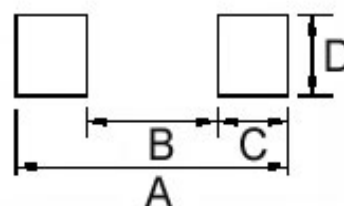

Dimension in mm

TYPE	A	B	C	D	E
SCDS8D43	8.3 ⁺⁰	8.3 ⁺⁰	4.5 ⁺⁰	2.5	6.3

Dimension in mm

TYPE	A	B	C	D
SCDS8D43	10.1	6.1	2.0	2.8

Electrical Characteristics

Part Number	Inductance (μH)	Tolerance ($\pm\%$)	DC Resistance ($\text{m}\Omega$) Max	Rated Current (A)
SCDS8D43T-3R3□-N	3.3	30	19	5.7
SCDS8D43T-100□-N	10	30	36	4.0
SCDS8D43T-220□-N	22	30	75	2.4
SCDS8D43T-470□-N	47	30	150	1.8
SCDS8D43T-680□-N	68	30	240	1.5

- When ordering, please specify tolerance and packaging codes
- Inductance range : 3.3uH to 68uH
- Inductance tested at 100KHz./1V
- Tolerance: M = $\pm 20\%$
- Rated current : Isat DC current (A) that will cause L to drop approximately 35% over of it's nominal value or D.C.current when the temperature rising $\Delta T=30^{\circ}\text{C}$ lower, whichever is lower
- Test Instrument: L : HP4284A
RDC : CHEN HWA 502BC
Rated current : HP4284+42841A

Packaging Specifications

Tape Dimensions

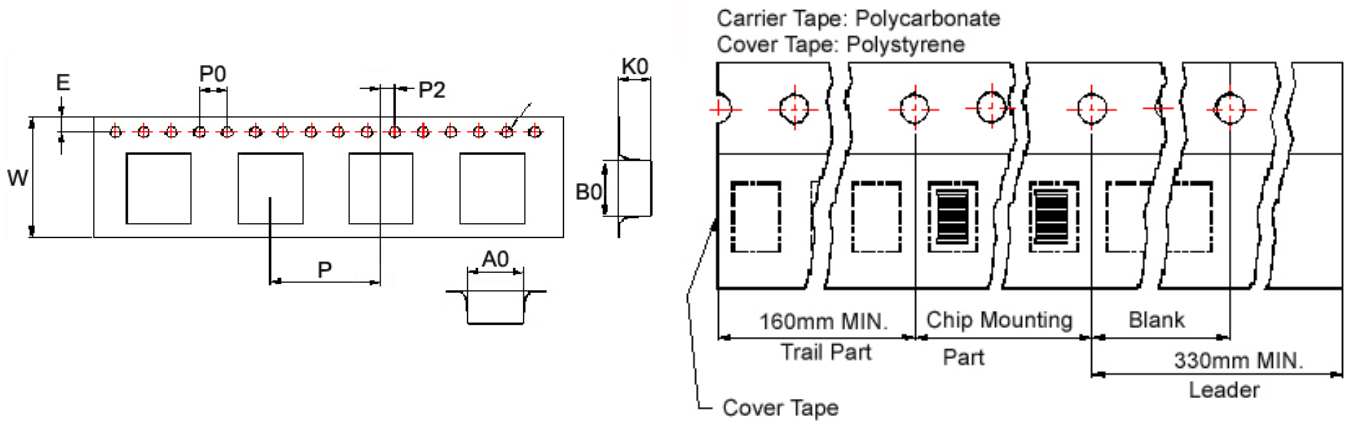

Reel Dimensions

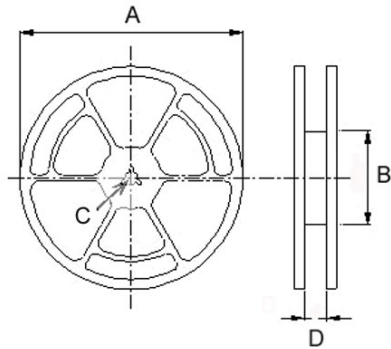

Dimensions in mm

TYPE	Tape Dimensions									Reel Dimensions				Quantity PCS / REEL
	A0	B0	K0	D	E	W	P	P0	P2	A	B	C	D	
SCDS 8D43	8.4	9.9	4.8	1.55	1.75	24	12	4	2	330	100	13	24.4	1000

SDS Series



These shielded ultra-miniature inductors can help designers achieve significantly longer battery life in handheld communication devices and other portable products. They are designed with a flat top and constructed of heat resistant materials to ensure trouble-free assembly and reflow operations.

Features

- RoHS compliant
- Smallest size and high performance
- High energy storage and very low resistance

Applications

- Notebook computers, step-up and step-down converters
- Flash memory programmers, etc

Product Identification

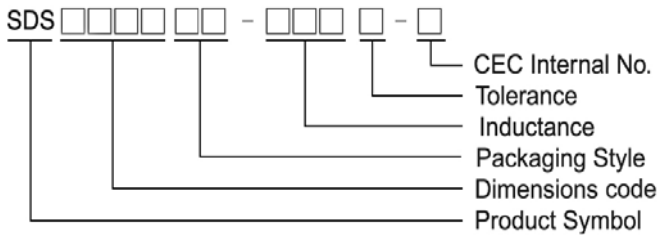

- Packaging: T: Tape and Reel

Shape and Dimensions

SDS0402

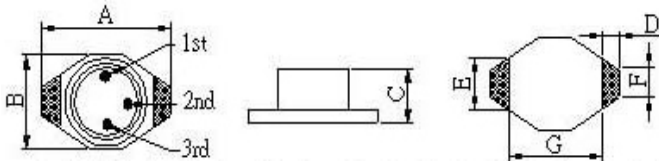

Dimensions in mm

TYPE	A	B	C	D	E	F	G
SDS0402	6.60 ⁺⁰	4.45 ⁺⁰	2.92 ⁺⁰	1.02	3.05	1.27	4.32

Recommended Pattern

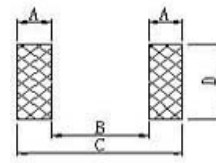

Dimensions in mm

TYPE	A	B	C	D
SDS0402	1.4	4.06	6.86	3.56

SDS0804

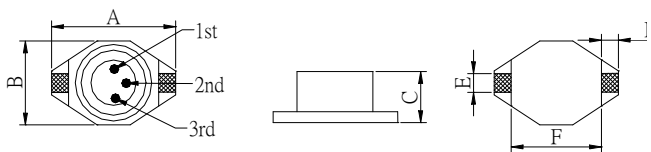

Dimensions in mm

TYPE	A	B	C	D	E	F
SDS0804	12.95 ⁺⁰	9.40 ⁺⁰	5.08 ⁺⁰	2.54	2.54	7.62

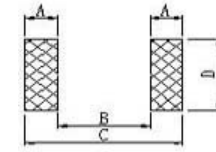

Dimensions in mm

TYPE	A	B	C	D
SDS0804	2.92	7.37	13.21	2.79

SDS1306

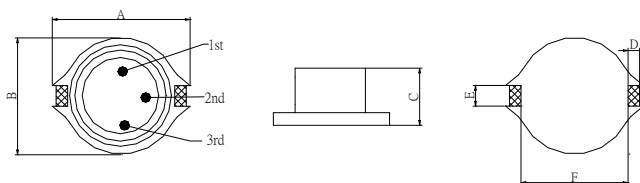

Dimensions in mm

TYPE	A	B	C	D	E	F
SDS1306	18.54 ⁺⁰	15.24 ⁺⁰	7.62 ⁺⁰	2.54	2.54	12.7

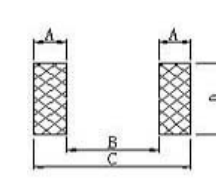

Dimensions in mm

TYPE	A	B	C	D
SDS1306	2.92	12.45	18.29	2.79

Electrical Characteristics

Part Number	Inductance (μH)	Tolerance (±%)	Q Min	Q Frequency (KHz)	DC Resistance (Ω) Max	SRF (MHz) Typ.	Irms (A)
SDS0402T-1R0M-N	1.0	20	30	200	0.040	200	3.0
SDS0402T-1R5M-N	1.5	20	30	200	0.045	100	2.8
SDS0402T-2R2M-N	2.2	20	40	200	0.050	90	1.8
SDS0402T-3R3M-N	3.3	20	40	200	0.060	90	1.6
SDS0402T-4R7M-N	4.7	20	40	200	0.065	80	1.4
SDS0402T-6R8M-N	6.8	20	40	200	0.070	40	1.2
SDS0402T-100M-N	10	20	40	200	0.075	30	1.0
SDS0402T-150M-N	15	20	40	100	0.090	25	0.80
SDS0402T-220M-N	22	20	40	100	0.110	20	0.70
SDS0402T-330M-N	33	20	40	100	0.190	15	0.60
SDS0402T-470M-N	47	20	40	100	0.230	15	0.50
SDS0402T-680M-N	68	20	40	100	0.290	10	0.40
SDS0402T-101M-N	100	20	40	100	0.480	8	0.30
SDS0402T-151M-N	150	20	40	100	0.590	7	0.26
SDS0402T-221M-N	220	20	40	100	0.770	4	0.22
SDS0402T-331M-N	330	20	40	100	1.4	4	0.20
SDS0402T-471M-N	470	20	40	100	1.8	3	0.19
SDS0402T-681M-N	680	20	40	100	2.2	2	0.18
SDS0402T-102M-N	1000	20	40	100	3.4	1	0.15

- Inductance tested at 0.1 Vrms, 100KHz.
- 30°C temperature rise at Irms
- Tolerance: M = ±20%
- Operating temperature range – 40 ~ 125 °C (Including self - temperature rise)

Test Instruments : HP4294A Impedance / Material Analyzer

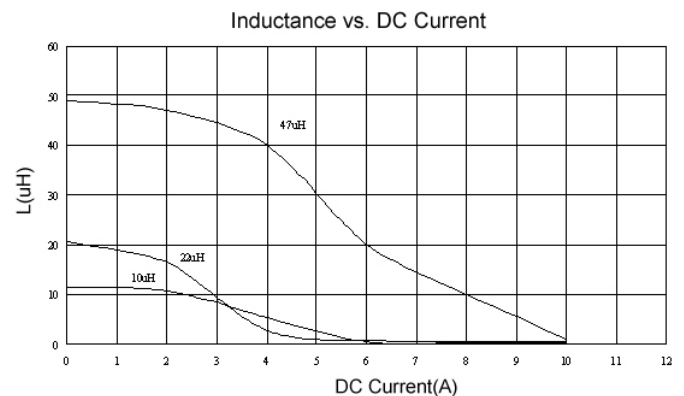
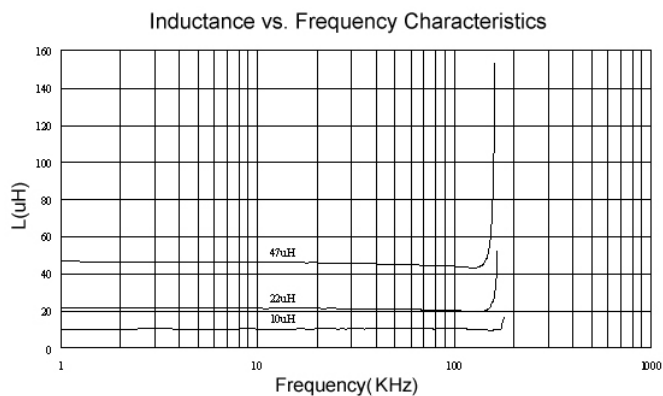

Electrical Characteristics

Part Number	Inductance (μH)	Tolerance (±%)	Q Min	Q Frequency (KHz)	DC Resistance (Ω) Max	SRF (MHz) Typ.	Isat (A)	Irms (A)
SDS0804T-1R0M-N	1.0	20	3	100	0.021	110	5.6	5.0
SDS0804T-1R5M-N	1.5	20	5	100	0.022	90	5.2	4.5
SDS0804T-2R2M-N	2.2	20	5	100	0.032	60	5.0	3.8
SDS0804T-3R3M-N	3.3	20	5	100	0.039	55	3.9	3.3
SDS0804T-4R7M-N	4.7	20	10	100	0.054	30	3.2	2.7
SDS0804T-6R8M-N	6.8	20	10	100	0.075	30	2.8	2.2
SDS0804T-100M-N	10.0	20	10	100	0.101	28	2.4	2.0
SDS0804T-150M-N	15.0	20	15	100	0.15	20	2.0	1.5
SDS0804T-220M-N	22.0	20	20	100	0.207	15	1.6	1.3
SDS0804T-330M-N	33.0	20	20	100	0.334	12	1.4	1.1
SDS0804T-470M-N	47.0	20	20	100	0.472	10	1.0	0.8

- Tested at 100KHz , 0.1 Vrms.
- Inductance drop = 10% typ. At rated Isat.
- 40°C rise typ. at I rms.
- Tolerance: M = ±20%
- Operating temperature range – 40 °C ~ 125 °C (Including self - temperature rise)

Test Instruments : HP4294A Impedance / Material Analyzer

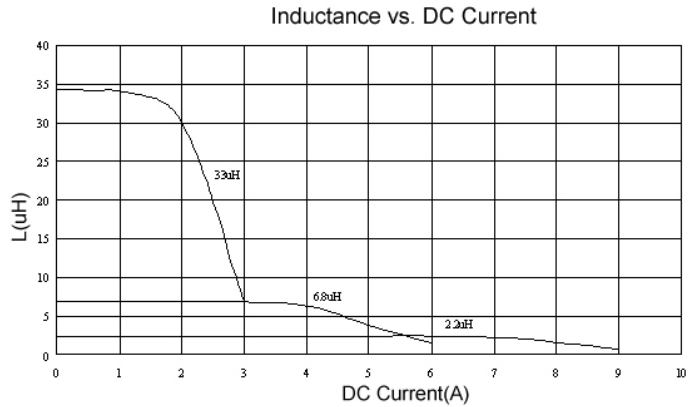
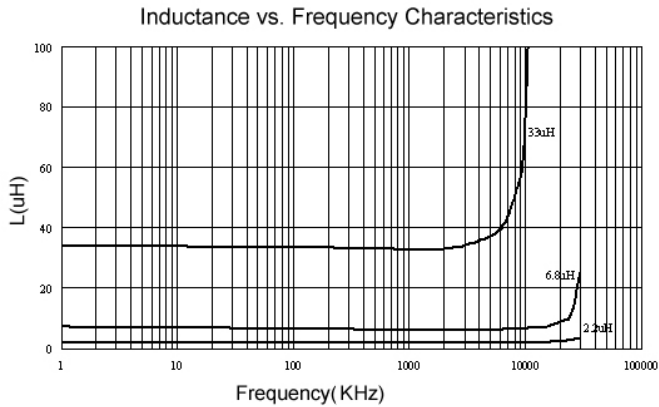

Electrical Characteristics

Part Number	Inductance (μH)	Tolerance (±%)	Q Min	Q Frequency (KHz)	DC Resistance (Ω) Max	Isat (A)	Irms (A)	SRF (MHz) Typ.
SDS1306T-100M-N	10	20	40	100	0.040	5.5	3.9	24
SDS1306T-150M-N	15	20	40	100	0.048	4.5	3.4	16
SDS1306T-220M-N	22	20	30	100	0.059	3.5	3.1	14
SDS1306T-330M-N	33	20	40	100	0.075	3.3	2.8	11
SDS1306T-470M-N	47	20	40	100	0.097	2.7	2.4	8.0
SDS1306T-680M-N	68	20	40	100	0.140	2.2	2.0	7.0
SDS1306T-101M-N	100	20	40	100	0.210	1.7	1.7	5.5
SDS1306T-151M-N	150	20	50	100	0.300	1.3	1.3	4.8
SDS1306T-221M-N	220	20	50	100	0.470	1.1	1.1	4.0
SDS1306T-331M-N	330	20	50	100	0.780	0.86	0.86	3.0
SDS1306T-471M-N	470	20	50	100	1.08	0.73	0.73	2.4
SDS1306T-681M-N	680	20	60	100	1.40	0.64	0.64	2.0
SDS1306T-102M-N	1000	20	60	100	2.01	0.53	0.53	1.0

- Inductance tested at 0.1 Vrms, 100KHz.
- Inductance drop 10% typ. at Isat.
- 40°C rise typ. at Iirms.
- Tolerance: M = ±20%
- Operating temperature range – 4 0 °C ~ 1 2 5 °C (Including self - temperature rise)

Test Instruments : HP4294A Impedance / Material Analyzer

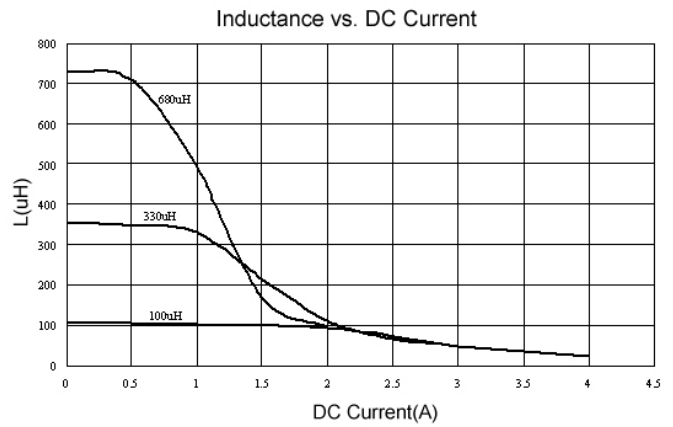
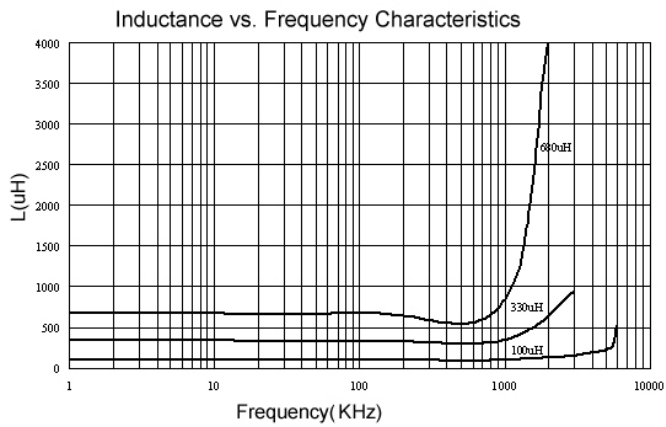

Packaging Specifications

Tape Dimensions

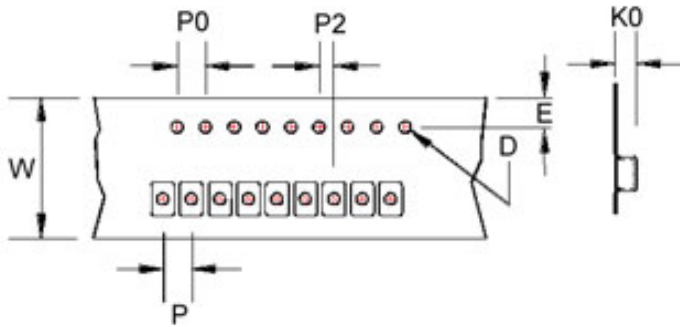

Tape Material

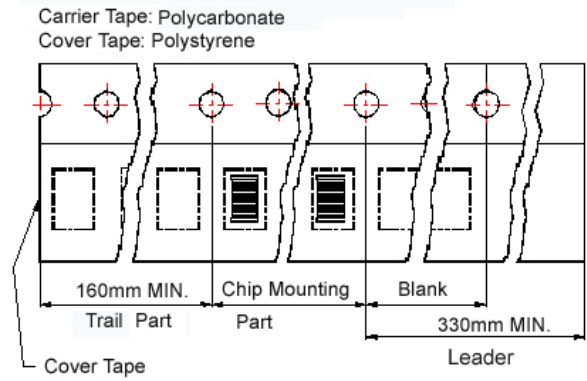

Reel Dimensions

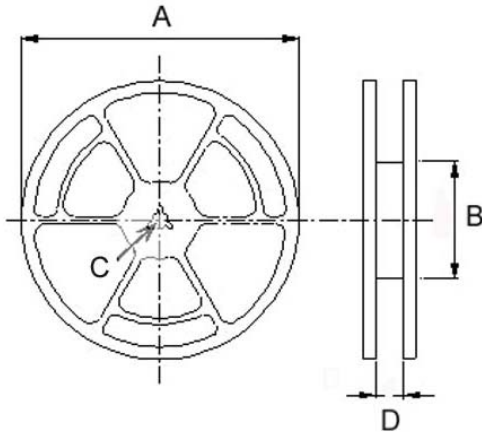

Dimensions

TYPE	Tape Dimensions							Reel Dimensions				Quantity (PCS / REEL)	
	K0	D	E	W	P	P0	P2	A	B	C	D	178mm	330mm
SDS 0402	3.2	1.55	1.75	12	8	4	2	330	100	13	13.4	-	2500
								178	60	13	13.2	750	-
SDS 0804	5.4	1.55	1.75	24	12	4	2	330	100	13	24.4	-	1000
SDS 1306	7.5	1.55	1.75	32	20	4	2	330	100	13	33.4	-	250

SLF Series



SLF series is designed for low profile type with low Rdc and large current. Its magnetic shielded type is suitable for high-density mounting and flat bottom surface allows for reliable mounting onto the board. Soldering conditions can be easily confirmed when mounting onto the board. This series also provides customers with embossed carrier type packaging for automatic mounting machine.

Features

- RoHS compliant
- Low resistance and high rated currents

Applications

- Portable telephones
- Computers
- Hard disk drives and other electronic devices

Products Identification

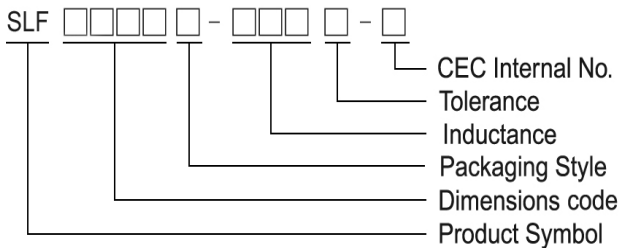

- Packaging: T : Tape and Reel

Shape and Dimensions

SLF 0628

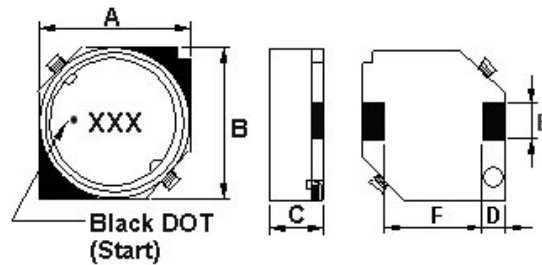

Dimension in mm

TYPE	A	B	C	D	E	F
SLF 0628	6 ± 0.2	6 ± 0.2	2.8 ± 0.2	1.5 TYP	2 ± 0.1	3.0 TYP

SLF0728/ 0732/ 0745/ 0730

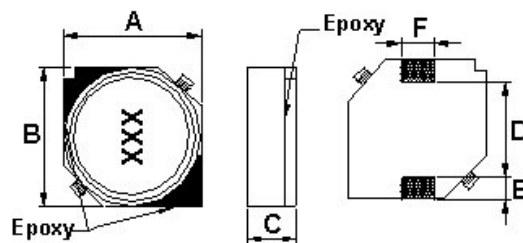

Dimension in mm

TYPE	A	B	C	D	E	F
SLF 0728	7 ± 0.2	7 ± 0.2	2.8 ± 0.2	4.9 TYP	0.9TYP	2.0 TYP
SLF 0730	7 ± 0.2	7 ± 0.2	3.0 ± 0.2	4.9 TYP	0.9TYP	2.0 TYP
SLF 0732	7 ± 0.2	7 ± 0.2	3.2 ± 0.2	4.9 TYP	0.9TYP	2.0 TYP
SLF 0745	7 ± 0.2	7 ± 0.2	4.5 ± 0.3	4.9 TYP	0.9TYP	2.0 TYP

Shape and Dimensions

SLF 1045/ 1055

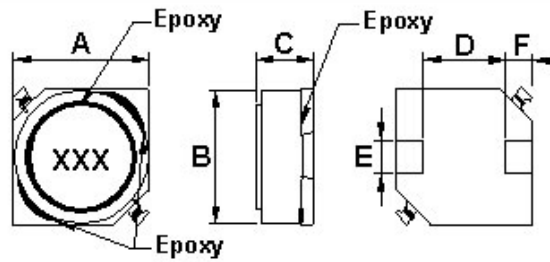

Dimension in mm

TYPE	A	B	C	D	E	F
SLF 1045	10.1 ± 0.3	10.1 ± 0.3	4.5 ± 0.3	6.0 TYP	3.0 TYP	2 TYP
SLF 1055	10.1 ± 0.3	10.1 ± 0.3	5.5 ± 0.3	6.0 TYP	3.0 TYP	2 TYP

SLF 0755/ 1255/ 1265/ 1275

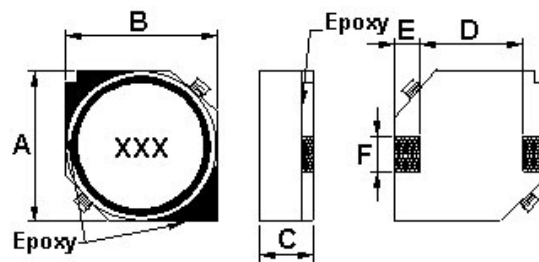

Dimension in mm

TYPE	A	B	C	D	E	F
SLF 0755	7.0 ± 0.2	7.0 ± 0.2	5.5 ± 0.3	4.9 TYP	0.9 TYP	2.0 TYP
SLF 1255	12.5 ± 0.3	12.5 ± 0.3	5.5 ± 0.3	8.6 TYP	2.0 TYP	3.0 TYP
SLF 1265	12.5 ± 0.3	12.5 ± 0.3	6.5 ± 0.35	8.6 TYP	2.0 TYP	3.0 TYP
SLF 1275	12.5 ± 0.3	12.5 ± 0.3	7.5 ± 0.35	8.6 TYP	2.0 TYP	3.0 TYP

Recommended Pattern

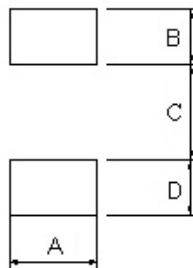

Dimension in mm

TYPE	A	B	C	D
SLF 0628	2.2	1.5	4.0	1.5
SLF 0728	2.2	1.5	4.9	1.5
SLF 0730	2.2	1.5	4.9	1.5
SLF 0732	2.2	1.5	4.9	1.5
SLF 0745	2.2	1.5	4.9	1.5
SLF 0755	2.2	1.5	4.9	1.5
SLF 1045	3.2	2.5	5.6	2.5
SLF 1045	3.2	2.5	5.6	2.5
SLF 1105	3.2	2.5	5.6	2.5
SLF 1255	3.2	2.5	8.6	2.5
SLF 1265	3.2	2.5	8.6	2.5
SLF 1275	3.2	2.5	8.6	2.5

Electrical Characteristics

Part Number	Inductance (μH)	Tolerance ($\pm\%$)	Test Frequency (KHz)	DC Resistance ($\Omega\pm 20\%$)	Isat (A)	Itemp (A) Max
SLF0628T-4R7M-N	4.7	20	1	0.0284	1.6	2.5
SLF0628T-6R8M-N	6.8	20	1	0.0354	1.5	2.2
SLF0628T-100M-N	10	20	1	0.0532	1.3	1.8
SLF0628T-150M-N	15	20	1	0.0745	1.0	1.4
SLF0628T-220M-N	22	20	1	0.104	0.77	1.3
SLF0628T-330M-N	33	20	1	0.148	0.69	1.1
SLF0628T-470M-N	47	20	1	0.21	0.59	0.92
SLF0628T-680M-N	68	20	1	0.29	0.50	0.78
SLF0628T-101M-N	100	20	1	0.43	0.42	0.64

- Tolerance: M = $\pm 20\%$
- Isat: Value obtained when DC current flows and the initial value of inductance has fallen by 30%
- Itemp current: Value obtained when current flows and the temperature has risen to 25°C
- Test equipment Inductance: HP4284A LF impedance analyzer or equivalent (Test frequency:1KHz/0.5V)
- RDC: CH502BC

Electrical Characteristics

Part Number	Inductance (μH)	Tolerance ($\pm\%$)	Test Frequency (KHz)	DC Resistance ($\Omega\pm 20\%$)	Isat (A)
SLF0728T-3R3M-N	3.3	20	1	0.037	1.6
SLF0728T-4R7M-N	4.7	20	1	0.045	1.5
SLF0728T-6R8M-N	6.8	20	1	0.059	1.3
SLF0728T-100M-N	10	20	1	0.083	1.1
SLF0728T-150M-N	15	20	1	0.13	0.88
SLF0728T-220M-N	22	20	1	0.18	0.75
SLF0728T-330M-N	33	20	1	0.24	0.65
SLF0728T-470M-N	47	20	1	0.34	0.54

- Tolerance: M = $\pm 20\%$
- Isat: Value obtained when DC current flows and the initial value of inductance has fallen by 10%
- Test equipment Inductance: HP4284A LF impedance analyzer or equivalent (Test frequency:1KHz/0.5V)
- RDC: CH502BC

Electrical Characteristics

Part Number	Inductance (μH)	Tolerance ($\pm\%$)	Test Frequency (KHz)	DC Resistance ($\Omega\pm 20\%$)	Isat (A)
SLF0730T-3R3M-N	3.3	20	1	0.023	1.8
SLF0730T-4R7M-N	4.7	20	1	0.036	1.6
SLF0730T-6R8M-N	6.8	20	1	0.041	1.5
SLF0730T-100M-N	10	20	1	0.060	1.3
SLF0730T-150M-N	15	20	1	0.084	1
SLF0730T-220M-N	22	20	1	0.15	0.86
SLF0730T-330M-N	33	20	1	0.16	0.65
SLF0730T-470M-N	47	20	1	0.24	0.57
SLF0730T-680M-N	68	20	1	0.31	0.49
SLF0730T-101M-N	100	20	1	0.45	0.35

- Tolerance: M = $\pm 20\%$
- Isat: Value obtained when DC current flows and the initial value of inductance has fallen by 10%
- Test equipment Inductance: HP4284A LF impedance analyzer or equivalent (Test frequency:1KHz/0.5V)
- RDC: CH502BC

Electrical Characteristics

Part Number	Inductance (μ H)	Tolerance (\pm %)	Test Frequency (KHz)	DC Resistance (Ω \pm 20%)	Isat (A)
SLF0732T-2R2M-N	2.2	20	1	0.018	2.1
SLF0732T-3R3M-N	3.3	20	1	0.023	1.9
SLF0732T-4R7M-N	4.7	20	1	0.036	1.7
SLF0732T-6R8M-N	6.8	20	1	0.041	1.6
SLF0732T-100M-N	10	20	1	0.053	1.4
SLF0732T-150M-N	15	20	1	0.075	1.1
SLF0732T-220M-N	22	20	1	0.11	0.96
SLF0732T-330M-N	33	20	1	0.16	0.75
SLF0732T-470M-N	47	20	1	0.24	0.67
SLF0732T-680M-N	68	20	1	0.31	0.59
SLF0732T-101M-N	100	20	1	0.45	0.45
SLF0732T-151M-N	150	20	1	0.65	0.37
SLF0732T-221M-N	220	20	1	1.05	0.29
SLF0732T-331M-N	330	20	1	1.67	0.22
SLF0732T-471M-N	470	20	1	2.05	0.2
SLF0732T-681M-N	680	20	1	3.15	0.16
SLF0732T-102M-N	1000	20	1	4.78	0.13

- Tolerance: M = \pm 20%
- Isat: Value obtained when DC current flows and the initial value of inductance has fallen by 10%
- Test equipment Inductance: HP4284A LF impedance analyzer or equivalent (Test frequency:1KHz/0.5V)
- RDC:CH502BC

Electrical Characteristics

Part Number	Inductance (μ H)	Tolerance (\pm %)	Test Frequency (KHz)	DC Resistance (Ω \pm 20%)	Isat (A)	Itemp (A) Max
SLF0745T-3R3M-N	3.3	20	1	0.02	2.5	2.3
SLF0745T-4R7M-N	4.7	20	1	0.03	2	2.1
SLF0745T-6R8M-N	6.8	20	1	0.039	1.7	1.74
SLF0745T-100M-N	10	20	1	0.036	1.3	1.78
SLF0745T-150M-N	15	20	1	0.052	1.1	1.53
SLF0745T-220M-N	22	20	1	0.061	0.9	1.34
SLF0745T-330M-N	33	20	1	0.096	0.82	1.09
SLF0745T-470M-N	47	20	1	0.125	0.75	0.92
SLF0745T-680M-N	68	20	1	0.175	0.6	0.77
SLF0745T-101M-N	100	20	1	0.25	0.5	0.65
SLF0745T-151M-N	150	20	1	0.34	0.4	0.55
SLF0745T-221M-N	220	20	1	0.52	0.33	0.45
SLF0745T-331M-N	330	20	1	0.74	0.25	0.37
SLF0745T-471M-N	470	20	1	1.05	0.22	0.31
SLF0745T-681M-N	680	20	1	1.48	0.2	0.27
SLF0745T-102M-N	1000	20	1	2.28	0.14	0.25

- Tolerance: M = \pm 20%
- Isat: Value obtained when DC current flows and the initial value of inductance has fallen by 10%
- Itemp current : Value obtained when current flows and the temperature has risen to 20°C
- Test equipment Inductance: HP4284A LF impedance analyzer or equivalent (Test frequency: 1KHz/0.5V)
- RDC: CH502BC

Electrical Characteristics

Part Number	Inductance (μ H)	Tolerance (\pm %)	Test Frequency (KHz)	DC Resistance (Ω)	Isat (A)	Itemp (A) Max
SLF0755T-1R5T-N	1.5	30	100	0.0174 \pm 30%	6.2	4.0
SLF0755T-2R2T-N	2.2	30	100	0.0217 \pm 30%	5.3	3.5
SLF0755T-3R3T-N	3.3	30	100	0.0240 \pm 30%	4.3	3.3
SLF0755T-4R7T-N	4.7	30	100	0.0280 \pm 30%	3.6	3.1
SLF0755T-6R8T-N	6.8	30	100	0.0340 \pm 30%	3.0	2.8
SLF0755T-100M-N	10	20	100	0.0391 \pm 20%	2.6	2.5
SLF0755T-150M-N	15	20	100	0.0508 \pm 20%	2.1	2.2
SLF0755T-220M-N	22	20	100	0.0643 \pm 20%	1.7	2.0
SLF0755T-470M-N	47	20	100	0.1550 \pm 20%	0.8	1.0

- Tolerance: T = \pm 30% , M = \pm 20% ,
- Isat: Value obtained when DC current flows and the initial value of inductance has fallen by 10%
- Itemp current : Value obtained when current flows and the temperature has risen to 30°C
- Test equipment Inductance: HP4284A LF impedance analyzer or equivalent (Test frequency: 100KHz/1V)
- RDC: CH502BC

Electrical Characteristics

Part Number	Inductance (μ H)	Tolerance (\pm %)	Test Frequency (KHz)	DC Resistance (Ω \pm 20%)	Isat (A)	Itemp (A) Max
SLF1045T-100M-N	10	20	1	0.0364	3	2.5
SLF1045T-150M-N	15	20	1	0.0472	2.4	2.2
SLF1045T-220M-N	22	20	1	0.0591	2.1	1.9
SLF1045T-330M-N	33	20	1	0.0815	1.6	1.7
SLF1045T-470M-N	47	20	1	0.1	1.4	1.5
SLF1045T-680M-N	68	20	1	0.14	1.2	1.3
SLF1045T-101M-N	100	20	1	0.2	1	1.1
SLF1045T-151M-N	150	20	1	0.35	0.79	0.81
SLF1045T-221M-N	220	20	1	0.47	0.65	0.7
SLF1045T-331M-N	330	20	1	0.68	0.54	0.58
SLF1045T-471M-N	470	20	1	1.03	0.47	0.47
SLF1045T-681M-N	680	20	1	1.6	0.38	0.38
SLF1045T-102M-N	1000	20	1	2.8	0.32	0.29
SLF1045T-152M-N	1500	20	1	3.4	0.22	0.26

- Tolerance: M = \pm 20%
- Isat: Value obtained when DC current flows and the initial value of inductance has fallen by 10%
- Itemp current: Value obtained when current flows and the temperature has risen to 30°C
- Test equipment Inductance: HP4284A LF impedance analyzer or equivalent (Test frequency:1KHz/0.5V)
- RDC: CH502BC

Electrical Characteristics

Part Number	Inductance (μ H)	Tolerance (\pm %)	Test Frequency (KHz)	DC Resistance (m Ω) Max	Isat (A)
SLF1055T-100M-N	10	20	1	40	3.5
SLF1055T-330M-N	33	20	1	85	2.1

- Tolerance: M = \pm 20%
- Isat: Value obtained when DC current flows and the initial value of inductance has fallen by 15%
- Test equipment Inductance: HP4284A LF impedance analyzer or equivalent (Test frequency:1KHz/0.5V)
- RDC:CH502BC digital

Electrical Characteristics

Part Number	Inductance (μ H)	Tolerance (\pm %)	Test Frequency (KHz)	DC Resistance (Ω \pm 20%)	Isat (A)	Itemp (A) Max
SLF1255T-6R0M-N	6	20	1	0.0164	3.6	4.9
SLF1255T-100M-N	10	20	1	0.0215	3.4	4.3
SLF1255T-150M-N	15	20	1	0.0259	2.8	3.9
SLF1255T-220M-N	22	20	1	0.0338	2.3	3.4
SLF1255T-330M-N	33	20	1	0.0415	1.9	3.1
SLF1255T-470M-N	47	20	1	0.0618	1.6	2.5
SLF1255T-680M-N	68	20	1	0.0832	1.3	2.2
SLF1255T-101M-N	100	20	1	0.117	1.1	1.8
SLF1255T-151M-N	150	20	1	0.19	0.88	1.4
SLF1255T-221M-N	220	20	1	0.27	0.72	1.2
SLF1255T-331M-N	330	20	1	0.41	0.59	1
SLF1255T-471M-N	470	20	1	0.52	0.49	0.88
SLF1255T-681M-N	680	20	1	0.76	0.43	0.73
SLF1255T-102M-N	1000	20	1	1.12	0.34	0.6
SLF1255T-152M-N	1500	20	1	1.73	0.29	0.48

- Tolerance: M = \pm 20%
- Isat: Value obtained when DC current flows and the initial value of inductance has fallen by 10%
- Itemp current: Value obtained when current flows and the temperature has risen to 30°C
- Test equipment Inductance: HP4284A LF impedance analyzer or equivalent (Test frequency: 1KHz/0.5V)
- RDC:CH502BC

Electrical Characteristics

Part Number	Inductance (μ H)	Tolerance (\pm %)	Test Frequency (KHz)	DC Resistance (Ω \pm 20%)	Isat (A)	Itemp (A) Max
SLF1265T-2R0T-N	2	30	1	0.0117	10	6.2
SLF1265T-4R2T-N	4.2	30	1	0.015	7.3	5.5
SLF1265T-7R0T-N	7	30	1	0.0177	5.7	5
SLF1265T-100M-N	10	20	1	0.0202	5	4.8
SLF1265T-150M-N	15	20	1	0.0237	4.2	4.4
SLF1265T-220M-N	22	20	1	0.0316	3.5	3.8
SLF1265T-330M-N	33	20	1	0.0406	2.8	3.4
SLF1265T-470M-N	47	20	1	0.0578	2.4	2.8
SLF1265T-680M-N	68	20	1	0.0787	2	2.4
SLF1265T-101M-N	100	20	1	0.123	1.6	1.9
SLF1265T-221M-N	220	20	1	0.273	1	1.2

- Tolerance: M = \pm 20%
- Isat: Value obtained when DC current flows and the initial value of inductance has fallen by 10%
- Itemp current: Value obtained when current flows and the temperature has risen to 40°C
- Test equipment Inductance: HP4284A LF impedance analyzer or equivalent (Test frequency: 1KHz/0.5V)
- RDC:CH502BC

Electrical Characteristics

Part Number	Inductance (μ H)	Tolerance (\pm %)	Test Frequency (KHz)	DC Resistance ($\Omega \pm 20\%$)	Isat (A)	Itemp (A) Max
SLF1275T-1R2T-N	1.2	30	1	0.0069	13	8.2
SLF1275T-2R7T-N	2.7	30	1	0.0094	10	7
SLF1275T-3R9T-N	3.9	30	1	0.0104	9	6.7
SLF1275T-5R6T-N	5.6	30	1	0.0116	7.8	6.3
SLF1275T-6R8T-N	6.8	30	1	0.0131	7.2	5.9
SLF1275T-100M-N	10	20	1	0.0156	5.5	5.4
SLF1275T-150M-N	15	20	1	0.0184	4.7	5
SLF1275T-220M-N	22	20	1	0.0263	4	4
SLF1275T-330M-N	33	20	1	0.0395	3.2	3.4
SLF1275T-470M-N	47	20	1	0.0528	2.7	3
SLF1275T-680M-N	68	20	1	0.0778	2	2.4
SLF1275T-101M-N	100	20	1	0.1250	1.9	1.9
SLF1275T-151M-N	150	20	1	0.1750	1.5	1.6
SLF1275T-221M-N	220	20	1	0.2580	1.3	1.3

- Tolerance: M = $\pm 20\%$
- Isat: Value obtained when DC current flows and the initial value of inductance has fallen by 10%
- Itemp current: Value obtained when current flows and the temperature has risen to 40°C
- Test equipment Inductance: HP4284A LF impedance analyzer or equivalent (Test frequency:1KHz/0.5V)
- RDC:CH502BC

Packaging Specifications

Tape Dimensions

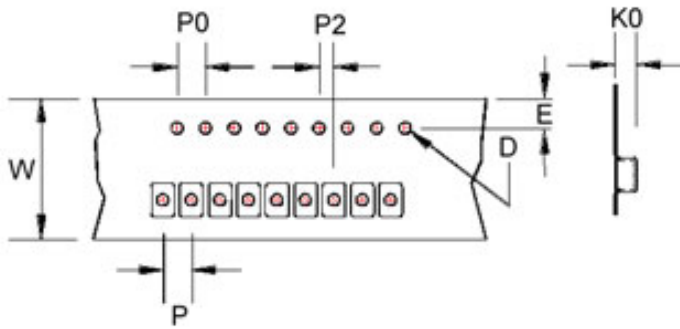

Tape Material

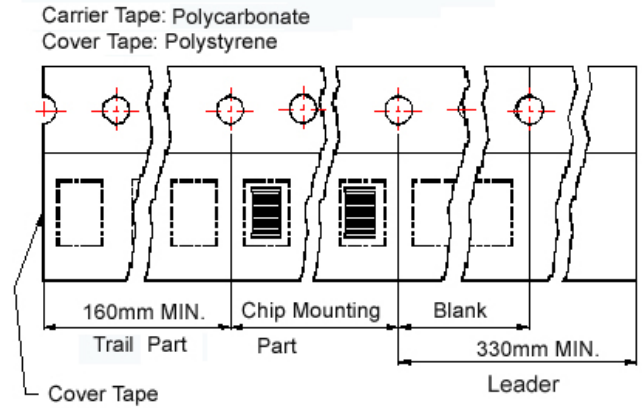

Reel Dimensions

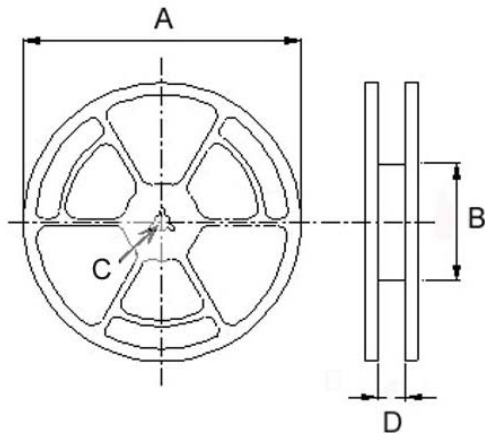

Dimensions in mm

TYPE	Tape Dimensions							Reel Dimensions				Quantity PCS / REEL
	K0	D	E	W	P	P0	P2	A	B	C	D	
SLF 0628	3.4	1.55	1.75	16	12	4	2	330	100	13	17.4	1000
SLF 0728	3.2	1.55	1.75	16	12	4	2	330	100	13	17.4	1000
SLF 0730	3.5	1.55	1.75	16	12	4	2	330	100	13	17.4	1000
SLF 0732	3.5	1.55	1.75	16	12	4	2	330	100	13	17.4	1000
SLF 0745	4.8	1.55	1.75	16	12	4	2	330	100	13	17.4	1000
SLF 0755	5.7	1.55	1.75	16	12	4	2	330	100	13	17.4	900
SLF 1045	5.0	1.55	1.75	24	16	4	2	330	100	13	24.4	500
SLF 1055	5.0	1.55	1.75	24	16	4	2	330	100	13	24.4	500
SLF 1255	6.0	1.55	1.75	24	16	4	2	330	100	13	24.4	500
SLF 1265	7.0	1.55	1.75	24	16	4	2	330	100	13	24.4	500
SLF 1275	8.2	1.55	1.75	24	16	4	2	330	100	13	24.4	350

SDT Series



Features

- RoHS compliant
- High inductance shielded power inductors
- Functions equally well in filter and smoothing circuit applications

Product Identification

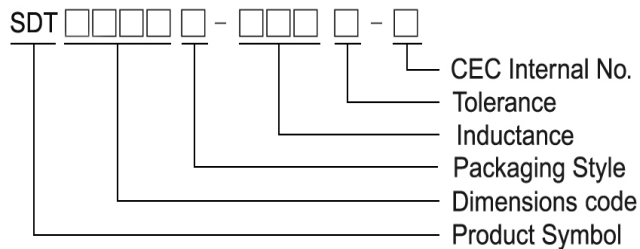

SDT Series is the ultimate cost effective and miniature power inductors. They are constructed of materials specially developed for surface mount applications to ensure the best possible reliability and ease of using and handling. Because of their “swinging” inductance vs. current characteristics, the SSL0402 Series supports used as ultra high inductance at zero or low current.

Applications

- Board mounted DC-DC converters
- Miniature power supplies and voltage multiplying circuits

Shape and Dimensions

SDT 0402

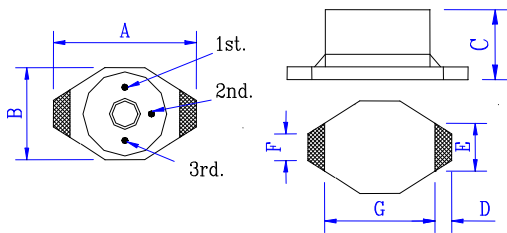

Dimensions in mm

A	B	C	D	E	F	G
6.60 ⁺⁰	4.54 ⁺⁰	2.92 ⁺⁰	1.02	3.05	1.27	4.32

SDT 0804

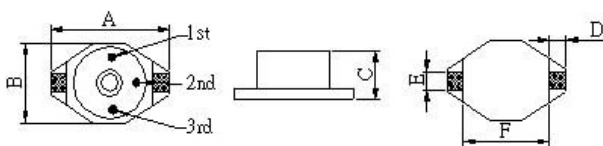

Dimensions in mm

A	B	C	D	E	F
12.95 ⁺⁰	9.4 ⁺⁰	5.08 ⁺⁰	2.54	2.54	7.62

Recommended Pattern

- Packaging: T : Tape and Reel

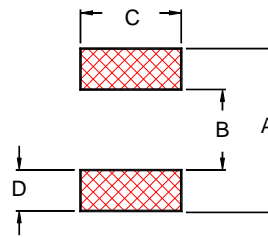

Dimensions in mm

A	B	C	D
6.86	4.06	3.56	1.40

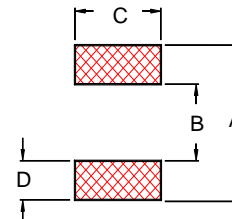

Dimensions in mm

A	B	C	D
13.21	7.37	2.79	2.92

Electrical Characteristics

Specifications				Operating Parameters				
Part Number	Inductance (μH)	Tolerance (±%)	DC Resistance (Ω) Max	Self Resonant Frequency (MHz) Typ.	Inductance Rating (μH)	Current Rating (A)	Energy Storage (μ Joules) Max	Switching Frequency Max
SDT0402T-1R0M-N	1.0	20	0.045	157	0.60	2.0	1.8	1 MHz
SDT0402T-1R5M-N	1.5	20	0.050	108	0.80	1.9	1.8	1 MHz
SDT0402T-2R2M-N	2.2	20	0.060	92	0.90	1.5	1.8	1 MHz
SDT0402T-3R3M-N	3.3	20	0.070	69	1.5	1.2	1.4	1 MHz
SDT0402T-4R7M-N	4.7	20	0.080	59	2.0	1.2	1.6	1 MHz
SDT0402T-6R8M-N	6.8	20	0.085	51	3.0	1.0	1.9	1 MHz
SDT0402T-100M-N	10	20	0.095	33	5.0	0.7	1.2	1 MHz
SDT0402T-150M-N	15	20	0.135	26	6.0	0.6	1.1	1 MHz
SDT0402T-220M-N	22	20	0.160	20	10	0.5	1.2	1 MHz
SDT0402T-330M-N	33	20	0.275	17	12	0.45	1.5	1 MHz
SDT0402T-470M-N	47	20	0.340	12	20	0.34	1.3	1 MHz
SDT0402T-680M-N	68	20	0.575	11	30	0.29	1.4	1 MHz
SDT0402T-101M-N	100	20	1.100	9.4	40	0.24	1.5	1 MHz
SDT0402T-151M-N	150	20	1.400	6.7	60	0.20	1.4	500 KHz
SDT0402T-221M-N	220	20	2.250	6.1	90	0.17	1.6	500 KHz
SDT0402T-331M-N	330	20	2.900	4.7	100	0.16	1.4	500 KHz
SDT0402T-471M-N	470	20	3.600	3.85	150	0.14	1.5	500 KHz
SDT0402T-681M-N	680	20	4.550	3.1	200	0.12	1.4	500 KHz
SDT0402T-102M-N	1000	20	8.100	2.3	400	0.08	1.4	500 KHz

- Inductance tested at 100 KHz.
- Measured at the rated current. Refer to curves below for more detail.
- Average maximum allowable current. SDT Series inductors are designed for current spikes as high as 2X the current rating
- Tolerance: M = ±20%
- Operating temperature range - 40 °C ~ 125 °C (Including self - temperature rise)

Typical Inductance Energy Storage VS. Current

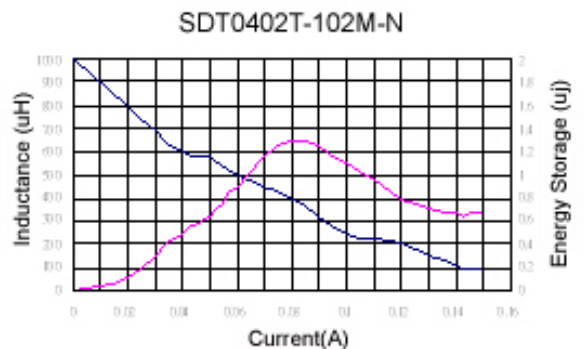
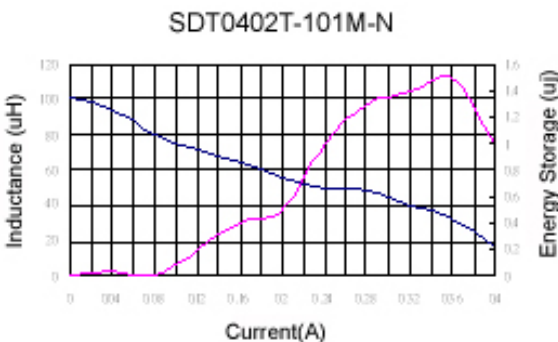
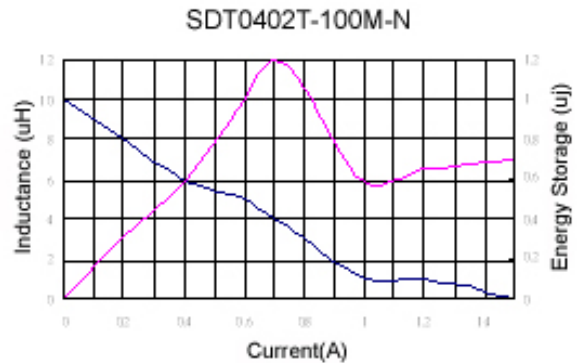
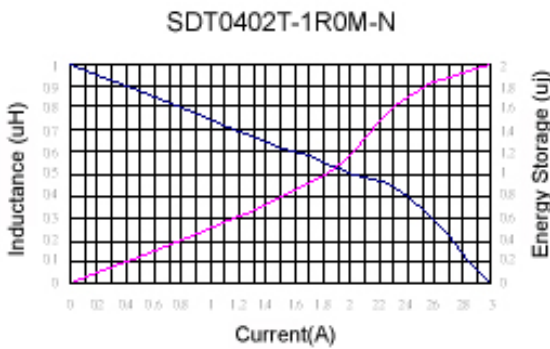

Electrical Characteristics

Specifications				Operating Parameters				
Part Number	Inductance (μH)	Tolerance (±%)	DC Resistance (Ω) Max	Self Resonant Frequency (MHz) Typ.	Inductance Rating (μH)	Current Rating (A)	Energy Storage (μ Joules) Max	Switching Frequency Max
SDT0804T-1R0M-N	1.0	20	0.025	60	0.50	5.0	9	1 MHz
SDT0804T-1R5M-N	1.5	20	0.030	55	0.70	5.0	12	1 MHz
SDT0804T-2R2M-N	2.2	20	0.035	55	1.00	5.0	15	1 MHz
SDT0804T-3R3M-N	3.3	20	0.040	50	1.50	5.0	16	1 MHz
SDT0804T-4R7M-N	4.7	20	0.045	45	2.00	3.0	10	1 MHz
SDT0804T-6R8M-N	6.8	20	0.050	40	4.00	2.5	14	1 MHz
SDT0804T-100M-N	10	20	0.055	35	5.00	2.0	11	1 MHz
SDT0804T-150M-N	15	20	0.060	25	6.00	1.8	12	1 MHz
SDT0804T-220M-N	22	20	0.084	22	10	1.5	11	1 MHz
SDT0804T-330M-N	33	20	0.090	18	12	1.3	13	1 MHz
SDT0804T-470M-N	47	20	0.11	16	27	1.0	13	1 MHz
SDT0804T-680M-N	68	20	0.15	12	40	0.90	17	1 MHz
SDT0804T-101M-N	100	20	0.29	9	50	0.80	15	1 MHz
SDT0804T-151M-N	150	20	0.36	8	80	0.60	15	500 KHz
SDT0804T-221M-N	220	20	0.39	6	90	0.50	10	500 KHz
SDT0804T-331M-N	330	20	0.73	5	150	0.40	13	500 KHz
SDT0804T-471M-N	470	20	0.88	4	200	0.35	13	500 KHz
SDT0804T-681M-N	680	20	1.15	3	300	0.30	13	500 KHz
SDT0804T-102M-N	1000	20	1.45	2.5	420	0.25	13	500 KHz

- Inductance tested at 100 KHz.
- Measured at the rated current. Refer to curves below for more detail.
- Average maximum allowable current. SDT Series inductors are designed for current spikes as high as 2X the current rating
- Tolerance: M = ±20%
- Operating temperature range - 40 °C ~ 125 °C (Including self - temperature rise)

Typical Inductance Energy Storage VS. Current

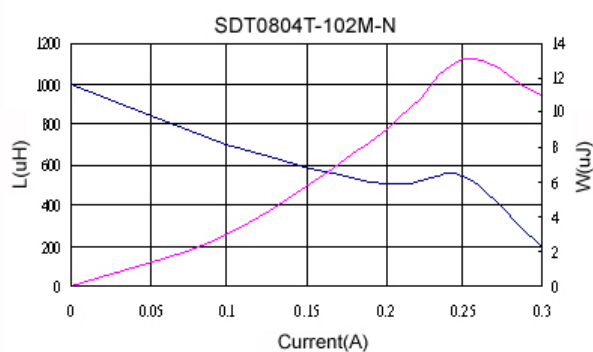
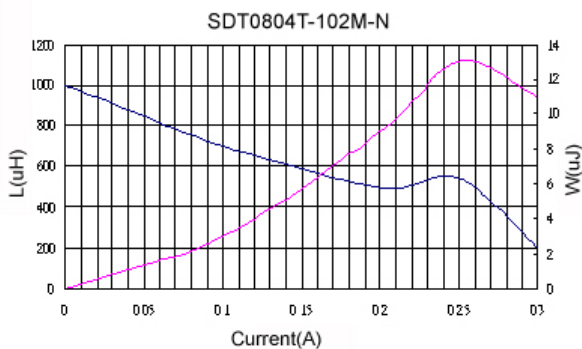
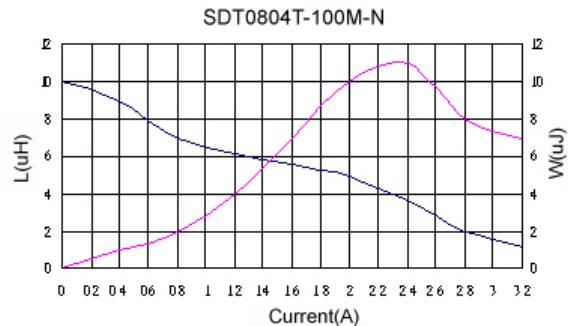
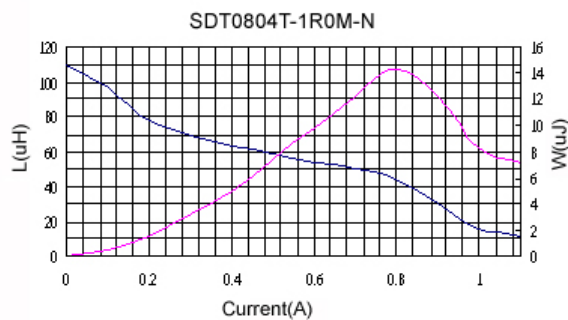

Packaging Specifications

Tape Dimensions

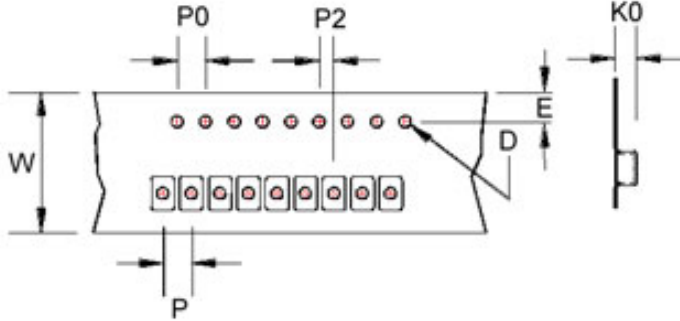

Tape Material

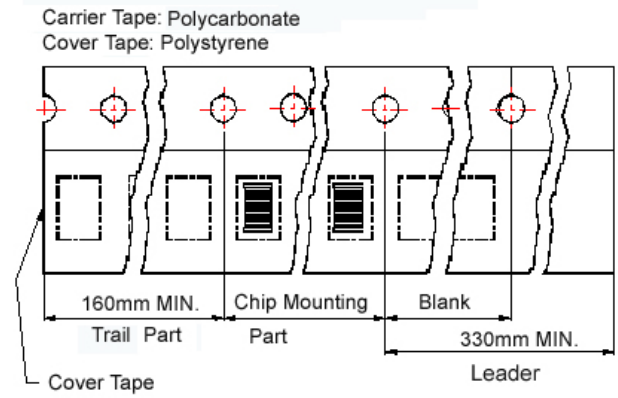

Reel Dimensions

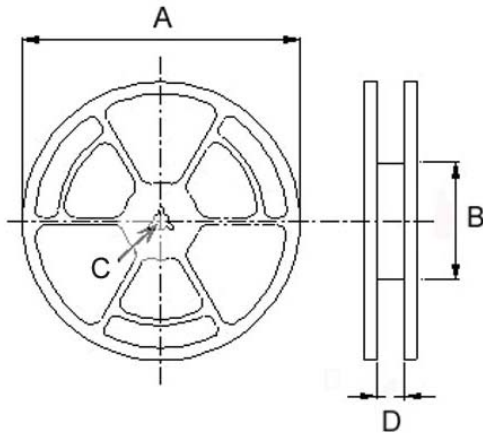

Dimensions in mm

TYPE	Tape Dimensions							Reel Dimensions				Quantity (PCS / REEL)	
	K0	D	E	W	P	P0	P2	A	B	C	D	178mm	330mm
SDT 0402	3.2	1.55	1.75	12	8	4	2	330	100	13	13.4	-	2500
								178	60	13	13.2	750	-
SDT 0804	5.4	1.55	1.75	24	16	4	2	330	100	13	24.4	-	750

SCD Series



Various high power surface mountable type inductors provide superior high saturation. The magnetic shielding also protects against radiation.

Features

- RoHS compliant
- High saturation open type wire wound power inductor
- Suitable for large currents
- Ideal for DC – DC converter applications
- Available on tape and reel for auto surface mounting

Applications

- Power supply for VTRs
- OA equipment
- LCD televisions
- Notebook PCs
- Portable communication devices
- DC / DC converters, etc

Product Identification

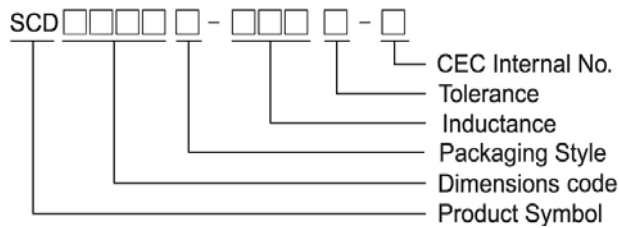

- Packaging: T : Tape and Reel

Shape and Dimensions

SCD 03011 ~ 1006

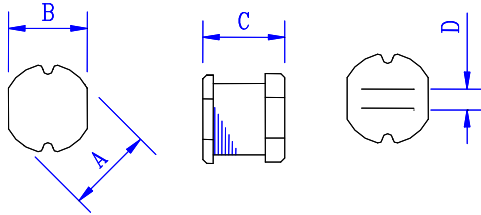

SCD 1307

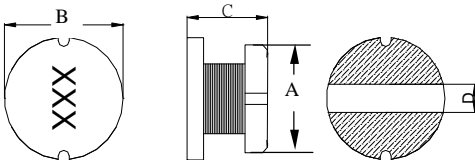

Dimensions in mm

TYPE	A	B	C	D
SCD 03011	3.5 ± 0.3	3.0 ± 0.3	1.1 ± 0.3	1.0 Typ.
SCD 03015	3.3 ± 0.3	3.0 ± 0.3	1.5 ± 0.3	1.0 Typ.
SCD 03021	3.3 ± 0.3	3.0 ± 0.3	2.1 ± 0.3	1.0 Typ.
SCD 0403	4.5 ± 0.3	4.0 ± 0.3	3.2 ± 0.3	1.2
SCD 0501	5.8 ± 0.3	5.2 ± 0.3	2.2 ⁺⁰	2.0 Typ.
SCD 0502	5.8 ± 0.3	5.2 ± 0.3	2.5 ± 0.3	2.0 Typ.
SCD 0503	5.8 ± 0.3	5.2 ± 0.3	3 ± 0.3	2.0 Typ.
SCD 0504	5.8 ± 0.3	5.2 ± 0.3	4.5 ± 0.4	1.3
SCD 0506	5.8 ± 0.3	5.2 ± 0.3	6.0 ± 0.4	1.3
SCD 0703	7.8 ± 0.3	7.0 ± 0.3	3.5 ± 0.3	2.1
SCD 0705	7.8 ± 0.3	7.0 ± 0.3	5.0 ± 0.3	2.1
SCD 0706	7.8 ± 0.3	7.0 ± 0.3	6.0 ± 0.3	2.1
SCD 1004	10.0 ± 0.3	9.0 ± 0.3	4.0 ± 0.5	2.1
SCD 1005	10.0 ± 0.4	9.0 ± 0.4	5.4 ± 0.4	2.1
SCD 1006	10.0 ± 0.4	9.0 ± 0.4	6.5 ± 0.4	2.1
SCD 1307	13.0 ± 0.5	13.0 ± 0.5	7.0 ± 0.3	5 Typ.

Recommended Pattern

SCD 1307

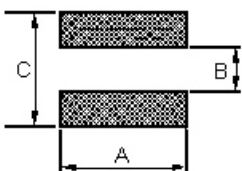

Dimensions in mm

Dim	A	B	C
1307	14	4.5	14

SCD03011-SCD1006

Dimensions in mm

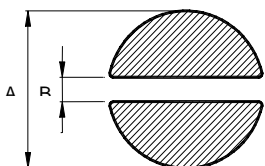

PAD LAYOUT

Dim	SCD 03011	SCD 03015	SCD 03021	SCD 0403	SCD 0501	SCD 0502	SCD 0503	SCD 0504	SCD 0506	SCD 0703	SCD 0705	SCD 0706	SCD 1004	SCD 1005	SCD 1006
A	4.5	4.5	4.5	5.5	6.8	6.8	6.8	6.8	6.8	8.8	8.8	8.8	11	11	11
B	1.5	1.0	1.0	1.2	2.0	2.0	2.0	1.3	1.3	2.1	2.1	2.1	2.1	2.1	2.1

Standard Specifications

Stamp	Inductance (μH)	RDC (Ω) Max														
		SCD 03011	SCD 03015	SCD 03021	SCD 0403	SCD 0501	SCD 0502	SCD 0503	SCD 0504	SCD 0506	SCD 0703	SCD 0705	SCD 0706	SCD 1004	SCD 1005	SCD 1006
R15	0.15				0.0085											
1R0	1.0	0.084		0.07	0.033	0.034	0.03	0.03								
1R2	1.2							0.03								
1R4	1.4			0.09	0.038	0.048	0.04						0.02			
1R5	1.5	0.126						0.03								
1R8	1.8			0.11	0.042	0.062	0.05	0.03					0.02			
2R2	2.2	0.18	0.10±30%	0.13	0.047	0.064	0.06	0.03								
2R7	2.7			0.14	0.052	0.078	0.07	0.04					0.02			
3R3	3.3	0.27		0.17	0.058	0.097	0.08	0.05								
3R9	3.9	0.32		0.19	0.076	0.105	0.09	0.06					0.03			
4R7	4.7	0.33	0.15±30%	0.21	0.094	0.134	0.14	0.07					0.04			0.040
5R6	5.6	0.48		0.22	0.101	0.170	0.15	0.08					0.04			
6R8	6.8	0.56		0.25	0.117	0.187	0.16	0.09					0.04			0.037
8R2	8.2	0.62		0.28	0.132	0.225	0.17	0.10					0.05			
100	10	0.90	0.30±30%	0.32	0.182	0.255	0.18	0.12	0.10			0.08	0.07		0.05	0.060
120	12	1.00		0.35	0.210	0.292	0.20	0.13	0.12			0.09	0.08		0.06	0.070
150	15	1.10	0.58±30%	0.40	0.235	0.360	0.22	0.15	0.14			0.10	0.09	0.08	0.07	0.080
180	18	1.24		0.48	0.338	0.430	0.25	0.22	0.15			0.11	0.10		0.08	0.090
220	22	1.40	0.71±30%	0.58	0.378	0.492	0.35	0.22	0.18	0.165		0.13	0.11		0.09	0.100
270	27	2.18		0.65	0.522	0.603	0.45	0.26	0.20			0.15	0.12		0.10	0.110
330	33	2.54	1.10±30%	0.80	0.540	0.796	0.56	0.33	0.23			0.17	0.13	0.14	0.12	0.120
390	39	2.80		0.90	0.587	0.897	0.69	0.42	0.32			0.22	0.16		0.15	0.140
470	47	3.10	1.30±30%	1.19	0.844	1.020	0.72	0.50	0.37			0.25	0.18		0.17	0.170
500	50	3.20		1.22		1.040										
560	56	3.50		1.27	0.937	1.164	0.84	0.55	0.42			0.28	0.24		0.20	0.190
680	68	5.80	2.20±30%	1.73	1.117	1.220	0.90	0.65	0.46			0.33	0.28		0.22	0.220
750	75	6.10		1.90		1.340										
820	82	6.60		1.99		1.570	1.20	0.80	0.60			0.41	0.37		0.30	0.25
101	100		3.50±30%	2.52	2.000	1.800	1.30	0.90	0.70			0.48	0.43		0.34	0.35
121	120			2.90	1.800	2.000	1.38	1.00	0.93			0.54	0.47		0.40	0.40
151	150			3.36	2.800	2.80	1.81	1.30	1.10			0.75	0.64		0.54	0.47
181	180			5.10	3.200	3.15	1.95	1.50	1.38			1.02	0.71		0.62	0.63
221	220			5.80	4.000	4.40	3.00	2.00	1.57			1.20	0.96		0.72	0.73
271	270			7.80		6.40	3.20	2.50	1.85			1.31	1.11		0.95	0.97
301	300					6.75										
331	330				5.850	7.20	3.82	3.20	2.00			1.50	1.26		1.10	1.15
391	390					8.40	4.68	3.50	2.60				1.77		1.24	1.30
461	460					12.0										
471	470					12.4	5.10	4.20	3.00				1.96		1.53	1.48
561	560					13.0	8.50	4.50	4.19						1.90	1.90
681	680							10.0	6.50	4.44						2.25
821	820							12.0	7.50	5.12						2.55
102	1000							18.0	8.00	10.00						
122	1200															
152	1500															
602	6000															14
822	8200															50

Test Freq.(L): SCD03011: (100KHz/1V) SCD03015: (1MHz/1V)
 SCD03021/0403/0501/0502/ 0503: 0.15 ~ 8.2μH(7.96MHz/1V), 10 ~ 82μH (2.52MHz/1V), 100 ~ 1000μH (1KHz/1V).
 SCD0504/0506/0703/0705/0706/1004: 1.0 ~ 8.2μH(7.96MHz/1V), 10 ~ 82μH (2.52MHz/1V), 100 ~ 1000μH (1KHz/1V).
 SCD1005/1006: 1.0 ~ 8.2μH(7.96MHz/1V), 10 ~ 82μH (2.52MHz/1V), 100 ~ 1000μH (1KHz/1V).

Test Instrument: L: Agilent/ E4980 or HP4284A (over 1MHz), HP4285A (under 1MHz)
 DCR: CH502BC ; Rated D.C. Current: HP4284+42841A or WK3260B+WK3265B

Standard Specifications

Stamp	Inductance (μH)	Isat (A) Max														
		SCD 03011	SCD 03015	SCD 03021	SCD 0403	SCD 0501	SCD 0502	SCD 0503	SCD 0504	SCD 0506	SCD 0703	SCD 0705	SCD 0706	SCD 1004	SCD 1005	SCD 1006
R15	0.15				7.5											
1R0	1.0	1.80		2.080	3.80	4.00	4.50	4.50								
1R2	1.2							4.20								
1R4	1.4			1.860	3.30	3.60	4.00					3.70				
1R5	1.5	1.44						4.10								
1R8	1.8			1.800	2.91	3.00	3.30	3.70				3.70				
2R2	2.2	1.26	0.79	1.390	2.60	2.65	2.94	3.50								
2R7	2.7			1.320	2.43	2.20	2.50	3.20				3.70				
3R3	3.3	1.08		1.250	2.15	2.11	2.35	2.80								
3R9	3.9	1.00		1.200	1.98	2.00	2.20	2.60				3.70				
4R7	4.7	0.90	0.65	1.130	1.70	1.80	2.00	2.50				3.50			2.60	
5R6	5.6	0.76		0.910	1.60	1.60	1.80	2.40				3.30				
6R8	6.8	0.68		0.850	1.41	1.50	1.70	2.20				3.10			4.33	
8R2	8.2	0.63		0.820	1.26	1.30	1.40	2.00				2.70				
100	10	0.56	0.45	0.740	1.15	1.10	1.20	1.80	1.44		1.44	2.30		2.38	2.60	
120	12	0.52		0.640	1.05	1.05	1.18	1.75	1.40		1.39	2.00		2.13	2.45	
150	15	0.50	0.30	0.600	0.92	1.00	1.15	1.70	1.30		1.24	1.80	2.8	1.87	2.27	
180	18	0.46		0.540	0.84	0.95	1.10	1.60	1.23		1.12	1.60		1.73	2.15	
220	22	0.36	0.25	0.500	0.76	0.90	1.00	1.50	1.11	1.6	1.07	1.50		1.60	1.95	
270	27	0.30		0.430	0.71	0.77	0.86	1.40	0.97		0.94	1.30		1.44	1.76	
330	33	0.28	0.20	0.400	0.64	0.68	0.76	1.10	0.88		0.85	1.20	2.3	1.26	1.50	
390	39	0.26		0.370	0.59	0.67	0.75	1.00	0.80		0.74	1.10		1.20	1.37	
470	47	0.25	0.17	0.360	0.54	0.66	0.73	0.90	0.72		0.68	1.10		1.10	1.28	
500	50	0.24		0.330		0.61										
560	56	0.23		0.310	0.50	0.50	0.55	0.85	0.68		0.64	0.94		1.01	1.17	
680	68	0.20	0.13	0.300	0.46	0.47	0.52	0.80	0.61		0.59	0.85		0.91	1.11	
750	75	0.18		0.290		0.46										
820	82	0.17		0.280		0.45	0.50	0.65	0.58		0.54	0.78		0.85	1.00	
101	100		0.10	0.250	0.40	0.36	0.40	0.60	0.52		0.51	0.72		0.74	0.97	
121	120			0.200	0.38	0.32	0.36	0.58	0.48		0.49	0.66		0.69	0.89	
151	150			0.190	0.30	0.270	0.30	0.43	0.40		0.40	0.58		0.61	0.78	
181	180			0.170	0.25	0.230	0.26	0.41	0.38		0.36	0.51		0.56	0.72	
221	220			0.160	0.15	0.220	0.25	0.38	0.35		0.31	0.49		0.53	0.66	
271	270			0.140		0.190	0.21	0.35	0.29		0.29	0.42		0.45	0.57	
301	300					0.180										
331	330				0.21	0.16	0.18	0.28	0.28		0.28	0.40		0.42	0.52	
391	390					0.150	0.16	0.26	0.26			0.36		0.38	0.48	
461	460					0.140										
471	470					0.135	0.15	0.20	0.12			0.34		0.35	0.42	
561	560					0.130	0.14	0.19	0.10					0.32	0.33	
681	680						0.13	0.18	0.08						0.28	
821	820						0.07	0.15	0.05						0.24	
102	1000						0.05	0.13	0.03							
122	1200															
152	1500															
602	6000															0.27
822	8200															0.20

Tolerance Of Inductors

- SCD03011 1.0 ~ 82μH ± 20%
- SCD03015 2.2 ~ 100μH ± 20%
- SCD03021 1.0 ~ 270μH ± 20%
- SCD0403 0.15 ~ 27μH ± 20% 33 ~ 100μH ± 10%
- SCD0501 1.0 ~ 27μH ± 20% 33 ~ 560μH ± 10%
- SCD0502 1.0 ~ 27μH ± 20% 33 ~ 1000μH ± 10%
- SCD0503 1.0 ~ 27μH ± 20% 33 ~ 1000μH ± 10%
- SCD0504 1.0~27μH±20% 33~47μH ±15% 56~1000μH±10%
- SCD0506 22μH ± 20%
- SCD0703 10 ~ 27μH ± 20% 33 ~ 330μH ±10%
- SCD0705 1.4 ~ 27μH ± 20% 33 ~ 470μH ±10%
- SCD0706 15μH ± 20% 33μH ±10%
- SCD1004 10 ~ 27μH ± 20% 33 ~ 560μH ±10%
- SCD1005 4.7 ~ 27μH ± 20% 33 ~ 820μH ±10%
- SCD1006 4.7 ~ 27uH ± 20% 33 ~820uH ± 10%
- SCD1006 6000μH ~8200μH±20%

Tolerance: K = ±10% , M = ±20%

※ This indicates the value of current when the inductance is 10% lower than its initial value at D.C superposition or D.C current when at Δt = 40° whichever is lower

Electrical Characteristics

Part Number	Inductance (μ H)	Tolerance (\pm %)	Q Ref	Q Frequency (MHz)	SRF (MHz) Typ.	DC Resistance (m Ω) Typ.	I _{rms} (A) Max	I _{sat} (A) Typ.
SCD1307T-1R5□-N	1.5	20	20	7.96 / 0.1V	65	5.0	9.50	20.0
SCD1307T-2R2□-N	2.2	20	22	7.96 / 0.1V	50	6.0	9.00	18.0
SCD1307T-2R7□-N	2.7	20	24	7.96 / 0.1V	40	8.0	8.20	16.0
SCD1307T-3R3□-N	3.3	20	26	7.96 / 0.1V	38	8.7	7.50	15.0
SCD1307T-4R7□-N	4.7	20	25	7.96 / 0.1V	36	10	7.00	13.0
SCD1307T-5R6□-N	5.6	20	24	7.96 / 0.1V	28	15	6.50	11.0
SCD1307T-6R8□-N	6.8	20	24	7.96 / 0.1V	26	17	6.00	10.5
SCD1307T-8R2□-N	8.2	20	24	7.96 / 0.1V	24	19	5.80	9.8
SCD1307T-100□-N	10	20	22	2.52 / 0.1V	22	21	5.60	9.2
SCD1307T-120□-N	12	20	25	2.52 / 0.1V	20	30	4.80	8.0
SCD1307T-150□-N	15	20	28	2.52 / 0.1V	17	34	4.50	7.5
SCD1307T-180□-N	18	20	28	2.52 / 0.1V	16	36	4.20	7.0
SCD1307T-220□-N	22	20	40	2.52 / 0.1V	15	47	3.60	6.5
SCD1307T-270□-N	27	20	35	2.52 / 0.1V	11	60	3.30	5.5
SCD1307T-330□-N	33	20 / 10	35	2.52 / 0.1V	10	65	3.10	5.0
SCD1307T-390□-N	39	20 / 10	28	2.52 / 0.1V	9.0	75	2.90	4.6
SCD1307T-470□-N	47	20 / 10	24	2.52 / 0.1V	7.5	82	2.70	4.2
SCD1307T-560□-N	56	20 / 10	22	2.52 / 0.1V	7.2	95	2.50	3.8
SCD1307T-680□-N	68	20 / 10	24	2.52 / 0.1V	7.0	120	2.30	3.5
SCD1307T-820□-N	82	20 / 10	18	2.52 / 0.1V	6.0	140	2.10	3.2
SCD1307T-101□-N	100	20 / 10	25	0.796 / 0.1V	5.8	180	1.90	3.0
SCD1307T-121□-N	120	20 / 10	20	0.796 / 0.1V	5.5	210	1.80	2.8
SCD1307T-151□-N	150	20 / 10	20	0.796 / 0.1V	4.5	250	1.60	2.6
SCD1307T-181□-N	180	20 / 10	18	0.796 / 0.1V	4.0	280	1.50	2.3
SCD1307T-221□-N	220	20 / 10	15	0.796 / 0.1V	3.8	360	1.30	2.1
SCD1307T-271□-N	270	20 / 10	15	0.796 / 0.1V	3.5	410	1.20	1.8
SCD1307T-331□-N	330	20 / 10	15	0.796 / 0.1V	3.2	520	1.10	1.6
SCD1307T-391□-N	390	20 / 10	12	0.796 / 0.1V	2.5	600	1.00	1.5
SCD1307T-471□-N	470	20 / 10	12	0.796 / 0.1V	2.2	720	0.90	1.4
SCD1307T-561□-N	560	20 / 10	10	0.796 / 0.1V	2.0	880	0.85	1.3
SCD1307T-681□-N	680	20 / 10	10	0.796 / 0.1V	1.6	1000	0.80	1.2
SCD1307T-821□-N	820	20 / 10	10	0.796 / 0.1V	1.5	1300	0.75	1.1
SCD1307T-102□-N	1000	20 / 10	10	0.252 / 0.1V	1.4	1600	0.65	1.0

- When ordering, please specify tolerance and packaging codes.
- Inductance tested at 0.1 V_{rms}, 100KHz.
- Tolerance: K = \pm 10% , M = \pm 20%
- Inductance drop = 10%. Typ. at I_{sat}
- Δ T = 40°C rise typ. at I_{rms}
- Test Instrument: L / Q : Agilent/ E4980 or HP4284A (over 1MHz), HP4285A (under 1MHz)
SRF: HP4286A
RDC: CH502BC
I_{sat}: HP4284+42841A or WK3260B+WK3265B

SMD Unshielded Power Inductors - SCD Series

Test Instruments : HP4294A Impedance / Material Analyzer

SCD0403

INDUCTANCE vs. FREQUENCY CHARACTERISTICS

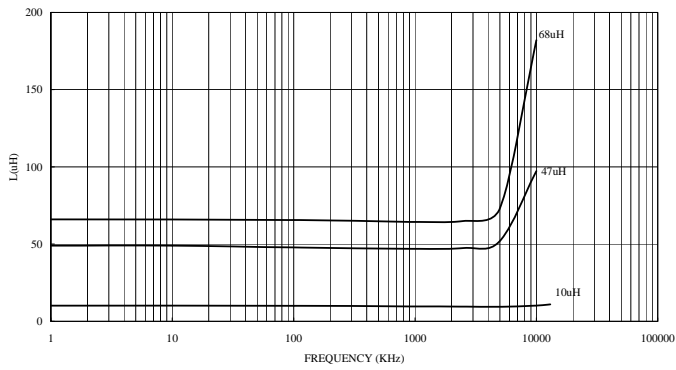

INDUCTANCE vs. IDC CHARACTERISTICS

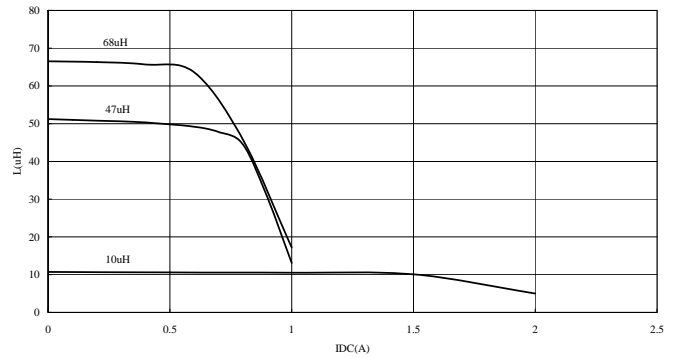

SCD0504

INDUCTANCE vs. FREQUENCY CHARACTERISTICS

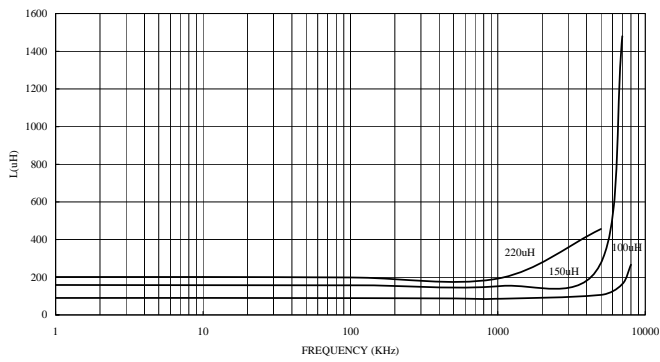

INDUCTANCE vs. IDC CHARACTERISTICS

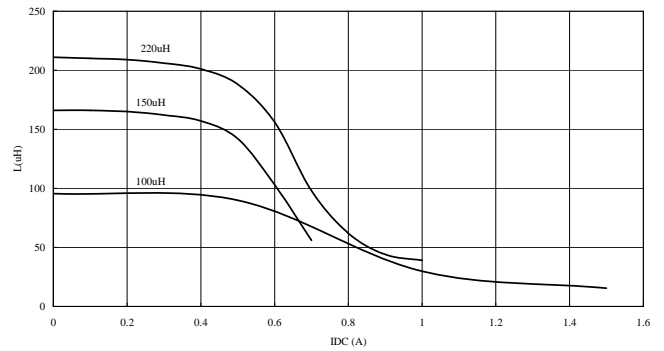

SCD0703

INDUCTANCE vs. FREQUENCY CHARACTERISTICS

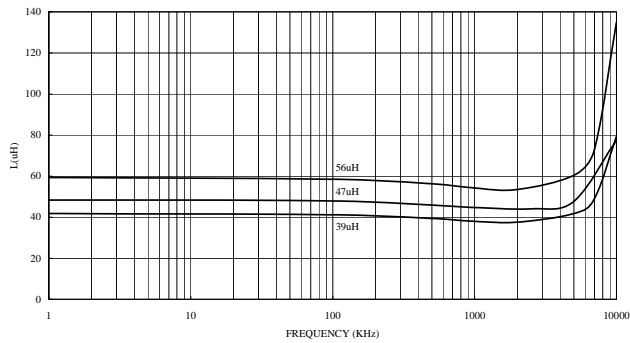

INDUCTANCE vs. IDC CHARACTERISTICS

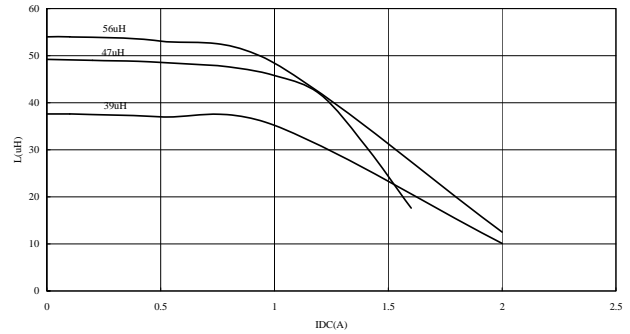

SMD Unshielded Power Inductors - SCD Series

Test Instruments : HP4294A Impedance / Material Analyzer

SCD0705

INDUCTANCE vs. FREQUENCY CHARACTERISTICS

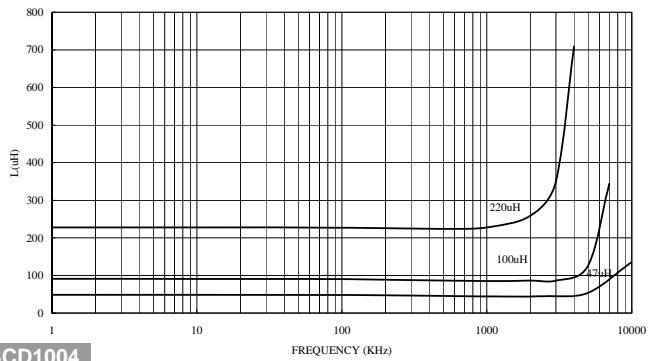

INDUCTANCE vs. IDC CHARACTERISTICS

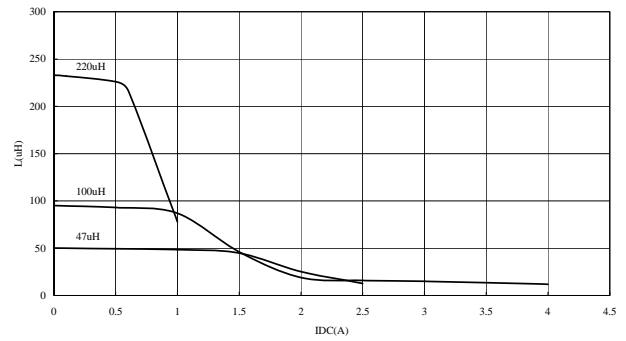

SCD1004

INDUCTANCE vs. FREQUENCY CHARACTERISTICS

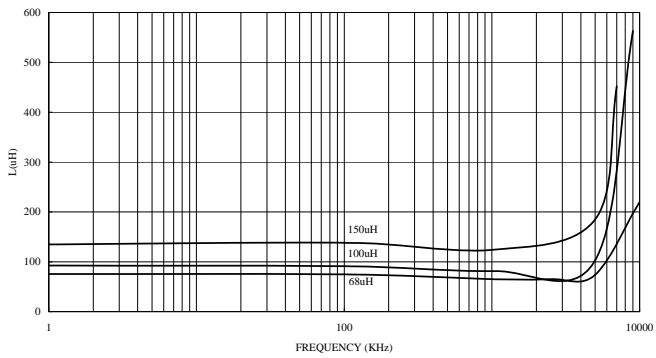

INDUCTANCE vs. IDC CHARACTERISTICS

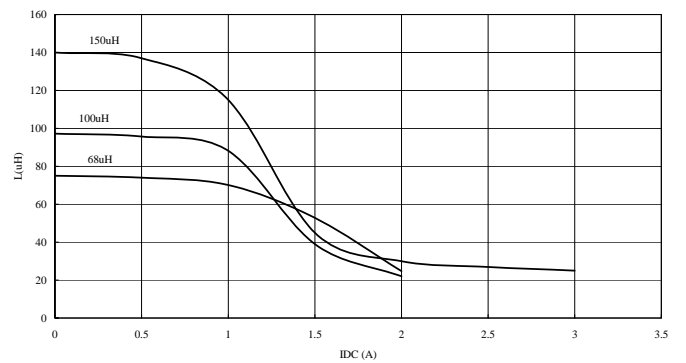

SCD1005

INDUCTANCE vs. FREQUENCY CHARACTERISTICS

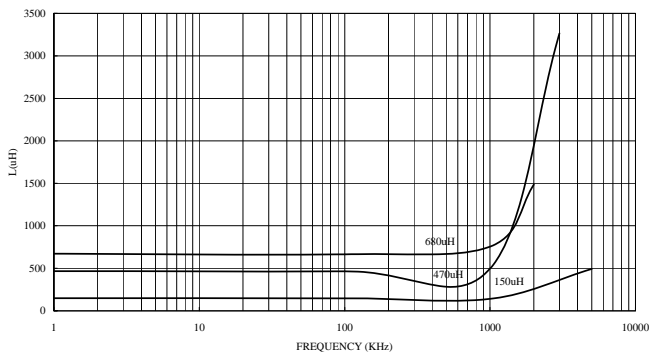

INDUCTANCE vs. IDC CHARACTERISTICS

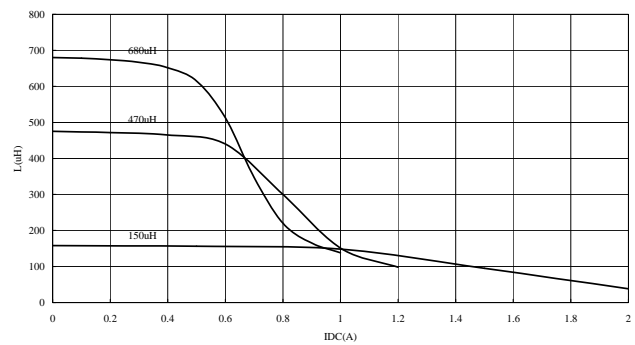

Packaging Specifications

Tape Dimensions

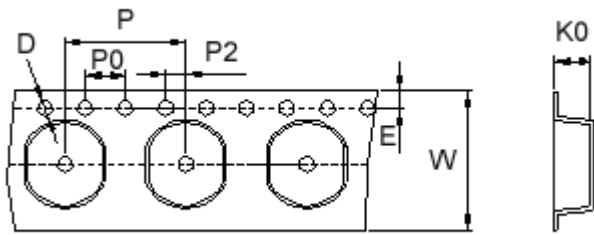

Tape Material

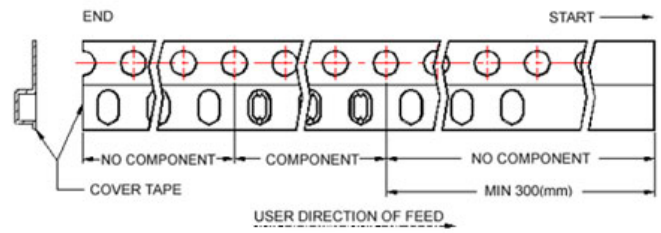

Reel Dimensions

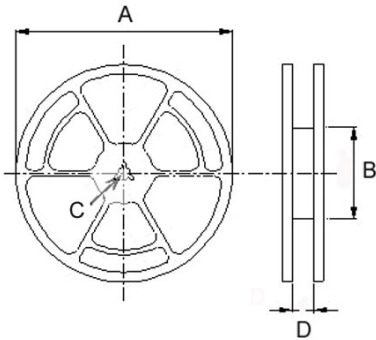

Dimensions in mm

TYPE	Tape Dimensions							Reel Dimensions				Quantity PCS / REEL
	K0	D	E	W	P	P0	P2	A	B	C	D	
SCD03011	1.4	1.50	1.75	12	8	4	2	330	100	13	13.4	3000
SCD03015	1.80	1.55	1.75	12	8	4	2	330	100	13	13.4	3000
SCD03021	2.50	1.55	1.75	12	8	4	2	330	100	13	13.4	3000
SCD0403	3.55	1.55	1.75	12	8	4	2	330	100	13	13.4	2000
SCD0501	2.35	1.55	1.75	12	8	4	2	330	100	13	13.4	2000
SCD0502	3.30	1.50	1.75	16	8	4	2	330	100	13	17.4	2000
SCD0503	3.30	1.50	1.75	16	8	4	2	330	100	13	17.4	2000
SCD0504	4.8	1.55	1.75	16	8	4	2	330	100	13	17.4	1500
SCD0506	6.4	1.55	1.75	16	8	4	2	330	100	13	17.4	1500
SCD0703	3.8	1.55	1.75	16	12	4	2	330	100	13	17.4	1000
SCD0705	5.2	1.55	1.75	16	12	4	2	330	100	13	17.4	700
SCD0706	6.4	1.55	1.75	16	12	4	2	330	100	13	17.4	700
SCD1004	4.5	1.55	1.75	24	12	4	2	330	100	13	24.4	700
SCD1005	5.8	1.55	1.75	24	12	4	2	330	100	13	24.4	700
SCD1006	7.0	1.55	1.75	24	12	4	2	330	100	13	24.4	500
SCD1307	7.4	1.55	1.75	24	16	4	2	330	100	13	24.4	500

SSL Series

Features

- RoHS compliant
- High energy storage and very low resistance
- Smallest size and high performance

Applications

- Notebook computers, step-up and step-down converters
- Flash, memory programmers. etc

Product Identification

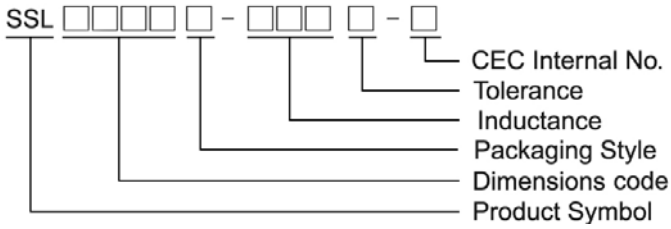

- Packaging: T : Tape and Reel , B : Bulk

Shape and Dimensions

Recommended Pattern

SSL0402

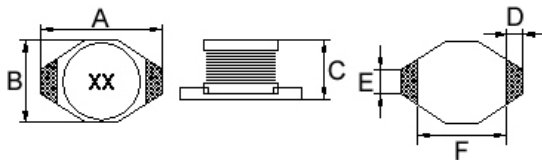

Dimensions in mm

A	B	C	D	E	F
6.60 ⁺⁰	4.45 ⁺⁰	2.92 ⁺⁰	1.02	1.27	4.32

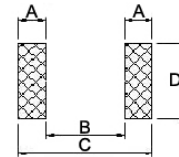

Dimensions in mm

TYPE	A	B	C	D
SSL0402	1.40	4.06	6.86	3.56

SSL 0614

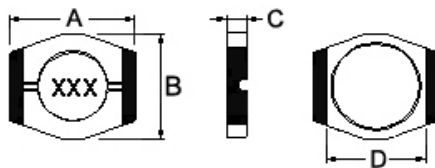

Dimensions in mm

A	B	C	D
9.14 ⁺⁰	7.87 ⁺⁰	1.65 ⁺⁰	7.24 ⁺⁰

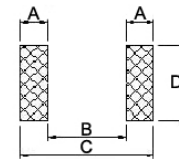

Dimensions in mm

A	B	C	D
1.21	7.24	9.66	5.84

Shape and Dimensions

SSL0802/ 0804/ 0810

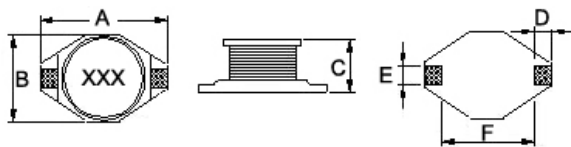

Dimensions in mm

TYPE	A	B	C	D	E	F
SSL0802	12.95 ⁺⁰	9.4 ⁺⁰	3.0 ⁺⁰	2.54	2.54	7.62
SSL0804	12.95 ⁺⁰	9.40 ⁺⁰	5.21 ⁺⁰	2.54	2.54	7.62
SSL0810	12.95 ⁺⁰	9.40 ⁺⁰	11.43 ⁺⁰	2.54	2.54	7.62

Recommended Pattern

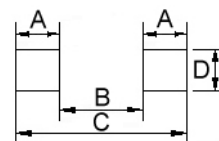

Dimension in mm

TYPE	A	B	C	D
SSL0802	2.92	7.37	13.21	2.79
SSL0804	2.92	7.37	13.21	2.79
SSL0810	2.92	7.37	13.21	2.79

SSL1306

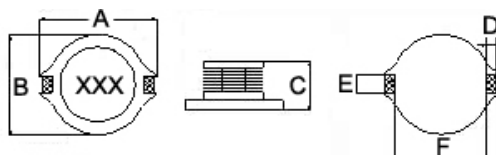

Dimensions in mm

A	B	C	D	E	F
18.54 ⁺⁰	15.24 ⁺⁰	7.11 ⁺⁰	2.54	2.54	12.7

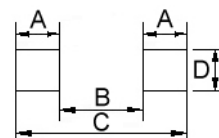

Dimension in mm

TYPE	A	B	C	D
SSL1306	2.92	12.45	18.29	2.79

Electrical Characteristics

Part Number	Inductance (μH)	Tolerance ($\pm\%$)	SRF (MHz) Typ	DC Resistance (Ω) Max	Isat (A)	Irms (A)
SSL0402T-1R0M-N	1.0	20	130	0.05	2.90	2.9
SSL0402T-1R5M-N	1.5	20	115	0.05	2.60	2.8
SSL0402T-2R2M-N	2.2	20	90	0.07	2.30	2.4
SSL0402T-3R3M-N	3.3	20	70	0.08	2.00	2.0
SSL0402T-4R7M-N	4.7	20	50	0.09	1.50	1.5
SSL0402T-6R8M-N	6.8	20	45	0.13	1.20	1.4
SSL0402T-100M-N	10	20	35	0.16	1.10	1.1
SSL0402T-150M-N	15	20	30	0.23	0.90	1.2
SSL0402T-220M-N	22	20	20	0.37	0.70	0.8
SSL0402T-330M-N	33	20	15	0.51	0.58	0.6
SSL0402T-470M-N	47	20	14	0.64	0.50	0.5
SSL0402T-680M-N	68	20	11	0.86	0.40	0.4
SSL0402T-101M-N	100	20	9	1.27	0.31	0.3
SSL0402T-151M-N	150	20	6	2.00	0.27	0.25
SSL0402T-221M-N	220	20	5.5	3.11	0.22	0.20
SSL0402T-331M-N	330	20	5	3.80	0.18	0.16
SSL0402T-471M-N	470	20	4	5.06	0.16	0.15
SSL0402T-681M-N	680	20	3	9.20	0.14	0.12
SSL0402T-102M-N	1000	20	2	13.8	0.10	0.07

- Inductance tested at 100 KHz, 0.1 Vrms.
- Inductance drop = 20% typ. at Isat.
- $\Delta T = 30^\circ\text{C}$ rise typ at I rms.
- Tolerance: M = $\pm 20\%$
- Operating temperature range $-40^\circ\text{C} \sim 125^\circ\text{C}$ (Including self - temperature rise)

Test Instruments :

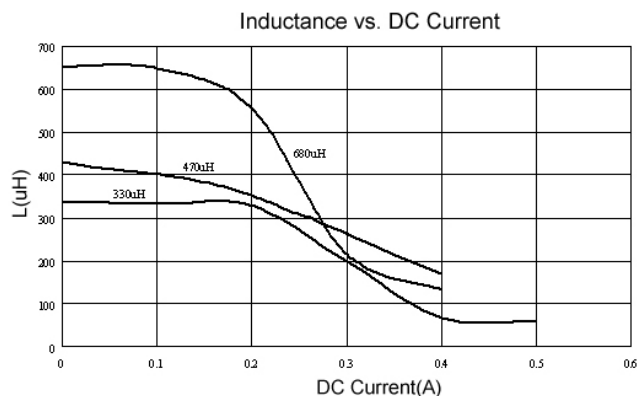
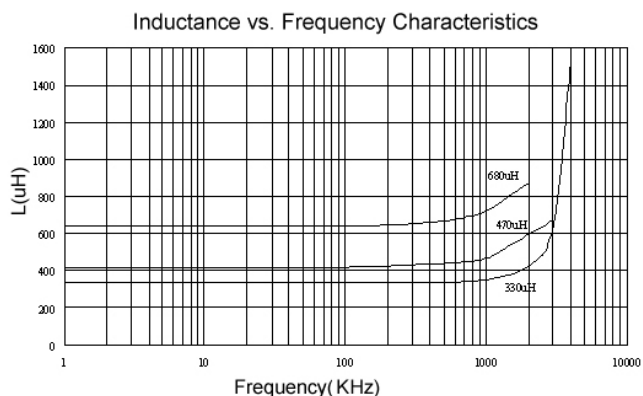

Electrical Characteristics

Part Number	Inductance (μ H)	Tolerance (\pm %)	D.C. Resistance (Ω) Max	Isat (A)
SSL0614T-4R7M-N	4.7	20	0.145	1.60
SSL0614T-6R8M-N	6.8	20	0.165	1.30
SSL0614T-100M-N	10	20	0.240	1.00
SSL0614T-150M-N	15	20	0.300	0.90
SSL0614T-220M-N	22	20	0.420	0.70
SSL0614T-330M-N	33	20	0.550	0.60
SSL0614T-470M-N	47	20	0.765	0.40
SSL0614T-680M-N	68	20	1.10	0.40
SSL0614T-101M-N	100	20	1.60	0.30
SSL0614T-151M-N	150	20	2.50	0.25
SSL0614T-221M-N	220	20	3.65	0.22
SSL0614T-331M-N	330	20	4.65	0.18
SSL0614T-471M-N	470	20	6.75	0.14
SSL0614T-681M-N	680	20	9.15	0.12
SSL0614T-102M-N	1000	20	14.2	0.10

- Inductance tested at 100 KHz, 0.1 Vrms.I
- Inductance drop = 10% typ. at Isat
- Tolerance: M = \pm 20%

Electrical Characteristics

Part Number	Inductance (μH)	Tolerance ($\pm\%$)	SRF (MHz) Typ.	DC Resistance (Ω) Max	Isat (A)	Irms (A)
SSL0802T-100M-N	10	20	35	0.09	2.4	2.0
SSL0802T-150M-N	15	20	33	0.12	2.0	1.5
SSL0802T-220M-N	22	20	25	0.19	1.6	1.3
SSL0802T-330M-N	33	20	19	0.25	1.4	1.1
SSL0802T-470M-N	47	20	14	0.32	1.0	0.8
SSL0802T-680M-N	68	20	12	0.55	0.9	0.7
SSL0802T-101M-N	100	20	10	0.70	0.7	0.6
SSL0802T-151M-N	150	20	8	1.00	0.6	0.5
SSL0802T-221M-N	220	20	6	1.60	0.5	0.4
SSL0802T-331M-N	330	20	5	2.20	0.4	0.3
SSL0802T-471M-N	470	20	4	3.30	0.3	0.2
SSL0802T-681M-N	680	20	3	4.40	0.2	0.1
SSL0802T-102M-N	1000	20	2.5	7.00	0.1	0.05

- Inductance tested at 100 KHz, 0.1 Vrms.
- Inductance drop = 20% typ. at Isat.
- $\Delta T = 30^\circ\text{C}$ rise typ. at I rms.
- Tolerance: M = $\pm 20\%$
- Operating temperature range $-40^\circ\text{C} \sim 125^\circ\text{C}$ (Including self - temperature rise)

Test Instruments :

Inductance vs. Frequency Characteristics

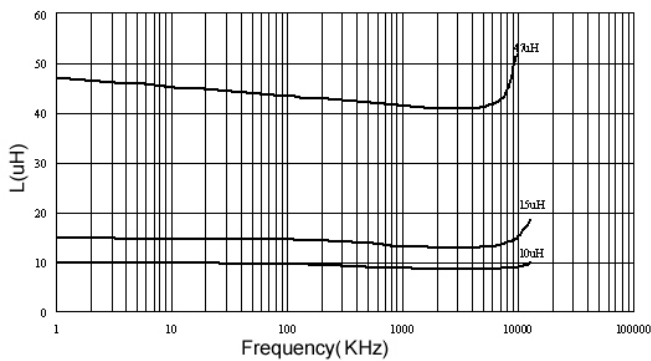

Inductance vs. DC Current

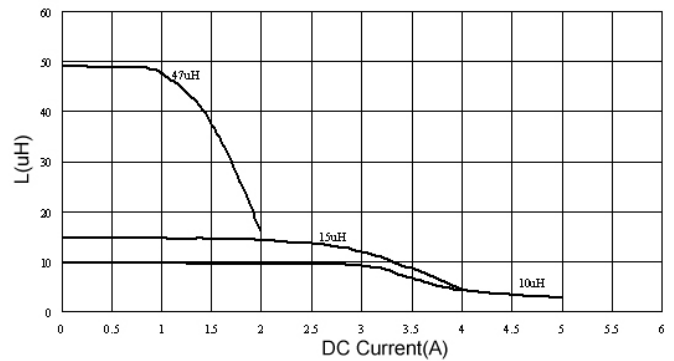

Electrical Characteristics

Part Number	Inductance (μH)	Tolerance ($\pm\%$)	SRF (MHz) Typ.	DC Resistance (Ω) Max	Isat (A)	Irms (A)
SSL0804T-1R0M-N	1.0	20	100	0.009	9.0	6.8
SSL0804T-1R5M-N	1.5	20	90	0.010	8.0	6.4
SSL0804T-2R2M-N	2.2	20	80	0.012	7.0	6.1
SSL0804T-3R3M-N	3.3	20	65	0.015	6.4	5.4
SSL0804T-4R7M-N	4.7	20	45	0.018	5.4	4.8
SSL0804T-6R8M-N	6.8	20	38	0.027	4.6	4.4
SSL0804T-100M-N	10	20	30	0.038	3.8	3.9
SSL0804T-150M-N	15	20	27	0.046	3.0	3.1
SSL0804T-220M-N	22	20	19	0.085	2.6	2.7
SSL0804T-330M-N	33	20	15	0.100	2.0	2.1
SSL0804T-470M-N	47	20	12	0.140	1.6	1.8
SSL0804T-680M-N	68	20	10	0.200	1.4	1.5
SSL0804T-101M-N	100	20	9	0.260	1.2	1.3
SSL0804T-151M-N	150	20	6	0.400	1.0	1.0
SSL0804T-221M-N	220	20	5	0.610	0.8	0.8
SSL0804T-331M-N	330	20	4.5	1.020	0.6	0.6
SSL0804T-471M-N	470	20	3.5	1.270	0.5	0.5
SSL0804T-681M-N	680	20	2.5	2.020	0.4	0.4
SSL0804T-102M-N	1000	20	2.0	3.000	0.3	0.3

- Inductance tested at 100 KHz, 0.1 Vrms.
- Inductance drop = 20% typ. at Isat.
- $\Delta T = 15^\circ\text{C}$ rise typ. at I rms.
- Tolerance: M = $\pm 20\%$
- Operating temperature range $-40^\circ\text{C} \sim 125^\circ\text{C}$ (Including self - temperature rise)

Test Instruments :

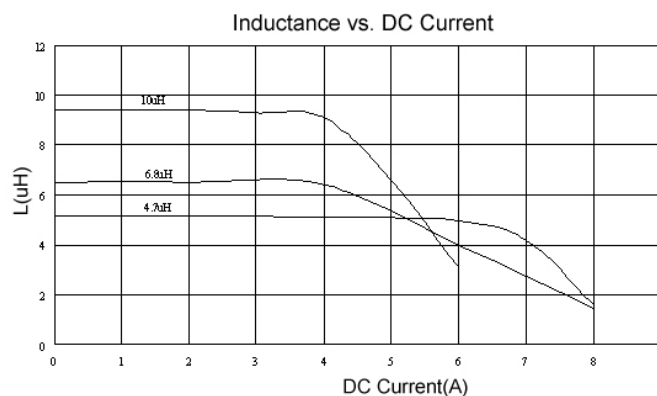
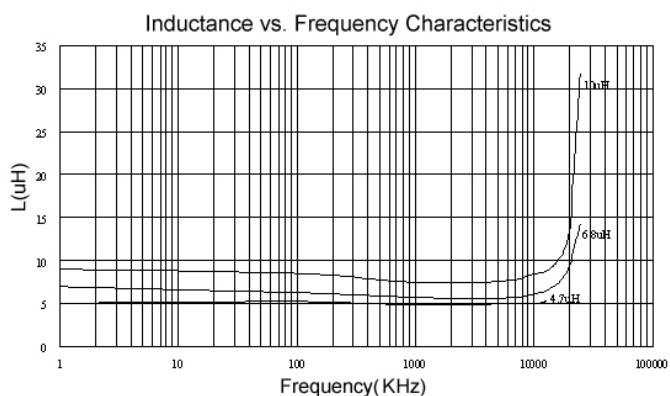

Electrical Characteristics

Part Number	Inductance (μH)	Tolerance ($\pm\%$)	DC Resistance (Ω) Max	SRF (MHz) Typ.	Isat (A)	Irms (A)
SSL0810T-100M-N	10	20	0.033	22	8.0	3.5
SSL0810T-150M-N	15	20	0.042	18	7.0	3.0
SSL0810T-220M-N	22	20	0.054	11	5.5	2.5
SSL0810T-330M-N	33	20	0.08	9	4.0	2.0
SSL0810T-470M-N	47	20	0.10	8	3.8	1.6
SSL0810T-680M-N	68	20	0.17	7	3.0	1.2
SSL0810T-101M-N	100	20	0.22	5	2.5	1.2
SSL0810T-151M-N	150	20	0.34	4	2.0	0.9
SSL0810T-221M-N	220	20	0.44	3.5	1.6	0.7
SSL0810T-331M-N	330	20	0.70	2.5	1.2	0.6
SSL0810T-471M-N	470	20	0.95	2	1.0	0.3
SSL0810T-681M-N	680	20	1.2	2	1.0	0.2
SSL0810T-102M-N	1000	20	2.0	1.5	0.8	0.1

- Inductance tested at 100 KHz, 0.1 Vrms.
- Inductance drop = 20% typ. at Isat.
- $\Delta T = 40^\circ\text{C}$ rise typ. at I rms.
- Tolerance: M = $\pm 20\%$
- Operating temperature range $-40^\circ\text{C} \sim 125^\circ\text{C}$ (Including self - temperature rise)

Test Instruments :

Inductance vs. Frequency Characteristics

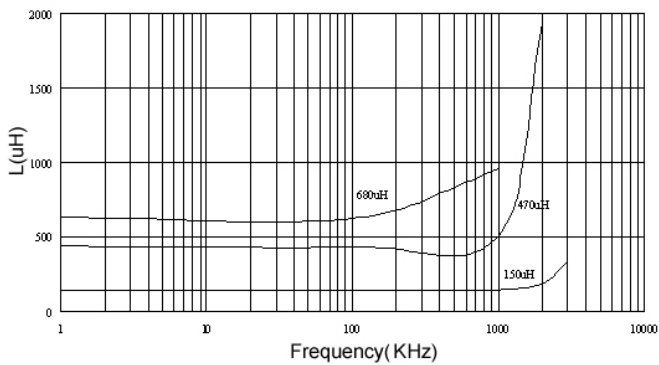

Inductance vs. DC Current

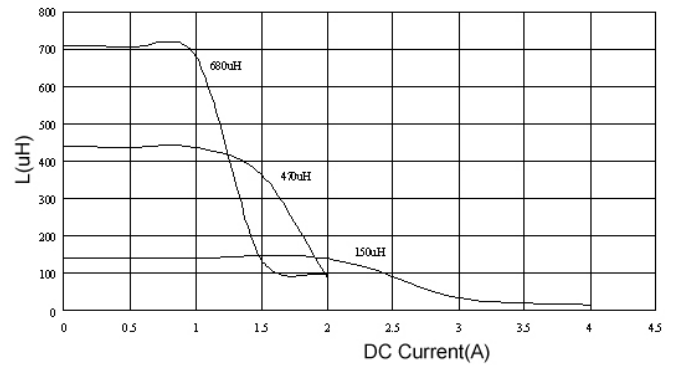

Electrical Characteristics

Part Number	Inductance (μH)	Tolerance ($\pm\%$)	SRF (MHz) Typ.	DC Resistance ($\Omega+15\%$)	Isat (A)	Irms (A)
SSL1306T-1R0M-N	1.0	20	80	0.011	20	8.6
SSL1306T-2R2M-N	2.2	20	80	0.014	16	7.1
SSL1306T-3R3M-N	3.3	20	60	0.016	14	6.2
SSL1306T-5R6M-N	5.6	20	40	0.022	12	5.3
SSL1306T-100M-N	10	20	30	0.032	10	4.3
SSL1306T-150M-N	15	20	22	0.036	8.0	4.0
SSL1306T-220M-N	22	20	20	0.047	7.0	3.5
SSL1306T-330M-N	33	20	15	0.066	5.5	3.0
SSL1306T-470M-N	47	20	9	0.087	4.5	2.6
SSL1306T-680M-N	68	20	8	0.13	3.5	2.3
SSL1306T-101M-N	100	20	7	0.19	3.0	1.8
SSL1306T-151M-N	150	20	6	0.25	2.6	1.5
SSL1306T-221M-N	220	20	5	0.38	2.4	1.2
SSL1306T-331M-N	330	20	4	0.56	1.9	1.0
SSL1306T-471M-N	470	20	3	0.85	1.4	0.82
SSL1306T-681M-N	680	20	2.5	1.2	1.2	0.72
SSL1306T-102M-N	1000	20	2	1.8	1.0	0.56

- Inductance tested at 100 KHz, 0.1 Vrms.
- Inductance drop = 20% typ. at Isat.
- $\Delta T = 40^\circ\text{C}$ rise typ. at I rms.
- Tolerance: M = $\pm 20\%$
- Operating temperature range $-40^\circ\text{C} \sim 125^\circ\text{C}$ (Including self - temperature rise)

Test Instruments :

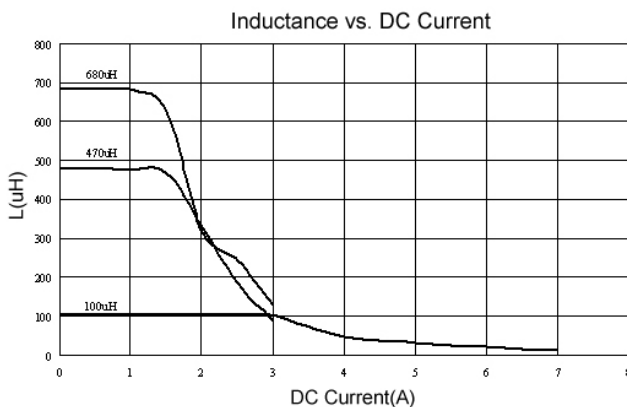
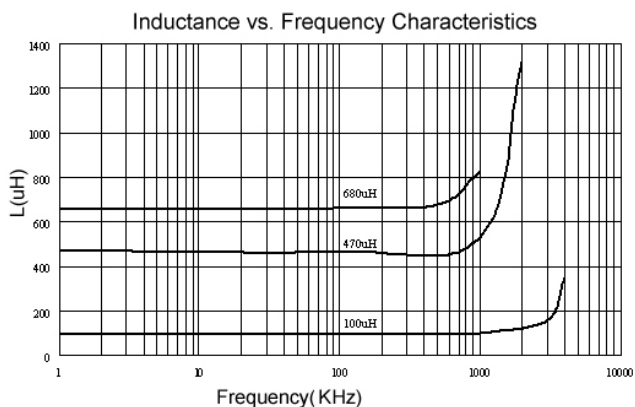

Packaging Specifications

Tape Dimensions

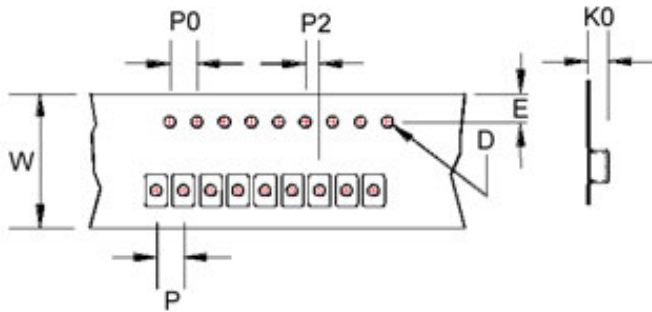

Tape Material

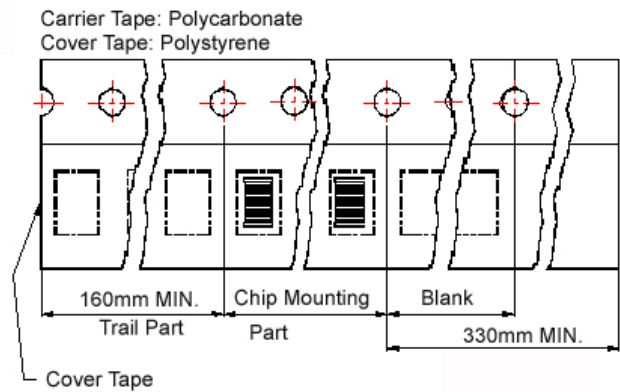

Reel Dimensions

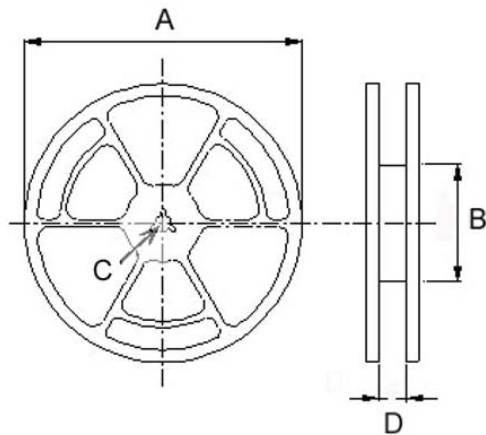

Dimensions in mm

TYPE	Tape Dimensions							Reel Dimensions				Quantity (PCS / REEL)	
	K0	D	E	W	P	P0	P2	A	B	C	D	178mm	330mm
SSL0402	3.2	1.55	1.75	12	8	4	2	330	100	13	13.4	-	2500
								178	60		13.2	750	-
SSL 0614	1.8	1.5	1.75	16	12	4	2	330	100	13	17.4	-	2500
SSL 0802	3.75	1.55	1.75	24	16	4	2	330	100	13	24.4	-	1000
SSL 0804	5.4	1.55	1.75	24	16	4	2	330	100	13	24.4	-	750
SSL 0810	11.5	1.55	1.75	24	20	4	2	330	100	13	24.4	-	225
SSL 1306	7.5	1.55	1.75	32	20	4	2	330	100	13	33.4	-	350

SSL-HC Series



This series is specially designed for high current, low voltage DC-DC converter applications. Its simple, rugged design provides current ratings normally available in larger packages. With tinned self-leaded construction, SSL-HC series can achieve very low DCR values and excellent solderability. In addition, they have very low resistance. Standard parts shown in catalogue and custom values are also available.

Features

- RoHS compliant
- For high current, low voltage DC-DC converter applications

Applications

- Notebook computers
- step-up and step-down converters
- memory programmers, etc

Product Identification

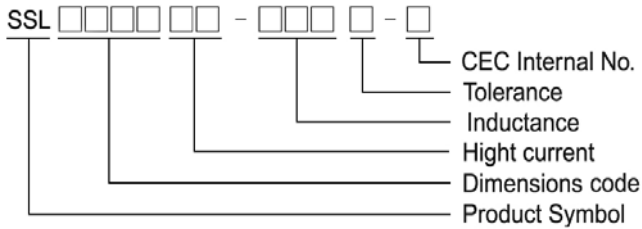

- Packaging: T : Tape and Reel , B : Bulk

Shape and Dimension

SSL0503HC

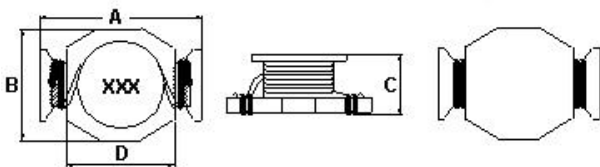

Dimension in mm

A	B	C	D
8.89 ⁺⁰	6.10 ⁺⁰	5.00 ⁺⁰	5.84

Recommended Pattern

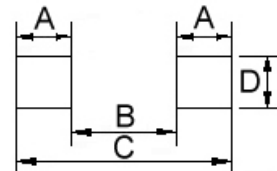

Dimension in mm

A	B	C	D
1.91	4.06	8.89	5.08

SSL0804HC

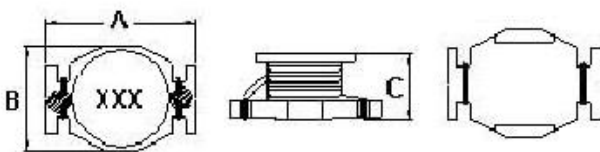

Dimension in mm

A	B	C
13.21 ⁺⁰	9.91 ⁺⁰	6.35 ⁺⁰

Dimension in mm

A	B	C	D
1.52	4.06	11.68	8.64

Electrical Characteristics

Part Number	Inductance (μH)	Tolerance (±%)	DC Resistance (Ω) Max	SRF (MHz) Typ.	Isat (A)	Irms (A)
SSL0503HC-R56M-N	0.56	20	0.010	200	7.7	6.0
SSL0503HC-1R2M-N	1.2	20	0.017	140	5.3	4.4
SSL0503HC-2R2M-N	2.2	20	0.035	100	3.5	3.1
SSL0503HC-4R7M-N	4.7	20	0.054	50	2.6	2.2
SSL0503HC-100M-N	10	20	0.111	40	1.9	1.5
SSL0503HC-150M-N	15	20	0.17	30	1.5	1.2
SSL0503HC-220M-N	22	20	0.25	25	1.2	1.0
SSL0503HC-330M-N	33	20	0.37	20	0.99	0.82
SSL0503HC-470M-N	47	20	0.47	15	0.87	0.72

- Inductance tested at 100 KHz, 0.25 Vrms.
- SRF measured using HP8753D network analyzer
- Inductance drop = 30% typ. at Isat.
- $\Delta T = 40^\circ$ typ. at I rms.
- Tolerance: M = $\pm 20\%$
- Operating temperature range – $40^\circ\text{C} \sim 125^\circ\text{C}$ (Including self - temperature rise)
- Electrical specifications at 25°C

Test Instruments :

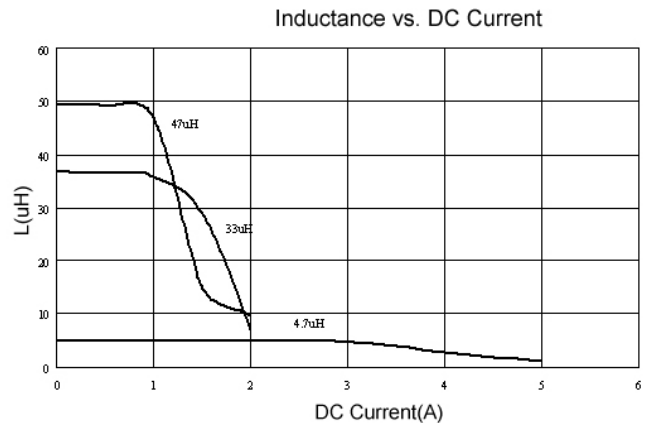
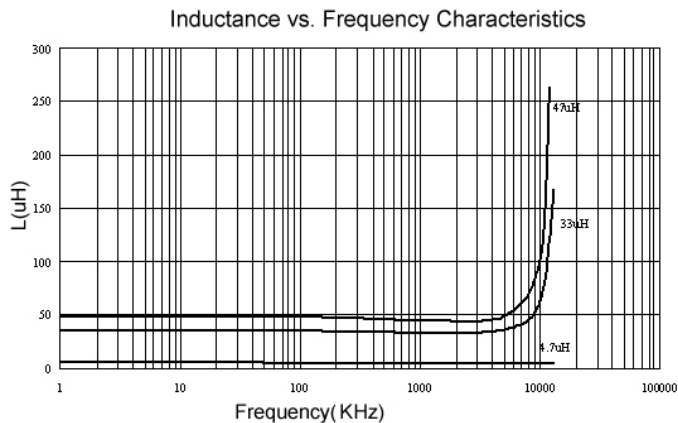

Electrical Characteristics

Part Number	Inductance (μH)	Tolerance ($\pm\%$)	DC Resistance (Ω) Max	SRF (MHz) Typ.	Isat (A)	Irms (A)
SSL0804HC-R33M-N	0.33	20	0.002	300	20.0	16.0
SSL0804HC-R68M-N	0.68	20	0.005	200	13.0	12.0
SSL0804HC-1R0M-N	1.0	20	0.006	100	11.0	10.0
SSL0804HC-1R5M-N	1.5	20	0.008	90	9.0	9.0
SSL0804HC-2R2M-N	2.2	20	0.011	90	7.8	7.4
SSL0804HC-2R7M-N	2.7	20	0.012	65	7.0	6.6
SSL0804HC-3R3M-N	3.3	20	0.014	65	6.4	5.9
SSL0804HC-4R7M-N	4.7	20	0.018	45	5.4	4.8
SSL0804HC-6R8M-N	6.8	20	0.035	35	3.6	5.0
SSL0804HC-100M-N	10	20	0.04	26	3.3	4.3
SSL0804HC-150M-N	15	20	0.06	21	2.4	3.5
SSL0804HC-220M-N	22	20	0.08	17	2.0	2.8
SSL0804HC-330M-N	33	20	0.15	14	1.7	2.1
SSL0804HC-470M-N	47	20	0.28	12	1.4	1.7
SSL0804HC-680M-N	68	20	0.3	9	1.2	1.5
SSL0804HC-101M-N	100	20	0.4	7	0.95	1.2

- Inductance tested at 100 KHz, 0.1 Vrms.
- SRF measured using HP8753D network analyzer
- Inductance drop = 10% typ. at Isat.
- $\Delta T = 40^\circ\text{C}$ typ. at I rms.
- Tolerance: M = $\pm 20\%$
- Operating temperature range $-40^\circ\text{C} \sim 125^\circ\text{C}$ (Including self - temperature rise)
- Electrical specifications at 25°C

Test Instruments :

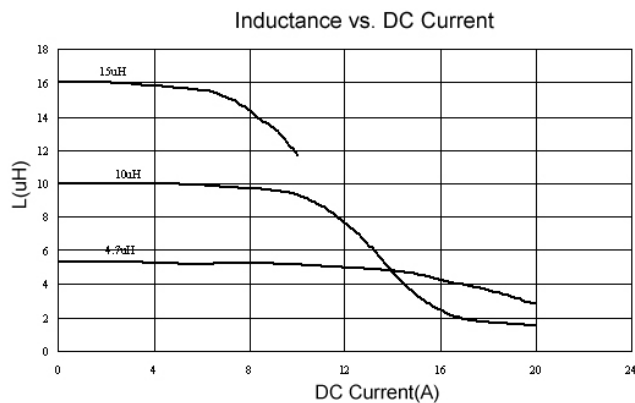
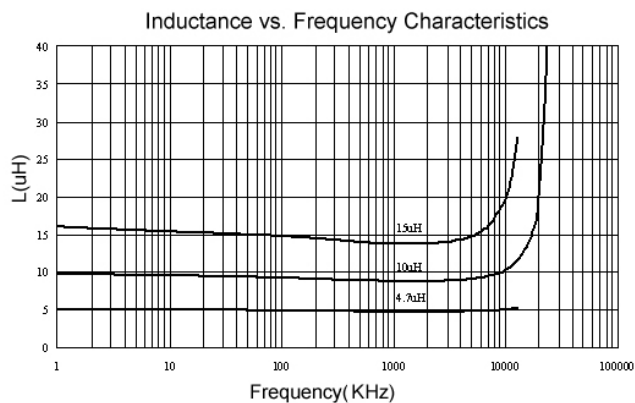

Packaging Specifications

Tape Dimensions

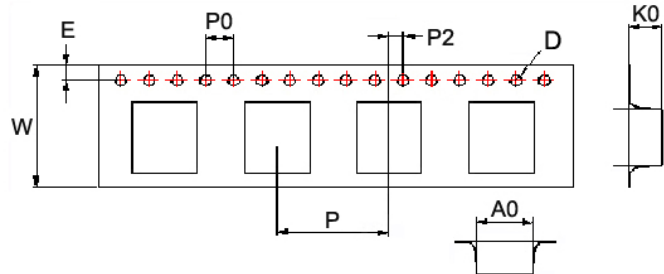

Tape Material

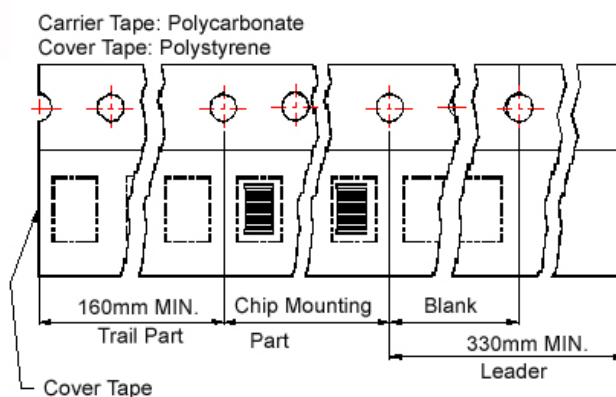

Reel Dimensions

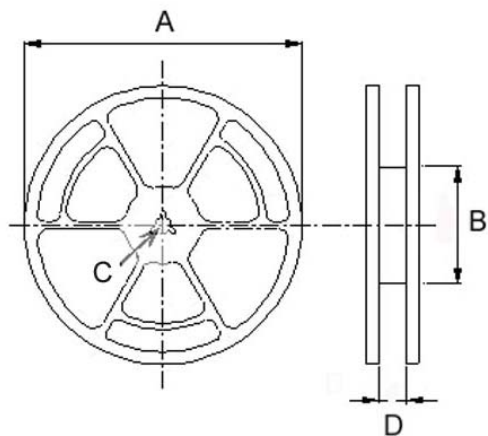

Dimensions in mm

TPYE	Tape Dimensions							Reel Dimensions				Quantity PCS / REEL
	K0	D	E	W	P	P0	P2	A	B	C	D	
SSL 0503HC	5.3	1.55	1.75	16	12	4	2	330	100	13	17.4	1000
SSL 0804HC	6.1	1.55	1.75	24	16	4	2	330	100	13	24.2	700

TFL Series



The TFL Series is designed for miniaturized devices, featuring low inductance, high precision and low loss. It allows for easy impedance matching for both RF and IF circuit designs as well as compact high frequency circuit designs

Features

- Ultra small size
- Excellent Q factor and SRF characteristics
- Minimal deviation in inductance
- Finely graded inductance level

Applications

- RF and wireless communication
- Bluetooth, cellular phone, ultrabook, telecommunications, W-LAN
- High frequency circuits in general

Product Identification

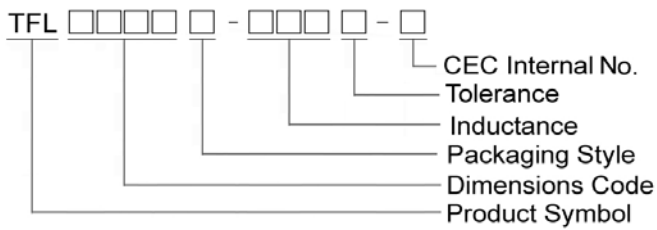

Shape and Dimensions

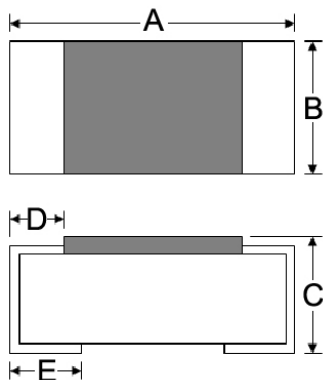

Dimensions in mm

TYPE	A	B	C	D	E
TFL0603	0.61±0.05	0.31±0.05	0.30±0.05	0.10±0.05	0.15±0.05

Recommended Pattern

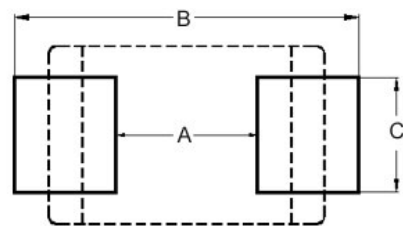

Dimensions in mm

TYPE	A	B	C
TFL0603	0.3	0.75 ~ 1.05	0.3

SMD Thin Film Chip Inductors – TFL Series

Electrical Characteristics

Part Number	Inductance (nH)	Tolerance (±%)	Q Min	Test Frequency (MHz)	SRF (MHz) Typ	DC Resistance (Ω) Max	Rated Current (mA) Max
TFL0603T-0N6□-S	0.6	±0.1nH/±0.2nH	14	500 / 500mV	6000	0.10	900
TFL0603T-0N7□-S	0.7	±0.1nH/±0.2nH	14	500 / 500mV	6000	0.10	850
TFL0603T-0N8□-S	0.8	±0.1nH/±0.2nH	14	500 / 500mV	6000	0.10	850
TFL0603T-0N9□-S	0.9	±0.1nH/±0.2nH	14	500 / 500mV	6000	0.10	800
TFL0603T-1N0□-S	1.0	±0.1nH/±0.2nH	14	500 / 500mV	6000	0.10	800
TFL0603T-1N1□-S	1.1	±0.1nH/±0.2nH	14	500 / 500mV	6000	0.10	800
TFL0603T-1N2□-S	1.2	±0.1nH/±0.2nH	14	500 / 500mV	6000	0.10	800
TFL0603T-1N3□-S	1.3	±0.1nH/±0.2nH	14	500 / 500mV	6000	0.12	650
TFL0603T-1N4□-S	1.4	±0.1nH/±0.2nH	14	500 / 500mV	6000	0.13	650
TFL0603T-1N5□-S	1.5	±0.1nH/±0.2nH	14	500 / 500mV	6000	0.16	650
TFL0603T-1N6□-S	1.6	±0.1nH/±0.2nH	14	500 / 500mV	6000	0.16	650
TFL0603T-1N7□-S	1.7	±0.1nH/±0.2nH	14	500 / 500mV	6000	0.20	650
TFL0603T-1N8□-S	1.8	±0.1nH/±0.2nH	14	500 / 500mV	6000	0.20	650
TFL0603T-1N9□-S	1.9	±0.1nH/±0.2nH	14	500 / 500mV	6000	0.20	620
TFL0603T-2N0□-S	2.0	±0.1nH/±0.2nH	14	500 / 500mV	6000	0.20	620
TFL0603T-2N1□-S	2.1	±0.1nH/±0.2nH	14	500 / 500mV	6000	0.20	620
TFL0603T-2N2□-S	2.2	±0.1nH/±0.2nH	14	500 / 500mV	6000	0.20	620
TFL0603T-2N3□-S	2.3	±0.1nH/±0.2nH	14	500 / 500mV	6000	0.20	500
TFL0603T-2N4□-S	2.4	±0.1nH/±0.2nH	14	500 / 500mV	6000	0.20	500
TFL0603T-2N5□-S	2.5	±0.1nH/±0.2nH	14	500 / 500mV	6000	0.20	500
TFL0603T-2N6□-S	2.6	±0.1nH/±0.2nH	14	500 / 500mV	6000	0.20	500
TFL0603T-2N7□-S	2.7	±0.1nH/±0.2nH	14	500 / 500mV	6000	0.23	500
TFL0603T-2N8□-S	2.8	±0.1nH/±0.2nH	14	500 / 500mV	6000	0.25	500
TFL0603T-2N9□-S	2.9	±0.1nH/±0.2nH	14	500 / 500mV	6000	0.25	500
TFL0603T-3N0□-S	3.0	±0.1nH/±0.2nH	14	500 / 500mV	6000	0.30	450
TFL0603T-3N1□-S	3.1	±0.1nH/±0.2nH	14	500 / 500mV	6000	0.30	450
TFL0603T-3N2□-S	3.2	±0.1nH/±0.2nH	14	500 / 500mV	6000	0.30	450
TFL0603T-3N3□-S	3.3	±0.1nH/±0.2nH	14	500 / 500mV	6000	0.30	450
TFL0603T-3N4□-S	3.4	±0.1nH/±0.2nH	14	500 / 500mV	6000	0.32	450
TFL0603T-3N5□-S	3.5	±0.1nH/±0.2nH	14	500 / 500mV	6000	0.32	450
TFL0603T-3N6□-S	3.6	±0.1nH/±0.2nH	14	500 / 500mV	6000	0.32	400
TFL0603T-3N7□-S	3.7	±0.1nH/±0.2nH	14	500 / 500mV	6000	0.40	400
TFL0603T-3N8□-S	3.8	±0.1nH/±0.2nH	14	500 / 500mV	6000	0.40	350
TFL0603T-3N9□-S	3.9	±0.1nH/±0.2nH	14	500 / 500mV	5700	0.40	350
TFL0603T-4N3□-S	4.3	3 / 5	14	500 / 500mV	5300	0.40	300
TFL0603T-4N7□-S	4.7	3 / 5	14	500 / 500mV	4400	0.45	280
TFL0603T-5N1□-S	5.1	3 / 5	14	500 / 500mV	4200	0.50	270
TFL0603T-5N6□-S	5.6	3 / 5	14	500 / 500mV	4000	0.55	260
TFL0603T-6N2□-S	6.2	3 / 5	14	500 / 500mV	4000	0.60	250
TFL0603T-6N8□-S	6.8	3 / 5	14	500 / 500mV	3900	0.70	230
TFL0603T-7N5□-S	7.5	3 / 5	12	500 / 500mV	3700	1.10	180
TFL0603T-8N2□-S	8.2	3 / 5	12	500 / 500mV	3600	1.20	180
TFL0603T-9N1□-S	9.1	3 / 5	12	500 / 500mV	3300	1.20	180
TFL0603T-10N□-S	10	3 / 5	12	500 / 500mV	3200	1.30	180

Electrical Characteristics

Part Number	Inductance (nH)	Tolerance (±%)	Q Min	Test Frequency (MHz)	SRF (MHz) Typ	DC Resistance (Ω) Max	Rated Current (mA) Max
TFL0603T-12N□-S	12	3 / 5	12	500 / 500mV	2900	1.30	180
TFL0603T-15N□-S	15	3 / 5	12	500 / 500mV	2600	1.50	180
TFL0603T-18N□-S	18	3 / 5	12	500 / 500mV	2200	1.70	160
TFL0603T-22N□-S	22	3 / 5	12	500 / 500mV	2200	2.55	120

- Tolerance : B = ± 0.1nH , C = ± 0.2nH , H = ± 3% , J = ± 5%
- Test Instruments : L/Q : Agilent E4991A + Fixture : Agilent 16197A
SRF : HP8753D
RDC : HP4338B/ CH502BC

Test Instruments : Agilent E4991A Material/Impedance Analyzer

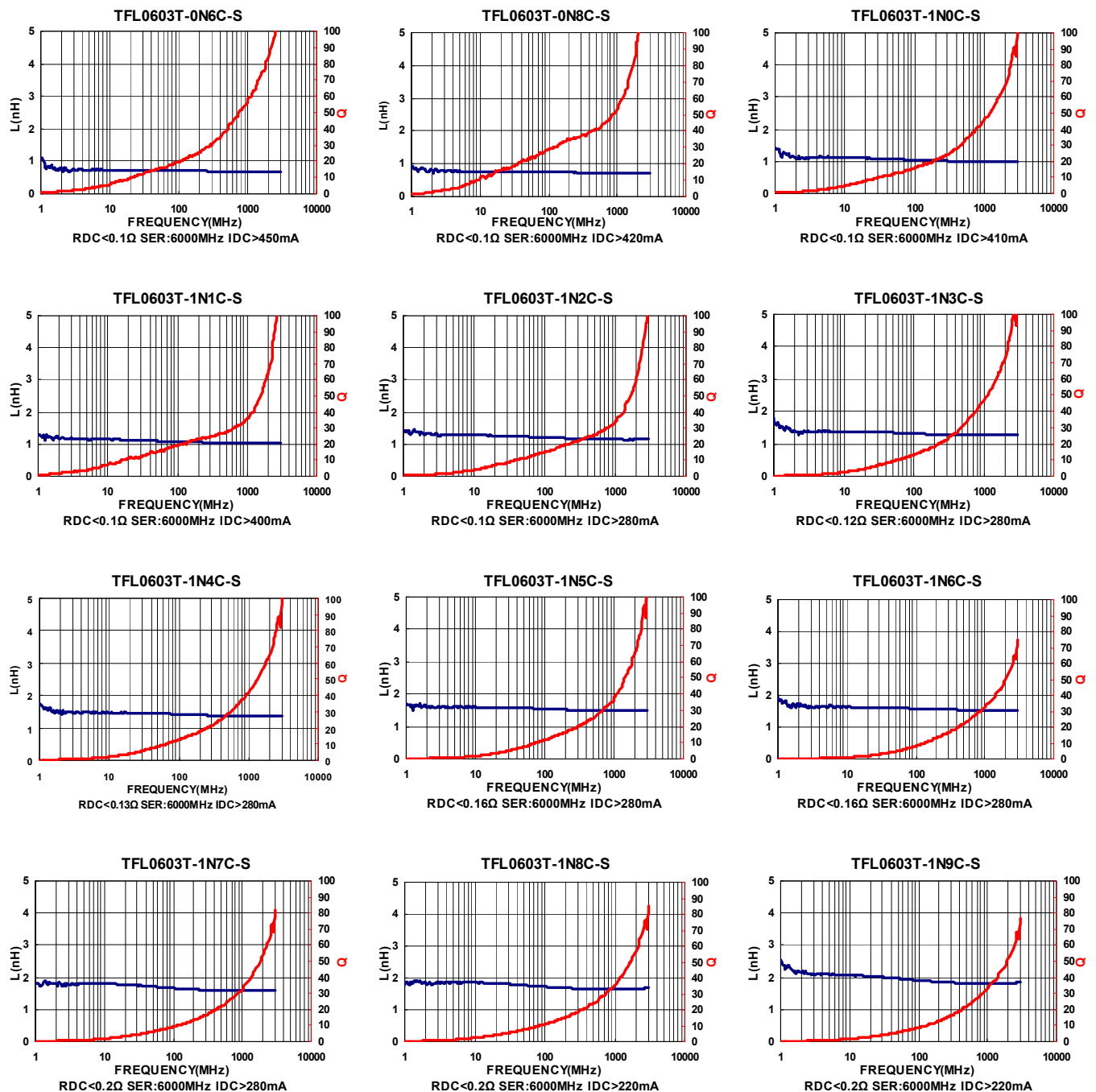

Test Instruments : Agilent E4991A Material/Impedance Analyzer

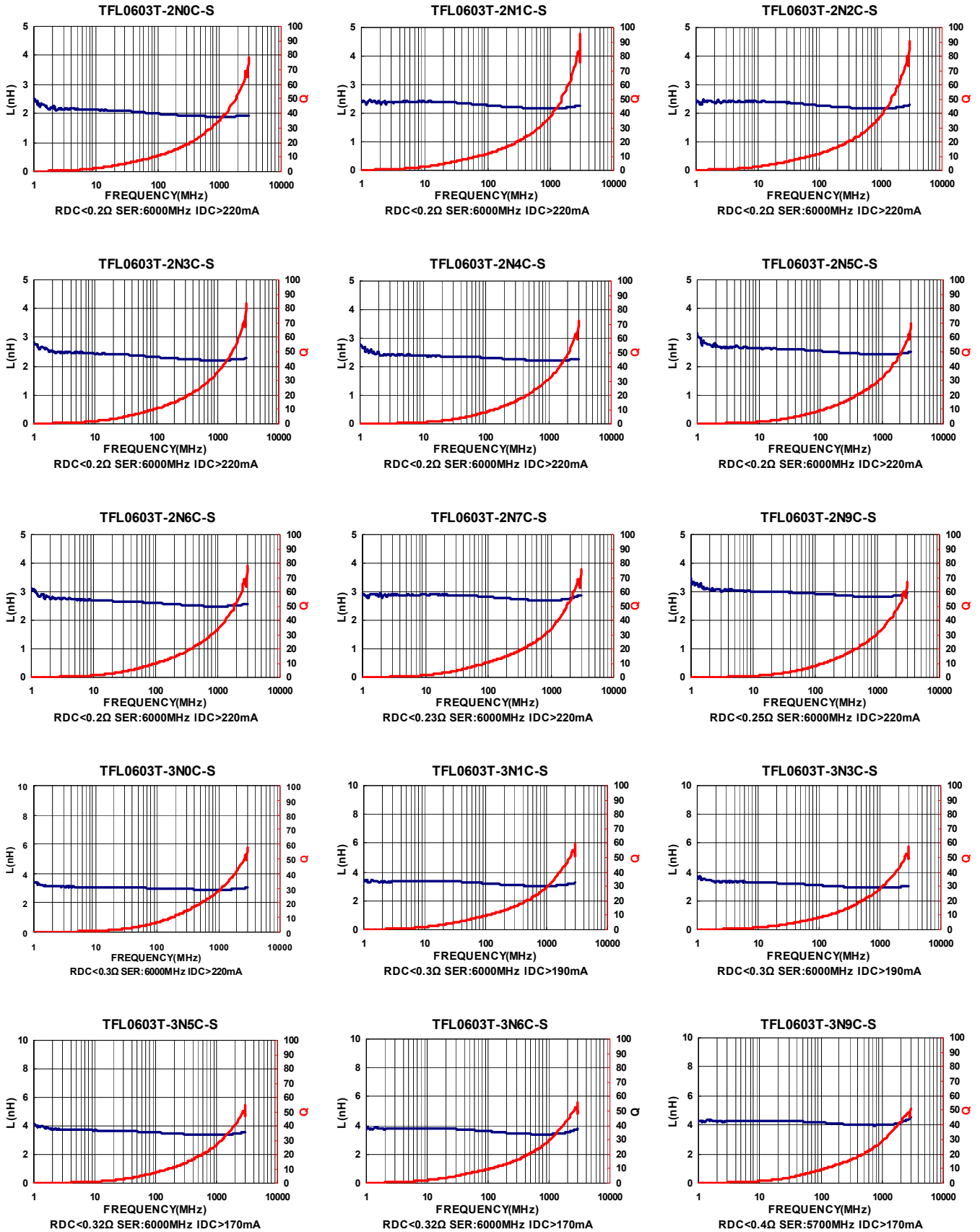

SMD Thin Film Chip Inductors - TFL Series

est Instruments : Agilent E4991A Material/Impedance Analyzer

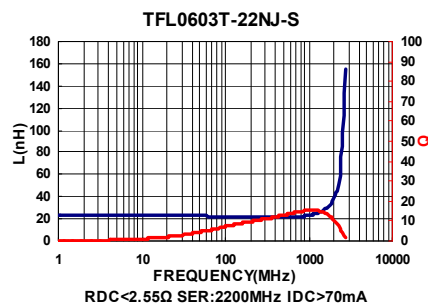
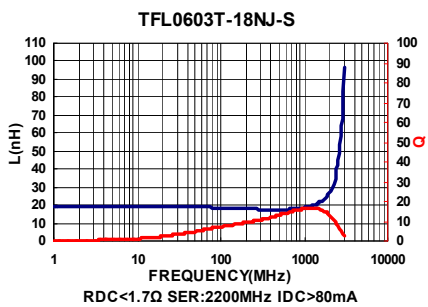
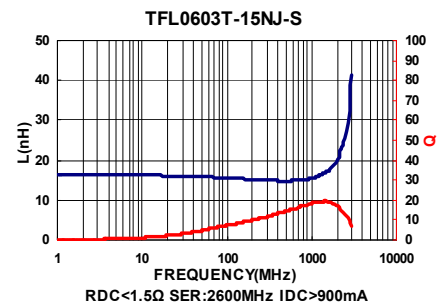
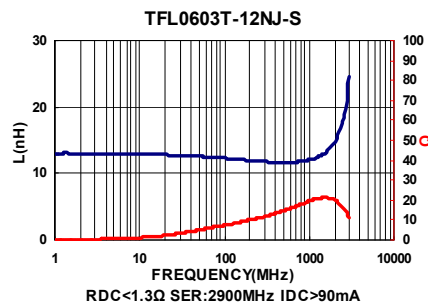
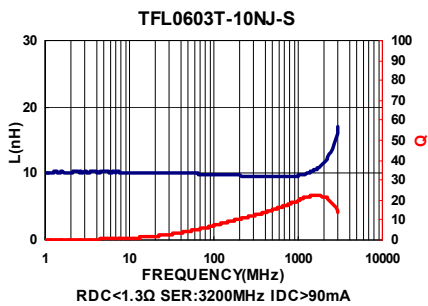
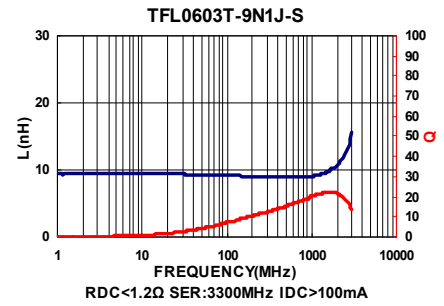
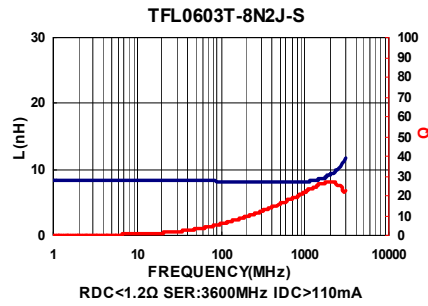
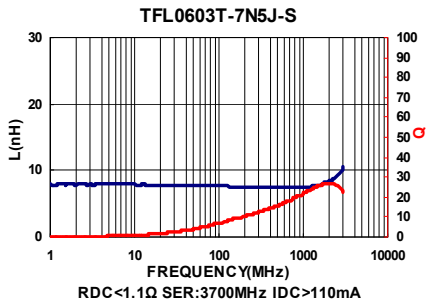
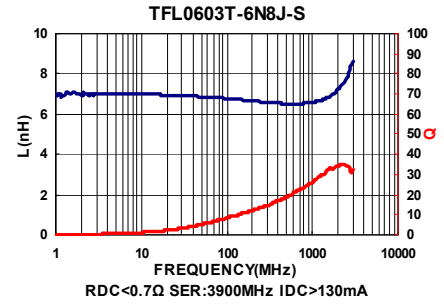
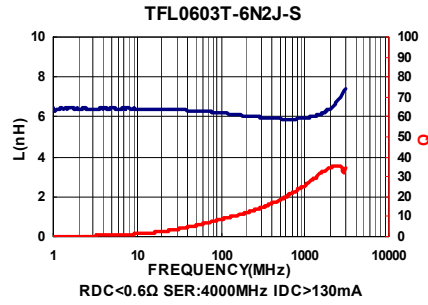
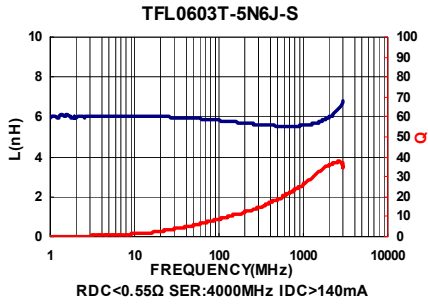
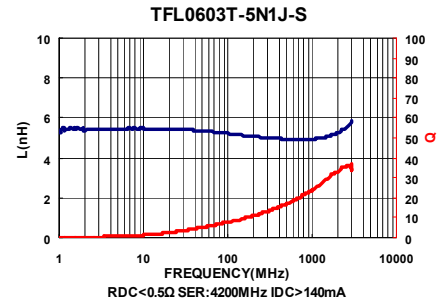
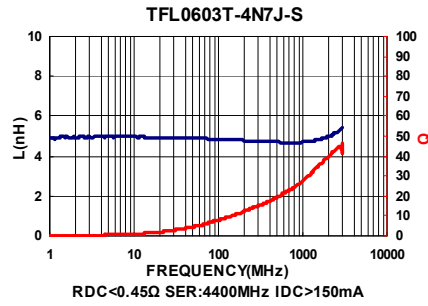
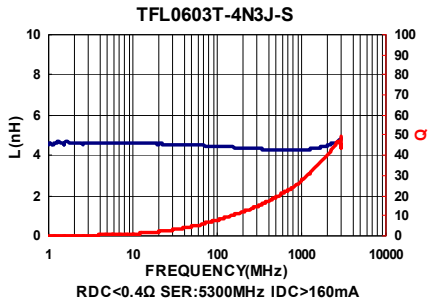

Test Instruments : Agilent E4991A Material/Impedance Analyzer

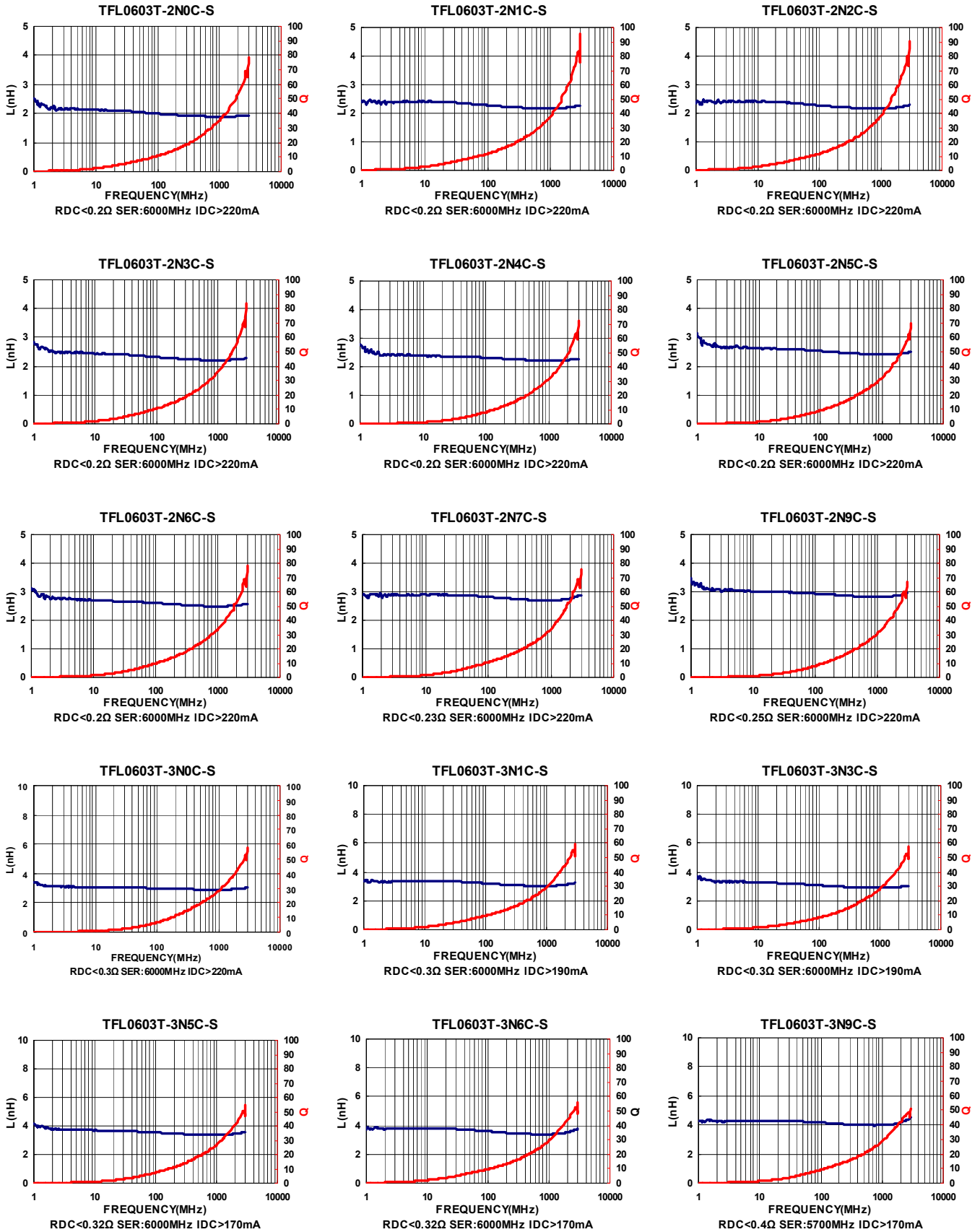

SMD Thin Film Chip Inductors - TFL Series

est Instruments : Agilent E4991A Material/Impedance Analyzer

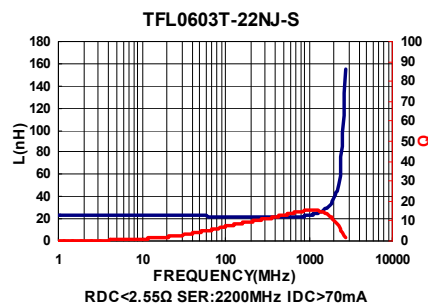
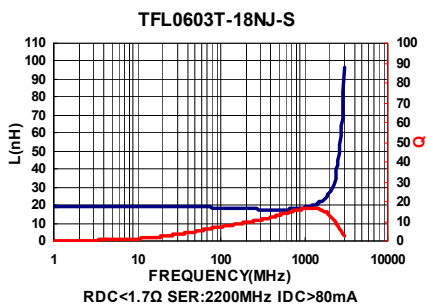
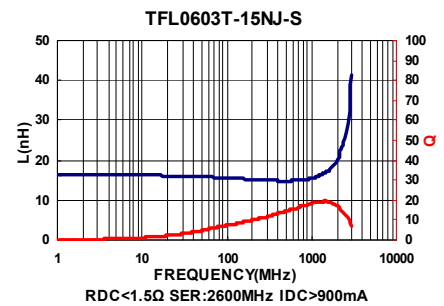
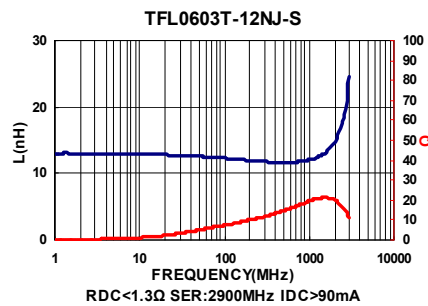
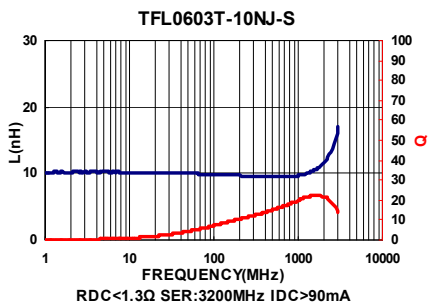
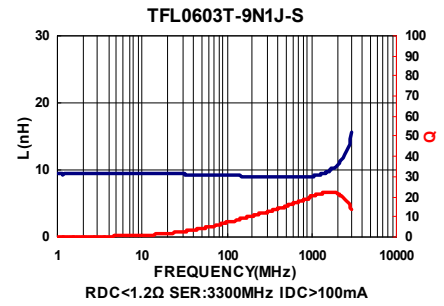
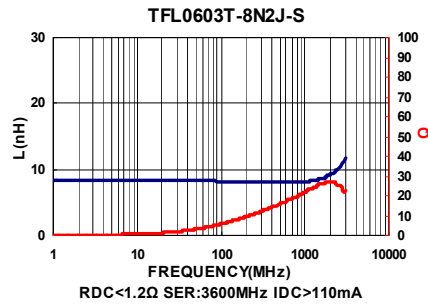
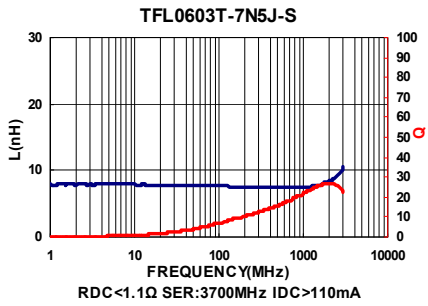
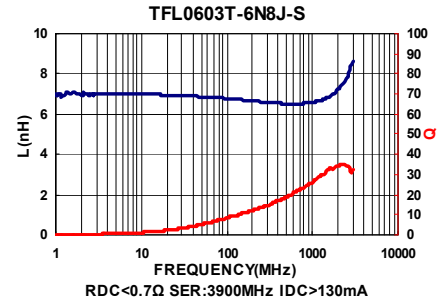
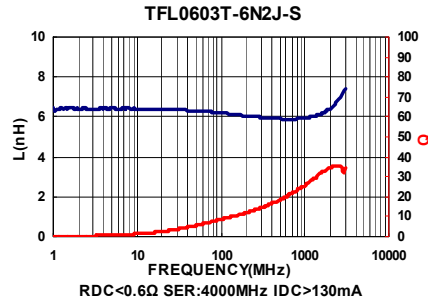
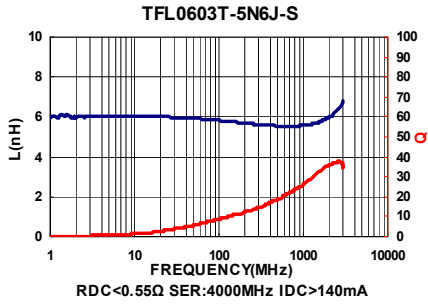
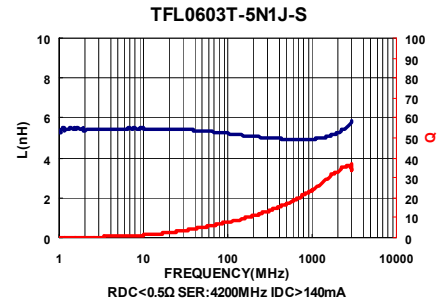
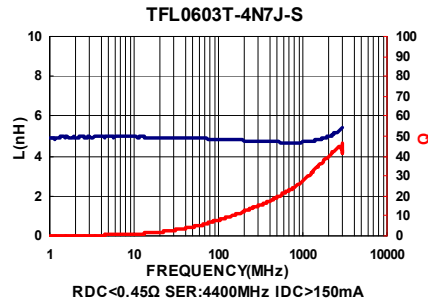
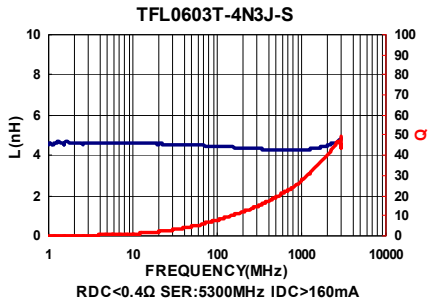

Packaging Specifications

Tape Dimensions

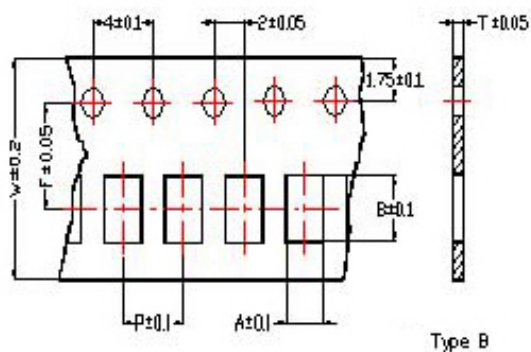

Tape Material

Carrier tape : Paper
Cover tape : Polyethylene

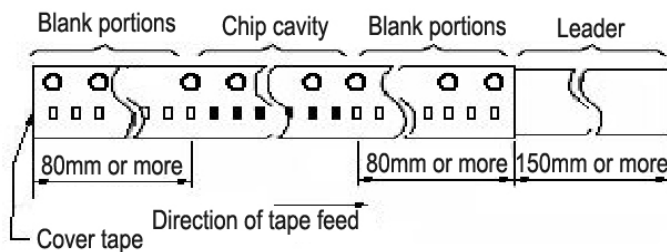

Reel Dimensions

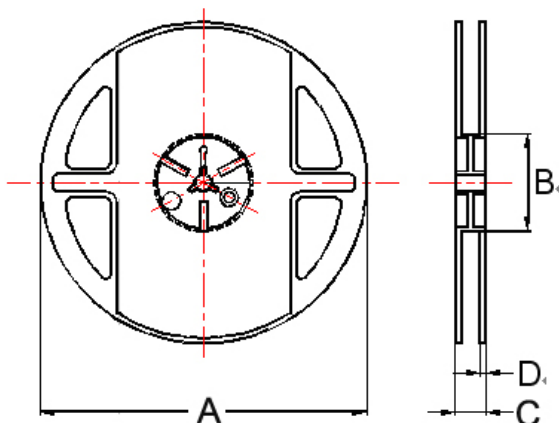

Dimensions in mm

TYPE	Tape Dimensions						Reel Dimensions				Quantity PCS / Reel
	A	B	T	W	P	F	A	B	C	D	
TFL0603	0.37	0.67	0.42	8	2	3.5	180	60	13	1.5	10000

CHQ Series



CHQ Series supports miniaturized devices. Its low inductance, high precision and high Q enables easy impedance matching at both RF and IF circuits and compact high frequency circuit designing.

Features

- Excellent high frequency application
- High Q factor and SRF value
- Miniaturization
- Tight tolerance
- Wide inductance range

Applications

- RF matching circuit requiring Q value
- Bluetooth, WLAN, UWB, digital TV tuners and high-frequency circuit and module

Product Identification

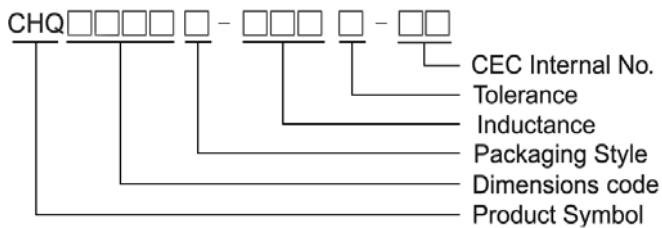

Shape and Dimensions

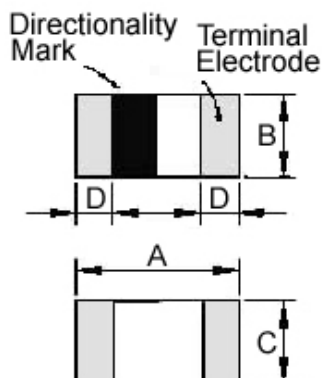

Dimensions in mm

TYPE	A	B	C	D
CHQ0603	0.6±0.03	0.3±0.03	0.3±0.03	0.10±0.05

Recommended Pattern

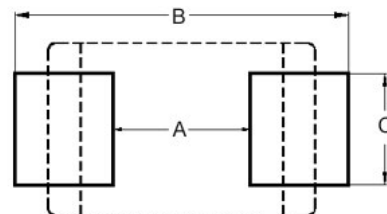

Dimensions in mm

TYPE	A	B	C
CHQ0603	0.3	0.75 ~ 1.05	0.3

SMD Ceramic Multilayer Chip Inductors - CHQ Series

Electrical Characteristics

Part Number	Inductance (nH)	Tolerance (±%)	Q Min	Test Frequency (MHz)	Q Typical					SRF (MHz) Min	DC Resistance (Ω) Max	IDC (mA) Max
					500 MHz	800 MHz	1.8 GHz	2.0 GHz	2.4 GHz			
CHQ0603T-0N6□-HU	0.6	±0.1nH/±0.2nH/±0.3nH	14	500	>35	>47	>75	>80	>88	10000	0.06	900
CHQ0603T-0N7□-HU	0.7	±0.1nH/±0.2nH/±0.3nH	14	500	>35	>47	>75	>80	>88	10000	0.06	900
CHQ0603T-0N8□-HU	0.8	±0.1nH/±0.2nH/±0.3nH	14	500	>35	>47	>75	>80	>88	10000	0.06	900
CHQ0603T-0N9□-HU	0.9	±0.1nH/±0.2nH/±0.3nH	14	500	>35	>47	>75	>80	>88	10000	0.06	900
CHQ0603T-1N0□-HU	1.0	±0.1nH/±0.2nH/±0.3nH	14	500	>35	>47	>75	>80	>88	10000	0.07	850
CHQ0603T-1N1□-HU	1.1	±0.1nH/±0.2nH/±0.3nH	14	500	>35	>47	>75	>80	>88	10000	0.07	850
CHQ0603T-1N2□-HU	1.2	±0.1nH/±0.2nH/±0.3nH	14	500	35	47	75	80	88	10000	0.08	800
CHQ0603T-1N3□-HU	1.3	±0.1nH/±0.2nH/±0.3nH	14	500	32	43	70	74	82	10000	0.09	760
CHQ0603T-1N4□-HU	1.4	±0.1nH/±0.2nH/±0.3nH	14	500	29	39	63	67	75	10000	0.12	640
CHQ0603T-1N5□-HU	1.5	±0.1nH/±0.2nH/±0.3nH	14	500	27	36	59	62	69	10000	0.15	600
CHQ0603T-1N6□-HU	1.6	±0.1nH/±0.2nH/±0.3nH	14	500	25	33	54	57	63	10000	0.19	510
CHQ0603T-1N7□-HU	1.7	±0.1nH/±0.2nH/±0.3nH	14	500	25	32	52	54	61	10000	0.11	680
CHQ0603T-1N8□-HU	1.8	±0.1nH/±0.2nH/±0.3nH	14	500	25	32	51	53	59	10000	0.12	640
CHQ0603T-1N9□-HU	1.9	±0.1nH/±0.2nH/±0.3nH	14	500	24	31	50	53	58	10000	0.13	620
CHQ0603T-2N0□-HU	2.0	±0.1nH/±0.2nH/±0.3nH	14	500	24	31	50	53	58	10000	0.15	600
CHQ0603T-2N1□-HU	2.1	±0.1nH/±0.2nH/±0.3nH	14	500	24	31	50	53	58	10000	0.16	550
CHQ0603T-2N2□-HU	2.2	±0.1nH/±0.2nH/±0.3nH	14	500	24	31	50	53	58	10000	0.20	500
CHQ0603T-2N3□-HU	2.3	±0.1nH/±0.2nH/±0.3nH	14	500	24	31	49	52	58	10000	0.24	460
CHQ0603T-2N4□-HU	2.4	±0.1nH/±0.2nH/±0.3nH	14	500	22	28	45	48	53	10000	0.26	430
CHQ0603T-2N5□-HU	2.5	±0.1nH/±0.2nH/±0.3nH	14	500	22	29	46	49	54	10000	0.28	415
CHQ0603T-2N6□-HU	2.6	±0.1nH/±0.2nH/±0.3nH	14	500	21	27	44	46	51	10000	0.30	405
CHQ0603T-2N7□-HU	2.7	±0.1nH/±0.2nH/±0.3nH	14	500	20	26	41	43	48	10000	0.32	400
CHQ0603T-2N8□-HU	2.8	±0.1nH/±0.2nH/±0.3nH	14	500	20	26	41	43	47	9500	0.20	500
CHQ0603T-2N9□-HU	2.9	±0.1nH/±0.2nH/±0.3nH	14	500	20	26	41	43	47	9300	0.22	480
CHQ0603T-3N0□-HU	3.0	±0.1nH/±0.2nH/±0.3nH	14	500	20	26	41	43	47	9100	0.24	460
CHQ0603T-3N1□-HU	3.1	±0.1nH/±0.2nH/±0.3nH	14	500	20	26	41	43	47	8900	0.25	450
CHQ0603T-3N2□-HU	3.2	±0.1nH/±0.2nH/±0.3nH	14	500	20	26	40	43	47	8700	0.28	415
CHQ0603T-3N3□-HU	3.3	±0.1nH/±0.2nH/±0.3nH	14	500	20	26	40	43	47	8600	0.28	415
CHQ0603T-3N4□-HU	3.4	±0.1nH/±0.2nH/±0.3nH	14	500	20	25	40	43	47	8400	0.29	410
CHQ0603T-3N5□-HU	3.5	±0.1nH/±0.2nH/±0.3nH	14	500	20	25	40	42	46	8200	0.30	405
CHQ0603T-3N6□-HU	3.6	±0.1nH/±0.2nH/±0.3nH	14	500	19	25	40	42	46	8100	0.32	400
CHQ0603T-3N7□-HU	3.7	±0.1nH/±0.2nH/±0.3nH	14	500	19	25	40	42	46	8000	0.36	370
CHQ0603T-3N8□-HU	3.8	±0.1nH/±0.2nH/±0.3nH	14	500	19	25	39	41	45	7800	0.40	355
CHQ0603T-3N9□-HU	3.9	±0.1nH/±0.2nH/±0.3nH	14	500	19	25	39	41	45	7700	0.41	350
CHQ0603T-4N0□-HU	4.0	±0.1nH/±0.2nH/±0.3nH	14	500	18	28	39	41	45	7600	0.44	335
CHQ0603T-4N1□-HU	4.1	±0.1nH/±0.2nH/±0.3nH	14	500	19	25	39	41	45	7500	0.48	320
CHQ0603T-4N2□-HU	4.2	±0.1nH/±0.2nH/±0.3nH	14	500	18	24	37	39	43	7300	0.48	320
CHQ0603T-4N3□-HU	4.3	±0.2nH/±0.3nH	14	500	18	24	37	39	43	6500	0.48	320
CHQ0603T-4N6□-HU	4.6	±0.2nH/±0.3nH	14	500	18	24	37	39	42	6500	0.39	360
CHQ0603T-4N7□-HU	4.7	±0.2nH/±0.3nH	14	500	19	24	37	39	42	6400	0.42	350
CHQ0603T-5N0□-HU	5.0	±0.2nH/±0.3nH	14	500	19	24	37	39	42	6200	0.44	335
CHQ0603T-5N1□-HU	5.1	±0.2nH/±0.3nH	14	500	19	24	37	39	42	6100	0.45	330
CHQ0603T-5N4□-HU	5.4	±0.2nH/±0.3nH	14	500	18	24	36	38	42	5900	0.49	315
CHQ0603T-5N6□-HU	5.6	±0.2nH/±0.3nH	14	500	18	24	36	37	41	5500	0.47	325
CHQ0603T-5N9□-HU	5.9	±0.2nH/±0.3nH	14	500	18	23	35	36	39	5500	0.47	325
CHQ0603T-6N2□-HU	6.2	±0.2nH/±0.3nH	14	500	18	23	35	36	39	5100	0.52	305
CHQ0603T-6N5□-HU	6.5	±0.2nH/±0.3nH	14	500	18	23	35	36	39	5100	0.52	305
CHQ0603T-6N8□-HU	6.8	3/5	14	500	18	23	35	36	39	4800	0.55	305

- Tolerance : B = ± 0.1 nH ; C = ± 0.2 nH ; S = ± 0.3 nH ; H = ± 3 % ; J = ± 5%
- Test Instruments : L/Q : Agilent E4991A Fixture : Agilent 16197A
SRF : Agilent E4991A / HP19196C
RDC : HP4338B/ CH502BC

Electrical Characteristics

Part Number	Inductance (nH)	Tolerance (±%)	Q Min	Test Frequency (MHz)	Q Typical					SRF (MHz) Min	DC Resistance (Ω) Max	IDC (mA) Max
					500 MHz	800 MHz	1.8 GHz	2.0 GHz	2.4 GHz			
CHQ0603T-7N1□-HU	7.1	3/5	14	500	18	23	35	36	39	4800	0.55	305
CHQ0603T-7N5□-HU	7.5	3/5	14	500	18	23	34	35	38	4600	0.55	305
CHQ0603T-7N8□-HU	7.8	3/5	14	500	17	22	33	34	36	4600	0.51	310
CHQ0603T-8N2□-HU	8.2	3/5	14	500	17	22	33	34	36	4300	0.57	290
CHQ0603T-8N5□-HU	8.5	3/5	14	500	17	22	33	34	36	4300	0.57	290
CHQ0603T-9N1□-HU	9.1	3/5	14	500	17	22	33	34	36	4000	0.65	270
CHQ0603T-9N4□-HU	9.4	3/5	14	500	17	22	33	34	36	4000	0.73	250
CHQ0603T-10N□-HU	10	3/5	14	500	17	22	33	34	36	3800	0.85	230
CHQ0603T-12N□-HU	12	3/5	14	500	17	22	31	32	33	3300	0.85	230
CHQ0603T-15N□-HU	15	3/5	14	500	17	21	28	29	29	2600	0.89	220
CHQ0603T-18N□-HU	18	3/5	14	500	16	21	26	26	25	2300	1.05	205
CHQ0603T-22N□-HU	22	3/5	14	500	16	21	26	26	24	1900	1.29	190

- Tolerance : B = ± 0.1 nH ; C = ± 0.2 nH ; S = ± 0.3 nH ; H = ± 3 % ; J = ± 5%
- Test Instruments : L/Q : Agilent E4991A Fixture : Agilent 16197A
 SRF : Agilent E4991A / HP19196C
 RDC : HP4338B/ CH502BC

Test Instruments : Agilent E4991A Material/Impedance Analyzer

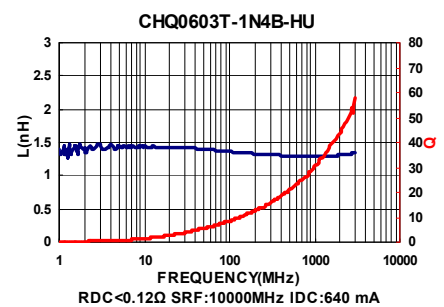
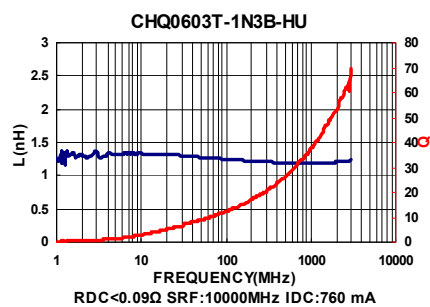
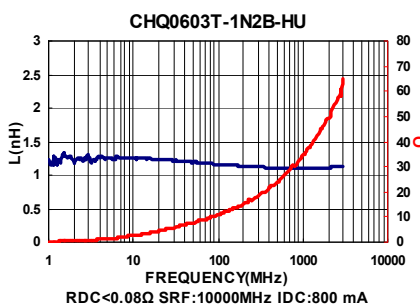
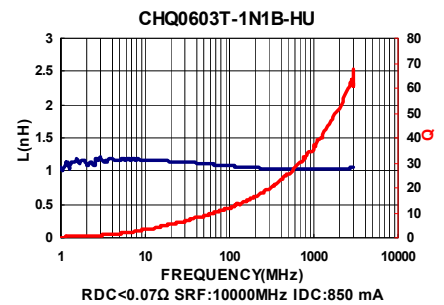
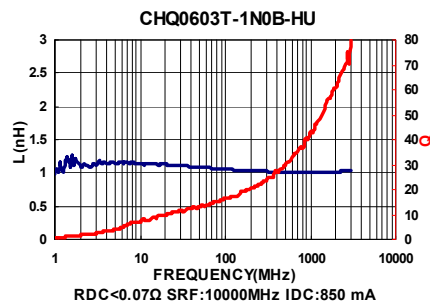
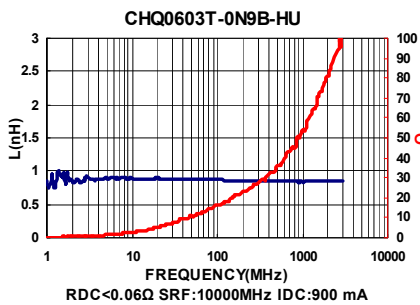
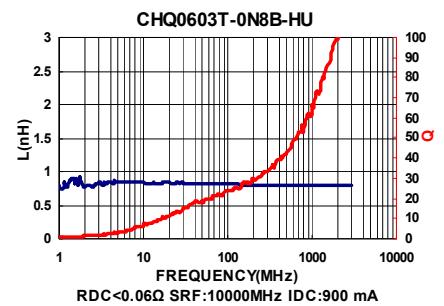
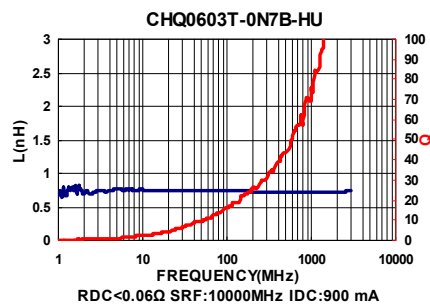
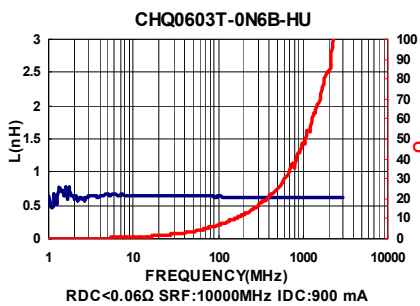

Test Instruments : Agilent E4991A Material/Impedance Analyzer

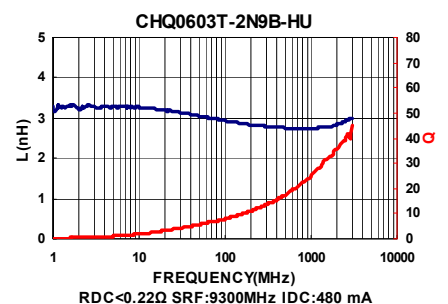
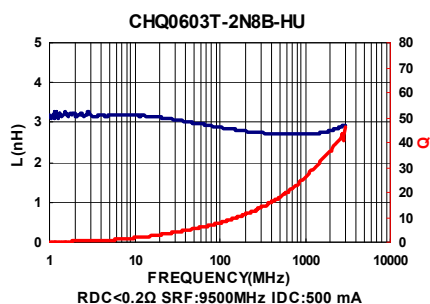
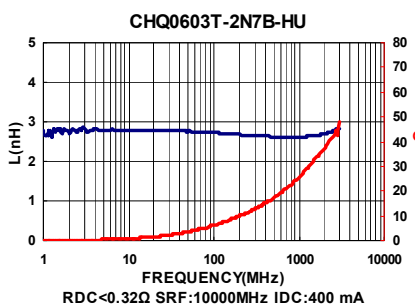
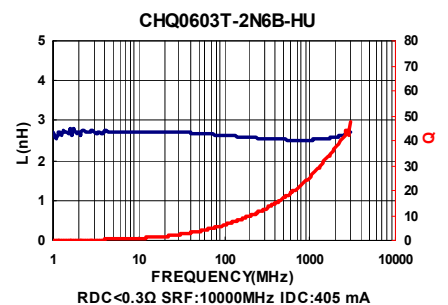
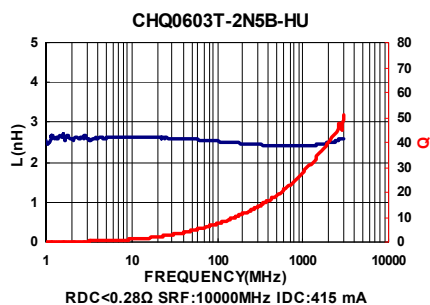
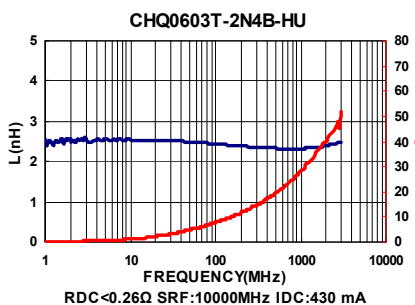
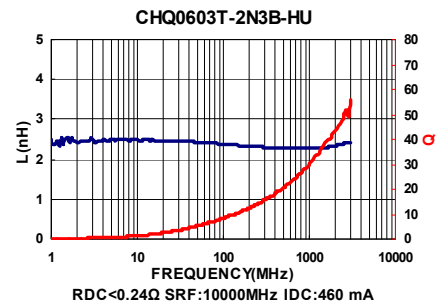
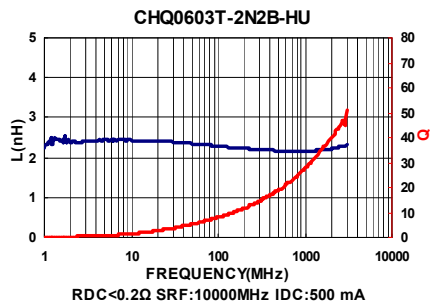
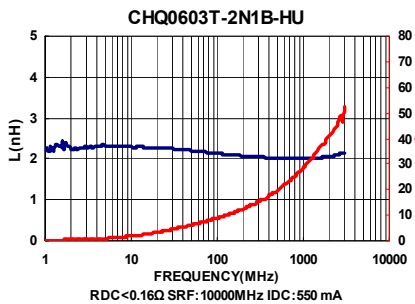
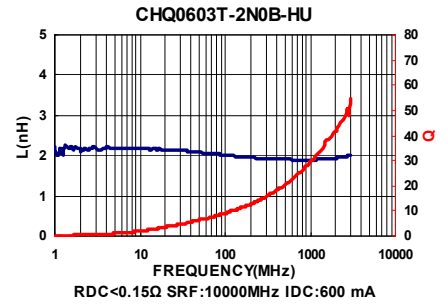
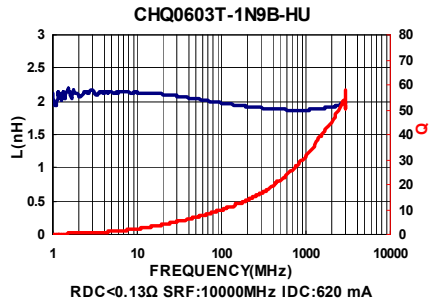
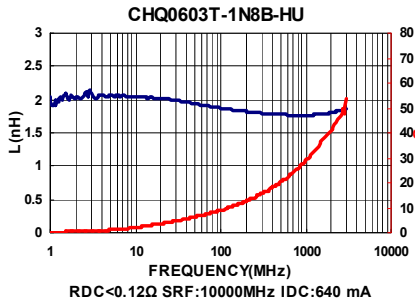
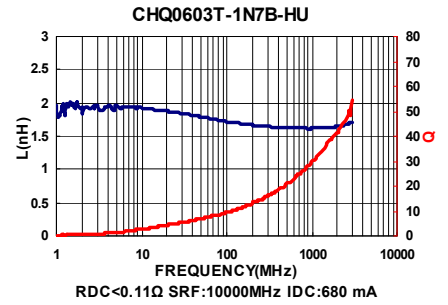
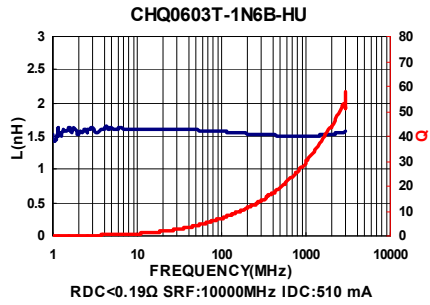
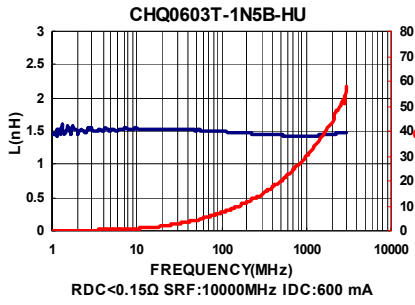

Test Instruments : Agilent E4991A Material/Impedance Analyzer

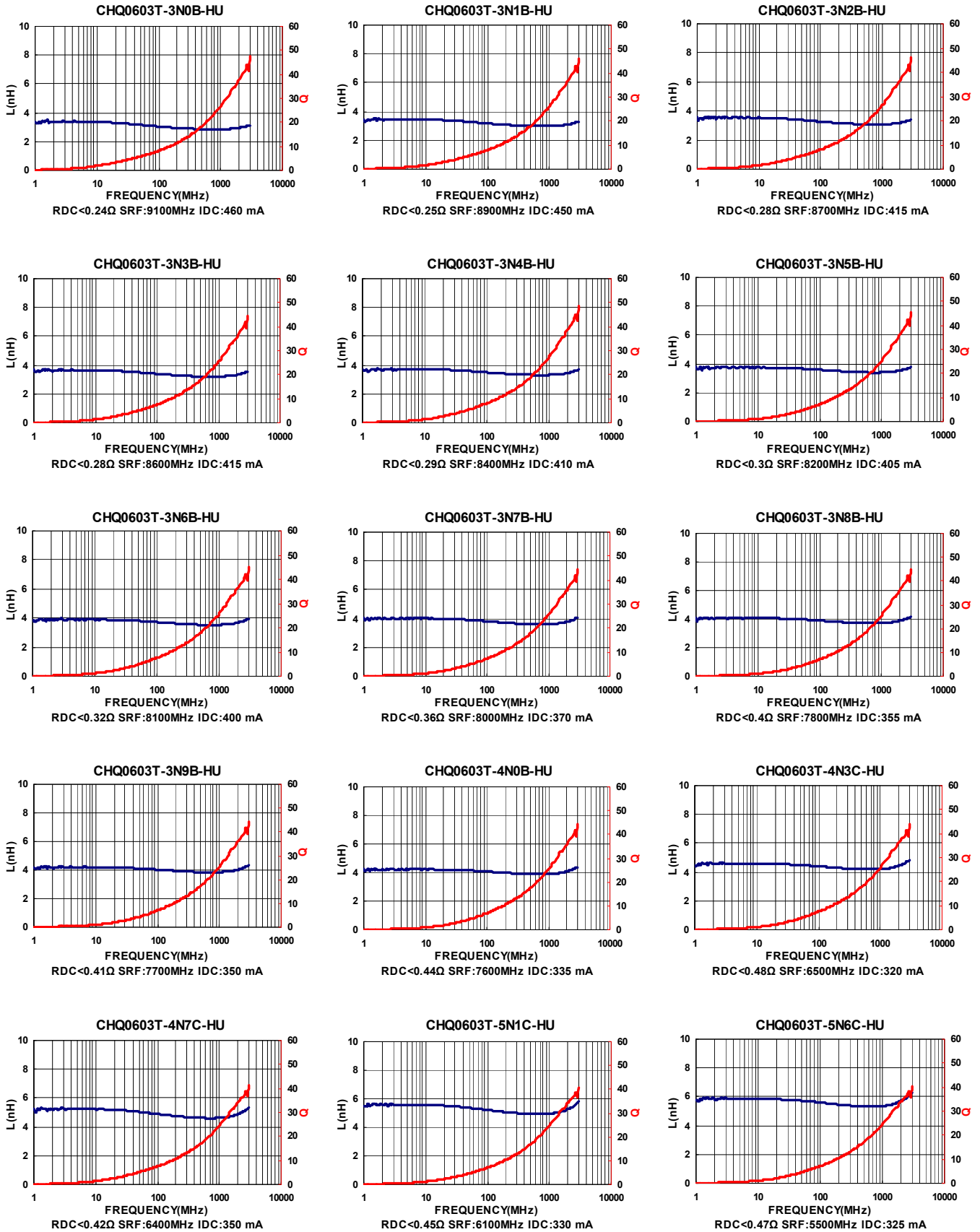

Test Instruments : Agilent E4991A Material/Impedance Analyzer

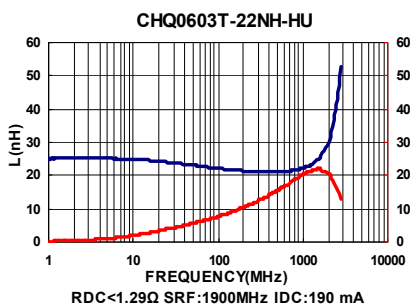
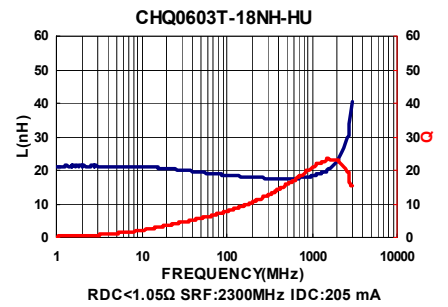
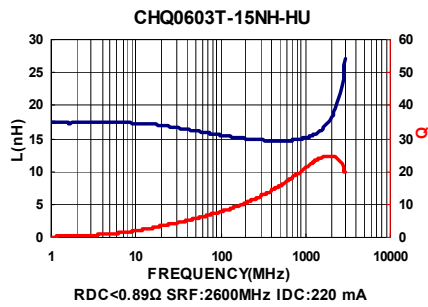
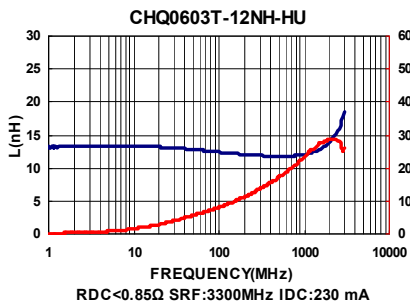
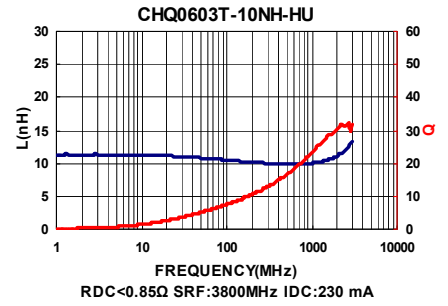
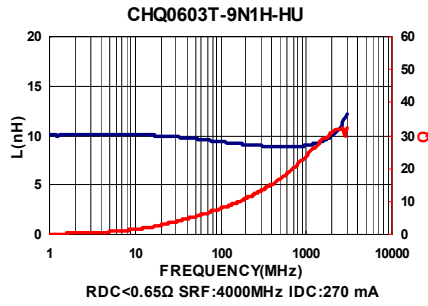
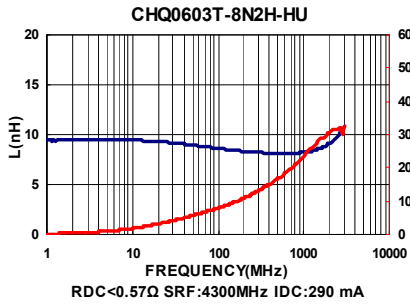
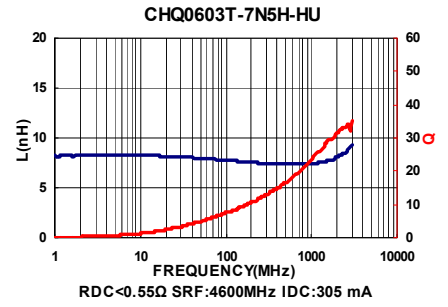
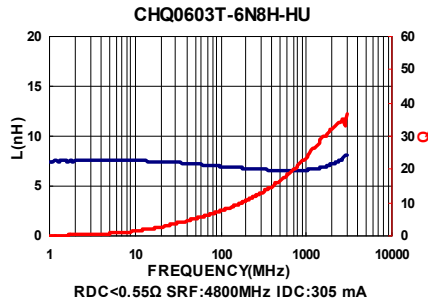
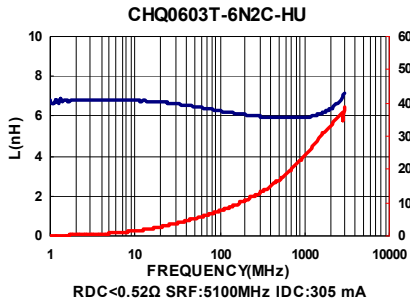

Packaging Specifications

Tape Dimensions

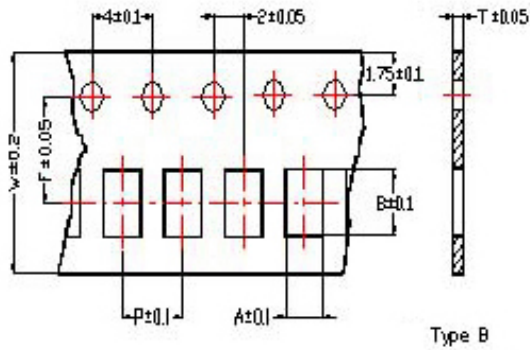

Tape Material

Carrier tape : Paper
Cover tape : Polyethylene

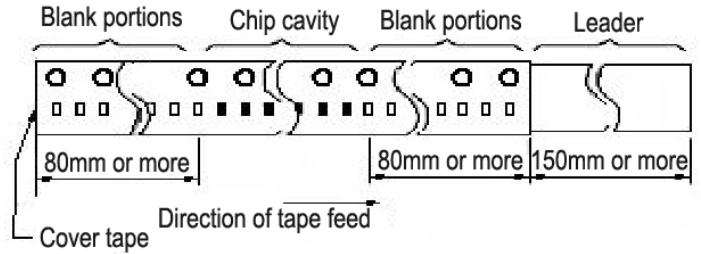

Reel Dimensions

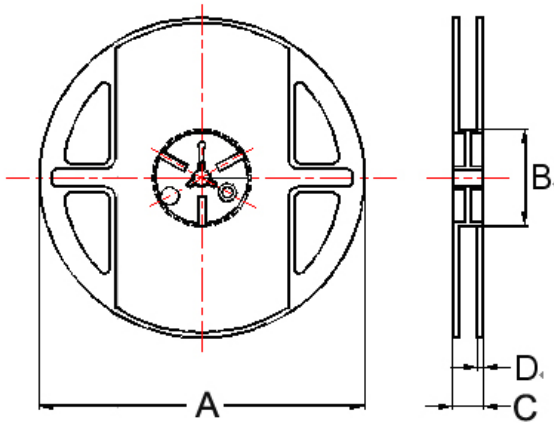

Dimensions in mm

TYPE	Tape Dimensions						Reel Dimensions				Quantity
	A	B	T	W	P	F	A	B	C	D	PCS / Reel
CHQ0603	0.37	0.67	0.42	8	2	3.5	180	60	13	1.5	15000

CLH Series

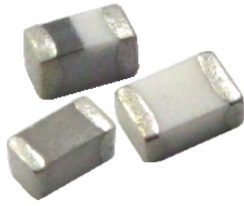

The CLH Series is a type of ceramic chip inductor produced using the multilayer technology. The series provides excellent Q factor and SRF characteristics and is suitable for high frequency applications.

Features

- RoHS compliant
- Excellent Q factor and SRF characteristics
- Small size of 1005/1608 is suitable for small portable devices
- Supports operating frequency up to 6GHz with nominal inductance values from 1.0nH to 470nH.

Applications

- RF resonance and impedance matching circuit
- RF and wireless communication
- Information technology equipment, computers, telecommunications, radar detectors, automotive electronics, cellular phones, pagers, PDAs, keyless remote systems
- L-C filter configurations

Product Identification

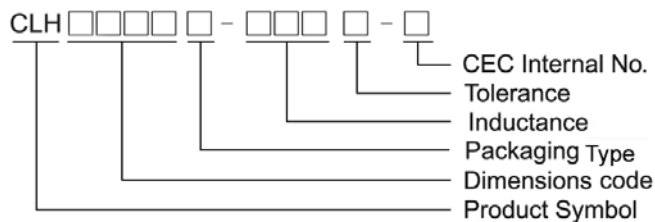

- Packing Type: T: Taping B: Bulk
- Product series identification:

CLH0603-F: Top side half mark.
 CLH1005-S: Top side full mark. CLH1005-H: Top side half mark.
 CLH1608-S: Top side full mark. CLH1608-H: Top side half mark.
 CLH2012-S: White

Shape and Dimensions

CLH0603-F Series
 CLH1005-H Series
 CLH1608-H Series

CLH1005-S Series
 CLH1608-S Series

CLH2012-S Series

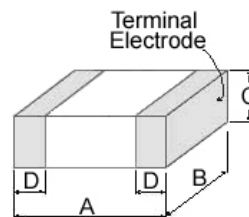
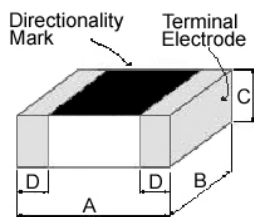
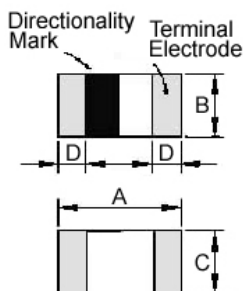

Recommended Pattern

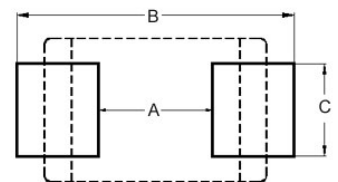

Dimensions in mm

TYPE	A	B	C	D
0603	0.6±0.03	0.3±0.03	0.3±0.03	0.15±0.05
1005	1.0±0.10	0.5±0.10	0.5±0.10	0.25±0.10
1608	1.6±0.15	0.8±0.15	0.8±0.15	0.3±0.2
2012 < 390 nH	2.0±0.2	1.25±0.2	0.9±0.2	0.5±0.3
2012 ≥ 390 nH	2.0±0.2	1.25±0.2	1.2±0.2	0.5±0.3

Dimensions in mm

TYPE	A	B	C
CLH0603	0.3	0.75 ~ 1.05	0.3
CLH1005	0.4	1.2 ~ 1.4	0.5
CLH1608	0.7 ~ 0.8	1.8 ~ 2.0	0.6 ~ 0.8
CLH2012	1.0 ~ 1.2	2.6 ~ 4.0	1.0 ~ 1.2

Electrical Characteristics

Part Number	Inductance (nH) at 100MHz	Tolerance (±%)	Q Min at 100MHz	SRF (MHz) Min	DC Resistance (Ω) Max	Rated Current (mA) Max
CLH0603T-1N0□-F	1.0	±0.3nH	4	>10000	0.11	470
CLH0603T-1N2□-F	1.2	±0.3nH	4	>10000	0.12	450
CLH0603T-1N5□-F	1.5	±0.3nH	4	>10000	0.13	430
CLH0603T-1N8□-F	1.8	±0.3nH	4	>10000	0.16	390
CLH0603T-2N0□-F	2.0	±0.3nH	4	>10000	0.17	380
CLH0603T-2N2□-F	2.2	±0.3nH	4	8800	0.19	360
CLH0603T-2N4□-F	2.4	±0.3nH	4	8300	0.20	350
CLH0603T-2N7□-F	2.7	±0.3nH	4	7700	0.21	340
CLH0603T-3N0□-F	3.0	±0.3nH	4	7200	0.22	330
CLH0603T-3N3□-F	3.3	±0.3nH	4	6700	0.23	320
CLH0603T-3N6□-F	3.6	±0.3nH	4	6400	0.25	310
CLH0603T-3N9□-F	3.9	±0.3nH	4	6000	0.27	300
CLH0603T-4N3□-F	4.3	±0.3nH	4	5700	0.30	280
CLH0603T-4N7□-F	4.7	±0.3nH	4	5300	0.30	280
CLH0603T-5N1□-F	5.1	±0.3nH	4	5000	0.33	270
CLH0603T-5N6□-F	5.6	±0.3nH	4	4600	0.36	260
CLH0603T-6N2□-F	6.2	±0.3nH	4	4200	0.38	250
CLH0603T-6N8□-F	6.8	5	4	3900	0.39	250
CLH0603T-7N5□-F	7.5	5	4	3600	0.41	240
CLH0603T-8N2□-F	8.2	5	4	3400	0.45	230
CLH0603T-9N1□-F	9.1	5	4	3200	0.48	220
CLH0603T-10N□-F	10	5	4	2900	0.51	220
CLH0603T-12N□-F	12	5	4	2700	0.68	190
CLH0603T-15N□-F	15	5	4	2300	0.71	180
CLH0603T-18N□-F	18	5	4	2100	0.81	170
CLH0603T-22N□-F	22	5	4	1800	1.00	150
CLH0603T-27N□-F	27	5	4	1800	1.35	120
CLH0603T-33N□-F	33	5	4	1700	1.47	110
CLH0603T-39N□-F	39	5	4	1500	1.72	100
CLH0603T-47N□-F	47	5	4	1300	1.90	100
CLH0603T-56N□-F	56	5	4	1100	2.27	80
CLH0603T-68N□-F	68	5	4	1100	2.66	80
CLH0603T-82N□-F	82	5	4	1000	3.37	70
CLH0603T-R10□-F	100	5	4	900	3.74	60

- Tolerance : S = ± 0.3 nH ; J = ± 5%
- Test Instruments : L/Q : Agilent E4991A + Fixture : Agilent 16197A
 SRF : Agilent E4991A / HP19196C
 RDC : HP4338B/ CH502BC

Test Instruments : Agilent E4991A Material/Impedance Analyzer

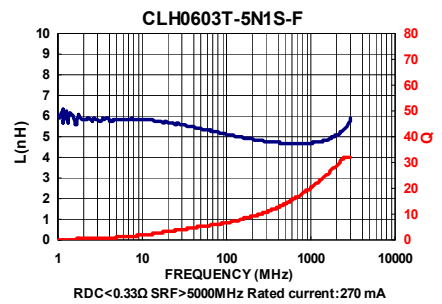
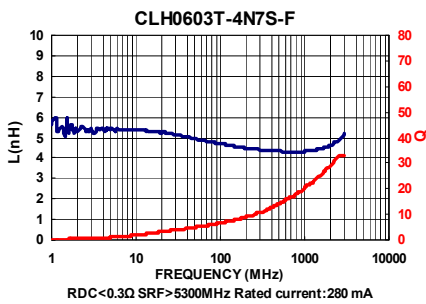
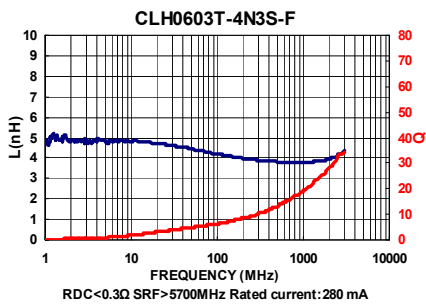
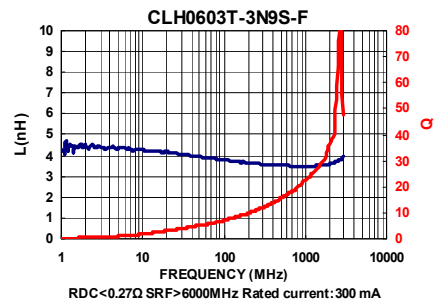
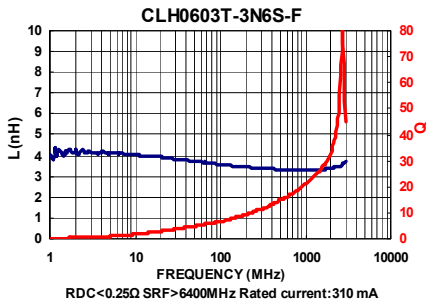
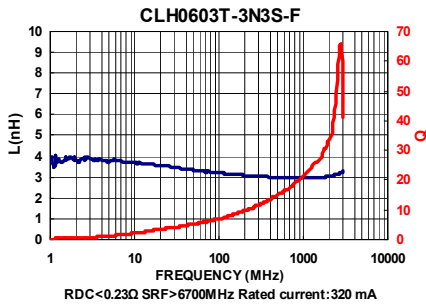
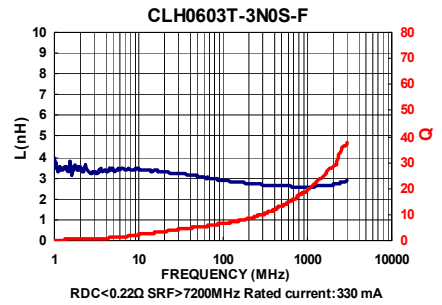
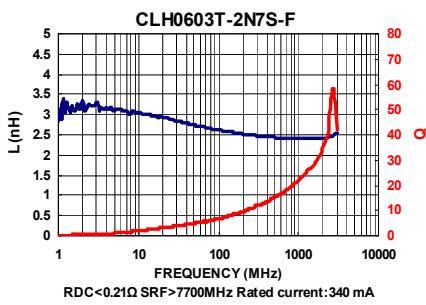
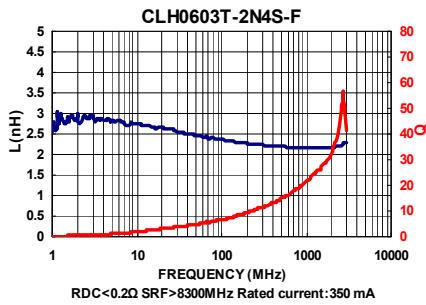
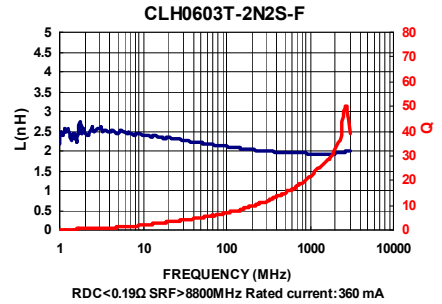
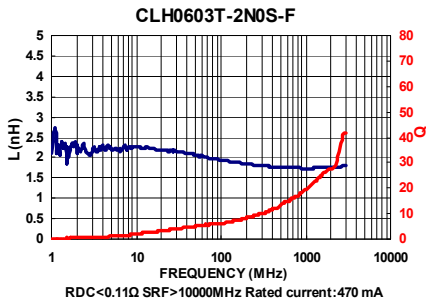
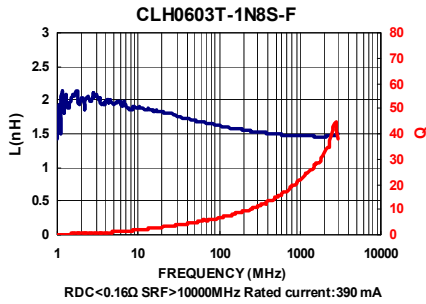
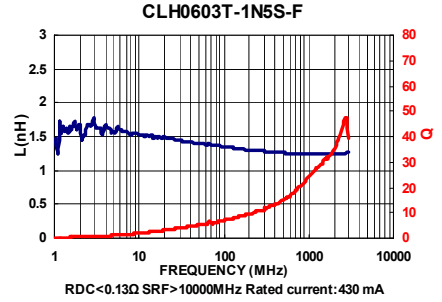
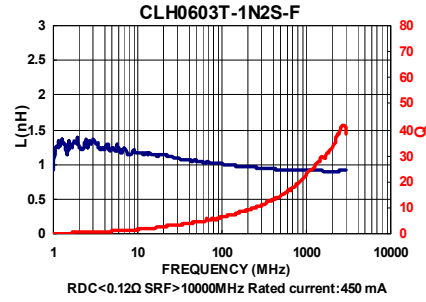
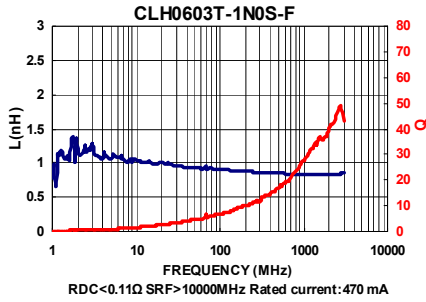

Test Instruments : Agilent E4991A Material/Impedance Analyzer

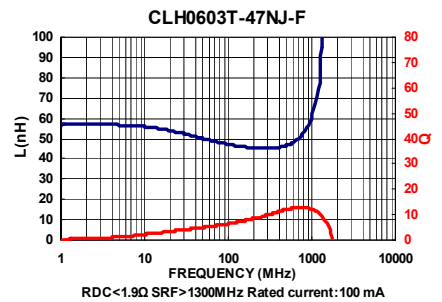
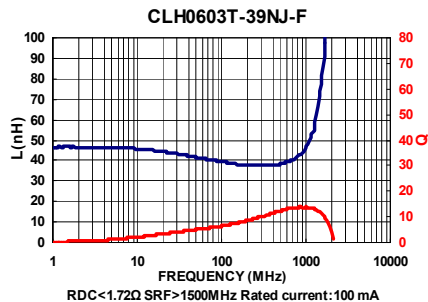
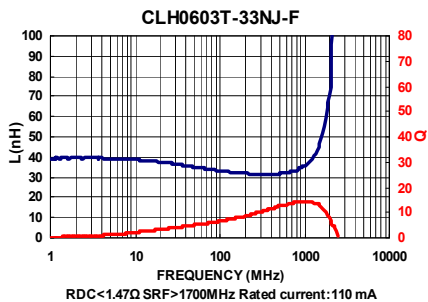
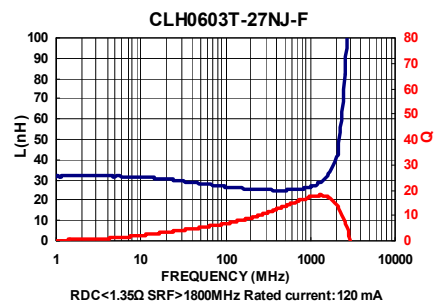
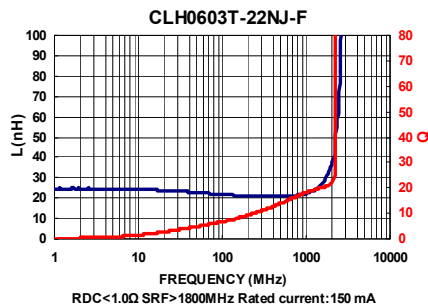
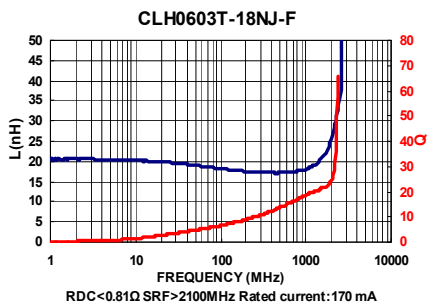
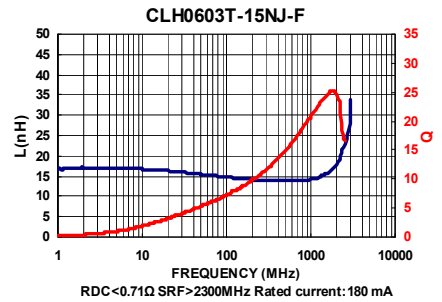
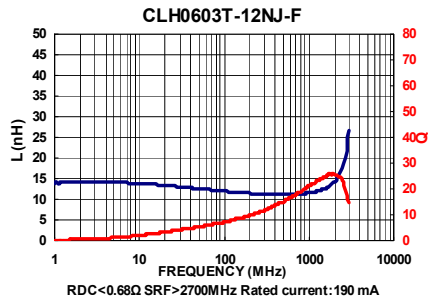
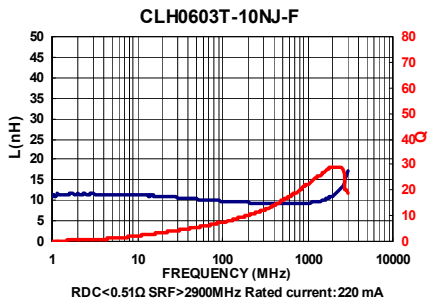
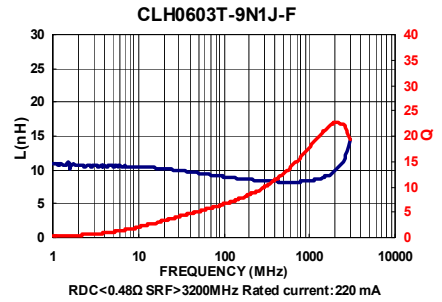
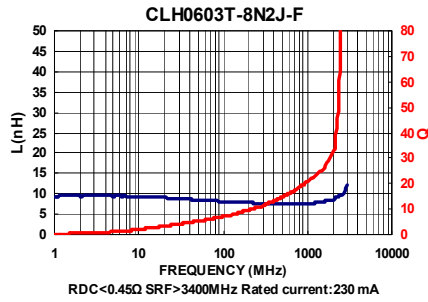
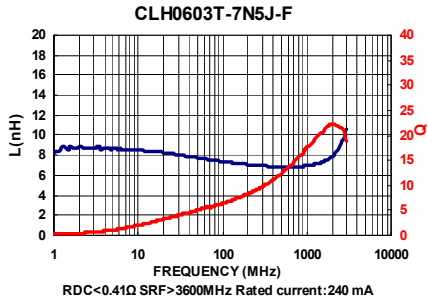
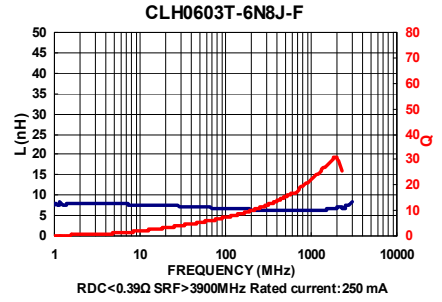
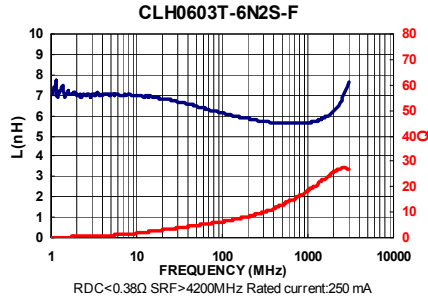
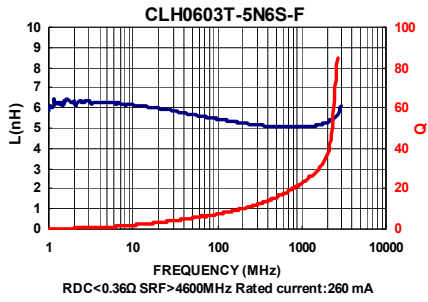

Test Instruments : Agilent E4991A Material/Impedance Analyzer

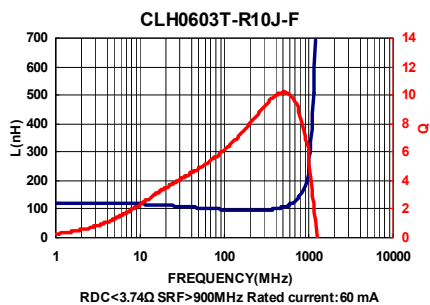
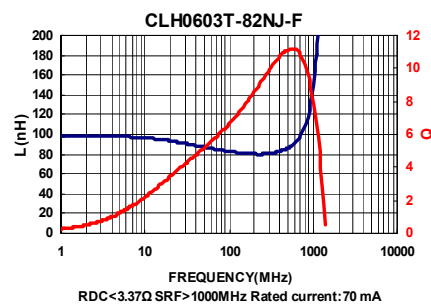
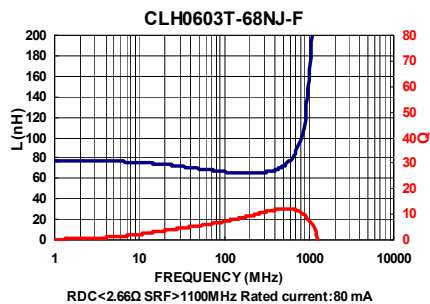
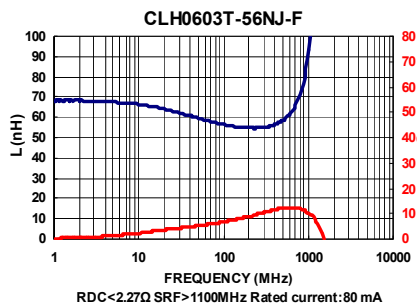

Electrical Characteristics

Part Number	Inductance (nH) at 100MHz	Tolerance (±%)	Q Min at 100MHz	SRF (MHz) Typ.	DC Resistance (Ω) Max	IDC (mA) Max
CLH1005T-1N0□-S	1.0	±0.3nH	8	10000	0.07	400
CLH1005T-1N2□-S	1.2	±0.3nH	8	10000	0.09	400
CLH1005T-1N5□-S	1.5	±0.3nH	8	9000	0.10	400
CLH1005T-1N8□-S	1.8	±0.3nH	8	8700	0.10	400
CLH1005T-2N0□-S	2.0	±0.3nH	8	8100	0.10	400
CLH1005T-2N2□-S	2.2	±0.3nH	8	8100	0.12	400
CLH1005T-2N4□-S	2.4	±0.3nH	8	7700	0.15	400
CLH1005T-2N7□-S	2.7	±0.3nH	8	7700	0.15	400
CLH1005T-3N0□-S	3.0	±0.3nH	8	6300	0.15	400
CLH1005T-3N3□-S	3.3	±0.3nH/10	8	6300	0.15	400
CLH1005T-3N6□-S	3.6	±0.3nH/10	8	6100	0.15	400
CLH1005T-3N9□-S	3.9	±0.3nH/10	8	6100	0.18	400
CLH1005T-4N3□-S	4.3	±0.3nH/10	8	6000	0.18	400
CLH1005T-4N7□-S	4.7	±0.3nH/10	8	6000	0.18	400
CLH1005T-5N6□-S	5.6	±0.3nH/10	8	5100	0.20	400
CLH1005T-6N8□-S	6.8	5 / 10	8	4550	0.24	400
CLH1005T-8N2□-S	8.2	5 / 10	8	4100	0.24	300
CLH1005T-10N□-S	10	5 / 10	8	3900	0.26	300
CLH1005T-12N□-S	12	5 / 10	8	3000	0.40	300
CLH1005T-15N□-S	15	5 / 10	8	2800	0.50	300
CLH1005T-18N□-S	18	5 / 10	8	2500	0.55	300
CLH1005T-22N□-S	22	5 / 10	8	2200	0.70	300
CLH1005T-27N□-S	27	5 / 10	8	2000	0.80	300
CLH1005T-33N□-S	33	5 / 10	8	1800	0.9	200
CLH1005T-39N□-S	39	5 / 10	8	1600	1.0	150
CLH1005T-47N□-S	47	5 / 10	8	1400	1.2	150
CLH1005T-56N□-S	56	5 / 10	8	1300	1.3	150
CLH1005T-68N□-S	68	5 / 10	8	1100	1.5	100
CLH1005T-82N□-S	82	5 / 10	8	1000	1.6	100
CLH1005T-R10□-S	100	5 / 10	8	900	2.0	100

- Tolerance : S = ± 0.3nH , J = ± 5% , K = ± 10%
- Test Instruments : L/Q : Agilent E4991A + Fixture : Agilent 16197A
SRF : HP8753D
RDC : HP4338B/ CH502BC

Test Instruments : Agilent E4991A Material/Impedance Analyzer

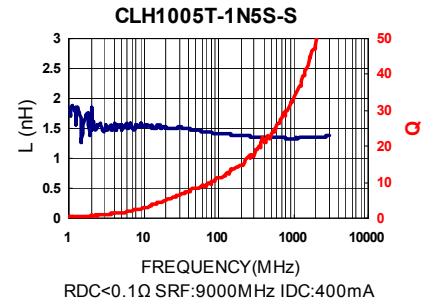
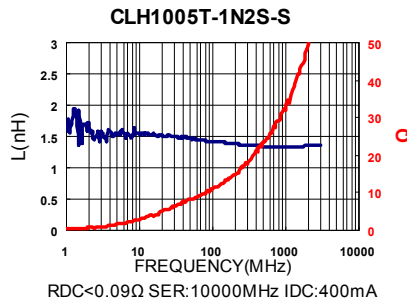
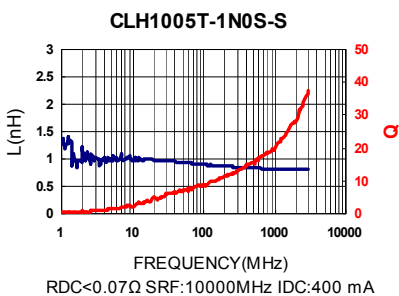

Test Instruments : Agilent E4991A Material/Impedance Analyzer

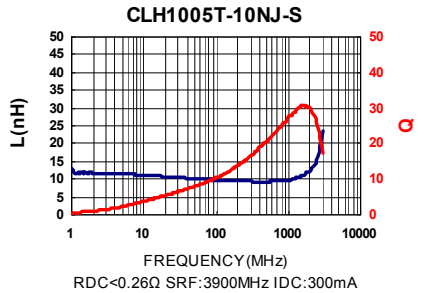
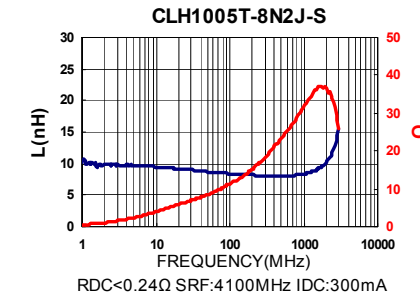
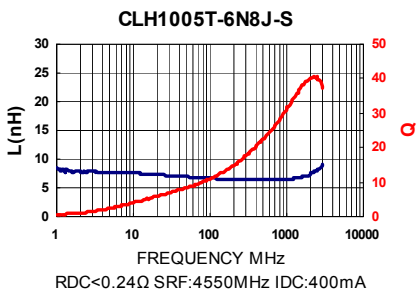
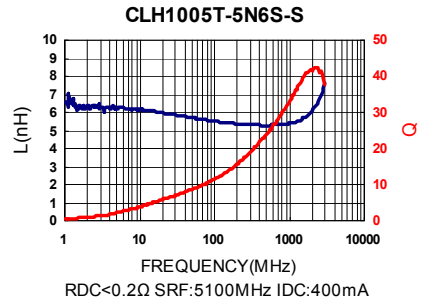
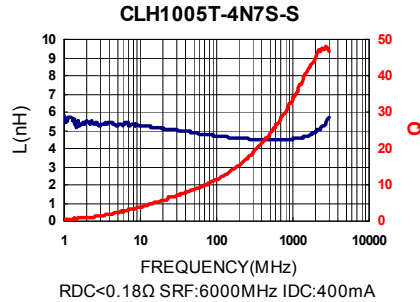
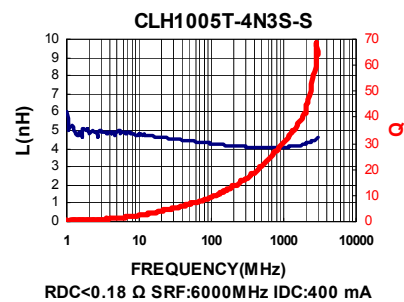
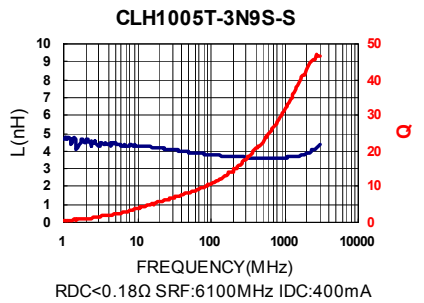
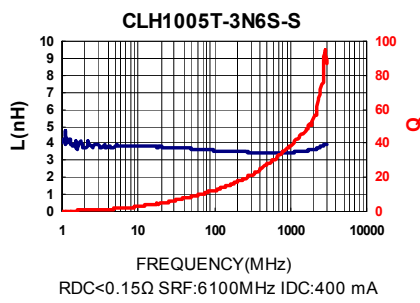
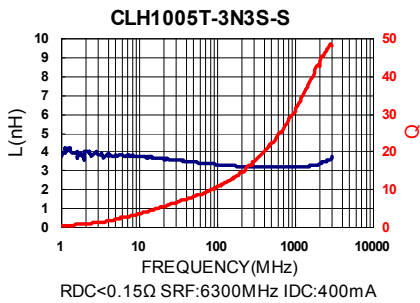
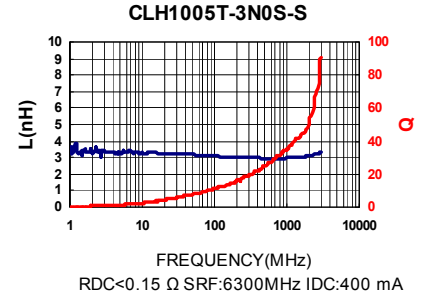
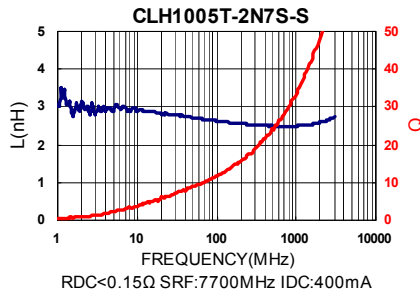
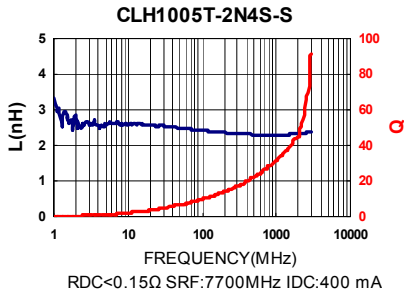
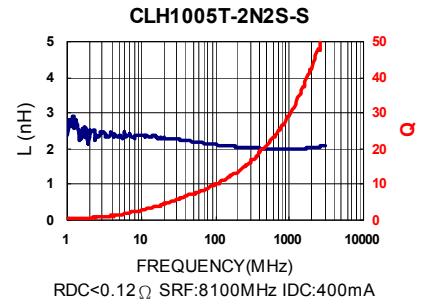
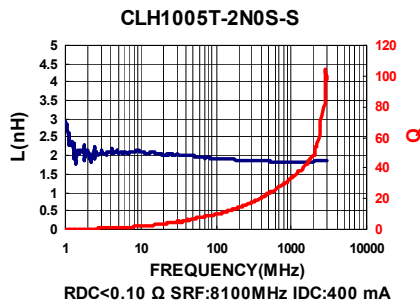
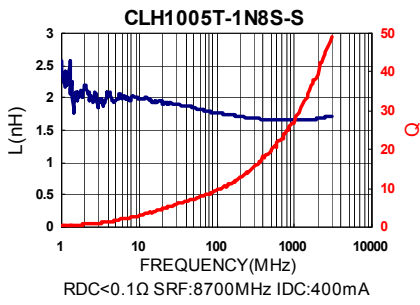

Test Instruments : Agilent E4991A Material/Impedance Analyzer

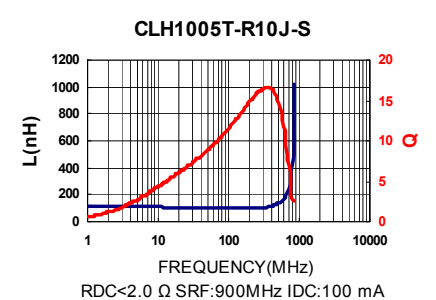
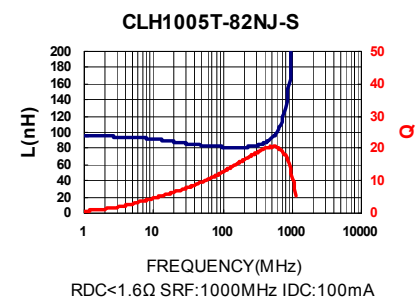
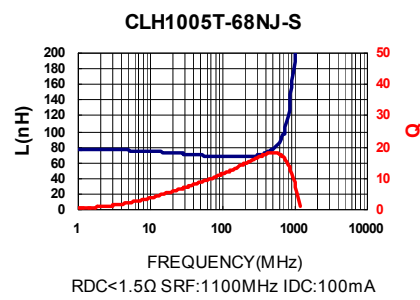
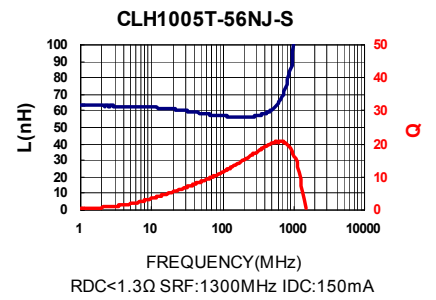
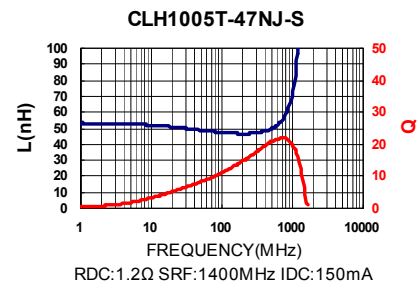
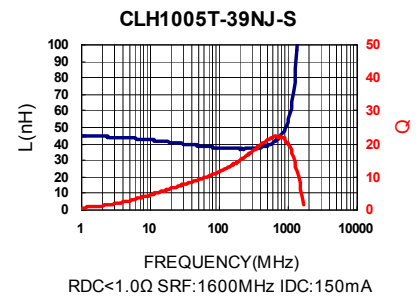
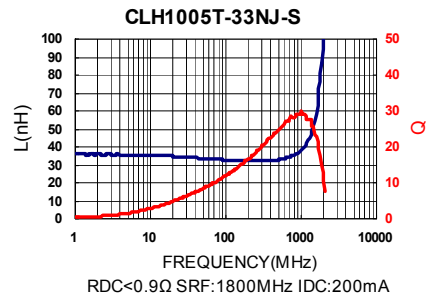
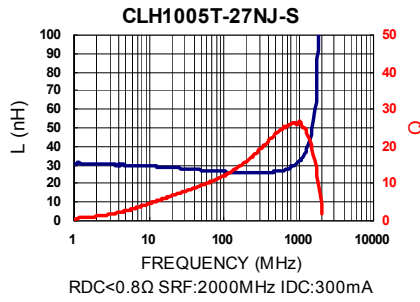
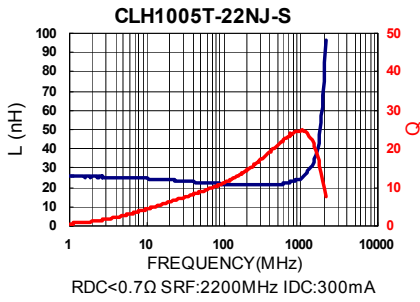
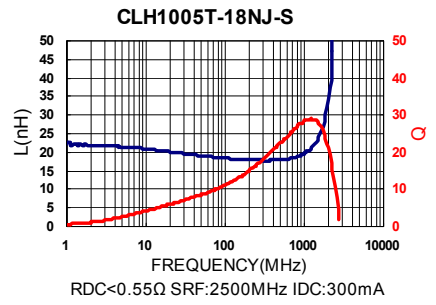
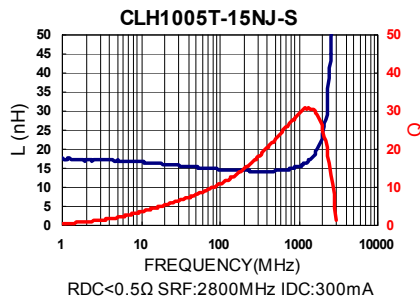
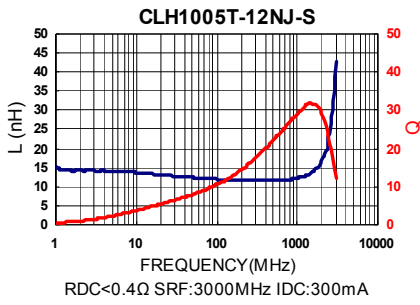

Electrical Characteristics

Part Number	Inductance (nH) at 100MHz	Tolerance (±%)	Q Min at 100MHz	SRF (MHz) Typ.	DC Resistance (Ω) Max	IDC (mA) Max
CLH1005T-1N0□-H	1.0	±0.3nH	8	10000	0.07	400
CLH1005T-1N2□-H	1.2	±0.3nH	8	10000	0.09	400
CLH1005T-1N5□-H	1.5	±0.3nH	8	9000	0.10	400
CLH1005T-1N8□-H	1.8	±0.3nH	8	8700	0.10	400
CLH1005T-2N2□-H	2.2	±0.3nH	8	8100	0.12	400
CLH1005T-2N7□-H	2.7	±0.3nH	8	7700	0.15	400
CLH1005T-3N0□-H	3.0	±0.3nH	8	6300	0.15	400
CLH1005T-3N3□-H	3.3	±0.3nH/10	8	6300	0.15	400
CLH1005T-3N9□-H	3.9	±0.3nH/10	8	6100	0.18	400
CLH1005T-4N7□-H	4.7	±0.3nH/10	8	6000	0.18	400
CLH1005T-5N6□-H	5.6	±0.3nH/10	8	5100	0.20	400
CLH1005T-6N8□-H	6.8	5 / 10	8	4550	0.24	400
CLH1005T-8N2□-H	8.2	5 / 10	8	4100	0.24	300
CLH1005T-10N□-H	10	5 / 10	8	3900	0.26	300
CLH1005T-12N□-H	12	5 / 10	8	3000	0.40	300
CLH1005T-15N□-H	15	5 / 10	8	2800	0.50	300
CLH1005T-18N□-H	18	5 / 10	8	2500	0.55	300
CLH1005T-22N□-H	22	5 / 10	8	2200	0.70	300
CLH1005T-27N□-H	27	5 / 10	8	2000	0.80	300
CLH1005T-33N□-H	33	5 / 10	8	1800	0.9	200
CLH1005T-39N□-H	39	5 / 10	8	1600	1.0	150
CLH1005T-47N□-H	47	5 / 10	8	1400	1.2	150
CLH1005T-56N□-H	56	5 / 10	8	1300	1.3	150
CLH1005T-68N□-H	68	5 / 10	8	1100	1.5	100
CLH1005T-82N□-H	82	5 / 10	8	1000	1.6	100
CLH1005T-R10□-H	100	5 / 10	8	900	2.0	100
CLH1005T-R12□-H	120	5 / 10	8	800	2.2	100
CLH1005T-R15□-H	150	5 / 10	8	700	3.5	100
CLH1005T-R18□-H	180	5 / 10	8	600	3.8	100
CLH1005T-R22□-H	220	5 / 10	8	500	4.2	100
CLH1005T-R27□-H	270	5 / 10	8	500	4.8	100

- Tolerance : S = ± 0.3nH , J = ± 5% , K = ± 10%
- Test Instruments : L/Q : Agilent E4991A + Fixture : Agilent 16197A
SRF : HP8753D
RDC : HP4338B/ CH502BC

Test Instruments : Agilent E4991A Material/Impedance Analyzer

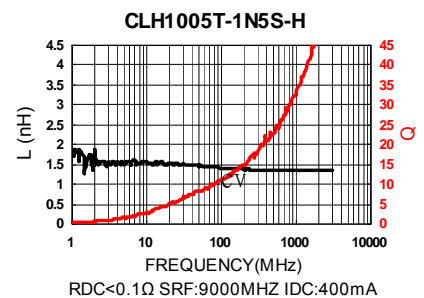
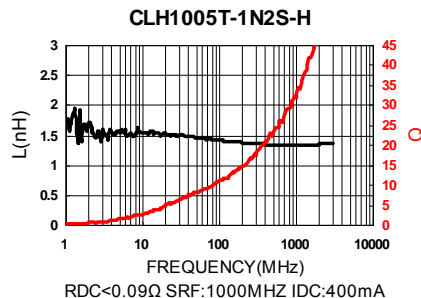
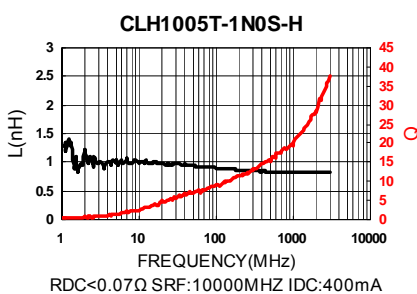

Test Instruments : Agilent E4991A Material/Impedance Analyzer

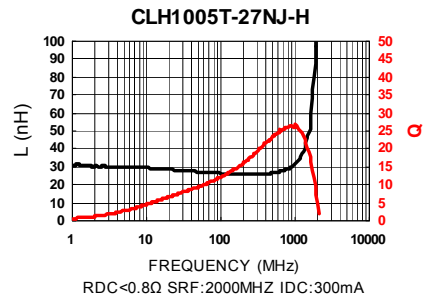
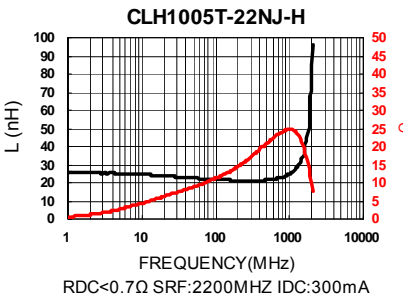
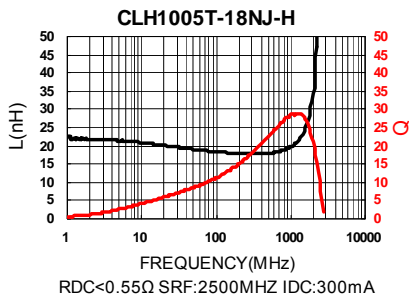
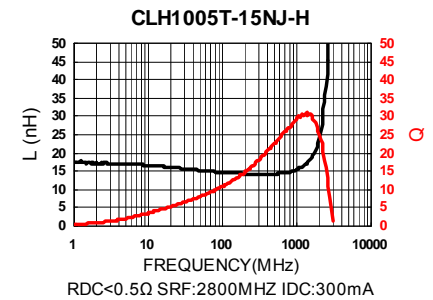
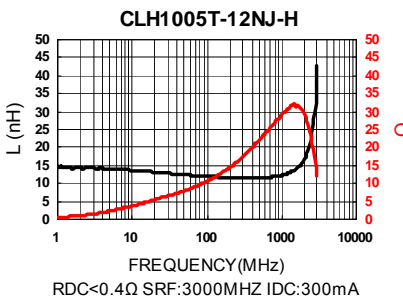
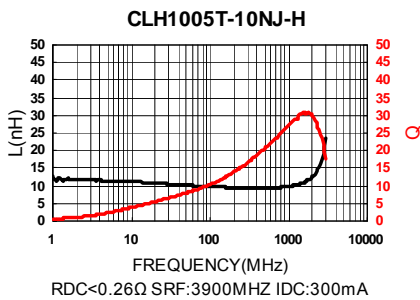
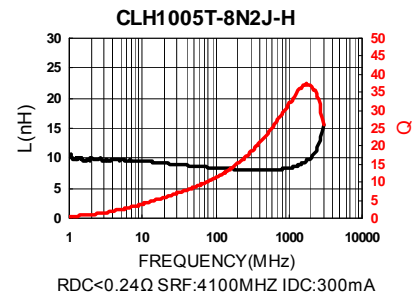
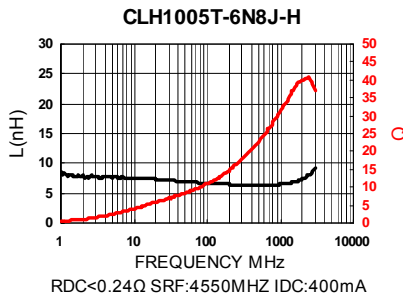
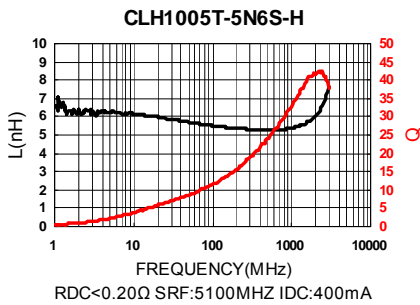
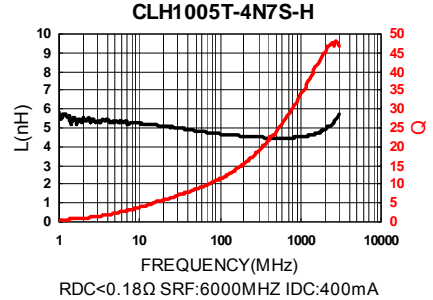
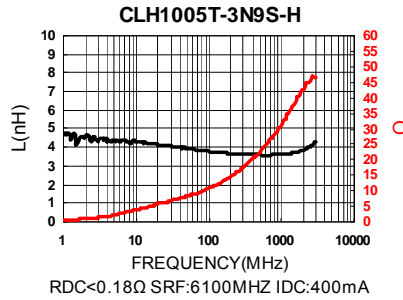
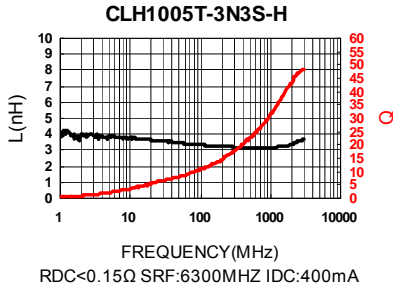
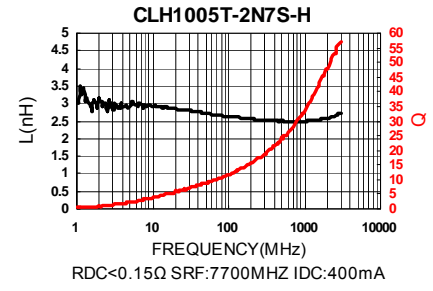
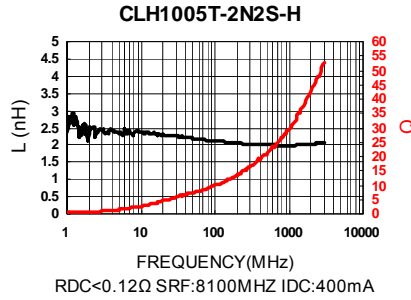
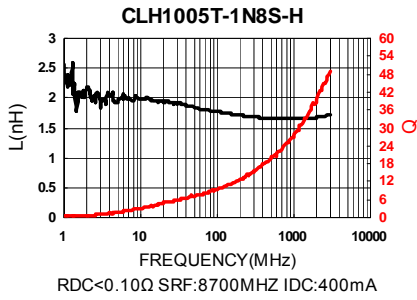

Test Instruments : Agilent E4991A Material/Impedance Analyzer

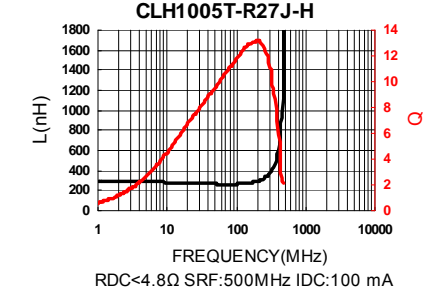
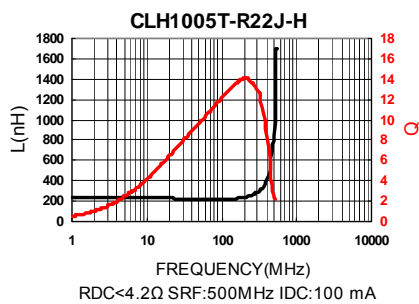
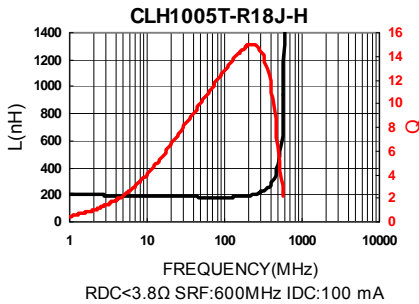
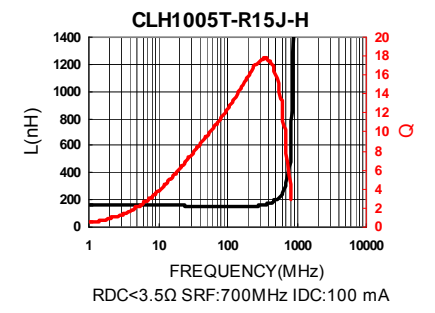
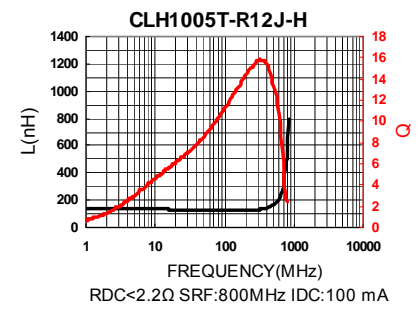
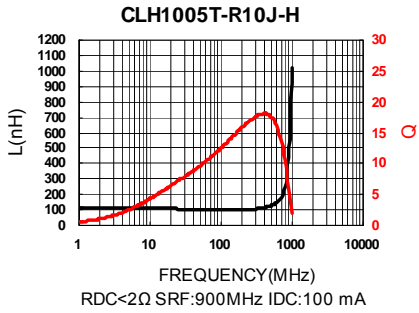
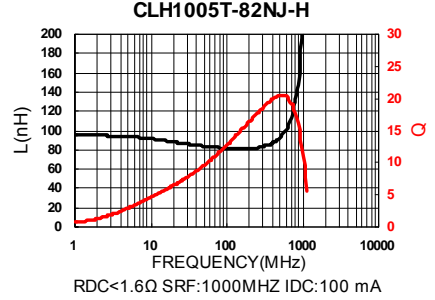
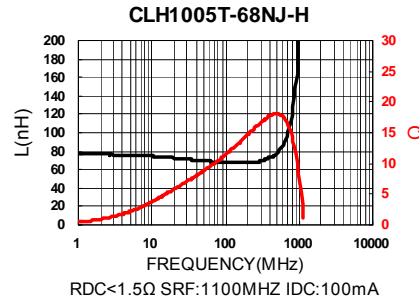
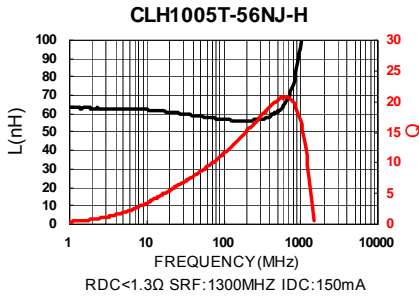
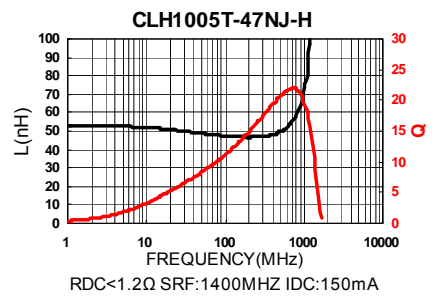
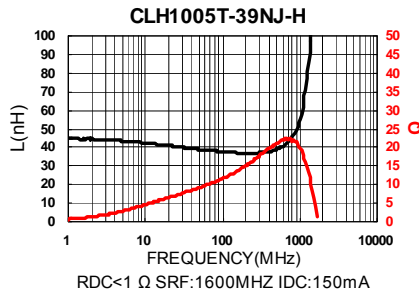
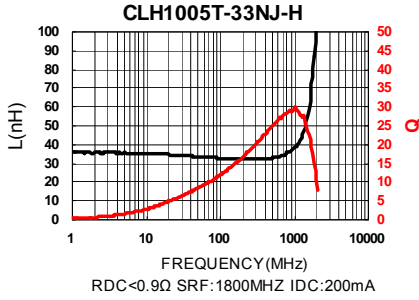

Electrical Characteristics

Part Number	Inductance (nH) at 100MHz	Tolerance (±%)	Q Min at 100MHz	SRF (MHz) Typ.	DC Resistance (Ω) Max	Rated Current (mA) Max
CLH1005T-1N0□-S-NP	1.0	±0.3nH	8	10000	0.07	400
CLH1005T-1N2□-S-NP	1.2	±0.3nH	8	10000	0.09	400
CLH1005T-1N5□-S-NP	1.5	±0.3nH	8	9000	0.10	400
CLH1005T-1N8□-S-NP	1.8	±0.3nH	8	8700	0.10	400
CLH1005T-2N0□-S-NP	2.0	±0.3nH	8	8100	0.10	400
CLH1005T-2N2□-S-NP	2.2	±0.3nH	8	8100	0.12	400
CLH1005T-2N4□-S-NP	2.4	±0.3nH	8	7700	0.15	400
CLH1005T-2N7□-S-NP	2.7	±0.3nH	8	7700	0.15	400
CLH1005T-3N0□-S-NP	3.0	±0.3nH	8	6300	0.15	400
CLH1005T-3N3□-S-NP	3.3	±0.3nH	8	6300	0.15	400
CLH1005T-3N6□-S-NP	3.6	±0.3nH	8	6100	0.15	400
CLH1005T-3N9□-S-NP	3.9	±0.3nH	8	6100	0.18	400
CLH1005T-4N3□-S-NP	4.3	±0.3nH	8	6000	0.18	400
CLH1005T-4N7□-S-NP	4.7	±0.3nH	8	6000	0.18	400
CLH1005T-5N1□-S-NP	5.1	±0.3nH	8	5300	0.20	400
CLH1005T-5N6□-S-NP	5.6	±0.3nH	8	5100	0.20	400
CLH1005T-6N2□-S-NP	6.2	±0.3nH/5/10	8	4500	0.22	400
CLH1005T-6N8□-S-NP	6.8	5 / 10	8	4550	0.24	400
CLH1005T-7N5□-S-NP	7.5	5 / 10	8	4200	0.24	300
CLH1005T-8N2□-S-NP	8.2	5 / 10	8	4100	0.24	300
CLH1005T-9N1□-S-NP	9.1	5 / 10	8	3900	0.26	300
CLH1005T-10N□-S-NP	10	5 / 10	8	3900	0.26	300
CLH1005T-12N□-S-NP	12	5 / 10	8	3000	0.28	300
CLH1005T-15N□-S-NP	15	5 / 10	8	2500	0.32	300
CLH1005T-18N□-S-NP	18	5 / 10	8	2200	0.36	300
CLH1005T-22N□-S-NP	22	5 / 10	8	1900	0.42	300
CLH1005T-27N□-S-NP	27	5 / 10	8	1700	0.46	300
CLH1005T-33N□-S-NP	33	5 / 10	8	1600	0.58	200
CLH1005T-39N□-S-NP	39	5 / 10	8	1200	0.65	200
CLH1005T-47N□-S-NP	47	5 / 10	8	1000	0.72	200
CLH1005T-56N□-S-NP	56	5 / 10	8	800	0.82	200
CLH1005T-68N□-S-NP	68	5 / 10	8	800	0.92	180
CLH1005T-82N□-S-NP	82	5 / 10	8	700	1.20	150

● Tolerance : S = ± 0.3nH , J = ± 5% , K = ± 10%

● Test Instruments : L/Q : Agilent E4991A + Fixture : Agilent 16197A
 SRF : HP8753D
 RDC : HP4338B/ CH502BC

Test Instruments : Agilent E4991A Material/Impedance Analyzer

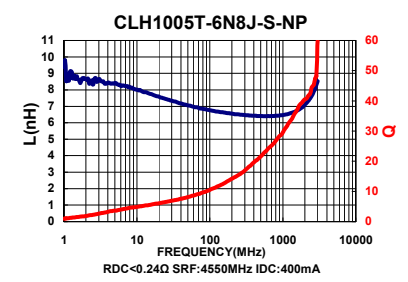
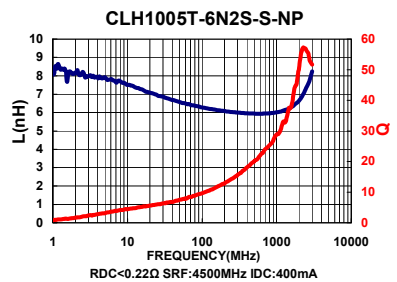
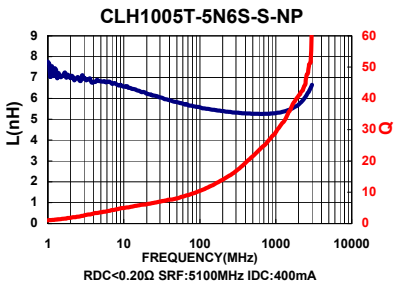
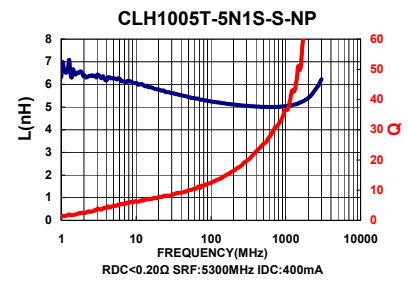
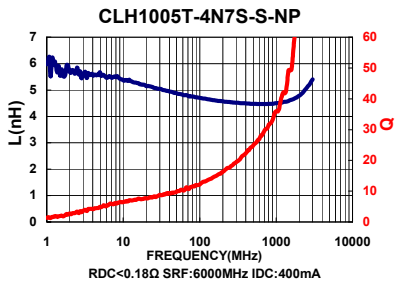
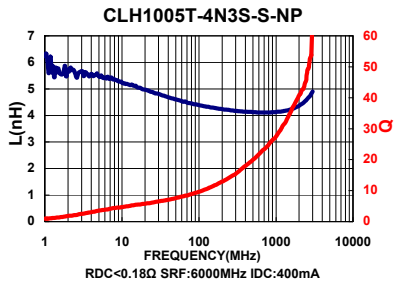
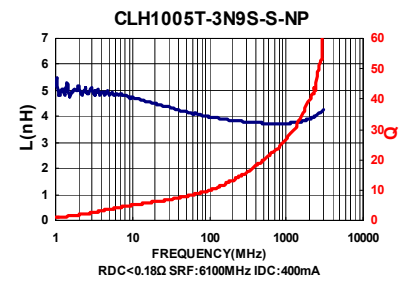
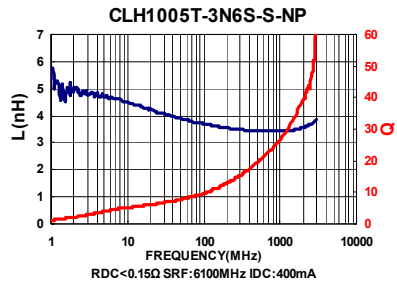
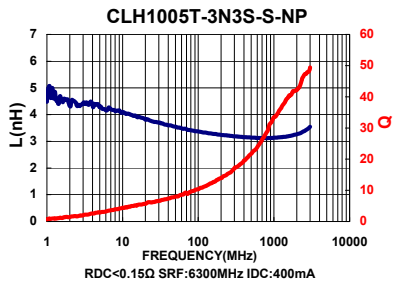
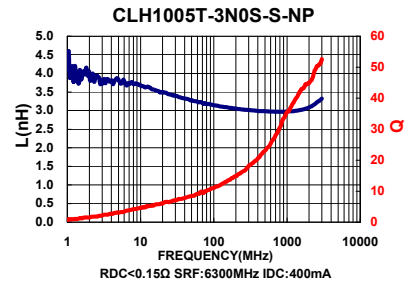
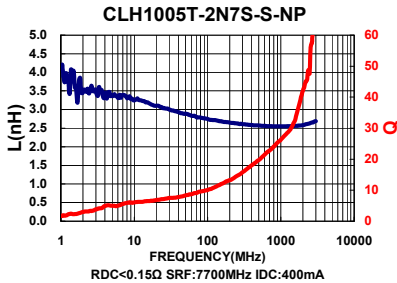
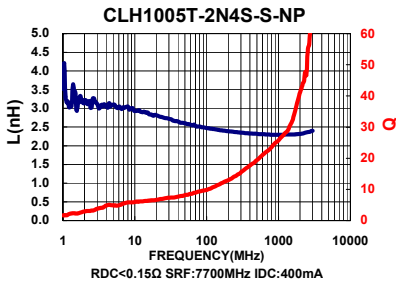
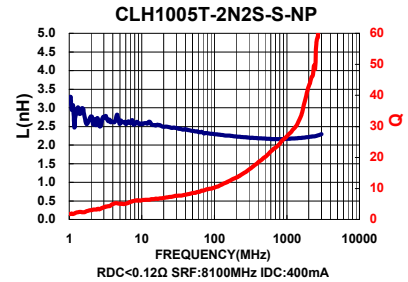
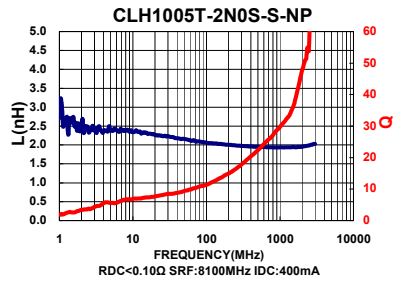
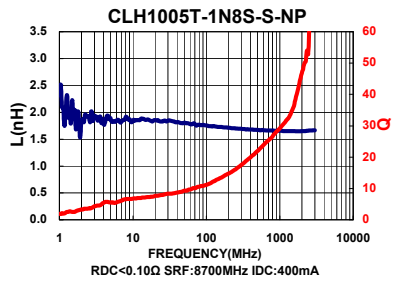
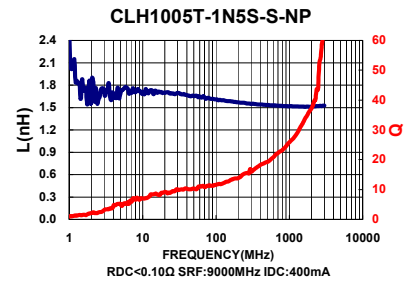
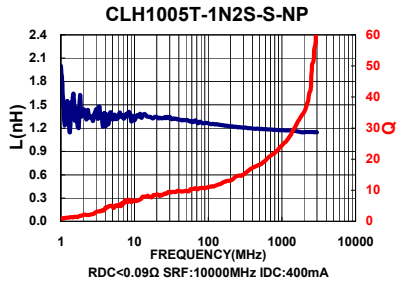
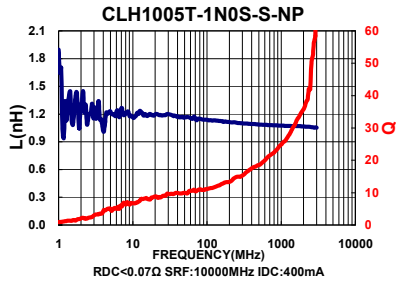

Test Instruments : Agilent E4991A Material/Impedance Analyzer

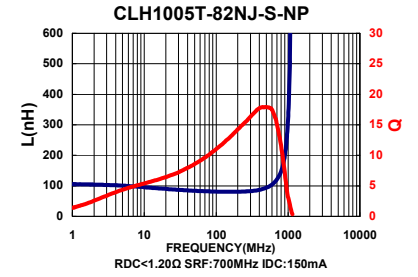
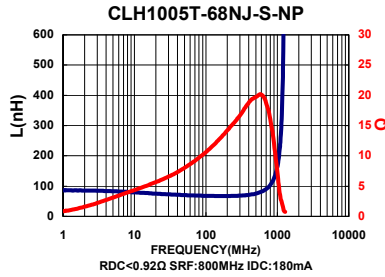
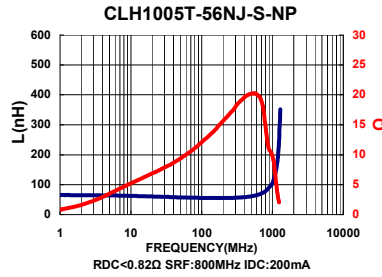
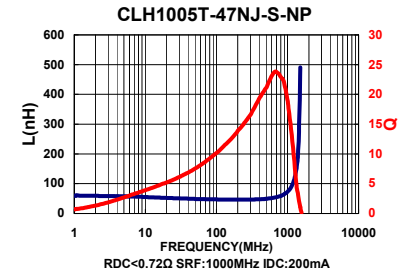
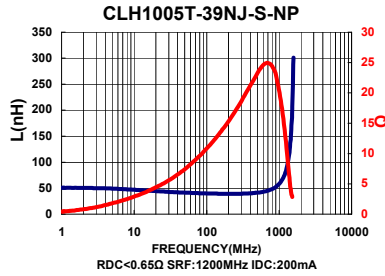
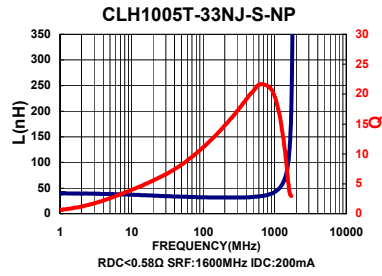
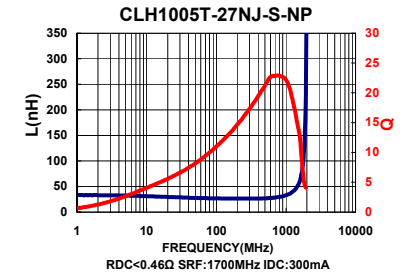
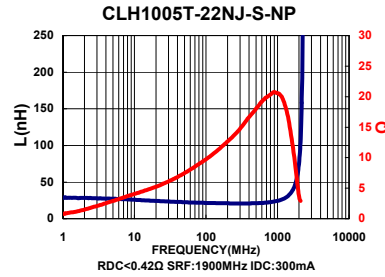
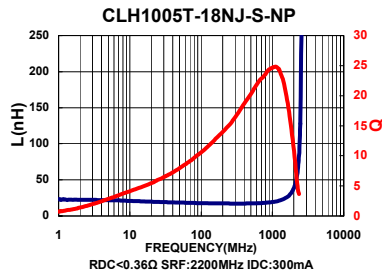
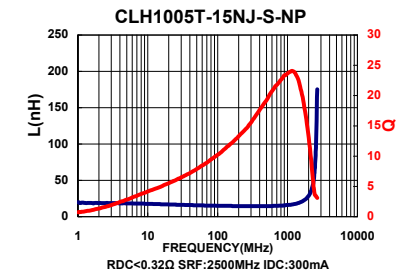
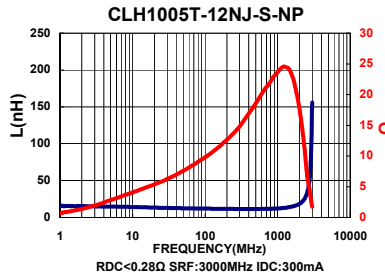
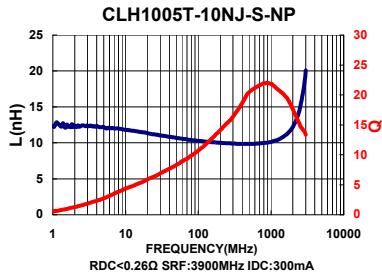
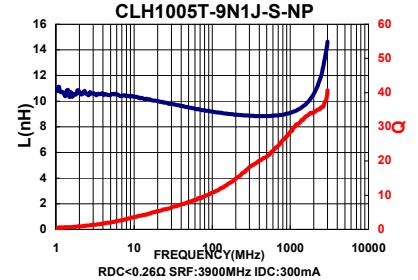
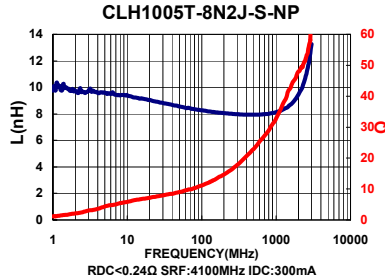
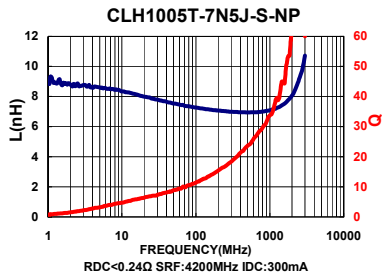

Electrical Characteristics

Part Number	Inductance (nH) at 100MHz	Tolerance (±%)	Q Min		SRF (MHz) Typ.	DC Resistance (Ω) Max	IDC (mA) Max
			at 50MHz	at 100MHz			
CLH1608T-1N0S-S	1.0	±0.3nH		8	10000	0.10	600
CLH1608T-1N2S-S	1.2	±0.3nH		8	10000	0.10	600
CLH1608T-1N5S-S	1.5	±0.3nH		8	8000	0.10	600
CLH1608T-1N8S-S	1.8	±0.3nH		8	8000	0.10	600
CLH1608T-2N2S-S	2.2	±0.3nH		8	7200	0.10	600
CLH1608T-2N7S-S	2.7	±0.3nH		10	6200	0.10	600
CLH1608T-3N3□-S	3.3	±0.3nH/10		10	5200	0.12	600
CLH1608T-3N9□-S	3.9	±0.3nH/10		10	5000	0.14	600
CLH1608T-4N7□-S	4.7	±0.3nH /10		10	4750	0.16	600
CLH1608T-5N6□-S	5.6	±0.3nH/10		10	4100	0.18	600
CLH1608T-6N8□-S	6.8	5 / 10		10	3750	0.22	600
CLH1608T-8N2□-S	8.2	5 / 10		10	3300	0.24	600
CLH1608T-10N□-S	10	5 / 10		12	3000	0.26	600
CLH1608T-12N□-S	12	5 / 10		12	2600	0.28	600
CLH1608T-15N□-S	15	5 / 10		12	2500	0.32	600
CLH1608T-18N□-S	18	5 / 10		12	2400	0.35	600
CLH1608T-22N□-S	22	5 / 10		12	2000	0.40	500
CLH1608T-27N□-S	27	5 / 10		12	1900	0.45	500
CLH1608T-33N□-S	33	5 / 10		12	1600	0.55	400
CLH1608T-39N□-S	39	5 / 10		12	1400	0.60	400
CLH1608T-47N□-S	47	5 / 10		12	1300	0.70	400
CLH1608T-56N□-S	56	5 / 10		12	1100	0.75	400
CLH1608T-62N□-S	62	5 / 10		12	1050	0.85	400
CLH1608T-68N□-S	68	5 / 10		12	1050	0.85	400
CLH1608T-82N□-S	82	5 / 10		12	900	1.00	300
CLH1608T-R10□-S	100	5 / 10		12	770	1.20	300
CLH1608T-R12□-S	*120	5 / 10	8		650	1.30	300
CLH1608T-R15□-S	*150	5 / 10	8		550	1.70	250
CLH1608T-R18□-S	*180	5 / 10	8		520	1.90	250
CLH1608T-R22□-S	*220	5 / 10	8		500	2.00	250
CLH1608T-R27□-S	*270	5 / 10	8		470	2.20	150
CLH1608T-R33□-S	*330	5 / 10	8		320	2.80	100
CLH1608T-R39□-S	*390	5 / 10	8		300	3.00	100

- * at 50MHz
- Tolerance : S = ± 0.3 nH ; J = ± 5% ; K = ± 10%
- Test Instruments : L/Q : L/Q : Agilent E4991A + Fixture : Agilent 16197A
SRF : HP8753D
RDC : HP4338B/ CH502BC

Test Instruments : Agilent E4991A Material/Impedance Analyzer

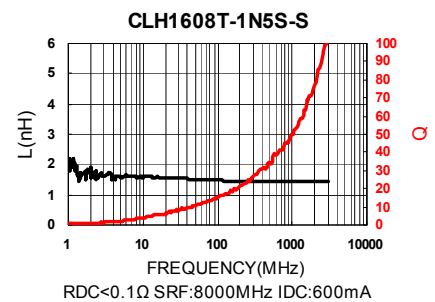
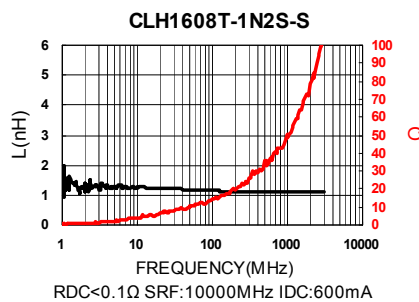
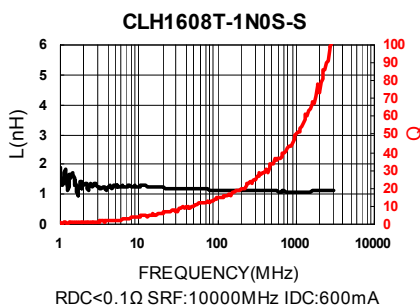

Test Instruments : Agilent E4991A Material/Impedance Analyzer

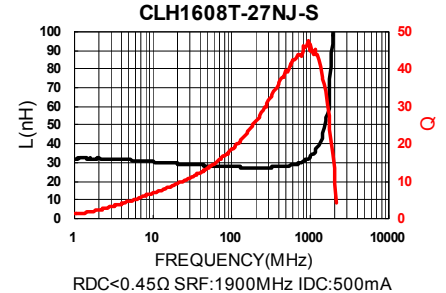
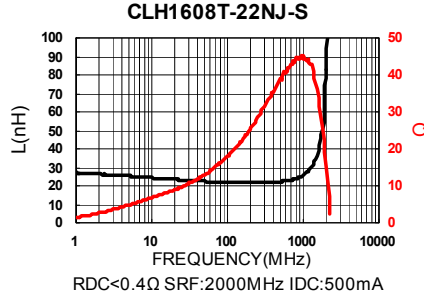
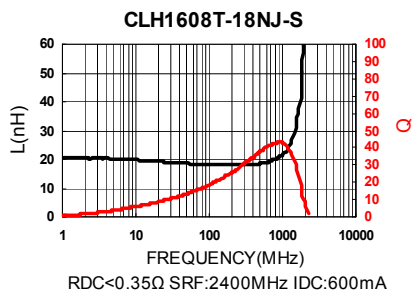
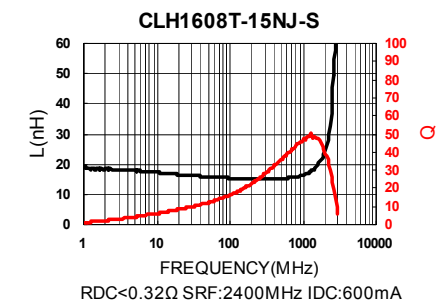
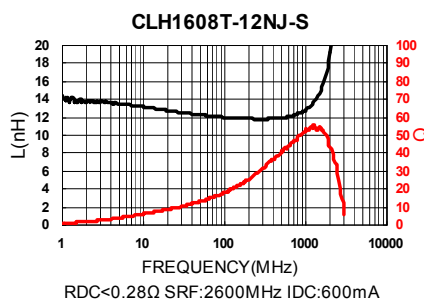
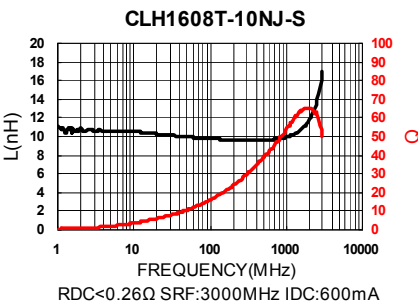
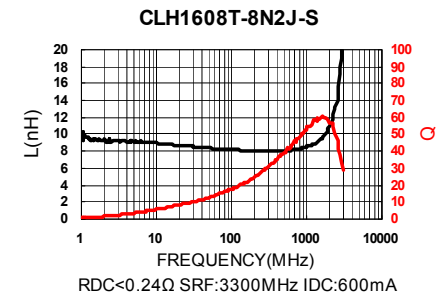
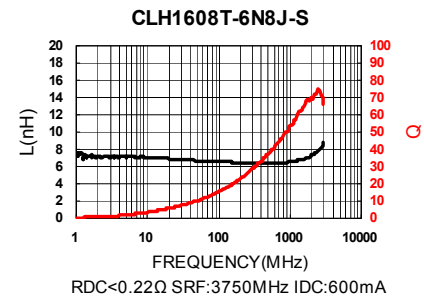
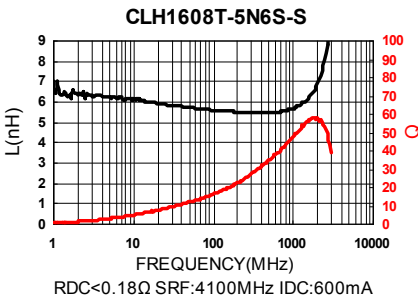
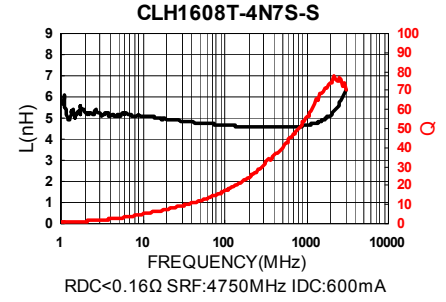
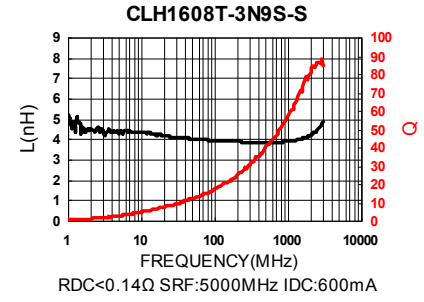
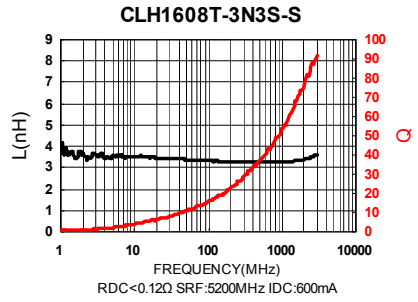
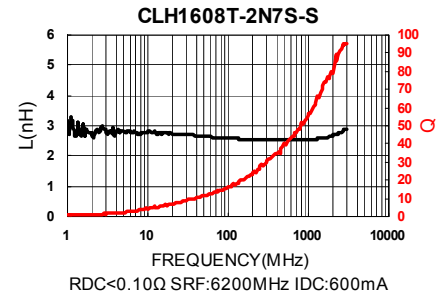
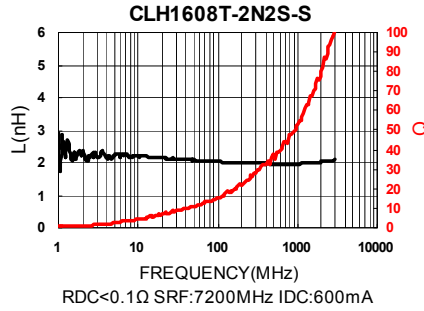
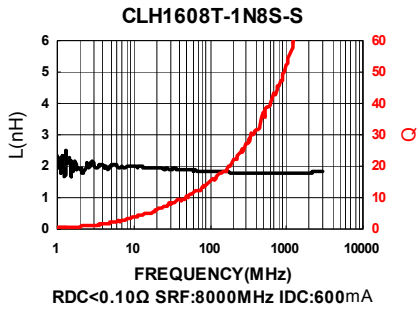

Test Instruments : Agilent E4991A Material/Impedance Analyzer

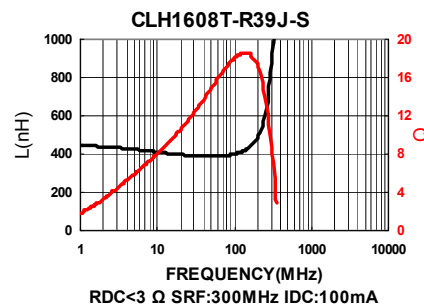
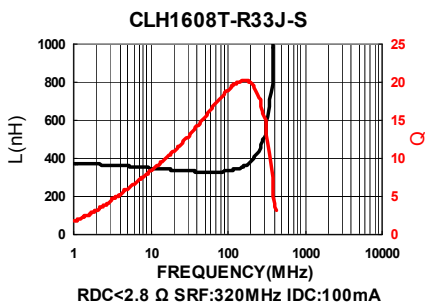
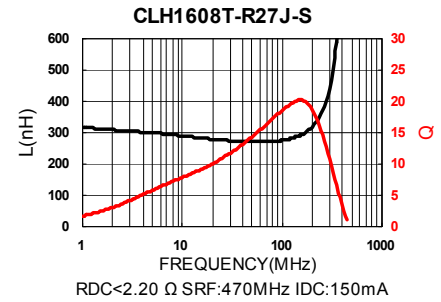
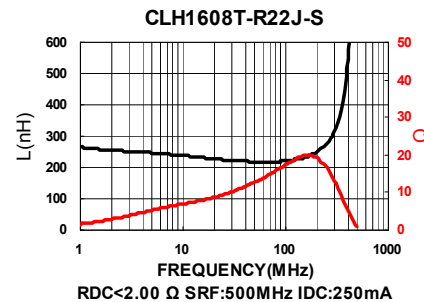
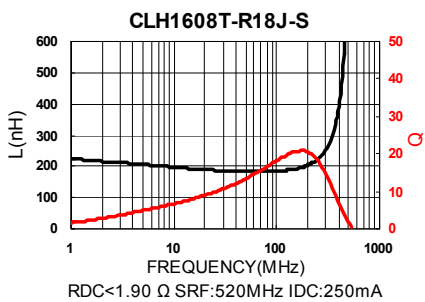
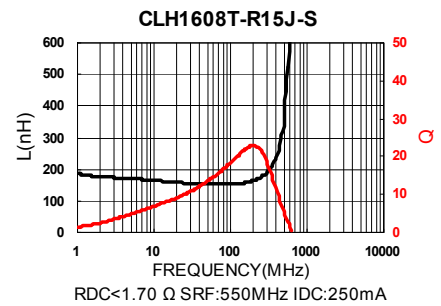
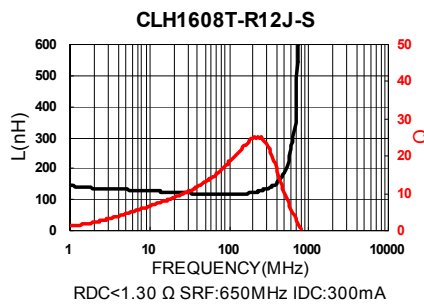
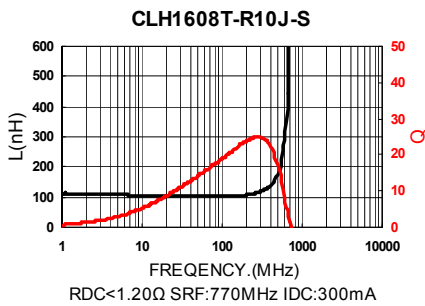
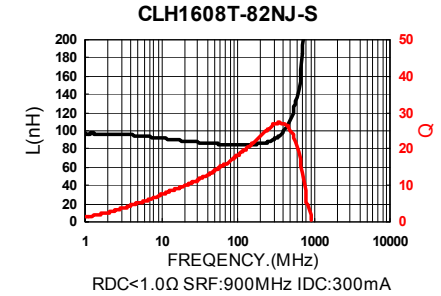
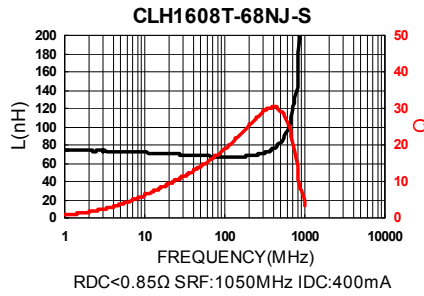
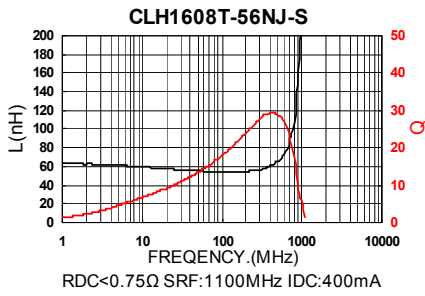
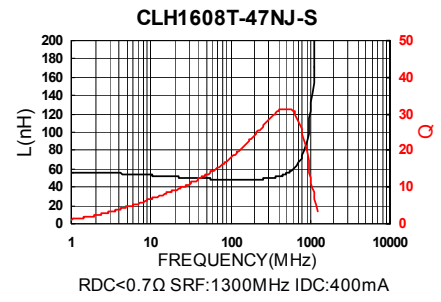
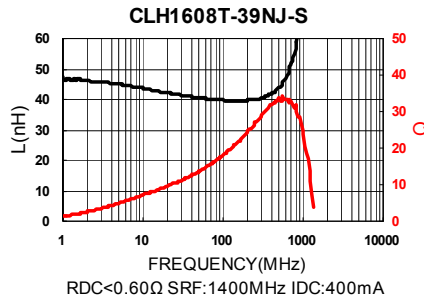
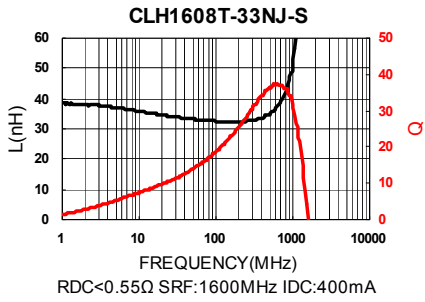

Electrical Characteristics

Part Number	Inductance (nH) at 100MHz	Tolerance (±%)	Q Min		SRF (MHz) Typ.	DC Resistance (Ω) Max	IDC (mA) Max
			at 50MHz	at 100MHz			
CLH1608T-1N0S-H	1.0	±0.3nH		8	10000	0.10	600
CLH1608T-1N2S-H	1.2	±0.3nH		8	10000	0.10	600
CLH1608T-1N5S-H	1.5	±0.3nH		8	8000	0.10	600
CLH1608T-1N8S-H	1.8	±0.3nH		8	8000	0.10	600
CLH1608T-2N2S-H	2.2	±0.3nH		8	7200	0.10	600
CLH1608T-2N7S-H	2.7	±0.3nH		10	6200	0.10	600
CLH1608T-3N3□-H	3.3	±0.3nH/10		10	5200	0.12	600
CLH1608T-3N9□-H	3.9	±0.3nH/10		10	5000	0.14	600
CLH1608T-4N7□-H	4.7	±0.3nH/10		10	4750	0.16	600
CLH1608T-5N6□-H	5.6	±0.3nH/10		10	4100	0.18	600
CLH1608T-6N8□-H	6.8	5 / 10		10	3750	0.22	600
CLH1608T-8N2□-H	8.2	5 / 10		10	3300	0.24	600
CLH1608T-10N□-H	10	5 / 10		12	3000	0.26	600
CLH1608T-12N□-H	12	5 / 10		12	2600	0.28	600
CLH1608T-15N□-H	15	5 / 10		12	2500	0.32	600
CLH1608T-18N□-H	18	5 / 10		12	2400	0.35	600
CLH1608T-22N□-H	22	5 / 10		12	2000	0.40	500
CLH1608T-27N□-H	27	5 / 10		12	1900	0.45	500
CLH1608T-33N□-H	33	5 / 10		12	1600	0.55	400
CLH1608T-39N□-H	39	5 / 10		12	1400	0.60	400
CLH1608T-47N□-H	47	5 / 10		12	1300	0.70	400
CLH1608T-56N□-H	56	5 / 10		12	1100	0.75	400
CLH1608T-62N□-H	62	5 / 10		12	1050	0.85	400
CLH1608T-68N□-H	68	5 / 10		12	1050	0.85	400
CLH1608T-82N□-H	82	5 / 10		12	900	1.00	300
CLH1608T-R10□-H	100	5 / 10		12	770	1.20	300
CLH1608T-R12□-H	*120	5 / 10	8		650	1.30	300
CLH1608T-R15□-H	*150	5 / 10	8		550	1.70	250
CLH1608T-R18□-H	*180	5 / 10	8		520	1.90	250
CLH1608T-R22□-H	*220	5 / 10	8		500	2.00	250
CLH1608T-R27□-H	*270	5 / 10	8		470	2.20	150
CLH1608T-R33□-H	*330	5 / 10	8		320	2.80	100
CLH1608T-R39□-H	*390	5 / 10	8		300	3.00	100

- * at 50MHz
- Tolerance : S = ± 0.3 nH ; J = ± 5% ; K = ± 10%
- Test Instruments : L/Q : Agilent E4991A + Fixture : Agilent 16197A
SRF : HP8753D
RDC : HP4338B/ CH502BC

Test Instruments : Agilent E4991A Material/Impedance Analyzer

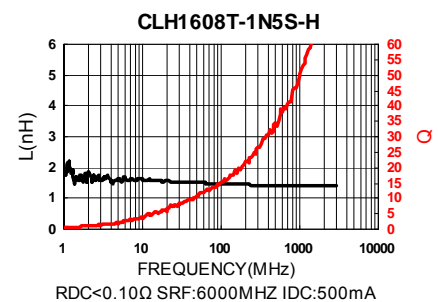
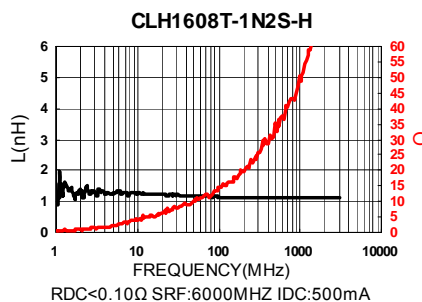
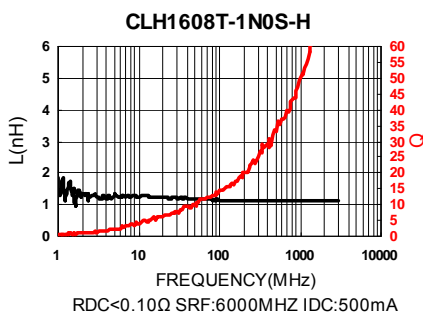

Test Instruments : Agilent E4991A Material/Impedance Analyzer

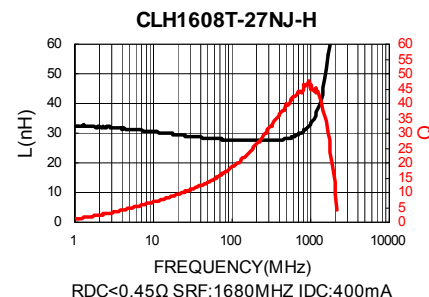
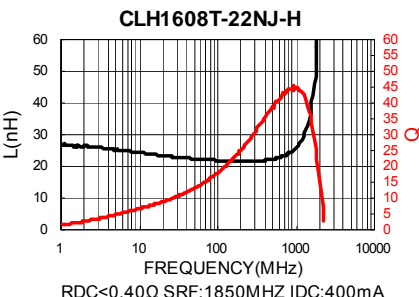
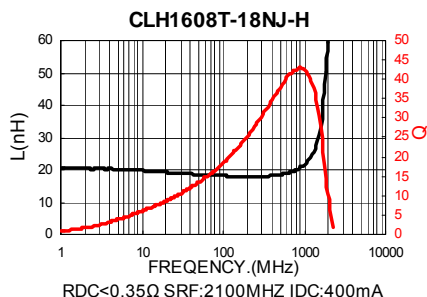
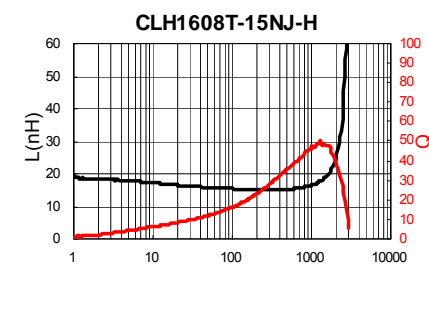
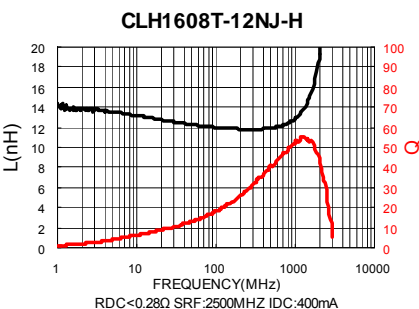
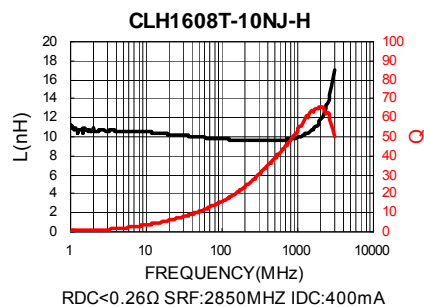
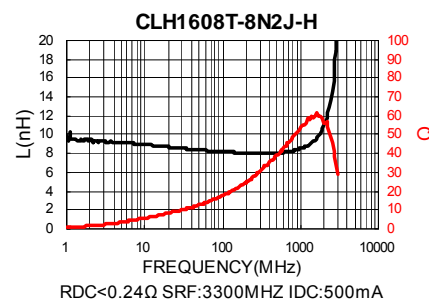
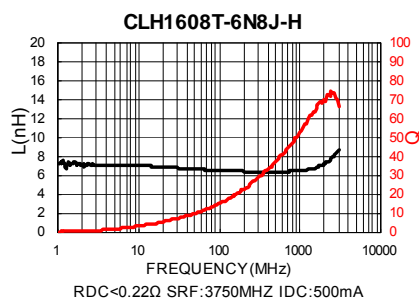
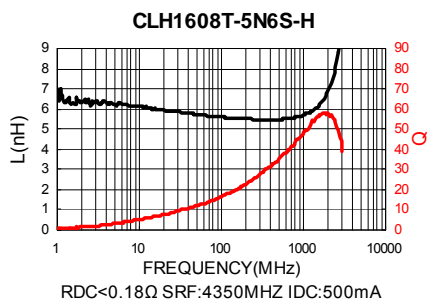
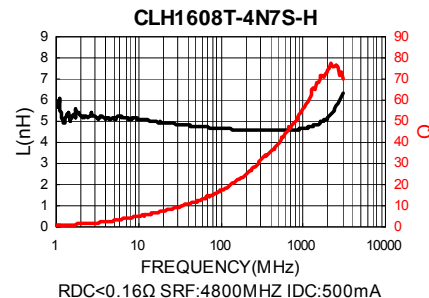
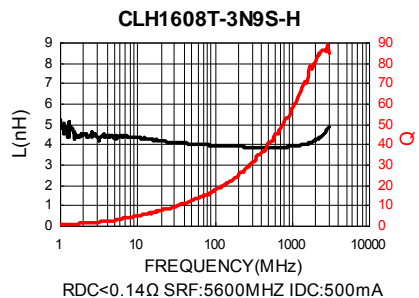
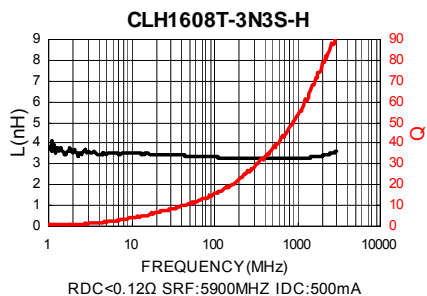
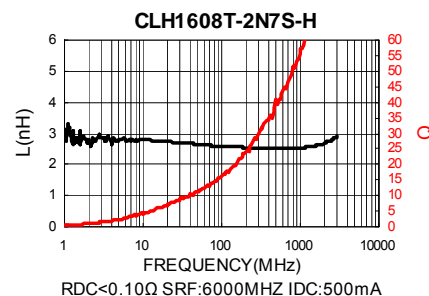
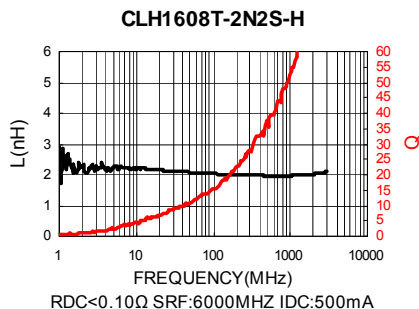
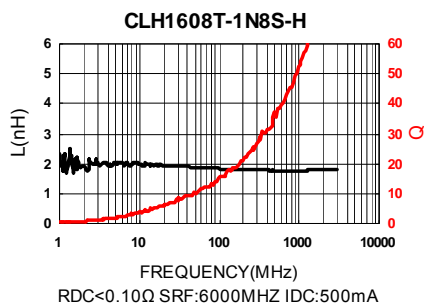

Test Instruments : Agilent E4991A Material/Impedance Analyzer

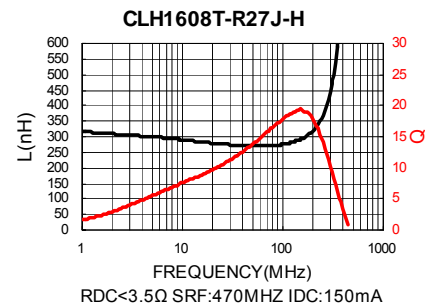
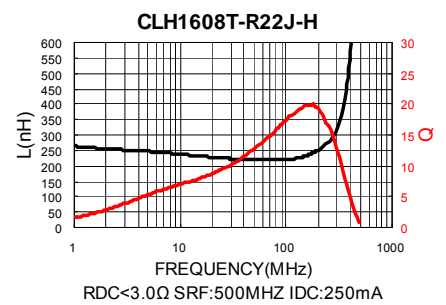
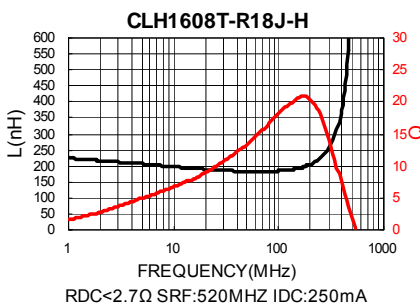
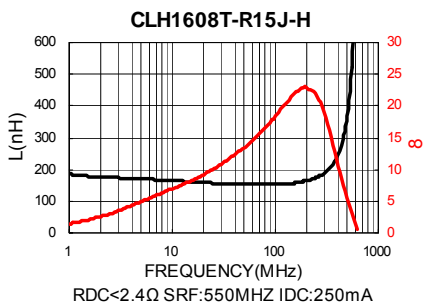
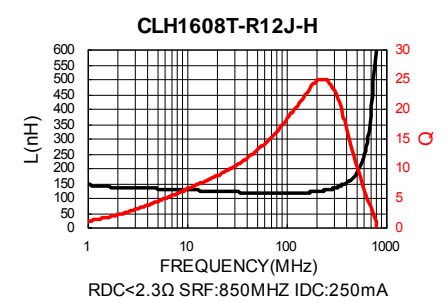
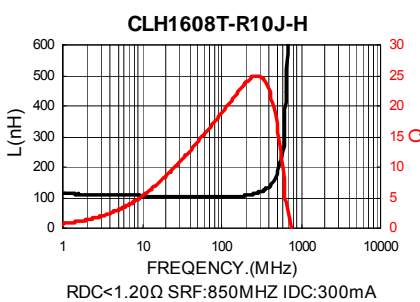
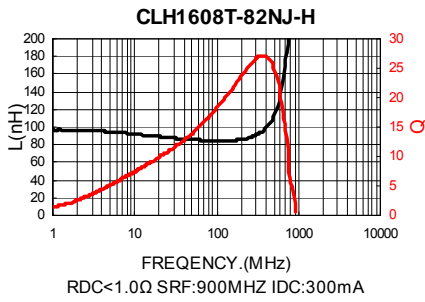
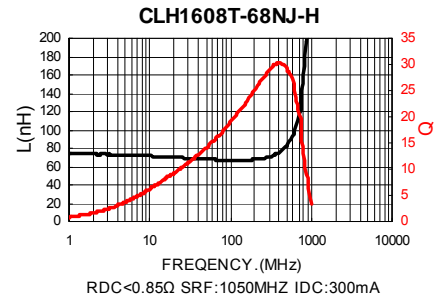
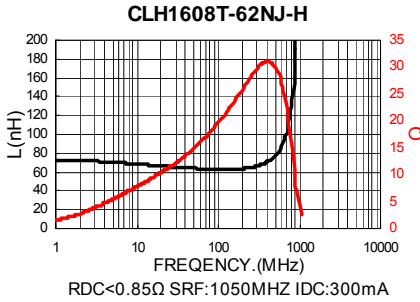
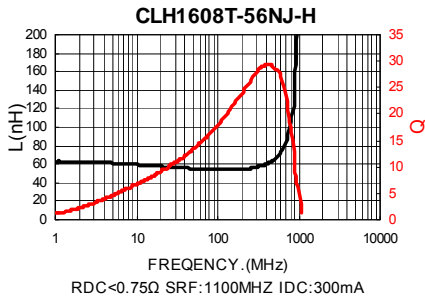
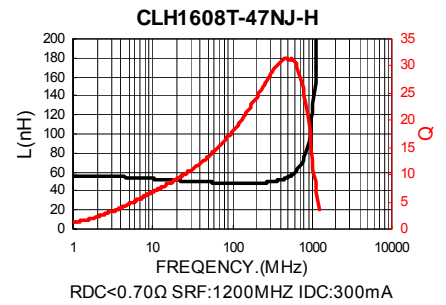
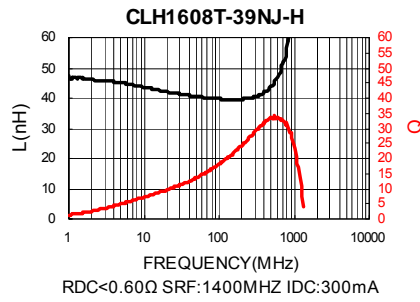
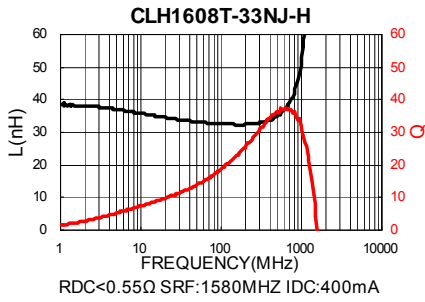

Electrical Characteristics

Part Number	Inductance (nH) at 100MHz	Tolerance (±%)	Q Min at		SRF (MHz) Typ.	DC Resistance (Ω) Max	IDC (mA) Max
			50MHz	100MHz			
CLH2012T-1N0□-S	1.0	±0.3nH		10	> 6000	0.10	300
CLH2012T-1N2□-S	1.2	±0.3nH		10	> 6000	0.10	300
CLH2012T-1N5□-S	1.5	±0.3nH		10	> 6000	0.10	300
CLH2012T-1N8□-S	1.8	±0.3nH		10	> 6000	0.10	300
CLH2012T-2N2□-S	2.2	±0.3nH		10	> 6000	0.10	300
CLH2012T-2N7□-S	2.7	±0.3nH		12	> 6000	0.10	300
CLH2012T-3N3□-S	3.3	±0.3nH/10		12	> 6000	0.13	300
CLH2012T-3N9□-S	3.9	±0.3nH/10		12	5400	0.15	300
CLH2012T-4N7□-S	4.7	±0.3nH/10		12	4500	0.20	300
CLH2012T-5N6□-S	5.6	±0.3nH/10		12	4000	0.23	300
CLH2012T-6N8□-S	6.8	5 / 10		15	3650	0.25	300
CLH2012T-8N2□-S	8.2	5 / 10		15	3000	0.28	300
CLH2012T-10N□-S	10	5 / 10		15	2500	0.30	300
CLH2012T-12N□-S	12	5 / 10		15	2450	0.35	300
CLH2012T-15N□-S	15	5 / 10		15	2000	0.40	300
CLH2012T-18N□-S	18	5 / 10		15	1750	0.45	300
CLH2012T-22N□-S	22	5 / 10		15	1700	0.50	300
CLH2012T-27N□-S	27	5 / 10		15	1550	0.55	300
CLH2012T-33N□-S	33	5 / 10		15	1350	0.60	300
CLH2012T-39N□-S	39	5 / 10		18	1300	0.65	300
CLH2012T-47N□-S	47	5 / 10		18	1200	0.70	300
CLH2012T-56N□-S	56	5 / 10		18	1150	0.75	300
CLH2012T-68N□-S	68	5 / 10		18	1000	0.80	300
CLH2012T-82N□-S	82	5 / 10		18	850	0.90	300
CLH2012T-R10□-S	100	5 / 10		18	730	1.00	300
CLH2012T-R12□-S	* 120	5 / 10	13		650	1.20	300
CLH2012T-R15□-S	* 150	5 / 10	13		550	1.40	300
CLH2012T-R18□-S	* 180	5 / 10	13		500	1.80	300
CLH2012T-R22□-S	* 220	5 / 10	12		450	2.00	300
CLH2012T-R27□-S	* 270	5 / 10	12		400	2.50	200
CLH2012T-R33□-S	* 330	5 / 10	12		380	3.00	200
CLH2012T-R39□-S	* 390	5 / 10	10		330	3.50	200
CLH2012T-R47□-S	* 470	5 / 10	10		300	4.00	200

- * at 50MHz
- Tolerance : S = ± 0.3nH , J = ± 5% , K = ± 10%
- Test Instruments : L/Q : Agilent E4991A + Fixture : Agilent 16197A
SRF : HP8753D
RDC : HP4338B/ CH502BC

Test Instruments : Agilent E4991A Material/Impedance Analyzer

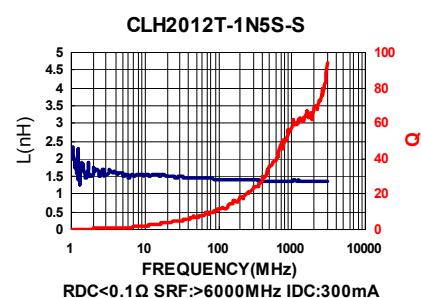
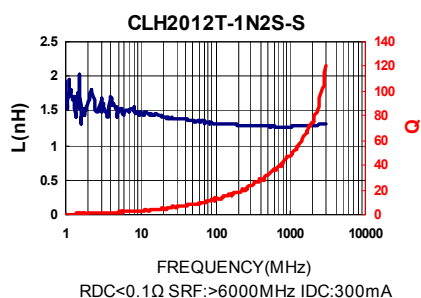
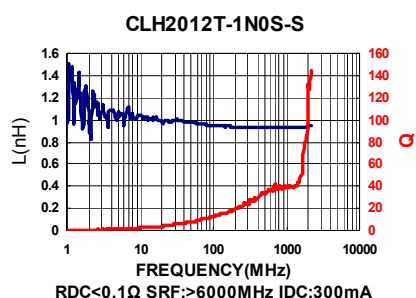

Test Instruments : Agilent E4991A Material/Impedance Analyzer

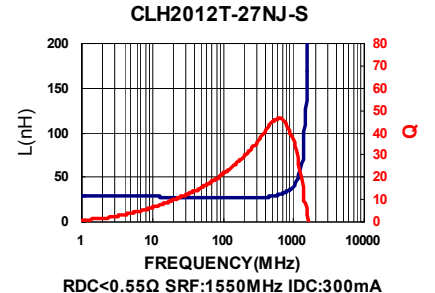
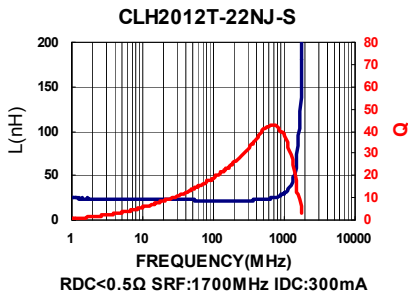
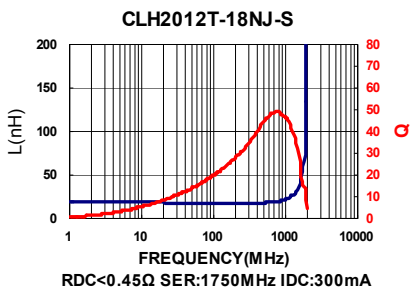
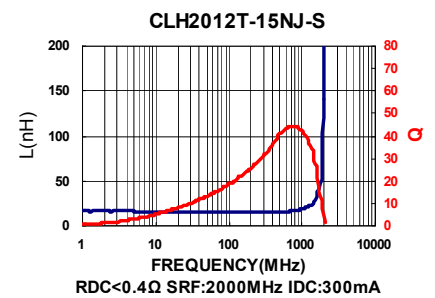
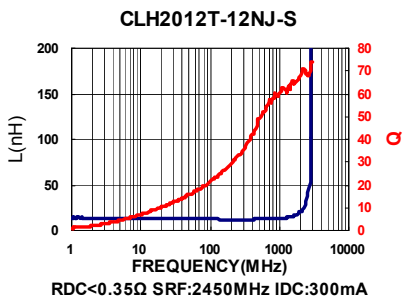
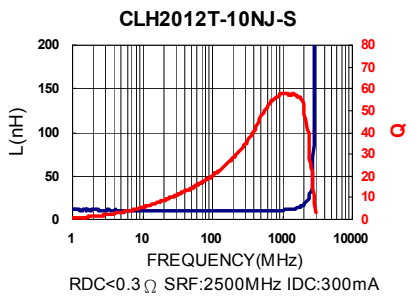
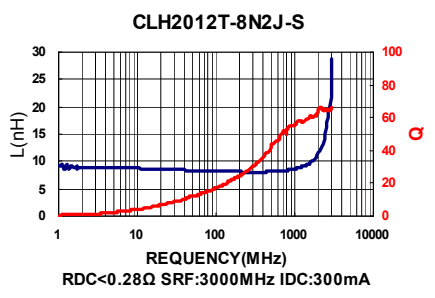
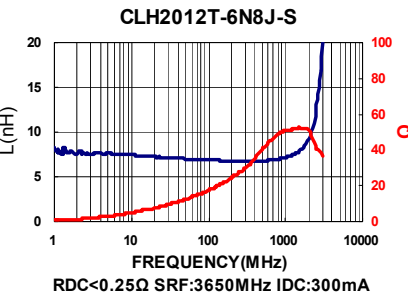
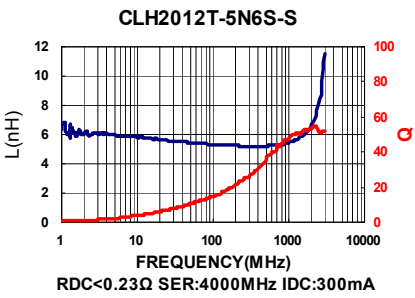
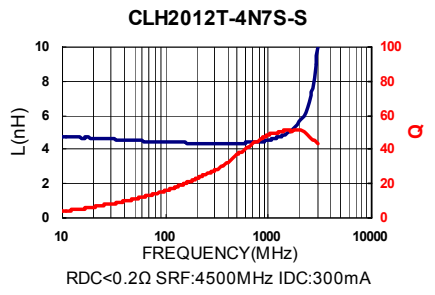
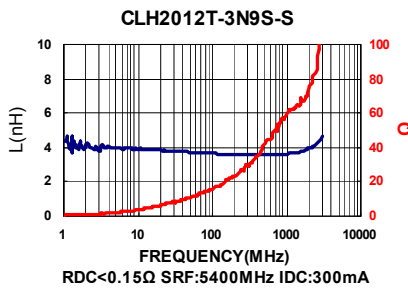
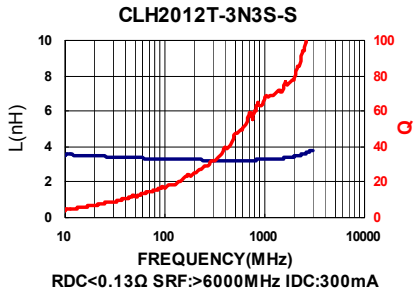
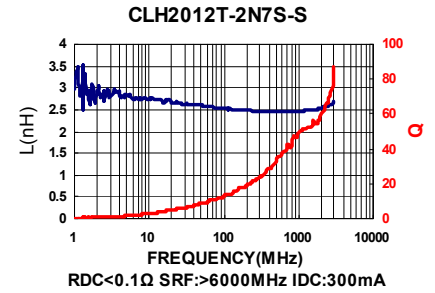
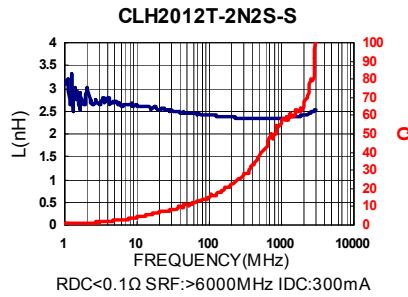
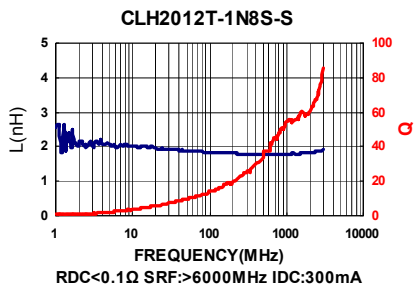

Test Instruments : Agilent E4991A Material/Impedance Analyzer

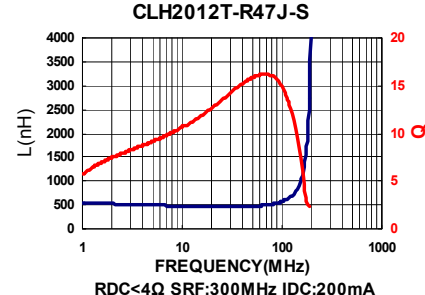
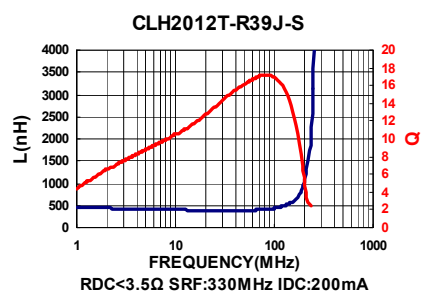
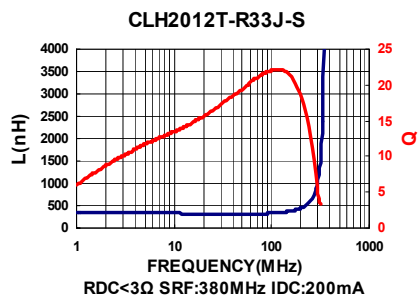
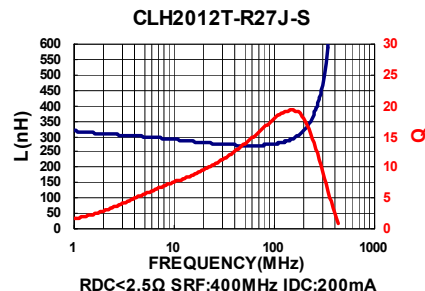
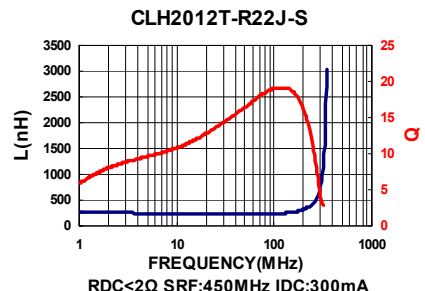
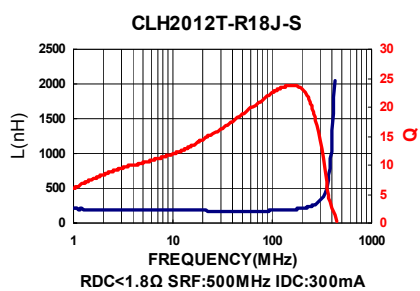
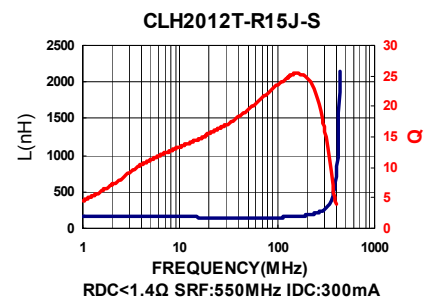
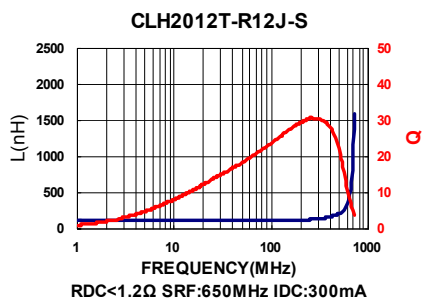
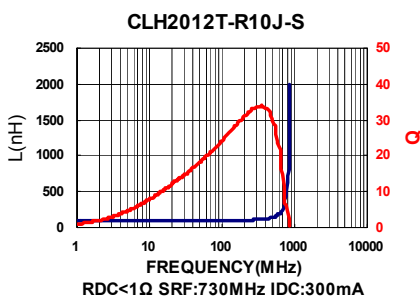
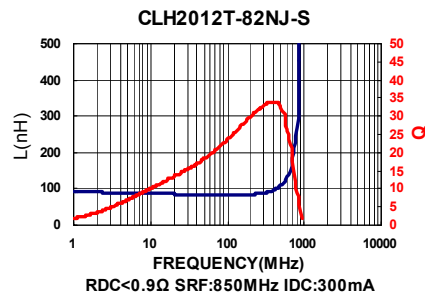
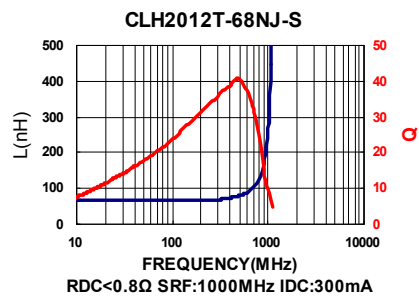
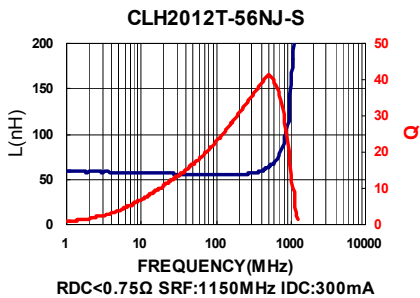
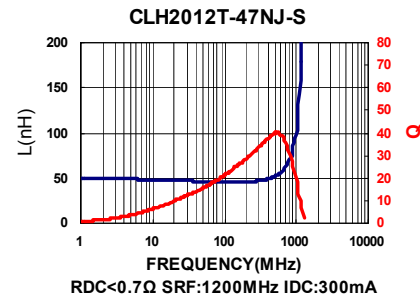
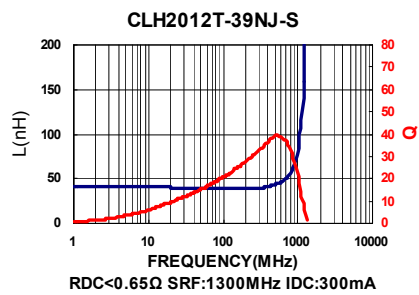
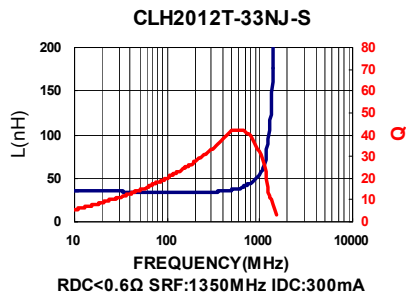

Packaging Specifications

Tape Dimensions

Figure A

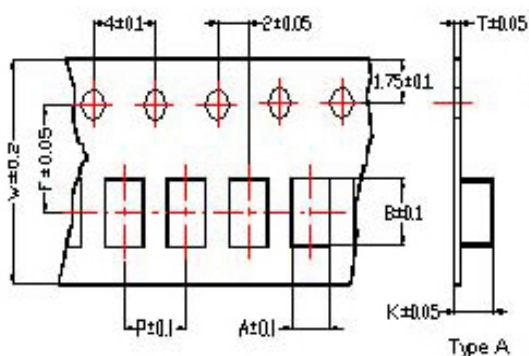
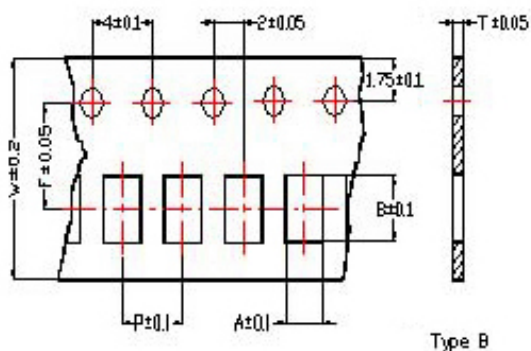
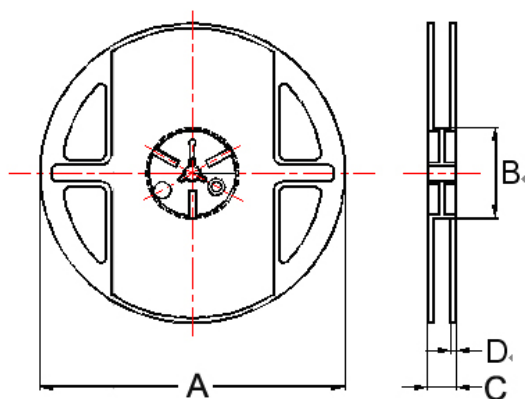

Figure B



Reel Dimensions



Dimensions in mm

TYPE	Tape Dimensions								Tape Material	Reel Dimensions				Quantity PCS / Reel	
	A	B	T	W	P	F	K	Tape		A	B	C	D		
CLH0603	0.37	0.67	0.42	8	2	3.5			B	B	180	60	13	1.5	15000
CLH1005	0.65	1.12	0.60	8	2	3.5			B	A	178	60	12	1.5	10000
CLH1608	1.00	1.80	0.95	8	4	3.5			B	A	178	60	12	1.5	4000
CLH201209	1.58	2.42	0.95	8	4	3.5	1.04		A,B	A	178	60	12	1.5	4000
CLH201212	1.35	2.25	0.22	8	4	3.5	1.35		A	A	178	60	12	1.5	3000

Tape Material

Figure A

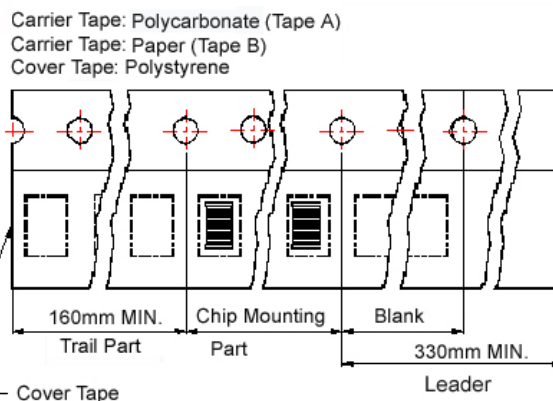
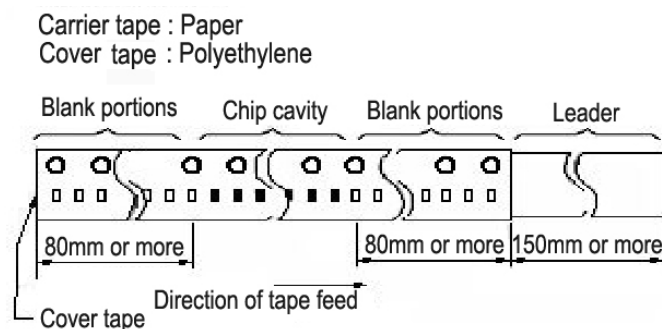

Figure B



CM Series



Due to accurate wire winding technology, these chip inductors are designed for filtering impedance matching, resonance and choke circuits for RF designer. Both standard series and custom designs are available.

Features

- RoHS Compliant
- Ceramic body and wire wound construction provide high SRFs
- Exceptional Q value even at high frequencies
- Ceramic construction delivers the highest possible SRFs as well as high Q value
- Low DC resistance design supports low loss, high output and low power consumption
- CM series is standard for RF designers

Applications

- RF products for cellular phone
- GPS receiver
- Base Station
- Repeater
- Wireless LAN/ mouse/ keyboard/ earphone
- Remote control
- Security system and other RF modules

Product Identification

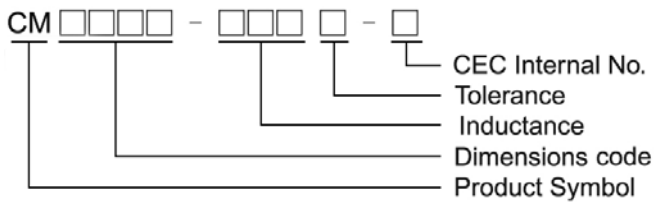

Shape and Dimensions / Recommended Pattern

CM0402

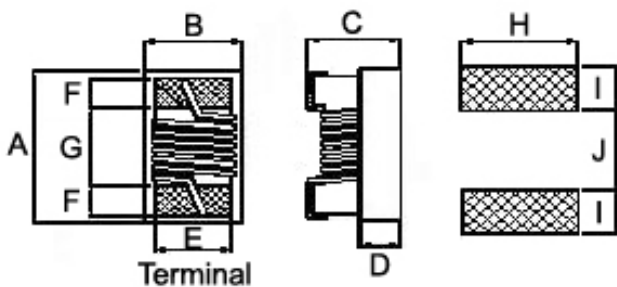

CM0603

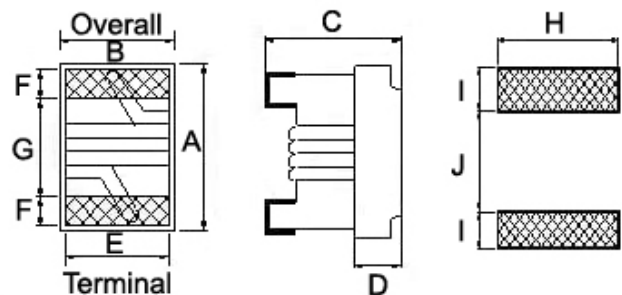

Dimensions

	A Max	B Max	C Max	D	E	F	G	H	I	J
CM0402	1.05 ± 0.05	0.60 ± 0.05	0.5 ± 0.05	0.25	0.40	0.20	0.54	0.56	0.36	0.46
CM0603	1.6 ^{+0.2} _{-0.1}	1.02 ± 0.1	0.82 ^{+0.2} _{-0.1}	0.35	0.70	0.30	0.95	1.02	0.64	0.64

Electrical Characteristics

Part Number	Inductance (nH)	Test Frequency (MHz)	Tolerance (±%)	Q Min	Test Frequency (MHz)	SRF (GHz) Min	Rdc (Ω) Max	Irms (mA) Max
CM0402-1N5□-N	1.5	100	±0.1nH/±0.2nH/±0.5nH	10	250	18.0	0.03	1000
CM0402-2N4□-N	2.4	100	±0.1nH/±0.2nH/±0.5nH	20	250	15.0	0.05	850
CM0402-2N5□-N	2.5	100	±0.1nH/±0.2nH/±0.5nH	20	250	15.0	0.05	850
CM0402-2N7□-N	2.7	100	±0.1nH/±0.2nH/±0.5nH	20	250	15.0	0.05	850
CM0402-2N9□-N	2.9	100	±0.1nH/±0.2nH/±0.5nH	20	250	15.0	0.07	750
CM0402-3N9□-N	3.9	100	3 / 5	25	250	10.0	0.07	750
CM0402-4N1□-N	4.1	100	3 / 5	25	250	10.0	0.07	750
CM0402-4N3□-N	4.3	100	3 / 5	25	250	10.0	0.07	750
CM0402-4N7□-N	4.7	100	3 / 5	25	250	8.0	0.07	750
CM0402-5N1□-N	5.1	100	3 / 5	25	250	8.0	0.12	600
CM0402-5N8□-N	5.8	100	3 / 5	25	250	8.0	0.12	700
CM0402-6N2□-N	6.2	100	3 / 5	25	250	8.0	0.09	700
CM0402-6N8□-N	6.8	100	3 / 5	25	250	6.0	0.09	700
CM0402-7N3□-N	7.3	100	3 / 5	25	250	6.0	0.13	570
CM0402-7N5□-N	7.5	100	3 / 5	25	250	6.0	0.13	570
CM0402-8N2□-N	8.2	100	3 / 5	25	250	5.5	0.14	540
CM0402-8N7□-N	8.7	100	3 / 5	25	250	5.5	0.14	540
CM0402-9N1□-N	9.1	100	3 / 5	25	250	5.5	0.14	540
CM0402-9N5□-N	9.5	100	3 / 5	25	250	5.5	0.14	540
CM0402-10N□-N	10	100	2 / 3 / 5	25	250	5.5	0.17	500
CM0402-11N□-N	11	100	2 / 3 / 5	30	250	5.5	0.14	500
CM0402-12N□-N	12	100	2 / 3 / 5	30	250	5.5	0.14	500
CM0402-13N□-N	13	100	2 / 3 / 5	25	250	5.0	0.21	430
CM0402-15N□-N	15	100	2 / 3 / 5	30	250	5.0	0.16	460
CM0402-16N□-N	16	100	2 / 3 / 5	25	250	4.5	0.24	370
CM0402-18N□-N	18	100	2 / 3 / 5	25	250	4.5	0.27	370
CM0402-19N□-N	19	100	2 / 3 / 5	25	250	4.5	0.27	370
CM0402-20N□-N	20	100	2 / 3 / 5	25	250	4.0	0.27	370
CM0402-22N□-N	22	100	2 / 3 / 5	25	250	4.0	0.30	310
CM0402-23N□-N	23	100	2 / 3 / 5	25	250	3.8	0.30	310
CM0402-24N□-N	24	100	2 / 3 / 5	25	250	3.5	0.52	280
CM0402-27N□-N	27	100	2 / 3 / 5	25	250	3.5	0.52	280
CM0402-30N□-N	30	100	2 / 3 / 5	25	250	3.3	0.58	270
CM0402-33N□-N	33	100	2 / 3 / 5	25	250	3.2	0.63	260
CM0402-36N□-N	36	100	2 / 3 / 5	25	250	3.1	0.63	260
CM0402-39N□-N	39	100	2 / 3 / 5	25	250	3.0	0.70	250
CM0402-40N□-N	40	100	2 / 3 / 5	25	250	3.0	0.70	250
CM0402-47N□-N	47	100	2 / 3 / 5	25	200	2.9	1.08	210
CM0402-51N□-N	51	100	2 / 3 / 5	25	200	2.85	1.08	210
CM0402-56N□-N	56	100	2 / 3 / 5	25	200	2.80	1.17	200
CM0402-62N□-N	62	100	2 / 3 / 5	20	200	2.60	1.82	145

- When ordering, please specify tolerance and packaging codes.
- Tolerance : G = ±2% , H = ±2% , J = ±5% , B = ±0.1nH , C = ±0.2nH , D = ±0.5nH
- L , Q : Agilent E4991A + Agilent HP16197A
- SRF : Agilent/HP8753D / Agilent/HP8722ES
- Rdc : Chroma16502
- Irms for a 15°C rise above 25°C ambient.
- Operating temperature range from -40°C to 125°C. (Including self - temperature rise)

Electrical Characteristics

Part Number	Inductance (nH)	Test Frequency (MHz)	Tolerance (±%)	Q Min	Test Frequency (MHz)	SRF (GHz) Min	Rdc (Ω) Max	Irms (mA) Max
CM0402-68N□-N	68	100	2 / 3 / 5	20	200	2.50	1.96	140
CM0402-72N□-N	72	100	2 / 3 / 5	20	150	2.50	2.10	135
CM0402-75N□-N	75	100	2 / 3 / 5	20	150	2.40	2.10	135
CM0402-82N□-N	82	100	2 / 3 / 5	20	150	2.30	2.24	130
CM0402-91N□-N	91	100	2 / 3 / 5	20	150	2.10	2.38	125
CM0402-R10□-N	100	100	2 / 3 / 5	20	150	1.50	2.52	120
CM0402-R12□-N	120	100	2 / 3 / 5	20	150	1.00	2.66	110

- When ordering, please specify tolerance and packaging codes.
- Tolerance : G = ±2% , H = ±3% , J = ±5% , B = ±0.1nH , C = ±0.2nH , D = ±0.3nH ,
- L , Q : Agilent E4991A + Agilent HP16197A
- SRF : Agilent/HP8753D / Agilent/HP8722ES
- Rdc : Chroma16502
- Irms for a 15°C rise above 25°C ambient.
- Operating temperature range from -40°C to 125°C. (Including self - temperature rise)

Typical L vs. Frequency

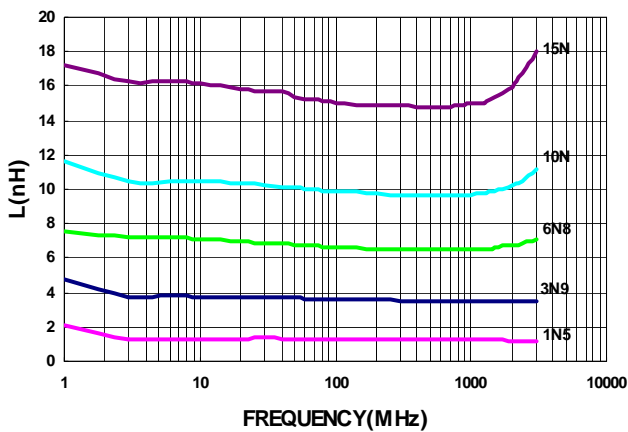

Typical Q vs. Frequency

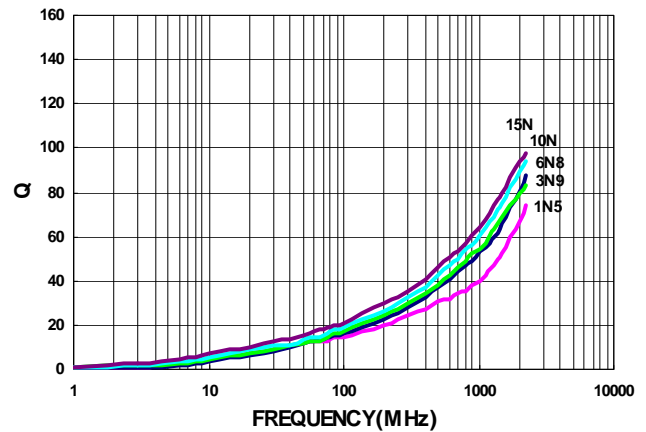

Electrical Characteristics

Part Number	Inductance (nH)	Test Frequency (MHz)	Tolerance (±%)	Q Min	Test Frequency (MHz)	SRF (GHz) Min	Rdc (Ω) Max	Irms (mA) Max
CM0603-2N2□-N	2.2	100	±0.1nH±0.2nH±0.5nH	16	250	6.0	0.049	700
CM0603-3N6□-N	3.6	100	3 / 5	25	250	6.0	0.059	850
CM0603-3N9□-N	3.9	100	3 / 5	35	250	6.0	0.059	850
CM0603-4N3□-N	4.3	100	3 / 5	35	250	6.0	0.059	850
CM0603-4N7□-N	4.7	100	3 / 5	35	250	6.0	0.059	850
CM0603-5N6□-N	5.6	100	3 / 5	35	250	6.0	0.082	750
CM0603-6N2□-N	6.2	100	3 / 5	35	250	6.0	0.082	750
CM0603-6N8□-N	6.8	100	3 / 5	35	250	6.0	0.082	750
CM0603-7N5□-N	7.5	100	3 / 5	35	250	6.0	0.082	750
CM0603-8N2□-N	8.2	100	3 / 5	35	250	6.0	0.110	650
CM0603-8N7□-N	8.7	100	3 / 5	35	250	6.0	0.110	650
CM0603-9N1□-N	9.1	100	3 / 5	35	250	6.0	0.110	650
CM0603-9N5□-N	9.5	100	3 / 5	35	250	6.0	0.110	650
CM0603-10N□-N	10	100	2 / 3 / 5	35	250	6.0	0.110	650
CM0603-11N□-N	11	100	2 / 3 / 5	35	250	6.0	0.110	650
CM0603-12N□-N	12	100	2 / 3 / 5	35	250	6.0	0.130	600
CM0603-13N□-N	13	100	2 / 3 / 5	35	250	6.0	0.130	600
CM0603-15N□-N	15	100	2 / 3 / 5	40	250	6.0	0.130	600
CM0603-16N□-N	16	100	2 / 3 / 5	40	250	5.5	0.160	550
CM0603-18N□-N	18	100	2 / 3 / 5	40	250	5.5	0.160	550
CM0603-20N□-N	20	100	2 / 3 / 5	40	250	4.9	0.160	550
CM0603-22N□-N	22	100	2 / 3 / 5	40	250	4.6	0.170	500
CM0603-24N□-N	24	100	2 / 3 / 5	40	250	3.8	0.210	500
CM0603-27N□-N	27	100	2 / 3 / 5	40	250	3.7	0.210	440
CM0603-30N□-N	30	100	2 / 3 / 5	40	250	3.3	0.230	420
CM0603-33N□-N	33	100	2 / 3 / 5	40	250	3.2	0.230	420
CM0603-36N□-N	36	100	2 / 3 / 5	40	250	2.9	0.260	400
CM0603-39N□-N	39	100	2 / 3 / 5	40	250	2.8	0.260	400
CM0603-43N□-N	43	100	2 / 3 / 5	40	200	2.7	0.290	380
CM0603-47N□-N	47	100	2 / 3 / 5	38	200	2.6	0.290	380
CM0603-51N□-N	51	100	2 / 3 / 5	38	200	2.5	0.330	370
CM0603-56N□-N	56	100	2 / 3 / 5	38	200	2.4	0.350	360
CM0603-62N□-N	62	100	2 / 3 / 5	38	200	2.3	0.510	280
CM0603-68N□-N	68	100	2 / 3 / 5	38	200	2.2	0.380	340
CM0603-72N□-N	72	100	2 / 3 / 5	38	150	2.1	0.560	270
CM0603-75N□-N	75	100	2 / 3 / 5	34	150	2.05	0.560	270
CM0603-82N□-N	82	100	2 / 3 / 5	34	150	2.00	0.600	250
CM0603-91N□-N	91	100	2 / 3 / 5	34	150	1.90	0.640	230
CM0603-R10□-N	100	100	2 / 3 / 5	34	150	1.80	0.680	220
CM0603-R11□-N	110	100	2 / 3 / 5	32	150	1.70	1.200	200
CM0603-R12□-N	120	100	2 / 3 / 5	32	150	1.60	1.300	180
CM0603-R13□-N	130	100	2 / 3 / 5	32	150	1.45	1.400	170
CM0603-R15□-N	150	100	2 / 3 / 5	32	150	1.40	1.500	160

- When ordering, please specify tolerance and packaging codes.
- Tolerance : G = ±2% , H = ±3% , J = ±5% , B = ±0.1nH , C = ±0.2nH , D = ±0.5nH
- L , Q : Agilent E4991A + Agilent HP16197A
- SRF : Agilent/HP8753D / Agilent/HP8722ES
- Rdc : Chroma16502
- Irms for a 15°C rise above 25°C ambient.
- Operating temperature range from -40°C to 125°C. (Including self - temperature rise)

Electrical Characteristics

Part Number	Inductance (Nh)	Test Frequency (MHz)	Tolerance (±%)	Q Min	Test Frequency (MHz)	SRF (GHz) Min	Rdc (Ω) Max	Irms (mA) Max
CM0603-R16□-N	160	100	2 / 3 / 5	25	100	1.35	2.100	150
CM0603-R18□-N	180	100	2 / 3 / 5	25	100	1.30	2.200	140
CM0603-R20□-N	200	100	2 / 3 / 5	25	100	1.25	2.400	120
CM0603-R22□-N	220	100	2 / 3 / 5	25	100	1.20	2.500	120
CM0603-R27□-N	270	100	2 / 3 / 5	30	100	0.96	3.400	110
CM0603-R33□-N	330	100	2 / 3 / 5	30	100	0.80	5.500	85
CM0603-R39□-N	390	100	2 / 3 / 5	30	100	0.80	6.200	80
CM0603-R47□-N	470	100	2 / 3 / 5	30	100	0.70	7.000	75

- When ordering, please specify tolerance and packaging codes.
- Tolerance : G = ±2% , H = ±3% , J = ±5% , B = ±0.1nH , C = ±0.2nH , D = ±0.5nH
- L , Q : Agilent E4991A + Agilent HP16197A
- SRF : Agilent/HP8753D / Agilent/HP8722ES
- Rdc : Chroma16502
- Irms for a 15°C rise above 25°C ambient.
- Operating temperature range from -40°C to 125°C . (Including self - temperature rise)

Typical **L** vs. **Frequency**

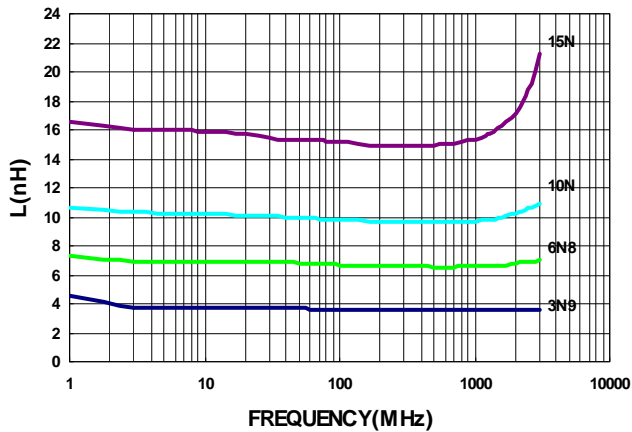

Typical **Q** vs. **Frequency**

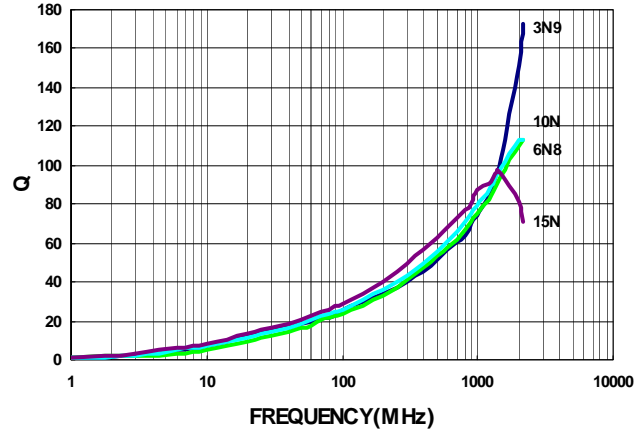

Packaging Specifications

Tape Dimensions

Figure 1

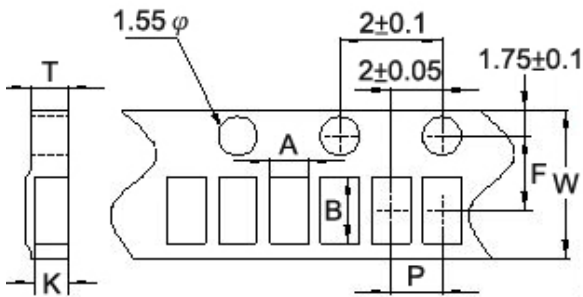

Tape Material

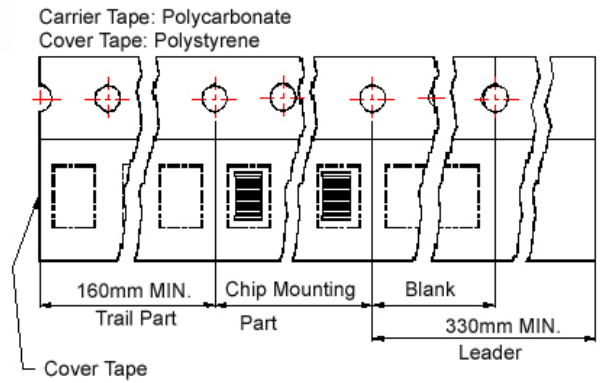
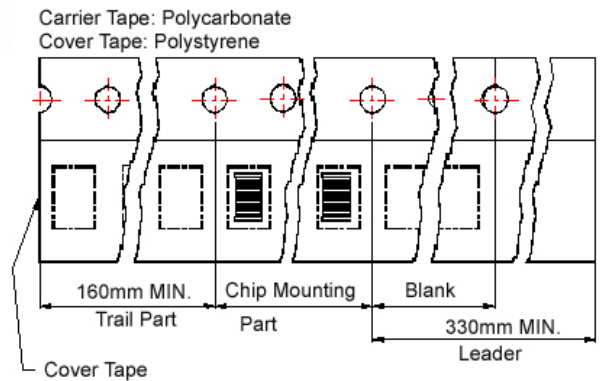
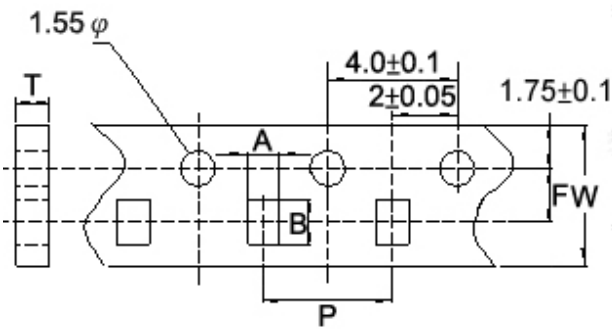
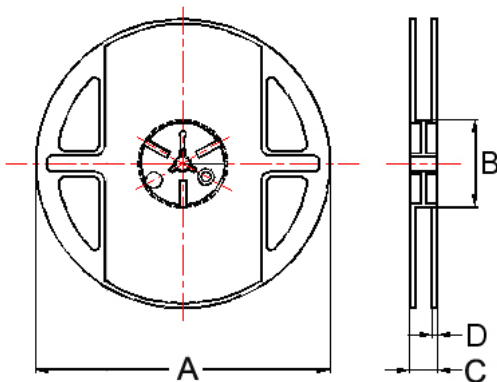

Figure 2



Reel Dimensions



Dimensions in mm

TYPE	Fig.	Tape Dimensions							Reel Dimensions				Quantity PCS / Reel
		A	B	T	W	P	F	K	A	B	C	D	
CM0402	1	0.67	1.20	0.75	8	2	3.5	0.53	178	60	12	1.5	4000
CM0603	2	1.20	1.80	0.97	8	4	3.5	-	178	60	12	1.5	4000

CS Series



Due to accurate wire winding technology, these chip inductors are designed for filtering, impedance matching, resonance and choke circuits for RF designer. Both standard series custom designs are available.

Features

- RoHS Compliant
- Ceramic body and wire wound construction provide high SRFs
- Exceptional Q values even at high frequencies
- Highest possible SRFs as well as excellent Q values
- The non-magnetic coil form assures utmost thermal stability, predictability and batch consistency
- CS series is standard for RF designers

Applications

- RF products for cellular phone
- GPS receiver
- Base Station
- Repeater
- Wireless LAN/ mouse/ keyboard/ earphone
- Remote control
- Security system and other RF modules

Product Identification

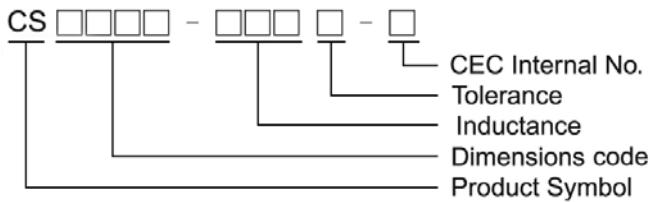

Shape and Dimensions / Recommended Pattern

CS0402

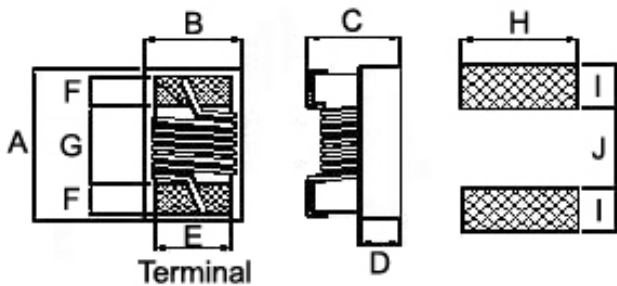

CS0603/0805/1008

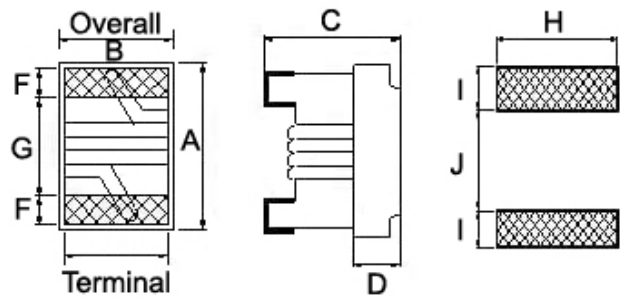

Dimensions

		A Max	B Max	C Max	D	E	F	G	H	I	J
CS0402	inch	0.047	0.028	0.026	0.010	0.020	0.009	0.022	0.026	0.014	0.018
	mm	1.19	0.70	0.66	0.25	0.51	0.23	0.56	0.66	0.36	0.46
CS0805	inch	0.093	0.068	0.06	0.028	0.050	0.020	0.040	0.070	0.040	0.030
	mm	2.35	1.73	1.52	0.71	1.27	0.51	1.02	1.78	1.02	0.76
CS1008	inch	0.115	0.110	0.083	0.046	0.080	0.020	0.060	0.100	0.040	0.050
	mm	2.92	2.79	2.1	1.16	2.03	0.51	1.52	2.54	1.02	1.27
		A	B	C	D	E	F	G	H	I	J
CS0603	mm	1.6 ^{+0.2} _{-0.1}	1.02±0.1	0.82 ^{+0.2} _{-0.1}	0.51	0.76	0.33	0.86	1.02	0.64	0.64

Electrical Characteristics

Part Number	Inductance (nH)	Test Frequency (MHz)	Tolerance (±%)	Q Min	SRF (GHz) Min	Rdc (Ω) Max	Irms (mA) Max
CS0402-1N0□-S	1.0	250	10 / 5 / ±0.1nH	16	12.7	0.045	1360
CS0402-1N2□-S	1.2	250	10 / 5 / ±0.1nH	10	10.0	0.140	640
CS0402-1N3□-S	1.3	250	10 / ±0.1nH	10	10.4	0.140	640
CS0402-1N9□-S	1.9	250	10 / 5 / ±0.1nH	16	11.3	0.070	1040
CS0402-2N0□-S	2.0	250	10 / 5 / ±0.1nH	16	11.1	0.070	1040
CS0402-2N2□-S	2.2	250	10 / 5 / ±0.1nH	19	10.8	0.070	960
CS0402-2N4□-S	2.4	250	10 / 5 / ±0.1nH	15	10.5	0.068	790
CS0402-2N5□-S	2.5	250	10 / 5 / ±0.1nH	13	10.4	0.150	640
CS0402-2N7□-S	2.7	250	10 / 5 / ±0.1nH	16	10.4	0.120	640
CS0402-3N3□-S	3.3	250	10 / 5 / 3	19	7.00	0.066	840
CS0402-3N6□-S	3.6	250	10 / 5 / 3	19	6.80	0.066	840
CS0402-3N9□-S	3.9	250	10 / 5 / 3	19	6.00	0.066	840
CS0402-4N3□-S	4.3	250	10 / 5 / 3	18	6.00	0.091	700
CS0402-4N7□-S	4.7	250	10 / 5 / 3	15	4.77	0.130	640
CS0402-5N1□-S	5.1	250	10 / 5 / 3	20	4.80	0.083	800
CS0402-5N6□-S	5.6	250	10 / 5 / 3	20	4.80	0.083	760
CS0402-6N2□-S	6.2	250	10 / 5 / 3	20	4.80	0.083	760
CS0402-6N8□-S	6.8	250	10 / 5 / 3	20	4.80	0.083	680
CS0402-7N3□-S	7.3	250	10 / 5 / 3	20	4.80	0.12	680
CS0402-7N5□-S	7.5	250	10 / 5 / 3	22	4.80	0.10	680
CS0402-8N2□-S	8.2	250	10 / 5 / 3	22	4.40	0.10	680
CS0402-8N7□-S	8.7	250	10 / 5 / 3	18	4.10	0.20	480
CS0402-9N0□-S	9.0	250	10 / 5 / 3	22	4.16	0.10	680
CS0402-9N1□-S	9.1	250	10 / 5 / 3	22	4.16	0.10	680
CS0402-9N5□-S	9.5	250	10 / 5 / 3	18	4.00	0.20	480
CS0402-10N□-S	10	250	10 / 5 / 3 / 2	21	3.90	0.20	480
CS0402-11N□-S	11	250	10 / 5 / 3 / 2	24	3.68	0.12	640
CS0402-12N□-S	12	250	10 / 5 / 3 / 2	24	3.60	0.12	640
CS0402-13N□-S	13	250	10 / 5 / 3 / 2	24	3.45	0.21	440
CS0402-15N□-S	15	250	10 / 5 / 3 / 2	24	3.28	0.17	560
CS0402-16N□-S	16	250	10 / 5 / 3 / 2	24	3.10	0.22	560
CS0402-18N□-S	18	250	10 / 5 / 3 / 2	25	3.10	0.23	420
CS0402-19N□-S	19	250	10 / 5 / 3 / 2	24	3.04	0.20	480
CS0402-20N□-S	20	250	10 / 5 / 3 / 2	25	3.00	0.25	420
CS0402-22N□-S	22	250	10 / 5 / 3 / 2	25	2.80	0.30	400
CS0402-23N□-S	23	250	10 / 5 / 3 / 2	22	2.72	0.30	400
CS0402-24N□-S	24	250	10 / 5 / 3 / 2	25	2.70	0.30	400
CS0402-27N□-S	27	250	10 / 5 / 3 / 2	24	2.48	0.30	400
CS0402-30N□-S	30	250	10 / 5 / 3 / 2	25	2.35	0.35	400

- When ordering, please specify tolerance and packaging codes.
- Tolerance : B = ±0.1uH , G = ±2% , H = ±3% , J = ±5% , K = ±10%
- L , Q : Agilent E4991A+AgilentHP16197A
- SRF : Agilent/HP8753D / Agilent/HP8722ES
- Rdc : HP4287A
- Irms for a 15°C rise above 25°C ambient.

Electrical Characteristics

Part Number	Inductance (nH)	Test Frequency (MHz)	Tolerance (±%)	Q Min	SRF (GHz) Min	Rdc (Ω) Max	Irms (mA) Max
CS0402-33N□-S	33	250	10 / 5 / 3 / 2	24	2.35	0.40	400
CS0402-36N□-S	36	250	10 / 5 / 3 / 2	24	2.32	0.44	320
CS0402-39N□-S	39	250	10 / 5 / 3 / 2	25	2.10	0.55	200
CS0402-40N□-S	40	250	10 / 5 / 3 / 2	24	2.24	0.65	320
CS0402-43N□-S	43	250	10 / 5 / 3 / 2	25	2.03	0.81	100
CS0402-47N□-S	47	250	10 / 5 / 3 / 2	20	2.10	0.83	150
CS0402-51N□-S	51	250	10 / 5 / 3 / 2	25	1.75	0.82	100
CS0402-56N□-S	56	250	10 / 5 / 3 / 2	22	1.76	0.97	100
CS0402-68N□-S	68	250	10 / 5 / 3 / 2	22	1.62	1.12	100
CS0402-82N□-S	82	250	10 / 5 / 3 / 2	20	1.26	1.55	50
CS0402-R10□-S	100	250	10 / 5 / 3 / 2	20	1.16	2.00	30
CS0402-R18□-S	180	100	10 / 5 / 3 / 2	8	0.70	2.70	50

- When ordering, please specify tolerance and packaging codes.
- Tolerance : B = ±0.1uH , G = ±2% , H = ±3% , J = ±5% , K = ±10%
- L , Q : Agilent E4991A+AgilentHP16197A
- SRF : Agilent/HP8753D / Agilent/HP8722ES
- Rdc : HP4287A
- Irms for a 15°C rise above 25°C ambient.

Electrical Characteristics

Part Number	Inductance (nH)	Test Frequency (MHz)	Tolerance (±%)	Q Min	SRF (MHz) Min	Rdc (Ω) Max	Irms (mA) Max	Color
CS0603-1N6□-S	1.6	250	10 / 5 / ±0.1nH	24	12500	0.030	700	Red
CS0603-1N8□-S	1.8	250	10 / 5 / ±0.1nH	16	12500	0.045	700	Black
CS0603-2N2□-S	2.2	250	10 / 5 / ±0.1nH	13	12500	0.250	700	Yellow
CS0603-3N3□-S	3.3	250	10 / 5 / 3	35	5900	0.045	700	Blue
CS0603-3N6□-S	3.6	250	10 / 5 / 3	22	5900	0.063	700	Red
CS0603-3N9□-S	3.9	250	10 / 5 / 3	22	6900	0.080	700	Brown
CS0603-4N3□-S	4.3	250	10 / 5 / 3	22	5900	0.063	700	Orange
CS0603-4N7□-S	4.7	250	10 / 5 / 3	20	5800	0.116	700	Violet
CS0603-5N1□-S	5.1	250	10 / 5 / 3	20	5700	0.140	700	Green
CS0603-5N6□-S	5.6	250	10 / 5 / 3	20	5800	0.170	700	Yellow
CS0603-6N3□-S	6.3	250	10 / 5 / 3	20	5700	0.140	700	White
CS0603-6N8□-S	6.8	250	10 / 5 / 3	27	5800	0.110	700	Red
CS0603-7N5□-S	7.5	250	10 / 5 / 3	28	4800	0.106	700	Brown
CS0603-8N2□-S	8.2	250	10 / 5 / 3	28	4700	0.109	700	White
CS0603-8N7□-S	8.7	250	10 / 5 / 3	28	4600	0.109	700	Yellow
CS0603-9N1□-S	9.1	250	10 / 5 / 3	28	4800	0.120	700	Violet
CS0603-9N5□-S	9.5	250	10 / 5 / 3	28	5400	0.135	700	Blue
CS0603-10N□-S	10	250	10 / 5 / 3 / 2	31	4800	0.130	700	Orange
CS0603-11N□-S	11	250	10 / 5 / 3 / 2	33	4000	0.086	700	Gray
CS0603-12N□-S	12	250	10 / 5 / 3 / 2	35	4000	0.130	700	Yellow
CS0603-13N□-S	13	250	10 / 5 / 3 / 2	30	4000	0.160	700	Black
CS0603-15N□-S	15	250	10 / 5 / 3 / 2	35	4000	0.170	700	Green
CS0603-16N□-S	16	250	10 / 5 / 3 / 2	34	3300	0.104	700	White
CS0603-18N□-S	18	250	10 / 5 / 3 / 2	35	3100	0.170	700	Blue
CS0603-20N□-S	20	250	10 / 5 / 3 / 2	38	3000	0.190	700	Red
CS0603-22N□-S	22	250	10 / 5 / 3 / 2	38	3000	0.190	700	Violet
CS0603-23N□-S	23	250	10 / 5 / 3 / 2		2850	0.190	700	Orange
CS0603-24N□-S	24	250	10 / 5 / 3 / 2	37	2650	0.135	700	Black
CS0603-27N□-S	27	250	10 / 5 / 3 / 2	40	2800	0.220	600	Gray
CS0603-30N□-S	30	250	10 / 5 / 3 / 2	37	2250	0.144	600	Brown
CS0603-33N□-S	33	250	10 / 5 / 3 / 2	40	2300	0.220	600	White
CS0603-36N□-S	36	250	10 / 5 / 3 / 2	38	2080	0.250	600	Red
CS0603-39N□-S	39	250	10 / 5 / 3 / 2	40	2200	0.250	600	Black
CS0603-43N□-S	43	250	10 / 5 / 3 / 2	39	2000	0.280	600	Orange
CS0603-47N□-S	47	200	10 / 5 / 3 / 2	38	2000	0.280	600	Brown
CS0603-51N□-S	51	200	10 / 5 / 3 / 2	38	1900	0.310	600	Brown
CS0603-56N□-S	56	200	10 / 5 / 3 / 2	38	1900	0.310	600	Red
CS0603-68N□-S	68	200	10 / 5 / 3 / 2	37	1700	0.340	600	Orange
CS0603-72N□-S	72	150	10 / 5 / 3 / 2	34	1700	0.490	400	Yellow
CS0603-82N□-S	82	150	10 / 5 / 3 / 2	34	1700	0.540	400	Green
CS0603-91N□-S	91	150	10 / 5 / 3 / 2	34	1400	0.580	400	Black

- When ordering, please specify tolerance and packaging codes.
- Tolerance : B = ±0.1nH , H = ±3% , G = ±2% , J = ±5% , K = ±10%
- Packaging: Clear tape and reel {standard}.
- L /Q: Agilent E4991A + AgilentHP16197A
- SRF: HP8753D/ HP4291A
- RDC: CH502BC/ HP4338B
- Irms for a 15°C rise above 25°C ambient.
- Operating temperature range from -40°C to 125°C. (Including self - temperature rise)

Electrical Characteristics

Part Number	Inductance (nH)	Test Frequency (MHz)	Tolerance (±%)	Q Min	SRF (MHz) Min	Rdc (Ω) Max	Irms (mA) Max	Color
CS0603-R10□-S	100	150	10 / 5 / 3 / 2	34	1400	0.580	400	Blue
CS0603-R11□-S	110	150	10 / 5 / 3 / 2	32	1350	0.610	300	Violet
CS0603-R12□-S	120	150	10 / 5 / 3 / 2	32	1300	0.750	300	Gray
CS0603-R15□-S	150	150	10 / 5 / 3 / 2	28	990	0.920	280	White
CS0603-R16□-S	160	100	10 / 5 / 3 / 2	25	990	1.250	240	Yellow
CS0603-R18□-S	180	100	10 / 5 / 3 / 2	25	990	1.250	240	Black
CS0603-R20□-S	200	100	10 / 5 / 3 / 2	25	900	2.100	200	Red
CS0603-R21□-S	210	100	10 / 5 / 3 / 2	27	895	2.060	200	Gray
CS0603-R22□-S	220	100	10 / 5 / 3 / 2	25	900	2.100	200	Brown
CS0603-R24□-S	240	100	10 / 5 / 3 / 2	25	900	2.200	200	Green
CS0603-R25□-S	250	100	10 / 5 / 3 / 2	25	822	3.550	120	Violet
CS0603-R27□-S	270	100	10 / 5 / 3 / 2	24	900	2.800	170	Red
CS0603-R33□-S	330	100	10 / 5 / 3 / 2	25	900	3.890	100	Orange
CS0603-R39□-S	390	100	10 / 5 / 3 / 2	25	900	4.350	100	Yellow
CS0603-R47□-S	470	100	10 / 5 / 3 / 2	25	500	4.500	100	Brown
CS0603-R56□-S	560	100	10 / 5 / 3 / 2	23	460	4.700	90	Blue

- When ordering, please specify tolerance and packaging codes.
- Tolerance : B = ±0.1nH , H = ±3% , G = ±2% , J = ±5% , K = ±10%
- Packaging: Clear tape and reel {standard}.
- L /Q: Agilent E4991A + AgilentHP16197A
- SRF: HP8753D/ HP4291A
- RDC: CH502BC/ HP4338B
- Irms for a 15°C rise above 25°C ambient.
- Operating temperature range from -40°C to 125°C. (Including self - temperature rise)

Electrical Characteristics

Part Number	Inductance (nH)	Test Frequency (MHz)	Tolerance (±%)	Q Min	Test Frequency (MHz)	SRF (MHz) Min	Rdc (Ω) Max	Irms (mA) Max	Color
CS0805-2N8□-S	2.8	250	10 / 5 / 2	80	1500	7900	0.06	800	Gray
CS0805-3N0□-S	3.0	250	10 / 5 / 2	65	1500	7900	0.06	800	White
CS0805-3N3□-S	3.3	250	10 / 5 / 2	50	1500	7900	0.08	600	Black
CS0805-5N6□-S	5.6	250	10 / 5 / 2	65	1000	5500	0.08	600	Orange
CS0805-6N8□-S	6.8	250	10 / 5 / 2	50	1000	5500	0.11	600	Brown
CS0805-7N5□-S	7.5	250	10 / 5 / 2	50	1000	4500	0.14	600	Green
CS0805-8N2□-S	8.2	250	10 / 5 / 2	50	1000	4700	0.12	600	Red
CS0805-10N□-S	10	250	10 / 5 / 2	60	500	4200	0.10	600	Blue
CS0805-12N□-S	12	250	10 / 5 / 2	50	500	4000	0.15	600	Orange
CS0805-15N□-S	15	250	10 / 5 / 2	50	500	3400	0.17	600	Yellow
CS0805-18N□-S	18	250	10 / 5 / 2	50	500	3300	0.20	600	Green
CS0805-22N□-S	22	250	10 / 5 / 2	55	500	2600	0.22	500	Blue
CS0805-24N□-S	24	250	10 / 5 / 2	50	500	2000	0.22	500	Gray
CS0805-27N□-S	27	250	10 / 5 / 2	55	500	2500	0.25	500	Violet
CS0805-33N□-S	33	250	10 / 5 / 2	60	500	2050	0.27	500	Gray
CS0805-36N□-S	36	250	10 / 5 / 2	55	500	1700	0.27	500	Orange
CS0805-39N□-S	39	250	10 / 5 / 2	60	500	2000	0.29	500	White
CS0805-43N□-S	43	200	10 / 5 / 2	60	500	1650	0.34	500	Yellow
CS0805-47N□-S	47	200	10 / 5 / 2	60	500	1650	0.31	500	Black
CS0805-56N□-S	56	200	10 / 5 / 2	60	500	1550	0.34	500	Brown
CS0805-68N□-S	68	200	10 / 5 / 2	60	500	1450	0.38	500	Red
CS0805-82N□-S	82	150	10 / 5 / 2	65	500	1300	0.42	400	Orange
CS0805-91N□-S	91	150	10 / 5 / 2	65	500	1200	0.48	400	Black
CS0805-R10□-S	100	150	10 / 5 / 2	65	500	1200	0.46	400	Yellow
CS0805-R11□-S	110	150	10 / 5 / 2	50	250	1000	0.48	400	Brown
CS0805-R12□-S	120	150	10 / 5 / 2	50	250	1100	0.51	400	Green
CS0805-R15□-S	150	100	10 / 5 / 2	50	250	920	0.56	400	Blue
CS0805-R18□-S	180	100	10 / 5 / 2	50	250	870	0.64	400	Violet
CS0805-R20□-S	200	100	10 / 5 / 2	50	250	860	0.68	400	Red
CS0805-R22□-S	220	100	10 / 5 / 2	50	250	850	0.70	400	Gray
CS0805-R24□-S	240	100	10 / 5 / 2	44	250	690	1.00	350	Red
CS0805-R25□-S	250	100	10 / 5 / 2	45	250	660	1.20	350	Yellow
CS0805-R27□-S	270	100	10 / 5 / 2	48	250	650	1.00	350	White
CS0805-R33□-S	330	100	10 / 5 / 2	48	250	600	1.40	310	Black
CS0805-R39□-S	390	100	10 / 5 / 2	48	250	560	1.50	290	Brown
CS0805-R47□-S	470	50	10 / 5 / 2	33	100	375	1.76	250	Violet
CS0805-R51□-S	510	25	10 / 5 / 2	23	50	340	1.90	230	Gray
CS0805-R56□-S	560	25	10 / 5 / 2	23	50	340	1.90	230	Orange
CS0805-R62□-S	620	25	10 / 5 / 2	23	50	220	2.20	210	Yellow
CS0805-R68□-S	680	25	10 / 5 / 2	23	50	188	2.20	190	Green
CS0805-R82□-S	820	25	10 / 5 / 2	23	50	215	2.35	180	Blue

- When ordering, please specify tolerance and packaging codes.
- Tolerance : G = ±2% , J = ±5% , K = ±10%
- L/Q: Agilent E4991A +AgilentHP16197A
- SRF: Agilent/HP8753D / Agilent/HP4291A
- RDC: CH502BC/ HP4338B
- I rms for a 15°C rise above 25°C ambient.
- Operating temperature range from -40°C to 125°C. (Including self - temperature rise)

Electrical Characteristics

Part Number	Inductance (nH)	Test Frequency (MHz)	Tolerance (±%)	Q Min	Test Frequency (MHz)	SRF (MHz) Min	Rdc (Ω) Max	Irms (mA) Max	Color
CS0805-1R0□-S	1000	25	10 / 5 / 2	20	50	100	2.50	170	Gray
CS0805-1R2□-S	1200	7.9	10 / 5	18	25	100	2.50	170	White
CS0805-1R8□-S	1800	7.9	10 / 5 / 2	16	7.9	80	2.50	170	Orange
CS0805-3R3□-S	3300	7.9	10 / 5 / 2	15	7.9	40	4.40	90	Red
CS0805-4R7□-S	4700	7.9	10 / 5 / 2	15	7.9	40	6.40	90	Yellow

- When ordering, please specify tolerance and packaging codes.
- Tolerance : G = ±2% , J = ±5% , K = ±10%
- L/Q: Agilent E4991A +AgilentHP16197A
- SRF: Agilent/HP8753D / Agilent/HP4291A
- RDC: CH502BC/ HP4338B
- I rms for a 15°C rise above 25°C ambient.
- Operating temperature range from -40°C to 125°C . (Including self - temperature rise)

Electrical Characteristics

Part Number	Inductance (nH)	Test Frequency (MHz)	Tolerance (±%)	Q Min	Test Frequency (MHz)	SRF (MHz) Min	Rdc (Ω) Max	I _{rms} (mA) Max	Color Coding		
									1 ST	2 ND	3 RD
CS1008-10N□-S	10	50	10 / 5 / 2	50	500	4100	0.08	1000	Brown	Black	Black
CS1008-12N□-S	12	50	10 / 5 / 2	50	500	3300	0.09	1000	Brown	Red	Black
CS1008-15N□-S	15	50	10 / 5 / 2	50	500	2500	0.10	1000	Brown	Green	Black
CS1008-18N□-S	18	50	10 / 5 / 2	50	350	2500	0.11	1000	Brown	Gray	Black
CS1008-22N□-S	22	50	10 / 5 / 2	55	350	2400	0.12	1000	Red	Red	Black
CS1008-27N□-S	27	50	10 / 5 / 2	55	350	1600	0.13	1000	Red	Violet	Black
CS1008-33N□-S	33	50	10 / 5 / 2	60	350	1600	0.14	1000	Orange	Orange	Black
CS1008-39N□-S	39	50	10 / 5 / 2	60	350	1500	0.15	1000	Orange	White	Black
CS1008-47N□-S	47	50	10 / 5 / 2	65	350	1500	0.16	1000	Yellow	Violet	Black
CS1008-56N□-S	56	50	10 / 5 / 2	65	350	1300	0.18	1000	Green	Blue	Black
CS1008-68N□-S	68	50	10 / 5 / 2	65	350	1300	0.20	1000	Blue	Gray	Black
CS1008-82N□-S	82	50	10 / 5 / 2	60	350	1000	0.22	1000	Gray	Red	Black
CS1008-R10□-S	100	25	10 / 5 / 2	60	350	1000	0.56	650	Brown	Black	Brown
CS1008-R12□-S	120	25	10 / 5 / 2	60	350	950	0.63	650	Brown	Red	Brown
CS1008-R15□-S	150	25	10 / 5 / 2	45	100	850	0.70	580	Brown	Green	Brown
CS1008-R18□-S	180	25	10 / 5 / 2	45	100	750	0.77	620	Brown	Gray	Brown
CS1008-R20□-S	200	25	10 / 5 / 2	45	100	700	0.84	500	Red	Black	Brown
CS1008-R22□-S	220	25	10 / 5 / 2	45	100	700	0.84	500	Red	Red	Brown
CS1008-R27□-S	270	25	10 / 5 / 2	45	100	600	0.91	500	Red	Violet	Brown
CS1008-R33□-S	330	25	10 / 5 / 2	45	100	570	1.05	450	Orange	Orange	Brown
CS1008-R39□-S	390	25	10 / 5 / 2	45	100	500	1.12	470	Orange	White	Brown
CS1008-R47□-S	470	25	10 / 5 / 2	45	100	450	1.19	470	Yellow	Violet	Brown
CS1008-R56□-S	560	25	10 / 5 / 2	45	100	415	1.33	400	Green	Blue	Brown
CS1008-R62□-S	620	25	10 / 5 / 2	45	100	375	1.40	300	Blue	Red	Brown
CS1008-R68□-S	680	25	10 / 5 / 2	45	100	375	1.47	400	Blue	Gray	Brown
CS1008-R75□-S	750	25	10 / 5 / 2	45	100	360	1.54	360	Violet	Green	Brown
CS1008-R82□-S	820	25	10 / 5 / 2	45	100	350	1.61	400	Gray	Red	Brown
CS1008-R91□-S	910	25	10 / 5 / 2	35	50	320	1.68	380	White	Brown	Brown
CS1008-1R0□-S	1000	25	10 / 5 / 2	35	50	290	1.75	370	Brown	Black	Red
CS1008-1R2□-S	1200	7.9	10 / 5 / 2	35	50	250	2.0	310	Brown	Red	Red
CS1008-1R5□-S	1500	7.9	10 / 5 / 2	28	50	200	2.3	330	Brown	Green	Red
CS1008-1R8□-S	1800	7.9	10 / 5 / 2	28	50	160	2.6	300	Brown	Gray	Red
CS1008-2R2□-S	2200	7.9	10 / 5 / 2	28	50	160	2.8	280	Red	Red	Red
CS1008-2R7□-S	2700	7.9	10 / 5 / 2	22	25	140	3.2	290	Red	Violet	Red
CS1008-3R3□-S	3300	7.9	10 / 5 / 2	22	25	110	3.4	290	Orange	Orange	Red
CS1008-3R9□-S	3900	7.9	10 / 5 / 2	20	25	100	3.6	260	Orange	White	Red
CS1008-4R7□-S	4700	7.9	10 / 5 / 2	20	25	90	4.0	260	Yellow	Violet	Red
CS1008-5R6□-S	5600	7.9	10 / 5 / 2	18	7.9	45	4.0	240	Green	Blue	Red
CS1008-6R8□-S	6800	7.9	10 / 5 / 2	18	7.9	40	4.9	200	Blue	Gray	Red
CS1008-8R2□-S	8200	7.9	10 / 5 / 2	18	7.9	25	6.0	170	Gray	Red	Red
CS1008-100□-S	10000	2.52	10 / 5 / 2	18	7.9	25	8.0	150	Brown	Black	Orange
CS1008-150□-S	15000	2.52	10 / 5 / 2	15	7.9	20	11	100	Brown	Brown	Orange

- When ordering, please specify tolerance and packaging codes
- Tolerance : G = ±2% , J = ±5% , K = ±10%
- Packaging: Clear tape and reel {standard}
- L/Q: Agilent E4991A + AgilentHP16197A
- SRF: Agilent/HP8753D / Agilent/HP4291A
- RDC: CH502BC/ HP4338B
- I_{rms} for a 15°C rise above 25°C ambient
- Operating temperature range from -40°C to 125°C. (Including self - temperature rise)
- Inductance would be correct Chilisin standard piece

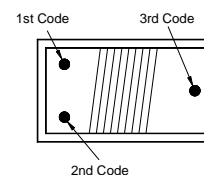

COLOR CODING



SMD Wire Wound Ceramic Chip Inductors - CS Series

Test Instruments : Agilent E4991A Material/Impedance Analyzer

CS0402

Typical **L** vs. **F** Frequency

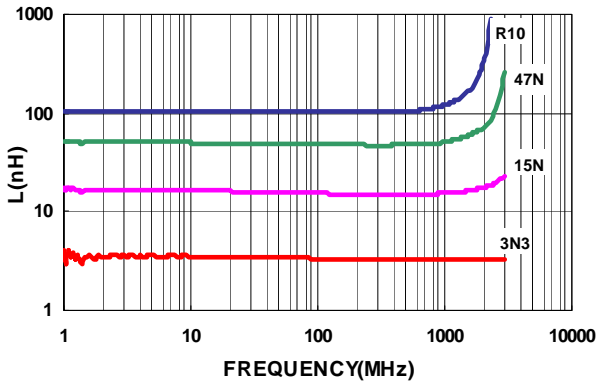

Typical **Q** vs. **F** Frequency

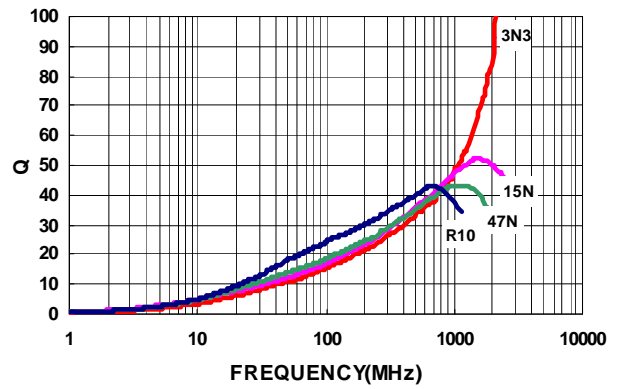

CS0603

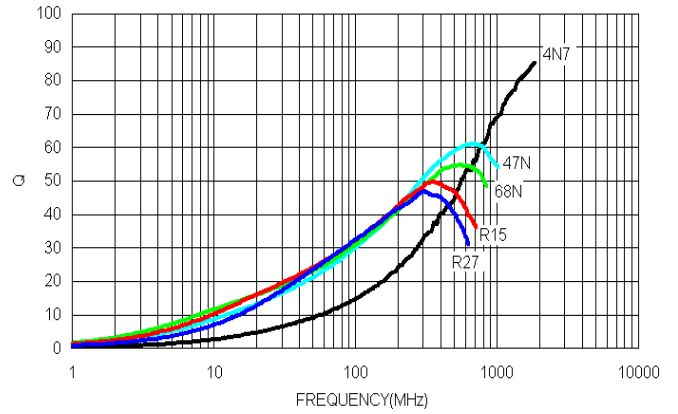
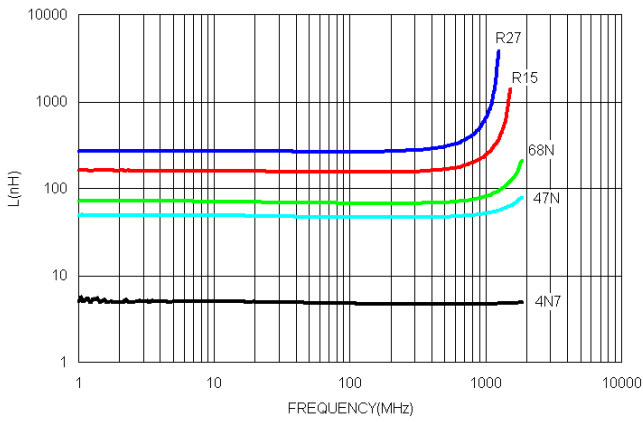

CS0805

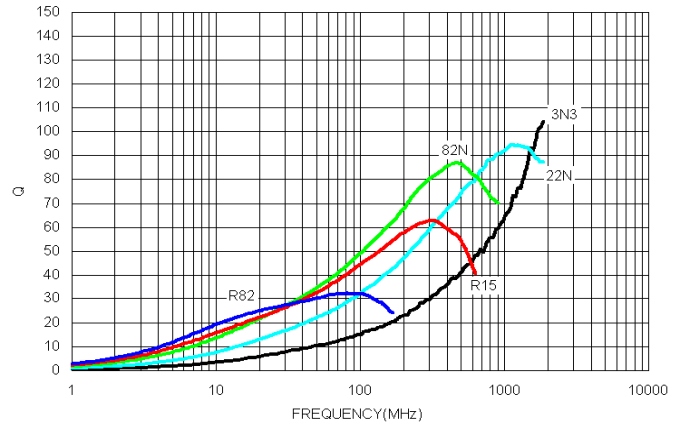
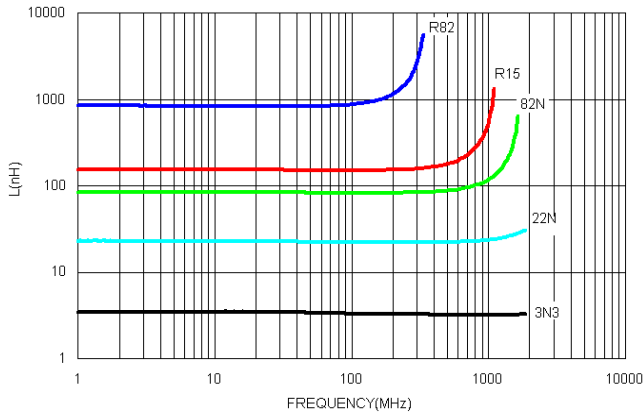

CS1008

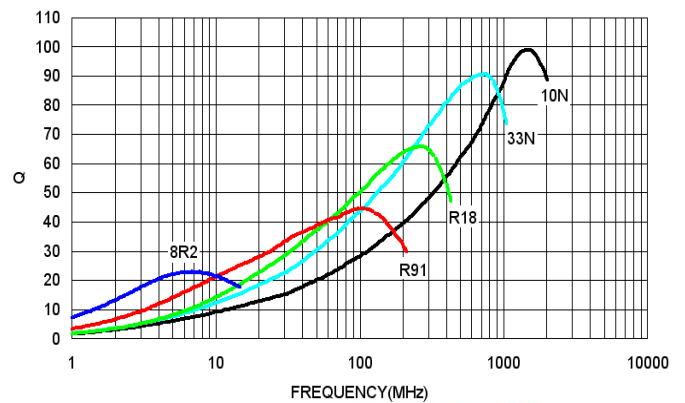
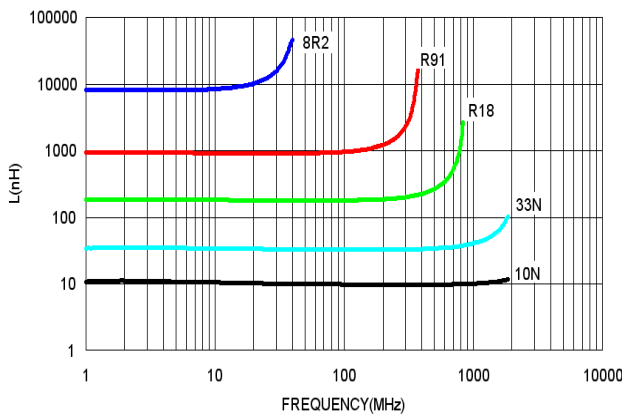

Packaging Specifications

Tape Dimensions

Figure 1

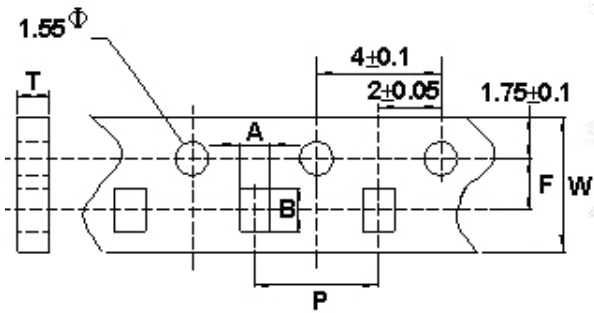

Tape Material

Carrier Tape: Polycarbonate
Cover Tape: Polystyrene

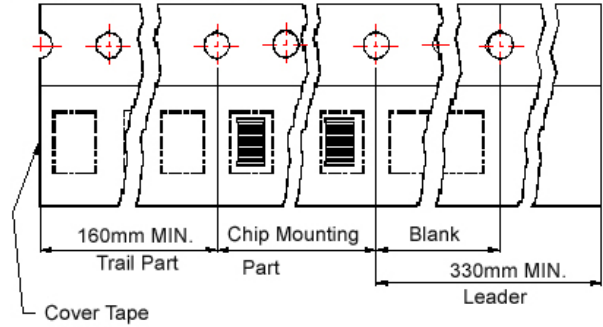
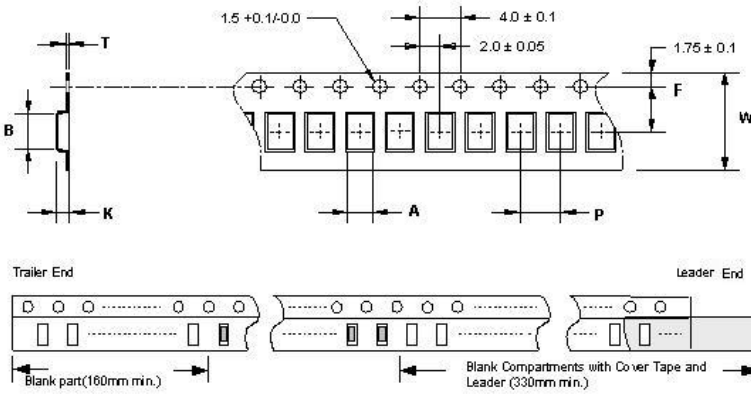
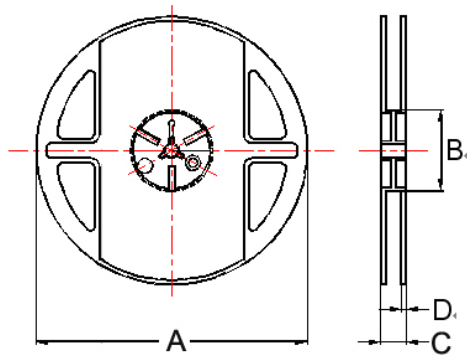

Figure 2



Reel Dimensions



Dimensions in mm

TYPE	Fig.	Tape Dimensions							Reel Dimensions				Quantity PCS / Reel
		A	B	T	W	P	F	K	A	B	C	D	
CS0402	2	0.67	1.20	0.75	8	2	3.5	0.53	178	60	12	1.5	4000
CS0603	1	1.20	1.80	0.97	8	4	3.5	-	178	60	12	1.5	4000
CS0805	2	1.85	2.45	0.23	8	4	3.5	1.50	178	60	12	1.5	2000
CS1008	2	2.80	2.95	0.23	8	4	3.5	2.20	178	60	12	1.5	2000

PM Series



Due to accurate wire winding technology, these chip inductors are designed for filtering, impedance matching, resonance and choke circuits for RF designer. Both standard series custom designs are available.

Features

- RoHS Compliant and Halogen Free
- Ceramic body and wire wound construction provide high Q and SRFs
- Higher Q and lower DCR than other inductors
- Exceptional current handling capability
- PM series is for high power and high frequency application

Applications

- Wireless embedded portable devices
- GPS receiver
- Base Station
- Repeater
- Set Top Box
- Cable / IP Modem
- Security system and other RF modules

Product Identification

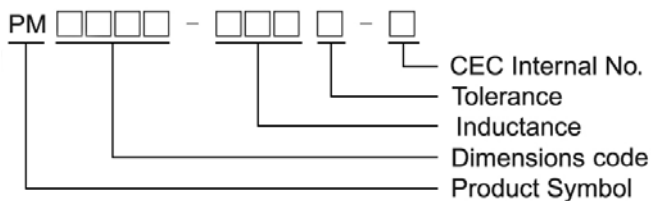

Shape and Dimensions / Recommended Pattern

PM0603

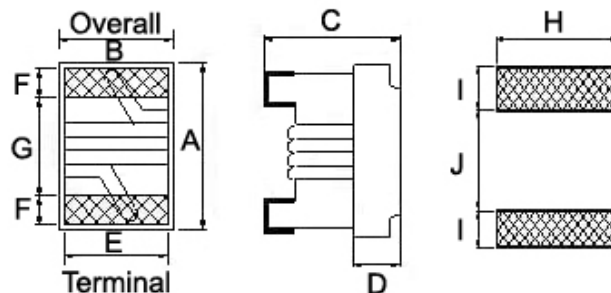

Dimensions

	A	B	C	D	E	F	G	H	I	J
PM0603	1.6 ^{+0.2} _{-0.1}	1.12 ± 0.1	0.82 ^{+0.2} _{-0.1}	0.30	0.95	0.30	0.70	1.02	0.64	0.64

Electrical Characteristics

Part Number	Inductance (nH)	Test Frequency (MHz)	Tolerance (±%)	Q Min	Test Frequency (MHz)	SRF (GHz) Min	Rdc (Ω) Max	Irms (mA) Max	Color
PM0603-2N2□-N	2.2	100	±0.5nH	25	250	18	0.018	1400	Black
PM0603-3N9□-N	3.9	100	±0.2nH/±0.5nH	38	250	11	0.032	1000	Brown
PM0603-5N6□-N	5.6	100	±0.5nH	38	250	10	0.045	900	Red
PM0603-6N8□-N	6.8	100	±0.2nH/±0.5nH	38	250	7	0.045	900	Orange
PM0603-8N2□-N	8.2	100	±0.5nH	38	250	7	0.058	800	Yellow
PM0603-10N□-N	10	100	5 / 2	38	250	5	0.058	800	Green
PM0603-12N□-N	12	100	5 / 2	38	250	5	0.071	750	Blue
PM0603-15N□-N	15	100	5	42	250	4.5	0.085	700	Violet
PM0603-18N□-N	18	100	5 / 2	42	250	3.5	0.085	700	Gray
PM0603-22N□-N	22	100	5 / 2	42	250	3.2	0.099	640	White
PM0603-27N□-N	27	100	5 / 2	42	250	2.8	0.116	590	Black
PM0603-33N□-N	33	100	5	42	250	2.5	0.132	550	Brown

- When ordering, please specify tolerance and packaging codes.
- Tolerance : G = ±2% , J = ±5% , C = ±0.2nH , D = ±0.5nH
- L , Q : Agilent E4991A + Agilent HP16197A
- SRF : HP8753D / Agilent/E5071C
- Rdc : Chroma16502
- Irms for a 15°C rise above 25°C ambient.
- Operating temperature range from -40°C to 125°C. (Including self - temperature rise)

Typical **L** vs. **F** Frequency

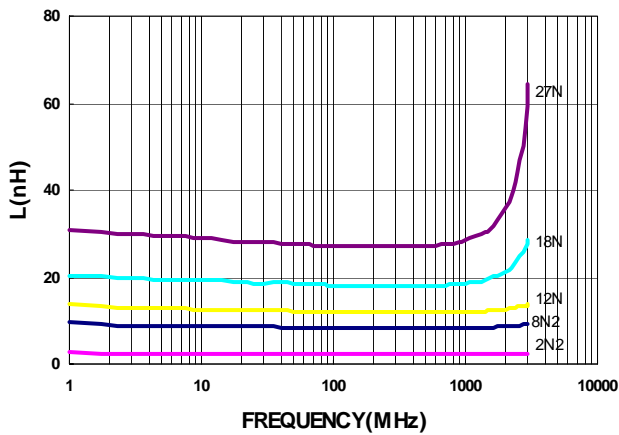

Typical **Q** vs. **F** Frequency

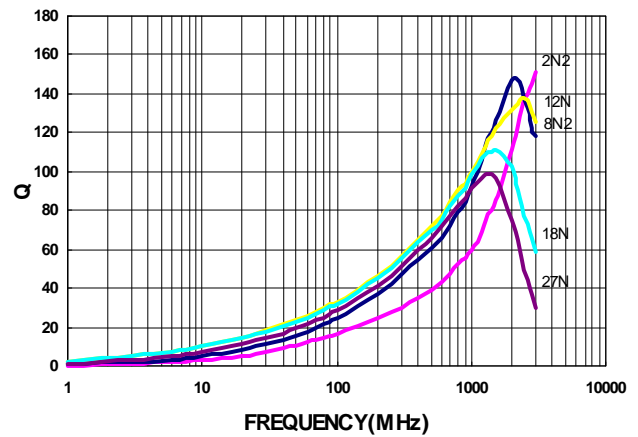

Packaging Specifications

Tape Dimensions

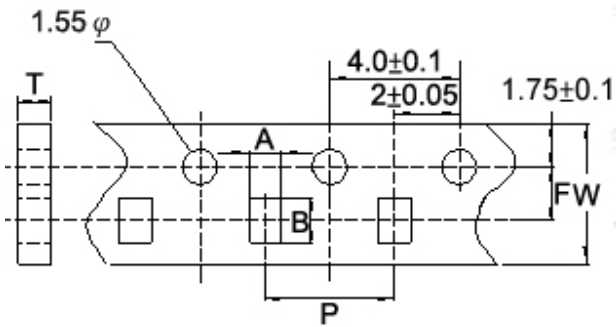

Tape Material

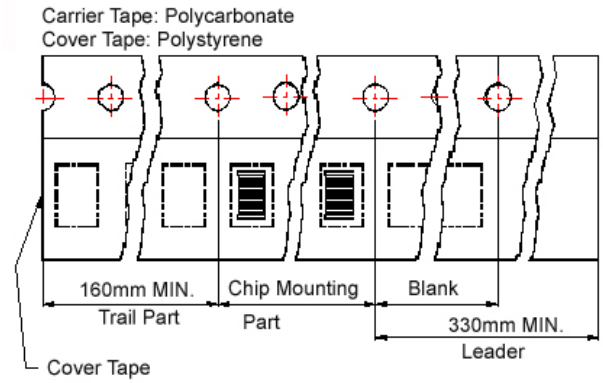

Reel Dimensions

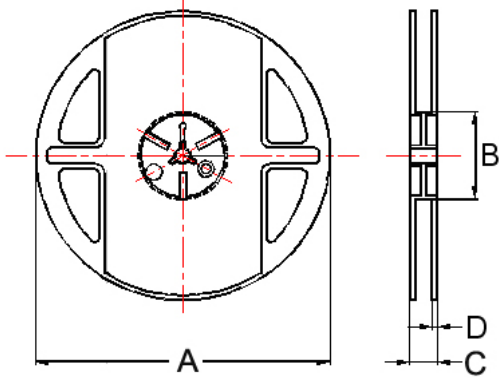

Dimensions in mm

TYPE	Tape Dimensions						Reel Dimensions				Quantity PCS / Reel
	A	B	T	W	P	F	A	B	C	D	
PM0603	1.23	1.90	0.97	8	4	3.5	178	60	12	1.5	4000

HP Series



Due to accurate wire winding technology, these chip inductors are designed for filtering, impedance matching, resonance and choke circuits for RF designer. Both standard series custom designs are available.

Features

- RoHS Compliant and Halogen Free
- Ceramic body and wire wound construction provide high Q and SRFs
- Higher Q and lower DCR than other inductors
- Exceptional current handling capability
- HP series is for high power and high frequency application

Applications

- Wireless embedded portable devices
- GPS receiver
- Base Station
- Repeater
- Set Top Box
- Cable / IP Modem
- Security system and other RF modules

Product Identification

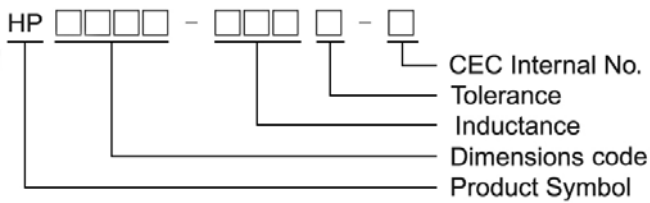

Shape and Dimensions / Recommended Pattern

HP0402

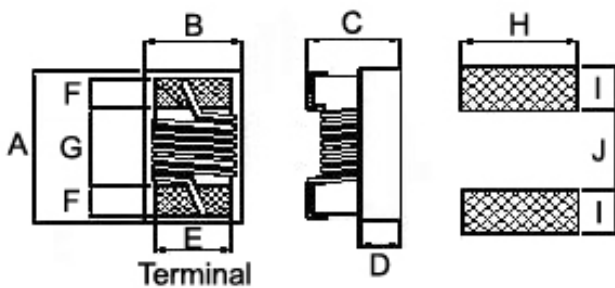

HP0603

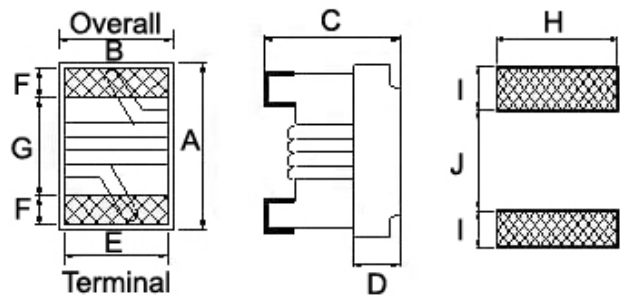

Dimensions

	A	B	C	D	E	F	G	H	I	J
HP0402	1.1 ± 0.05	0.70 ± 0.05	0.6 ± 0.05	0.25	0.54	0.20	0.45	0.66	0.36	0.51
HP0603	1.6 ^{+0.2} _{-0.1}	1.02 ± 0.1	0.82 ^{+0.2} _{-0.1}	0.35	0.70	0.30	0.95	1.02	0.64	0.64

Electrical Characteristics

Part Number	Inductance (nH)	Test Frequency (MHz)	Tolerance (±%)	Q Min	Test Frequency (MHz)	SRF (GHz) Min	Rdc (Ω) Max	Irms (mA) Max
HP0402-1N0□-N	1.0	250	±0.1nH	18	250	16.0	0.030	2300
HP0402-2N0□-N	2.0	250	±0.2nH	18	250	15.2	0.038	2100
HP0402-2N2□-N	2.2	250	±0.2nH	25	250	15.1	0.045	2100
HP0402-2N4□-N	2.4	250	±0.2nH	25	250	14.0	0.045	2000
HP0402-2N7□-N	2.7	250	±0.2nH	20	250	13.0	0.090	1500
HP0402-3N3□-N	3.3	250	3 / 5	20	250	12.8	0.050	1700
HP0402-3N6□-N	3.6	250	3 / 5	28	250	11.7	0.065	1700
HP0402-3N9□-N	3.9	250	3 / 5	28	250	9.50	0.065	1700
HP0402-4N3□-N	4.3	250	3 / 5	22	250	7.15	0.060	1600
HP0402-4N7□-N	4.7	250	3 / 5	18	250	6.85	0.115	1500
HP0402-5N1□-N	5.1	250	3 / 5	20	250	6.80	0.125	1200
HP0402-5N6□-N	5.6	250	3 / 5	28	250	6.80	0.070	1600
HP0402-6N2□-N	6.2	250	3 / 5	25	250	5.80	0.070	1600
HP0402-6N8□-N	6.8	250	3 / 5	25	250	5.80	0.095	1500
HP0402-7N5□-N	7.5	250	3 / 5	25	250	5.40	0.130	1400
HP0402-8N2□-N	8.2	250	3 / 5	30	250	5.40	0.080	1500
HP0402-8N7□-N	8.7	250	3 / 5	30	250	5.00	0.085	1500
HP0402-9N0□-N	9.0	250	3 / 5	28	250	5.00	0.090	1400
HP0402-9N5□-N	9.5	250	3 / 5	30	250	4.70	0.095	1400
HP0402-10N□-N	10	250	3 / 5	30	250	4.70	0.120	1300
HP0402-11N□-N	11	250	3 / 5	30	250	4.70	0.095	1400
HP0402-12N□-N	12	250	3 / 5	25	250	4.40	0.110	1200
HP0402-13N□-N	13	250	3 / 5	30	250	4.20	0.140	870
HP0402-15N□-N	15	250	3 / 5	30	250	3.90	0.130	1100
HP0402-16N□-N	16	250	3 / 5	30	250	3.70	0.150	850
HP0402-18N□-N	18	250	3 / 5	30	250	3.55	0.160	900
HP0402-19N□-N	19	250	3 / 5	30	250	3.50	0.175	850
HP0402-20N□-N	20	250	3 / 5	30	250	3.50	0.220	780
HP0402-21N□-N	21	250	3 / 5	30	250	1.70	0.360	450
HP0402-22N□-N	22	250	3 / 5	30	250	3.30	0.210	800
HP0402-23N□-N	23	250	3 / 5	30	250	3.15	0.210	700
HP0402-24N□-N	24	250	3 / 5	30	250	3.15	0.260	700
HP0402-25N□-N	25	250	3 / 5	30	250	3.15	0.310	700
HP0402-26N□-N	26	250	3 / 5	30	250	3.15	0.275	700
HP0402-27N□-N	27	250	3 / 5	30	250	3.20	0.300	450
HP0402-30N□-N	30	250	3 / 5	30	250	2.90	0.350	450
HP0402-33N□-N	33	250	3 / 5	30	250	2.80	0.380	490
HP0402-36N□-N	36	250	3 / 5	30	250	2.80	0.480	480
HP0402-37N□-N	37	250	3 / 5	30	250	2.70	0.490	470
HP0402-39N□-N	39	250	3 / 5	30	250	2.60	0.520	450
HP0402-40N□-N	40	250	3 / 5	30	250	2.60	0.520	450
HP0402-43N□-N	43	250	3 / 5	30	250	2.50	0.720	450
HP0402-47N□-N	47	250	3 / 5	30	250	2.40	0.720	420
HP0402-51N□-N	51	250	3 / 5	30	250	2.30	0.980	360

- When ordering, please specify tolerance and packaging codes.
- Tolerance : H = ±3% , J = ±5% , B = ±0.1nH , C = ±0.2nH
- L , Q : Agilent E4991A + Agilent HP16197A
- SRF : Agilent/HP8753D / Agilent/HP8722ES
- Rdc : Chroma16502
- Irms for a 15°C rise above 25°C ambient.
- Operating temperature range from -40°C to 125°C. (Including self - temperature rise)

Electrical Characteristics

Part Number	Inductance (nH)	Test Frequency (MHz)	Tolerance (±%)	Q Typ	Test Frequency (MHz)	SRF (GHz) Typ	Rdc (Ω) Max	Irms (mA) Max	Color
HP0603-1N8□-N	1.8	250	5	23	250	16.0	0.033	2100	Black
HP0603-2N2□-N	2.2	250	5	13	250	15.0	0.182	900	Brown
HP0603-3N9□-N	3.9	250	5	26	250	7.50	0.062	1600	Red
HP0603-4N3□-N	4.3	250	3 / 5	26	250	7.50	0.088	1300	Orange
HP0603-4N7□-N	4.7	250	3 / 5	25	250	7.90	0.130	1100	Yellow
HP0603-6N8□-N	6.8	250	3 / 5	40	250	5.80	0.065	1400	Green
HP0603-7N2□-N	7.2	250	3 / 5	32	250	5.40	0.100	1400	Blue
HP0603-7N5□-N	7.5	250	3 / 5	32	250	5.30	0.100	1300	Violet
HP0603-11N□-N	11	250	3 / 5	41	250	4.10	0.086	1400	Gray
HP0603-15N□-N	15	250	3 / 5	42	250	3.60	0.110	1200	White
HP0603-16N□-N	16	250	3 / 5	40	250	3.50	0.125	1100	Black
HP0603-22N□-N	22	250	3 / 5	40	250	3.15	0.195	850	Brown
HP0603-23N□-N	23	250	3 / 5	40	250	3.00	0.150	850	Red
HP0603-24N□-N	24	250	3 / 5	42	250	2.95	0.125	1100	Orange
HP0603-27N□-N	27	250	3 / 5	42	250	2.80	0.200	780	Yellow
HP0603-30N□-N	30	250	3 / 5	49	250	2.80	0.130	920	Green
HP0603-33N□-N	33	250	3 / 5	45	250	2.70	0.170	680	Blue
HP0603-36N□-N	36	250	3 / 5	44	250	2.50	0.225	720	Violet
HP0603-39N□-N	39	250	3 / 5	48	250	2.45	0.190	680	Gray
HP0603-43N□-N	43	250	3 / 5	45	250	2.45	0.225	810	White
HP0603-47N□-N	47	200	3 / 5	43	250	2.30	0.240	680	Black
HP0603-51N□-N	51	200	3 / 5	42	250	2.30	0.280	660	Brown
HP0603-56N□-N	56	200	3 / 5	43	250	2.20	0.300	610	Red
HP0603-68N□-N	68	200	3 / 5	43	250	2.00	0.330	600	Orange
HP0603-72N□-N	72	150	3 / 5	37	250	1.90	0.420	550	Yellow
HP0603-75N□-N	75	150	3 / 5	37	250	1.90	0.520	500	Green
HP0603-82N□-N	82	150	3 / 5	38	250	1.80	0.460	510	Blue
HP0603-91N□-N	91	150	3 / 5	45	250	1.65	0.580	440	Violet
HP0603-R10□-N	100	150	3 / 5	49	250	1.70	0.540	470	Gray
HP0603-R11□-N	110	150	3 / 5	47	250	1.60	0.620	440	White
HP0603-R12□-N	120	150	3 / 5	47	250	1.55	0.720	420	Black
HP0603-R15□-N	150	150	3 / 5	47	250	1.35	1.150	390	Brown
HP0603-R18□-N	180	100	3 / 5	48	250	1.30	1.500	310	Red
HP0603-R20□-N	200	100	3 / 5	47	250	1.25	2.000	280	Orange
HP0603-R21□-N	210	100	3 / 5	48	250	1.20	2.000	280	Yellow
HP0603-R22□-N	220	100	3 / 5	47	250	1.10	2.000	280	Green
HP0603-R25□-N	250	100	3 / 5	45	250	1.05	3.000	240	Blue
HP0603-R27□-N	270	100	3 / 5	46	250	1.05	2.250	260	Violet
HP0603-R30□-N	300	100	3 / 5	47	250	0.99	2.800	220	Gray
HP0603-R33□-N	330	100	3 / 5	46	250	0.93	3.600	180	White
HP0603-R36□-N	360	100	3 / 5	47	250	0.93	4.000	170	Black
HP0603-R39□-N	390	100	3 / 5	47	250	0.88	4.000	170	Brown

- When ordering, please specify tolerance and packaging codes.
- Tolerance : H = ±3% , J = ±5%
- L , Q : Agilent E4991A + Agilent HP16197A
- SRF : Agilent/HP8753D / Agilent/HP8722ES
- Rdc : Chroma16502
- Irms for a 15°C rise above 25°C ambient.
- Operating temperature range from -40°C to 125°C. (Including self - temperature rise)

SMD Wire Wound Ceramic Chip Inductors - HP Series

Test Instruments : Agilent E4991A Material/Impedance Analyzer

HP0402

Typical **L** vs. **F** Frequency

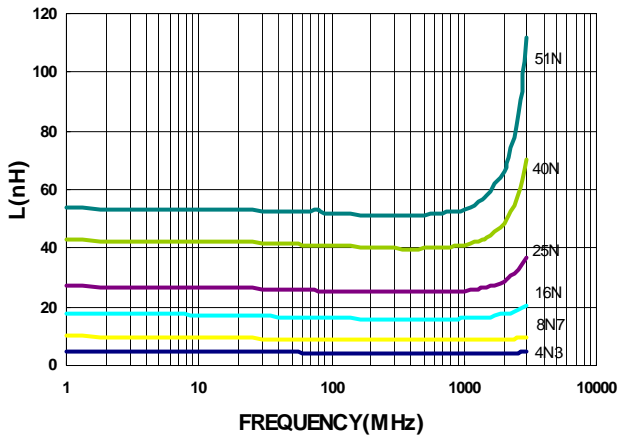

Typical **Q** vs. **F** Frequency

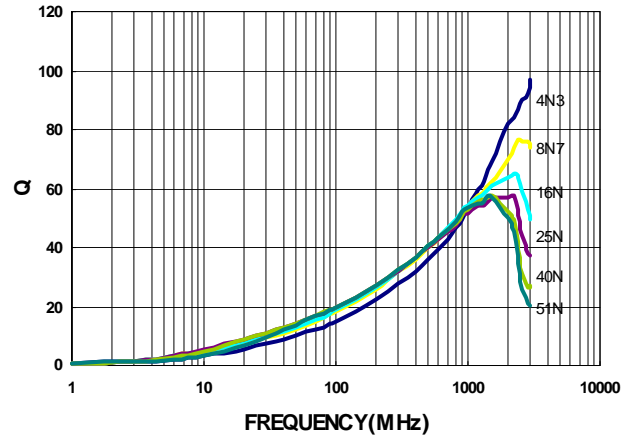

HP0603

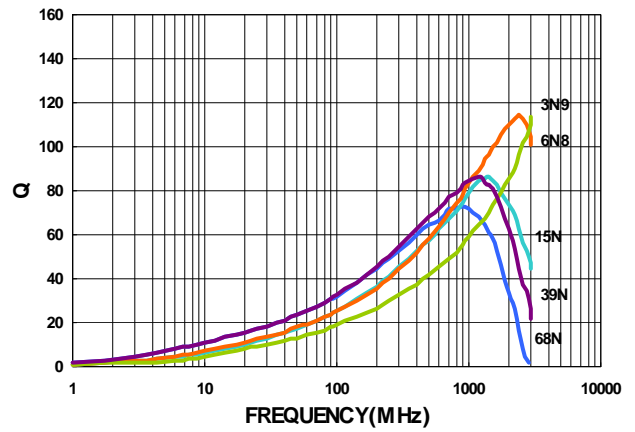
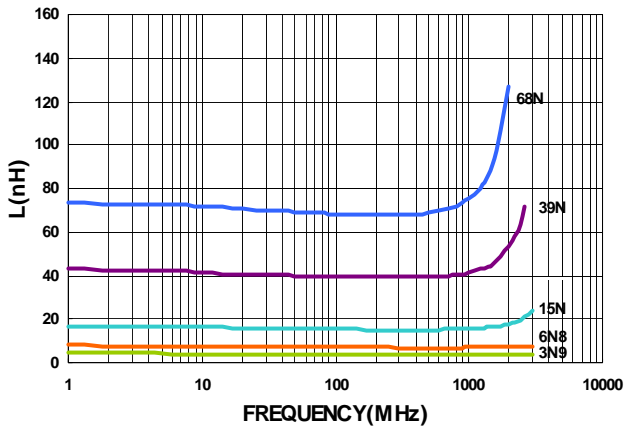

Packaging Specifications

Tape Dimensions

Figure 1

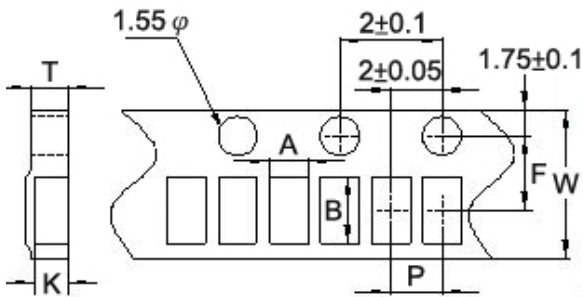

Tape Material

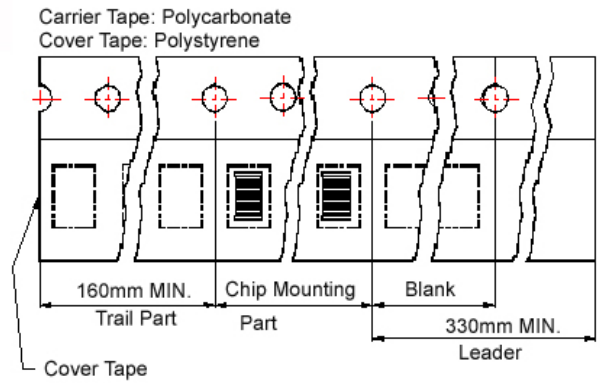
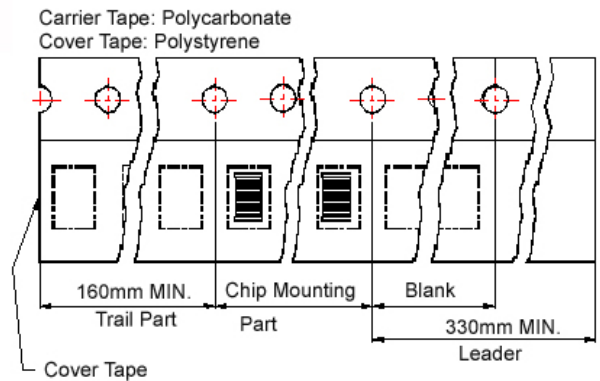
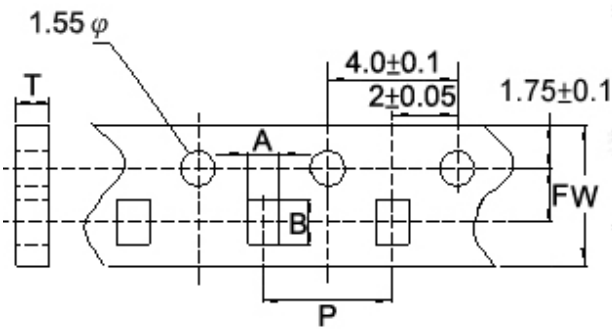
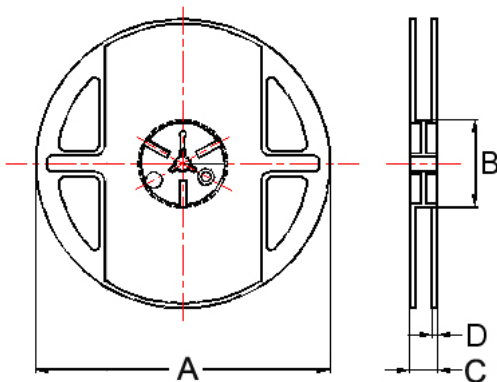

Figure 2



Reel Dimensions



Dimensions in mm

TYPE	Fig.	Tape Dimensions							Reel Dimensions				Quantity PCS / Reel
		A	B	T	W	P	F	K	A	B	C	D	
HP0402	1	0.83	1.20	0.75	8	2	3.5	0.64	178	60	12	1.5	4000
HP0603	2	1.20	1.80	0.97	8	4	3.5	-	178	60	12	1.5	4000

HPH Series



Due to accurate wire winding technology, these chip inductors are designed for filtering, impedance matching, resonance and choke circuits for RF designer. Both standard series custom designs are available.

Features

- RoHS Compliant and Halogen Free
- Ceramic body and wire wound construction provide high Q and SRFs
- Higher Q and lower DCR than other inductors
- Exceptional current handling capability
- HPH series is for high power and high frequency application

Applications

- Wireless embedded portable devices
- GPS receiver
- Base Station
- Repeater
- Set Top Box
- Cable / IP Modem
- Security system and other RF modules

Product Identification

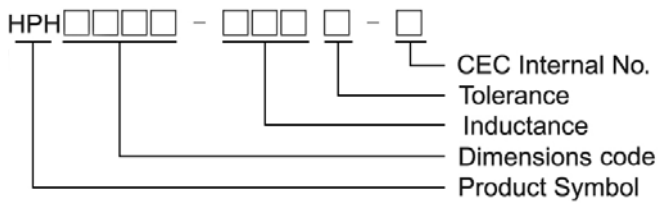

Shape and Dimensions / Recommended Pattern

HPH0603

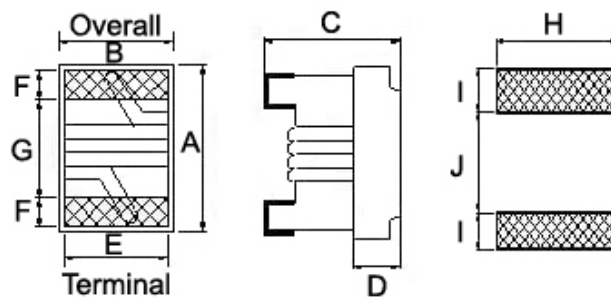

Dimensions

	A	B	C	D	E	F	G	H	I	J
HPH0603	1.6 ^{+0.2} _{-0.1}	1.12 ± 0.1	0.82 ^{+0.2} _{-0.1}	0.30	0.70	0.30	0.95	1.02	0.64	0.64

Electrical Characteristics

Part Number	Inductance (nH)	Test Frequency (MHz)	Tolerance (±%)	Q Typ	Test Frequency (MHz)	SRF (GHz) Typ	Rdc (Ω) Max	Irms (mA) Max
HPH0603-3N3□-N	3.3	250	5 / 3	36	250	9.6	0.034	1900
HPH0603-3N6□-N	3.6	250	5 / 3	28	250	9.7	0.040	1900
HPH0603-5N1□-N	5.1	250	5 / 3	38	250	8.9	0.042	1700
HPH0603-5N6□-N	5.6	250	5 / 3	35	250	6.6	0.042	1700
HPH0603-6N0□-N	6.0	250	5 / 3	49	250	6.0	0.042	1700
HPH0603-8N2□-N	8.2	250	5 / 3	40	250	5.9	0.054	1400
HPH0603-8N7□-N	8.7	250	5 / 3	46	250	5.5	0.054	1400
HPH0603-9N1□-N	9.1	250	5 / 3	40	250	5.1	0.052	1400
HPH0603-9N5□-N	9.5	250	5 / 3	42	250	4.9	0.054	1400
HPH0603-10N□-N	10	250	5 / 3	44	250	4.3	0.054	1400
HPH0603-12N□-N	12	250	5 / 3	40	250	4.1	0.088	1100
HPH0603-18N□-N	18	250	5 / 3	45	250	3.3	0.082	1200

- When ordering, please specify tolerance and packaging codes.
- Tolerance : H = ±3% , J = ±5%
- L , Q : Agilent E4991A + Agilent HP16197A
- SRF : Agilent/E5071C
- Rdc : Chroma16502
- I rms for a 15°C rise above 25°C ambient.
- Operating temperature range from -40°C to 125°C . (Including self - temperature rise)

Typical **L** vs. **F** Frequency

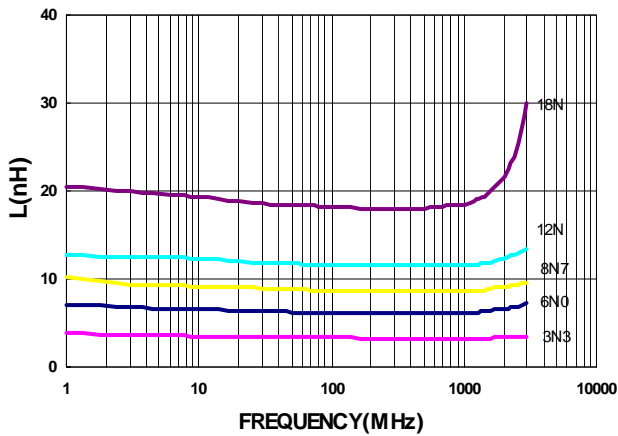

Typical **Q** vs. **F** Frequency

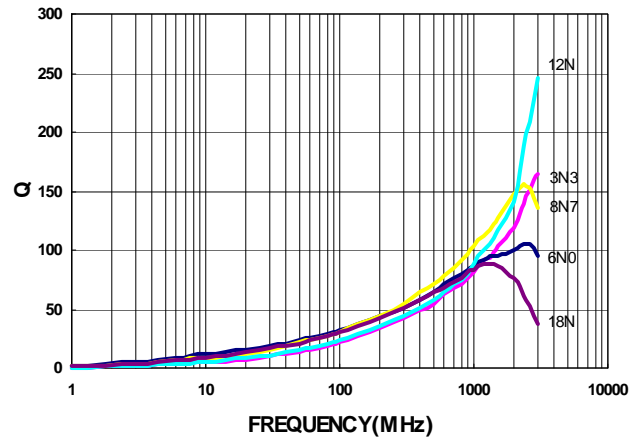

Packaging Specifications

Tape Dimensions

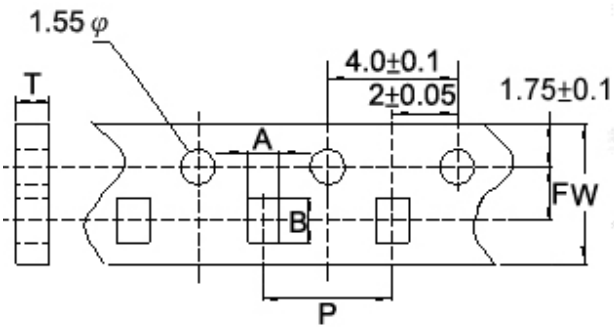

Tape Material

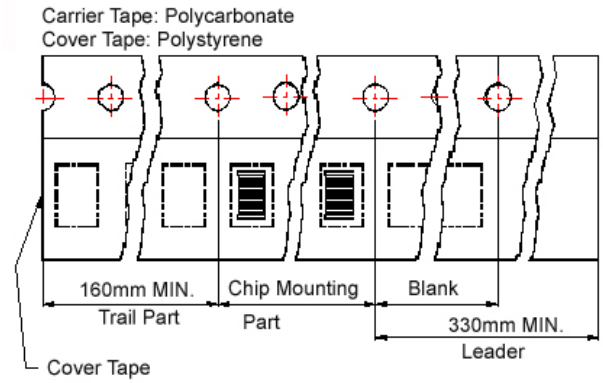

Reel Dimensions

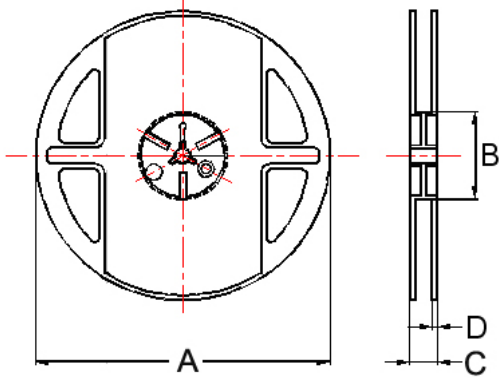

Dimensions in mm

TYPE	Tape Dimensions						Reel Dimensions				Quantity PCS / Reel
	A	B	T	W	P	F	A	B	C	D	
HPH0603	1.23	1.90	0.97	8	4	3.5	178	60	12	1.5	4000

CT Series



Due to accurate wire winding technology, these chip inductors are designed for filtering, impedance matching, resonance and choke circuits for RF designer. Both standard series custom designs are available.

Features

- RoHS compliant.
- Ceramic body and wire wound construction provide highest SRFs
- Exceptional Q values even at high frequencies
- Highest possible SRFs as well as excellent Q values
- The non-magnetic coil form assures utmost thermal stability, predictability and batch consistency

Applications

- RF products for cellular phone
- GPS receiver
- Base Station
- Repeater
- Wireless LAN/ mouse/ keyboard/ earphone
- Remote control
- Security system and other RF modules

Product Identification

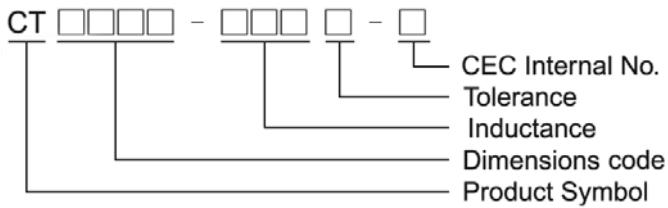

Shape and Dimensions/ Recommended Pattern

CT0805

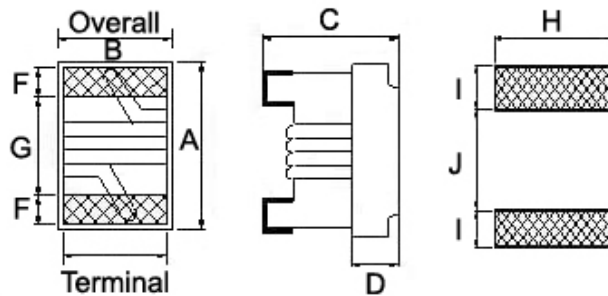

Dimensions

		A Max	B Max	C Max	D	E	F	G	H	I	J
CT0805	inch	0.093	0.068	0.039	0.020	0.050	0.020	0.040	0.070	0.040	0.030
	mm	2.35	1.73	1.10	0.51	1.27	0.51	1.02	1.78	1.02	0.76

Electrical Characteristics

Part Number	Inductance (nH)	Test Frequency (MHz)	Tolerance (±%)	Q Min	Test Frequency (MHz)	SRF (MHz) Min	Rdc (Ω) Max	Irms (mA) Max	Color
CT0805-1N8□-S	1.8	250	10	55	1500	9400	0.03	800	Black
CT0805-3N9□-S	3.9	250	10	50	1000	6100	0.06	800	Brown
CT0805-4N7□-S	4.7	250	10 / 5	50	1000	5500	0.06	800	Red
CT0805-6N8□-S	6.8	250	10 / 5	50	1000	5500	0.08	800	Orange
CT0805-8N2□-S	8.2	250	10 / 5	50	1000	4800	0.08	800	Yellow
CT0805-10N□-S	10	250	10 / 5 / 2	55	750	3300	0.08	800	Green
CT0805-12N□-S	12	250	10 / 5 / 2	55	750	3800	0.10	800	Blue
CT0805-15N□-S	15	250	10 / 5 / 2	50	500	2950	0.10	800	Violet
CT0805-18N□-S	18	250	10 / 5 / 2	50	500	3100	0.13	800	Gray
CT0805-22N□-S	22	250	10 / 5 / 2	50	500	2900	0.15	800	White
CT0805-27N□-S	27	250	10 / 5 / 2	50	500	2450	0.23	600	Black
CT0805-33N□-S	33	250	10 / 5 / 2	55	500	2350	0.28	600	Brown
CT0805-39N□-S	39	250	10 / 5 / 2	55	500	2200	0.33	600	Red
CT0805-47N□-S	47	200	10 / 5 / 2	50	500	2000	0.39	600	Orange
CT0805-56N□-S	56	200	10 / 5 / 2	50	500	1850	0.39	500	Yellow
CT0805-68N□-S	68	200	10 / 5 / 2	50	500	1500	0.40	500	Green
CT0805-82N□-S	82	150	10 / 5 / 2	50	500	1500	0.44	500	Blue
CT0805-R10□-S	100	150	10 / 5 / 2	50	500	1200	0.64	400	Violet
CT0805-R12□-S	120	150	10 / 5 / 2	40	250	1150	0.68	300	Gray
CT0805-R15□-S	150	150	10 / 5 / 2	40	250	1050	0.80	300	White
CT0805-R18□-S	180	150	10 / 5 / 2	40	250	950	0.90	300	Black
CT0805-R22□-S	220	150	10 / 5 / 2	40	250	900	0.98	300	Brown
CT0805-R27□-S	270	150	10 / 5 / 2	40	250	850	1.30	300	Red
CT0805-R33□-S	330	100	10 / 5 / 2	40	250	800	1.45	300	Orange
CT0805-R39□-S	390	100	10 / 5 / 2	35	250	700	1.60	300	Yellow
CT0805-R47□-S	470	50	10 / 5 / 2	25	100	600	1.80	300	Green
CT0805-R56□-S	560	25	10 / 5 / 2	18	50	550	1.90	300	Blue
CT0805-R62□-S	620	25	10 / 5 / 2	18	50	450	2.00	300	Violet
CT0805-R68□-S	680	25	10 / 5 / 2	18	50	420	2.10	300	Gray
CT0805-R75□-S	750	25	10 / 5 / 2	18	50	400	2.20	300	White
CT0805-R82□-S	820	25	10 / 5 / 2	18	50	400	2.50	300	Black
CT0805-1R0□-S	1000	25	10 / 5	17	50	330	3.10	300	Brown

- When ordering, please specify tolerance and packaging codes.
- Tolerance: G = ±2%, J = ±5% , K = ±10%
- L/Q: Agilent E4991A+ Agilent HP16197A
- SRF: Agilent/HP8753D / Agilent E4991A
- RDC: CH502BC/ HP4338B
- Irms for a 15°C rise above 25°C ambient.
- Operating temperature range from -40°C to 125°C. (Including self - temperature rise)

Test Instruments : Agilent E4991A Material/Impedance Analyzer

Typical **L** vs. **Frequency**

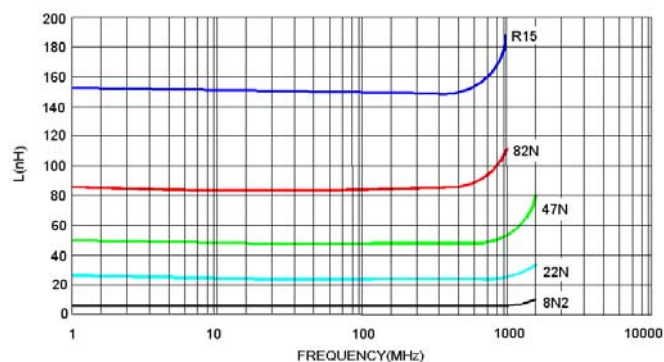

Typical **Q** vs. **Frequency**

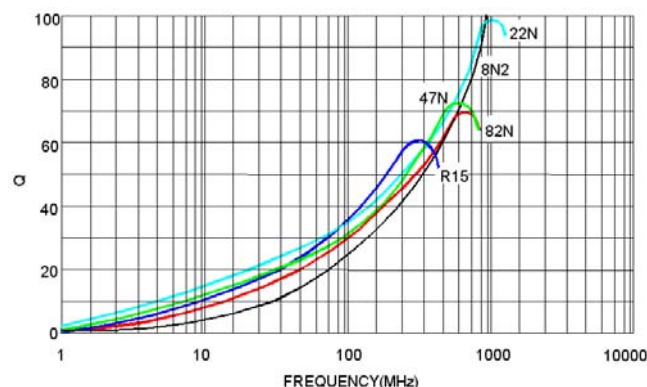

Packaging Specifications

Tape Dimensions

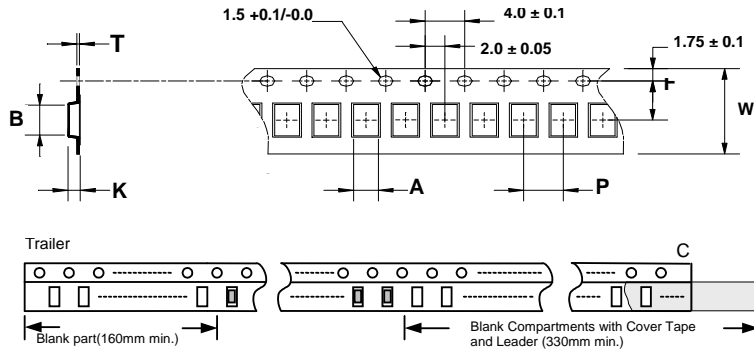

Reel Dimensions

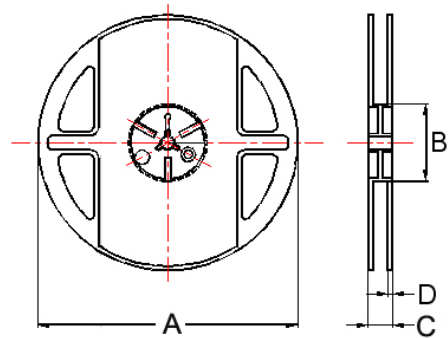

Dimensions in mm

TYPE	Tape Dimensions							Reel Dimensions				Quantity
	A	B	T	W	P	F	K	A	B	C	D	PCS / REEL
CT0805	1.85	2.45	0.23	8	4	3.5	1.10	178	60	12	1.5	2000

HQ Series



Due to accurate wire winding technology, these chip inductors are designed for filtering, impedance matching, resonance and choke circuits for RF designer. Both standard series custom designs are available.

Features

- RoHS compliant.
- Ceramic body and wire wound construction provide highest SRFs
- Exceptional Q values even at high frequencies
- Highest possible SRFs as well as excellent Q values
- The non-magnetic coil form assures utmost thermal stability, predictability and batch consistency
- The highest Q factors and low RDC to fulfill the needs of mobile applications

Applications

- RF products for cellular phone
- GPS receiver
- Base Station
- Repeater
- Wireless LAN/ mouse/ keyboard/ earphone
- Remote control
- Security system and other RF modules

Product Identification

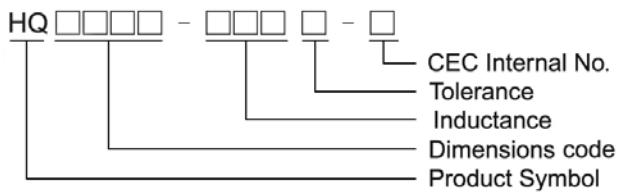

Shape and Dimensions/ Recommended Pattern

HQ0805/1008

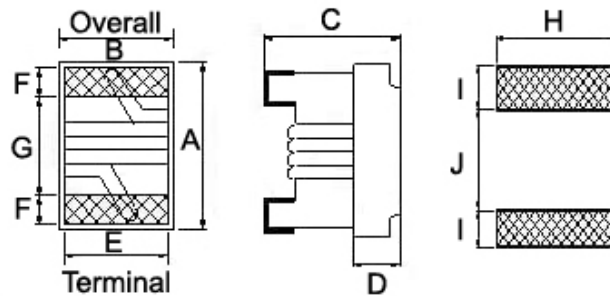

Dimensions

		A Max	B Max	C Max	D	E	F	G	H	I	J
HQ0805	inch	0.090	0.070	0.061	0.020	0.050	0.017	0.050	0.070	0.040	0.030
	mm	2.29	1.78	1.56	0.50	1.27	0.44	1.27	1.78	1.02	0.76
HQ1008	inch	0.117	0.110	0.083	0.028	0.080	0.020	0.060	0.100	0.040	0.050
	mm	2.96	2.79	2.10	0.70	2.03	0.51	1.52	2.54	1.02	1.27

Electrical Characteristics

Part Number	Inductance (nH)	Test Frequency (MHz)	Tolerance (±%)	Q Min	Test Frequency (MHz)	SRF (MHz) Min	Rdc (Ω) Max	Irms (mA) Max	Color
HQ0805-2N5□-S	2.5	250	10 / 5	80	1500	6000	0.020	1600	Black
HQ0805-5N6□-S	5.6	250	10 / 5	98	1500	6000	0.035	1600	Brown
HQ0805-6N2□-S	6.2	250	10 / 5	88	1000	4750	0.035	1600	Red
HQ0805-12N□-S	12.0	250	10 / 5	80	1000	3000	0.045	1600	Orange
HQ0805-16N□-S	16.0	250	10 / 5 / 2	72	500	2950	0.060	1500	Yellow
HQ0805-18N□-S	18.0	250	10 / 5 / 2	75	500	2550	0.060	1400	Green
HQ0805-20N□-S	20.0	250	10 / 5 / 2	70	500	2050	0.055	1400	Blue
HQ0805-27N□-S	27.0	250	10 / 5 / 2	75	500	2000	0.070	1300	Violet
HQ0805-30N□-S	30.0	250	10 / 5 / 2	65	500	1950	0.095	1200	Gray
HQ0805-39N□-S	39.0	250	10 / 5 / 2	65	500	1600	0.095	1100	White
HQ0805-48N□-S	48.0	200	10 / 5 / 2	65	500	1400	0.110	1200	Black
HQ0805-51N□-S	51.0	200	10 / 5 / 2	65	500	1400	0.120	1000	Brown

- When ordering, please specify tolerance and packaging codes.
- Tolerance: G = ±2%, J = ±5% , K = ±10%
- Packaging: Clear tape and reel {standard}
- L/Q: Agilent E4991A+ Agilent HP16197A
- SRF: Agilent HP8753D / Agilent E4991A
- RDC: CH502BC/ HP4338B
- I_{rms} for a 15°C rise above 25°C ambient
- Operating temperature range from -40°C to 125°C.(Including self - temperature rise)

Test Instruments : Agilent E4991A Material/Impedance Analyzer

Typical **L** vs. **F** Frequency

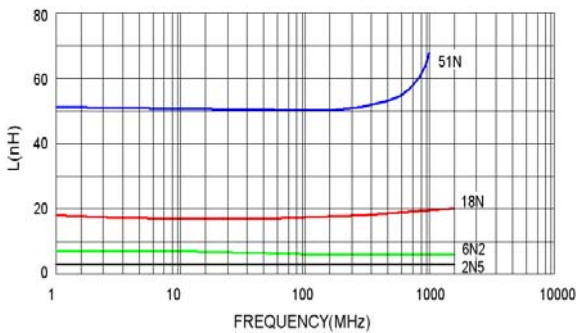

Typical **Q** vs. **F** Frequency

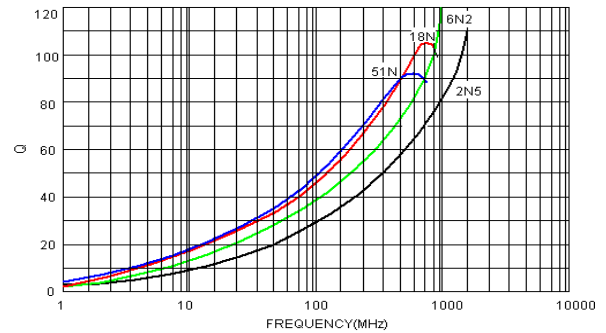

Electrical Characteristics

Part Number	Inductance (nH)	Test Frequency (MHz)	Tolerance (±%)	Q Min	Test Frequency (MHz)	SRF (MHz) Min	Rdc (Ω) Max	I _{rms} (mA) Max	Color Coding		
									1 ST	2 ND	3 RD
HQ1008-4N1□-S	4.1	50	10 / 5	75	1500	6000	0.05	1600	Black	Yellow	Black
HQ1008-10N□-S	10	50	10 / 5	60	500	3600	0.06	1600	Brown	Black	Black
HQ1008-12N□-S	12	50	10 / 5 / 2	70	500	2800	0.06	1500	Brown	Red	Black
HQ1008-18N□-S	18	50	10 / 5 / 2	62	350	2700	0.07	1400	Brown	Gray	Black
HQ1008-22N□-S	22	50	10 / 5 / 2	62	350	2050	0.07	1400	Red	Red	Black
HQ1008-33N□-S	33	50	10 / 5 / 2	75	350	1700	0.09	1300	Orange	Orange	Black
HQ1008-39N□-S	39	50	10 / 5 / 2	75	350	1300	0.09	1300	Orange	White	Black
HQ1008-47N□-S	47	50	10 / 5 / 2	75	350	1450	0.12	1200	Yellow	Violet	Black
HQ1008-56N□-S	56	50	10 / 5 / 2	75	350	1230	0.12	1200	Green	Blue	Black
HQ1008-68N□-S	68	50	10 / 5 / 2	80	350	1150	0.13	1100	Blue	Gray	Black
HQ1008-82N□-S	82	50	10 / 5 / 2	80	350	1060	0.16	1100	Gray	Red	Black
HQ1008-R10□-S	100	50	10 / 5 / 2	62	350	1000	0.16	1000	Brown	Black	Brown
HQ1008-R12□-S	120	25	10 / 5 / 2	50	100	950	0.20	1000	Brown	Red	Brown
HQ1008-R15□-S	150	25	10 / 5 / 2	48	100	820	0.23	1000	Brown	Green	Brown
HQ1008-R22□-S	220	25	10 / 5 / 2	48	100	730	0.45	1000	Red	Red	Brown
HQ1008-R27□-S	270	25	10 / 5 / 2	48	100	650	0.50	900	Red	Violet	Brown
HQ1008-R33□-S	330	25	10 / 5 / 2	48	100	570	0.65	900	Orange	Orange	Brown
HQ1008-R39□-S	390	25	10 / 5 / 2	48	100	530	0.70	900	Orange	White	Brown

- When ordering, please specify tolerance and packaging codes.
- Tolerance: G = ±2%, J = ±5%, K = ±10%
- Packaging: Clear tape and reel {standard}.
- L / Q: Agilent E4991A + Agilent HP16197A
- SRF: Agilent HP8753D / Agilent E4991A
- RDC: CH502BC/ HP4338B
- I_{rms} for a 15°C rise above 25°C ambient.
- Operating temperature range from -40°C to 125°C. (Including self - temperature rise)

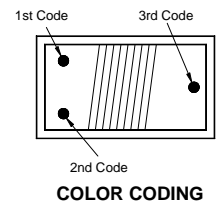

Test Instruments : Agilent E4991A Material/Impedance Analyzer

Typical **L** vs. **Frequency**

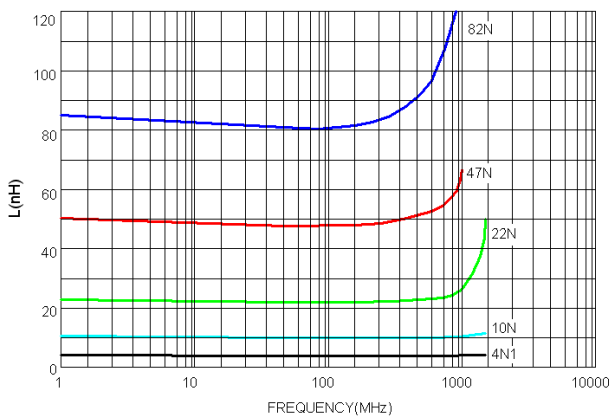

Typical **Q** vs. **Frequency**

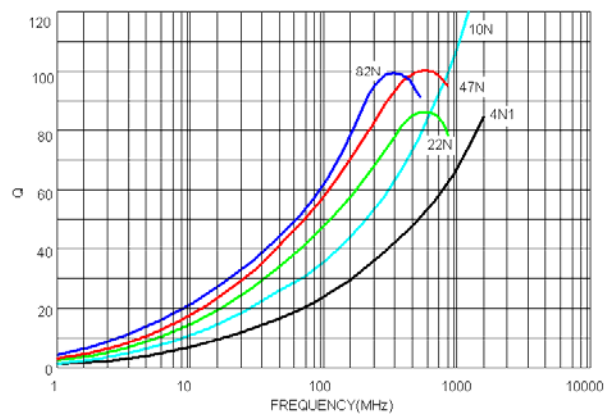

Packaging Specifications

Tape Dimensions

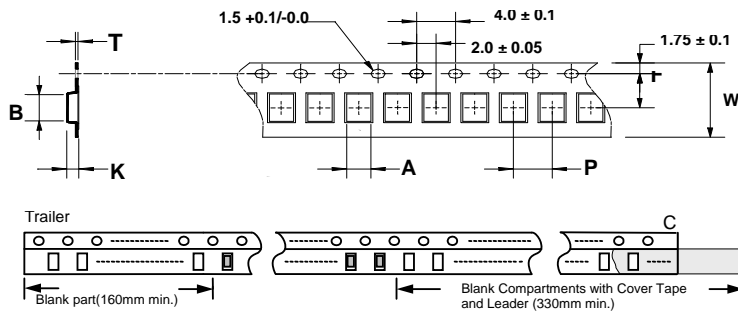

Reel Dimensions

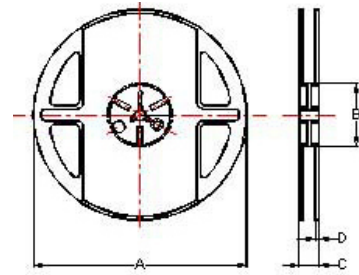

Dimensions in mm

TYPE	Tape Dimensions							Reel Dimensions				Quantity PCS / REEL
	A	B	T	W	P	F	K	A	B	C	D	
HQ0805	1.85	2.45	0.23	8	4	3.5	1.45	178	60	12	1.5	2000
HQ1008	2.80	2.95	0.23	8	4	3.5	2.20	178	60	12	1.5	2000

HC Series



Due to accurate wire winding technology, these chip inductors are designed for filtering, impedance matching, resonance and choke circuits for RF designer. Both standard series custom designs are available.

Features

- RoHS compliant
- Ceramic body and wire wound construction provide highest SRFs
- Exceptional Q values even at high frequencies
- Highest possible SRFs as well as excellent Q values
- The non-magnetic coil form assures utmost thermal stability, predictability and batch consistency
- The high current rating and low loss to fit the RF applications

Applications

- RF products for cellular phone
- GPS receiver
- Base Station
- Repeater
- Wireless LAN/ mouse/ keyboard/ earphone
- Remote control
- Security system and other RF modules

Product Identification

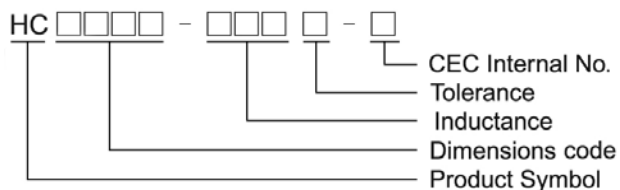

Shape and Dimensions/ Recommended Pattern

HC0603

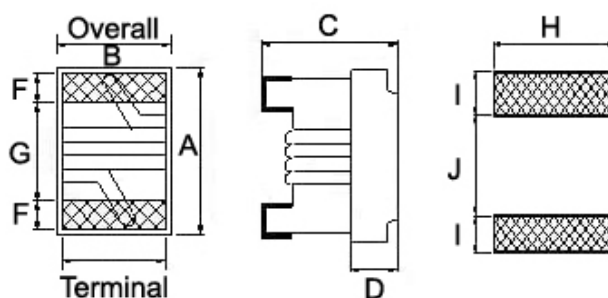

Dimensions

		A Max	B Max	C Max	D	E	F	G	H	I	J
HC0603	inch	0.071	0.049	0.04	0.015	0.030	0.013	0.034	0.040	0.025	0.025
	mm	1.80	1.25	1.02	0.38	0.76	0.33	0.86	1.02	0.64	0.64

Electrical Characteristics

Part Number	Inductance (nH)	Test Frequency (MHz)	Tolerance (±%)	Q Min	Test Frequency (MHz)	SRF (MHz) Min	Rdc (Ω) Max	Irms (mA) Max	Color
HC0603-1N6□-S	1.6	250	10 / 5	24	250	12500	0.030	2400	Black
HC0603-3N6□-S	3.6	250	10 / 5	24	250	5900	0.048	2300	Brown
HC0603-3N9□-S	3.9	250	10 / 5	25	250	5900	0.054	2200	Red
HC0603-6N8□-S	6.8	250	10 / 5	35	250	5800	0.054	2100	Orange
HC0603-7N5□-S	7.5	250	10 / 5	35	250	3700	0.059	2100	Yellow
HC0603-8N2□-S	8.2	250	10 / 5	38	250	3700	0.071	2000	Brown
HC0603-10N□-S	10.0	250	10 / 5 / 2	38	250	3700	0.071	2000	Green
HC0603-12N□-S	12.0	250	10 / 5 / 2	38	250	3000	0.075	2000	Blue
HC0603-15N□-S	15.0	250	10 / 5 / 2	38	250	2800	0.080	1900	Violet
HC0603-18N□-S	18.0	250	10 / 5 / 2	40	250	2800	0.099	1900	Gray
HC0603-22N□-S	22.0	250	10 / 5 / 2	42	250	2400	0.099	1800	White
HC0603-24N□-S	24.0	250	10 / 5 / 2	42	250	2400	0.105	1800	Black

- When ordering, please specify tolerance and packaging codes.
- Tolerance : G = ±2% , J = ±5% , K = ±10%
- L/Q: Agilent E4991A + Agilent HP16197A
- SRF: Agilent HP8753D
- RDC: CH502BC/ HP4338B
- I_{rms} for a 20°C rise above 25°C ambient.
- Operating temperature range from -40°C to 125°C. (Including self - temperature rise)

Test Instruments : Agilent E4991A Material/Impedance Analyzer

Typical L vs. Frequency

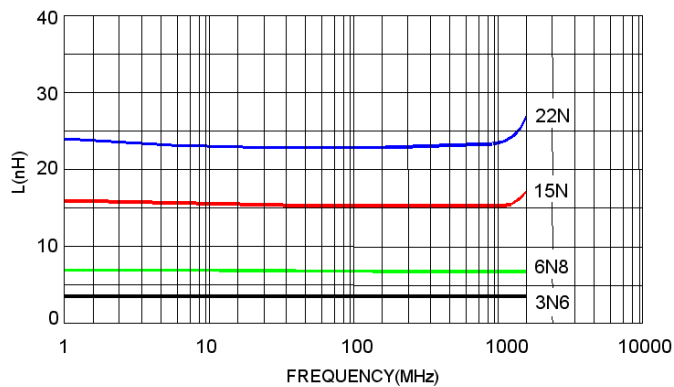

Typical Q vs. Frequency

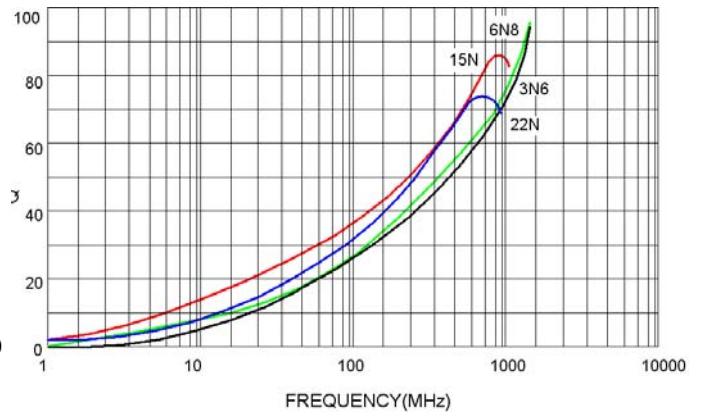

Packaging Specifications

Tape Dimensions

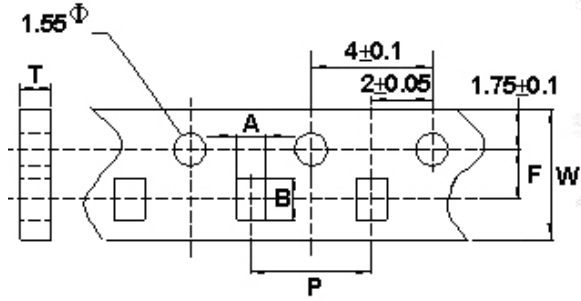

Tape Material

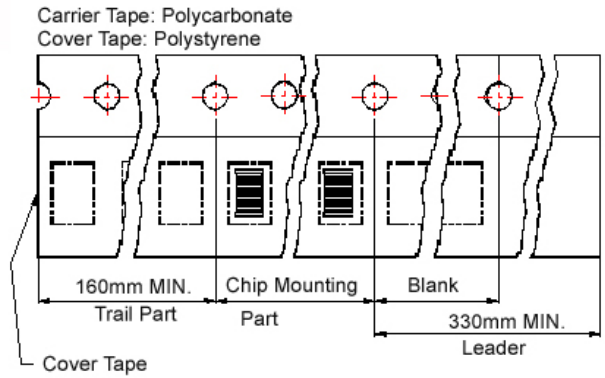

Reel Dimensions

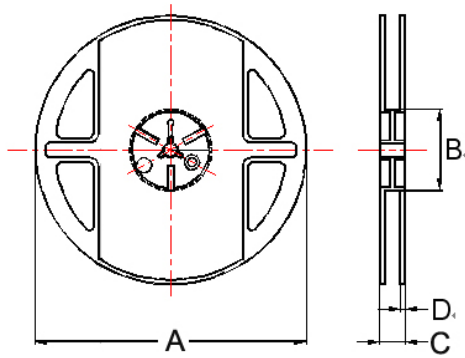

Dimensions in mm

TYPE	Tape Dimensions						Reel Dimensions				Quantity
	A	B	T	W	P	F	A	B	C	D	PCS / REEL
HC0603	1.20	1.80	0.97	8	4	3.5	178	60	12	1.5	4000

CL Series

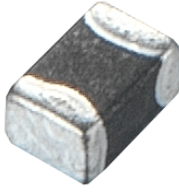

The SMD multi-layered ferrite chip inductors provide a cost-effective solution for densely packed PC board designs. CL series comes in 5 sizes and is suitable for low frequency applications.

Features

- RoHS compliant
- High mounting density of compact circuit due to crosstalk elimination that results from a closed magnetic flux in a ferrite material
- Suitable for flow and re-flow soldering
- Available in 5 sizes

Applications

- Personal computers, HDDs, other various electronic devices
- Any portable device where compact size and high mounting densities are required

Product Identification

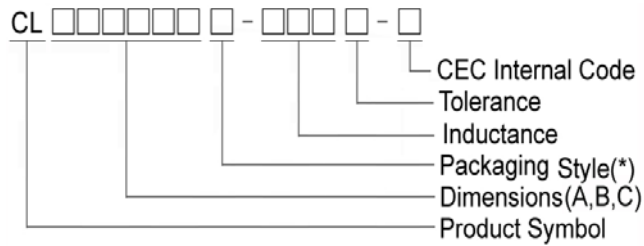

- Packaging : T : Tape and Reel ; B : Bulk

Shape and Dimensions

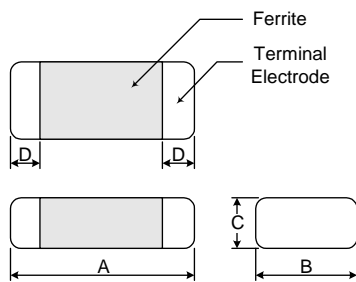

Recommended Pattern

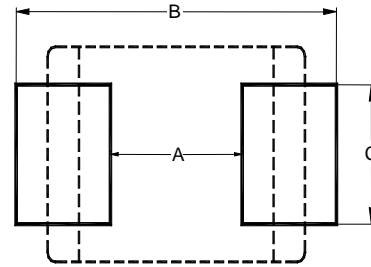

Dimensions in mm

TYPE	A	B	C	D
CL160808	1.6±0.20	0.80±0.20	0.80±0.20	0.3±0.20
CL201209	2.0±0.20	1.25±0.20	0.90±0.20	0.5±0.30
CL201212	2.0±0.20	1.25±0.20	1.25±0.20	0.5±0.30
CL321611	3.2±0.20	1.60±0.20	1.10±0.20	0.5±0.30

Dimensions in mm

TYPE	A	B	C
CL160808	0.7 ~ 0.8	1.8 ~ 2.0	0.6 ~ 0.8
CL201209	1.0 ~ 1.2	2.6 ~ 4.0	1.0 ~ 1.2
CL201212	1.0 ~ 1.2	2.6 ~ 4.0	1.0 ~ 1.2
CL321611	2.0	4.2 ~ 5.2	1.2

Electrical Characteristics

Part Number	Inductance (μ H)	Tolerance (\pm %)	Q Min	Test Frequency (MHz)	SRF (MHz) Min	DC Resistance (Ω) Max	IDC (mA) Max
CL160808T-10N□-N	0.010	20 / 15	15	50	300	0.2	50
CL160808T-33N□-N	0.033	20 / 15	15	50	270	0.2	50
CL160808T-47N□-N	0.047	20 / 15	15	50	260	0.3	50
CL160808T-56N□-N	0.056	20 / 15	15	50	255	0.3	50
CL160808T-68N□-N	0.068	20 / 15	15	50	250	0.3	50
CL160808T-82N□-N	0.082	20 / 15	15	50	245	0.3	50
CL160808T-R10□-N	0.10	20 / 15 / 10	25	25	240	0.5	50
CL160808T-R12□-N	0.12	20 / 15 / 10	25	25	205	0.5	50
CL160808T-R15□-N	0.15	20 / 15 / 10	25	25	180	0.6	50
CL160808T-R18□-N	0.18	20 / 15 / 10	25	25	165	0.6	50
CL160808T-R22□-N	0.22	20 / 15 / 10	25	25	150	0.8	50
CL160808T-R27□-N	0.27	20 / 15 / 10	25	25	136	0.8	50
CL160808T-R33□-N	0.33	20 / 15 / 10	25	25	125	0.85	35
CL160808T-R39□-N	0.39	20 / 15 / 10	25	25	110	1.00	35
CL160808T-R47□-N	0.47	20 / 15 / 10	25	25	105	1.35	35
CL160808T-R56□-N	0.56	20 / 15 / 10	25	25	95	1.50	35
CL160808T-R68□-N	0.68	20 / 15 / 10	25	25	85	1.70	35
CL160808T-R82□-N	0.82	20 / 15 / 10	25	25	75	2.10	35
CL160808T-1R0□-N	1.0	20 / 15 / 10	35	10	65	0.60	25
CL160808T-1R2□-N	1.2	20 / 15 / 10	35	10	60	0.80	25
CL160808T-1R5□-N	1.5	20 / 15 / 10	35	10	55	0.80	25
CL160808T-1R8□-N	1.8	20 / 15 / 10	35	10	50	0.95	25
CL160808T-2R2□-N	2.2	20 / 15 / 10	35	10	45	1.00	15
CL160808T-2R7□-N	2.7	20 / 15 / 10	35	10	40	1.15	15
CL160808T-3R3□-N	3.3	20 / 15 / 10	35	10	38	1.30	15
CL160808T-3R9□-N	3.9	20 / 15 / 10	35	10	36	1.50	15
CL160808T-4R7□-N	4.7	20 / 15 / 10	35	10	33	1.60	15
CL160808T-5R6□-N	5.6	20 / 15 / 10	35	4	22	1.10	5
CL160808T-6R8□-N	6.8	20 / 15 / 10	35	4	20	1.30	5
CL160808T-8R2□-N	8.2	20 / 15 / 10	30	4	18	1.50	5
CL160808T-100□-N	10	20 / 15 / 10	30	2	17	1.70	5
CL160808T-120□-N	12	20 / 15 / 10	30	2	15	1.80	3
CL160808T-150□-N	15	20 / 15 / 10	20	1	14	1.50	1
CL160808T-180□-N	18	20 / 15 / 10	20	1	13	1.60	1
CL160808T-220□-N	22	20 / 15 / 10	20	1	11	1.70	1

- When ordering, please specify tolerance and packaging codes.
- Tolerance : K = \pm 10% L = \pm 15% M = \pm 20%

Electrical Characteristics

Part Number	Inductance (μ H)	Tolerance (\pm %)	Q Min	Test Frequency (MHz)	SRF (MHz) Min	DC Resistance (Ω) Max	IDC (mA) Max
CL201209T-22N□-N	0.022	20 / 15	20	50	320	0.20	300
CL201209T-33N□-N	0.033	20 / 15	20	50	320	0.20	300
CL201209T-47N□-N	0.047	20 / 15	20	50	320	0.20	300
CL201209T-68N□-N	0.068	20 / 15	20	50	280	0.20	300
CL201209T-82N□-N	0.082	20 / 15	20	50	255	0.20	300
CL201209T-R10□-N	0.10	20 / 15 / 0	25	25	235	0.30	250
CL201209T-R12□-N	0.12	20 / 15 / 10	25	25	220	0.30	250
CL201209T-R15□-N	0.15	20 / 15 / 10	25	25	200	0.40	250
CL201209T-R18□-N	0.18	20 / 15 / 10	25	25	185	0.40	250
CL201209T-R22□-N	0.22	20 / 15 / 10	25	25	170	0.50	250
CL201209T-R27□-N	0.27	20 / 15 / 10	25	25	150	0.50	250
CL201209T-R33□-N	0.33	20 / 15 / 10	25	25	145	0.55	250
CL201209T-R39□-N	0.39	20 / 15 / 10	25	25	135	0.65	250
CL201209T-R47□-N	0.47	20 / 15 / 10	25	25	125	0.65	250
CL201209T-R56□-N	0.56	20 / 15 / 10	25	25	115	0.75	150
CL201209T-R68□-N	0.68	20 / 15 / 10	25	25	105	0.80	150
CL201209T-R82□-N	0.82	20 / 15 / 10	25	25	100	1.00	150
CL201209T-1R0□-N	1.0	20 / 15 / 10	45	10	75	0.40	50
CL201209T-1R2□-N	1.2	20 / 15 / 10	45	10	65	0.50	50
CL201209T-1R5□-N	1.5	20 / 15 / 10	45	10	60	0.50	50
CL201209T-1R8□-N	1.8	20 / 15 / 10	45	10	55	0.60	50
CL201209T-2R2□-N	2.2	20 / 15 / 10	45	10	50	0.65	30

- When ordering, please specify tolerance and packaging codes
- Tolerance : K = \pm 10% L = \pm 15% M = \pm 20%

Electrical Characteristics

Part Number	Inductance (μ H)	Tolerance (\pm %)	Q Min	Test Frequency (MHz)	SRF (MHz) Min	DC Resistance (Ω) Max	IDC (mA) Max
CL201212T-2R7□-N	2.7	20 / 15 / 10	45	10	45	0.75	30
CL201212T-3R3□-N	3.3	20 / 15 / 10	45	10	41	0.80	30
CL201212T-3R9□-N	3.9	20 / 15 / 10	45	10	38	0.90	30
CL201212T-4R7□-N	4.7	20 / 15 / 10	45	10	35	1.00	30
CL201212T-5R6□-N	5.6	20 / 15 / 10	45	4	32	0.90	15
CL201212T-6R8□-N	6.8	20 / 15 / 10	45	4	29	1.00	15
CL201212T-8R2□-N	8.2	20 / 15 / 10	45	4	26	1.10	15
CL201212T-100□-N	10	20 / 15 / 10	45	2	24	1.10	15
CL201212T-120□-N	12	20 / 15 / 10	45	2	22	1.20	15
CL201212T-150□-N	15	20 / 15 / 10	30	1	19	0.80	5
CL201212T-180□-N	18	20 / 15 / 10	30	1	18	0.90	5
CL201212T-220□-N	22	20 / 15 / 10	30	1	16	1.1	5

- When ordering, please specify tolerance and packaging codes
- Tolerance : K = \pm 10% L = \pm 15% M = \pm 20%

Electrical Characteristics

Part Number	Inductance (μ H)	Tolerance (\pm %)	Q Min	Test Frequency (MHz)	SRF (MHz) Min	DC Resistance (Ω) Max	IDC (mA) Max
CL321611T-47N□-N	0.047	20 / 15	20	50	320	0.15	300
CL321611T-68N□-N	0.068	20 / 15	20	50	280	0.25	300
CL321611T-82N□-N	0.082	20 / 15	20	50	250	0.25	300
CL321611T-R10□-N	0.10	20 / 15 / 10	25	25	235	0.25	250
CL321611T-R12□-N	0.12	20 / 15 / 10	25	25	220	0.30	250
CL321611T-R15□-N	0.15	20 / 15 / 10	25	25	200	0.30	250
CL321611T-R18□-N	0.18	20 / 15 / 10	25	25	185	0.40	250
CL321611T-R22□-N	0.22	20 / 15 / 10	25	25	170	0.40	250
CL321611T-R27□-N	0.27	20 / 15 / 10	25	25	150	0.50	250
CL321611T-R33□-N	0.33	20 / 15 / 10	25	25	145	0.60	250
CL321611T-R39□-N	0.39	20 / 15 / 10	25	25	135	0.50	200
CL321611T-R47□-N	0.47	20 / 15 / 10	25	25	125	0.60	200
CL321611T-R56□-N	0.56	20 / 15 / 10	25	25	115	0.70	150
CL321611T-R68□-N	0.68	20 / 15 / 10	25	25	105	0.80	150
CL321611T-R82□-N	0.82	20 / 15 / 10	25	25	100	0.90	150
CL321611T-1R0□-N	1.0	20 / 15 / 10	45	10	75	0.40	100
CL321611T-1R2□-N	1.2	20 / 15 / 10	45	10	65	0.50	100
CL321611T-1R5□-N	1.5	20 / 15 / 10	45	10	60	0.50	80
CL321611T-1R8□-N	1.8	20 / 15 / 10	45	10	55	0.50	70
CL321611T-2R2□-N	2.2	20 / 15 / 10	45	10	50	0.60	60
CL321611T-2R7□-N	2.7	20 / 15 / 10	45	10	45	0.60	60
CL321611T-3R3□-N	3.3	20 / 15 / 10	45	10	41	0.70	60
CL321611T-3R9□-N	3.9	20 / 15 / 10	45	10	38	0.80	50
CL321611T-4R7□-N	4.7	20 / 15 / 10	45	10	35	0.90	50
CL321611T-5R6□-N	5.6	20 / 15 / 10	45	4	32	0.70	25
CL321611T-6R8□-N	6.8	20 / 15 / 10	45	4	29	0.80	25
CL321611T-8R2□-N	8.2	20 / 15 / 10	45	4	26	0.90	25
CL321611T-100□-N	10	20 / 15 / 10	45	2	24	1.00	25
CL321611T-120□-N	12	20 / 15 / 10	45	2	22	1.00	15
CL321611T-150□-N	15	20 / 15 / 10	35	1	19	0.70	5
CL321611T-180□-N	18	20 / 15 / 10	35	1	18	0.75	5
CL321611T-220□-N	22	20 / 15 / 10	35	1	16	0.90	5
CL321611T-270□-N	27	20 / 15 / 10	35	1	14	0.90	5

- When ordering, please specify tolerance and packaging codes.
- Tolerance : K = \pm 10% / L = \pm 15% / M = \pm 20%

SMD Multilayer Ferrite Chip Inductors - CL Series

Test Instruments : Agilent E4991A Impedance / Material Analyzer

CL160808

INDUCTANCE vs. FREQUENCY CHARACTERISTICS

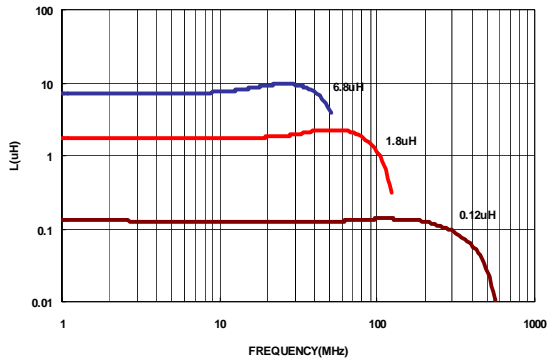

Q vs. FREQUENCY CHARACTERISTICS

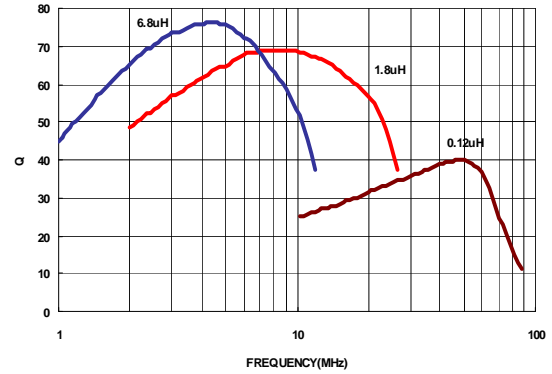

CL201209

INDUCTANCE vs. FREQUENCY CHARACTERISTICS

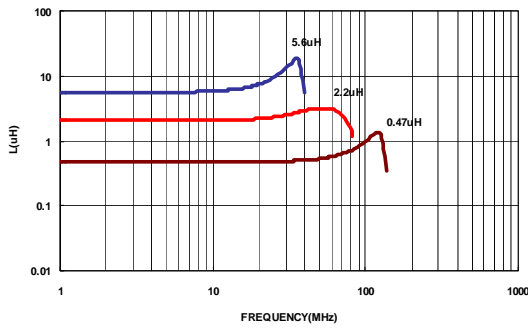

Q vs. FREQUENCY CHARACTERISTICS

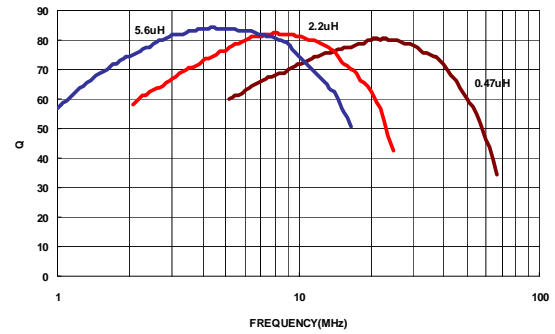

CL321611

INDUCTANCE vs. FREQUENCY CHARACTERISTICS

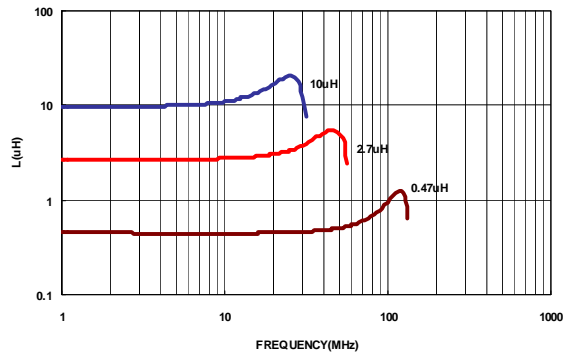

Q vs. FREQUENCY CHARACTERISTICS

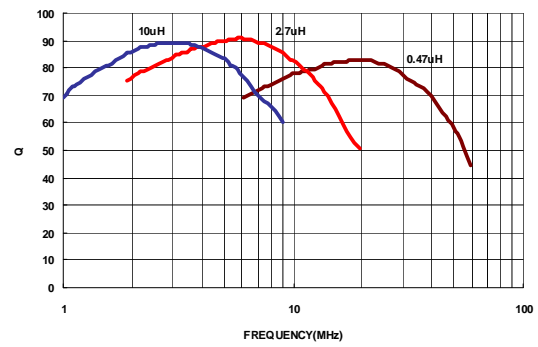

Packaging Specifications

Tape Dimensions

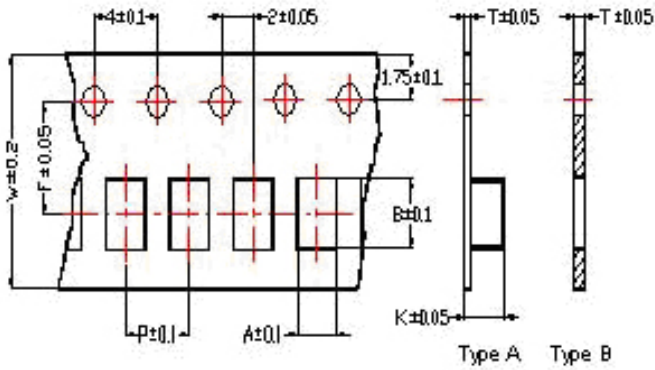

Tape Material

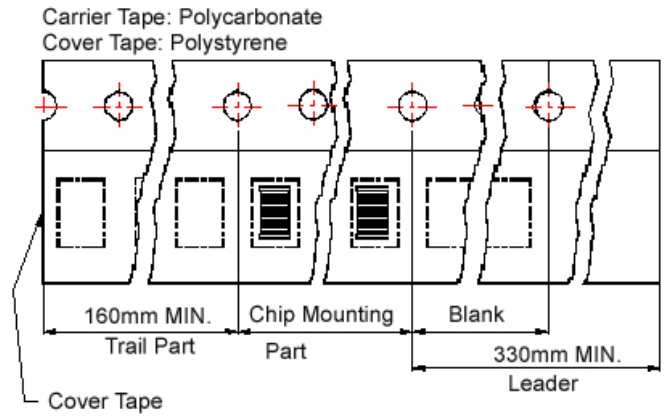

Reel Dimensions

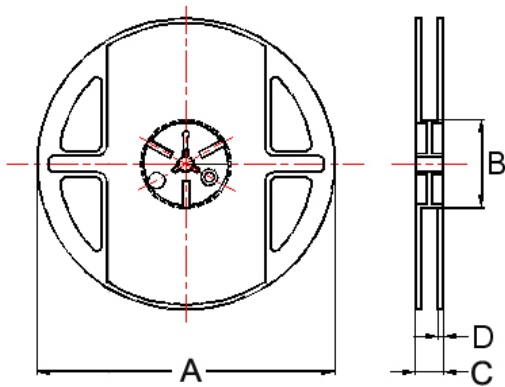

Dimensions in mm

TYPE	Tape Dimensions								Tape	Reel Dimensions				Quantity PCS / Reel
	A	B	T	W	P	F	K	A		B	C	D		
CL160808	1.05	1.85	0.95	8.0	4.0	3.5	-	B	178	60	12	1.5	4000	
CL201209	1.50	2.30	0.97	8.0	4.0	3.5	-	B	178	60	12	1.5	4000	
CL201212	1.35	2.25	0.22	8.0	4.0	3.5	1.35	A	178	60	12	1.5	3000	
CL321611	1.88	3.50	0.22	8.0	4.0	3.5	1.27	A	178	60	12	1.5	3000	

NL Series



Features

- RoHS compliant
- Strong solderability by reflow soldering and soldering iron
- Highly accurate dimensions
- Can be mounted automatically
- Terminals are highly resistant to external forces
- Highly resistant to mechanical shocks and pressure
- Highly reliable in environments of sudden temperature change and humidity
- Superior Q characteristics and the broadest L selections among peers

Applications

- Microtelevisions
- Liquid crystal televisions
- Video cameras
- Portable VCRs
- Car radios
- Car stereos
- Thin tape radios
- Television tuners
- Mobile telephones
- Radio and other electronic devices

Product Identification

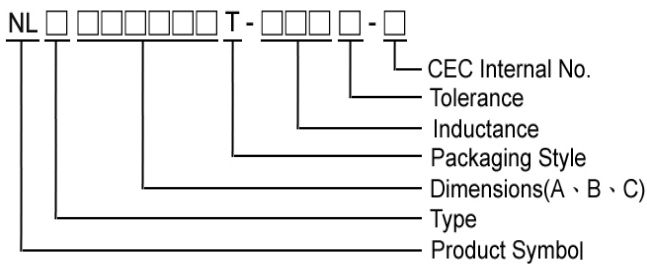

- Packaging: T : Tape and Reel

Shape and Dimensions

NL201614

NL252018

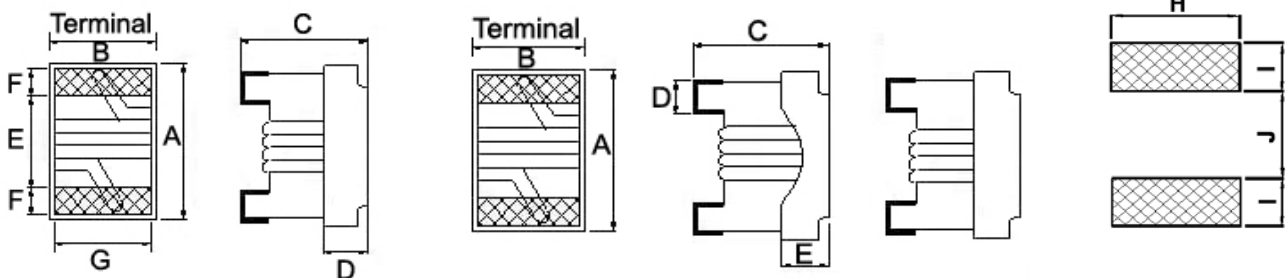

Dimensions in mm

TYPE	A Max	B Max	C Max	D	E	F	G	H	I	J
NL201614	2.40	1.72	1.52	0.70	1.02	0.50	1.27	1.78	1.02	0.76
NL252018	2.92	2.50 2.79	2.20	0.51	0.51	-	-	2.54	1.02	1.27

NL252018: B Max: 2.79 mm, at 5N0-R10,
2.50 mm, at R12-101

Electrical Characteristics

Part Number	Inductance (uH)	Test Frequency (MHz)	Tolerance (±%)	Q Min	Test Frequency (MHz)	SRF (MHz) Min	Rdc (Ω) Max	Idc (mA)	Color
NL201614T-R12□-N	0.12	25.2	10 / 5	25	25.2	500	0.20	600	White
NL201614T-R15□-N	0.15	25.2	10 / 5	25	25.2	450	0.25	600	Black
NL201614T-R18□-N	0.18	25.2	10 / 5	25	25.2	410	0.30	570	Brown
NL201614T-R22□-N	0.22	25.2	10 / 5	25	25.2	350	0.35	550	Red
NL201614T-R27□-N	0.27	25.2	10 / 5	25	25.2	280	0.40	530	Orange
NL201614T-R33□-N	0.33	25.2	10 / 5	25	25.2	235	0.45	510	Yellow
NL201614T-R39□-N	0.39	25.2	10 / 5	25	25.2	210	0.50	490	Green
NL201614T-R47□-N	0.47	25.2	10 / 5	25	25.2	170	0.55	470	Blue
NL201614T-R56□-N	0.56	25.2	10 / 5	25	25.2	150	0.60	450	Violet
NL201614T-R68□-N	0.68	25.2	10 / 5	25	25.2	140	0.70	420	Gray
NL201614T-R82□-N	0.82	25.2	10 / 5	25	25.2	130	0.75	400	White
NL201614T-1R0□-N	1.00	7.96	10 / 5	15	7.96	115	0.80	350	Black
NL201614T-1R2□-N	1.20	7.96	10 / 5	15	7.96	95	0.90	325	Brown
NL201614T-1R5□-N	1.50	7.96	10 / 5	15	7.96	85	1.05	300	Red
NL201614T-1R8□-N	1.80	7.96	10 / 5	15	7.96	80	1.20	270	Orange
NL201614T-2R2□-N	2.20	7.96	10 / 5	15	7.96	75	1.40	250	Yellow
NL201614T-2R7□-N	2.70	7.96	10 / 5	15	7.96	70	1.60	230	Green
NL201614T-3R3□-N	3.30	7.96	10 / 5	15	7.96	60	1.80	210	Blue
NL201614T-3R9□-N	3.90	7.96	10 / 5	15	7.96	55	2.00	190	Violet
NL201614T-4R7□-N	4.70	7.96	10 / 5	15	7.96	45	2.40	170	Gray
NL201614T-5R6□-N	5.60	7.96	10 / 5	15	7.96	40	2.70	150	White
NL201614T-6R8□-N	6.80	7.96	10 / 5	15	7.96	36	3.20	140	Black
NL201614T-8R2□-N	8.20	7.96	10 / 5	15	7.96	33	3.60	120	Brown
NL201614T-100□-N	10.0	2.52	10 / 5	15	2.52	30	4.50	110	Red
NL201614T-120□-N	12.0	2.52	10 / 5	15	2.52	25	5.70	105	Orange
NL201614T-150□-N	15.0	2.52	10 / 5	15	2.52	23	6.50	90	Yellow
NL201614T-180□-N	18.0	2.52	10 / 5	15	2.52	21	7.00	85	Green
NL201614T-220□-N	22.0	2.52	10 / 5	15	2.52	20	8.00	78	Blue
NL201614T-270□-N	27.0	2.52	10 / 5	15	2.52	18	9.00	75	Violet
NL201614T-330□-N	33.0	2.52	10 / 5	15	2.52	17	10.0	70	Gray

- When ordering, please specify tolerance and packaging codes.
- Tolerance : J = ±5% , K = ±10%
- L/Q : Agilent E4991A+ Agilent HP16197A
- SRF: Agilent E4991A
- Rdc: CH502BC/ HP4338B
- Idc for Inductance drop 10% from its value without current.
- Operating temperature range from -25°C to 105°C. (Including self - temperature rise)

Test Instruments : Agilent E4991A Material/Impedance Analyzer

Typical L vs. Frequency

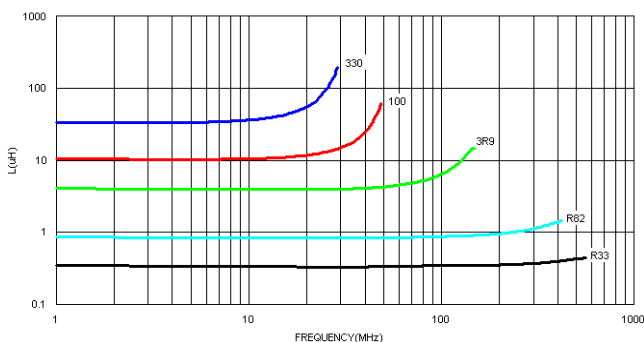

Typical Q vs. Frequency

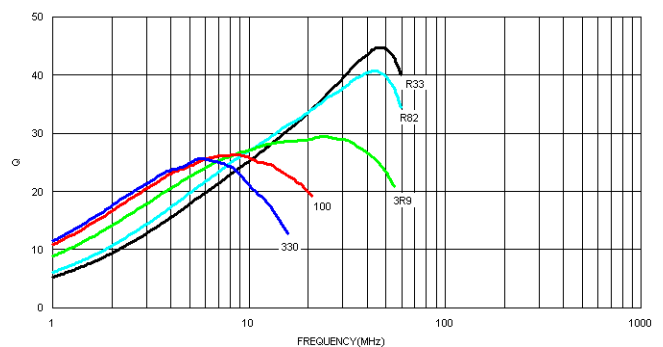

Electrical Characteristics

Part Number	Inductance (uH)	Test Frequency (MHz)	Tolerance (±%)	Q Min	Test Frequency (MHz)	SRF (MHz) Min	Rdc (Ω) Max	Idc (mA)	Color Coding		
									1 ST	2 ND	3 RD
NL252018T-5N0□-N	0.005	100	10	10	100	3000	0.25	2000	Black	Green	Black
NL252018T-10N□-N	0.010	100	10	10	100	2500	0.25	1800	Brown	Black	Black
NL252018T-12N□-N	0.012	100	10	15	100	2400	0.26	1700	Brown	Red	Black
NL252018T-15N□-N	0.015	100	10	15	100	2300	0.28	1600	Brown	Green	Black
NL252018T-18N□-N	0.018	100	10	15	100	2200	0.30	1550	Brown	Gray	Black
NL252018T-22N□-N	0.022	100	10 / 5	20	100	2100	0.35	1500	Red	Red	Black
NL252018T-27N□-N	0.027	100	10 / 5	20	100	2000	0.40	1450	Red	Violet	Black
NL252018T-33N□-N	0.033	100	10 / 5	30	100	1600	0.42	1400	Orange	Orange	Black
NL252018T-39N□-N	0.039	100	10 / 5	35	100	1500	0.45	1350	Orange	White	Black
NL252018T-47N□-N	0.047	100	10 / 5	35	100	1400	0.50	1300	Yellow	Violet	Black
NL252018T-56N□-N	0.056	100	10 / 5	35	100	1300	0.60	1250	Green	Blue	Black
NL252018T-68N□-N	0.068	100	10 / 5	35	100	1200	0.65	1240	Blue	Gray	Black
NL252018T-82N□-N	0.082	100	10 / 5	35	100	1100	0.75	1230	Gray	Red	Black
NL252018T-R10□-N	0.10	100	10 / 5	35	100	800	0.80	1220	Brown	Black	Brown
NL252018T-R12□-N	0.12	25.2	10 / 5	30	25.2	700	0.30	900	Brown	Red	Brown
NL252018T-R15□-N	0.15	25.2	10 / 5	30	25.2	550	0.35	900	Brown	Green	Brown
NL252018T-R18□-N	0.18	25.2	10 / 5	30	25.2	500	0.40	850	Brown	Gray	Brown
NL252018T-R22□-N	0.22	25.2	10 / 5	30	25.2	450	0.50	840	Red	Red	Brown
NL252018T-R27□-N	0.27	25.2	10 / 5	30	25.2	425	0.55	830	Red	Violet	Brown
NL252018T-R33□-N	0.33	25.2	10 / 5	30	25.2	400	0.60	820	Orange	Orange	Brown
NL252018T-R39□-N	0.39	25.2	10 / 5	30	25.2	375	0.65	810	Orange	White	Brown
NL252018T-R47□-N	0.47	25.2	10 / 5	30	25.2	350	0.68	800	Yellow	Violet	Brown
NL252018T-R56□-N	0.56	25.2	10 / 5	30	25.2	325	0.75	800	Green	Blue	Brown
NL252018T-R68□-N	0.68	25.2	10 / 5	30	25.2	300	0.85	800	Blue	Gray	Brown
NL252018T-R82□-N	0.82	25.2	10 / 5	30	25.2	260	1.0	800	Gray	Red	Brown
NL252018T-1R0□-N	1.0	7.96	10 / 5	25	7.96	245	1.1	800	Brown	Black	Red
NL252018T-1R2□-N	1.2	7.96	10 / 5	25	7.96	230	1.2	790	Brown	Red	Red
NL252018T-1R5□-N	1.5	7.96	10 / 5	25	7.96	182	1.3	750	Brown	Green	Red
NL252018T-1R8□-N	1.8	7.96	10 / 5	25	7.96	135	1.45	750	Brown	Gray	Red
NL252018T-2R2□-N	2.2	7.96	10 / 5	25	7.96	105	1.55	750	Red	Red	Red
NL252018T-2R7□-N	2.7	7.96	10 / 5	25	7.96	70	1.7	740	Red	Violet	Red
NL252018T-3R3□-N	3.3	7.96	10 / 5	25	7.96	55	1.9	730	Orange	Orange	Red
NL252018T-3R9□-N	3.9	7.96	10 / 5	25	7.96	48	2.1	700	Orange	White	Red
NL252018T-4R7□-N	4.7	7.96	10 / 5	25	7.96	43	2.3	650	Yellow	Violet	Red
NL252018T-5R6□-N	5.6	7.96	10 / 5	20	7.96	42	2.5	640	Green	Blue	Red
NL252018T-6R8□-N	6.8	7.96	10 / 5	20	7.96	39	2.7	630	Blue	Gray	Red
NL252018T-8R2□-N	8.2	7.96	10 / 5	20	7.96	36	3.05	600	Gray	Red	Red
NL252018T-100□-N	10	2.52	10 / 5	15	2.52	33	3.5	600	Brown	Black	Orange
NL252018T-120□-N	12	2.52	10 / 5	15	2.52	30	3.8	550	Brown	Red	Orange
NL252018T-150□-N	15	2.52	10 / 5	15	2.52	26	4.4	430	Brown	Green	Orange
NL252018T-180□-N	18	2.52	10 / 5	15	2.52	24	4.8	400	Brown	Gray	Orange
NL252018T-220□-N	22	2.52	10 / 5	15	2.52	22	5.5	400	Red	Red	Orange
NL252018T-270□-N	27	2.52	10 / 5	15	2.52	21	6.3	360	Red	Violet	Orange
NL252018T-330□-N	33	2.52	10 / 5	15	2.52	20	7.1	350	Orange	Orange	Orange
NL252018T-390□-N	39	2.52	10 / 5	10	2.52	18	9.5	330	Orange	White	Orange
NL252018T-470□-N	47	2.52	10 / 5	10	2.52	17	11.1	300	Yellow	Violet	Orange
NL252018T-560□-N	56	2.52	10 / 5	10	2.52	16	12.1	270	Green	Blue	Orange
NL252018T-680□-N	68	2.52	10 / 5	10	2.52	15	16.6	250	Blue	Gray	Orange
NL252018T-820□-N	82	2.52	10 / 5	10	2.52	13	19	200	Gray	Red	Orange
NL252018T-101□-N	100	0.796	10 / 5	8	0.796	12	21	120	Brown	Black	Yellow

- When ordering, please specify tolerance and packaging codes.
- Tolerance : J = ±5% , K = ±10%
- L/Q : Agilent E4991A+ Agilent HP16197A(Over 1MHz) or Agilent/HP4285A+ Agilent HP16197A(Under 1MHz)
- SRF : Agilent HP8753D / Agilent E4991A
- RDC : CH502BC/ HP4338B
- Idc for Inductance drop 10% from its value without current.
- Operating temperature range from -25°C to 105°C. (Including self - temperature rise)

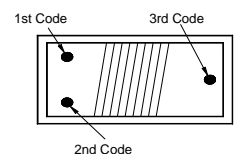

COLOR CODING

Packaging Specifications

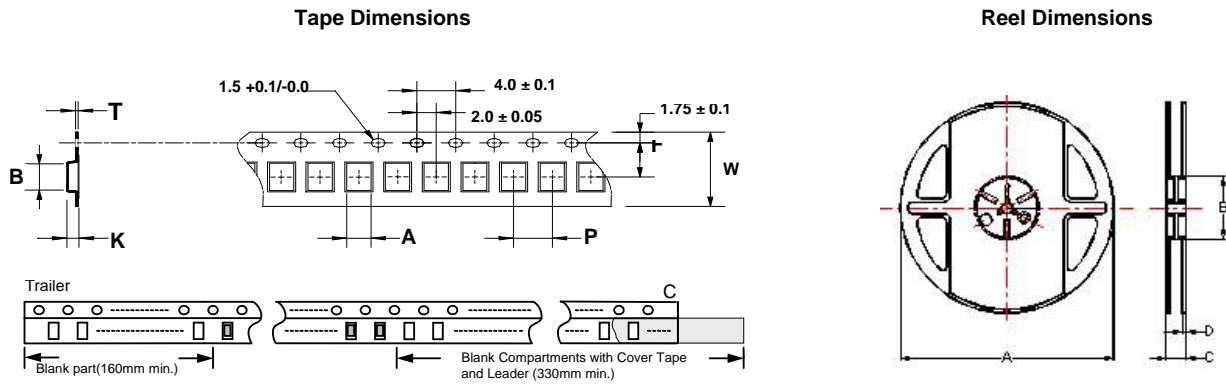

Dimensions in mm

TYPE	Tape Dimensions							Reel Dimensions				Quantity PCS / Reel
	A	B	T	W	P	F	K	A	B	C	D	
NL201614	1.85	2.45	0.23	8	4	3.5	1.45	178	60	12	1.5	2000
NL252018(5N0~R10)	2.80	2.95	0.23	8	4	3.5	2.20	178	60	12	1.5	2000
NL252018(R12~101)	2.40	2.93	0.26	8	4	3.5	2.25	178	60	12	1.5	2000

NLC Series



The characteristics of this series perform low RDC and carry large current. These unique open type inductors offer many superior features in opposition to the molding type one of Japanese peers.

Features

- RoHS compliant
- Very strong solderability by reflow soldering and soldering iron
- Highly accurate dimensions can be mounted automatically
- Terminals are highly resistant to pull forces
- Highly resistant to mechanical shocks and pressure
- Highly reliable in environments of sudden temperature change and humidity
- Superior IDC for DC/DC converter

Applications

- DC/DC converter such as DSC
- LCD TV
- Game console
- Portable VCRs
- Conveyable telephone and others

Product Identification

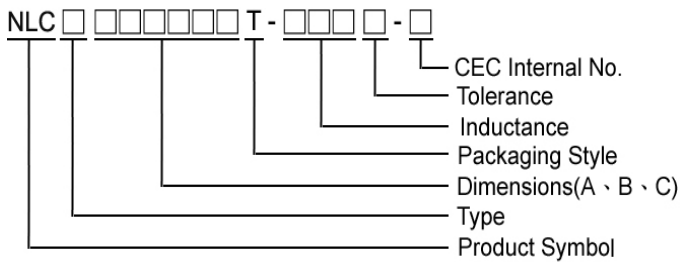

- Packaging: T : Tape and Reel

Shape and Dimensions

NLC252018

NLC322522

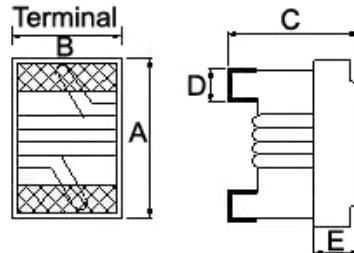
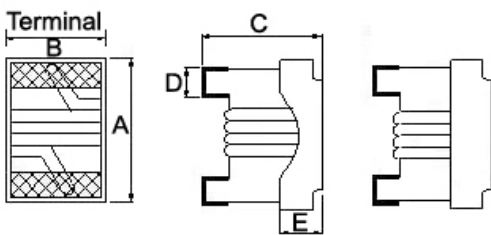

Recommended Pattern

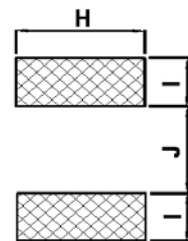

Dimensions in mm

TYPE	A Max	B Max	C Max	D	E	H	I	J
NLC252018	2.92	2.50	2.20	0.51	0.51	2.54	1.02	1.27
NLC322522	3.70	2.90	2.60	0.51	0.51	2.70	1.00	2.00

Electrical Characteristics

Part Number	Inductance (uH)	Test Frequency (MHz)	Tolerance (±%)	Q Min	Test Frequency (MHz)	SRF (MHz) Min	Rdc (Ω) Max	Idc (mA)	Color Coding		
									1 ST	2 ND	3 RD
NLC252018T-1R0□-N	1.0	7.96	10 / 5	25	7.96	300	0.34	1500	Brown	Black	Red
NLC252018T-1R5□-N	1.5	7.96	10 / 5	25	7.96	270	0.42	1400	Brown	Green	Red
NLC252018T-2R2□-N	2.2	7.96	10 / 5	25	7.96	140	0.50	1200	Red	Red	Red
NLC252018T-3R3□-N	3.3	7.96	10 / 5	25	7.96	95	0.65	1000	Orange	Orange	Red
NLC252018T-4R7□-N	4.7	7.96	10 / 5	25	7.96	90	0.80	800	Yellow	Violet	Red
NLC252018T-6R8□-N	6.8	7.96	10 / 5	25	7.96	68	1.00	730	Blue	Gray	Red
NLC252018T-100□-N	10	2.52	10 / 5	20	2.52	45	1.50	700	Brown	Black	Orange
NLC252018T-150□-N	15	2.52	10 / 5	20	2.52	40	2.20	500	Brown	Green	Orange
NLC252018T-220□-N	22	2.52	10 / 5	20	2.52	25	2.70	470	Red	Red	Orange
NLC252018T-330□-N	33	2.52	10 / 5	20	2.52	25	4.00	400	Orange	Orange	Orange
NLC252018T-470□-N	47	2.52	10 / 5	16	2.52	20	8.00	300	Yellow	Violet	Orange

- When ordering, please specify tolerance and packaging codes.
- Tolerance: J = ±5%, K = ±10%
- L / Q : Agilent E4991A + Agilent HP16197A
- SRF : Agilent E4991A
- RDC : CH502BC/ HP4338B
- Idc for Inductance drop 10% from its value without current.
- Operating temperature range from -25°C to 105°C (Including self - temperature rise)

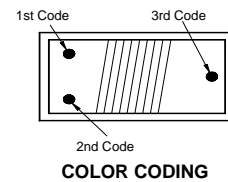

Test Instruments : Agilent E4991A Material/Impedance Analyzer

Typical L vs. Frequency

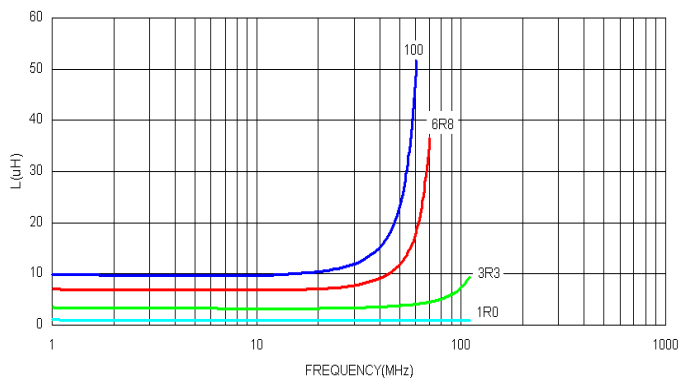

Typical Q vs. Frequency

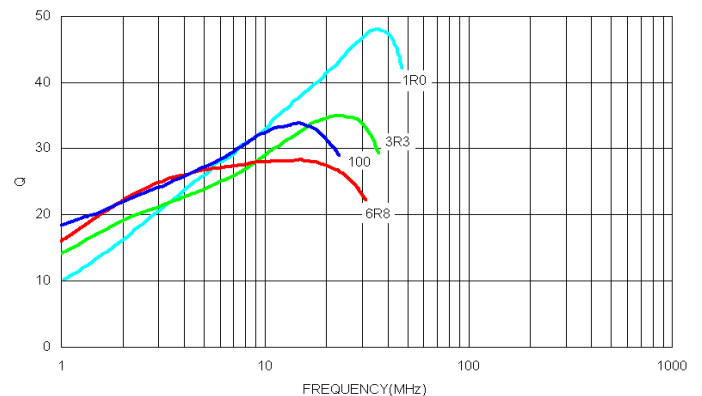

Electrical Characteristics

Part Number	Inductance (uH)	Test Frequency (MHz)	Tolerance (±%)	Q Min	Test Frequency (MHz)	SRF (MHz) Typ	Rdc (Ω)±30%	Idc (mA)	Color Coding		
									1 ST	2 ND	3 RD
NLC322522T-R47□-N	0.47	25.2	5 / 10	40	25.2	450	0.07	1800	Yellow	Violet	Brown
NLC322522T-1R0□-N	1.0	7.96	5 / 10	20	7.96	100	0.08	1500	Brown	Black	Red
NLC322522T-1R2□-N	1.2	7.96	5 / 10	20	7.96	90	0.12	1400	Brown	Red	Red
NLC322522T-1R5□-N	1.5	7.96	5 / 10	20	7.96	80	0.13	1125	Brown	Green	Red
NLC322522T-1R8□-N	1.8	7.96	5 / 10	20	7.96	70	0.13	970	Brown	Gray	Red
NLC322522T-2R2□-N	2.2	7.96	5 / 10	20	7.96	68	0.13	970	Red	Red	Red
NLC322522T-3R3□-N	3.3	7.96	5 / 10	20	7.96	54	0.16	837	Orange	Orange	Red
NLC322522T-4R7□-N	4.7	7.96	5 / 10	20	7.96	43	0.23	675	Yellow	Violet	Red
NLC322522T-5R6□-N	5.6	7.96	5 / 10	20	7.96	36	0.26	620	Green	Blue	Red
NLC322522T-6R8□-N	6.8	7.96	5 / 10	20	7.96	33	0.27	600	Blue	Gray	Red
NLC322522T-8R2□-N	8.2	7.96	5 / 10	20	7.96	30	0.32	580	Gray	Red	Red
NLC322522T-100□-N	10	2.52	5 / 10	15	2.52	28	0.36	520	Brown	Black	Orange
NLC322522T-150□-N	15	2.52	5 / 10	15	2.52	19	0.56	480	Brown	Green	Orange
NLC322522T-220□-N	22	2.52	5 / 10	15	2.52	16	0.77	310	Red	Red	Orange
NLC322522T-270□-N	27	2.52	5 / 10	15	2.52	13	1.00	280	Red	Violet	Orange
NLC322522T-330□-N	33	2.52	5 / 10	15	2.52	12	1.10	270	Orange	Orange	Orange
NLC322522T-470□-N	47	2.52	5 / 10	15	2.52	10	1.64	210	Yellow	Violet	Orange
NLC322522T-680□-N	68	2.52	5 / 10	15	2.52	9	2.80	189	Blue	Gray	Orange
NLC322522T-101□-N	100	0.796	5 / 10	15	0.796	6	3.70	145	Brown	Black	Yellow
NLC322522T-151□-N	150	0.796	5 / 10	15	0.796	5	6.10	120	Brown	Green	Yellow
NLC322522T-181□-N	180	0.796	5 / 10	15	0.796	4	8.00	105	Brown	Gray	Yellow
NLC322522T-221□-N	220	0.796	5 / 10	15	0.796	4	8.40	100	Red	Red	Yellow
NLC322522T-331□-N	330	0.796	5 / 10	15	0.796	3.5	12.3	80	Orange	Orange	Yellow
NLC322522T-471□-N	470	0.796	5 / 10	15	0.796	2.8	22.0	75	Yellow	Violet	Yellow
NLC322522T-561□-N	560	0.796	5 / 10	15	0.796	2.5	23.0	65	Green	Blue	Yellow
NLC322522T-681□-N	680	0.796	5 / 10	15	0.796	2	28.0	65	Blue	Gray	Yellow

- When ordering, please specify tolerance and packaging codes.
- Tolerance: J = ±5%, K = ±10%
- Packaging: Clear tape and reel {standard}.
- L/Q: Agilent E4991A+Agilent HP16197A (over 1MHz); Agilent/HP4285A+Agilent HP16197A (under 1MHz)
- SRF: Agilent E4991A
- RDC: HP4338B/ CH502BC
- Idc for Inductance drop 10% from its value without current.
- Operating temperature range from -25°C to 105°C. (Including self - temperature rise)

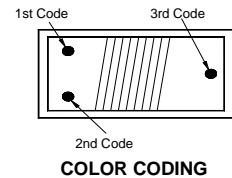

Test Instruments : Agilent E4991A Material/Impedance Analyzer

Typical L vs. Frequency

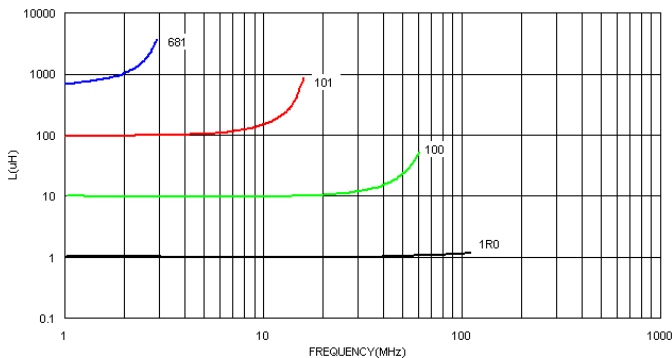

Typical Q vs. Frequency

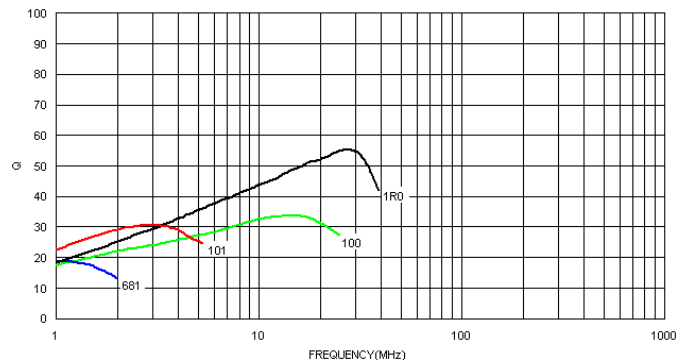

Packaging Specifications

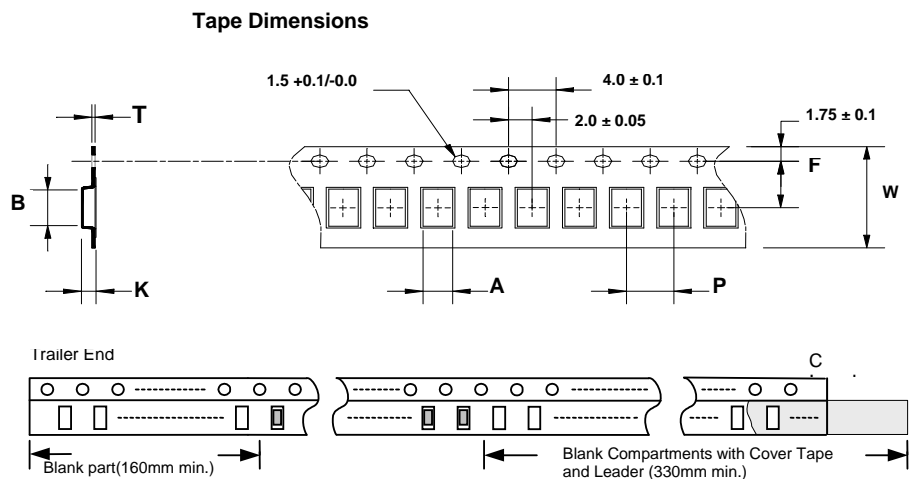

Reel Dimensions

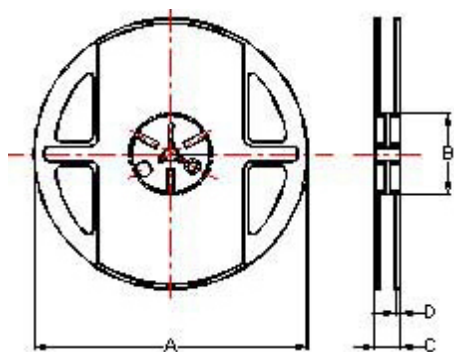

Dimensions in mm

TYPE	Tape Dimensions							Reel Dimensions				Quantity PCS / Reel
	A	B	T	W	P	F	K	A	B	C	D	
NLC252018	2.40	2.93	0.26	8	4	3.5	2.25	178	60	12	1.5	2000
NLC322522	2.85	3.58	0.25	12	4	5.5	2.45	178	60	16	1.4	2000

LD Series



LD series is the newest open type ferrite wire wound chip inductors. The wire wound ferrite construction supports lower DCR than other open type inductors.

Features

- RoHS compliant
- Miniature SMD type 0805 wire-wound chip inductor with low DC resistance
- Wide inductance range (1uH~100uH)

Applications

- DSC, DVC, MD, PDA
- Portable digital devices

Product Identification

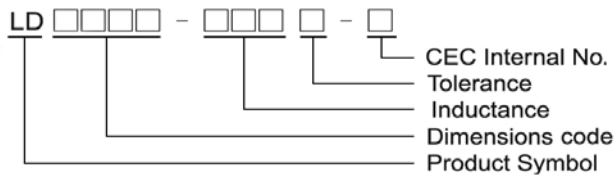

Shape and Dimensions / Recommended Pattern

LD0805

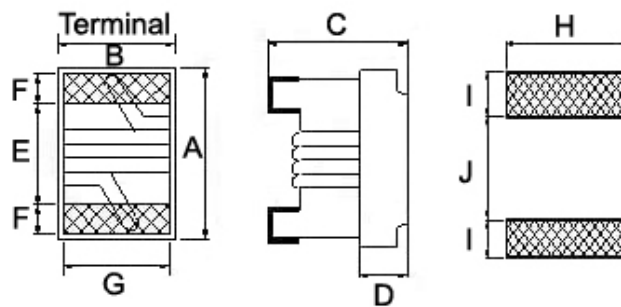

Dimensions in mm

TYPE	A Max	B Max	C Max	D	E	F	G	H	I	J
LD0805	2.4	1.72	1.52	0.70	1.00	0.50	1.27	1.78	1.02	0.76

Electrical Characteristics

Part Number	Inductance (uH)	Test Frequency (MHz)	Tolerance (±%)	Q Typ.	SRF (MHz) Min	Rdc (Ω±30%)	Idc (mA) Max	Color
LD0805-1R0□-N	1.0	7.96	10 / 20	18	100	0.10	800	Black
LD0805-1R5□-N	1.5	7.96	10 / 20	18	90	0.18	650	Brown
LD0805-2R2□-N	2.2	7.96	10 / 20	18	70	0.24	550	Red
LD0805-3R3□-N	3.3	7.96	10 / 20	18	55	0.30	450	Orange
LD0805-4R7□-N	4.7	7.96	10 / 20	18	50	0.47	360	Yellow
LD0805-6R8□-N	6.8	7.96	10 / 20	24	60	0.75	290	Green
LD0805-100□-N	10	2.52	10 / 20	18	25	0.90	290	Blue
LD0805-150□-N	15	2.52	10 / 20	18	25	1.60	230	Violet
LD0805-220□-N	22	2.52	10 / 20	18	17	1.95	190	Gray
LD0805-330□-N	33	2.52	10 / 20	17	15	2.60	120	White
LD0805-470□-N	47	2.52	10 / 20	17	11	3.90	95	Black
LD0805-680□-N	68	2.52	10 / 20	17	11	5.50	95	Brown
LD0805-101□-N	100	1.00	10 / 20	12	9	9.00	70	Red

- When ordering, please specify tolerance and packaging codes.
- Tolerance : K = ±10%, M = ±20%
- L , Q : Agilent E4991A+Agilent HP16197A(over 1MHz) or Agilent HP4285A(under 1MHz)
- SRF : Agilent E4991A
- Rdc :CH502BC/ HP4338B
- Idc for Inductance drop 10% from its value without current.
- Operating temperature range from -25°C to 105°C . (Including self - temperature rise)

Test Instruments : Agilent E4991A Material/Impedance Analyzer

Typical L vs. Frequency

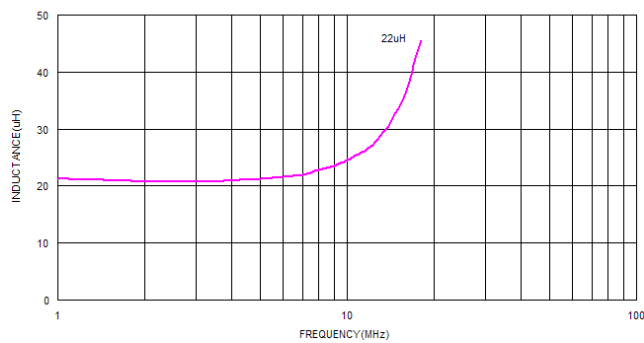

Typical Q vs. Frequency

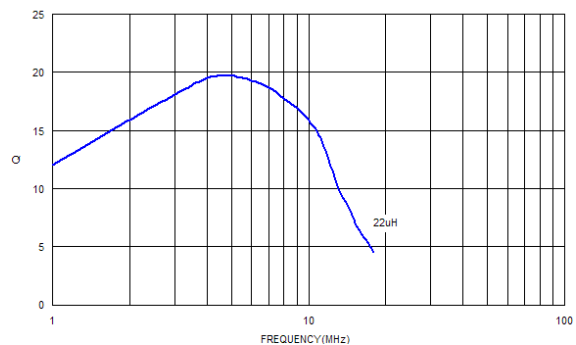

Packaging Specifications

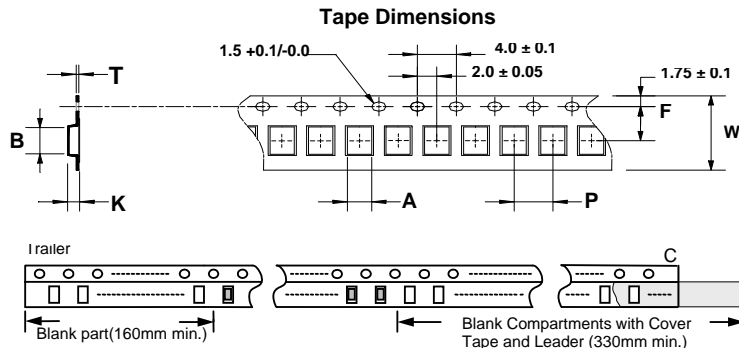

Reel Dimensions

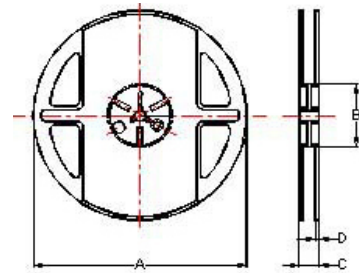

Dimensions in mm

TYPE	Tape Dimensions							Reel Dimensions				Quantity
	A	B	T	W	P	F	K	A	B	C	D	PCS / REEL
LD 0805	1.60	2.42	0.22	8	4	3.5	1.45	178	60	12	1.5	2000

LS Series



LS Series is the newest in open type ferrite wire wound chip inductors. The wire wound ferrite construction supports higher SRF, lower DCR and superior Q values than other ferrite chip inductors.

Features

- RoHS compliant
- Very strong solderability by reflow soldering and soldering iron
- Highly accurate dimensions
- Can be mounted automatically
- Terminals are highly resistant to external forces
- Highly resistant to mechanical shocks and pressure
- Highly reliable in environments of sudden temperature change and humidity
- Low DCR & better Q value in ferrite series

Applications

- Telecom and datacom applications such as xDSL
- Cable modem
- Set-top box
- CATV filter/tuner
- Wireless LAN, etc

Product Identification

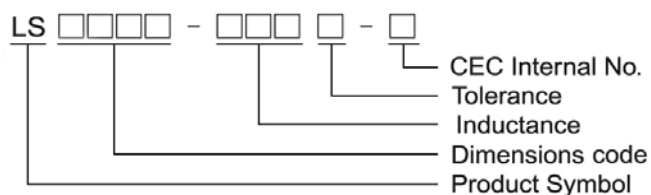

Shape and Dimensions / Recommended Pattern

LS0402/0603/0805/1008

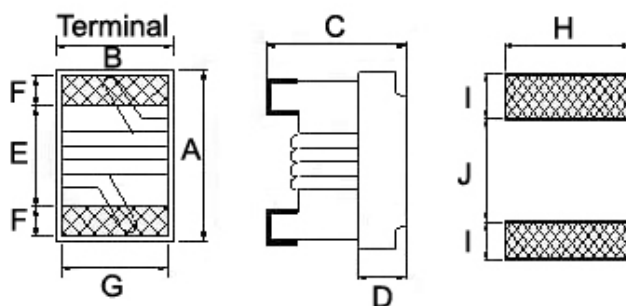

Dimensions in mm

TYPE	A Max	B Max	C Max	D	E	F	G	H	I	J
LS0402	1.02±0.1	0.55±0.1	0.56±0.1	0.25	0.54	0.23	0.50	0.65	0.38	0.44
LS0603	1.8	1.25	1.02	0.38	0.86	0.33	0.76	1.02	0.64	0.64
LS0805	2.4	1.72	1.52	0.70	1.02	0.50	1.27	1.78	1.02	0.76
LS1008	2.99	2.50	2.20	0.70	1.52	0.51	2.03	2.54	1.02	1.27

SMD Wire Wound Ferrite Chip Inductors – LS Series

Electrical Characteristics

art Number	Inductance (uH)	Test Frequency (MHz)	Tolerance (±%)	Q Typ	SRF (MHz)Typ	Rdc (Ω) Max	Irms (mA)Typ
LS0402-18N□-N	0.018	100	10 / 5	10	2600	0.055	1600
LS0402-20N□-N	0.020	100	10 / 5	10	2600	0.050	1600
LS0402-22N□-N	0.022	100	10	10	2500	0.072	1300
LS0402-33N□-N	0.033	100	10 / 5	10	2300	0.060	1400
LS0402-36N□-N	0.036	100	10 / 5	10	2300	0.092	1000
LS0402-39N□-N	0.039	100	10 / 5	10	2200	0.150	830
LS0402-51N□-N	0.051	100	10	10	1930	0.070	1100
LS0402-56N□-N	0.056	100	10	10	1900	0.125	900
LS0402-70N□-N	0.070	100	10 / 5	10	1900	0.130	900
LS0402-72N□-N	0.072	100	10 / 5	10	1650	0.100	900
LS0402-78N□-N	0.078	100	10 / 5	10	1600	0.190	850
LS0402-R10□-N	0.10	100	10	9	1400	0.160	900
LS0402-R14□-N	0.14	50	10 / 5	11	1220	0.260	540
LS0402-R18□-N	0.18	50	10	11	1150	0.330	560
LS0402-R20□-N	0.20	50	10 / 5	11	1000	0.440	400
LS0402-R22□-N	0.22	50	10 / 5	11	1150	0.530	380
LS0402-R25□-N	0.25	25	10 / 5	11	900	0.360	520
LS0402-R27□-N	0.27	25	10	11	860	0.550	360
LS0402-R30□-N	0.30	25	10 / 5	11	860	0.410	420
LS0402-R33□-N	0.33	7.9	10 / 5	11	820	0.680	350
LS0402-R36□-N	0.36	7.9	10 / 5	11	810	0.575	360
LS0402-R39□-N	0.39	7.9	10 / 5	11	760	0.890	300
LS0402-R42□-N	0.42	7.9	10 / 5	11	700	1.100	340
LS0402-R47□-N	0.47	7.9	10	11	650	0.730	310
LS0402-R56□-N	0.56	7.9	10 / 5	11	600	1.100	200

- When ordering, please specify tolerance and packaging codes.
- Tolerance : J = ±5% , K = ±10%
- L , Q : Agilent E4991A+ Agilent HP16197A
- SRF : Agilent E4991A
- Rdc : CH502BC/ HP4338B
- Irms for 15°C rise above 25°C ambient.
- Operating temperature range from -25°C to 105°C. (Including self - temperature rise)

Test Instruments : Agilent E4991A Material/Impedance Analyzer

Typical **L** vs. **F** Frequency

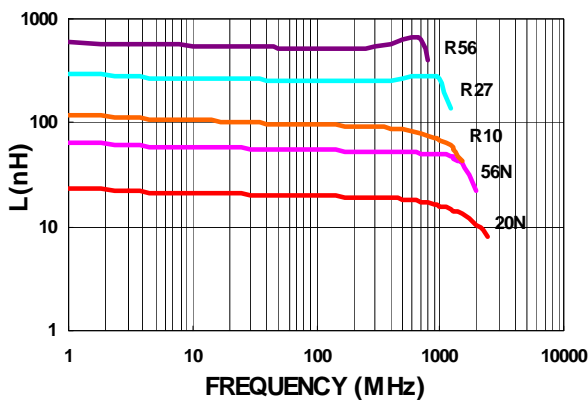

Typical **Q** vs. **F** Frequency

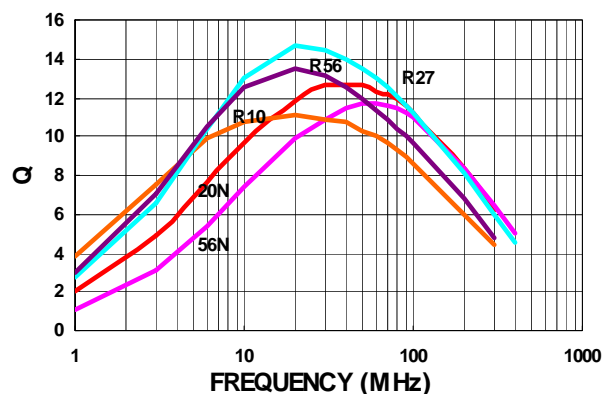

SMD Wire Wound Ferrite Chip Inductors – LS Series

Electrical Characteristics

Part Number	Inductance (uH)	Test Frequency (MHz)	Tolerance (±%)	Q Typ.	SRF (MHz) Min	Rdc (Ω) Max	Idc (mA)	Color
LS0603-47N□-N	0.047	7.9	10 / 5	17	1700	0.075	1500	Black
LS0603-72N□-N	0.072	7.9	10 / 5	17	1700	0.12	1500	Brown
LS0603-R10□-N	0.10	7.9	10 / 5	17	1650	0.13	1500	Red
LS0603-R12□-N	0.12	7.9	10 / 5	17	1350	0.15	1500	Orange
LS0603-R15□-N	0.15	7.9	10 / 5	17	1350	0.15	1450	Yellow
LS0603-R18□-N	0.18	7.9	10 / 5	17	1150	0.15	1400	Green
LS0603-R22□-N	0.22	7.9	10 / 5	17	1050	0.16	1350	Blue
LS0603-R24□-N	0.24	7.9	10 / 5	17	1050	0.19	1300	Violet
LS0603-R27□-N	0.27	7.9	10 / 5	17	1050	0.30	1050	Gray
LS0603-R33□-N	0.33	7.9	10 / 5	17	850	0.46	1200	White
LS0603-R39□-N	0.39	7.9	10 / 5	17	810	0.51	1200	Black
LS0603-R47□-N	0.47	7.9	10 / 5	17	720	0.62	1050	Brown
LS0603-R56□-N	0.56	7.9	10 / 5	17	600	0.44	850	Red
LS0603-R68□-N	0.68	7.9	10 / 5	17	600	0.52	850	Orange
LS0603-R78□-N	0.78	7.9	10 / 5	17	460	0.83	850	Yellow
LS0603-R82□-N	0.82	7.9	10 / 5	17	480	0.69	750	Green
LS0603-1R0□-N	1.0	7.9	10 / 5	18	310	0.81	600	Blue
LS0603-1R2□-N	1.2	7.9	10 / 5	17	270	0.87	550	Violet
LS0603-1R5□-N	1.5	7.9	10 / 5	17	270	1.06	540	Gray
LS0603-1R8□-N	1.8	7.9	10 / 5	17	230	1.10	520	White
LS0603-2R2□-N	2.2	7.9	10 / 5	17	140	1.20	500	Black
LS0603-2R7□-N	2.7	7.9	10 / 5	17	105	1.50	480	Brown
LS0603-3R3□-N	3.3	7.9	10 / 5	17	84	1.50	440	Red
LS0603-3R9□-N	3.9	7.9	10 / 5	17	80	1.60	430	Orange
LS0603-4R7□-N	4.7	7.9	10 / 5	18	69	2.10	420	Yellow
LS0603-5R6□-N	5.6	7.9	10 / 5	18	65	2.60	400	Green
LS0603-6R8□-N	6.8	7.9	10 / 5	19	55	3.10	400	Blue
LS0603-7R8□-N	7.8	7.9	10 / 5	17	47	3.50	400	Violet
LS0603-8R2□-N	8.2	7.9	10 / 5	17	42	3.80	400	Gray
LS0603-100□-N	10	7.9	10 / 5	19	40	4.80	300	White

- When ordering, please specify tolerance and packaging codes.
- Tolerance : J = ±5% , K = ±10%
- L , Q : Agilent E4991A+ Agilent HP16197A
- SRF : Agilent E4991A
- Rdc : CH502BC/ HP4338B
- Idc for Inductance drop 10% from its value without current.
- Operating temperature range from -25°C to 105°C. (Including self - temperature rise)

Test Instruments : Agilent E4991A Material/Impedance Analyzer

Typical L vs. Frequency

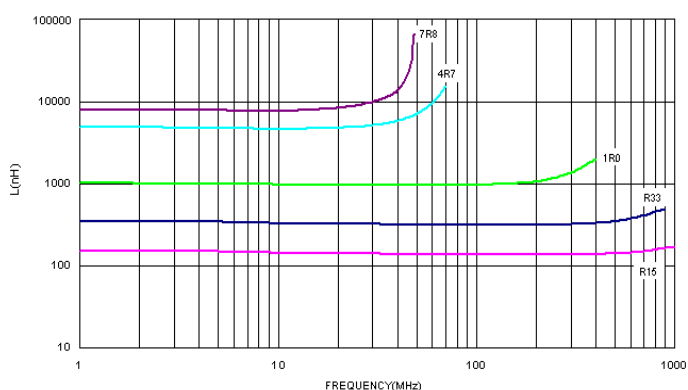

Typical Q vs. Frequency

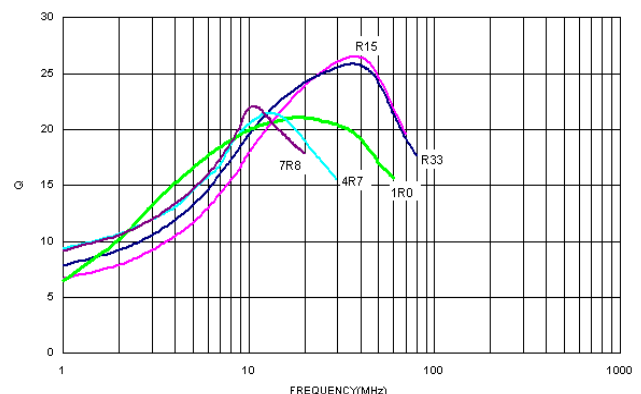

Electrical Characteristics

Part Number	Inductance (uH)	Test Frequency (MHz)	Tolerance (±%)	Q Typ.	SRF (MHz) Min	Rdc (Ω) Max	Idc (mA)	Color
LS0805-78N□-N	0.078	7.9	10 / 5	19	1440	0.06	2000	Black
LS0805-R11□-N	0.11	7.9	10 / 5	19	1200	0.07	2000	Brown
LS0805-R47□-N	0.47	7.9	10 / 5	19	480	0.40	800	Red
LS0805-R56□-N	0.56	7.9	10 / 5	19	480	0.40	800	Yellow
LS0805-R68□-N	0.68	7.9	10 / 5	20	480	0.40	800	Orange
LS0805-1R0□-N	1.0	7.9	10 / 5	20	400	0.69	700	Yellow
LS0805-1R5□-N	1.5	7.9	10 / 5	20	330	0.83	700	Green
LS0805-1R8□-N	1.8	7.9	10 / 5	20	300	1.00	650	Blue
LS0805-2R2□-N	2.2	7.9	10 / 5	20	250	1.10	650	Violet
LS0805-2R7□-N	2.7	7.9	10 / 5	23	200	1.25	650	Gray
LS0805-3R3□-N	3.3	7.9	10 / 5	23	160	1.45	650	White
LS0805-3R9□-N	3.9	7.9	10 / 5	23	90	1.50	600	Black
LS0805-4R7□-N	4.7	7.9	10 / 5	20	70	1.60	530	Brown
LS0805-5R6□-N	5.6	7.9	10 / 5	20	65	1.70	500	Red
LS0805-6R8□-N	6.8	7.9	10 / 5	20	45	1.95	470	Orange
LS0805-8R2□-N	8.2	2.5	10 / 5	16	45	2.10	450	Yellow
LS0805-100□-N	10	2.5	10 / 5	16	40	2.40	400	Green
LS0805-120□-N	12	2.5	10 / 5	16	38	3.20	360	Red
LS0805-150□-N	15	2.5	10 / 5	16	30	3.55	350	Blue
LS0805-180□-N	18	2.5	10 / 5	16	25	4.90	300	Orange
LS0805-220□-N	22	2.5	10 / 5	16	20	5.45	270	Violet
LS0805-270□-N	27	2.5	10 / 5	16	19	7.80	240	Gray
LS0805-470□-N	47	2.5	10 / 5	16	15	14.50	180	Brown

- When ordering, please specify tolerance and packaging codes.
- Tolerance : J = ±5% , K = ±10%
- L , Q : Agilent E4991A + Agilent HP16197A
- SRF : Agilent E4991A
- Rdc : CH502BC/ HP4338B
- Idc for Inductance drop 10% from its value without current.
- Operating temperature range from -25°C to 105°C. (Including self - temperature rise)

Test Instruments : Agilent E4991A Material/Impedance Analyzer

Typical **L** vs. **F**requency

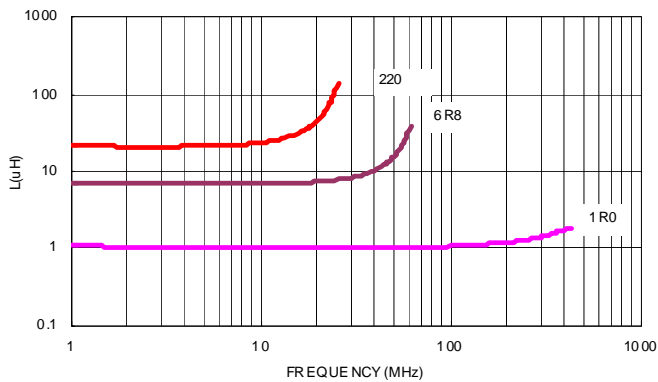

Typical **Q** vs. **F**requency

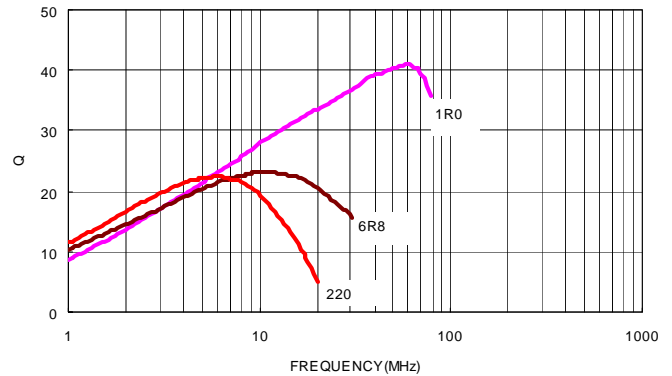

Electrical Characteristics

Part Number	Inductance (uH)	Test Frequency (MHz)	Tolerance (±%)	Q Typ.			SRF (MHz) Min	Rdc (Ω) Max	Idc (mA)	Color Coding		
				7.9MHz	25MHz	50MHz				1 ST	2 ND	3 RD
LS1008-1R2□-N	1.2	7.9	10 / 5	35	47	55	350	0.50	1200	Brown	Red	Red
LS1008-1R5□-N	1.5	7.9	10 / 5	38	53	58	300	0.65	1200	Brown	Green	Red
LS1008-1R8□-N	1.8	7.9	10 / 5	34	47	54	280	0.75	1050	Brown	Gray	Red
LS1008-2R2□-N	2.2	7.9	10 / 5	34	43	48	250	0.90	950	Red	Red	Red
LS1008-2R7□-N	2.7	7.9	10 / 5	38	49	51	200	1.00	950	Red	Violet	Red
LS1008-3R3□-N	3.3	7.9	10 / 5	42	57	58	200	1.15	900	Orange	Orange	Red
LS1008-3R9□-N	3.9	7.9	10 / 5	37	46	47	170	1.25	850	Orange	White	Red
LS1008-4R7□-N	4.7	7.9	10 / 5	37	43	38	130	1.35	700	Yellow	Violet	Red
LS1008-5R6□-N	5.6	7.9	10 / 5	36	40	29	110	1.45	700	Green	Blue	Red
LS1008-6R8□-N	6.8	7.9	10 / 5	33	39	33	105	1.60	600	Blue	Gray	Red
LS1008-8R2□-N	8.2	7.9	10 / 5	40	43	28	90	1.80	550	Gray	Red	Red
LS1008-100□-N	10.0	7.9	10 / 5	40	41	25	85	2.40	500	Brown	Black	Orange

- When ordering, please specify tolerance and packaging codes.
- Tolerance : J = ±5% , K = ±10%
- L/Q: Agilent E4991A+ Agilent HP16197A
- SRF: Agilent E4991A
- Rdc: CH502BC/ HP4338B
- Idc for Inductance drop 10% from its value without current
- Operating temperature range from -25°C to 105°C. (Including self - temperature rise)

Test Instruments : Agilent E4991A Material/Impedance Analyzer

Typical L vs. Frequency

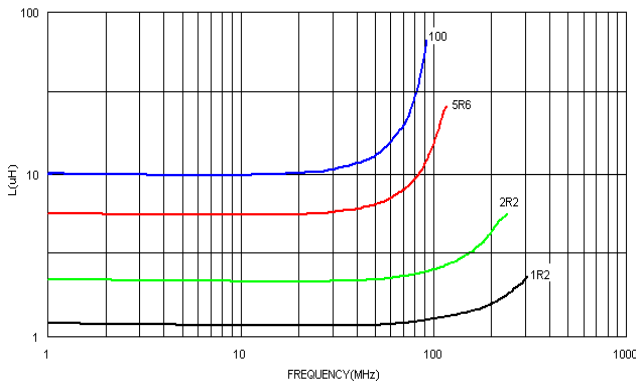

Typical Q vs. Frequency

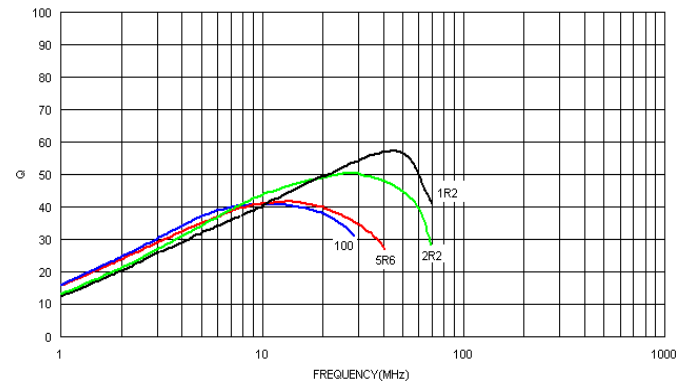

Packaging Specifications

Tape Dimensions

Tape Material

Figure 1

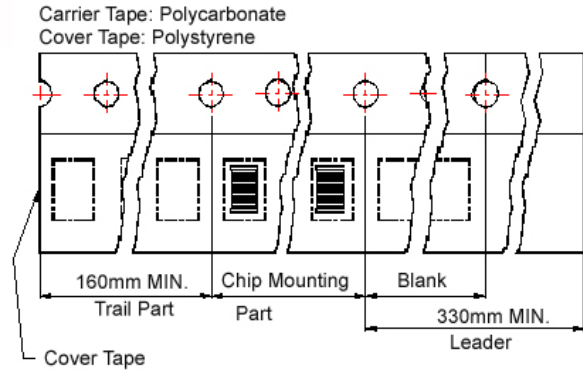
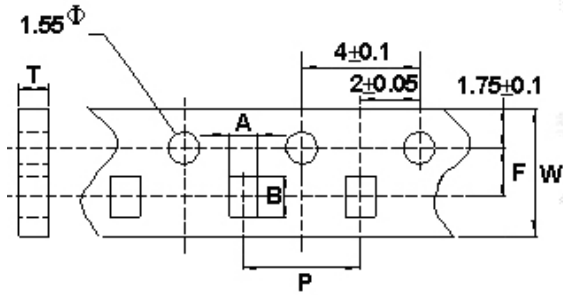
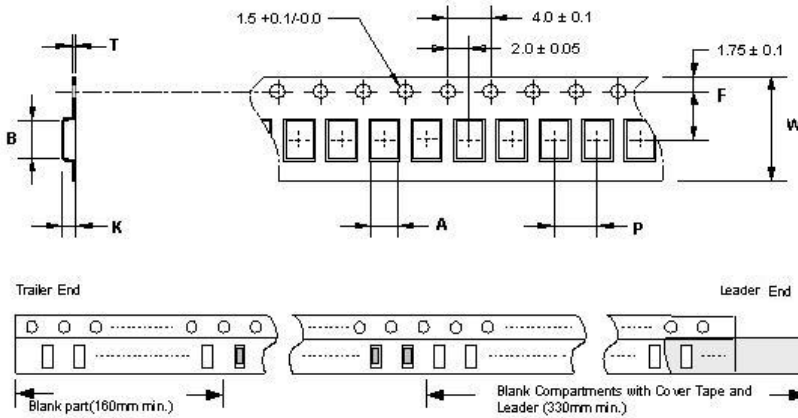
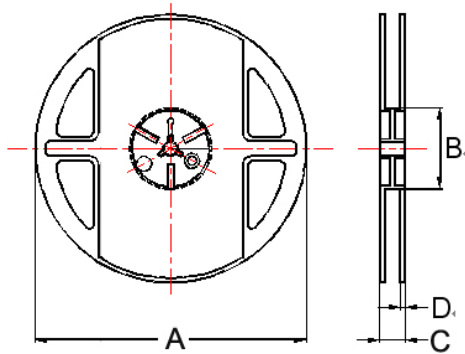

Figure 2



Reel Dimensions



Dimensions in mm

TYPE	Fig.	Tape Dimensions							Reel Dimensions				Quantity PCS / REEL
		A	B	T	W	P	F	K	A	B	C	D	
LS0402	2	0.67	1.20	0.75	8	2	3.5	0.53	178	60	12	1.5	4000
LS0603	1	1.23	1.90	0.97	8	4	3.5	-	178	60	12	1.5	4000
LS0805	2	1.60	2.42	0.22	8	4	3.5	1.45	178	60	12	1.5	2000
LS1008	2	2.40	2.93	0.26	8	4	3.5	2.25	178	60	12	1.5	2000

PS Series



PS series is the newest shielding type ferrite wire wound chip inductor. This wire wound ferrite construction provides extremely low DCR and high rating current.

Features

- RoHS compliant
- Shielded power inductors
- Specially designed ferrite cover provides magnetic shielding
- Best possible surface for pick and place handling

Applications

- Notebook computers
- PC cards
- Wireless communication
- Handheld devices

Product Identification

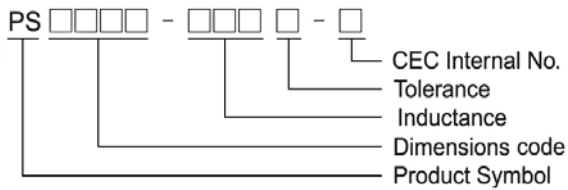

Shape and Dimensions / Recommended Pattern

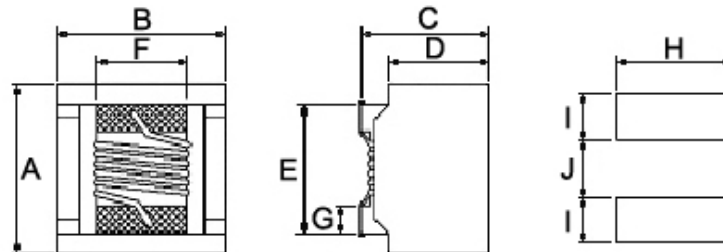

Dimensions in mm

TYPE	A Max	B Max	C Max	D	E	F	G	H	I	J	
PS1008	3.81	3.81	2.94	3.05	2.20	2.54	2.03	0.51	2.54	1.02	1.27

C : 2.94⁺⁰mm at 1R0~331/ 561~102
3.05⁺⁰mm at 471

Electrical Characteristics

Part Number	Inductance (uH)	Test Frequency (MHz)	Tolerance (±%)	Q Typ.	Test Frequency (MHz)	SRF (MHz) Typ.	Rdc (Ω) Max	Idc (A)
PS1008-1R0□-N	1.0	0.1	20 / 10	26	1	344	0.05	3.0
PS1008-1R5□-N	1.5	0.1	20 / 10	26	1	260	0.08	2.8
PS1008-1R8□-N	1.8	0.1	20 / 10	28	1	225	0.09	2.1
PS1008-2R7□-N	2.7	0.1	20 / 10	30	1	185	0.14	1.5
PS1008-3R9□-N	3.9	0.1	20 / 10	30	1	172	0.29	1.2
PS1008-4R7□-N	4.7	0.1	20 / 10	30	1	157	0.35	1.1
PS1008-5R6□-N	5.6	0.1	20 / 10	30	1	150	0.39	1.1
PS1008-6R8□-N	6.8	0.1	20 / 10	30	1	110	0.58	0.9
PS1008-100□-N	10	0.1	20 / 10	30	1	95	0.75	0.82
PS1008-150□-N	15	0.1	20 / 10	30	1	75	1.15	0.70
PS1008-220□-N	22	0.1	20 / 10	33	1	30	1.40	0.65
PS1008-330□-N	33	0.1	20 / 10	33	1	21	1.61	0.52
PS1008-390□-N	39	0.1	20 / 10	33	1	18	1.85	0.46
PS1008-470□-N	47	0.1	20 / 10	33	1	15	2.20	0.43
PS1008-680□-N	68	0.1	20 / 10	33	1	12	3.80	0.33
PS1008-820□-N	82	0.1	20 / 10	33	1	10	4.30	0.32
PS1008-101□-N	100	0.1	20 / 10	33	1	8	4.80	0.31
PS1008-121□-N	120	0.1	20 / 10	33	1	8	5.0	0.25
PS1008-151□-N	150	0.1	20 / 10	33	1	5.8	6.5	0.24
PS1008-221□-N	220	0.1	20 / 10	33	1	5.5	12.0	0.22
PS1008-331□-N	330	0.1	20 / 10	33	1	3.8	17.0	0.20
PS1008-471□-N	470	0.1	20 / 10	33	1	3.1	19.0	0.16
PS1008-561□-N	560	0.1	20 / 10	33	1	2.8	18.4	0.13
PS1008-681□-N	680	0.1	20 / 10	33	1	2.5	24.0	0.12
PS1008-821□-N	820	0.1	20 / 10	23	1	2.0	26.0	0.10
PS1008-102□-N	1000	0.1	20 / 10	20	1	1.5	29.2	0.10

- When ordering, please specify tolerance and packaging codes.
- Tolerance : K = ±10% , M =±20%
- L : Agilent/HP4285A 0.1Vrms
- Q : Agilent E4991A + Agilent HP16197A
- SRF : Agilent E4991A
- Rdc : CH502BC/ HP4338B
- Idc for Inductance drop 10% from its value without current.
- Operating temperature range from -40°C to 105°C. (Including self - temperature rise)

Packaging Specifications

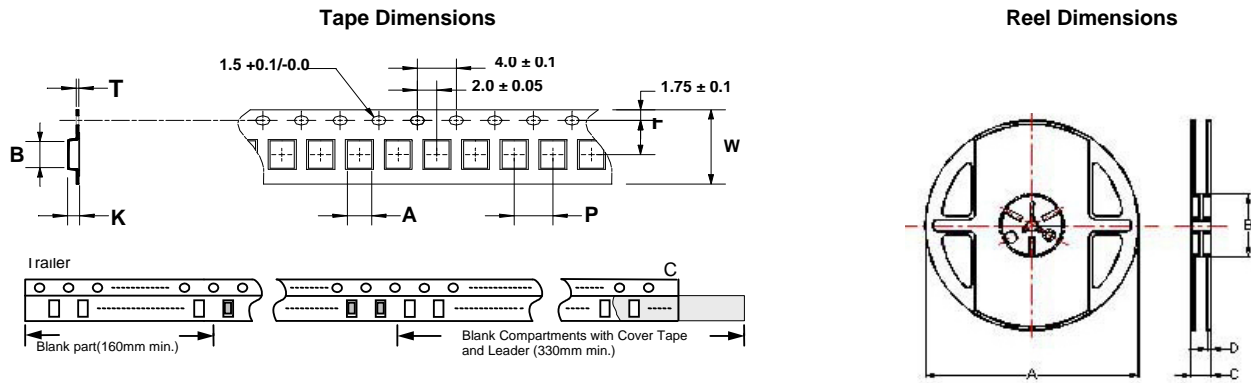

Dimensions in mm

TYPE	Tape Dimensions							Reel Dimensions				Quantity PCS / REEL
	A	B	T	W	P	F	K	A	B	C	D	
PS 1008	3.85	3.85	0.25	12	8	5.5	2.85	178	60	16	1.4	750

LT Series



LT series is the newest open type ferrite wire wound chip inductors. This wire wound ferrite construction supports thinness for low profile application.

Features

- RoHS compliant
- At just 1.05mm in height, these are one of Chilisin's lowest profile surface mount inductors
- Wire wound ferrite design supports lower R_{dc}, higher current ratings and exceptional Q values
- Inductance values from 0.12 to 39uH

Applications

- Boost IC for tiny panels of C-STN, TFT-LCD and OLED in backlight
- Buck/Boost IC using in DC to DC converter
- LC filter in power as well as signal lines

Product Identification

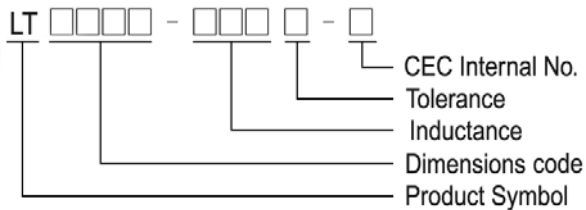

Shape and Dimensions / Recommended Pattern

LT0805/1210

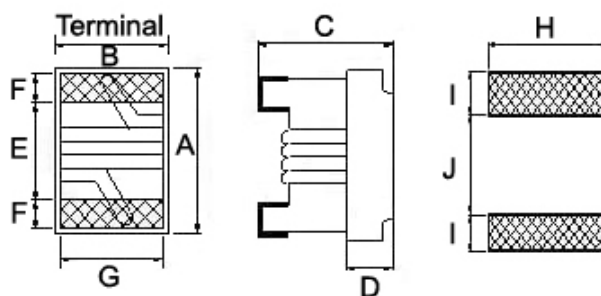

Dimensions in mm

TYPE	A Max	B Max	C Max	D Ref	E	F	G	H	I	J
LT0805	2.40	1.85	1.05	0.70	1.02	0.50	1.27	1.78	1.02	0.76
LT1210	3.75	3.10	1.05	0.65	1.80	0.65	2.35	2.70	1.00	2.00

Electrical Characteristics

Part Number	Inductance (uH)	Test Frequency (MHz)	Tolerance (±%)	Q Min	SRF (MHz) Min	Rdc (Ω)Max	Idc (mA) Max	Color
LT0805-R12□-N	0.12	25.2	10 / 5	22	1500	0.33	1200	Black
LT0805-R15□-N	0.15	25.2	10 / 5	22	1100	0.33	1200	Brown
LT0805-R18□-N	0.18	25.2	10 / 5	22	1100	0.36	1100	Red
LT0805-R22□-N	0.22	25.2	10 / 5	22	1100	0.39	1100	Orange
LT0805-R27□-N	0.27	25.2	10 / 5	22	950	0.43	1050	Yellow
LT0805-R33□-N	0.33	25.2	10 / 5	22	650	0.46	900	Green
LT0805-R39□-N	0.39	25.2	10 / 5	22	640	0.48	850	Blue
LT0805-R47□-N	0.47	25.2	10 / 5	22	570	0.65	800	Violet
LT0805-R56□-N	0.56	25.2	10 / 5	22	540	0.67	770	Gray
LT0805-R68□-N	0.68	25.2	10 / 5	22	500	0.73	750	White
LT0805-R82□-N	0.82	25.2	10 / 5	22	480	0.85	730	Black
LT0805-1R0□-N	1.0	7.96	10 / 5	15	470	0.87	720	Brown
LT0805-1R2□-N	1.2	7.96	10 / 5	15	450	0.97	690	Red
LT0805-1R5□-N	1.5	7.96	10 / 5	15	400	1.10	670	Orange
LT0805-1R8□-N	1.8	7.96	10 / 5	15	340	1.15	650	Yellow
LT0805-2R2□-N	2.2	7.96	10 / 5	15	265	1.28	630	Green
LT0805-2R7□-N	2.7	7.96	10 / 5	15	235	1.40	620	Blue
LT0805-3R3□-N	3.3	7.96	10 / 5	15	190	1.62	580	Violet
LT0805-3R9□-N	3.9	7.96	10 / 5	15	180	1.75	570	Gray
LT0805-4R7□-N	4.7	7.96	10 / 5	13	160	1.95	550	White
LT0805-5R6□-N	5.6	7.96	10 / 5	15	120	2.14	540	Black
LT0805-6R8□-N	6.8	7.96	10 / 5	15	45	2.28	520	Brown
LT0805-8R2□-N	8.2	7.96	10 / 5	15	42	2.55	500	Red
LT0805-100□-N	10	2.52	10 / 5	10	38	2.70	450	Orange
LT0805-120□-N	12	2.52	10 / 5	10	33	4.20	400	Yellow
LT0805-150□-N	15	2.52	10 / 5	10	30	4.80	380	Green
LT0805-180□-N	18	2.52	10 / 5	10	25	5.74	300	Blue
LT0805-220□-N	22	2.52	10 / 5	10	23	7.75	260	Violet
LT0805-270□-N	27	2.52	10 / 5	10	21	10.0	230	Gray
LT0805-330□-N	33	2.52	10 / 5	10	16	13.5	200	White
LT0805-390□-N	39	2.52	10 / 5	10	15	16.0	190	Black

- When ordering, please specify tolerance and packaging codes.
- Tolerance : J = ±5% , K = ±10%
- L , Q : Agilent E4991A + Agilent HP16197A
- SRF : Agilent E4991A
- Rdc : CH502BC/ HP4338B
- Idc for Inductance drop 10% from its value without current.
- Operating temperature range from -25°C to 105°C. (Including self - temperature rise)

Electrical Characteristics

Part Number	Inductance (μ H)	Test Frequency (MHz)	Tolerance (\pm %)	Q Typ.	SRF (MHz) Min	Rdc (Ω) Max	Idc (mA) Max	Color Coding		
								1 ST	2 ND	3 RD
LT1210-1R0□-N	1.0	7.96	10 / 5	20	350	0.45	1500	Brown	Black	Red
LT1210-1R2□-N	1.2	7.96	10 / 5	20	330	0.49	1300	Brown	Red	Red
LT1210-1R5□-N	1.5	7.96	10 / 5	20	310	0.68	1200	Brown	Green	Red
LT1210-1R8□-N	1.8	7.96	10 / 5	20	290	0.72	1150	Brown	Gray	Red
LT1210-2R2□-N	2.2	7.96	10 / 5	20	270	1.02	1020	Red	Red	Red
LT1210-2R7□-N	2.7	7.96	10 / 5	20	265	1.15	1000	Red	Violet	Red
LT1210-3R3□-N	3.3	7.96	10 / 5	20	195	1.20	970	Orange	Orange	Red
LT1210-3R9□-N	3.9	7.96	10 / 5	20	170	1.35	910	Orange	White	Red
LT1210-4R7□-N	4.7	7.96	10 / 5	20	155	1.48	880	Yellow	Violet	Red
LT1210-5R6□-N	5.6	7.96	10 / 5	20	125	1.65	820	Green	Blue	Red
LT1210-6R8□-N	6.8	7.96	10 / 5	20	110	1.68	750	Blue	Gray	Red
LT1210-8R2□-N	8.2	7.96	10 / 5	20	100	1.88	700	Gray	Red	Red
LT1210-100□-N	10	2.52	10 / 5	16	85	2.90	610	Brown	Black	Orange
LT1210-120□-N	12	2.52	10 / 5	16	70	3.05	540	Brown	Red	Orange
LT1210-150□-N	15	2.52	10 / 5	16	65	3.45	500	Brown	Green	Orange
LT1210-180□-N	18	2.52	10 / 5	16	55	4.79	420	Brown	Gray	Orange
LT1210-220□-N	22	2.52	10 / 5	16	50	5.20	350	Red	Red	Orange

- When ordering, please specify tolerance and packaging codes.
- Tolerance : J = \pm 5% , K = \pm 10%
- L , Q : Agilent E4991A + Agilent HP16197A
- SRF : Agilent E4991A
- Rdc : CH502BC/ HP4338B
- Idc for Inductance drop 10% from its value without current.
- Operating temperature range from -25°C to 105°C. (Including self - temperature rise)

Packaging Specifications

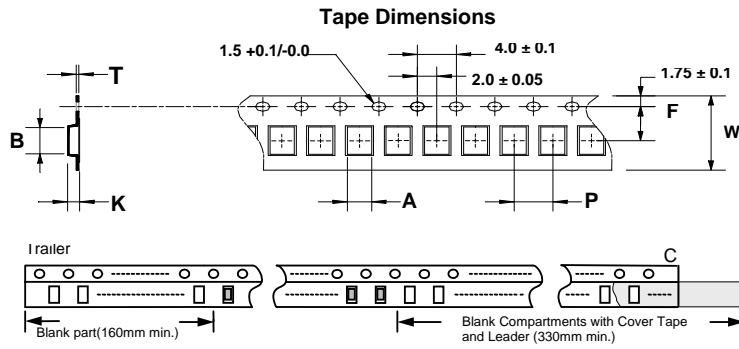

Reel Dimensions

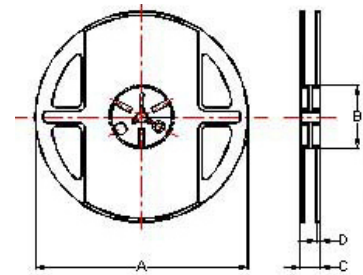

Dimensions in mm

TYPE	Tape Dimensions							Reel Dimensions				Quantity
	A	B	T	W	P	F	K	A	B	C	D	PCS / REEL
LT0805	1.85	2.45	0.23	8	4	3.5	1.0	178	60	12	1.5	2000
LT1210	3.05	3.70	0.25	12	4	5.5	1.1	178	60	12	1.5	2000

SQV Series



SQV Series comes in 2 sizes with wide inductance range, high Q value at high frequencies and low DC resistance.

Features

- RoHS compliant
- Miniature chip inductors wound on a special ferrite core
- High Q value at high frequencies and low DC resistance
- Wide inductance range
- Excellent solder heat resistance
- Both flow and reflow soldering methods can be employed

Applications

- Personal, cordless phone
- High Freq. communication products
- GPS (global position system)
- Personal computers

Product Identification

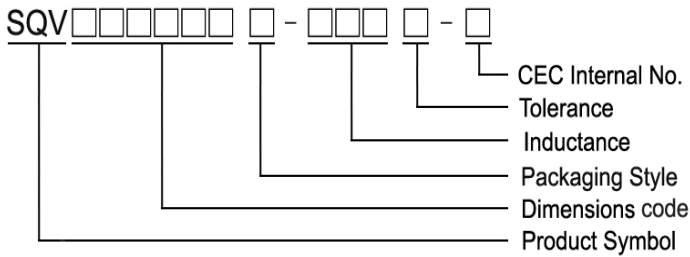

- Packaging: T : Tape and Reel

Shape and Dimensions

SQV322520

SQV453226

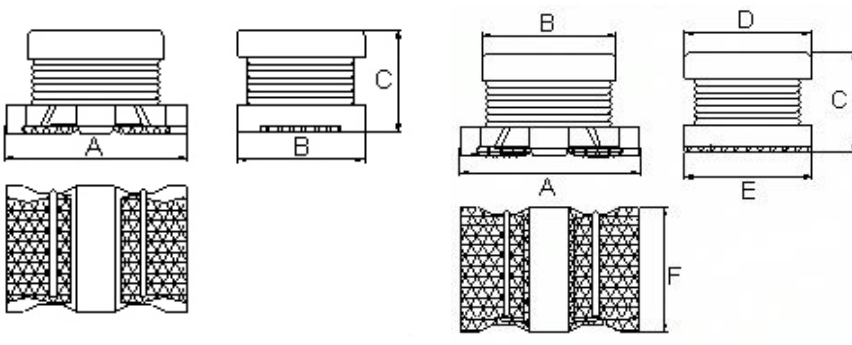

Dimensions in mm

TYPE	A	B	C	D	E	F
SQV322520	3.2±0.3	2.5±0.2	2.0±0.2	-	-	-
SQV453226	4.5±0.3	3.6±0.2	2.6±0.2	3.2±0.2	3.2±0.2	3.2±0.2

Recommended Pattern

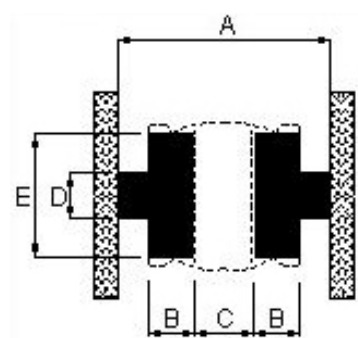

Dimensions in mm

TYPE	A	B	C	D	E
SQV322520	5.5	1.0	1.3	1.0	2.0
SQV453226	7.5	1.5	1.5	1.5	3.0

Electrical Characteristics

Part Number	Inductance (uH)	Test Frequency (MHz)	Tolerance (±%)	Q Min	Test Frequency (MHz)	D.C. Resistance (Ω) Max	SRF (MHz) Min	Rated current (mA)
SQV322520T-R18□-N	0.18	1	20	20	25.2	0.25	200	650
SQV322520T-R27□-N	0.27	1	20	25	25.2	0.25	200	600
SQV322520T-R39□-N	0.39	1	20	25	25.2	0.25	200	530
SQV322520T-R56□-N	0.56	1	20	30	25.2	0.25	160	530
SQV322520T-R68□-N	0.68	1	20	30	25.2	0.25	160	470
SQV322520T-R82□-N	0.82	1	20	30	25.2	0.25	120	450
SQV322520T-1R0□-N	1.0	1	20	20	1	0.50	100	445
SQV322520T-1R2□-N	1.2	1	20	20	1	0.60	100	425
SQV322520T-1R5□-N	1.5	1	20 / 10	20	1	0.60	75	400
SQV322520T-1R8□-N	1.8	1	20 / 10	20	1	0.70	60	390
SQV322520T-2R2□-N	2.2	1	20 / 10	20	1	0.80	50	370
SQV322520T-2R7□-N	2.7	1	20 / 10	20	1	0.90	43	320
SQV322520T-3R3□-N	3.3	1	20 / 10	20	1	1.0	38	300
SQV322520T-3R9□-N	3.9	1	20 / 10	20	1	1.1	35	290
SQV322520T-4R7□-N	4.7	1	20 / 10	20	1	1.2	31	270
SQV322520T-5R6□-N	5.6	1	20 / 10	20	1	1.3	28	250
SQV322520T-6R8□-N	6.8	1	20 / 10	20	1	1.5	25	240
SQV322520T-8R2□-N	8.2	1	20 / 10	20	1	1.6	23	225
SQV322520T-100□-N	10	1	10 / 5	35	1	1.8	20	190
SQV322520T-120□-N	12	1	10 / 5	35	1	2.0	18	180
SQV322520T-150□-N	15	1	10 / 5	35	1	2.2	16	170
SQV322520T-180□-N	18	1	10 / 5	35	1	2.5	15	165
SQV322520T-220□-N	22	1	10 / 5	35	1	2.8	14	150
SQV322520T-270□-N	27	1	10 / 5	35	1	3.1	13	125
SQV322520T-330□-N	33	1	10 / 5	40	1	3.5	12	115
SQV322520T-390□-N	39	1	10 / 5	40	1	3.9	11	110
SQV322520T-470□-N	47	1	10 / 5	40	1	4.3	11	100
SQV322520T-560□-N	56	1	10 / 5	40	1	4.9	10.0	85
SQV322520T-680□-N	68	1	10 / 5	40	1	5.5	9.0	80
SQV322520T-820□-N	82	1	10 / 5	40	1	6.2	8.5	70
SQV322520T-101□-N	100	1	10 / 5	40	0.796	7.0	8.0	80
SQV322520T-121□-N	120	1	10 / 5	40	0.796	8.0	7.5	75
SQV322520T-151□-N	150	1	10 / 5	40	0.796	9.3	7.0	70
SQV322520T-181□-N	180	1	10 / 5	40	0.796	10.2	6.0	65
SQV322520T-221□-N	220	1	10 / 5	40	0.796	11.8	5.5	65
SQV322520T-271□-N	270	1	10 / 5	40	0.796	12.5	5.0	65
SQV322520T-331□-N	330	1	10 / 5	40	0.796	13.0	5.0	65
SQV322520T-391□-N	390	1	10 / 5	50	0.796	22.0	5.0	50
SQV322520T-471□-N	470	0.001	10 / 5	50	0.796	25.0	5.0	45
SQV322520T-561□-N	560	0.001	10 / 5	50	0.796	28.0	2.0	40

- When ordering, please specify tolerance and packaging codes
- Rated Current: Self temperature rise shall be limited to 35°C Max. Inductance drop 10% typ.
- Operating temp: -40°C ~ 125°C. (Including self - temperature rise)
- Soldering Heat: 260°C 10 sec after 150°C preheat cycle for 4 min
- Tolerance: J = ±5% , K = ±10% , M = ±20%
- Test Equipment: L & Q: HP4285A LF Impedance Analyzer
SRF: HP4291A RF Impedance Analyzer
DCR: CH502BC/ HP4338B

Electrical Characteristics

Part Number	Inductance (uH)	Test Frequency (MHz)	Tolerance (±%)	Q Min	Test Frequency (MHz)	D.C. Resistance (Ω) Max	SRF (MHz) Min	Rated current (mA)
SQV453226T-1R0□-N	1.0	1	20	20	1	0.20	120	500
SQV453226T-1R2□-N	1.2	1	20	20	1	0.20	100	500
SQV453226T-1R5□-N	1.5	1	20	20	1	0.30	85	500
SQV453226T-1R8□-N	1.8	1	20	20	1	0.30	75	500
SQV453226T-2R2□-N	2.2	1	20	20	1	0.30	62	500
SQV453226T-2R7□-N	2.7	1	20	20	1	0.32	53	500
SQV453226T-3R3□-N	3.3	1	20	20	1	0.35	47	500
SQV453226T-3R9□-N	3.9	1	20	20	1	0.38	41	500
SQV453226T-4R7□-N	4.7	1	20 / 10	30	1	0.40	38	500
SQV453226T-5R6□-N	5.6	1	20 / 10	30	1	0.47	33	500
SQV453226T-6R8□-N	6.8	1	20 / 10	30	1	0.50	31	450
SQV453226T-8R2□-N	8.2	1	20 / 10	30	1	0.56	27	450
SQV453226T-100□-N	10	1	10 / 5	35	1	0.56	23	400
SQV453226T-120□-N	12	1	10 / 5	35	1	0.62	21	380
SQV453226T-150□-N	15	1	10 / 5	35	1	0.73	19	360
SQV453226T-180□-N	18	1	10 / 5	35	1	0.82	17	340
SQV453226T-220□-N	22	1	10 / 5	35	1	0.94	15	320
SQV453226T-270□-N	27	1	10 / 5	35	1	1.1	14	300
SQV453226T-330□-N	33	1	10 / 5	35	1	1.2	12	270
SQV453226T-390□-N	39	1	10 / 5	35	1	1.4	11	240
SQV453226T-470□-N	47	1	10 / 5	35	1	1.5	10	220
SQV453226T-560□-N	56	1	10 / 5	35	1	1.7	9.3	200
SQV453226T-680□-N	68	1	10 / 5	35	1	1.9	8.4	180
SQV453226T-820□-N	82	1	10 / 5	35	1	2.2	7.5	170
SQV453226T-101□-N	100	1	10 / 5	40	0.796	2.5	6.8	160
SQV453226T-121□-N	120	1	10 / 5	40	0.796	3.0	6.2	150
SQV453226T-151□-N	150	1	10 / 5	40	0.796	3.7	5.5	130
SQV453226T-181□-N	180	1	10 / 5	40	0.796	4.5	5.0	120
SQV453226T-221□-N	220	1	10 / 5	40	0.796	5.4	4.5	110
SQV453226T-271□-N	270	1	10 / 5	40	0.796	6.8	4.0	100
SQV453226T-331□-N	330	1	10 / 5	40	0.796	8.2	3.6	95
SQV453226T-391□-N	390	1	10 / 5	40	0.796	9.7	3.3	90
SQV453226T-471□-N	470	0.001	10 / 5	40	0.796	11.8	3.0	80
SQV453226T-561□-N	560	0.001	10 / 5	40	0.796	14.5	2.7	70
SQV453226T-681□-N	680	0.001	10 / 5	40	0.796	17.5	2.5	65
SQV453226T-821□-N	820	0.001	10 / 5	40	0.796	20.5	2.2	60
SQV453226T-102□-N	1000	0.001	10 / 5	40	0.252	25.0	2.0	50
SQV453226T-122□-N	1200	0.001	10 / 5	40	0.252	30.0	1.8	45
SQV453226T-152□-N	1500	0.001	10 / 5	40	0.252	37.0	1.6	40
SQV453226T-182□-N	1800	0.001	10 / 5	40	0.252	45.0	1.5	35
SQV453226T-222□-N	2200	0.001	10 / 5	40	0.252	50.0	1.3	30

- When ordering, please specify tolerance and packaging codes
- Rated Current: Self temperature rise shall be limited to 35°C Max. Inductance drop 10% typ.
- Operating temp: -40°C ~ 125°C. (Including self - temperature rise)
- Soldering Heat: 260°C 10 sec after 150°C preheat cycle for 4 min
- Inductance tolerance: J = ±5% K = ±10% M = ±20%
- Test Equipment: L & Q: HP4285A LF Impedance Analyzer
SRF: HP4291A RF Impedance Analyzer
DCR: CH502BC/ HP4338B

Packaging Specifications

Tape Dimensions

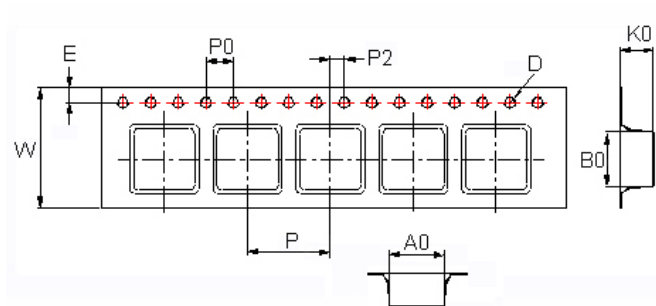

Tape Material

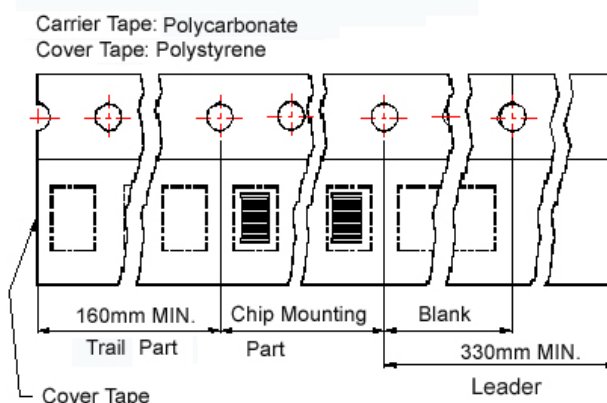

Reel Dimensions

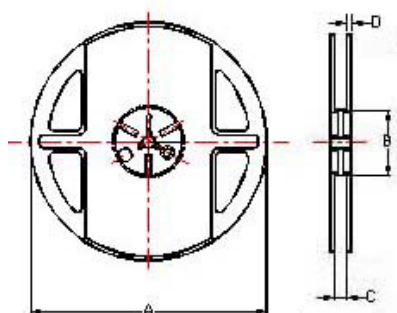

Dimensions in mm

TYPE	Tape Dimensions									Reel Dimensions				Quantity
	A0	B0	K0	D	E	W	P	P0	P2	A	B	C	D	PCS / REEL
SQV322520	2.90	3.60	2.25	1.5	1.75	8	4	4	2	178	60	9	1.5	2000
SQV453226	3.60	4.90	3.00	1.5	1.75	12	8	4	2	178	60	13.2	1.5	500

SQC Series



Features

- RoHS compliant
- Low DC resistance, high current capacity, and high impedance characteristics
- Excellent solder heat resistance
- Both flow and reflow soldering methods can be employed
- Available in 4 sizes

Applications

- Personal computers
- Disk drives and computer peripherals
- Pagers, cordless phone
- DC power supply circuit

Product Identification

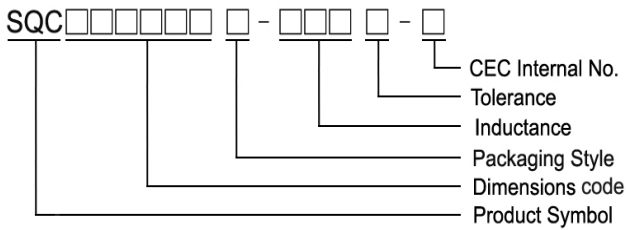

- Packaging: T : Tape and Reel

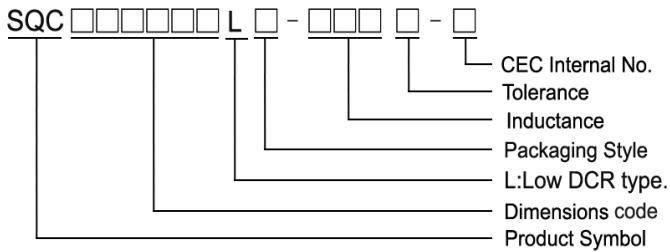

- Packaging: T : Tape and Reel

Shape and Dimensions

SQC321618 & SQC322520 & SQC322520LT

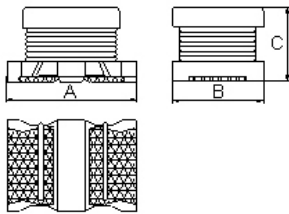

SQC322517 & SQC322517HP

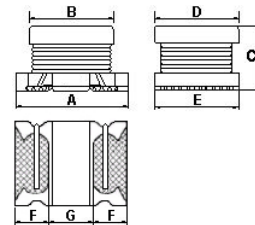

SQC453226

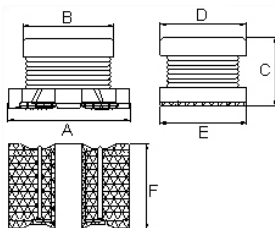

SQC575047

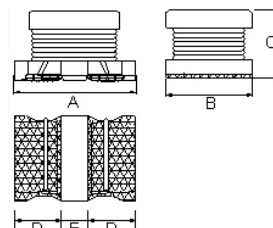

SMD Wire Wound Ferrite Chip Inductors - SQC Series

Dimensions in mm

TYPE	A	B	C	D	E	F	G
SQC321618	3.2 ± 0.3	1.6 ± 0.2	1.8 ± 0.2	-	-	-	-
SQC322517	3.2 ± 0.3	2.5 ± 0.2	1.55 ± 0.15	2.5 ± 0.2	2.5 ± 0.2	0.9 ± 0.3	1.3 ± 0.2
SQC322517HP	3.2 ± 0.3	2.5 ± 0.2	1.55 ± 0.15	2.5 ± 0.2	2.5 ± 0.2	0.9 ± 0.3	1.3 ± 0.2
SQC322520	3.2 ± 0.3	2.5 ± 0.2	2.0 ± 0.2	-	-	-	-
SQC322520LT	3.2 ± 0.3	2.5 ± 0.2	2.0 ± 0.2	-	-	-	-
SQC453226	4.5 ± 0.3	3.6 ± 0.2	2.6 ± 0.2	3.2 ± 0.2	3.2 ± 0.2	3.2 ± 0.2	-
SQC575047	5.7 ± 0.3	5.0 ± 0.3	4.7 ± 0.3	1.3 Min	1.7 Min	-	-

Recommended Pattern

SQC321618

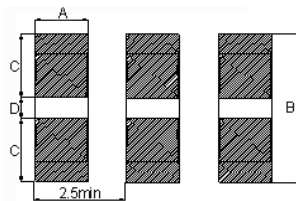

Dimensions in mm

TYPE	A	B	C	D
SQC321618	1.5	4.5	1.75	1.0

SQC575047

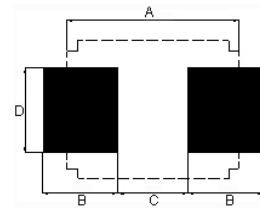

Dimensions in mm

TYPE	A	B	C	D
SQC575047	8.0	3.0	2.0	3.5

SQC322517 & SQC322517HP

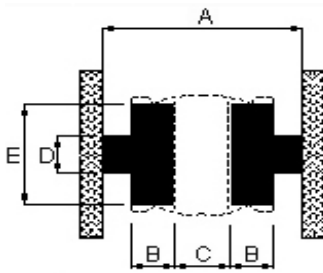

Dimensions in mm

TYPE	A	B	C	D	E
SQC322517	5.5	1.0	1.3	1.0	2.0
SQC322517HP	5.5	1.0	1.3	1.0	2.0

SQC322520 & SQC322520LT & SQC453226

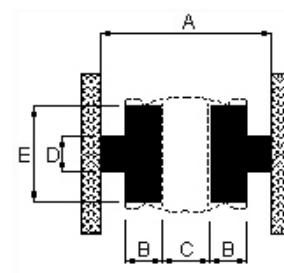

Dimensions in mm

TYPE	A	B	C	D	E
SQC322520	5.5	1.0	1.3	1.0	2.0
SQC322520LT	5.5	1.0	1.3	1.0	2.0
SQC453226	7.5	1.5	1.5	1.5	3.0

Electrical Characteristics

Part Number	Inductance (uH)	Tolerance (±%)	Test Frequency (MHz)	D.C. Resistance (Ω) Max	SRF (MHz) Min	Rated current (mA)
SQC321618T-R12□-N	0.12	20	1	0.112	250	970
SQC321618T-R22□-N	0.22	20	1	0.140	250	850
SQC321618T-R47□-N	0.47	20	1	0.210	180	700
SQC321618T-1R0□-N	1.0	20	1	0.364	100	510
SQC321618T-2R2□-N	2.2	20	1	0.533	50	430
SQC321618T-4R7□-N	4.7	20 / 10	1	0.845	31	340
SQC321618T-100□-N	10	10 / 5	1	1.690	20	230
SQC321618T-220□-N	22	10 / 5	1	3.900	14	160
SQC321618T-470□-N	47	10 / 5	1	10.40	10	100
SQC321618T-101□-N	100	10 / 5	1	15.60	7	80

- When ordering, please specify tolerance and packaging codes
- Rated Current: Self temperature rise shall be limited to 35°C Max. Inductance drop 10% typ.
- Tolerance : J = ±5% , K = ±10% , M = ±20%
- Operating temp: - 2 5 °C ~ 1 2 5 °C (Including self - temperature rise)
- Soldering Heat: 260°C 10 seconds after 150°C preheat cycle for 4 minutes
- Test Equipment: L: HP4192A. LF Impedance Analyzer
SRF: HP4291A RF Impedance Analyzer
DCR: CH502BC

Electrical Characteristics

Part Number	Inductance (uH)	Tolerance (±%)	Test Frequency (MHz)	D.C. Resistance (Ω±30%)	SRF (MHz) Min	Rated current (mA)
SQC322517T-2R2□-N	2.2	20	1	0.097	64	790
SQC322517T-3R3□-N	3.3	20	1	0.12	50	710
SQC322517T-6R8□-N	6.8	20	1	0.25	32	540
SQC322517T-100□-N	10	10,20	1	0.30	26	350
SQC322517T-220□-N	22	10,20	1	0.71	19	250
SQC322517T-101□-N	100	10,20	1	3.50	10	100

- When ordering, please specify tolerance and packaging codes
- Rated Current: Inductance drop 10% typ.
- Tolerance : K = ±10% , M = ±20%
- Operating temp: - 2 5 °C ~ 1 2 5 °C (Including self - temperature rise)
- Soldering Heat: 260°C 10 seconds after 150°C preheat cycle for 4 minutes
- Test Equipment: L: HP4284A
SRF: HP4287A
DCR: CH502BC

Electrical Characteristics

Part Number	Inductance (μ H)	Tolerance (\pm %)	Test Frequency (MHz)	D.C. Resistance ($\Omega \pm 20\%$)	SRF (MHz) Min	Rated current (mA)	Irms (mA)
SQC322517HP-R47□-N	0.47	30	1	0.030	100	3400	2550
SQC322517HP-1R0□-N	1.0	30	1	0.045	100	2300	2050
SQC322517HP-1R5□-N	1.5	30	1	0.057	70	1750	1750
SQC322517HP-2R2□-N	2.2	30	1	0.076	70	1550	1600
SQC322517HP-3R3□-N	3.3	30	1	0.120	50	1250	1200
SQC322517HP-4R7□-N	4.7	30	1	0.180	40	1000	1000
SQC322517HP-6R8□-N	6.8	30	1	0.240	40	850	850
SQC322517HP-100□-N	10	30	1	0.380	30	750	700
SQC322517HP-150□-N	15	30	1	0.700	25	550	500
SQC322517HP-220□-N	22	30	1	0.810	20	500	450
SQC322517HP-330□-N	33	30	1	1.050	14	360	320
SQC322517HP-470□-N	47	30	1	1.480	11	280	240

- When ordering, please specify tolerance and packaging codes
- Rated Current: Self temperature rise shall be limited to 40°C Max. Inductance drop 30% typ.
- Tolerance : T = $\pm 30\%$
- Operating temp: -40°C ~ 125°C (Including self - temperature rise)
- Soldering Heat: 260°C 10 seconds after 150°C preheat cycle for 4 minutes
- Test Equipment: L: HP4284A
SRF: HP4291A RF Impedance Analyzer
DCR: CH502BC

Electrical Characteristics

Part Number	Inductance (μ H)	Tolerance (\pm %)	Test Frequency (MHz)	D.C. Resistance ($\Omega \pm 30\%$)	SRF (MHz) Min	Rated current (mA)
SQC322520T-1R0□-N	1.0	20	1	0.09	96	1000
SQC322520T-2R2□-N	2.2	20	1	0.13	64	600
SQC322520T-4R7□-N	4.7	20	1	0.20	43	450
SQC322520T-100□-N	10	20	1	0.44	26	300
SQC322520T-220□-N	22	20 / 10	1	0.71	19	250
SQC322520T-470□-N	47	20 / 10	1	1.30	15	170
SQC322520T-101□-N	100	20 / 10	1	3.50	10	100
SQC322520T-221□-N	220	20 / 10	1	8.40	6.8	70
SQC322520T-331□-N	330	20 / 10	1	10.0	5.6	60
SQC322520T-391□-N	390	20 / 10	1	17.0	5.0	60
SQC322520T-471□-N	470	20 / 10	0.001	19.0	5.0	60
SQC322520T-561□-N	560	20 / 10	0.001	22.0	5.0	60

- When ordering, please specify tolerance and packaging codes
- Rated Current: Self temperature rise shall be limited to 35°C Max. Inductance drop 10% typ.
- Tolerance : K = $\pm 10\%$, M = $\pm 20\%$
- Operating temp: -40°C ~ 125°C (Including self - temperature rise)
- Soldering Heat: 260°C 10 seconds after 150°C preheat cycle for 4 minutes
- Test Equipment: L: HP4192A. LF Impedance Analyzer
SRF: HP4291A RF Impedance Analyzer
DCR: CH502BC

Electrical Characteristics (LOW DCR Type)

Part Number	Inductance (uH)	Tolerance (±%)	Test Frequency (MHz)	D.C. Resistance (Ω±30%)	SRF (MHz) Min	Rated current (mA)
SQC322520LT-R15□-N	0.15	20	1	0.028	400	1450
SQC322520LT-R27□-N	0.27	20	1	0.034	250	1250
SQC322520LT-R47□-N	0.47	20	1	0.042	150	1100
SQC322520LT-1R0□-N	1.0	20	1	0.060	100	1000
SQC322520LT-2R2□-N	2.2	20	1	0.097	64	790
SQC322520LT-4R7□-N	4.7	20	1	0.15	43	650
SQC322520LT-100□-N	10	20 / 10	1	0.30	26	450

- When ordering, please specify tolerance and packaging codes
- Rated Current: Self temperature rise shall be limited to 35°C Max. Inductance drop 10% typ.
- Tolerance : K = ±10% , M = ±20%
- Operating temp: - 2 5 °C ~ 1 2 5 °C (Including self - temperature rise)
- Soldering Heat: 260°C 10 seconds after 150°C preheat cycle for 4 minutes
- Test Equipment: L: HP4192A. LF Impedance Analyzer
SRF: HP4291A RF Impedance Analyzer
DCR: CH502BC

Electrical Characteristics

Part Number	Inductance (uH)	Tolerance (±%)	Test Frequency (MHz)	D.C. Resistance (Ω) Max	SRF (MHz) Min	Rated current (mA)
SQC453226T-1R0□-N	1.0	20	1	0.08	100	1080
SQC453226T-1R5□-N	1.5	20	1	0.09	85	1000
SQC453226T-2R2□-N	2.2	20	1	0.11	60	900
SQC453226T-3R3□-N	3.3	20	1	0.13	47	800
SQC453226T-4R7□-N	4.7	10 / 20	1	0.15	35	750
SQC453226T-6R8□-N	6.8	10 / 20	1	0.20	30	720
SQC453226T-100□-N	10	5 / 10	1	0.24	23	650
SQC453226T-150□-N	15	5 / 10	1	0.32	20	570
SQC453226T-220□-N	22	5 / 10	1	0.60	15	420
SQC453226T-330□-N	33	5 / 10	1	1.0	12	310
SQC453226T-470□-N	47	5 / 10	1	1.1	10	280
SQC453226T-680□-N	68	5 / 10	1	1.7	8.4	220
SQC453226T-101□-N	100	5 / 10	1	2.2	6.8	190
SQC453226T-151□-N	150	5 / 10	1	3.5	5.5	130
SQC453226T-221□-N	220	5 / 10	1	4.0	4.5	110
SQC453226T-331□-N	330	5 / 10	1	6.8	3.6	100
SQC453226T-471□-N	470	5 / 10	0.001	8.5	3.0	90

- When ordering, please specify tolerance and packaging codes
- Rated Current: Self temperature rise shall be limited to 35°C Max. Inductance drop 10% typ.
- Tolerance : J = ±5% , K = ±10% , M = ±20%
- Operating temp: - 2 5 °C ~ 1 2 5 °C (Including self - temperature rise)
- Soldering Heat: 260°C 10 seconds after 150°C preheat cycle for 4 minutes
- Test Equipment: L: HP4192A. LF Impedance Analyzer
SRF: HP4291A RF Impedance Analyzer
DCR: CH502BC

Packaging Specifications

Tape Dimensions

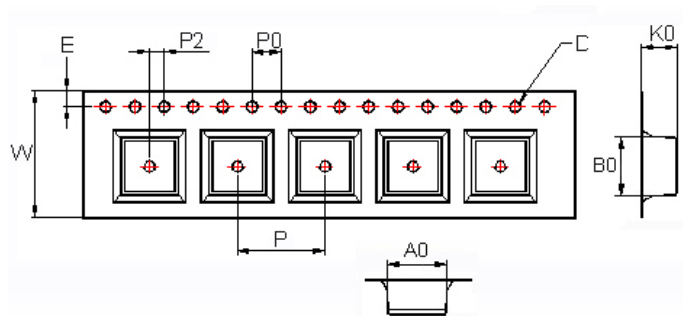

Tape Material

Carrier Tape: Polycarbonate
Cover Tape: Polystyrene

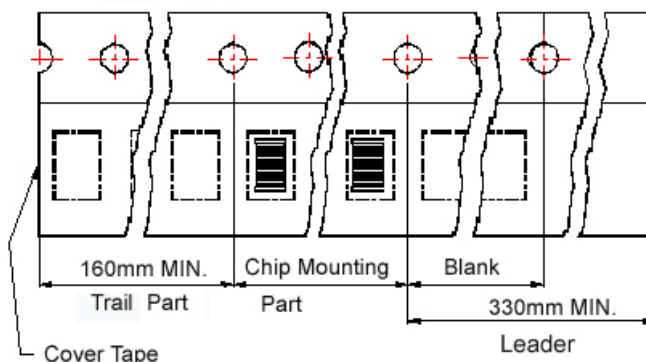

Reel Dimensions

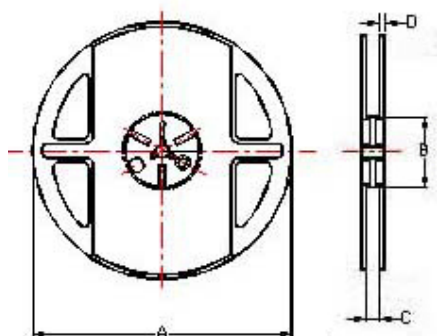

Dimensions in mm

TYPE	Tape Dimensions									Reel Dimensions				Quantity
	A0	B0	K0	D	E	W	P	P0	P2	A	B	C	D	PCS / REEL
SQC201609	1.9	2.3	1.1	1.55	1.75	8	4	4	2	178	60	9	1.5	3000
SQC3010	3.2	3.2	1.4	1.55	1.75	8	4	4	2	178	60	9	1.5	2000
SQC321618	1.85	3.55	2.05	1.5	1.75	8	4	4	2	178	60	9	1.5	2000
SQC322517	2.85	3.56	1.80	1.55	1.75	8	4	4	2	178	60	9	1.5	2000
SQC322517HP	2.85	3.56	1.80	1.55	1.75	8	4	4	2	178	60	9	1.5	2000
SQC322520	2.90	3.60	2.25	1.5	1.75	8	4	4	2	178	60	9	1.5	2000
SQC322520LT	2.90	3.60	2.25	1.5	1.75	8	4	4	2	178	60	9	1.5	2000
SQC453226	3.60	4.90	3.00	1.5	1.75	12	8	4	2	178	60	13.2	1.5	500
SQC575047	5.4	6.0	5.5	1.5	1.75	16	12	12	2	330	100	17	1.5	1000

Multilayer Ferrite Chip Beads



Chilisin offers a wide range of multi-layered ferrite chip beads with various sizes, frequency characteristics, and impedance values for EMI solutions. These ferrite formulas are used to compose seven types of EMI suppression chip beads: SB, GB, PB, UPB, NB, HF, and VPB series.

Product Identification

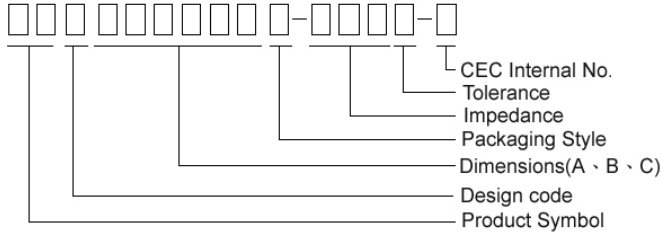

- Product symbol: SB, GB, PB, UPB, NB, HF, VPB
- Packaging: T : Tape and Reel ; B : Bulk
- Tolerance: Y = $\pm 25\%$; M = $\pm 20\%$; T: $\pm 30\%$
- Note: RoHS Compliant

Shape and Dimensions

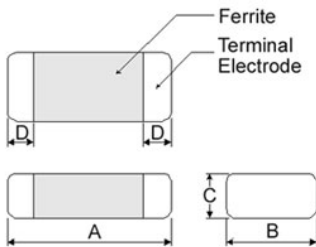

Dimensions in mm

TYPE	A	B	C	D
①060303	0.6 \pm 0.03	0.30 \pm 0.03	0.3 \pm 0.03	0.15 \pm 0.05
②100505	1.0 \pm 0.10	0.50 \pm 0.10	0.5 \pm 0.10	0.25 \pm 0.10
③160808	1.6 \pm 0.15	0.80 \pm 0.15	0.8 \pm 0.15	0.3 \pm 0.2
④201209	2.0 \pm 0.20	1.25 \pm 0.20	0.9 \pm 0.20	0.5 \pm 0.3
⑤201212	2.0 \pm 0.20	1.25 \pm 0.20	1.25 \pm 0.20	0.5 \pm 0.3
④321611	3.2 \pm 0.20	1.60 \pm 0.20	1.1 \pm 0.20	0.5 \pm 0.3
⑥321616	3.2 \pm 0.20	1.60 \pm 0.20	1.6 \pm 0.20	0.5 \pm 0.3
⑦322513	3.2 \pm 0.20	2.50 \pm 0.20	1.3 \pm 0.20	0.5 \pm 0.3
⑧451616	4.5 \pm 0.25	1.60 \pm 0.20	1.6 \pm 0.20	0.5 \pm 0.3
⑧453215	4.5 \pm 0.25	3.20 \pm 0.20	1.5 \pm 0.20	0.5 \pm 0.3

- ① : SB / PB / NB ② : SB / PB / NB / HF ⑦ : SB / PB
 ③ : SB / PB / NB / GB / UPB / HF / VPB ⑤ : UPB ⑥ : SB
 ④ : SB / PB / NB / GB / UPB ⑧ : PB / UPB

Recommended Pattern

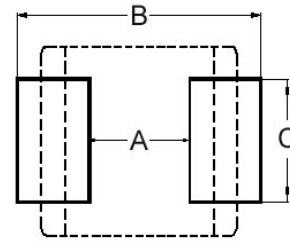

Dimensions in mm

TYPE	A	B	C
①060303	0.2 ~ 0.3	0.75 ~ 1.05	0.3
②100505	0.4	1.2 ~ 1.4	0.5
③160808	0.7 ~ 0.8	1.8 ~ 2.0	0.6 ~ 0.8
④201209	1.0 ~ 1.2	2.6 ~ 4.0	1.0 ~ 1.2
⑤201212	1.0 ~ 1.2	2.6 ~ 4.0	1.0 ~ 1.2
④321611	2.0	4.2 ~ 5.2	1.2
⑥321616	2.0	4.2 ~ 5.2	1.2
⑦322513	2.0	5.5 ~ 6.5	1.8
⑧451616	3.0	5.5 ~ 6.5	1.2
⑧453215	3.0	5.5 ~ 6.5	2.4

- * Don't apply narrower pattern than listed above to PB and UPB. Narrow pattern might cause excessive heat or open circuit.

Dimension Conversion

Code	Dimension in mm (AxBxC)	EIA
060303	0.6X0.3X0.3	0201
100505	1.0X0.5X0.5	0402
160808	1.6x0.8x0.8	0603
201209	2.0x1.2x0.9	0805
201212	2.0x1.2x1.25	0805
321611	3.2x1.6x1.1	1206
321616	3.2x1.6x1.6	1206
322513	3.2x2.5x1.3	1210
451616	4.5x1.6x1.6	1806
453215	4.5x3.2x1.5	1812

Electrical Characteristics

Part Number	Test Frequency (MHz)	Impedance ($\Omega \pm 25\%$)	DC Resistance (Ω) Max	Rated current (mA) Max
SBY060303T-100Y-N	100	10 \pm 30%	0.1	500
SBY060303T-600Y-N	100	60	0.4	200
SBY060303T-121Y-N	100	120	0.5	200
SBY060303T-241Y-N	100	240	0.8	200
SBY060303T-601Y-N	100	600	1.5	100

Test Instruments : Agilent E4991A Impedance / Material Analyzer

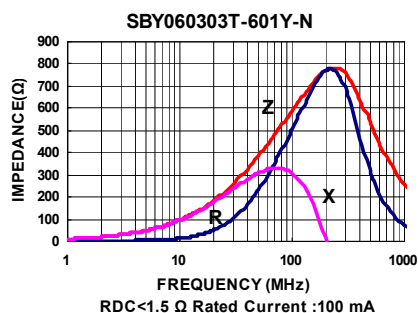
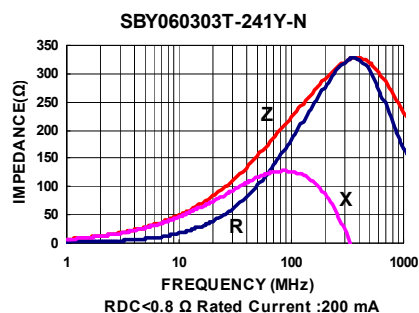
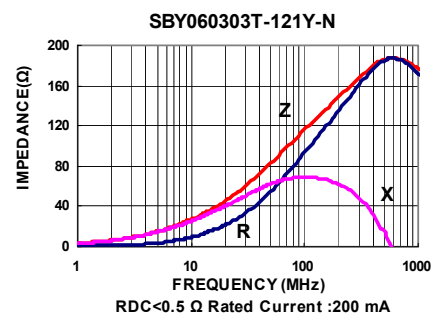
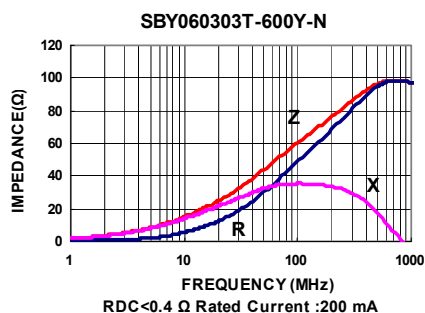
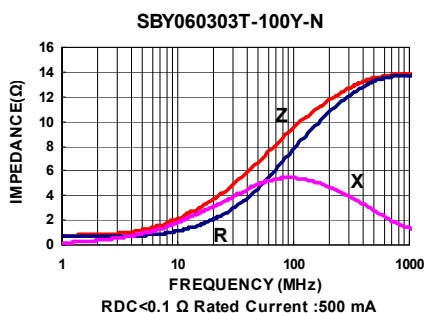

Electrical Characteristics

Part Number	Test Frequency (MHz)	Impedance ($\Omega \pm 25\%$)	DC Resistance (Ω) Max	Rated current (mA) Max
SBY100505T-100Y-N	100	10 \pm 30%	0.05	500
SBY100505T-400Y-N	100	40	0.20	500
SBY100505T-600Y-N	100	60	0.20	500
SBY100505T-700Y-N	100	70	0.20	500
SBY100505T-101Y-N	100	100	0.25	500
SBY100505T-121Y-N	100	120	0.25	500
SBY100505T-221Y-N	100	220	0.40	400
SBY100505T-301Y-N	100	300	0.50	300
SBY100505T-471Y-N	100	470	0.50	300
SBY100505T-601Y-N	100	600	0.60	300
SBY100505T-102Y-N	100	1000	0.95	200
SBY100505T-182Y-N	100	1800	1.40	100
SBY100505T-222Y-N	100	2200	1.40	100

Test Instruments : Agilent E4991A Impedance / Material Analyzer

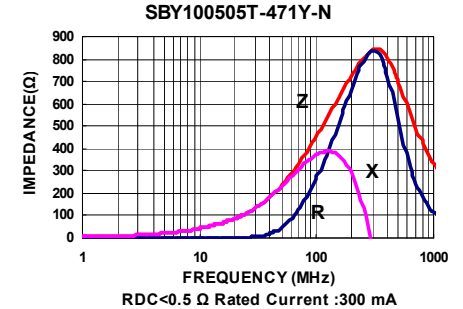
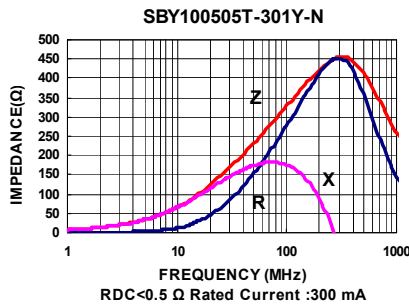
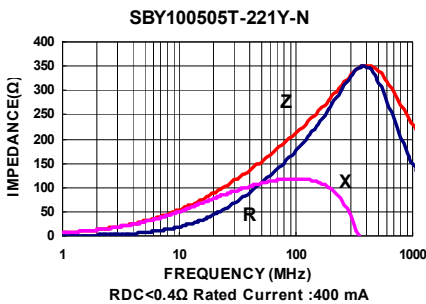
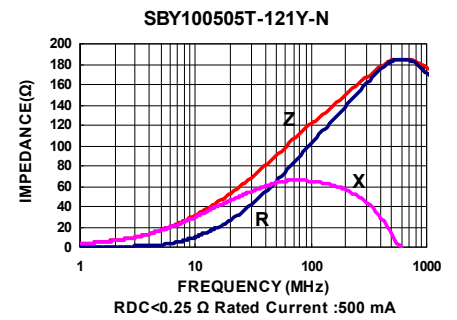
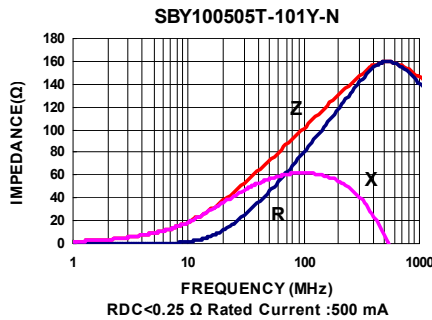
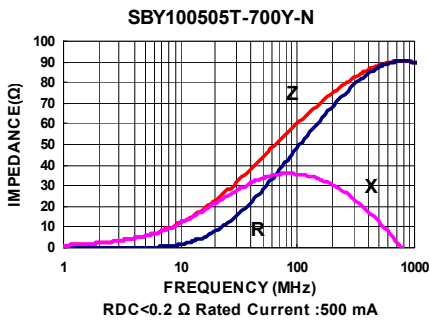
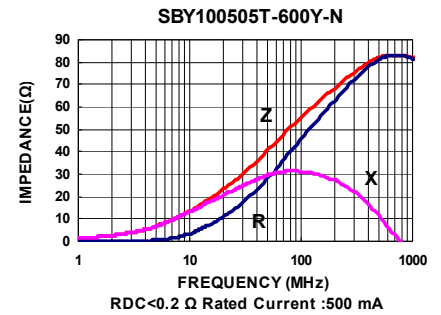
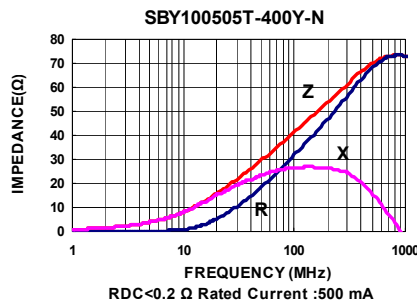
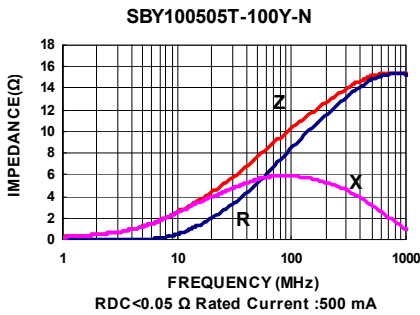

Test Instruments : Agilent E4991A Impedance / Material Analyzer

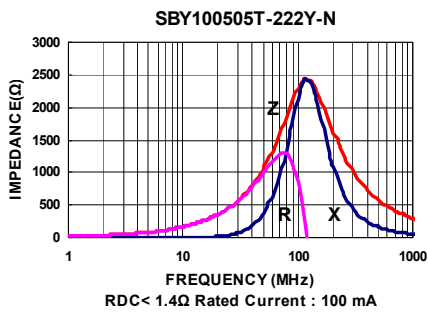
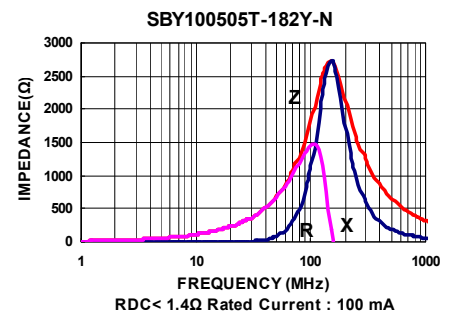
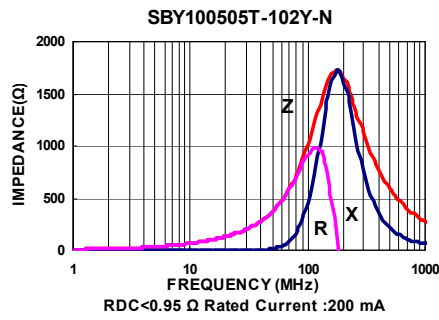
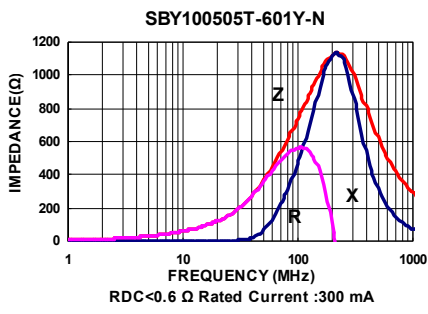

Electrical Characteristics

Part Number	Test Frequency (MHz)	Impedance ($\Omega \pm 25\%$)	DC Resistance (Ω) Max	Rated current (mA) Max
SBK160808T-110Y-N	100	11 \pm 30%	0.05	500
SBK160808T-300Y-N	100	30	0.10	400
SBK160808T-600Y-N	100	60	0.10	400
SBK160808T-800Y-N	100	80	0.15	400
SBK160808T-121Y-N	100	120	0.25	400
SBK160808T-221Y-N	100	220	0.30	300
SBK160808T-301Y-N	100	300	0.40	300
SBK160808T-471Y-N	100	470	0.50	300
SBK160808T-601Y-N	100	600	0.50	300
SBK160808T-751Y-N	100	750	0.60	300
SBK160808T-102Y-N	100	1000	0.60	300
SBK160808T-152Y-N	100	1500	0.60	300
SBK160808T-222Y-N	100	2200	0.80	200
SBK160808T-272Y-N	100	2700	0.80	200

Test Instruments : Agilent E4991A Impedance / Material Analyzer

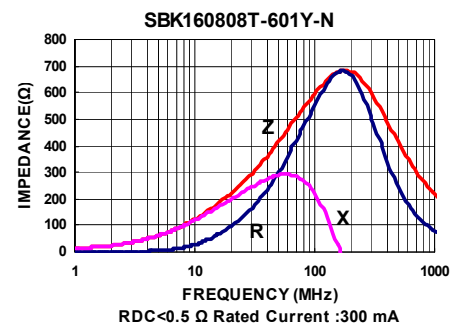
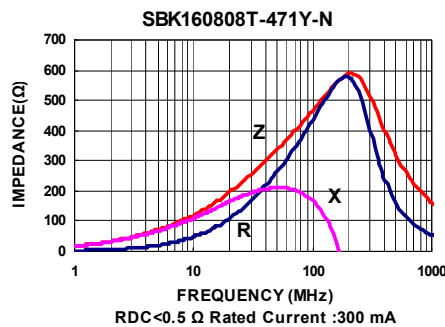
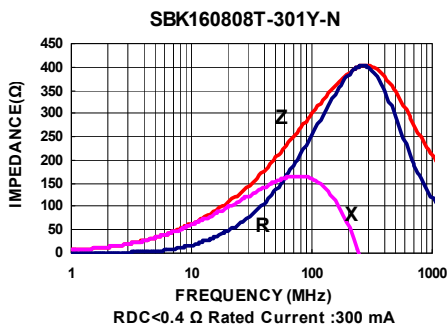
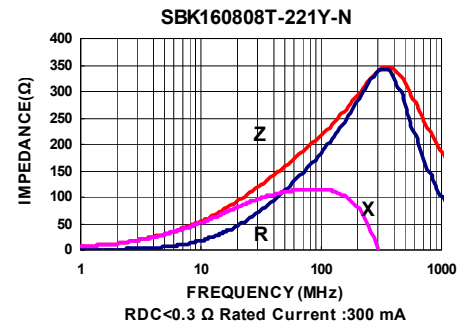
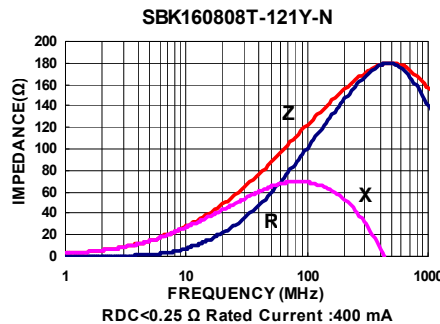
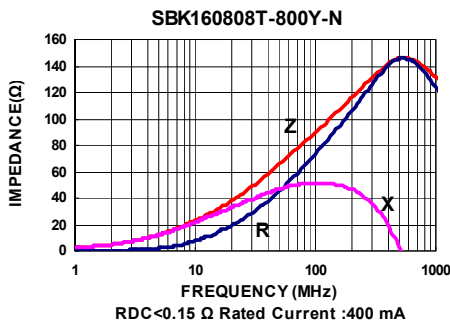
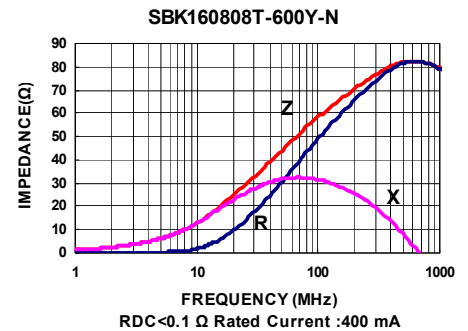
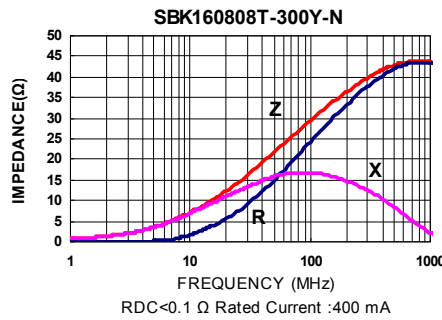
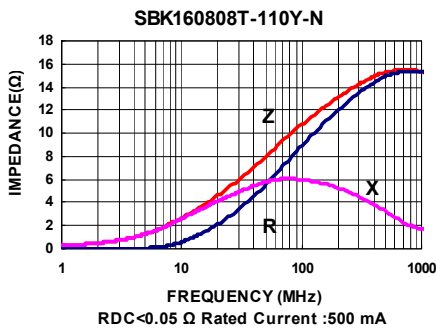

Test Instruments : Agilent E4991A Impedance / Material Analyzer

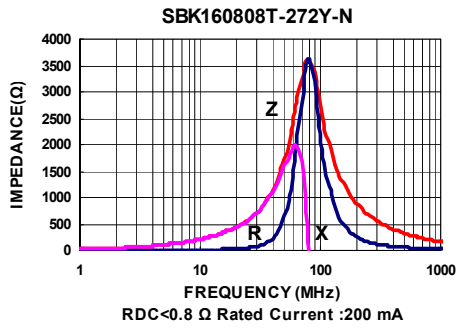
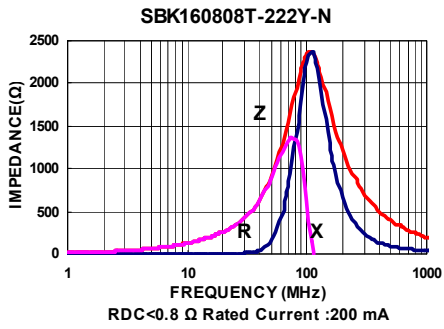
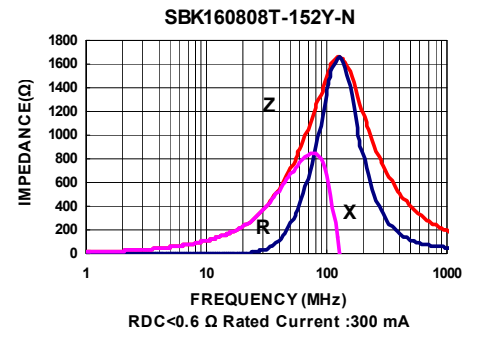
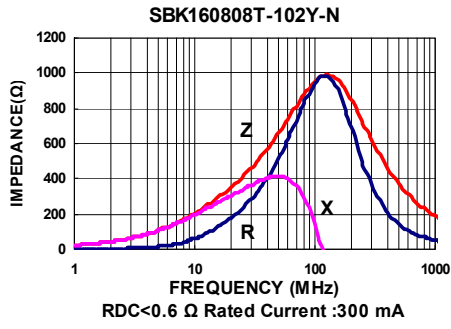
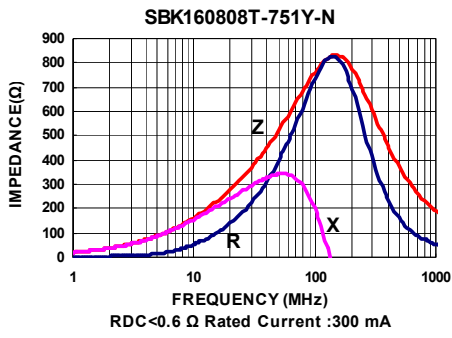

Electrical Characteristics

Part Number	Test Frequency (MHz)	Impedance ($\Omega \pm 25\%$)	DC Resistance (Ω) Max	Rated current (mA) Max
SBY201209T-110Y-N	100	11 \pm 30%	0.10	600
SBY201209T-320Y-N	100	32	0.10	600
SBK201209T-600Y-N	100	60	0.15	500
SBK201209T-121Y-N	100	120	0.25	300
SBK201209T-151Y-N	100	150	0.25	300
SBK201209T-221Y-N	100	220	0.30	300
SBK201209T-301Y-N	100	300	0.30	300
SBK201209T-471Y-N	100	470	0.30	300
SBK201209T-601Y-N	100	600	0.40	300
SBK201209T-751Y-N	100	750	0.50	200
SBK201209T-102Y-N	100	1000	0.50	200
SBK201209T-152Y-N	100	1500	0.60	200
SBK201209T-202Y-N	100	2000	0.70	200
SBK201209T-222Y-N	100	2200	0.70	200
SBK201209T-252Y-N	100	2500	0.70	200
SBK201209T-272Y-N	100	2700	0.70	200

Test Instruments : Agilent E4991A Impedance / Material Analyzer

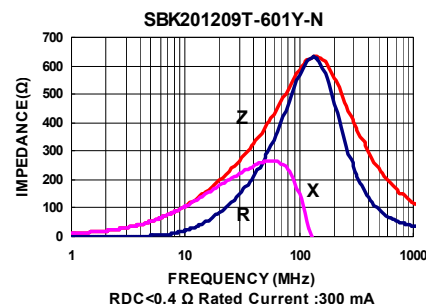
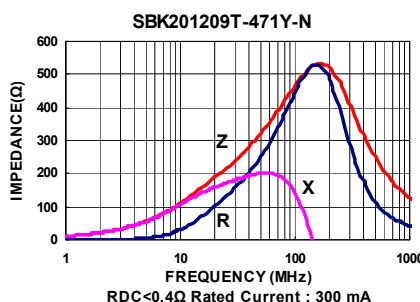
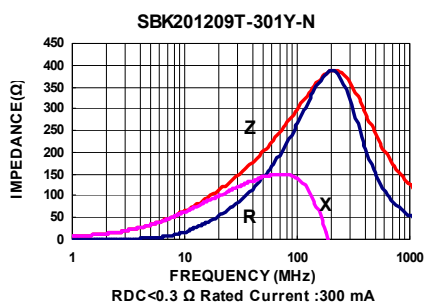
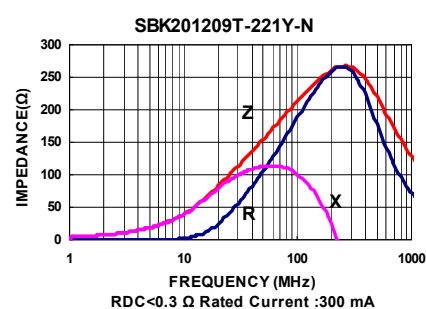
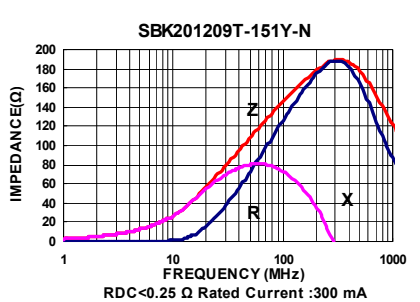
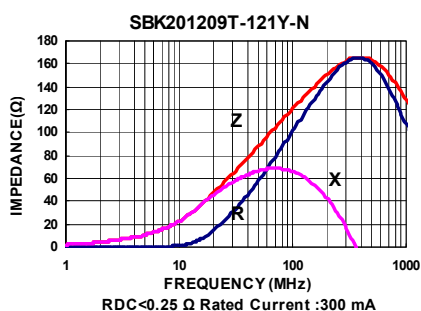
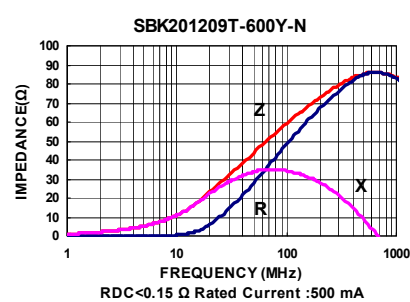
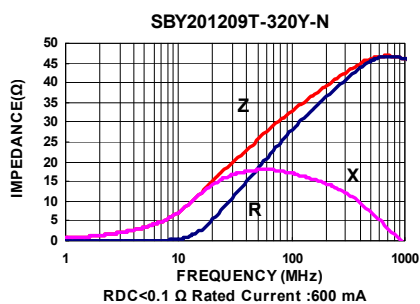
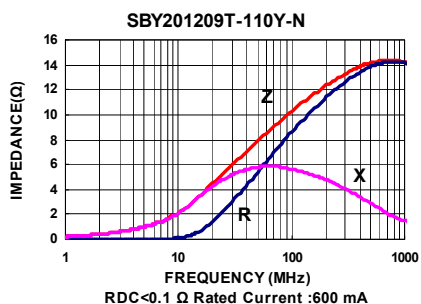

Test Instruments : Agilent E4991A Impedance / Material Analyzer

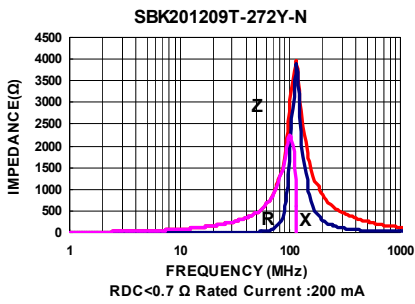
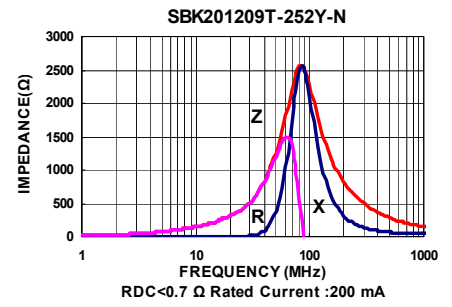
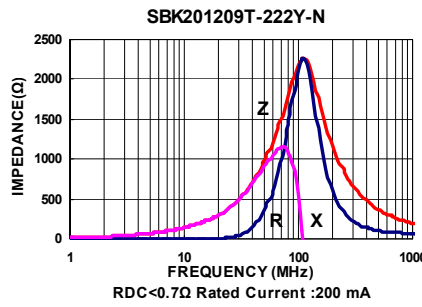
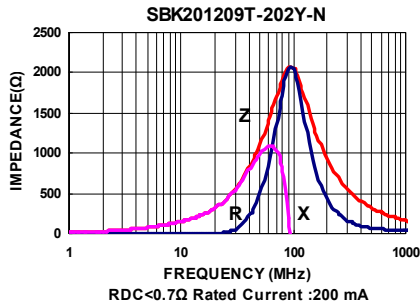
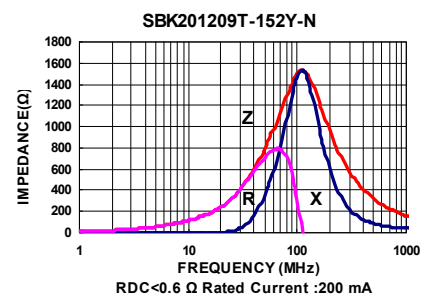
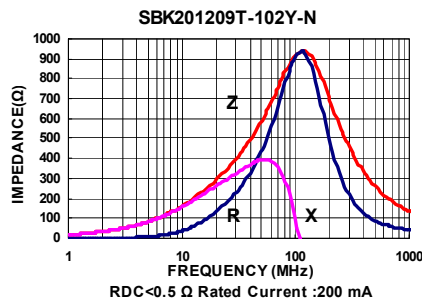
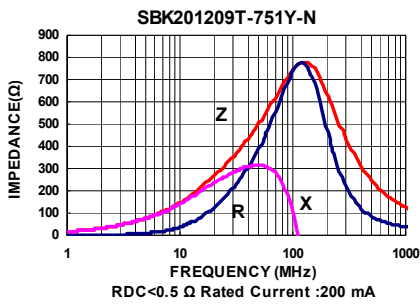

Electrical Characteristics

Part Number	Test Frequency (MHz)	Impedance ($\Omega \pm 25\%$)	DC Resistance (Ω) Max	Rated current (mA) Max
SBY321611T-110Y-N	100	11 \pm 30%	0.05	600
SBY321611T-320Y-N	100	32	0.05	600
SBY321611T-600Y-N	100	60	0.10	500
SBK321611T-900Y-N	100	90	0.15	500
SBK321611T-121Y-N	100	120	0.15	500
SBK321611T-151Y-N	100	150	0.15	500
SBK321611T-471Y-N	100	470	0.20	400
SBK321611T-601Y-N	100	600	0.30	400
SBK321611T-102Y-N	50	1000	0.40	200
SBK321611T-122Y-N	50	1200	0.40	200
SBK321611T-152Y-N	50	1500	0.45	200

Test Instruments : Agilent E4991A Impedance / Material Analyzer

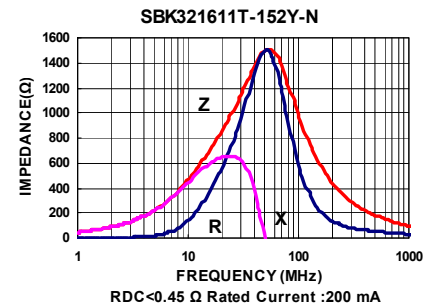
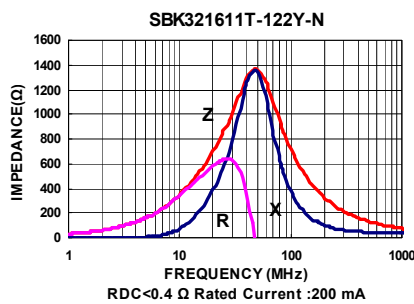
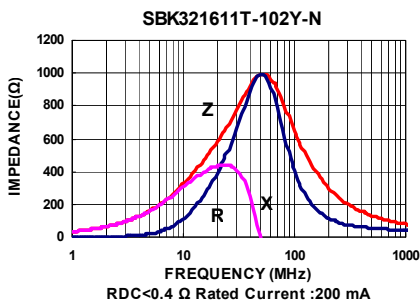
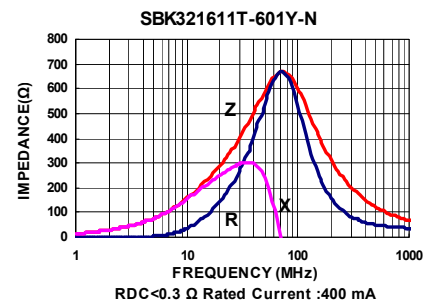
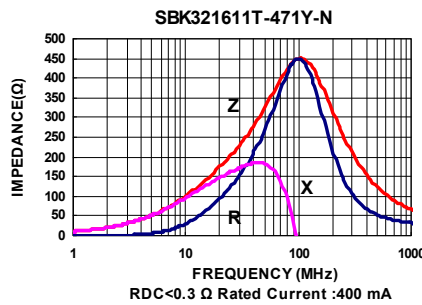
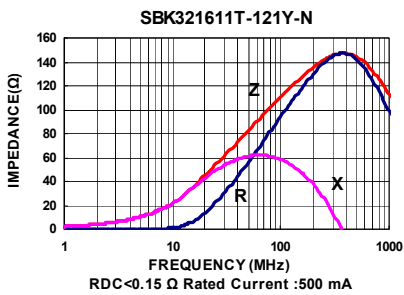
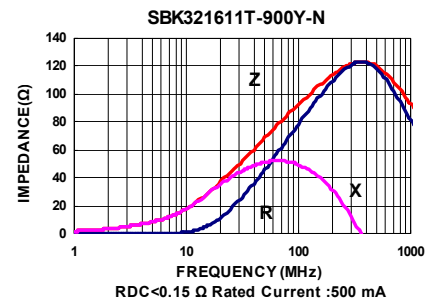
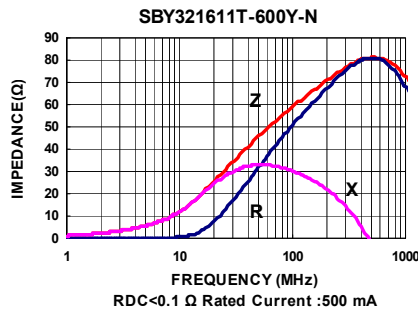
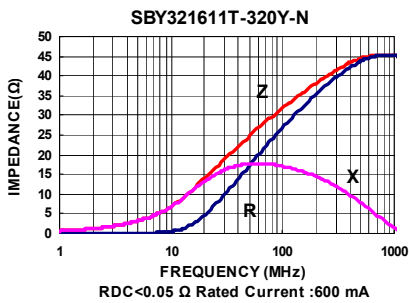

Packaging Specifications

Tape Dimensions

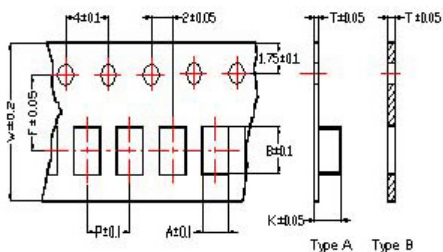

Tape Material

Carrier Tape: Polycarbonate (Tape A)
 Carrier Tape: Paper (Tape B)
 Cover Tape: Polystyrene

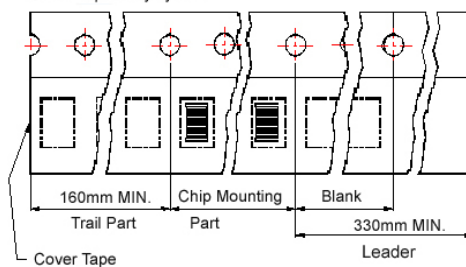

Reel Dimensions

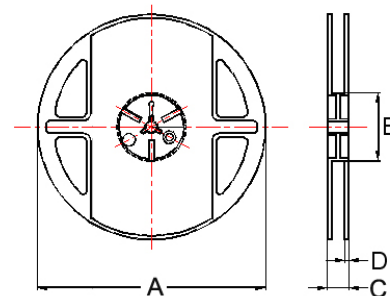

- ① : SB / PB / NB ② : SB / PB / NB / HF ③ : SB / PB
- ④ : SB / PB / NB / GB / UPB / HF / VPB ⑤ : UPB
- ⑥ : SB / PB / NB / GB / UPB ⑦ : SB ⑧ : PB / UPB

Dimensions in mm

TYPE	Tape Dimensions								Reel Dimensions				Quantity PCS / REEL
	A	B	T	W	P	F	K	Tape	A	B	C	D	
①060303	0.37	0.67	0.42	8.0	2.0	3.5	-	B	178	60	10	2	15000
②100505	0.65	1.15	0.60	8.0	2.0	3.5	-	B	178	60	12	2	10000
③160808	1.05	1.85	0.95	8.0	4.0	3.5	-	B	178	60	12	2	4000
④201209	1.50	2.30	0.97	8.0	4.0	3.5	-	B	178	60	12	2	4000
⑤201212	1.35	2.25	0.22	8.0	4.0	3.5	1.35	A	178	60	12	2	3000
④321611	1.88	3.50	0.22	8.0	4.0	3.5	1.27	A	178	60	12	2	3000
⑥321616	1.88	3.53	0.22	8.0	4.0	3.5	1.80	A	178	60	12	2	2000
⑦322513	2.77	3.42	0.22	8.0	4.0	3.5	1.55	A	178	60	12	2	2500
⑧451616	1.93	4.95	0.24	12	4.0	5.5	1.93	A	178	60	14	2	2000
⑨453215	3.66	4.95	0.24	12	8.0	5.5	1.85	A	178	60	14	2	1000

Multilayer Ferrite Chip Beads



Chilisin offers a wide range of multi-layered ferrite chip beads with various sizes, frequency characteristics, and impedance values for EMI solutions. These ferrite formulas are used to compose seven types of EMI suppression chip beads: SB, GB, PB, UPB, NB, HF, and HP series.

Product Identification

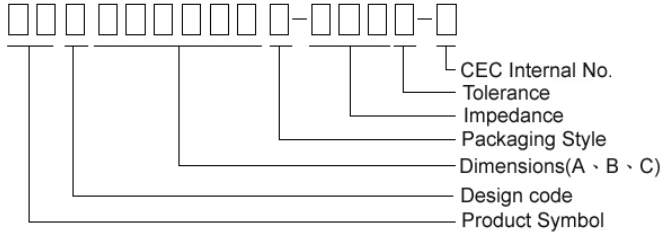

- Product symbol: SB, GB, PB, UPB, NB, HF, HP
- Packaging: T : Tape and Reel ; B : Bulk
- Tolerance: Y = $\pm 25\%$; M = $\pm 20\%$; T: $\pm 30\%$
- Note: RoHS Compliant

Shape and Dimensions

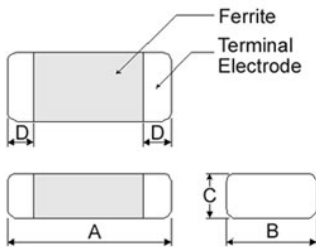

Dimensions in mm

TYPE	A	B	C	D
①060303	0.6 \pm 0.03	0.30 \pm 0.03	0.3 \pm 0.03	0.15 \pm 0.05
②100505	1.0 \pm 0.10	0.50 \pm 0.10	0.5 \pm 0.10	0.25 \pm 0.10
③160808	1.6 \pm 0.15	0.80 \pm 0.15	0.8 \pm 0.15	0.3 \pm 0.2
④201209	2.0 \pm 0.20	1.25 \pm 0.20	0.9 \pm 0.20	0.5 \pm 0.3
⑤201212	2.0 \pm 0.20	1.25 \pm 0.20	1.25 \pm 0.20	0.5 \pm 0.3
④321611	3.2 \pm 0.20	1.60 \pm 0.20	1.1 \pm 0.20	0.5 \pm 0.3
⑥321616	3.2 \pm 0.20	1.60 \pm 0.20	1.6 \pm 0.20	0.5 \pm 0.3
⑦322513	3.2 \pm 0.20	2.50 \pm 0.20	1.3 \pm 0.20	0.5 \pm 0.3
⑧451616	4.5 \pm 0.25	1.60 \pm 0.20	1.6 \pm 0.20	0.5 \pm 0.3
⑧453215	4.5 \pm 0.25	3.20 \pm 0.20	1.5 \pm 0.20	0.5 \pm 0.3

- ① : SB / PB / NB ② : SB / PB / NB / HF ⑦ : SB / PB
 ③ : SB / PB / NB / GB / UPB / HF / HP ⑤ : UPB ⑥ : SB
 ④ : SB / PB / NB / GB / UPB ⑧ : PB / UPB

Recommended Pattern

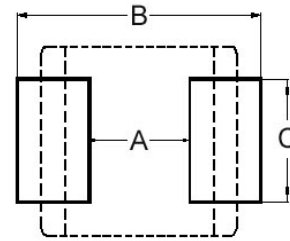

Dimensions in mm

TYPE	A	B	C
①060303	0.2 ~ 0.3	0.75 ~ 1.05	0.3
②100505	0.4	1.2 ~ 1.4	0.5
③160808	0.7 ~ 0.8	1.8 ~ 2.0	0.6 ~ 0.8
④201209	1.0 ~ 1.2	2.6 ~ 4.0	1.0 ~ 1.2
⑤201212	1.0 ~ 1.2	2.6 ~ 4.0	1.0 ~ 1.2
④321611	2.0	4.2 ~ 5.2	1.2
⑥321616	2.0	4.2 ~ 5.2	1.2
⑦322513	2.0	5.5 ~ 6.5	1.8
⑧451616	3.0	5.5 ~ 6.5	1.2
⑧453215	3.0	5.5 ~ 6.5	2.4

* Don't apply narrower pattern than listed above to PB and UPB. Narrow pattern might cause excessive heat or open circuit.

Dimension Conversion

Code	Dimension in mm (AxBxC)	EIA
060303	0.6X0.3X0.3	0201
100505	1.0X0.5X0.5	0402
160808	1.6x0.8x0.8	0603
201209	2.0x1.2x0.9	0805
201212	2.0x1.2x1.25	0805
321611	3.2x1.6x1.1	1206
321616	3.2x1.6x1.6	1206
322513	3.2x2.5x1.3	1210
451616	4.5x1.6x1.6	1806
453215	4.5x3.2x1.5	1812

Electrical Characteristics

Part Number	Test Frequency (MHz)	Impedance ($\Omega \pm 25\%$)	DC Resistance (Ω) Max	Rated current (mA) Max
SBJ060303T-600Y-N	100	60	0.3	200
SBJ060303T-750Y-N	100	75	0.4	300
SBJ060303T-121Y-N	100	120	0.5	250
SBJ060303T-241Y-N	100	240	1.0	220

Test Instruments : Agilent E4991A Impedance / Material Analyzer

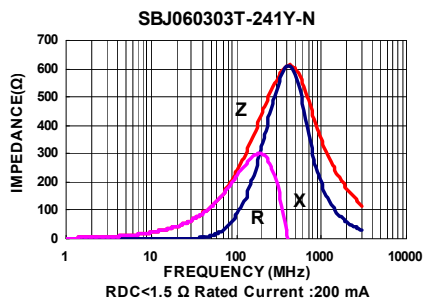
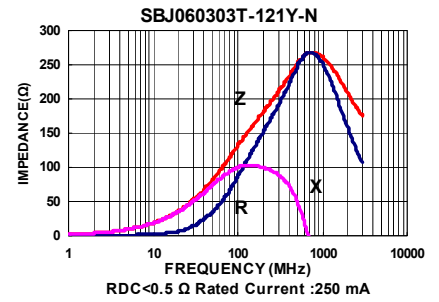
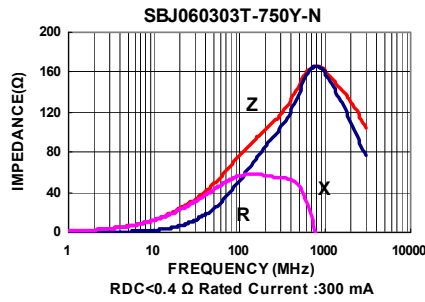
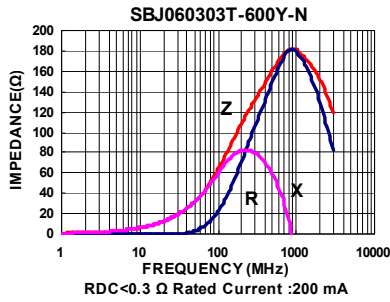

Electrical Characteristics

Part Number	Test Frequency (MHz)	Impedance ($\Omega \pm 25\%$)	DC Resistance (Ω) Max	Rated current (mA) Max
SBJ100505T-100Y-N	100	10 \pm 30%	0.05	500
SBJ100505T-300Y-N	100	30	0.20	500
SBJ100505T-600Y-N	100	60	0.20	500
SBJ100505T-121Y-N	100	120	0.25	500
SBJ100505T-221Y-N	100	220	0.40	400
SBJ100505T-301Y-N	100	300	0.50	300
SBJ100505T-481Y-N	100	480	0.50	300
SBJ100505T-601Y-N	100	600	0.60	300
SBJ100505T-102Y-N	100	1000	0.95	200
SBJ100505T-152Y-N	100	1500	1.15	100
SBJ100505T-182Y-N	100	1800	1.40	100
SBJ100505T-252Y-N	100	2500	1.80	100

Test Instruments : Agilent E4991A Impedance / Material Analyzer

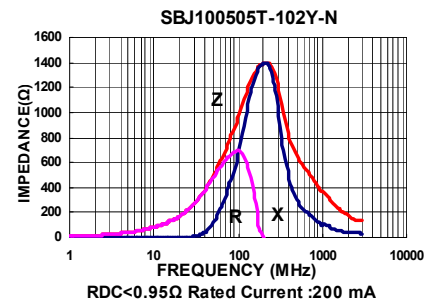
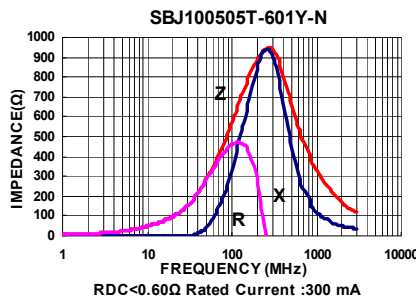
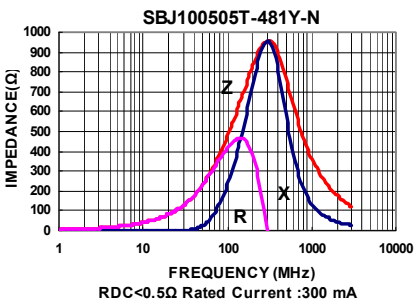
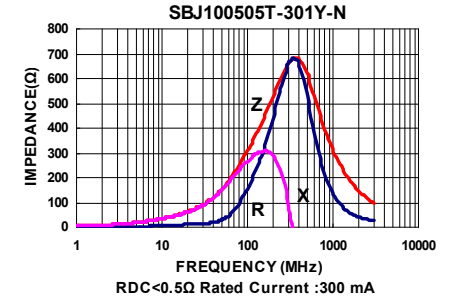
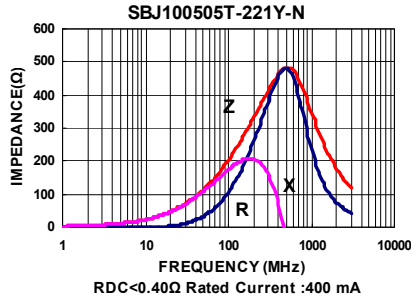
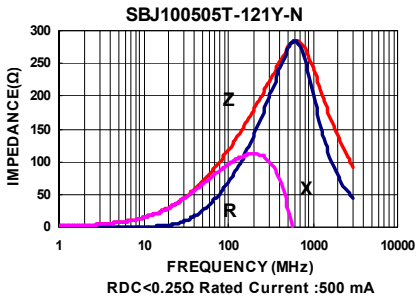
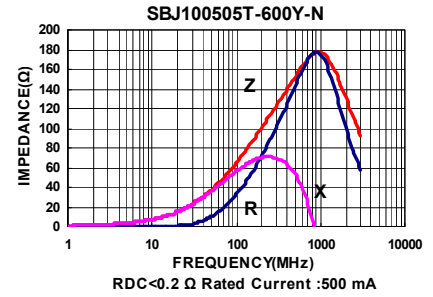
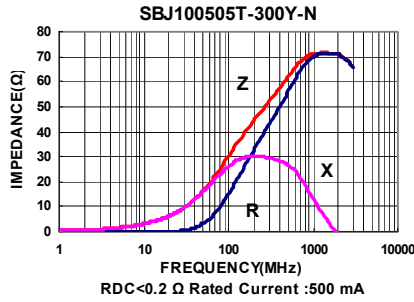
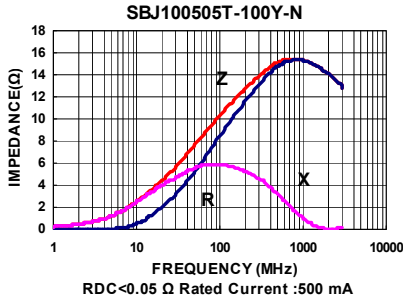

Test Instruments : Agilent E4991A Impedance / Material Analyzer

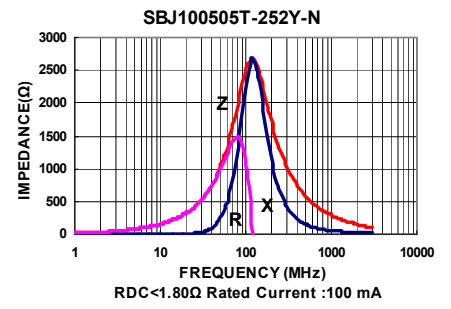
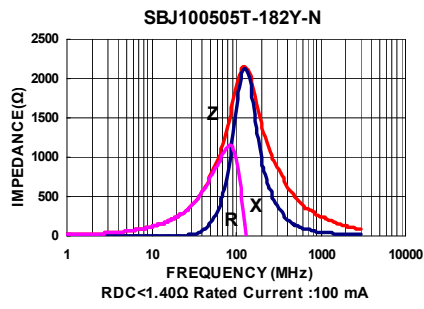
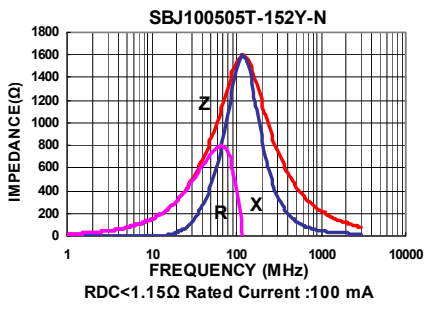

Electrical Characteristics

Part Number	Test Frequency (MHz)	Impedance ($\Omega \pm 25\%$)	DC Resistance (Ω) Max	Rated current (mA) Max
SBJ160808T-110Y-N	100	11 \pm 30%	0.05	500
SBJ160808T-320Y-N	100	32	0.10	400
SBJ160808T-600Y-N	100	60	0.10	400
SBJ160808T-121Y-N	100	120	0.25	400
SBJ160808T-221Y-N	100	220	0.30	400
SBJ160808T-301Y-N	100	300	0.40	400
SBJ160808T-471Y-N	100	470	0.40	400
SBJ160808T-601Y-N	100	600	0.40	400
SBJ160808T-102Y-N	100	1000	0.60	300
SBJ160808T-152Y-N	100	1500	0.80	200
SBJ160808T-182Y-N	100	1800	1.0	200
SBJ160808T-202Y-N	100	2000	1.0	200
SBJ160808T-222Y-N	100	2200	1.0	200
SBJ160808T-252Y-N	100	2500	1.0	200
SBJ160808T-272Y-N	100	2700	1.0	200

Test Instruments : Agilent E4991A Impedance / Material Analyzer

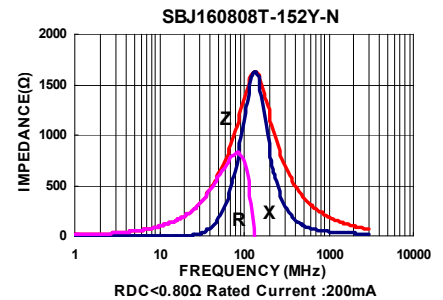
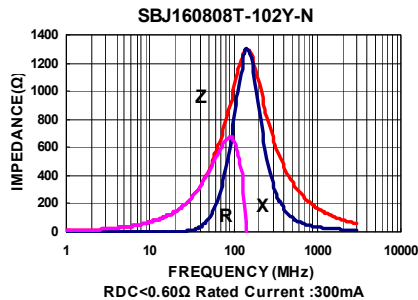
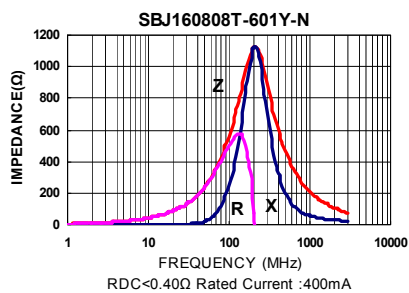
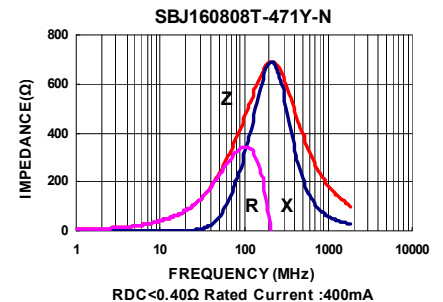
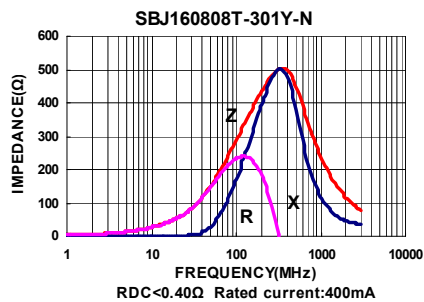
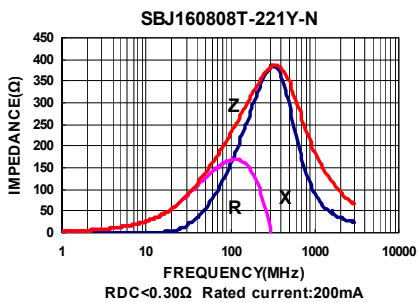
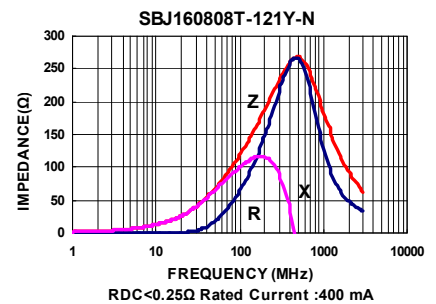
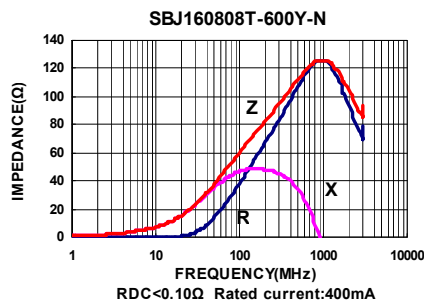
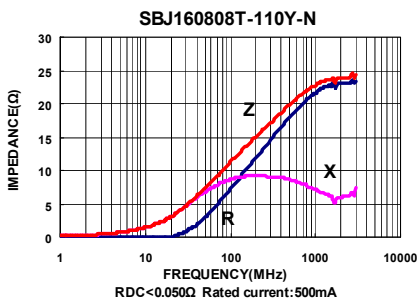

Test Instruments : Agilent E4991A Impedance / Material Analyzer

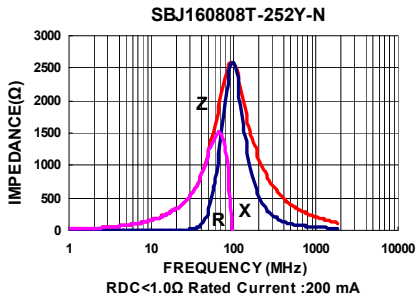
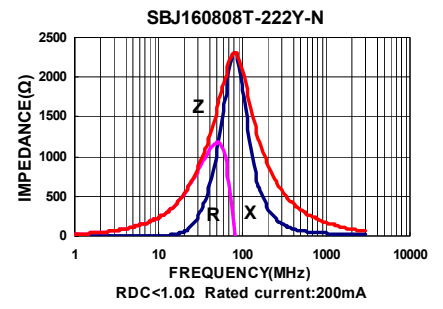
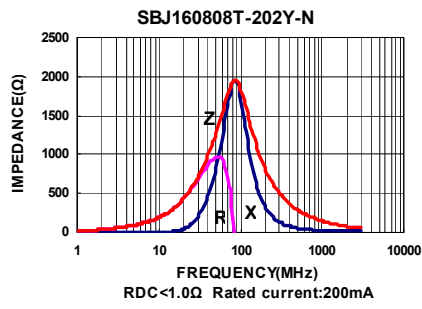
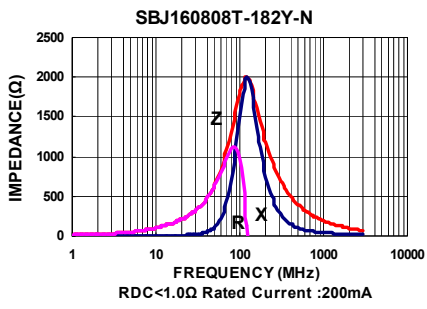

Packaging Specifications

Tape Dimensions

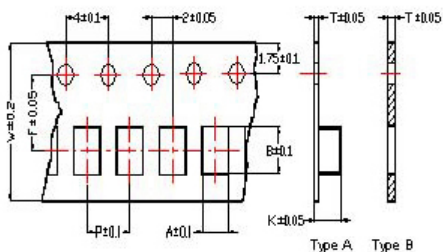

Tape Material

Carrier Tape: Polycarbonate (Tape A)
 Carrier Tape: Paper (Tape B)
 Cover Tape: Polystyrene

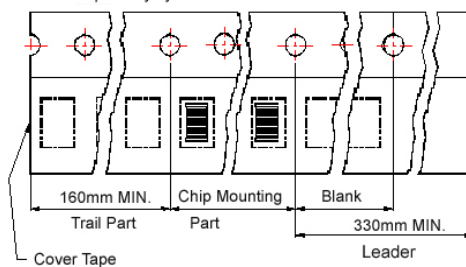

Reel Dimensions

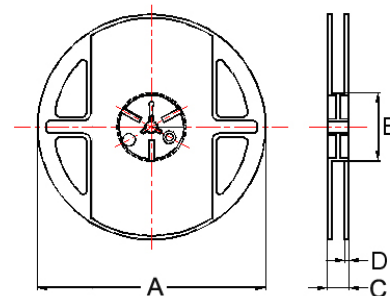

- ① : SB / PB / NB ② : SB / PB / NB / HF ③ : SB / PB
- ④ : SB / PB / NB / GB / UPB / HF / VPB ⑤ : UPB
- ⑥ : SB / PB / NB / GB / UPB ⑦ : SB ⑧ : PB / UPB

Dimensions in mm

TYPE	Tape Dimensions								Reel Dimensions				Quantity PCS / REEL
	A	B	T	W	P	F	K	Tape	A	B	C	D	
①060303	0.37	0.67	0.42	8.0	2.0	3.5	-	B	178	60	10	2	15000
②100505	0.65	1.15	0.60	8.0	2.0	3.5	-	B	178	60	12	2	10000
③160808	1.05	1.85	0.95	8.0	4.0	3.5	-	B	178	60	12	2	4000
④201209	1.50	2.30	0.97	8.0	4.0	3.5	-	B	178	60	12	2	4000
⑤201212	1.35	2.25	0.22	8.0	4.0	3.5	1.35	A	178	60	12	2	3000
④321611	1.88	3.50	0.22	8.0	4.0	3.5	1.27	A	178	60	12	2	3000
⑥321616	1.88	3.53	0.22	8.0	4.0	3.5	1.80	A	178	60	12	2	2000
⑦322513	2.77	3.42	0.22	8.0	4.0	3.5	1.55	A	178	60	12	2	2500
⑧451616	1.93	4.95	0.24	12	4.0	5.5	1.93	A	178	60	14	2	2000
⑨453215	3.66	4.95	0.24	12	8.0	5.5	1.85	A	178	60	14	2	1000

Multilayer Ferrite Chip Beads



Chilisin offers a wide range of multi-layered ferrite chip beads with various sizes, frequency characteristics, and impedance values for EMI solutions. These ferrite formulas are used to compose seven types of EMI suppression chip beads: SB, GB, PB, UPB, NB, HF, and HP series.

Product Identification

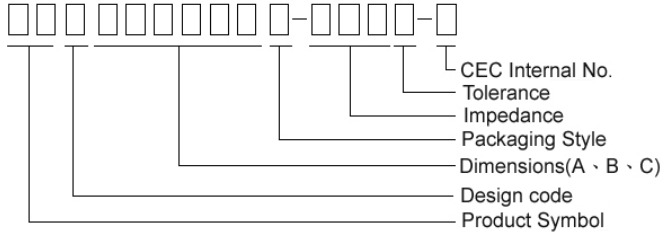

- Product symbol: SB, GB, PB, UPB, NB, HF, HP
- Packaging: T : Tape and Reel ; B : Bulk
- Tolerance: Y = $\pm 25\%$; M = $\pm 20\%$; T: $\pm 30\%$
- Note: RoHS Compliant

Shape and Dimensions

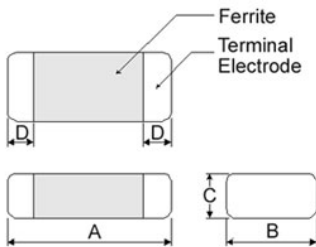

Dimensions in mm

TYPE	A	B	C	D
①060303	0.6 \pm 0.03	0.30 \pm 0.03	0.3 \pm 0.03	0.15 \pm 0.05
②100505	1.0 \pm 0.10	0.50 \pm 0.10	0.5 \pm 0.10	0.25 \pm 0.10
③160808	1.6 \pm 0.15	0.80 \pm 0.15	0.8 \pm 0.15	0.3 \pm 0.2
④201209	2.0 \pm 0.20	1.25 \pm 0.20	0.9 \pm 0.20	0.5 \pm 0.3
⑤201212	2.0 \pm 0.20	1.25 \pm 0.20	1.25 \pm 0.20	0.5 \pm 0.3
④321611	3.2 \pm 0.20	1.60 \pm 0.20	1.1 \pm 0.20	0.5 \pm 0.3
⑥321616	3.2 \pm 0.20	1.60 \pm 0.20	1.6 \pm 0.20	0.5 \pm 0.3
⑦322513	3.2 \pm 0.20	2.50 \pm 0.20	1.3 \pm 0.20	0.5 \pm 0.3
⑧451616	4.5 \pm 0.25	1.60 \pm 0.20	1.6 \pm 0.20	0.5 \pm 0.3
⑧453215	4.5 \pm 0.25	3.20 \pm 0.20	1.5 \pm 0.20	0.5 \pm 0.3

- ① : SB / PB / NB ② : SB / PB / NB / HF ⑦ : SB / PB
 ③ : SB / PB / NB / GB / UPB / HF / HP ⑤ : UPB ⑥ : SB
 ④ : SB / PB / NB / GB / UPB ⑧ : PB / UPB

Recommended Pattern

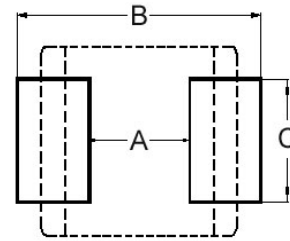

Dimensions in mm

TYPE	A	B	C
①060303	0.2 ~ 0.3	0.75 ~ 1.05	0.3
②100505	0.4	1.2 ~ 1.4	0.5
③160808	0.7 ~ 0.8	1.8 ~ 2.0	0.6 ~ 0.8
④201209	1.0 ~ 1.2	2.6 ~ 4.0	1.0 ~ 1.2
⑤201212	1.0 ~ 1.2	2.6 ~ 4.0	1.0 ~ 1.2
④321611	2.0	4.2 ~ 5.2	1.2
⑥321616	2.0	4.2 ~ 5.2	1.2
⑦322513	2.0	5.5 ~ 6.5	1.8
⑧451616	3.0	5.5 ~ 6.5	1.2
⑧453215	3.0	5.5 ~ 6.5	2.4

- * Don't apply narrower pattern than listed above to PB and UPB. Narrow pattern might cause excessive heat or open circuit.

Dimension Conversion

Code	Dimension in mm (AxBxC)	EIA
060303	0.6X0.3X0.3	0201
100505	1.0X0.5X0.5	0402
160808	1.6x0.8x0.8	0603
201209	2.0x1.2x0.9	0805
201212	2.0x1.2x1.25	0805
321611	3.2x1.6x1.1	1206
321616	3.2x1.6x1.6	1206
322513	3.2x2.5x1.3	1210
451616	4.5x1.6x1.6	1806
453215	4.5x3.2x1.5	1812

Electrical Characteristics

Part Number	Test Frequency (MHz)	Impedance ($\Omega \pm 25\%$)	DC Resistance (Ω) Max	Rated current (mA) Max
GBK160808T-100Y-N	100	10 \pm 30%	0.03	1000
GBK160808T-300Y-N	100	30	0.06	800
GBK160808T-600Y-N	100	60	0.06	700
GBK160808T-101Y-N	100	100	0.15	600
GBK160808T-121Y-N	100	120	0.15	600
GBK160808T-221Y-N	100	220	0.18	550
GBK160808T-301Y-N	100	300	0.25	500
GBK160808T-451Y-N	100	450	0.30	400
GBK160808T-601Y-N	100	600	0.30	400
GBK160808T-102Y-N	100	1000	0.45	300
GBK160808T-152Y-N	100	1500	0.70	150

Test Instruments : Agilent E4991A Impedance / Material Analyzer

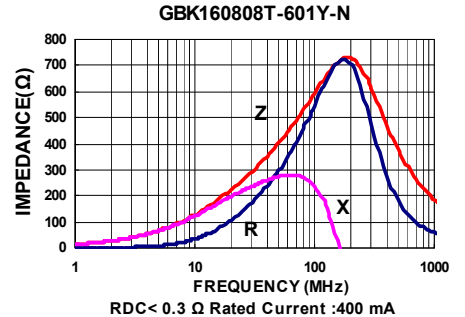
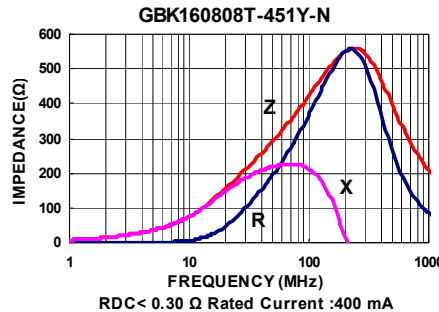
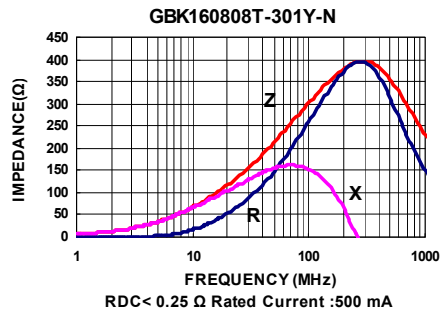
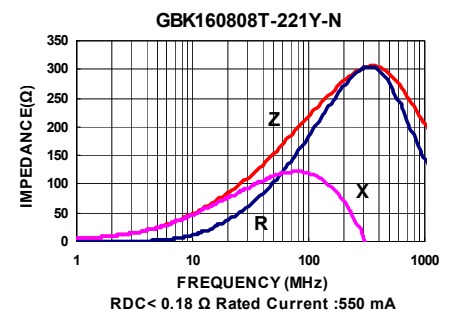
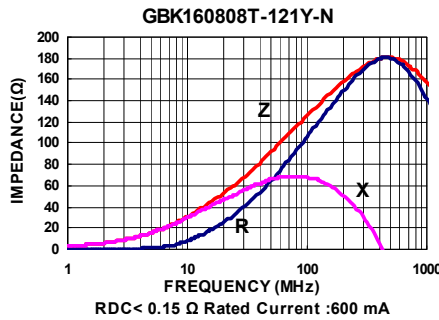
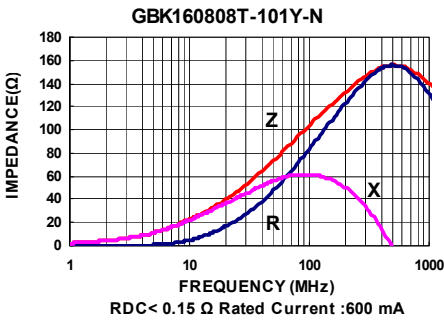
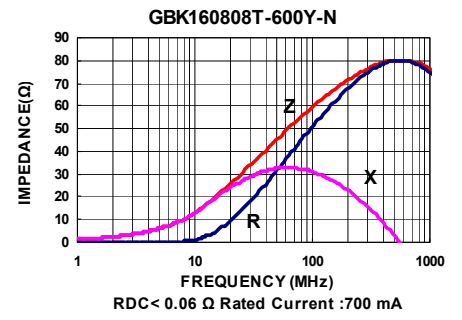
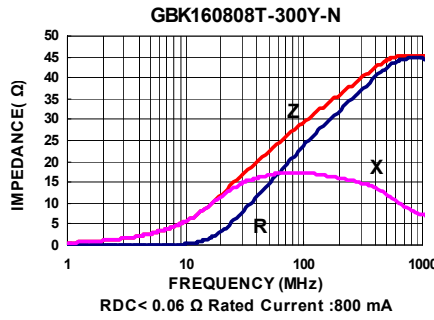
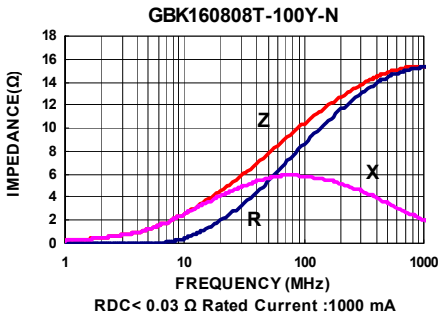

Test Instruments : Agilent E4991A Impedance / Material Analyzer

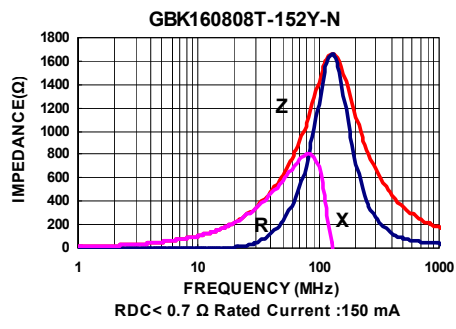
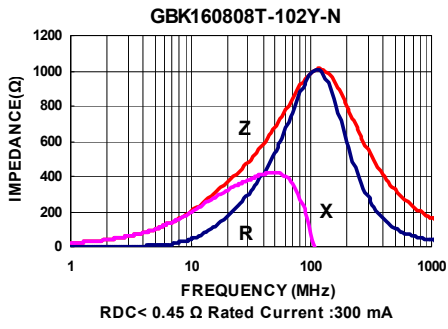

Electrical Characteristics

Part Number	Test Frequency (MHz)	Impedance ($\Omega \pm 25\%$)	DC Resistance (Ω) Max	Rated current (mA) Max
GBY201209T-110Y-N	100	11 \pm 30%	0.06	1000
GBY201209T-320Y-N	100	32	0.06	1000
GBK201209T-600Y-N	100	60	0.10	900
GBK201209T-121Y-N	100	120	0.15	800
GBK201209T-151Y-N	100	150	0.15	800
GBK201209T-221Y-N	100	220	0.18	750
GBK201209T-301Y-N	100	300	0.18	700
GBK201209T-401Y-N	100	400	0.18	600
GBK201209T-601Y-N	100	600	0.25	500
GBK201209T-102Y-N	100	1000	0.30	400
GBK201209T-152Y-N	100	1500	0.40	400
GBK201209T-202Y-N	100	2000	0.55	400

Test Instruments : Agilent E4991A Impedance / Material Analyzer

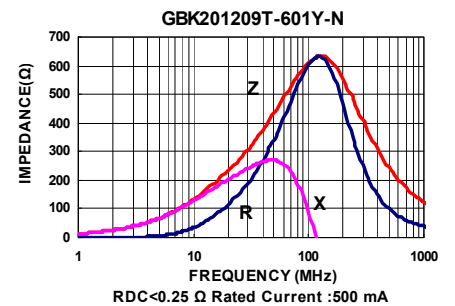
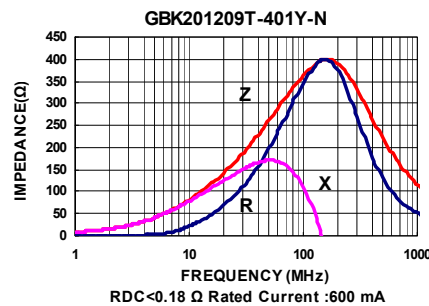
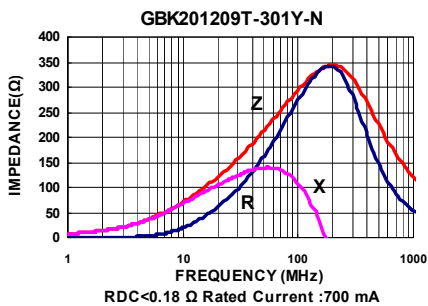
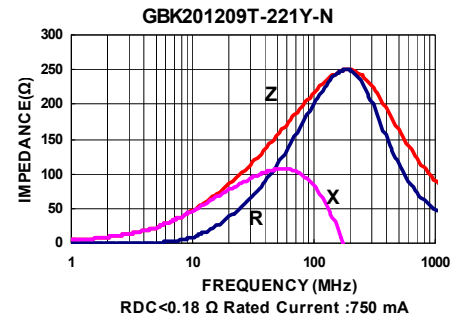
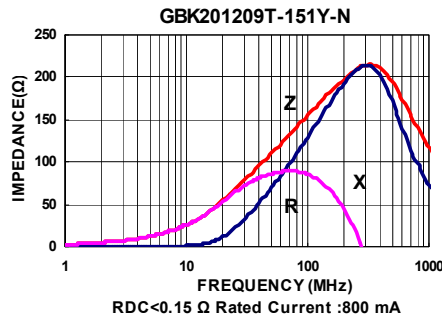
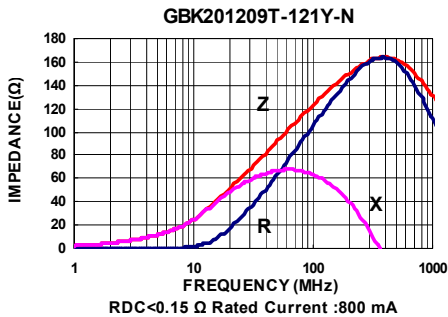
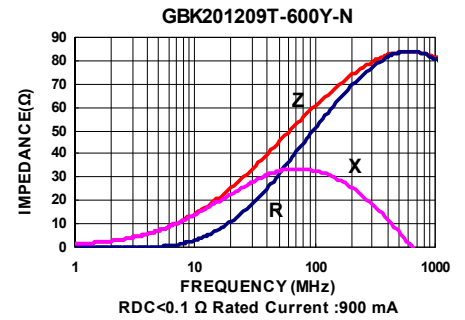
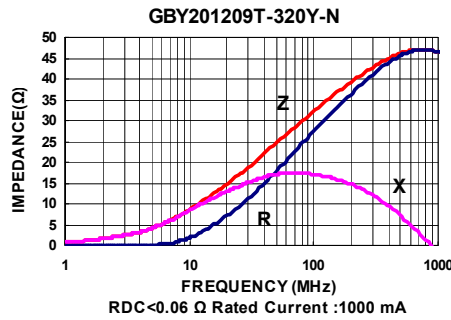
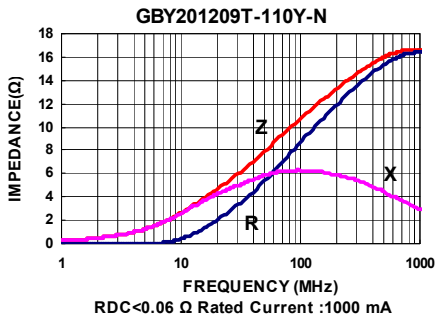

Test Instruments : Agilent E4991A Impedance / Material Analyzer

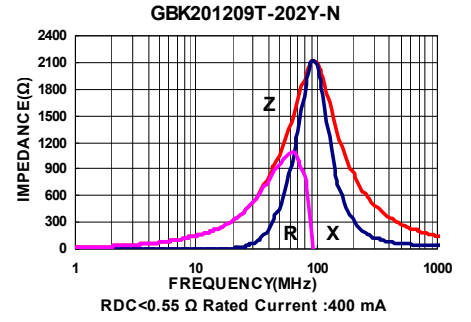
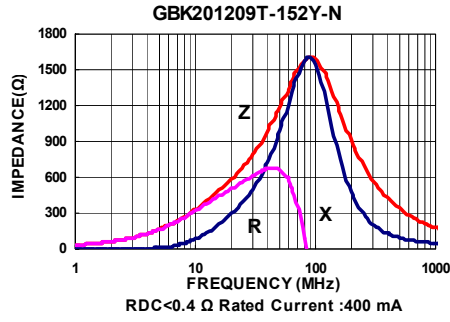
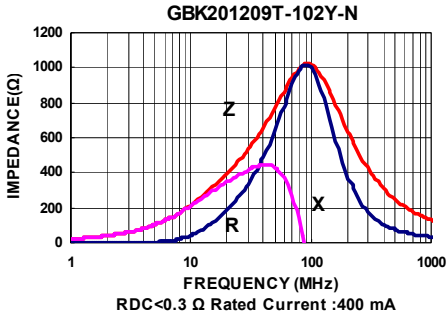

Electrical Characteristics

Part Number	Test Frequency (MHz)	Impedance ($\Omega \pm 25\%$)	DC Resistance (Ω) Max	Rated current (mA) Max
GBY321611T-320Y-N	100	32	0.03	1000
GBY321611T-600Y-N	100	60	0.06	800
GBK321611T-700Y-N	100	70	0.06	800
GBK321611T-900Y-N	100	90	0.10	800
GBK321611T-121Y-N	100	120	0.10	800
GBK321611T-151Y-N	100	150	0.10	800
GBK321611T-201Y-N	100	200	0.15	600
GBK321611T-401Y-N	100	400	0.15	600
GBK321611T-501Y-N	100	500	0.15	600
GBK321611T-601Y-N	100	600	0.20	500
GBK321611T-102Y-N	50	1000	0.25	400
GBK321611T-122Y-N	50	1200	0.25	400
GBK321611T-202Y-N	30	2000	0.35	400

Test Instruments : Agilent E4991A Impedance / Material Analyzer

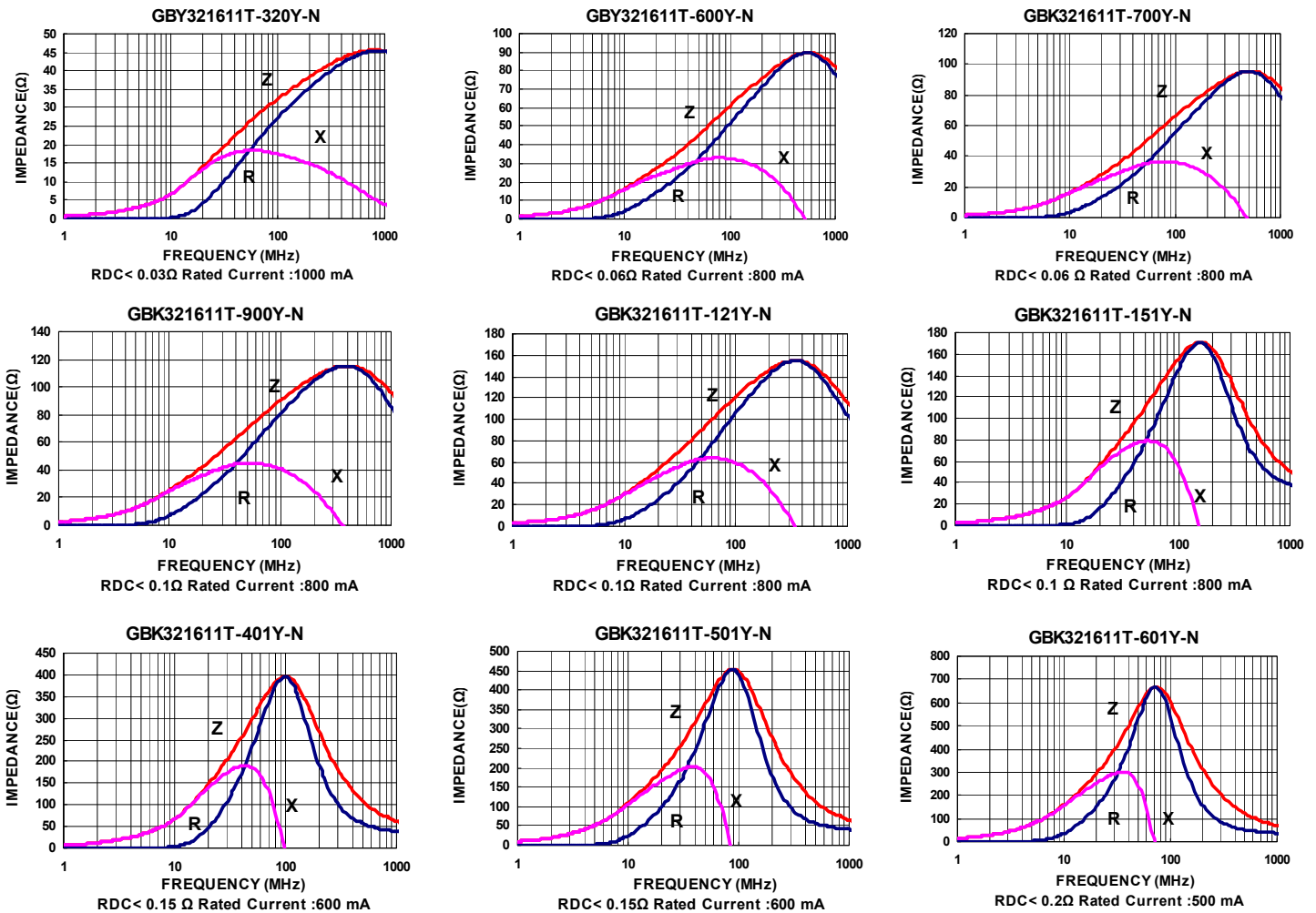

Test Instruments : Agilent E4991A Impedance / Material Analyzer

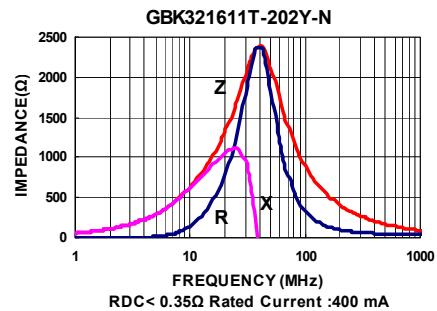
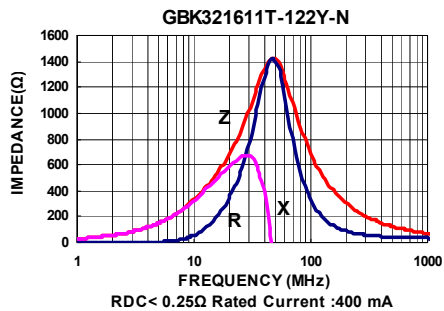
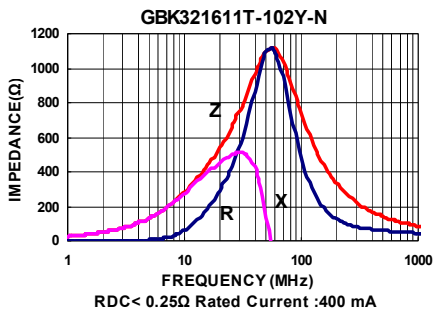

Packaging Specifications

Tape Dimensions

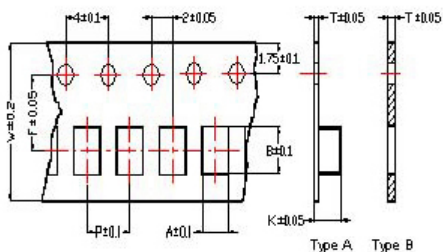

Tape Material

Carrier Tape: Polycarbonate (Tape A)
Carrier Tape: Paper (Tape B)
Cover Tape: Polystyrene

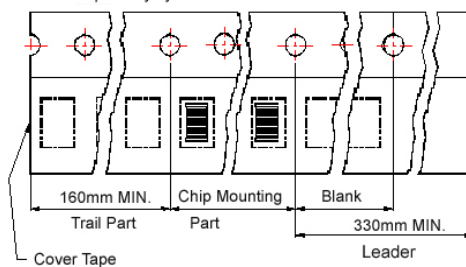

Reel Dimensions

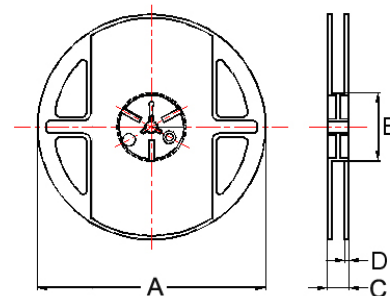

- ① : SB / PB / NB ② : SB / PB / NB / HF ③ : SB / PB
- ④ : SB / PB / NB / GB / UPB / HF / VPB ⑤ : UPB
- ⑥ : SB / PB / NB / GB / UPB ⑦ : SB ⑧ : PB / UPB

Dimensions in mm

TYPE	Tape Dimensions								Reel Dimensions				Quantity PCS / REEL
	A	B	T	W	P	F	K	Tape	A	B	C	D	
①060303	0.37	0.67	0.42	8.0	2.0	3.5	-	B	178	60	10	2	15000
②100505	0.65	1.15	0.60	8.0	2.0	3.5	-	B	178	60	12	2	10000
③160808	1.05	1.85	0.95	8.0	4.0	3.5	-	B	178	60	12	2	4000
④201209	1.50	2.30	0.97	8.0	4.0	3.5	-	B	178	60	12	2	4000
⑤201212	1.35	2.25	0.22	8.0	4.0	3.5	1.35	A	178	60	12	2	3000
④321611	1.88	3.50	0.22	8.0	4.0	3.5	1.27	A	178	60	12	2	3000
⑥321616	1.88	3.53	0.22	8.0	4.0	3.5	1.80	A	178	60	12	2	2000
⑦322513	2.77	3.42	0.22	8.0	4.0	3.5	1.55	A	178	60	12	2	2500
⑧451616	1.93	4.95	0.24	12	4.0	5.5	1.93	A	178	60	14	2	2000
⑨453215	3.66	4.95	0.24	12	8.0	5.5	1.85	A	178	60	14	2	1000

Multilayer Ferrite Chip Beads



Chilisin offers a wide range of multi-layered ferrite chip beads with various sizes, frequency characteristics, and impedance values for EMI solutions. These ferrite formulas are used to compose seven types of EMI suppression chip beads: SB, GB, PB, UPB, NB, HF, and VPB series.

Product Identification

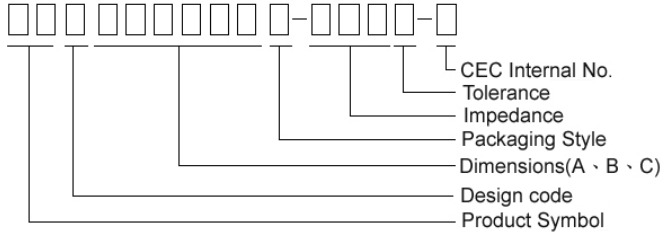

- Product symbol: SB, GB, PB, UPB, NB, HF, VPB
- Packaging: T : Tape and Reel ; B : Bulk
- Tolerance: Y = $\pm 25\%$; M = $\pm 20\%$; T: $\pm 30\%$
- Note: RoHS Compliant

Shape and Dimensions

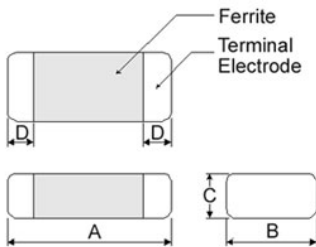

Dimensions in mm

TYPE	A	B	C	D
①060303	0.6 \pm 0.03	0.30 \pm 0.03	0.3 \pm 0.03	0.15 \pm 0.05
②100505	1.0 \pm 0.10	0.50 \pm 0.10	0.5 \pm 0.10	0.25 \pm 0.10
③160808	1.6 \pm 0.15	0.80 \pm 0.15	0.8 \pm 0.15	0.3 \pm 0.2
④201209	2.0 \pm 0.20	1.25 \pm 0.20	0.9 \pm 0.20	0.5 \pm 0.3
⑤201212	2.0 \pm 0.20	1.25 \pm 0.20	1.25 \pm 0.20	0.5 \pm 0.3
④321611	3.2 \pm 0.20	1.60 \pm 0.20	1.1 \pm 0.20	0.5 \pm 0.3
⑥321616	3.2 \pm 0.20	1.60 \pm 0.20	1.6 \pm 0.20	0.5 \pm 0.3
⑦322513	3.2 \pm 0.20	2.50 \pm 0.20	1.3 \pm 0.20	0.5 \pm 0.3
⑧451616	4.5 \pm 0.25	1.60 \pm 0.20	1.6 \pm 0.20	0.5 \pm 0.3
⑧453215	4.5 \pm 0.25	3.20 \pm 0.20	1.5 \pm 0.20	0.5 \pm 0.3

- ① : SB / PB / NB ② : SB / PB / NB / HF ⑦ : SB / PB
 ③ : SB / PB / NB / GB / UPB / HF / VPB ⑤ : UPB ⑥ : SB
 ④ : SB / PB / NB / GB / UPB ⑧ : PB / UPB

Recommended Pattern

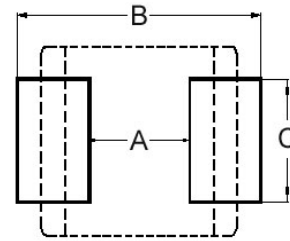

Dimensions in mm

TYPE	A	B	C
①060303	0.2 ~ 0.3	0.75 ~ 1.05	0.3
②100505	0.4	1.2 ~ 1.4	0.5
③160808	0.7 ~ 0.8	1.8 ~ 2.0	0.6 ~ 0.8
④201209	1.0 ~ 1.2	2.6 ~ 4.0	1.0 ~ 1.2
⑤201212	1.0 ~ 1.2	2.6 ~ 4.0	1.0 ~ 1.2
④321611	2.0	4.2 ~ 5.2	1.2
⑥321616	2.0	4.2 ~ 5.2	1.2
⑦322513	2.0	5.5 ~ 6.5	1.8
⑧451616	3.0	5.5 ~ 6.5	1.2
⑧453215	3.0	5.5 ~ 6.5	2.4

- * Don't apply narrower pattern than listed above to PB and UPB. Narrow pattern might cause excessive heat or open circuit.

Dimension Conversion

Code	Dimension in mm (AxBxC)	EIA
060303	0.6X0.3X0.3	0201
100505	1.0X0.5X0.5	0402
160808	1.6x0.8x0.8	0603
201209	2.0x1.2x0.9	0805
201212	2.0x1.2x1.25	0805
321611	3.2x1.6x1.1	1206
321616	3.2x1.6x1.6	1206
322513	3.2x2.5x1.3	1210
451616	4.5x1.6x1.6	1806
453215	4.5x3.2x1.5	1812

Electrical Characteristics

Part Number	Test Frequency (MHz)	Impedance ($\Omega \pm 25\%$)	DC Resistance (Ω) Max	Rated current (mA) Max
NBQ060303T-100Y-N	100	10 \pm 30%	0.4	300
NBQ060303T-220Y-N	100	22	0.5	200
NBQ060303T-470Y-N	100	47	0.7	200
NBQ060303T-750Y-N	100	75	1.0	200
NBQ060303T-121Y-N	100	120	1.5	100

Test Instruments : Agilent E4991A Impedance / Material Analyzer

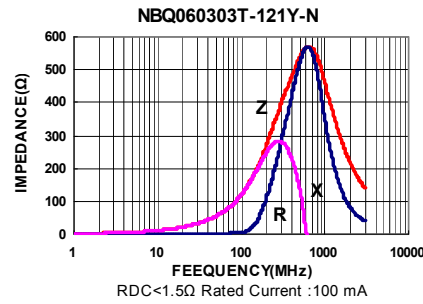
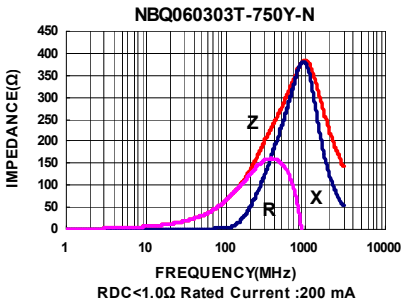
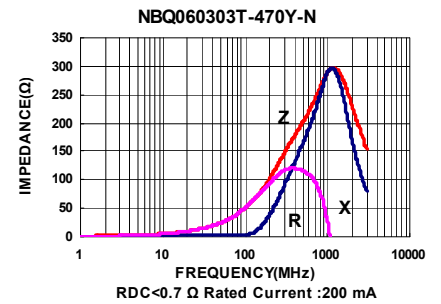
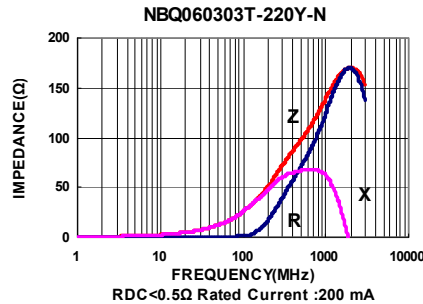
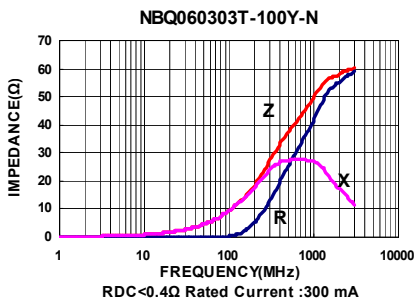

Electrical Characteristics

Part Number	Test Frequency (MHz)	Impedance ($\Omega \pm 25\%$)	DC Resistance (Ω) Max	Rated current (mA) Max
NBQ100505T-060Y-N	100	6 \pm 30%	0.08	500
NBQ100505T-100Y-N	100	10 \pm 30%	0.10	500
NBQ100505T-750Y-N	100	75	0.30	400
NBQ100505T-121Y-N	100	120	0.40	350
NBQ100505T-221Y-N	100	220	0.60	200
NBQ100505T-301Y-N	100	300	0.80	200
NBQ100505T-471Y-N	100	470	1.10	200
NBQ100505T-601Y-N	100	600	1.20	200

Test Instruments : Agilent E4991A Impedance / Material Analyzer

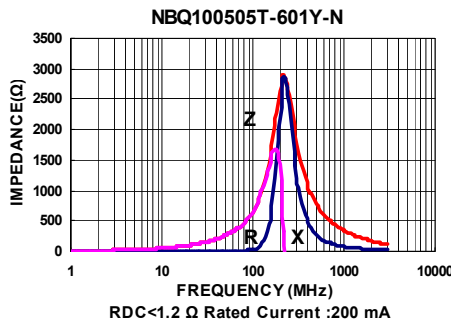
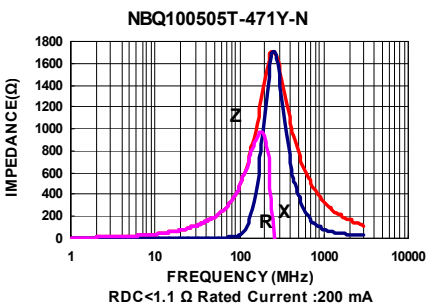
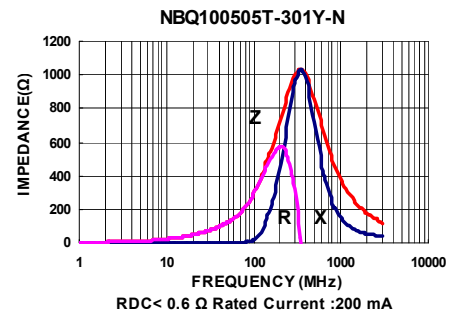
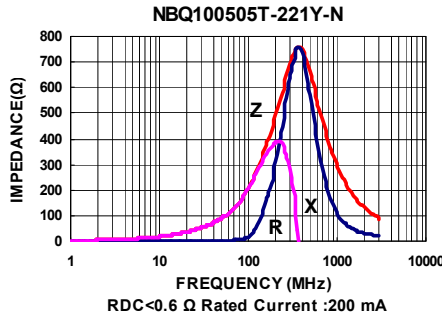
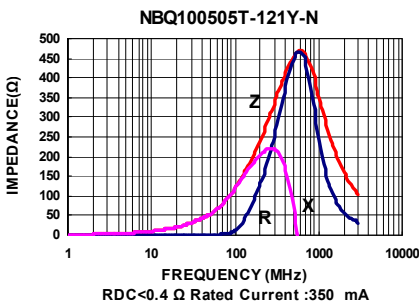
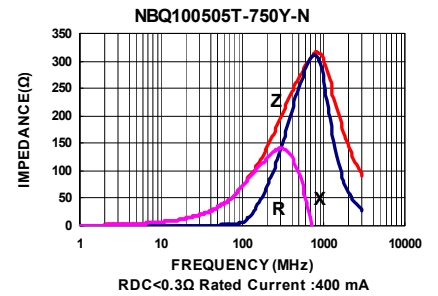
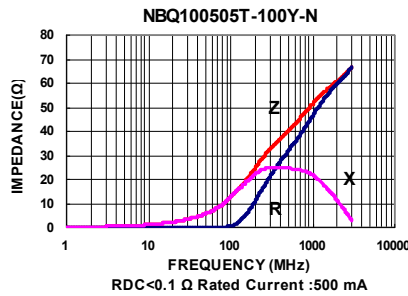
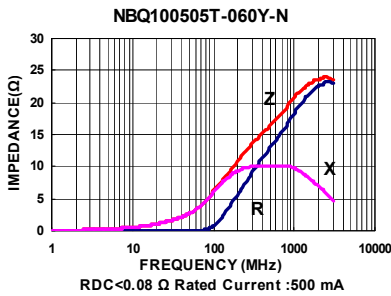

Electrical Characteristics

Part Number	Test Frequency (MHz)	Impedance ($\Omega \pm 25\%$)	DC Resistance (Ω) Max	Rated current (mA) Max
NBQ160808T-060Y-N	100	6 \pm 30%	0.05	700
NBQ160808T-100Y-N	100	10 \pm 30%	0.07	500
NBQ160808T-220Y-N	100	22	0.20	500
NBQ160808T-600Y-N	100	60	0.25	500
NBQ160808T-750Y-N	100	75	0.25	500
NBQ160808T-121Y-N	100	120	0.30	400
NBQ160808T-241Y-N	100	240	0.35	400
NBQ160808T-301Y-N	100	300	0.40	400
NBQ160808T-601Y-N	100	600	0.50	200
NBQ160808T-102Y-N	100	1000	0.60	200
NBQ160808T-122Y-N	100	1200	0.60	100
NBQ160808T-152Y-N	100	1500	0.70	100
NBQ160808T-182Y-N	100	1800	0.80	100
NBQ160808T-222Y-N	100	2200	1.0	100
NBQ160808T-252Y-N	100	2500	1.0	100

Test Instruments : Agilent E4991A Impedance / Material Analyzer

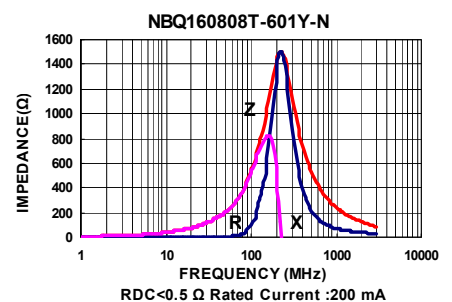
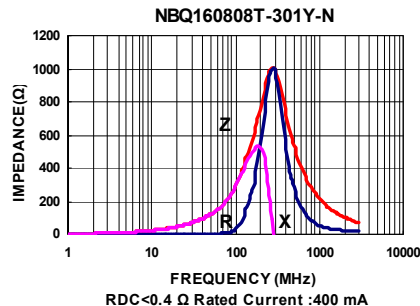
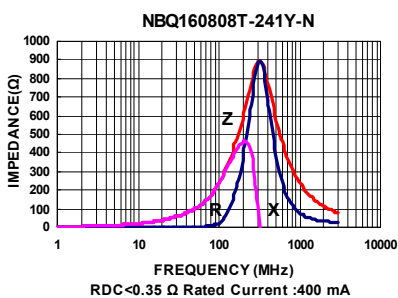
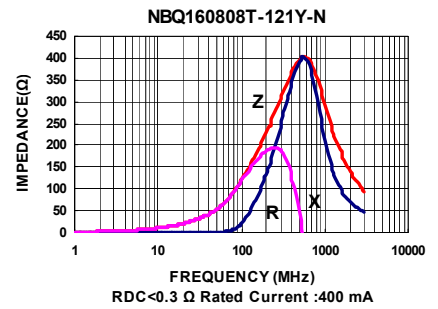
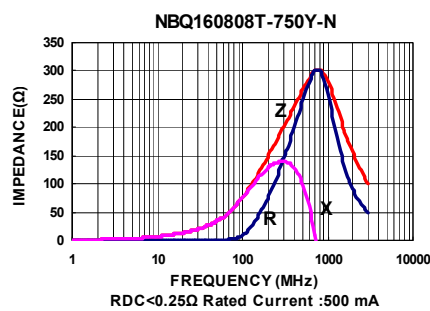
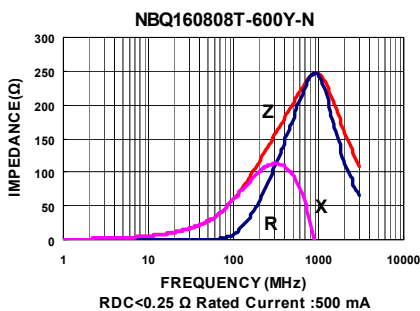
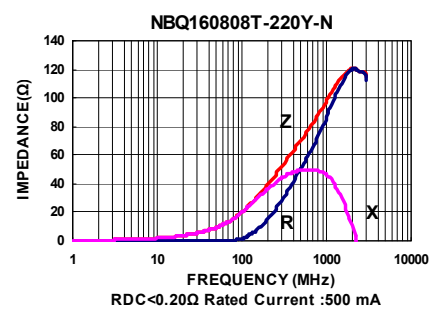
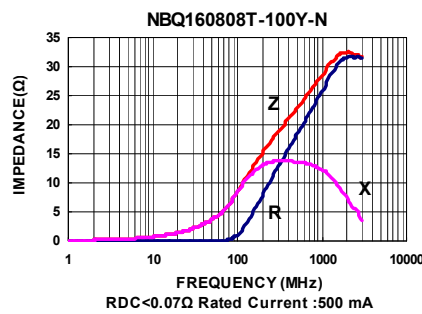
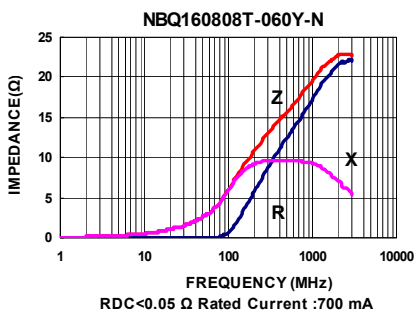

Test Instruments : Agilent E4991A Impedance / Material Analyzer

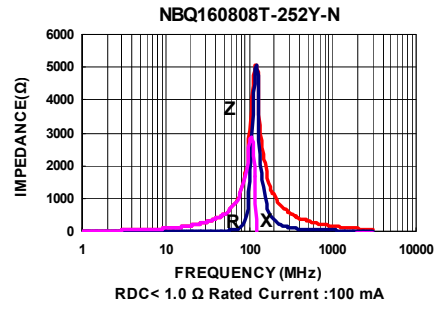
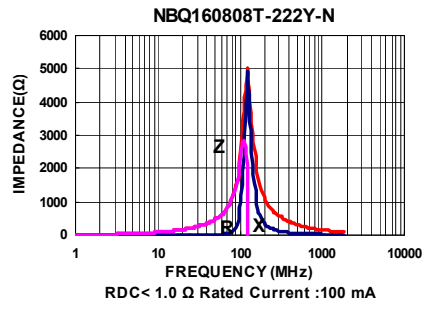
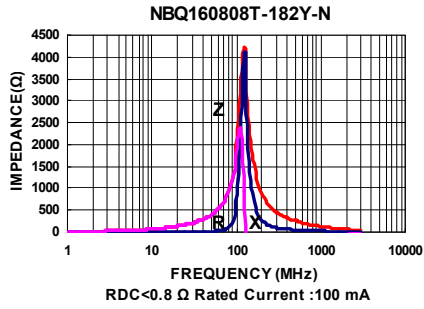
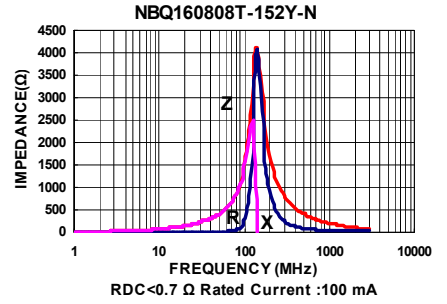
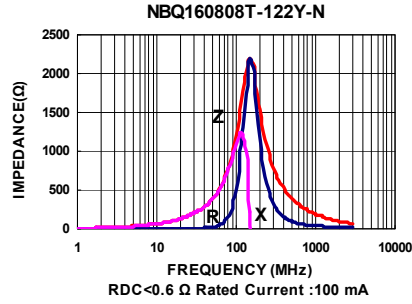
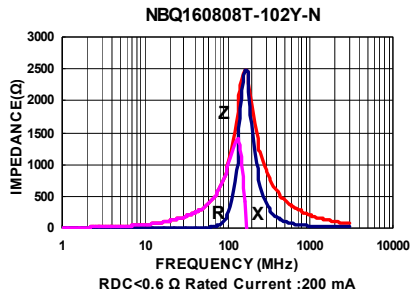

Packaging Specifications

Tape Dimensions

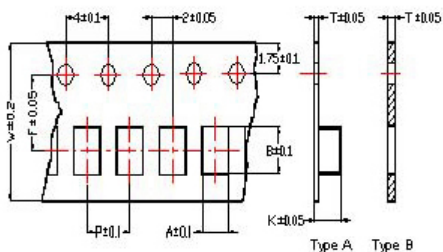

Tape Material

Carrier Tape: Polycarbonate (Tape A)
 Carrier Tape: Paper (Tape B)
 Cover Tape: Polystyrene

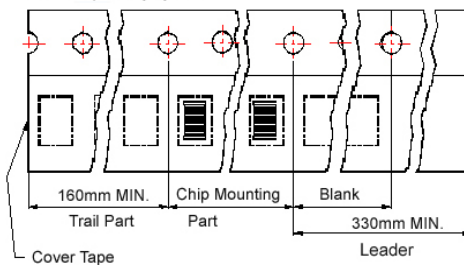

Reel Dimensions

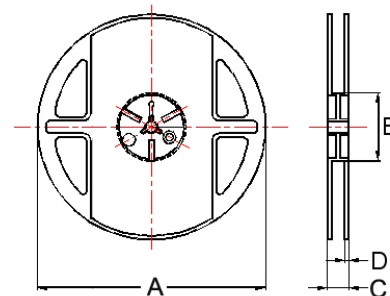

- ① : SB / PB / NB ② : SB / PB / NB / HF ③ : SB / PB
- ④ : SB / PB / NB / GB / UPB / HF / VPB ⑤ : UPB
- ⑥ : SB / PB / NB / GB / UPB ⑦ : SB ⑧ : PB / UPB

Dimensions in mm

TYPE	Tape Dimensions								Reel Dimensions				Quantity PCS / REEL
	A	B	T	W	P	F	K	Tape	A	B	C	D	
①060303	0.37	0.67	0.42	8.0	2.0	3.5	-	B	178	60	10	2	15000
②100505	0.65	1.15	0.60	8.0	2.0	3.5	-	B	178	60	12	2	10000
③160808	1.05	1.85	0.95	8.0	4.0	3.5	-	B	178	60	12	2	4000
④201209	1.50	2.30	0.97	8.0	4.0	3.5	-	B	178	60	12	2	4000
⑤201212	1.35	2.25	0.22	8.0	4.0	3.5	1.35	A	178	60	12	2	3000
④321611	1.88	3.50	0.22	8.0	4.0	3.5	1.27	A	178	60	12	2	3000
⑥321616	1.88	3.53	0.22	8.0	4.0	3.5	1.80	A	178	60	12	2	2000
⑦322513	2.77	3.42	0.22	8.0	4.0	3.5	1.55	A	178	60	12	2	2500
⑧451616	1.93	4.95	0.24	12	4.0	5.5	1.93	A	178	60	14	2	2000
⑨453215	3.66	4.95	0.24	12	8.0	5.5	1.85	A	178	60	14	2	1000

Multilayer Ferrite Chip Beads



Chilisin offers a wide range of multi-layered ferrite chip beads with various sizes, frequency characteristics, and impedance values for EMI solutions. These ferrite formulas are used to compose seven types of EMI suppression chip beads: SB, GB, PB, UPB, NB, HF, and VPB series.

Product Identification

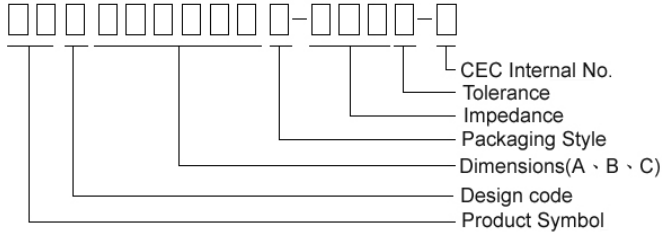

- Product symbol: SB, GB, PB, UPB, NB, HF, VPB
- Packaging: T : Tape and Reel ; B : Bulk
- Tolerance: Y = $\pm 25\%$; M = $\pm 20\%$; T: $\pm 30\%$
- Note: RoHS Compliant

Shape and Dimensions

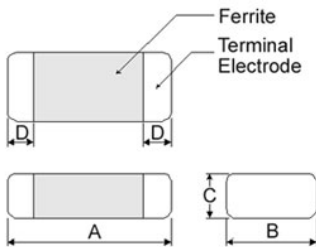

Dimensions in mm

TYPE	A	B	C	D
①060303	0.6 \pm 0.03	0.30 \pm 0.03	0.3 \pm 0.03	0.15 \pm 0.05
②100505	1.0 \pm 0.10	0.50 \pm 0.10	0.5 \pm 0.10	0.25 \pm 0.10
③160808	1.6 \pm 0.15	0.80 \pm 0.15	0.8 \pm 0.15	0.3 \pm 0.2
④201209	2.0 \pm 0.20	1.25 \pm 0.20	0.9 \pm 0.20	0.5 \pm 0.3
⑤201212	2.0 \pm 0.20	1.25 \pm 0.20	1.25 \pm 0.20	0.5 \pm 0.3
④321611	3.2 \pm 0.20	1.60 \pm 0.20	1.1 \pm 0.20	0.5 \pm 0.3
⑥321616	3.2 \pm 0.20	1.60 \pm 0.20	1.6 \pm 0.20	0.5 \pm 0.3
⑦322513	3.2 \pm 0.20	2.50 \pm 0.20	1.3 \pm 0.20	0.5 \pm 0.3
⑧451616	4.5 \pm 0.25	1.60 \pm 0.20	1.6 \pm 0.20	0.5 \pm 0.3
⑧453215	4.5 \pm 0.25	3.20 \pm 0.20	1.5 \pm 0.20	0.5 \pm 0.3

- ① : SB / PB / NB ② : SB / PB / NB / HF ⑦ : SB / PB
 ③ : SB / PB / NB / GB / UPB / HF / VPB ⑤ : UPB ⑥ : SB
 ④ : SB / PB / NB / GB / UPB ⑧ : PB / UPB

Recommended Pattern

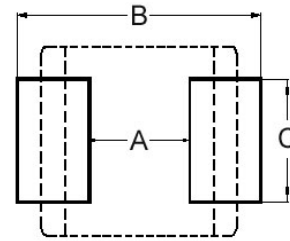

Dimensions in mm

TYPE	A	B	C
①060303	0.2 ~ 0.3	0.75 ~ 1.05	0.3
②100505	0.4	1.2 ~ 1.4	0.5
③160808	0.7 ~ 0.8	1.8 ~ 2.0	0.6 ~ 0.8
④201209	1.0 ~ 1.2	2.6 ~ 4.0	1.0 ~ 1.2
⑤201212	1.0 ~ 1.2	2.6 ~ 4.0	1.0 ~ 1.2
④321611	2.0	4.2 ~ 5.2	1.2
⑥321616	2.0	4.2 ~ 5.2	1.2
⑦322513	2.0	5.5 ~ 6.5	1.8
⑧451616	3.0	5.5 ~ 6.5	1.2
⑧453215	3.0	5.5 ~ 6.5	2.4

- * Don't apply narrower pattern than listed above to PB and UPB. Narrow pattern might cause excessive heat or open circuit.

Dimension Conversion

Code	Dimension in mm (AxBxC)	EIA
060303	0.6X0.3X0.3	0201
100505	1.0X0.5X0.5	0402
160808	1.6x0.8x0.8	0603
201209	2.0x1.2x0.9	0805
201212	2.0x1.2x1.25	0805
321611	3.2x1.6x1.1	1206
321616	3.2x1.6x1.6	1206
322513	3.2x2.5x1.3	1210
451616	4.5x1.6x1.6	1806
453215	4.5x3.2x1.5	1812

Electrical Characteristics

Part Number	Test Frequency (MHz)	Impedance ($\Omega \pm 25\%$)	DC Resistance (Ω) Max	Rated current (mA) Max
PBY060303T-100Y-N	100	10 $\pm 30\%$	0.050	1000
PBY060303T-220Y-N	100	22	0.065	1000
PBY060303T-330Y-N	100	33	0.090	750
PBY060303T-470Y-N	100	47	0.120	500
PBY060303T-800Y-N	100	80	0.180	500
PBY060303T-121Y-N	100	120	0.230	450
PBY060303T-241Y-N	100	240	0.400	350

Test Instruments : Agilent E4991A Impedance / Material Analyzer

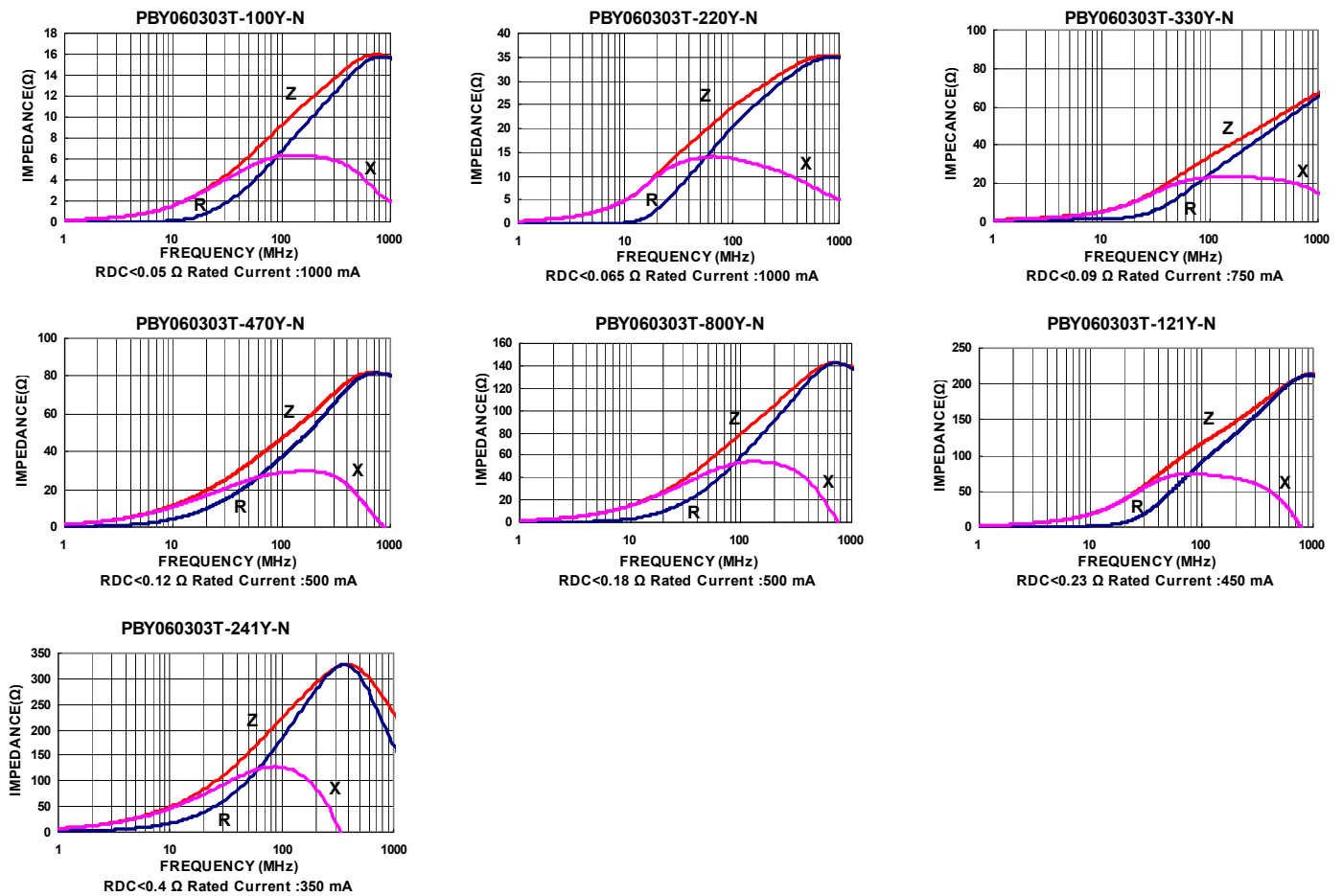

Electrical Characteristics

Part Number	Test Frequency (MHz)	Impedance ($\Omega \pm 25\%$)	DC Resistance (Ω) Max	Rated current (mA) Max
PBY100505T-100Y-N	100	10 \pm 30%	0.03	2000
PBY100505T-300Y-N	100	30	0.05	1700
PBY100505T-600Y-N	100	60	0.075	1500
PBY100505T-800Y-N	100	80	0.09	1200
PBY100505T-121Y-N	100	120	0.09	1200
PBY100505T-151Y-N	100	150	0.14	900
PBY100505T-221Y-N	100	220	0.18	580
PBY100505T-601Y-N	100	600	0.34	420
PBY100505T-102Y-N	100	1000	0.49	350

Test Instruments : Agilent E4991A Impedance / Material Analyzer

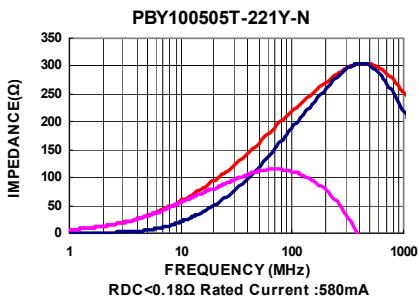
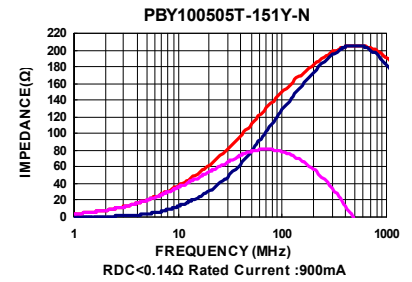
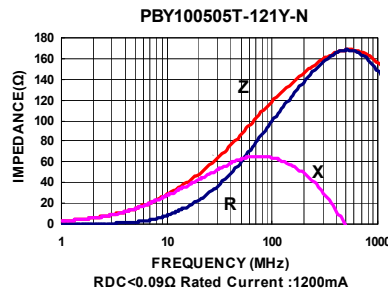
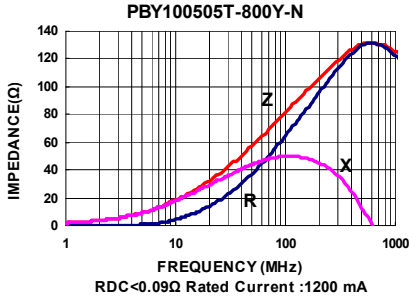
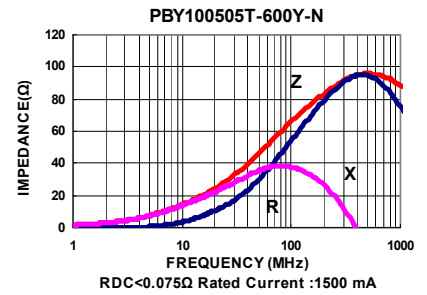
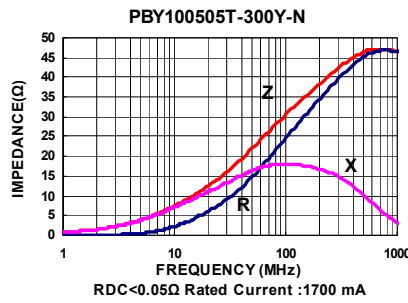
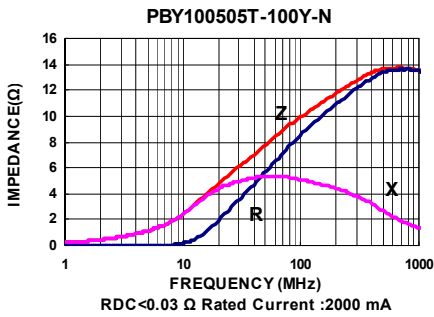

Electrical Characteristics

Part Number	Test Frequency (MHz)	Impedance ($\Omega \pm 25\%$)	DC Resistance (Ω) Max	Rated current (mA) Max
PBY160808T-100Y-N	100	10 \pm 30%	0.020	4000
PBY160808T-250Y-N	100	25	0.030	3000
PBY160808T-400Y-N	100	40	0.035	3000
PBY160808T-600Y-N	100	60	0.040	3000
PBY160808T-121Y-N	100	120	0.080	2500
PBY160808T-151Y-N	100	150	0.085	2000
PBY160808T-181Y-N	100	180	0.090	2000
PBY160808T-221Y-N	100	220	0.095	2000
PBY160808T-301Y-N	100	300	0.120	1500
PBY160808T-471Y-N	100	470	0.150	1200
PBY160808T-601Y-N	100	600	0.200	1000
PBY160808T-102Y-N	100	1000	0.250	800
PBY160808T-122Y-N	100	1200	0.250	800
PBY160808T-152Y-N	100	1500	0.400	500

Test Instruments : Agilent E4991A Impedance / Material Analyzer

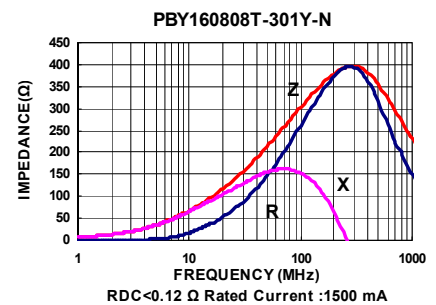
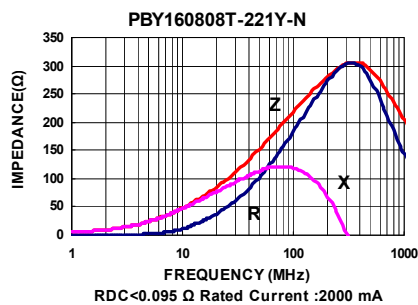
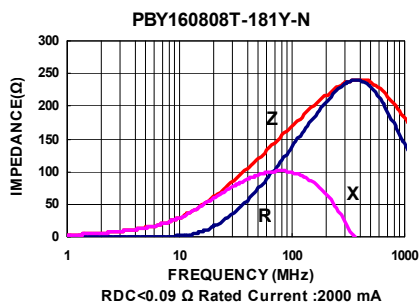
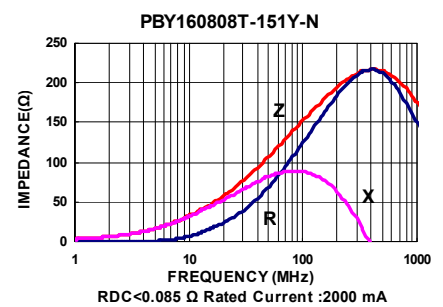
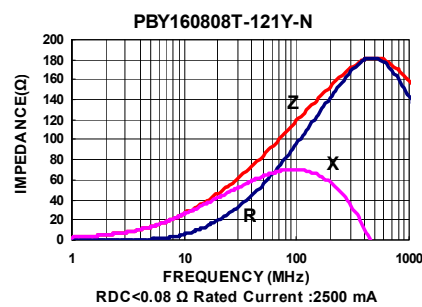
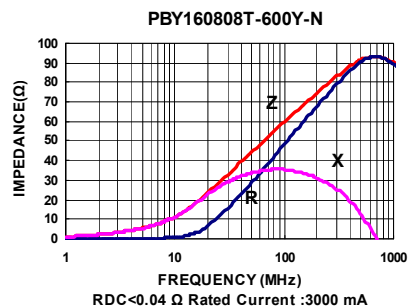
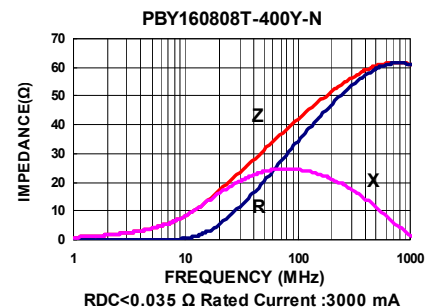
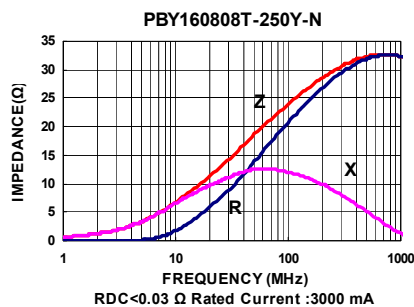
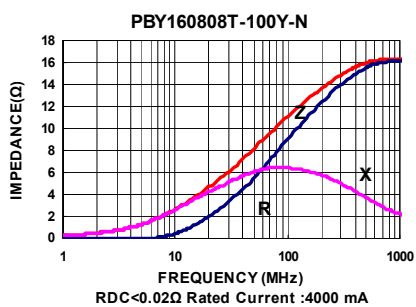

SMD Multilayer Ferrite Chip Beads - PBX Series

est Instruments : Agilent E4991A Impedance / Material Analyzer

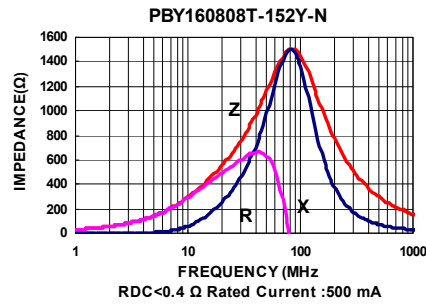
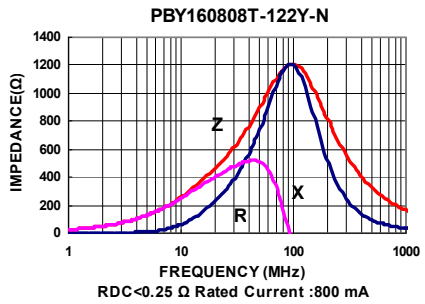
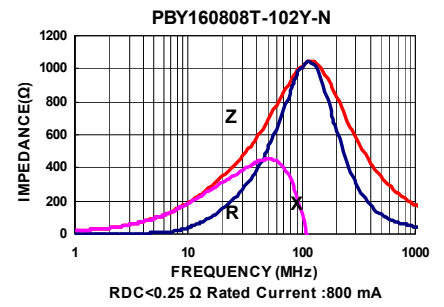
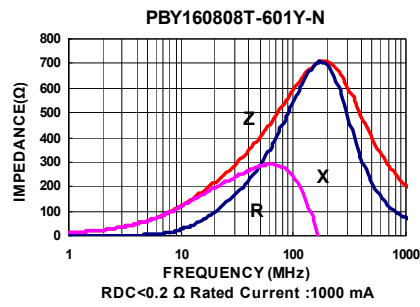
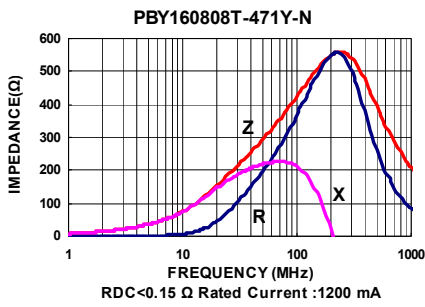

Electrical Characteristics

Part Number	Test Frequency (MHz)	Impedance ($\Omega \pm 25\%$)	DC Resistance (Ω) Max	Rated current (mA) Max
PBY201209T-100Y-N	100	10 \pm 30%	0.01	6000
PBY201209T-170Y-N	100	17	0.02	5000
PBY201209T-300Y-N	100	30	0.015	4000
PBY201209T-500Y-N	100	50	0.025	3000
PBY201209T-600Y-N	100	60	0.03	3000
PBY201209T-800Y-N	100	80	0.04	3000
PBY201209T-121Y-N	100	120	0.04	3000
PBY201209T-221Y-N	100	220	0.08	2000
PBY201209T-301Y-N	100	300	0.08	2000
PBY201209T-471Y-N	100	470	0.10	2000
PBY201209T-601Y-N	100	600	0.10	2000
PBY201209T-751Y-N	100	750	0.12	1500
PBY201209T-102Y-N	100	1000	0.12	1500
PBY201209T-152Y-N	100	1500	0.30	1000

Test Instruments : Agilent E4991A Impedance / Material Analyzer

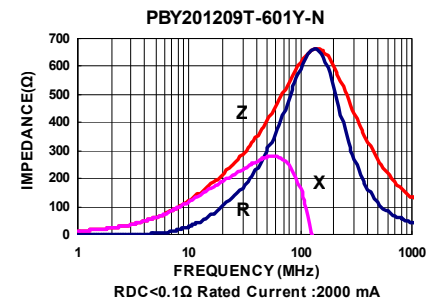
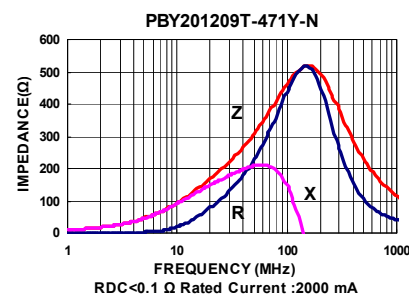
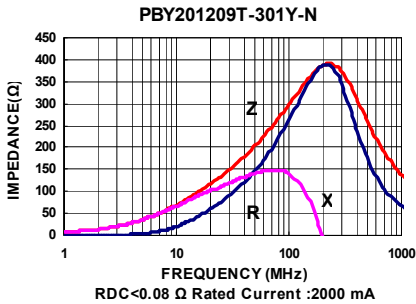
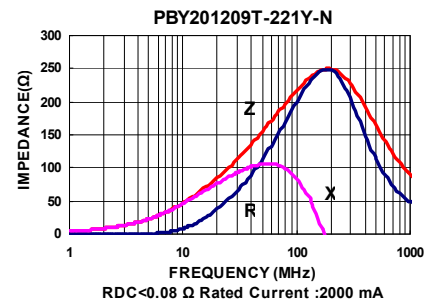
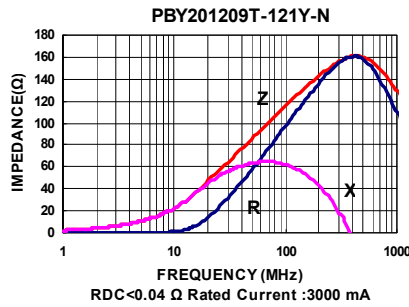
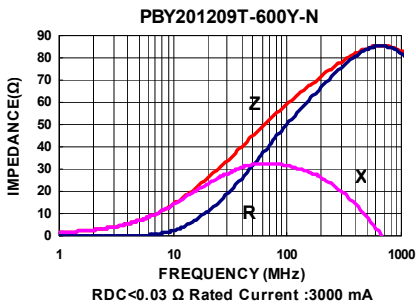
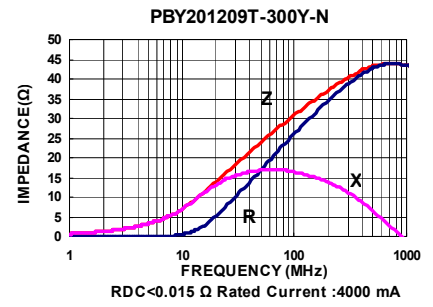
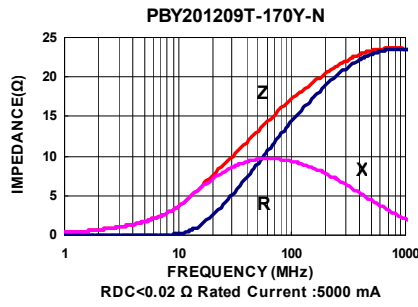
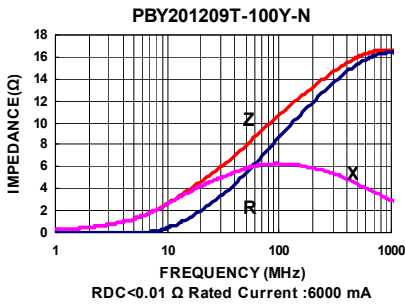

Test Instruments : Agilent E4991A Impedance / Material Analyzer

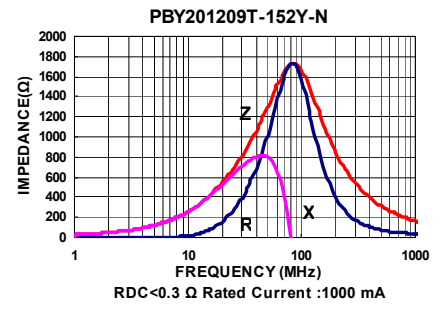
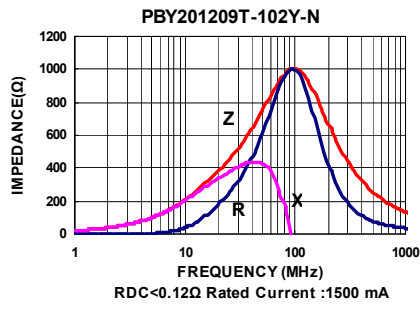
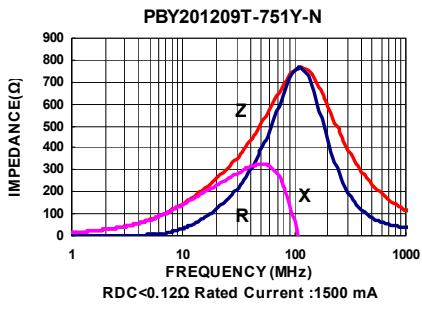

Electrical Characteristics

Part Number	Test Frequency (MHz)	Impedance ($\Omega \pm 25\%$)	DC Resistance (Ω) Max	Rated current (mA) Max
PBY321611T-100Y-N	100	10 \pm 30%	0.015	6000
PBY321611T-190Y-N	100	19	0.015	6000
PBY321611T-300Y-N	100	30	0.015	4000
PBY321611T-600Y-N	100	60	0.025	3000
PBY321611T-101Y-N	100	100	0.030	3000
PBY321611T-121Y-N	100	120	0.030	3000
PBY321611T-221Y-N	100	220	0.050	2000
PBY321611T-301Y-N	100	300	0.060	2000
PBY321611T-601Y-N	100	600	0.100	2000
PBY321611T-102Y-N	50	1000	0.150	1200
PBY321611T-122Y-N	50	1200	0.180	1000
PBY321611T-152Y-N	50	1500	0.200	800

Test Instruments : Agilent E4991A Impedance / Material Analyzer

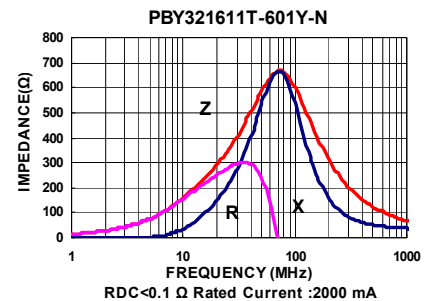
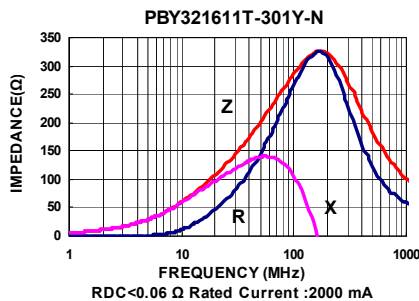
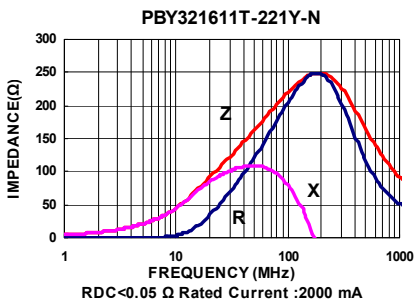
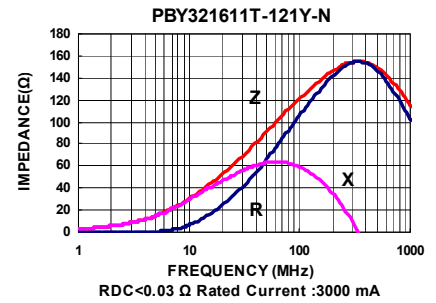
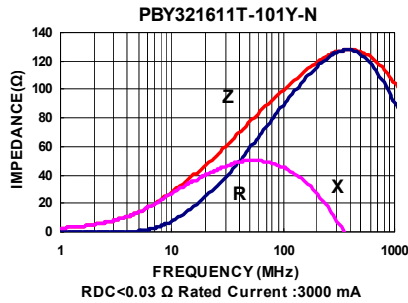
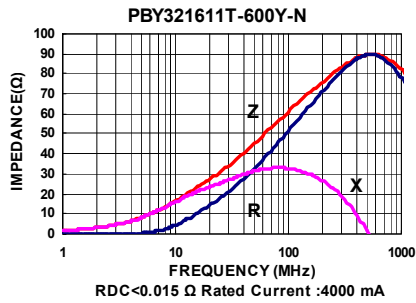
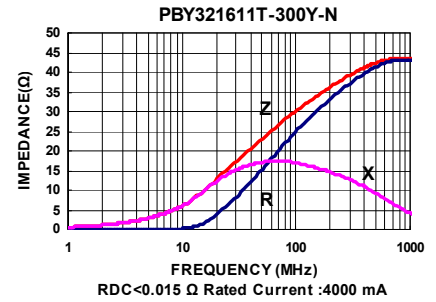
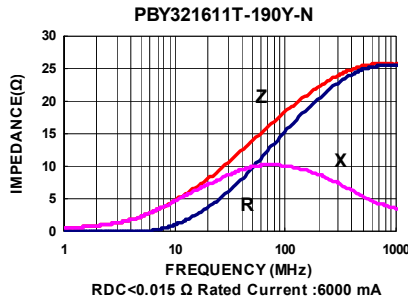
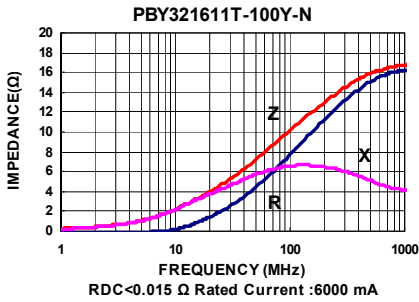

Test Instruments : Agilent E4991A Impedance / Material Analyzer

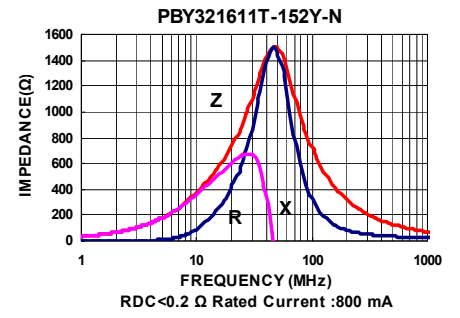
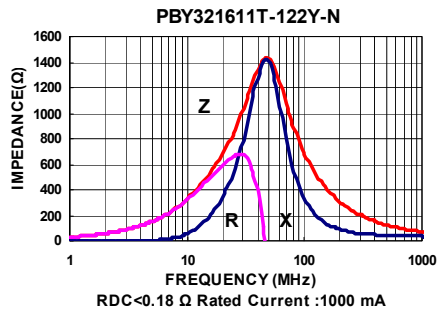
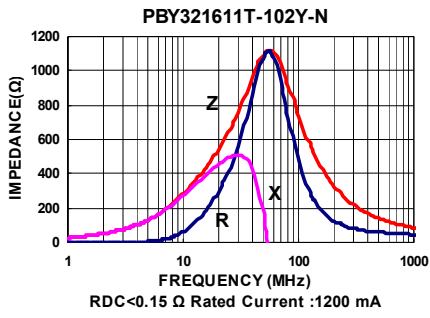

Electrical Characteristics

Part Number	Test Frequency (MHz)	Impedance ($\Omega \pm 25\%$)	DC Resistance (Ω) Max	Rated current (mA) Max
PBY322513T-190Y-N	100	19	0.025	4000
PBY322513T-300Y-N	100	30	0.025	4000
PBY322513T-600Y-N	100	60	0.025	4000
PBY322513T-900Y-N	100	90	0.025	3000
PBY322513T-121Y-N	100	120	0.030	2500

Test Instruments : Agilent E4991A Impedance / Material Analyzer

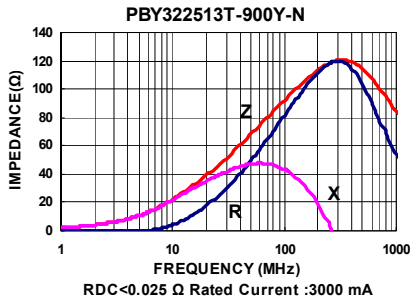
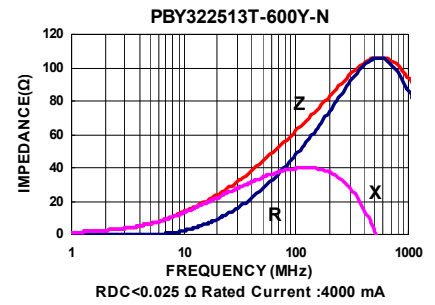
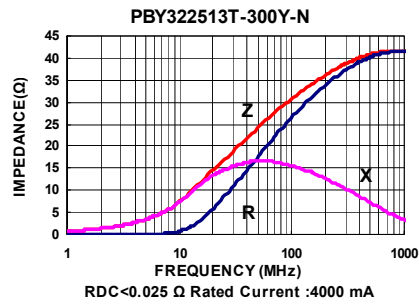
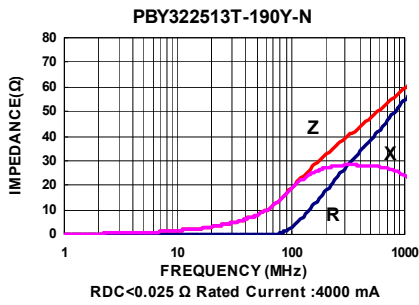

Electrical Characteristics

Part Number	Test Frequency (MHz)	Impedance ($\Omega \pm 25\%$)	DC Resistance (Ω) Max	Rated current (mA) Max
PBY451616T-190Y-N	100	19	0.020	6000
PBY451616T-400Y-N	100	40	0.020	6000
PBY451616T-500Y-N	100	50	0.020	6000
PBY451616T-600Y-N	100	60	0.020	5000
PBY451616T-800Y-N	100	80	0.025	4000
PBY451616T-900Y-N	100	90	0.100	2000

Test Instruments : Agilent E4991A Impedance / Material Analyzer

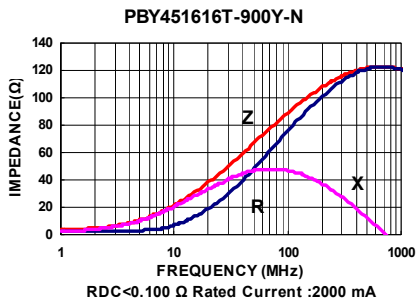
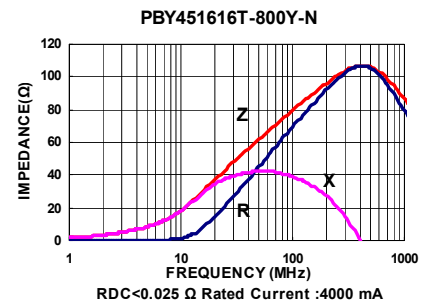
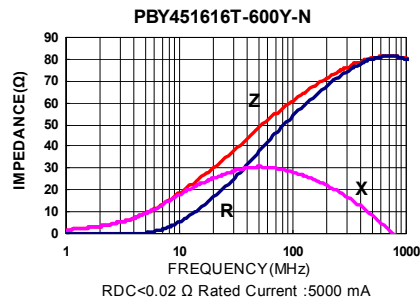
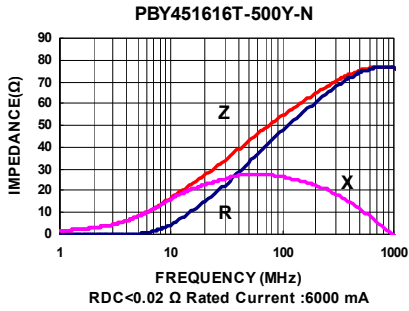

Electrical Characteristics

Part Number	Test Frequency (MHz)	Impedance ($\Omega \pm 25\%$)	DC Resistance (Ω) Max	Rated current (mA) Max
PBY453215T-190Y-N	100	19	0.030	6000
PBY453215T-300Y-N	100	30	0.030	6000
PBY453215T-600Y-N	100	60	0.030	6000
PBY453215T-700Y-N	100	70	0.030	6000
PBY453215T-121Y-N	100	120	0.030	4000
PBY453215T-151Y-N	100	150	0.030	4000

Test Instruments : Agilent E4991A Impedance / Material Analyzer

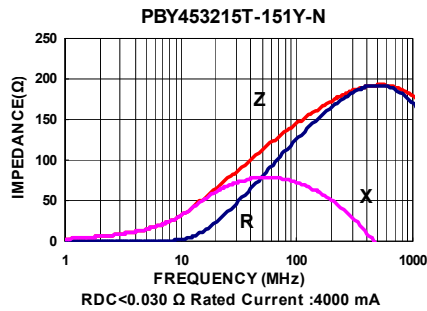
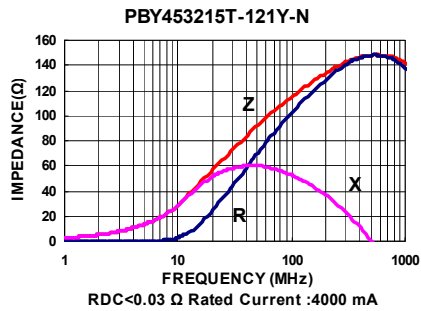
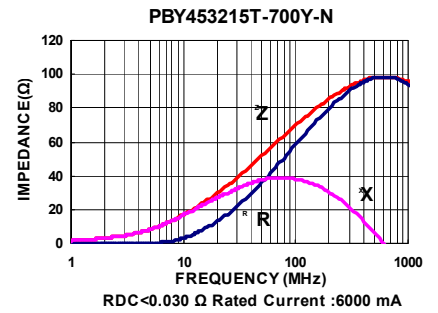
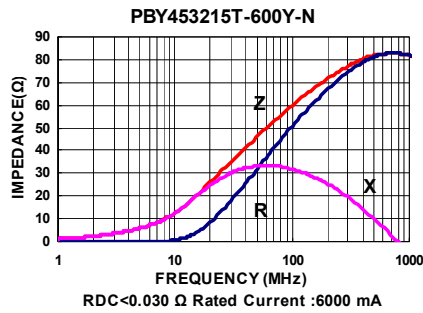
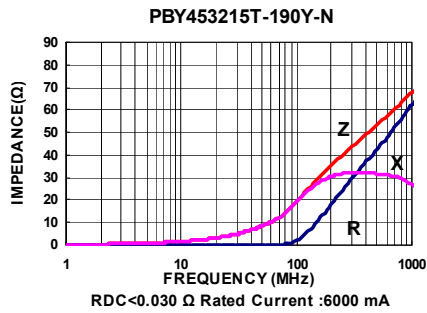

Packaging Specifications

Tape Dimensions

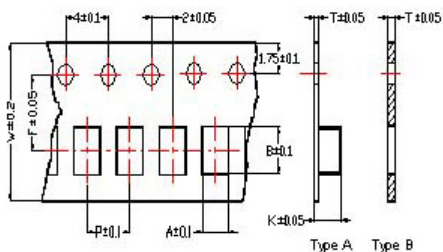

Tape Material

Carrier Tape: Polycarbonate (Tape A)
Carrier Tape: Paper (Tape B)
Cover Tape: Polystyrene

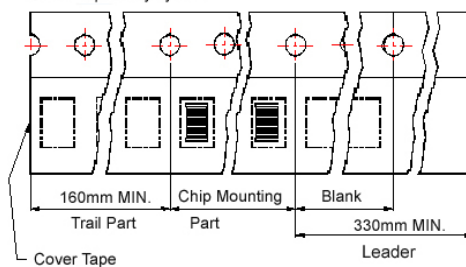

Reel Dimensions

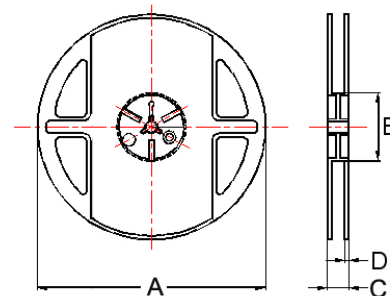

- ① : SB / PB / NB ② : SB / PB / NB / HF ③ : SB / PB
- ④ : SB / PB / NB / GB / UPB / HF / VPB ⑤ : UPB
- ⑥ : SB / PB / NB / GB / UPB ⑦ : SB ⑧ : PB / UPB

Dimensions in mm

TYPE	Tape Dimensions								Reel Dimensions				Quantity PCS / REEL
	A	B	T	W	P	F	K	Tape	A	B	C	D	
①060303	0.37	0.67	0.42	8.0	2.0	3.5	-	B	178	60	10	2	15000
②100505	0.65	1.15	0.60	8.0	2.0	3.5	-	B	178	60	12	2	10000
③160808	1.05	1.85	0.95	8.0	4.0	3.5	-	B	178	60	12	2	4000
④201209	1.50	2.30	0.97	8.0	4.0	3.5	-	B	178	60	12	2	4000
⑤201212	1.35	2.25	0.22	8.0	4.0	3.5	1.35	A	178	60	12	2	3000
④321611	1.88	3.50	0.22	8.0	4.0	3.5	1.27	A	178	60	12	2	3000
⑥321616	1.88	3.53	0.22	8.0	4.0	3.5	1.80	A	178	60	12	2	2000
⑦322513	2.77	3.42	0.22	8.0	4.0	3.5	1.55	A	178	60	12	2	2500
⑧451616	1.93	4.95	0.24	12	4.0	5.5	1.93	A	178	60	14	2	2000
⑨453215	3.66	4.95	0.24	12	8.0	5.5	1.85	A	178	60	14	2	1000

Multilayer Ferrite Chip Beads



Chilisin offers a wide range of multi-layered ferrite chip beads with various sizes, frequency characteristics, and impedance values for EMI solutions. These ferrite formulas are used to compose seven types of EMI suppression chip beads: SB, GB, PB, UPB, NB, HF, and VPB series.

Product Identification

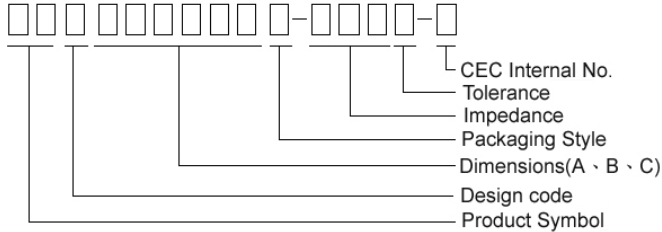

- Product symbol: SB, GB, PB, UPB, NB, HF, VPB
- Packaging: T : Tape and Reel ; B : Bulk
- Tolerance: Y = $\pm 25\%$; M = $\pm 20\%$; T: $\pm 30\%$
- Note: RoHS Compliant

Shape and Dimensions

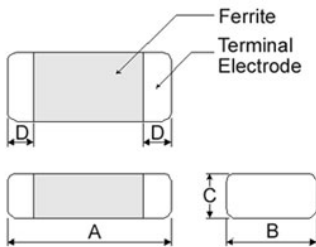

Dimensions in mm

TYPE	A	B	C	D
①060303	0.6 \pm 0.03	0.30 \pm 0.03	0.3 \pm 0.03	0.15 \pm 0.05
②100505	1.0 \pm 0.10	0.50 \pm 0.10	0.5 \pm 0.10	0.25 \pm 0.10
③160808	1.6 \pm 0.15	0.80 \pm 0.15	0.8 \pm 0.15	0.3 \pm 0.2
④201209	2.0 \pm 0.20	1.25 \pm 0.20	0.9 \pm 0.20	0.5 \pm 0.3
⑤201212	2.0 \pm 0.20	1.25 \pm 0.20	1.25 \pm 0.20	0.5 \pm 0.3
④321611	3.2 \pm 0.20	1.60 \pm 0.20	1.1 \pm 0.20	0.5 \pm 0.3
⑥321616	3.2 \pm 0.20	1.60 \pm 0.20	1.6 \pm 0.20	0.5 \pm 0.3
⑦322513	3.2 \pm 0.20	2.50 \pm 0.20	1.3 \pm 0.20	0.5 \pm 0.3
⑧451616	4.5 \pm 0.25	1.60 \pm 0.20	1.6 \pm 0.20	0.5 \pm 0.3
⑧453215	4.5 \pm 0.25	3.20 \pm 0.20	1.5 \pm 0.20	0.5 \pm 0.3

- ① : SB / PB / NB ② : SB / PB / NB / HF ⑦ : SB / PB
 ③ : SB / PB / NB / GB / UPB / HF / VPB ⑤ : UPB ⑥ : SB
 ④ : SB / PB / NB / GB / UPB ⑧ : PB / UPB

Recommended Pattern

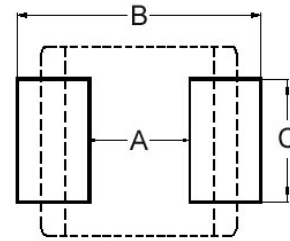

Dimensions in mm

TYPE	A	B	C
①060303	0.2 ~ 0.3	0.75 ~ 1.05	0.3
②100505	0.4	1.2 ~ 1.4	0.5
③160808	0.7 ~ 0.8	1.8 ~ 2.0	0.6 ~ 0.8
④201209	1.0 ~ 1.2	2.6 ~ 4.0	1.0 ~ 1.2
⑤201212	1.0 ~ 1.2	2.6 ~ 4.0	1.0 ~ 1.2
④321611	2.0	4.2 ~ 5.2	1.2
⑥321616	2.0	4.2 ~ 5.2	1.2
⑦322513	2.0	5.5 ~ 6.5	1.8
⑧451616	3.0	5.5 ~ 6.5	1.2
⑧453215	3.0	5.5 ~ 6.5	2.4

- * Don't apply narrower pattern than listed above to PB and UPB. Narrow pattern might cause excessive heat or open circuit.

Dimension Conversion

Code	Dimension in mm (AxBxC)	EIA
060303	0.6X0.3X0.3	0201
100505	1.0X0.5X0.5	0402
160808	1.6x0.8x0.8	0603
201209	2.0x1.2x0.9	0805
201212	2.0x1.2x1.25	0805
321611	3.2x1.6x1.1	1206
321616	3.2x1.6x1.6	1206
322513	3.2x2.5x1.3	1210
451616	4.5x1.6x1.6	1806
453215	4.5x3.2x1.5	1812

Electrical Characteristics

Part Number	Test Frequency (MHz)	Impedance ($\Omega \pm 25\%$)	DC Resistance (Ω) Max	Rated current (mA) Max
VPB160808T-100Y-N	100	10	0.010	6000
VPB160808T-300Y-N	100	30	0.015	4000
VPB160808T-600Y-N	100	60	0.030	3000
VPB160808T-700Y-N	100	70	0.040	3000
VPB160808T-800Y-N	100	80	0.040	3000
VPB160808T-121Y-N	100	120	0.040	3000
VPB160808T-201Y-N	100	200	0.050	2500
VPB160808T-221Y-N	100	220	0.080	2000
VPB160808T-301Y-N	100	300	0.080	2000
VPB160808T-331Y-N	100	330	0.080	2000
VPB160808T-471Y-N	100	470	0.100	2000
VPB160808T-601Y-N	100	600	0.100	2000

Test Instruments : Agilent E4991A Impedance / Material Analyzer

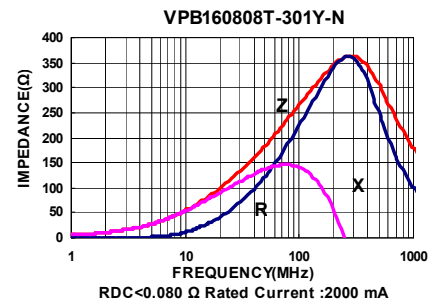
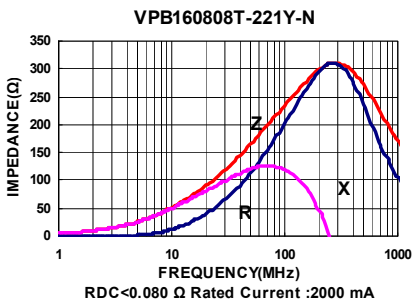
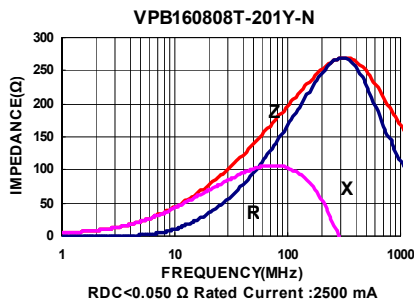
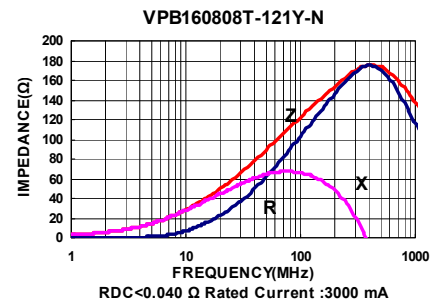
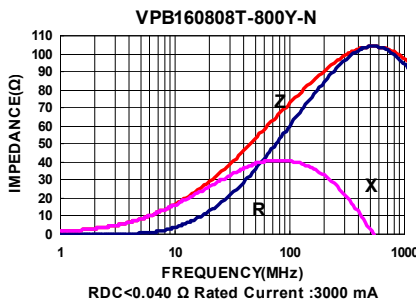
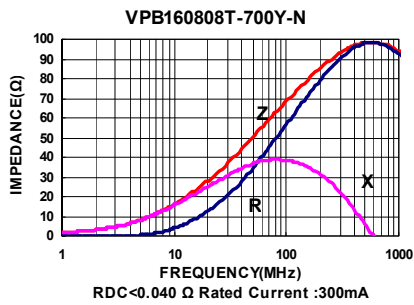
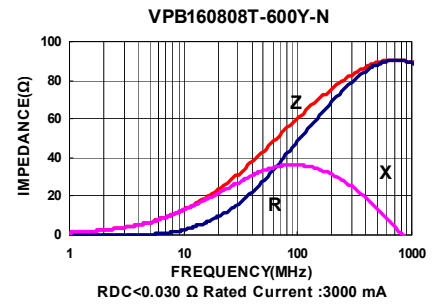
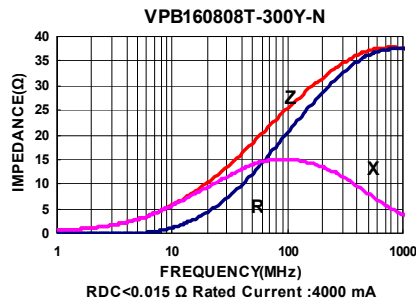
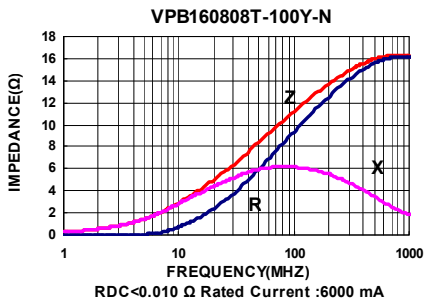

SMD Multilayer Ferrite Chip Power Beads – VPB Series

Test Instruments : Agilent E4991A Impedance / Material Analyzer

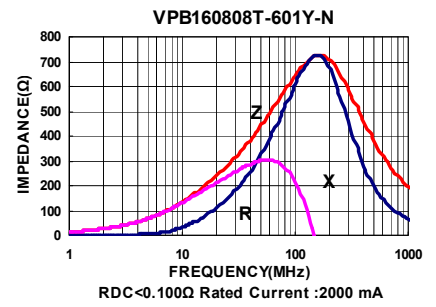
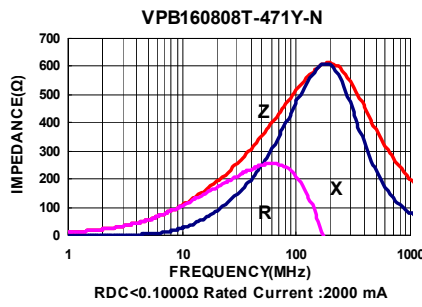
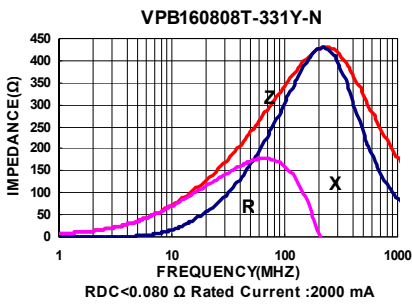

Packaging Specifications

Tape Dimensions

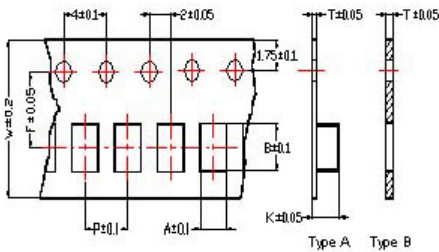

Tape Material

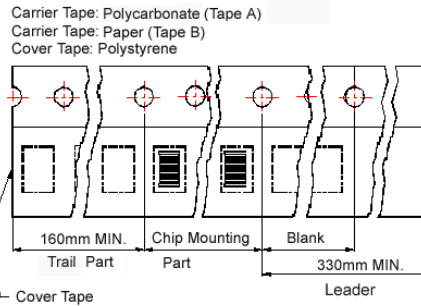

Reel Dimensions

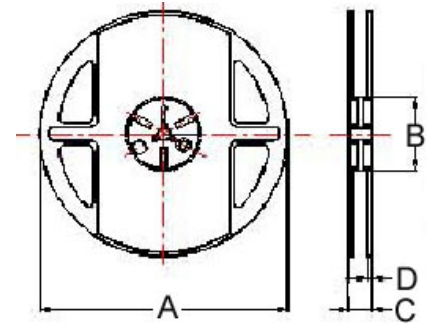

Dimensions in mm

TYPE	Tape Dimensions								Reel Dimensions				Quantity PCS / Reel
	A	B	T	W	P	F	K	Tape Type.	A	B	C	D	
160808	1.05	1.85	0.95	8.0	4.0	3.5	-	B	178	60	12	2	4000

Multilayer Ferrite Chip Beads



Chilisin offers a wide range of multi-layered ferrite chip beads with various sizes, frequency characteristics, and impedance values for EMI solutions. These ferrite formulas are used to compose seven types of EMI suppression chip beads: SB, GB, PB, UPB, NB, HF, and VPB series.

Product Identification

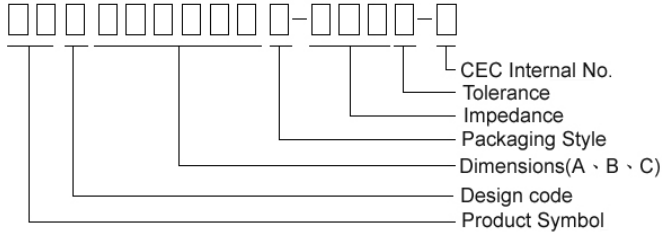

- Product symbol: SB, GB, PB, UPB, NB, HF, VPB
- Packaging: T : Tape and Reel ; B : Bulk
- Tolerance: Y = $\pm 25\%$; M = $\pm 20\%$; T: $\pm 30\%$
- Note: RoHS Compliant

Shape and Dimensions

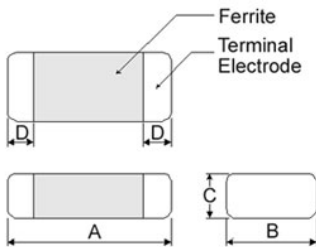

Dimensions in mm

TYPE	A	B	C	D
100505	1.0 \pm 0.10	0.50 \pm 0.10	0.5 \pm 0.10	0.25 \pm 0.10
160805	1.6 \pm 0.15	0.80 \pm 0.15	0.5 \pm 0.15	0.3 \pm 0.2
160808	1.6 \pm 0.15	0.80 \pm 0.15	0.8 \pm 0.15	0.3 \pm 0.2
201209	2.0 \pm 0.20	1.25 \pm 0.20	0.9 \pm 0.20	0.5 \pm 0.3
201212	2.0 \pm 0.20	1.25 \pm 0.20	1.25 \pm 0.20	0.5 \pm 0.3
321611	3.2 \pm 0.20	1.60 \pm 0.20	1.1 \pm 0.20	0.5 \pm 0.3
451616	4.5 \pm 0.25	1.60 \pm 0.20	1.6 \pm 0.20	0.5 \pm 0.3
453215	4.5 \pm 0.25	3.20 \pm 0.20	1.5 \pm 0.20	0.5 \pm 0.3

Recommended Pattern

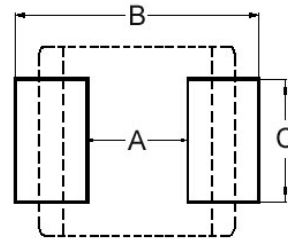

Dimensions in mm

TYPE	A	B	C
100505	0.4	1.2 ~ 1.4	0.5
160805	0.7 ~ 0.8	1.8 ~ 2.0	0.6 ~ 0.8
160808	0.7 ~ 0.8	1.8 ~ 2.0	0.6 ~ 0.8
201209	1.0 ~ 1.2	2.6 ~ 4.0	1.0 ~ 1.2
201212	1.0 ~ 1.2	2.6 ~ 4.0	1.0 ~ 1.2
321611	2.0	4.2 ~ 5.2	1.2
451616	3.0	5.5 ~ 6.5	1.2
453215	3.0	5.5 ~ 6.5	2.4

* Don't apply narrower pattern than listed above to PB and UPB. Narrow pattern might cause excessive heat or open circuit.

Dimension Conversion

Code	Dimension in mm (AxBxC)	EIA
100505	1.0X0.5X0.5	0402
160805	1.6x0.8x0.5	0603
160808	1.6x0.8x0.8	0603
201209	2.0x1.2x0.9	0805
201212	2.0x1.2x1.25	0805
321611	3.2x1.6x1.1	1206
451616	4.5x1.6x1.6	1806
453215	4.5x3.2x1.5	1812

Electrical Characteristics

Part Number	Test Frequency (MHz)	Impedance ($\Omega \pm 25\%$)	DC Resistance (Ω) Max	Rated current (mA) Max
UPB100505T-330Y-N	100	33	0.022	3000
UPB100505T-600Y-N	100	60	0.032	2500
UPB100505T-800Y-N	100	80	0.038	2300
UPB100505T-121Y-N	100	120	0.055	2000
UPB100505T-181Y-N	100	180	0.090	1500
UPB100505T-221Y-N	100	220	0.100	1400
UPB100505T-331Y-N	100	330	0.150	1200

Test Instruments : Agilent E4991A Impedance / Material Analyzer

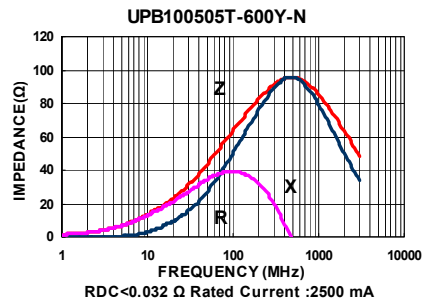
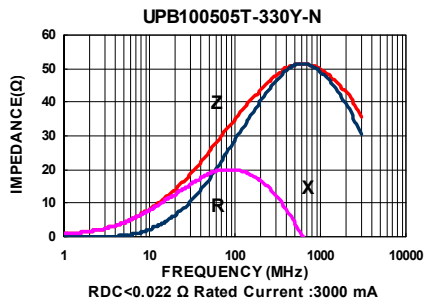

Electrical Characteristics

Part Number	Test Frequency (MHz)	Impedance ($\Omega \pm 25\%$)	DC Resistance (Ω) Max	Rated current (mA) Max
UPB160805T-260Y-N	100	26	0.007	6000
UPB160805T-300Y-N	100	30	0.020	4000
UPB160805T-700Y-N	100	70	0.020	4000
UPB160805T-101Y-N	100	100	0.025	3000
UPB160805T-121Y-N	100	120	0.025	3000
UPB160805T-221Y-N	100	220	0.040	2500
UPB160805T-331Y-N	100	330	0.070	1500

Test Instruments : Agilent E4991A Impedance / Material Analyzer

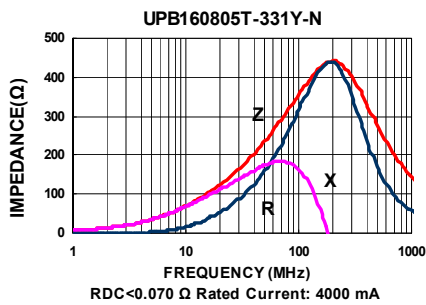
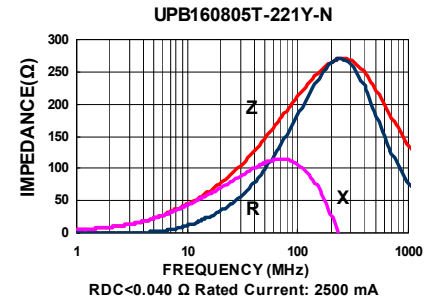
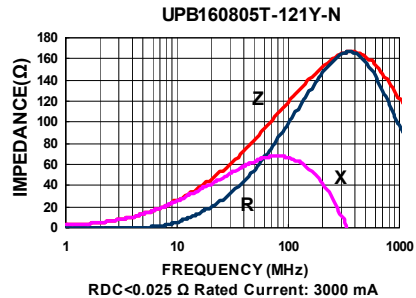
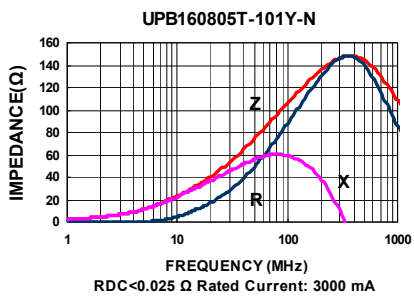
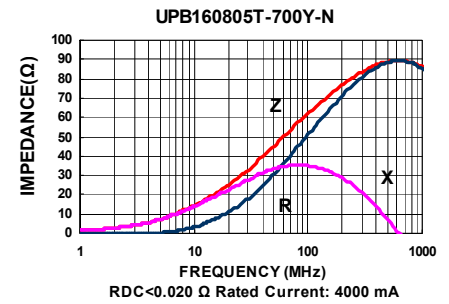
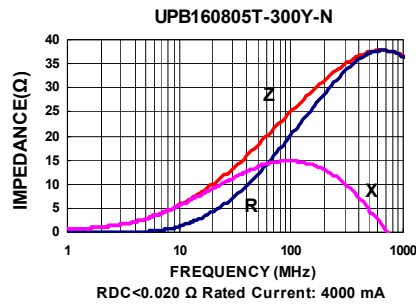
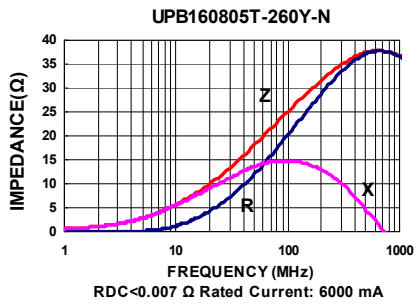

Electrical Characteristics

Part Number	Test Frequency (MHz)	Impedance ($\Omega \pm 25\%$)	DC Resistance (Ω) Max	Rated current (mA) Max
UPB160808T-100Y-N	100	10 \pm 30%	0.010	5000
UPB160808T-300Y-N	100	30	0.015	4500
UPB160808T-600Y-N	100	60	0.020	4000
UPB160808T-700Y-N	100	70	0.020	4000
UPB160808T-101Y-N	100	100	0.030	3000
UPB160808T-121Y-N	100	120	0.030	3000
UPB160808T-181Y-N	100	180	0.050	2000
UPB160808T-221Y-N	100	220	0.040	2500

Test Instruments : Agilent E4991A Impedance / Material Analyzer

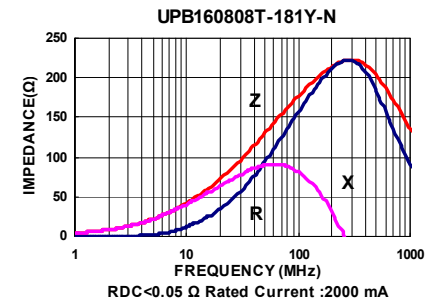
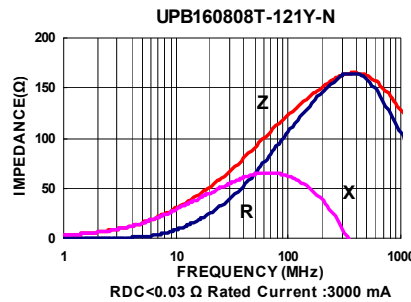
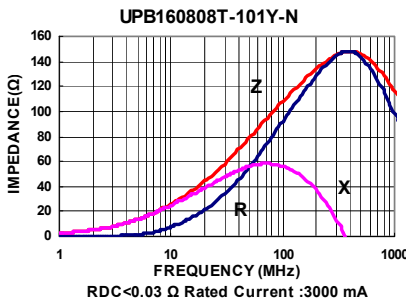
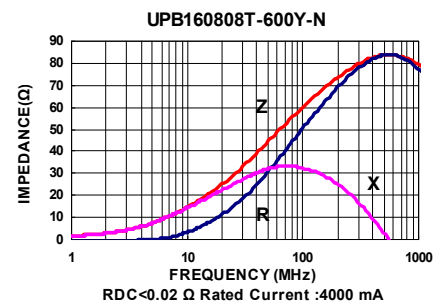
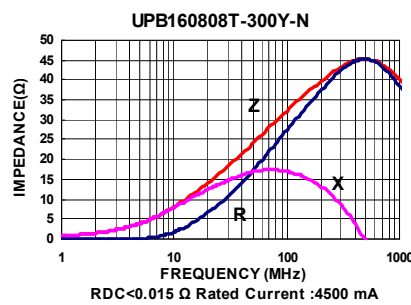
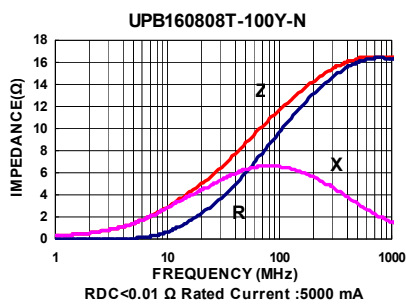

Electrical Characteristics

Part Number	Test Frequency (MHz)	Impedance ($\Omega \pm 25\%$)	DC Resistance (Ω) Max	Rated current (mA) Max
UPB201209T-150Y-N	100	15	0.012	6000
UPB201209T-220Y-N	100	22	0.012	6000
UPB201209T-300Y-N	100	30	0.012	6000
UPB201209T-500Y-N	100	50	0.015	6000
UPB201209T-600Y-N	100	60	0.02	4500
UPB201209T-800Y-N	100	80	0.02	4500
UPB201209T-101Y-N	100	100	0.02	5000
UPB201209T-121Y-N	100	120	0.02	5000
UPB201209T-201Y-N	100	200	0.04	3000
UPB201209T-221Y-N	100	220	0.04	3000
UPB201209T-301Y-N	100	300	0.05	3000
UPB201209T-331Y-N	100	330	0.05	3000

Test Instruments : Agilent E4991A Impedance / Material Analyzer

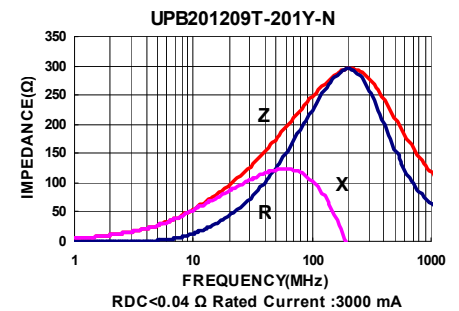
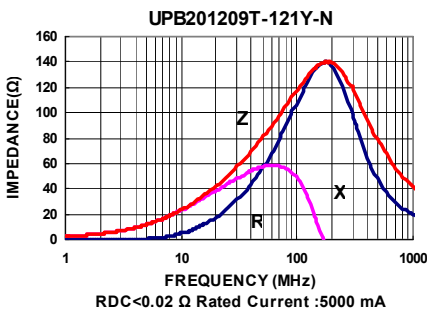
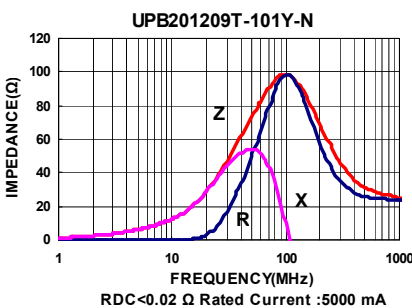
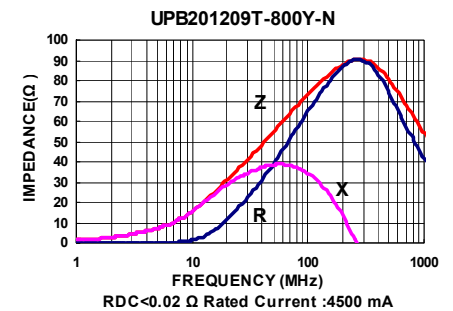
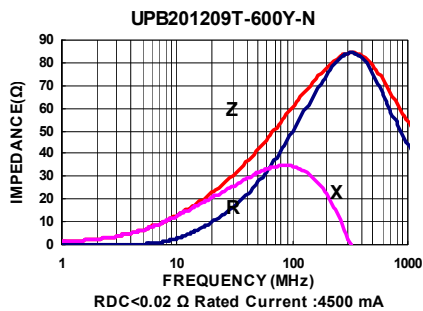
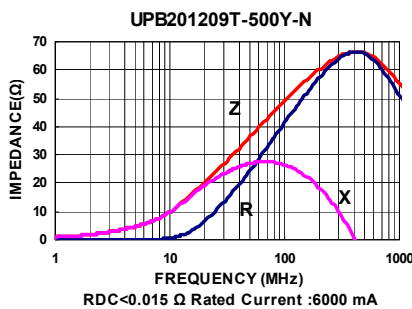
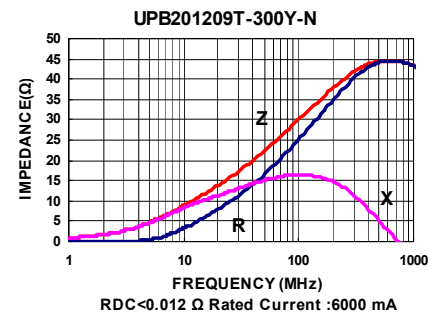
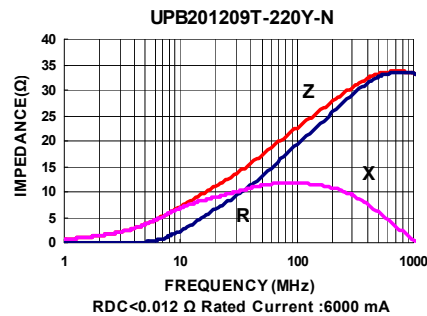
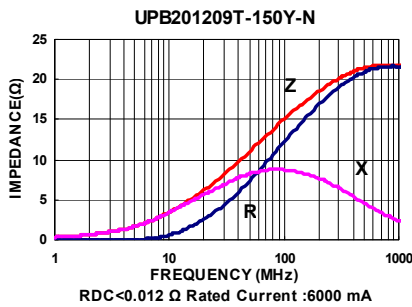

Test Instruments : Agilent E4991A Impedance / Material Analyzer

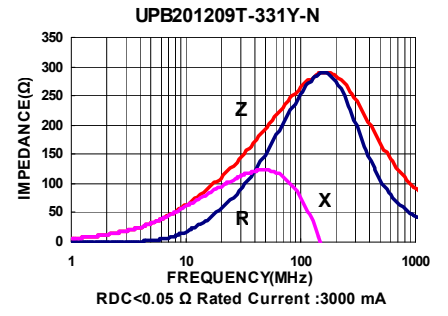
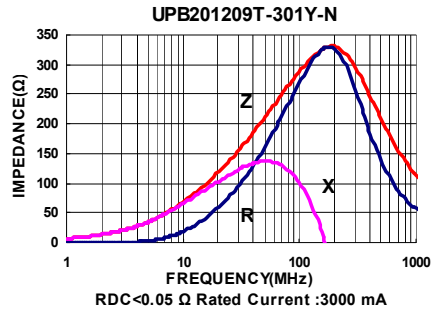
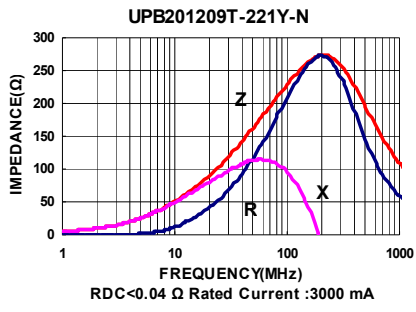

Electrical Characteristics

Part Number	Test Frequency (MHz)	Impedance ($\Omega \pm 25\%$)	DC Resistance (Ω) Max	Rated current (mA) Max
UPB201212T-500Y-N	100	50	0.018	6000
UPB201212T-600Y-N	100	60	0.018	6000
UPB201212T-700Y-N	100	70	0.018	6000
UPB201212T-800Y-N	100	80	0.020	6000
UPB201212T-900Y-N	100	90	0.025	5000
UPB201212T-101Y-N	100	100	0.025	5000
UPB201212T-121Y-N	100	120	0.025	5000

Test Instruments : Agilent E4991A Impedance / Material Analyzer

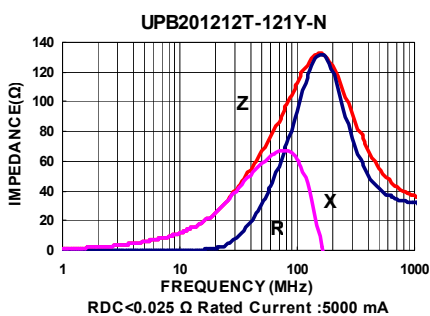
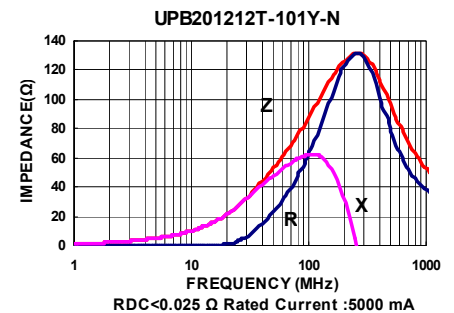
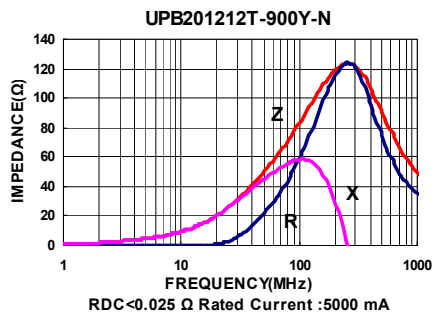
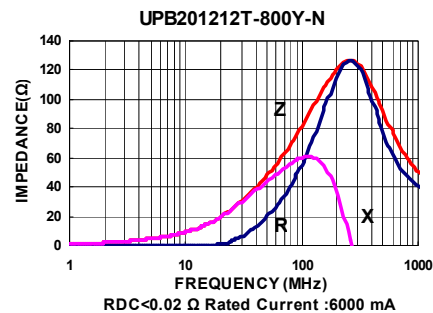
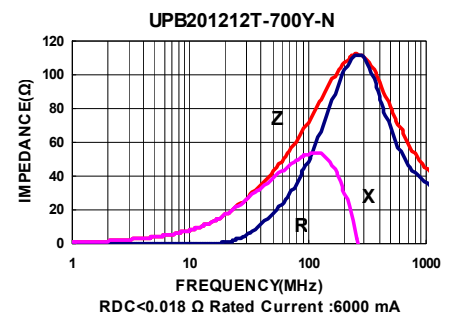
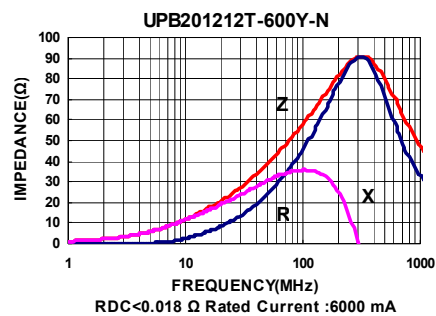
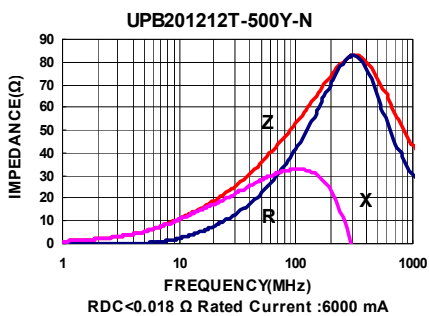

Electrical Characteristics

Part Number	Test Frequency (MHz)	Impedance ($\Omega \pm 25\%$)	DC Resistance (Ω) Max	Rated current (mA) Max
UPB321611T-110Y-N	100	11 \pm 30%	0.012	6000
UPB321611T-300Y-N	100	30	0.012	6000
UPB321611T-600Y-N	100	60	0.012	6000
UPB321611T-800Y-N	100	80	0.012	6000
UPB321611T-101Y-N	100	100	0.012	6000
UPB321611T-121Y-N	100	120	0.012	6000
UPB321611T-151Y-N	100	150	0.020	4500
UPB321611T-181Y-N	100	180	0.020	4500
UPB321611T-221Y-N	100	220	0.020	4500

Test Instruments : Agilent E4991A Impedance / Material Analyzer

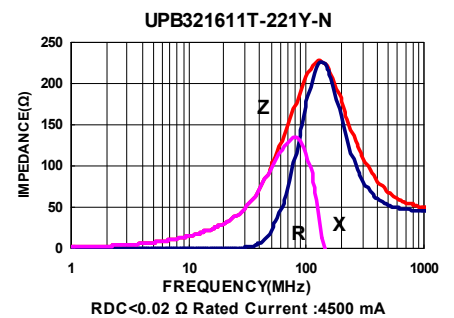
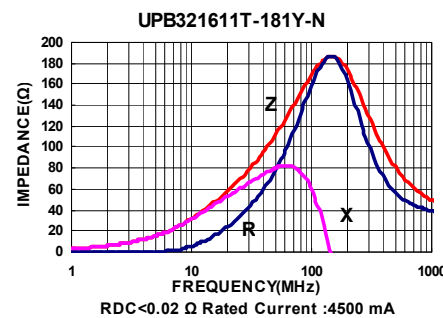
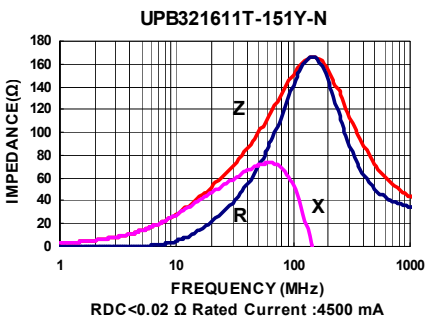
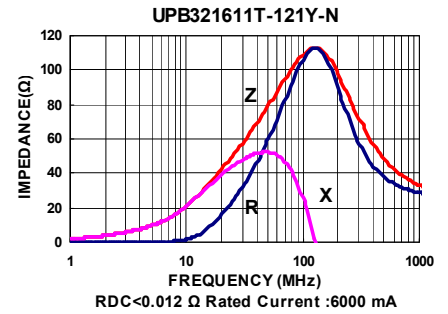
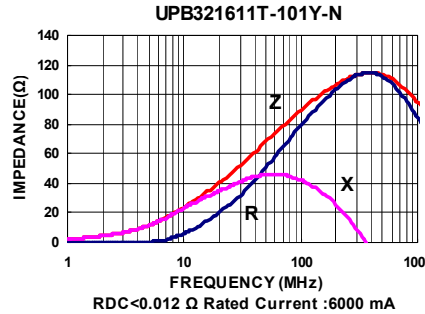
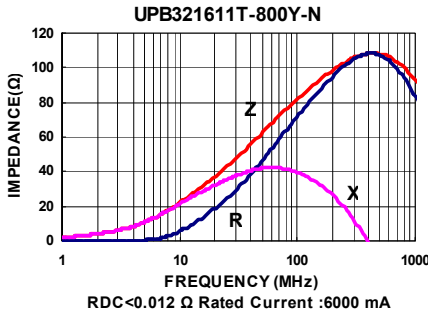
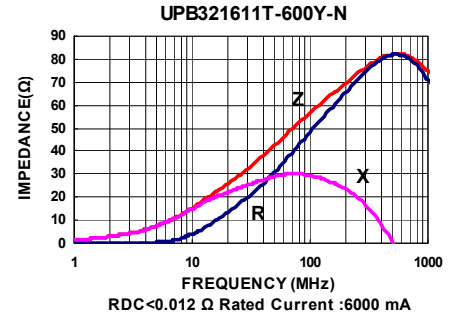
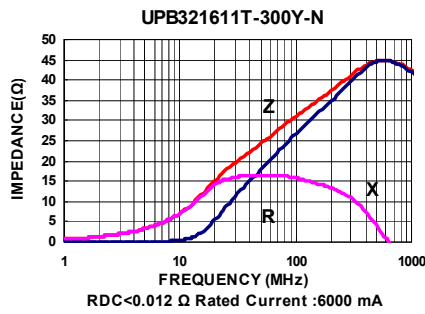
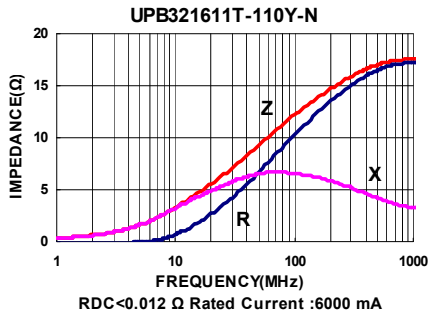

Electrical Characteristics

Part Number	Test Frequency (MHz)	Impedance ($\Omega \pm 25\%$)	DC Resistance (Ω) Max	Rated current (mA) Max
UPB451616T-600Y-N	100	60	0.012	7000
UPB451616T-111Y-N	100	110	0.020	4000

Test Instruments : Agilent E4991A Impedance / Material Analyzer

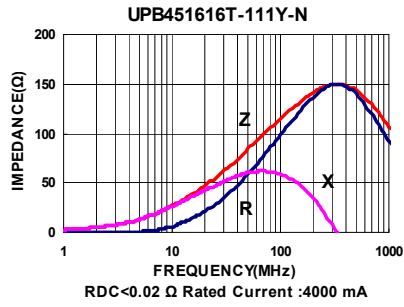
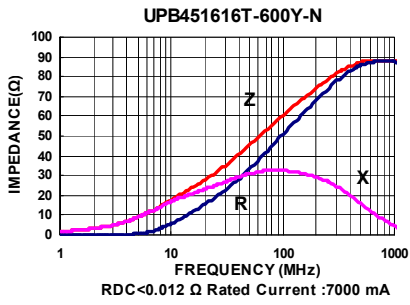

Electrical Characteristics

Part Number	Test Frequency (MHz)	Impedance ($\Omega \pm 25\%$)	DC Resistance (Ω) Max	Rated current (mA) Max
UPB453215T-400Y-N	100	40	0.010	10000
UPB453215T-560Y-N	100	56	0.010	10000
UPB453215T-700Y-N	100	70	0.010	9000
UPB453215T-800Y-N	100	80	0.010	9000
UPB453215T-900Y-N	100	90	0.015	6000
UPB453215T-121Y-N	100	120	0.020	6000
UPB453215T-151Y-N	100	150	0.020	6000

Test Instruments : Agilent E4991A Impedance / Material Analyzer

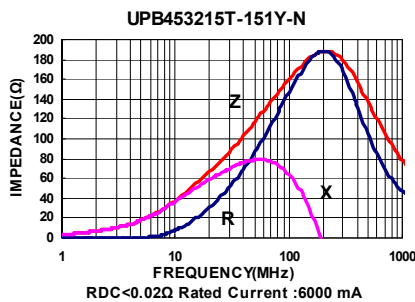
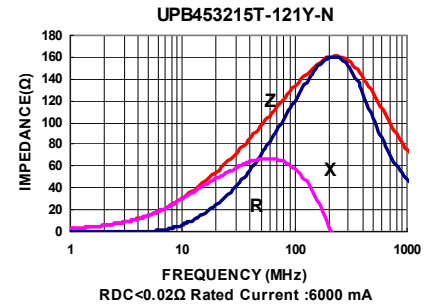
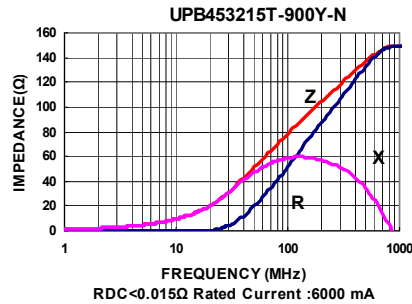
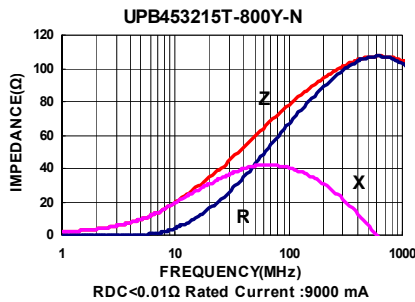
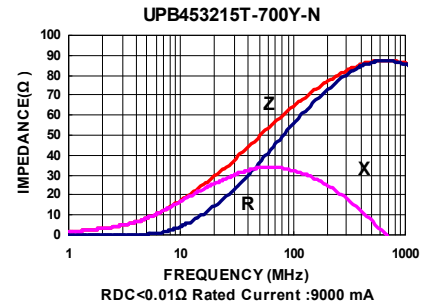
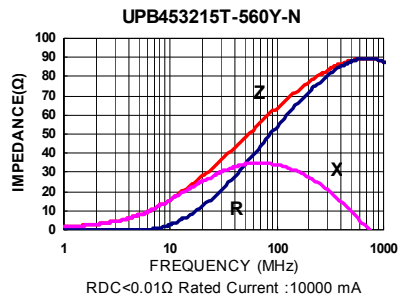
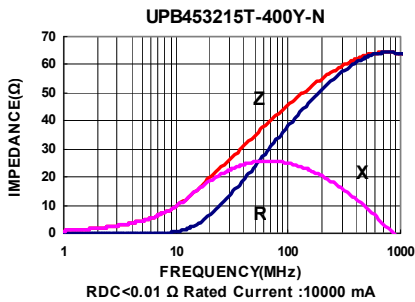

Packaging Specifications

Tape Dimensions

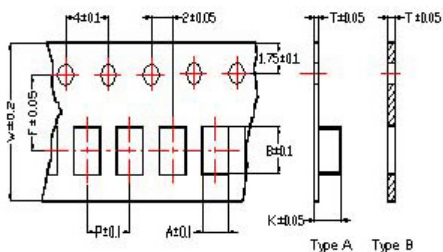

Tape Material

Carrier Tape: Polycarbonate (Tape A)
Carrier Tape: Paper (Tape B)
Cover Tape: Polystyrene

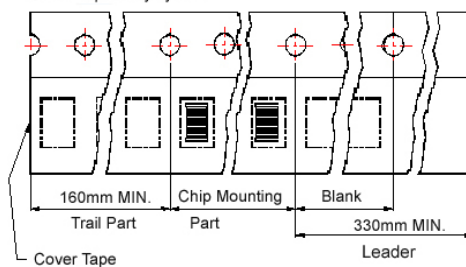

Reel Dimensions

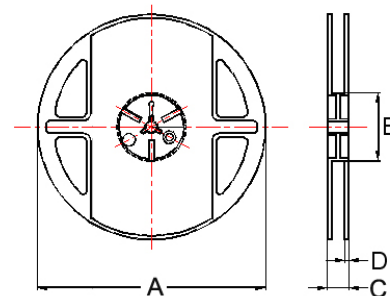

- ① : SB / PB / NB ② : SB / PB / NB / HF ③ : SB / PB
- ④ : SB / PB / NB / GB / UPB / HF / VPB ⑤ : UPB
- ⑥ : SB / PB / NB / GB / UPB ⑦ : SB ⑧ : PB / UPB

Dimensions in mm

TYPE	Tape Dimensions								Reel Dimensions				Quantity PCS / REEL
	A	B	T	W	P	F	K	Tape	A	B	C	D	
①060303	0.37	0.67	0.42	8.0	2.0	3.5	-	B	178	60	10	2	15000
②100505	0.65	1.15	0.60	8.0	2.0	3.5	-	B	178	60	12	2	10000
③160808	1.05	1.85	0.95	8.0	4.0	3.5	-	B	178	60	12	2	4000
④201209	1.50	2.30	0.97	8.0	4.0	3.5	-	B	178	60	12	2	4000
⑤201212	1.35	2.25	0.22	8.0	4.0	3.5	1.35	A	178	60	12	2	3000
④321611	1.88	3.50	0.22	8.0	4.0	3.5	1.27	A	178	60	12	2	3000
⑥321616	1.88	3.53	0.22	8.0	4.0	3.5	1.80	A	178	60	12	2	2000
⑦322513	2.77	3.42	0.22	8.0	4.0	3.5	1.55	A	178	60	12	2	2500
⑧451616	1.93	4.95	0.24	12	4.0	5.5	1.93	A	178	60	14	2	2000
⑨453215	3.66	4.95	0.24	12	8.0	5.5	1.85	A	178	60	14	2	1000

Multilayer Ferrite Chip Beads



Chilisin offers a wide range of multi-layered ferrite chip beads with various sizes, frequency characteristics, and impedance values for EMI solutions. These ferrite formulas are used to compose seven types of EMI suppression chip beads: SB, GB, PB, UPB, NB, HF, and VPB series.

Product Identification

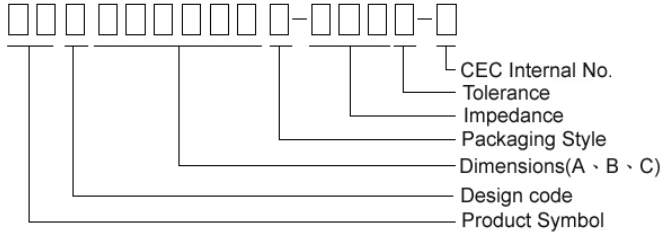

- Product symbol: SB, GB, PB, UPB, NB, HF, VPB
- Packaging: T : Tape and Reel ; B : Bulk
- Tolerance: Y = $\pm 25\%$; M = $\pm 20\%$; T: $\pm 30\%$
- Note: RoHS Compliant

Shape and Dimensions

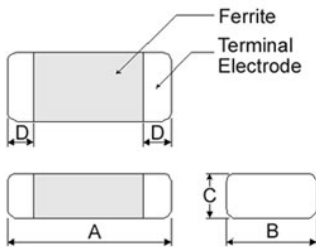

Dimensions in mm

TYPE	A	B	C	D
①060303	0.6 \pm 0.03	0.30 \pm 0.03	0.3 \pm 0.03	0.15 \pm 0.05
②100505	1.0 \pm 0.10	0.50 \pm 0.10	0.5 \pm 0.10	0.25 \pm 0.10
③160808	1.6 \pm 0.15	0.80 \pm 0.15	0.8 \pm 0.15	0.3 \pm 0.2
④201209	2.0 \pm 0.20	1.25 \pm 0.20	0.9 \pm 0.20	0.5 \pm 0.3
⑤201212	2.0 \pm 0.20	1.25 \pm 0.20	1.25 \pm 0.20	0.5 \pm 0.3
④321611	3.2 \pm 0.20	1.60 \pm 0.20	1.1 \pm 0.20	0.5 \pm 0.3
⑥321616	3.2 \pm 0.20	1.60 \pm 0.20	1.6 \pm 0.20	0.5 \pm 0.3
⑦322513	3.2 \pm 0.20	2.50 \pm 0.20	1.3 \pm 0.20	0.5 \pm 0.3
⑧451616	4.5 \pm 0.25	1.60 \pm 0.20	1.6 \pm 0.20	0.5 \pm 0.3
⑧453215	4.5 \pm 0.25	3.20 \pm 0.20	1.5 \pm 0.20	0.5 \pm 0.3

- ① : SB / PB / NB ② : SB / PB / NB / HF ⑦ : SB / PB
 ③ : SB / PB / NB / GB / UPB / HF / VPB ⑤ : UPB ⑥ : SB
 ④ : SB / PB / NB / GB / UPB ⑧ : PB / UPB

Recommended Pattern

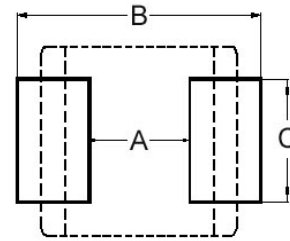

Dimensions in mm

TYPE	A	B	C
①060303	0.2 ~ 0.3	0.75 ~ 1.05	0.3
②100505	0.4	1.2 ~ 1.4	0.5
③160808	0.7 ~ 0.8	1.8 ~ 2.0	0.6 ~ 0.8
④201209	1.0 ~ 1.2	2.6 ~ 4.0	1.0 ~ 1.2
⑤201212	1.0 ~ 1.2	2.6 ~ 4.0	1.0 ~ 1.2
④321611	2.0	4.2 ~ 5.2	1.2
⑥321616	2.0	4.2 ~ 5.2	1.2
⑦322513	2.0	5.5 ~ 6.5	1.8
⑧451616	3.0	5.5 ~ 6.5	1.2
⑧453215	3.0	5.5 ~ 6.5	2.4

- * Don't apply narrower pattern than listed above to PB and UPB. Narrow pattern might cause excessive heat or open circuit.

Dimension Conversion

Code	Dimension in mm (AxBxC)	EIA
060303	0.6X0.3X0.3	0201
100505	1.0X0.5X0.5	0402
160808	1.6x0.8x0.8	0603
201209	2.0x1.2x0.9	0805
201212	2.0x1.2x1.25	0805
321611	3.2x1.6x1.1	1206
321616	3.2x1.6x1.6	1206
322513	3.2x2.5x1.3	1210
451616	4.5x1.6x1.6	1806
453215	4.5x3.2x1.5	1812

Electrical Characteristics

Part Number	Test Frequency (MHz)	Impedance ($\Omega \pm 25\%$)	Test Frequency (MHz)	Impedance ($\Omega \pm 40\%$)	DC Resistance (Ω) Max	Rated current (mA) Max
HFY100505T-221Y-N	100	220	1000	270	0.55	450
HFY100505T-301Y-N	100	300	1000	450	0.55	350
HFY100505T-471Y-N	100	470	1000	650	0.60	300
HFY100505T-601Y-N	100	600	1000	1000	0.7	300
HFY100505T-102Y-N	100	1000	1000	1400	1.1	250

Test Instruments : Agilent E4991A Impedance / Material Analyzer

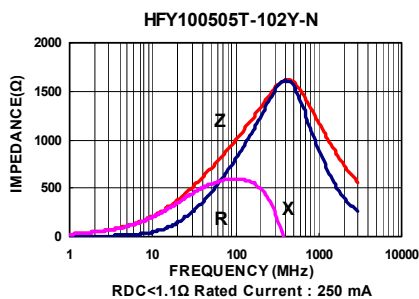
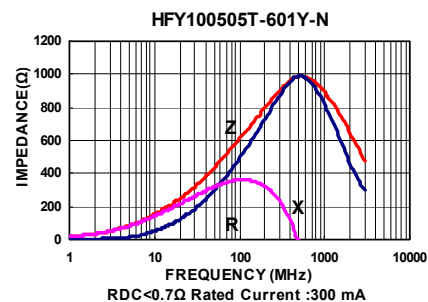
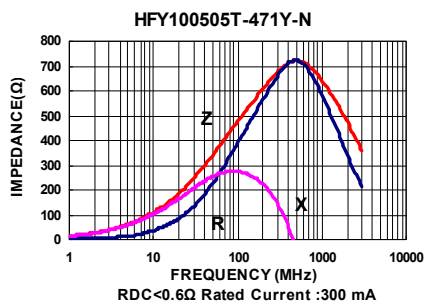
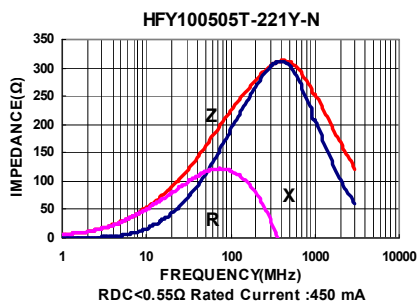

Packaging Specifications

Tape Dimensions

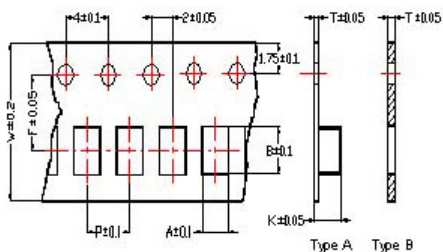

Tape Material

Carrier Tape: Polycarbonate (Tape A)
 Carrier Tape: Paper (Tape B)
 Cover Tape: Polystyrene

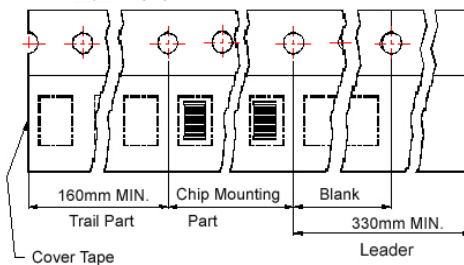

Reel Dimensions

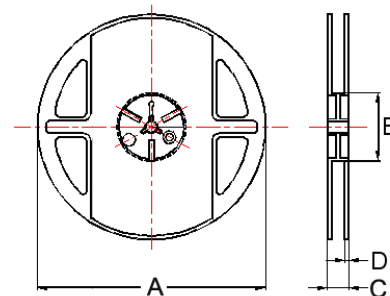

- ① : SB / PB / NB ② : SB / PB / NB / HF ③ : SB / PB
- ④ : SB / PB / NB / GB / UPB / HF / VPB ⑤ : UPB
- ⑥ : SB / PB / NB / GB / UPB ⑦ : SB ⑧ : PB / UPB

Dimensions in mm

TYPE	Tape Dimensions								Reel Dimensions				Quantity PCS / REEL
	A	B	T	W	P	F	K	Tape	A	B	C	D	
①060303	0.37	0.67	0.42	8.0	2.0	3.5	-	B	178	60	10	2	15000
②100505	0.65	1.15	0.60	8.0	2.0	3.5	-	B	178	60	12	2	10000
③160808	1.05	1.85	0.95	8.0	4.0	3.5	-	B	178	60	12	2	4000
④201209	1.50	2.30	0.97	8.0	4.0	3.5	-	B	178	60	12	2	4000
⑤201212	1.35	2.25	0.22	8.0	4.0	3.5	1.35	A	178	60	12	2	3000
④321611	1.88	3.50	0.22	8.0	4.0	3.5	1.27	A	178	60	12	2	3000
⑥321616	1.88	3.53	0.22	8.0	4.0	3.5	1.80	A	178	60	12	2	2000
⑦322513	2.77	3.42	0.22	8.0	4.0	3.5	1.55	A	178	60	12	2	2500
⑧451616	1.93	4.95	0.24	12	4.0	5.5	1.93	A	178	60	14	2	2000
⑨453215	3.66	4.95	0.24	12	8.0	5.5	1.85	A	178	60	14	2	1000

Multilayer Ferrite Chip Beads



Chilisin offers a wide range of multi-layered ferrite chip beads with various sizes, frequency characteristics, and impedance values for EMI solutions. These ferrite formulas are used to compose seven types of EMI suppression chip beads: SB, GB, PB, UPB, NB, HF, and VPB series.

Product Identification

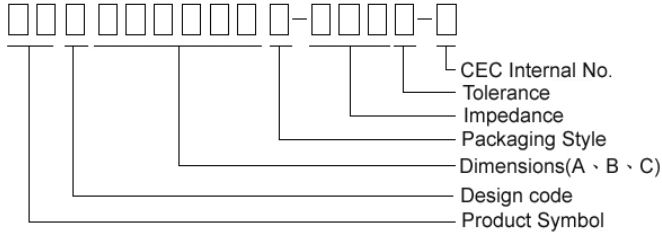

- Product symbol: SB, GB, PB, UPB, NB, HF, VPB
- Packaging: T : Tape and Reel ; B : Bulk
- Tolerance: Y = $\pm 25\%$; M = $\pm 20\%$; T: $\pm 30\%$
- Note: RoHS Compliant

Shape and Dimensions

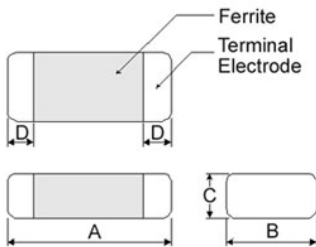

Dimensions in mm

TYPE	A	B	C	D
①060303	0.6 \pm 0.03	0.30 \pm 0.03	0.3 \pm 0.03	0.15 \pm 0.05
②100505	1.0 \pm 0.10	0.50 \pm 0.10	0.5 \pm 0.10	0.25 \pm 0.10
③160808	1.6 \pm 0.15	0.80 \pm 0.15	0.8 \pm 0.15	0.3 \pm 0.2
④201209	2.0 \pm 0.20	1.25 \pm 0.20	0.9 \pm 0.20	0.5 \pm 0.3
⑤201212	2.0 \pm 0.20	1.25 \pm 0.20	1.25 \pm 0.20	0.5 \pm 0.3
④321611	3.2 \pm 0.20	1.60 \pm 0.20	1.1 \pm 0.20	0.5 \pm 0.3
⑥321616	3.2 \pm 0.20	1.60 \pm 0.20	1.6 \pm 0.20	0.5 \pm 0.3
⑦322513	3.2 \pm 0.20	2.50 \pm 0.20	1.3 \pm 0.20	0.5 \pm 0.3
⑧451616	4.5 \pm 0.25	1.60 \pm 0.20	1.6 \pm 0.20	0.5 \pm 0.3
⑧453215	4.5 \pm 0.25	3.20 \pm 0.20	1.5 \pm 0.20	0.5 \pm 0.3

- ① : SB / PB / NB ② : SB / PB / NB / HF ⑦ : SB / PB
 ③ : SB / PB / NB / GB / UPB / HF / VPB ⑤ : UPB ⑥ : SB
 ④ : SB / PB / NB / GB / UPB ⑧ : PB / UPB

Recommended Pattern

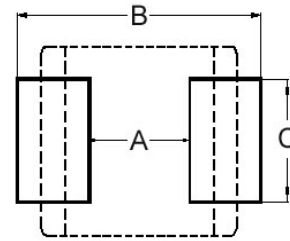

Dimensions in mm

TYPE	A	B	C
①060303	0.2 ~ 0.3	0.75 ~ 1.05	0.3
②100505	0.4	1.2 ~ 1.4	0.5
③160808	0.7 ~ 0.8	1.8 ~ 2.0	0.6 ~ 0.8
④201209	1.0 ~ 1.2	2.6 ~ 4.0	1.0 ~ 1.2
⑤201212	1.0 ~ 1.2	2.6 ~ 4.0	1.0 ~ 1.2
④321611	2.0	4.2 ~ 5.2	1.2
⑥321616	2.0	4.2 ~ 5.2	1.2
⑦322513	2.0	5.5 ~ 6.5	1.8
⑧451616	3.0	5.5 ~ 6.5	1.2
⑧453215	3.0	5.5 ~ 6.5	2.4

- * Don't apply narrower pattern than listed above to PB and UPB. Narrow pattern might cause excessive heat or open circuit.

Dimension Conversion

Code	Dimension in mm (AxBxC)	EIA
060303	0.6X0.3X0.3	0201
100505	1.0X0.5X0.5	0402
160808	1.6x0.8x0.8	0603
201209	2.0x1.2x0.9	0805
201212	2.0x1.2x1.25	0805
321611	3.2x1.6x1.1	1206
321616	3.2x1.6x1.6	1206
322513	3.2x2.5x1.3	1210
451616	4.5x1.6x1.6	1806
453215	4.5x3.2x1.5	1812

Electrical Characteristics

Part Number	Test Frequency (MHz)	Impedance ($\Omega \pm 25\%$)	Test Frequency (MHz)	Impedance ($\Omega \pm 40\%$)	DC Resistance (Ω) Max	Rated current (mA) Max
HFJ100505T-601Y-N	100	600	1000	1400	0.85	300
HFJ100505T-102Y-N	100	1000	1000	2000	1.25	250
HFJ100505T-152Y-N	100	1500	1000	2400	1.80	230
HFJ100505T-182Y-N	100	1800	1000	2700	2.20	200

Test Instruments : Agilent E4991A Impedance / Material Analyzer

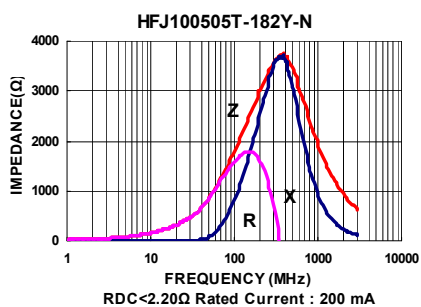
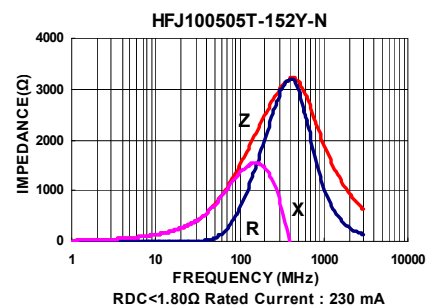
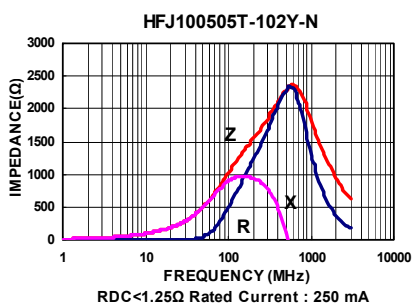
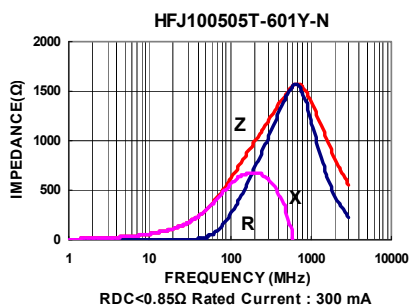

Packaging Specifications

Tape Dimensions

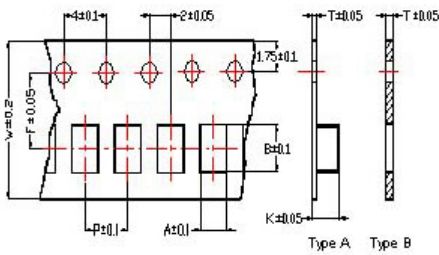

Tape Material

Carrier Tape: Polycarbonate (Tape A)
Carrier Tape: Paper (Tape B)
Cover Tape: Polystyrene

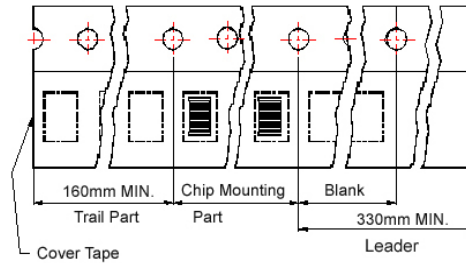

Reel Dimensions

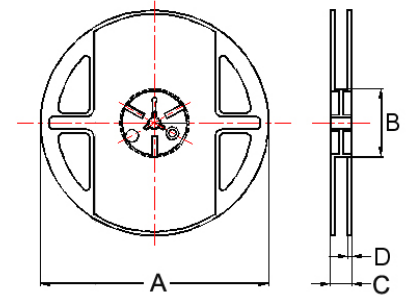

- ① : SB / PB / NB ② : SB / PB / NB / HF ③ : SB / PB
- ④ : SB / PB / NB / GB / UPB / HF / VPB ⑤ : UPB
- ⑥ : SB / PB / NB / GB / UPB ⑦ : SB ⑧ : PB / UPB

Dimensions in mm

TYPE	Tape Dimensions								Reel Dimensions				Quantity PCS / REEL
	A	B	T	W	P	F	K	Tape	A	B	C	D	
①060303	0.37	0.67	0.42	8.0	2.0	3.5	-	B	178	60	10	2	15000
②100505	0.65	1.15	0.60	8.0	2.0	3.5	-	B	178	60	12	2	10000
③160808	1.05	1.85	0.95	8.0	4.0	3.5	-	B	178	60	12	2	4000
④201209	1.50	2.30	0.97	8.0	4.0	3.5	-	B	178	60	12	2	4000
⑤201212	1.35	2.25	0.22	8.0	4.0	3.5	1.35	A	178	60	12	2	3000
④321611	1.88	3.50	0.22	8.0	4.0	3.5	1.27	A	178	60	12	2	3000
⑥321616	1.88	3.53	0.22	8.0	4.0	3.5	1.80	A	178	60	12	2	2000
⑦322513	2.77	3.42	0.22	8.0	4.0	3.5	1.55	A	178	60	12	2	2500
⑧451616	1.93	4.95	0.24	12	4.0	5.5	1.93	A	178	60	14	2	2000
⑨453215	3.66	4.95	0.24	12	8.0	5.5	1.85	A	178	60	14	2	1000

Multilayer Ferrite Chip Beads



Chilisin offers a wide range of multi-layered ferrite chip beads with various sizes, frequency characteristics, and impedance values for EMI solutions. These ferrite formulas are used to compose seven types of EMI suppression chip beads: SB, GB, PB, UPB, NB, HF, and VPB series.

Product Identification

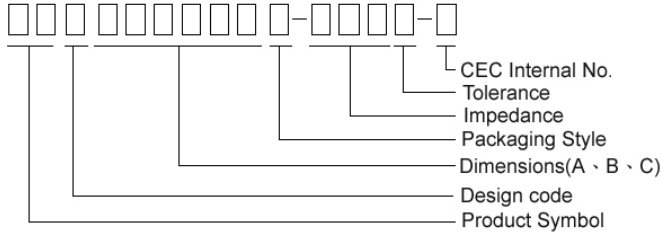

- Product symbol: SB, GB, PB, UPB, NB, HF, VPB
- Packaging: T : Tape and Reel ; B : Bulk
- Tolerance: Y = $\pm 25\%$; M = $\pm 20\%$; T: $\pm 30\%$
- Note: RoHS Compliant

Shape and Dimensions

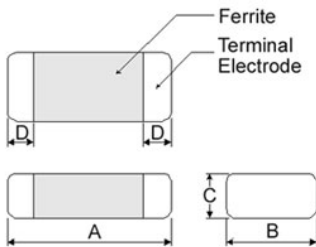

Dimensions in mm

TYPE	A	B	C	D
①060303	0.6 \pm 0.03	0.30 \pm 0.03	0.3 \pm 0.03	0.15 \pm 0.05
②100505	1.0 \pm 0.10	0.50 \pm 0.10	0.5 \pm 0.10	0.25 \pm 0.10
③160808	1.6 \pm 0.15	0.80 \pm 0.15	0.8 \pm 0.15	0.3 \pm 0.2
④201209	2.0 \pm 0.20	1.25 \pm 0.20	0.9 \pm 0.20	0.5 \pm 0.3
⑤201212	2.0 \pm 0.20	1.25 \pm 0.20	1.25 \pm 0.20	0.5 \pm 0.3
④321611	3.2 \pm 0.20	1.60 \pm 0.20	1.1 \pm 0.20	0.5 \pm 0.3
⑥321616	3.2 \pm 0.20	1.60 \pm 0.20	1.6 \pm 0.20	0.5 \pm 0.3
⑦322513	3.2 \pm 0.20	2.50 \pm 0.20	1.3 \pm 0.20	0.5 \pm 0.3
⑧451616	4.5 \pm 0.25	1.60 \pm 0.20	1.6 \pm 0.20	0.5 \pm 0.3
⑧453215	4.5 \pm 0.25	3.20 \pm 0.20	1.5 \pm 0.20	0.5 \pm 0.3

- ① : SB / PB / NB ② : SB / PB / NB / HF ⑦ : SB / PB
 ③ : SB / PB / NB / GB / UPB / HF / VPB ⑤ : UPB ⑥ : SB
 ④ : SB / PB / NB / GB / UPB ⑧ : PB / UPB

Recommended Pattern

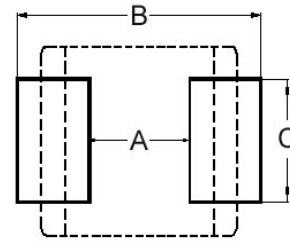

Dimensions in mm

TYPE	A	B	C
①060303	0.2 ~ 0.3	0.75 ~ 1.05	0.3
②100505	0.4	1.2 ~ 1.4	0.5
③160808	0.7 ~ 0.8	1.8 ~ 2.0	0.6 ~ 0.8
④201209	1.0 ~ 1.2	2.6 ~ 4.0	1.0 ~ 1.2
⑤201212	1.0 ~ 1.2	2.6 ~ 4.0	1.0 ~ 1.2
④321611	2.0	4.2 ~ 5.2	1.2
⑥321616	2.0	4.2 ~ 5.2	1.2
⑦322513	2.0	5.5 ~ 6.5	1.8
⑧451616	3.0	5.5 ~ 6.5	1.2
⑧453215	3.0	5.5 ~ 6.5	2.4

- * Don't apply narrower pattern than listed above to PB and UPB. Narrow pattern might cause excessive heat or open circuit.

Dimension Conversion

Code	Dimension in mm (AxBxC)	EIA
060303	0.6X0.3X0.3	0201
100505	1.0X0.5X0.5	0402
160808	1.6x0.8x0.8	0603
201209	2.0x1.2x0.9	0805
201212	2.0x1.2x1.25	0805
321611	3.2x1.6x1.1	1206
321616	3.2x1.6x1.6	1206
322513	3.2x2.5x1.3	1210
451616	4.5x1.6x1.6	1806
453215	4.5x3.2x1.5	1812

Electrical Characteristics

Part Number	Test Frequency (MHz)	Impedance ($\Omega \pm 25\%$)	Test Frequency (MHz)	Impedance ($\Omega \pm 40\%$)	DC Resistance (Ω) Max	Rated current (mA) Max
HFY100505T-121Y-NP	100	120	1000	150	0.095	1500
HFY100505T-221Y-NP	100	220	1000	270	0.280	700

Test Instruments : Agilent E4991A Impedance / Material Analyzer

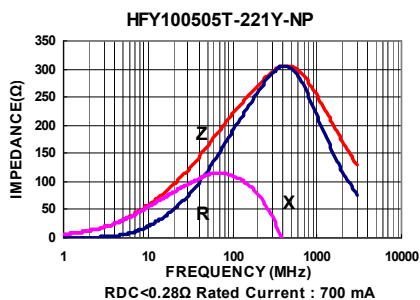
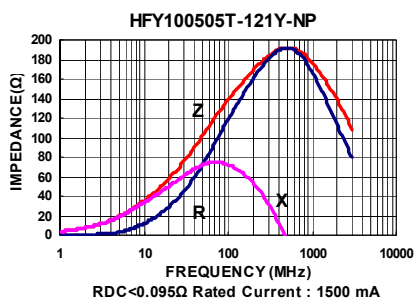

Packaging Specifications

Tape Dimensions

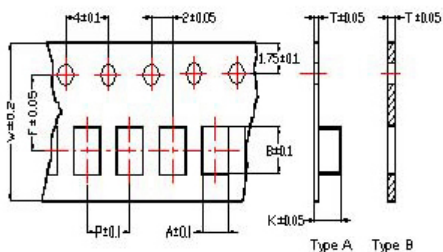

Tape Material

Carrier Tape: Polycarbonate (Tape A)
 Carrier Tape: Paper (Tape B)
 Cover Tape: Polystyrene

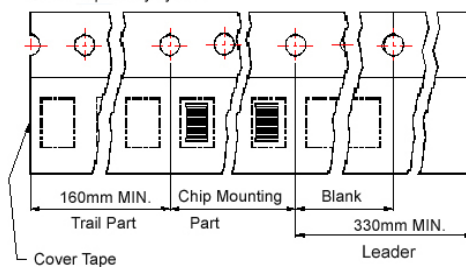

Reel Dimensions

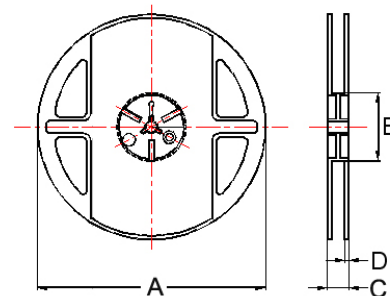

- ① : SB / PB / NB ② : SB / PB / NB / HF ③ : SB / PB
- ④ : SB / PB / NB / GB / UPB / HF / VPB ⑤ : UPB
- ⑥ : SB / PB / NB / GB / UPB ⑦ : SB ⑧ : PB / UPB

Dimensions in mm

TYPE	Tape Dimensions								Reel Dimensions				Quantity PCS / REEL
	A	B	T	W	P	F	K	Tape	A	B	C	D	
①060303	0.37	0.67	0.42	8.0	2.0	3.5	-	B	178	60	10	2	15000
②100505	0.65	1.15	0.60	8.0	2.0	3.5	-	B	178	60	12	2	10000
③160808	1.05	1.85	0.95	8.0	4.0	3.5	-	B	178	60	12	2	4000
④201209	1.50	2.30	0.97	8.0	4.0	3.5	-	B	178	60	12	2	4000
⑤201212	1.35	2.25	0.22	8.0	4.0	3.5	1.35	A	178	60	12	2	3000
④321611	1.88	3.50	0.22	8.0	4.0	3.5	1.27	A	178	60	12	2	3000
⑥321616	1.88	3.53	0.22	8.0	4.0	3.5	1.80	A	178	60	12	2	2000
⑦322513	2.77	3.42	0.22	8.0	4.0	3.5	1.55	A	178	60	12	2	2500
⑧451616	1.93	4.95	0.24	12	4.0	5.5	1.93	A	178	60	14	2	2000
⑨453215	3.66	4.95	0.24	12	8.0	5.5	1.85	A	178	60	14	2	1000

CMF Series



The CMF series is a type of common mode filter designed and produced using the multilayer technology. The multilayer construction allows for excellent noise suppression for signal lines used in high-speed and high-density digital equipment such as personal computers, facsimiles, DSC, STB, etc. Both standard series and custom-design products are available.

Features

- Multilayer construction for effective suppression of common mode noise at high frequency
- Excellent solderability
- Compact design

Applications

- High speed interfaces (IEEE1394, USB2.0, and LVDS) in electronic devices
- PDP, LCD TV, DVD player, PC, Audio player, DSC
- Digital audio and video equipment such as PDAs, DVC, CD player, MD player, etc.

Product Identification

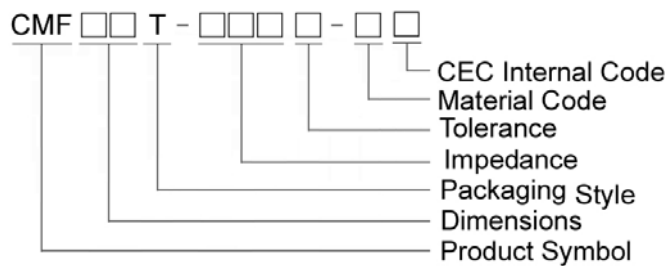

Shape and Dimensions

CMF11

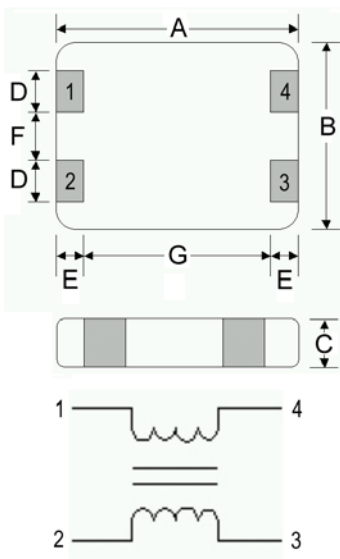

CMF21

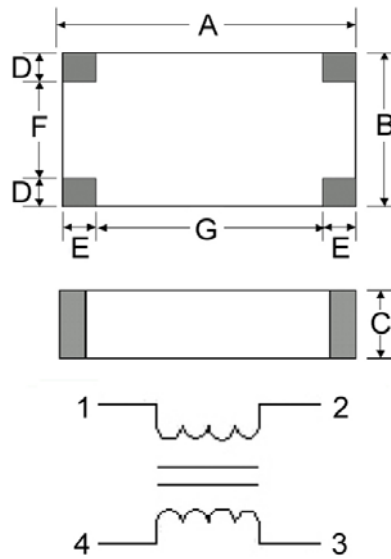

Dimensions in mm

TYPE	A	B	C	D	E	F	G
CMF11	1.25±0.15	1.00±0.15	0.60±0.15	0.30±0.15	0.20±0.15	0.25±0.15	0.85±0.15
CMF21	2.00±0.20	1.25±0.20	1.00±0.20	0.35±0.10	0.40±0.10	0.55±0.20	1.20±0.20

Recommended Pattern

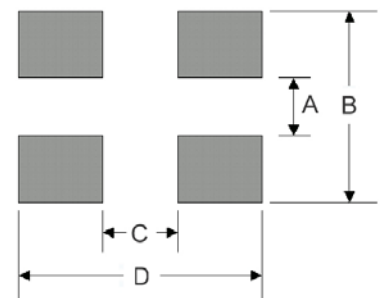

Dimensions in mm

TYPE	A	B	C	D
CMF11	0.2~0.3	0.7~1.0	0.7~0.8	1.6~1.9
CMF21	0.50	1.30	0.80	2.60

Electrical Characteristics

Part Number	Impedance (Ω)	Test Frequency (MHz)	Tolerance ($\pm\%$)	RDC (Ω)Max	Rated Current (mA)Max	Rated Voltage (Vdc)Max	Insulation Resistance (M Ω) Min
CMF11T-670M-N2	67	100	20	1.35	200	10	200
CMF11T-900M-N2	90	100	20	1.45	200	10	200

- When ordering, please specify tolerance and packaging codes
- Tolerance: M = $\pm 20\%$
- Packaging: Clear tape and reel {standard}
- Z: Agilent E4991A
- Rdc (single line): CH502BC HP4338B
- Insulation Resistance: Agilent HP4339B
- Operating temperature range from -40°C to $+105^{\circ}\text{C}$. (Including self - temperature rise)

Test Instruments : Agilent E4991A Material/Impedance Analyzer

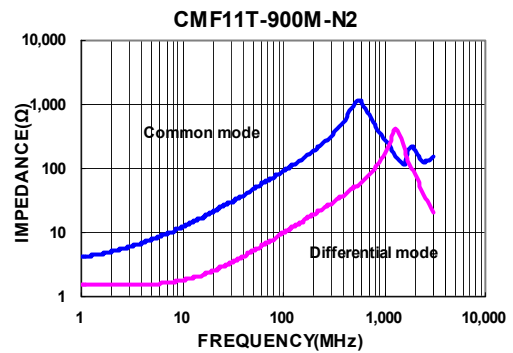
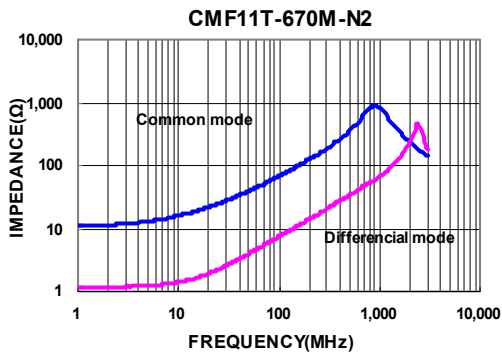

Electrical Characteristics

Part Number	Impedance (Ω)	Test Frequency (MHz)	Tolerance ($\pm\%$)	RDC (Ω)Max	Rated Current (mA)Max	Rated Voltage (Vdc)Max	Insulation Resistance (M Ω) Min
CMF21T-670M-N2	67	100	20	0.80	400	30	200
CMF21T-900M-N2	90	100	20	0.85	400	30	200
CMF21T-121M-N2	120	100	20	0.90	400	30	200

- When ordering, please specify tolerance and packaging codes
- Tolerance: M = $\pm 20\%$
- Packaging: Clear tape and reel {standard}
- Z: Agilent E4991A
- Rdc (single line): CH502BC HP4338B
- Insulation Resistance: Agilent HP4339B
- Operating temperature range from -40°C to $+105^{\circ}\text{C}$. (Including self - temperature rise)

Test Instruments : Agilent E4991A Material/Impedance Analyzer

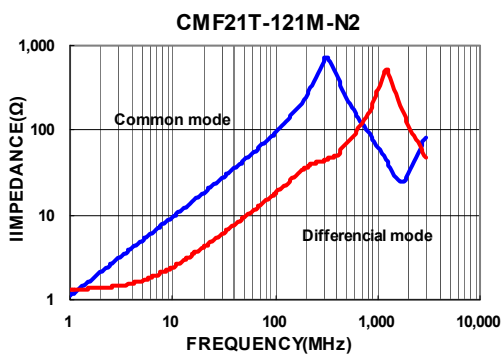
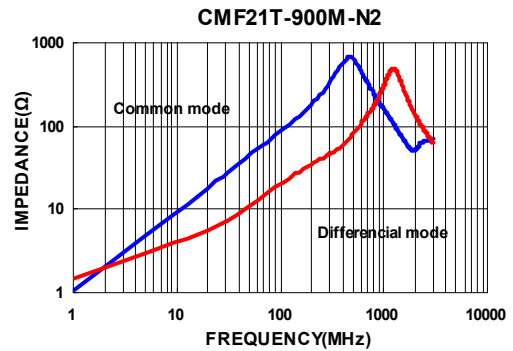
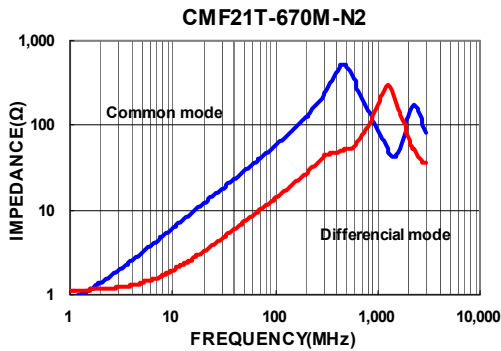

Packaging Specifications

Tape Dimensions

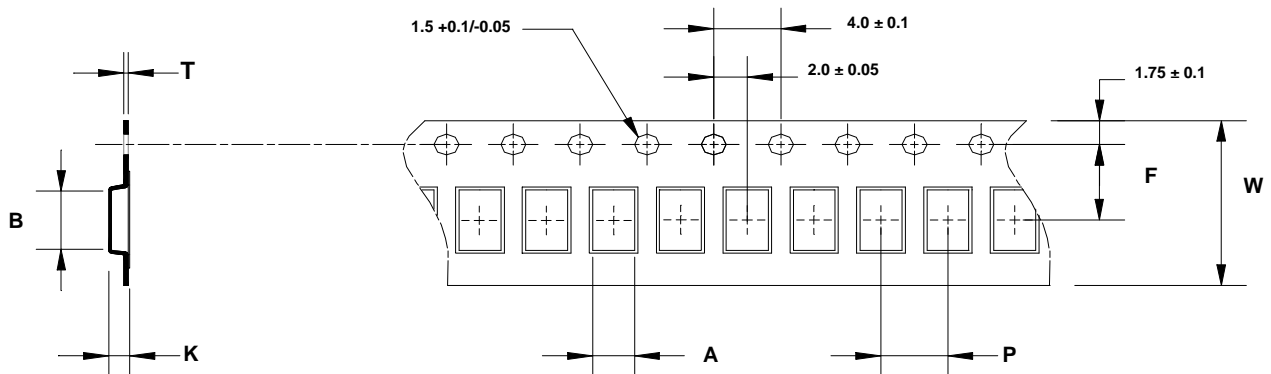

Trailer End

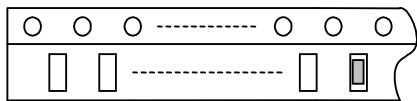

Blank part(160mm min.)

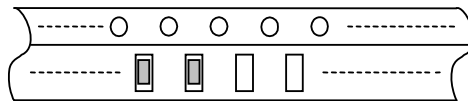

Blank Compartments with Cover Tape and Leader (330mm min.)

Leader End

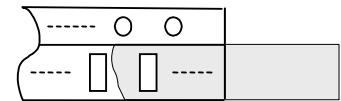

Reel Dimensions

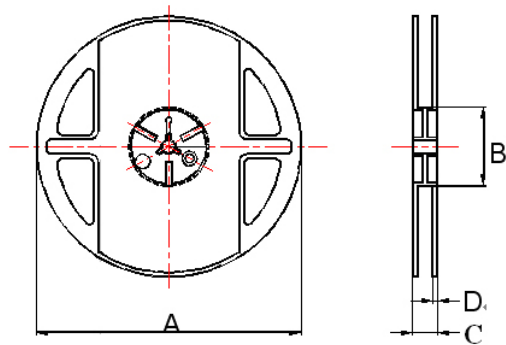

Dimensions in mm

TYPE	Tape Dimensions							Reel Dimensions				Quantity
	A	B	T	W	P	F	K	A	B	C	D	PCS / Reel
CMF11	1.15	1.50	0.25	8	4	3.5	0.72	178	60	12	1.5	4000
CMF21	1.45	2.30	0.22	8	4	3.5	1.13	178	60	12	1.5	3000

Packaging Specifications

Tape Dimensions

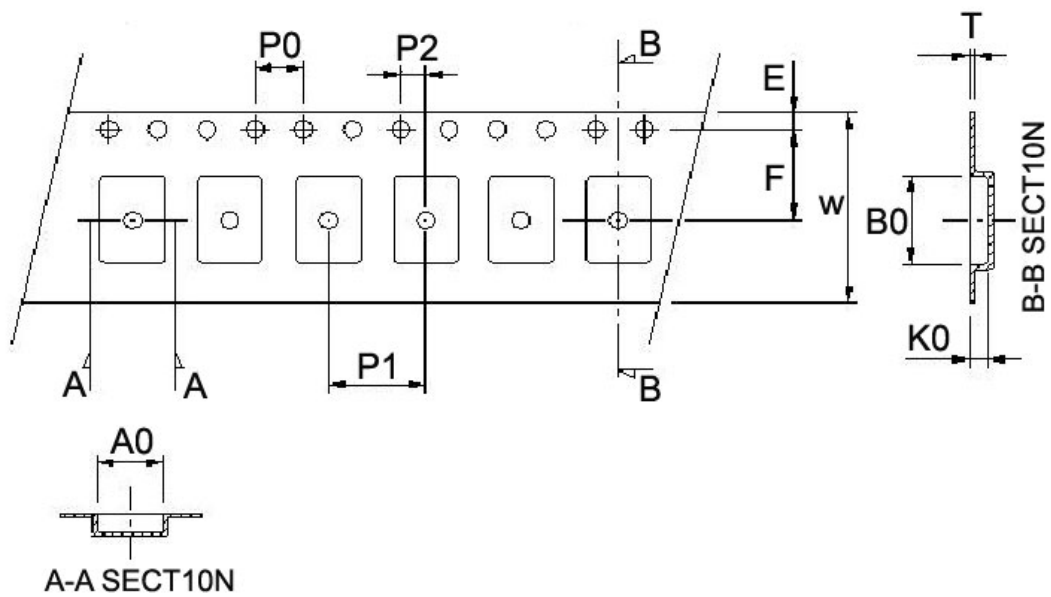

Reel Dimensions

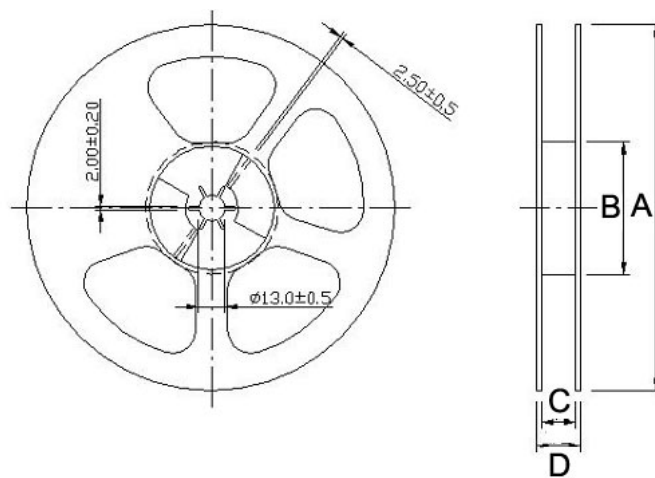

Dimensions in mm

TYPE	Tape Dimensions									Reel Dimensions				Quantity
	A0	B0	T	E	W	P1	P2	F	K0	A	B	C	D Max	PCS / REEL
CMF11	1.15	1.5	0.25	1.75	8	4	2	3.5	0.72	178	50	10	15.5	4000
CMF21	1.15	1.5	0.22	1.75	8.1	4	2	3.4	1.13	178	62	8.4	14.4	3000

CMM Series For USB 2.0, IEEE1394b, LVDS Applications



A full series of common mode choke is designed for excellent noise attenuation with compact sizing for use in wide range of applications. Both standard series and custom designs are available.

Features

- RoHS Compliant
- Miniature SMD type common mode filter for fully automated assembly
- Wide impedance range (30Ω ~ 2200Ω) for noise suppression
- Excellent solderability

Applications

- USB line for personal computers and peripheral
- IEEE 1394 line for personal computers, DVC, STB
- LVDS, panel line for liquid display panels, graph card, etc.

Product Identification

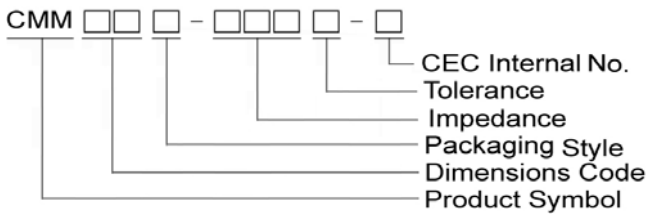

- Packaging: T : Tape and Reel

Shape and Dimensions

CMM10/ 11

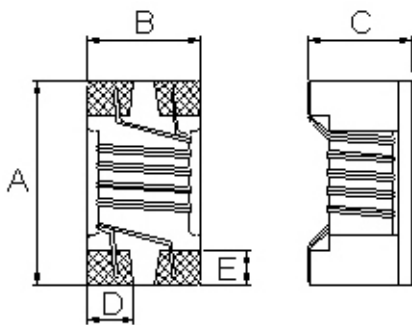

CMM21/31

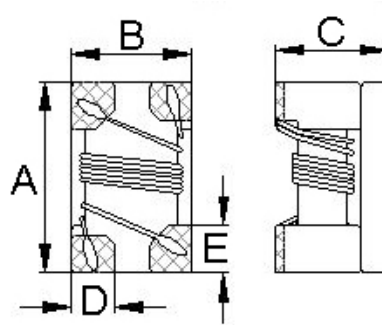

Recommended Pattern

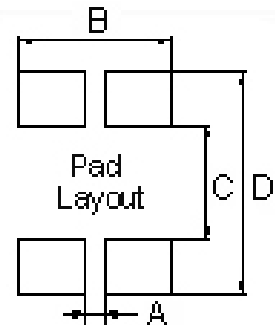

Dimensions in mm

TYPE	A	B	C	D	E
CMM10	1.60±0.2	0.80±0.2	1.10±0.2	0.25	0.33
CMM11	1.25±0.2	1.00±0.2	0.8±0.1	0.32	0.33
CMM21	2.05±0.2	1.25±0.2	1.20±0.2	0.50	0.58
CMM31	3.20±0.2	1.60±0.2	1.90±0.2	0.50	0.60

Dimensions in mm

TYPE	A	B	C	D
CMM10	0.25	0.75	0.61	2.29
CMM11	0.36	1.00	0.59	1.75
CMM21	0.50	1.27	0.80	2.60
CMM31	0.40	1.60	1.60	3.70

Electrical Characteristics

Part Number	Impedance (Ω)	Test Frequency (MHz)	Tolerance (±%)	I _{rms} (mA) Max	Rated Voltage (Vdc)	R _{dc} (Ω) Max	Insulation Resistance (MΩ) Min
CMM10T-250M-N	25	100	20,25	500	50	0.077	10
CMM10T-600M-N	60	100	20,25	500	50	0.109	10
CMM10T-900M-N	90	100	20,25	500	50	0.142	10
CMM10T-121M-N	120	100	20,25	500	50	0.160	10
CMM10T-141M-N	140	100	20,25	500	50	0.174	10
CMM10T-221M-N	220	100	20,25	500	50	0.209	10

- When ordering, please specify tolerance and packaging codes. Ex:CMM10T-600M-N
- Tolerance : M = ±20% , Y = ±25%
- Packaging : Clear tape and reel { standard }
- Z : Agilent/HP4287A+Agilent16197A
- R_{dc}(single line) :Chroma16502
- I_{rms} for 20°C rise from 25°C ambient
- Insulation Resistance : Agilent/HP4339B
- Operating temperature range from -40°C to 105°C . (Including self - temperature rise)

Test Instruments : HP4287A Material/Impedance Analyzer

Typical Impedance vs. Frequency

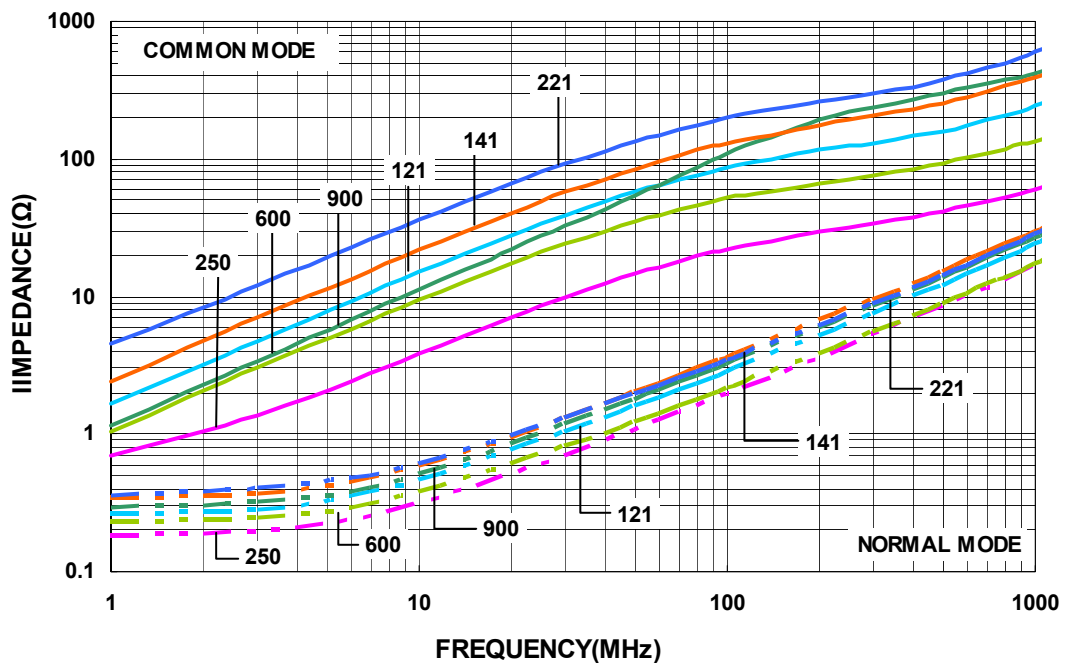

Electrical Characteristics

Part Number	Impedance (Ω)	Test Frequency (MHz)	Tolerance ($\pm\%$)	Idc (mA) Max	Rated Voltage (Vdc)	Rdc (Ω) Max	Insulation Resistance (M Ω) Min
CMM11T-600M-N	60	100	20	300	20	0.40	10
CMM11T-670M-N	67	100	20	300	50	0.25	10
CMM11T-900M-N	90	100	20	250	50	0.30	10
CMM11T-121M-N	120	100	20	200	50	0.40	10
CMM11T-161M-N	160	100	20	160	50	0.43	10

- When ordering, please specify tolerance and packaging codes. Ex:CMM11T-600M-N
- Tolerance : M = $\pm 20\%$
- Packaging : Clear tape and reel { standard }.
- Z : Agilent/HP4287A+Agilent16197A
- Rdc(single line) :Chroma16502
- Insulation Resistance : Agilent/HP4339B
- Operating temperature range from -40°C to 105°C . (Including self - temperature rise)

Test Instruments : HP4287A Material/Impedance Analyzer

Typical Impedance vs. Frequency

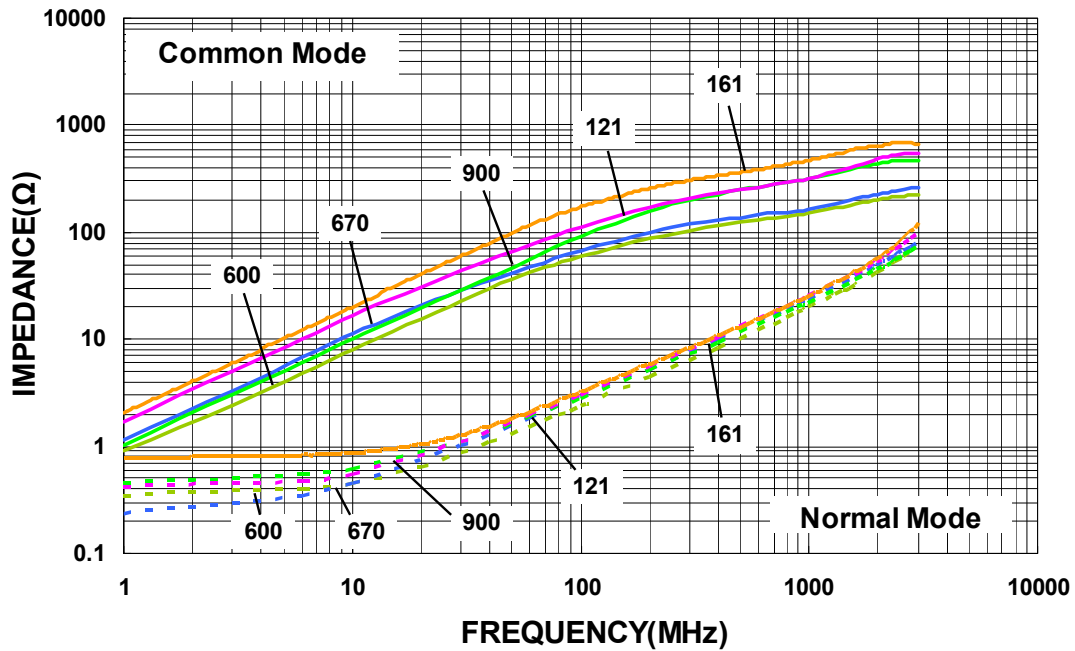

Electrical Characteristics

Part Number	Impedance (Ω)	Test Frequency (MHz)	Tolerance ($\pm\%$)	Idc (mA) Max	Rated Voltage (Vdc)	Rdc (Ω) Max	Insulation Resistance (M Ω) Min
CMM21T-300M-N	30	100	20	450	120	0.20	10
CMM21T-670M-N	67	100	20	400	120	0.25	10
CMM21T-900M-N	90	100	20	330	120	0.35	10
CMM21T-121M-N	120	100	20	400	120	0.30	10
CMM21T-161M-N	160	100	20	350	120	0.35	10
CMM21T-181M-N	180	100	20	330	120	0.35	10
CMM21T-201M-N	200	100	20	330	120	0.35	10
CMM21T-221M-N	220	100	20	310	120	0.35	10
CMM21T-261M-N	260	100	20	300	120	0.40	10
CMM21T-301M-N	300	100	20	290	120	0.40	10
CMM21T-361M-N	360	100	20	280	120	0.45	10
CMM21T-371M-N	370	100	20	280	120	0.45	10
CMM21T-501M-N	500	100	20	170	120	0.55	10
CMM21T-671M-N	670	100	20	140	120	0.60	10
CMM21T-901M-N	900	100	20	80	120	0.60	10

- When ordering, please specify tolerance and packaging codes
- Tolerance : M = $\pm 20\%$
- Packaging : Clear tape and reel { standard }
- Z : Agilent/HP4291A
- Rdc(single line) : CH502BC/ HP4338B
- Insulation Resistance : Agilent /HP4339B
- Operating temperature range from -40°C to 105°C . (Including self - temperature rise)

Test Instruments : HP4291A Material/Impedance Analyzer

Typical Impedance vs. Frequency

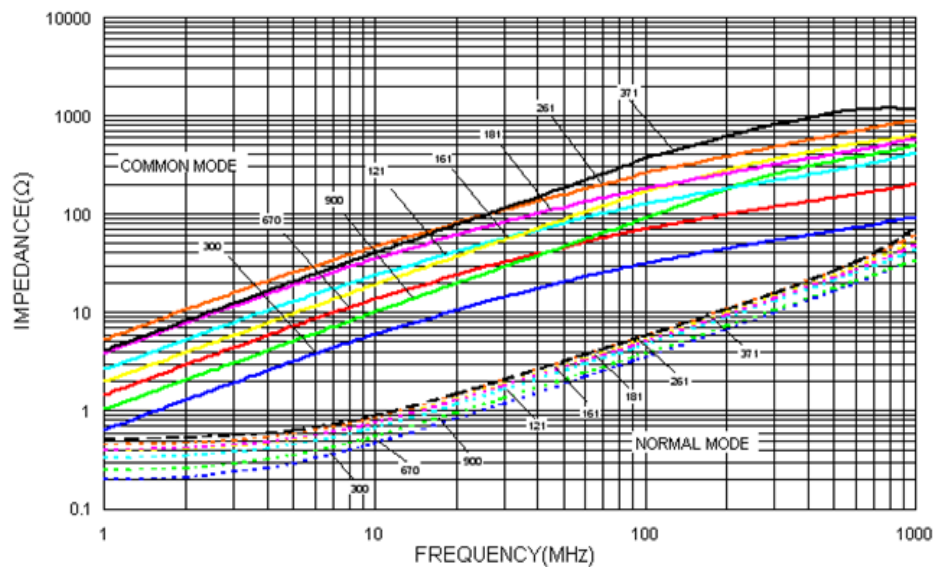

Electrical Characteristics

Part Number	Impedance (Ω)	Test Frequency (MHz)	Tolerance (±%)	Idc (mA) Max	Rated Voltage (Vdc)	Rdc (Ω) Max	Insulation Resistance (MΩ) Min
CMM31T-900M-N	90	100	20	370	50	0.3	10
CMM31T-161M-N	160	100	20	340	50	0.4	10
CMM31T-221M-N	220	100	20	320	50	0.4	10
CMM31T-261M-N	260	100	20	310	50	0.5	10
CMM31T-601M-N	600	100	20	260	50	0.8	10
CMM31T-102M-N	1000	100	20	230	50	1.0	10
CMM31T-222M-N	2200	100	20	200	50	1.2	10

- When ordering, please specify tolerance and packaging codes
- Tolerance: M = ±20%
- Packaging: Clear tape and reel {standard}
- Z: Agilent/HP4291A
- Rdc (single line): CH502BC/ HP4338B
- Insulation Resistance: Agilent/HP4339B
- Operating temperature range from -40°C to +105°C. (Including self - temperature rise)

Test Instruments : HP4291A Material/Impedance Analyzer

Typical Impedance vs. Frequency

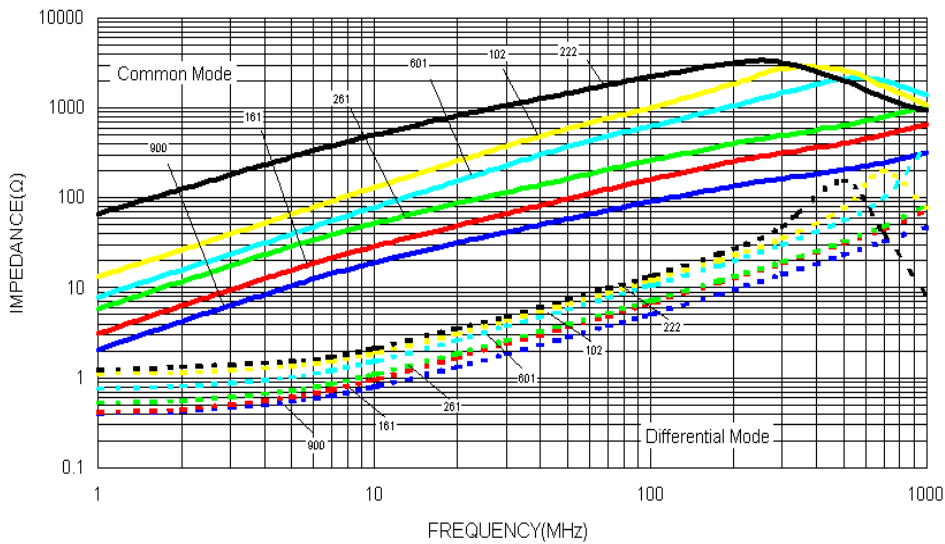

Packaging Specifications

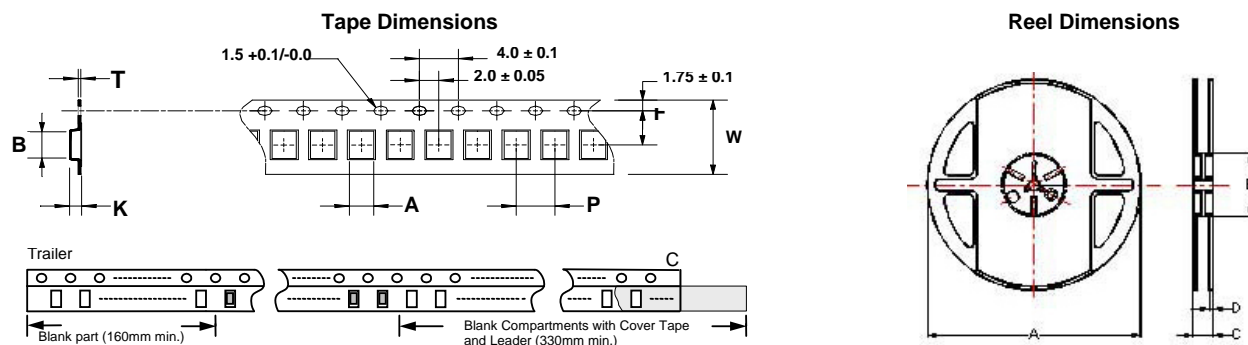

Dimensions in mm

TYPE	Tape Dimensions							Reel Dimensions				Quantity PCS / Reel
	A	B	T	W	P	F	K	A	B	C	D	
CMM10	0.95	1.70	0.24	8	4	3.5	1.15	178	60	12	1.5	2000
CMM11	1.10	1.40	0.24	8	4	3.5	1.00	178	60	12	1.5	2000
CMM21	1.50	2.25	0.24	8	4	3.5	1.35	178	60	12	1.5	2000
CMM31	1.76	3.47	0.22	8	4	3.5	2.05	178	60	12	1.5	2000

CMM Series For USB 2.0, IEEE1394b, LVDS



A full series of common mode choke is designed for excellent noise attenuation with compact sizing for use in wide range of applications. Both standard series and custom designs are available.

Features

- RoHS Compliant
- Miniature SMD type common mode filter for fully automated assembly
- Wide impedance range (30Ω ~ 2200Ω) for noise suppression
- Excellent solderability

Applications

- USB line for personal computers and peripheral
- IEEE 1394 line for personal computers, DVC, STB
- LVDS, panel line for liquid display panels, graph card etc

Product Identification

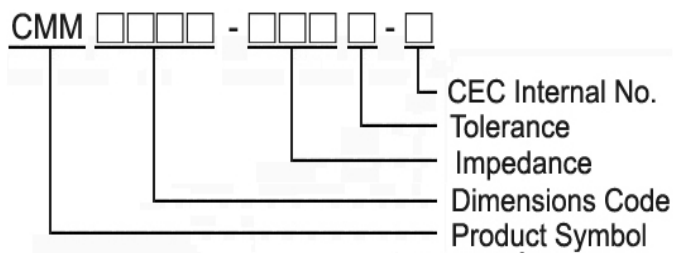

- Packaging: T : Tape and Reel

Shapes and Dimensions

CMM0805

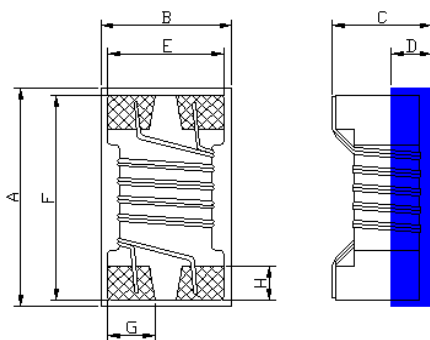

Dimensions in mm

A	B	C	D	E	F	G	H
2.29 ⁺⁰	1.52 ⁺⁰	1.20 ⁺⁰	0.5	1.27	2.03	0.5	0.58

Recommended Pattern

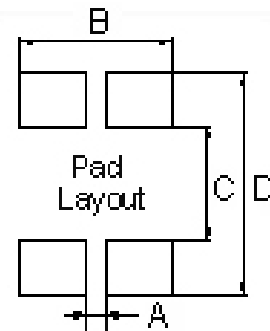

Dimensions in mm

A	B	C	D
0.5	1.27	0.8	2.6

Electrical Characteristics

Part Number	Impedance (Ω)	Test Frequency (MHz)	Tolerance (±%)	Idc (mA) Max	Rated Voltage (Vdc)	Rdc (Ω) Max	Insulation Resistance (MΩ) Min
CMM0805-300M-N	30	100	20	1300	50	0.20	10
CMM0805-420M-N	42	100	20	1300	50	0.20	10
CMM0805-670M-N	67	100	20	1200	50	0.25	10
CMM0805-900M-N	90	100	20	1000	50	0.27	10
CMM0805-121M-N	120	100	20	900	50	0.30	10
CMM0805-181M-N	180	100	20	700	50	0.40	10
CMM0805-261M-N	260	100	20	700	50	0.60	10

- When ordering, please specify tolerance and packaging codes.
- Tolerance : M = ±20%
- Packaging : Clear tape and reel { standard }.
- Z : Agilent/HP4291A
- Rdc(single line) : CH502BC/ HP4338B
- Insulation Resistance : Agilent /HP4339B
- Operating temperature range from -25°C to 85°C.

Typical Impedance vs. Frequency

CMM0805-900M-N

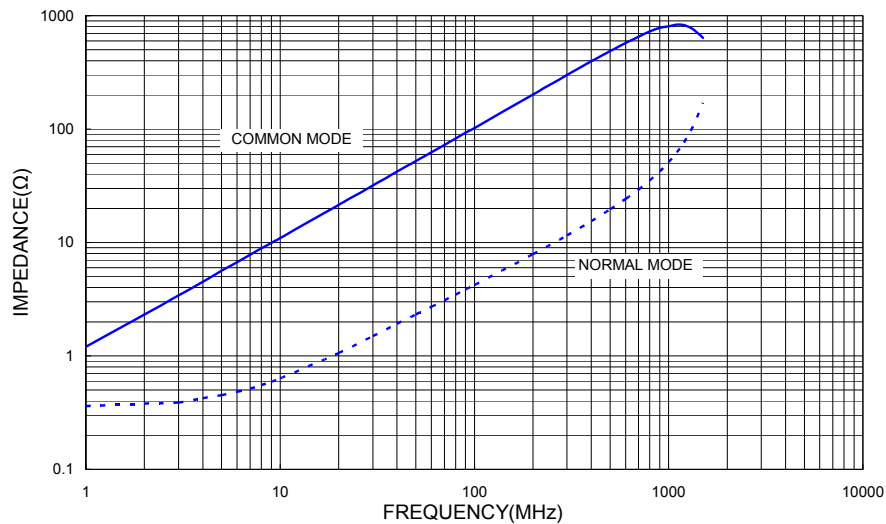

Packaging Specifications

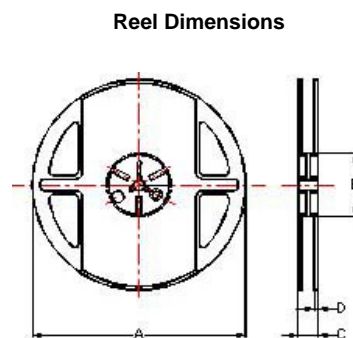
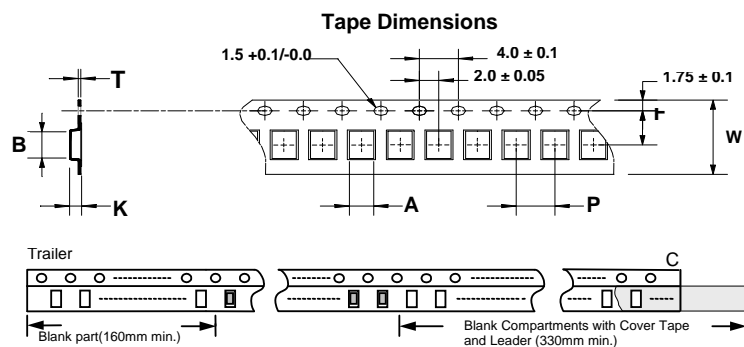

Dimensions in mm

TYPE	Tape Dimensions							Reel Dimensions				Quantity PCS / Reel
	A	B	T	W	P	F	K	A	B	C	D	
CMM0805	1.60	2.42	0.26	8	4	3.5	1.14	178	60	12	1.5	2000

CMMI Series For HDMI, USB 3.0



A full series of common mode choke is designed for excellent noise attenuation and compact sizing for use in wide range of applications. Both standard series and custom designs are available.

Features

- RoHS Compliant
- Miniature SMD type common mode filter for fully automated assembly
- Excellent solderability

Applications

- HDMI
- USB lines (for personal computers and peripheral), DVC, STB, LVDS, panel line for liquid display panels, etc.

Product Identification

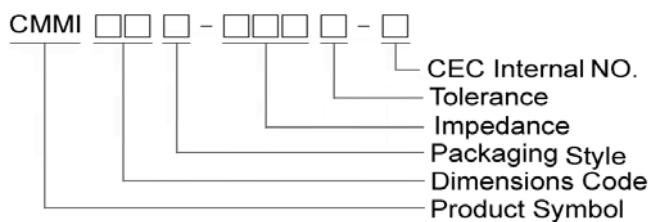

- Packaging: T : Tape and Reel

Shape and Dimensions

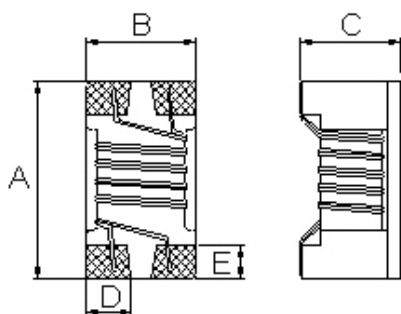

Dimensions in mm

TYPE	A	B	C	D	E
CMMI11	1.25±0.2	1.00±0.2	0.80±0.1	0.32	0.33
CMMI21	2.05±0.2	1.25±0.2	1.20±0.2	0.50	0.58

Recommended Pattern

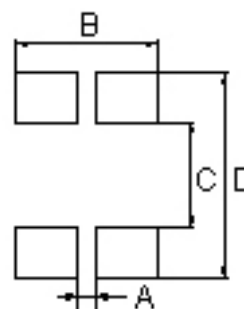

Dimensions in mm

TYPE	A	B	C	D
CMMI11	0.36	1.00	0.59	1.75
CMMI21	0.50	1.20	0.80	2.60

Electrical Characteristics

Part Number	Impedance (Ω)	Test Frequency (MHz)	Tolerance (±%)	Idc (mA) Max	Rated Voltage (Vdc)	Rdc (Ω) Max	Insulation Resistance (MΩ) Min
CMMI11T-600Y-N	60	100	25	250	20	0.40	10
CMMI11T-900Y-N	90	100	25	250	20	0.30	10

- When ordering, please specify tolerance and packaging codes
- Tolerance : Y = ±25%
- Packaging : Clear tape and reel { standard }
- Z : HP4286A / HP4287A / Agilent E4991A + Agilent16197A
- Rdc(single line) :CH502BC
- Idc : HP4284A+HP42841A/HP4285A+HP42841A
- Insulation Resistance : Agilent HP4339B
- Operating temperature range from -40°C to 105°C . (Including self - temperature rise)

Test Instruments : HP4291A Material/Impedance Analyzer

Typical Impedance vs. Frequency

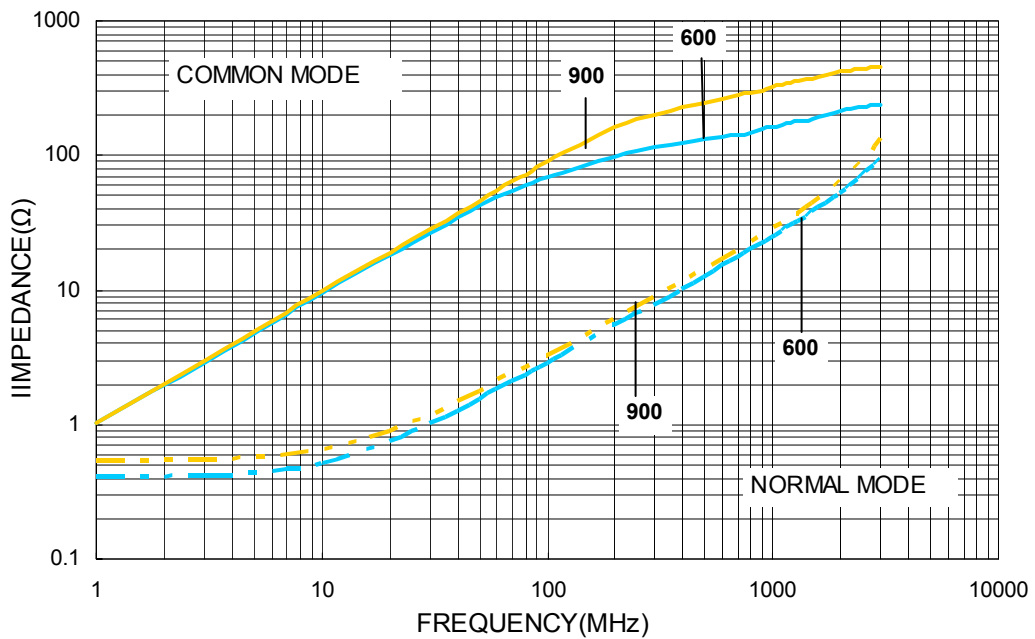

CMMI11T-600Y-N

Insertion Loss For HDMI Testing:

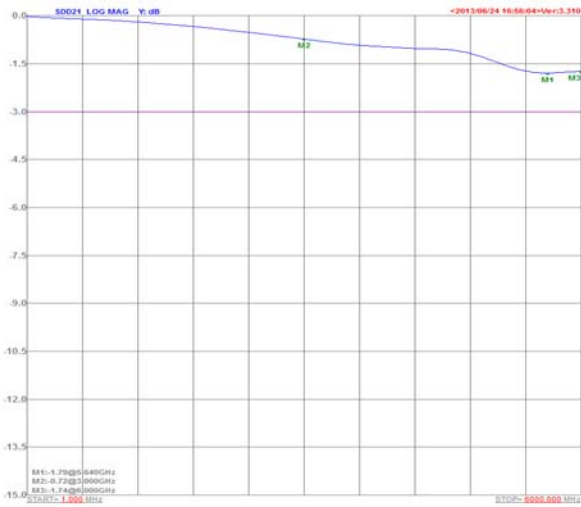

Insertion Loss For USB3.0 Testing:

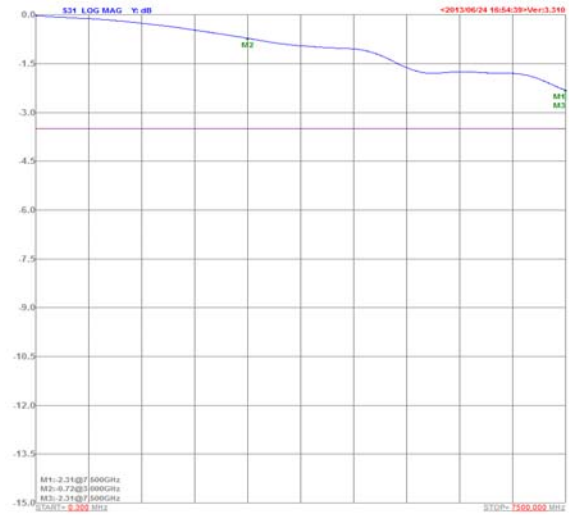

TDR For HDMI Testing:

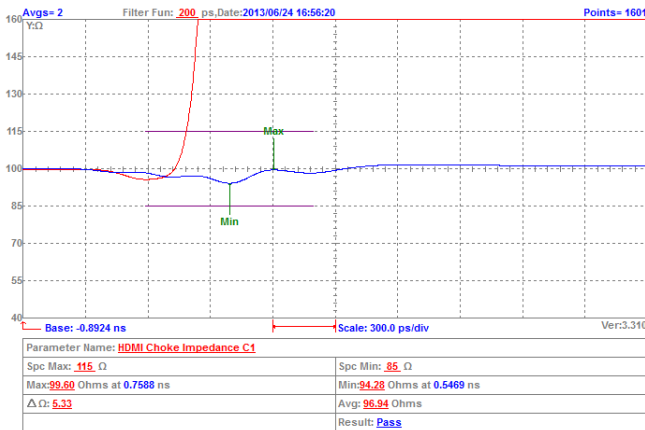

TDR For USB3.0 Testing:

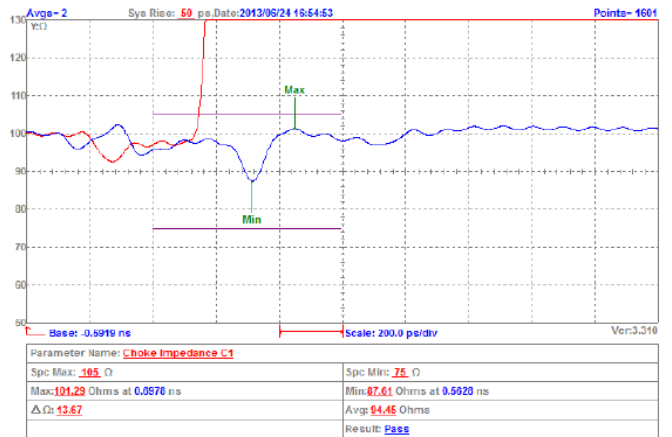

Eye Diagram For HDMI Testing:

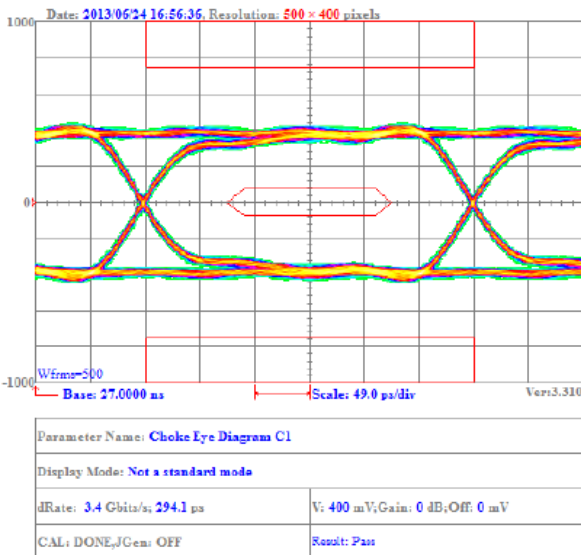

Eye Diagram For USB3.0 Testing:

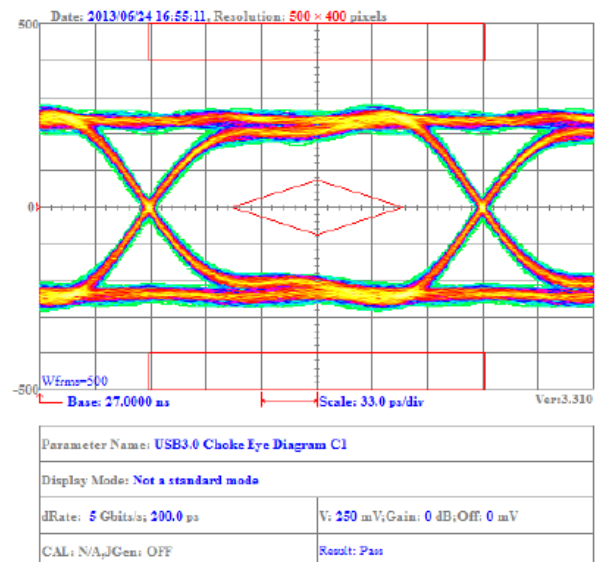

CMMI11T-900Y-N

Insertion Loss For HDMI Testing:

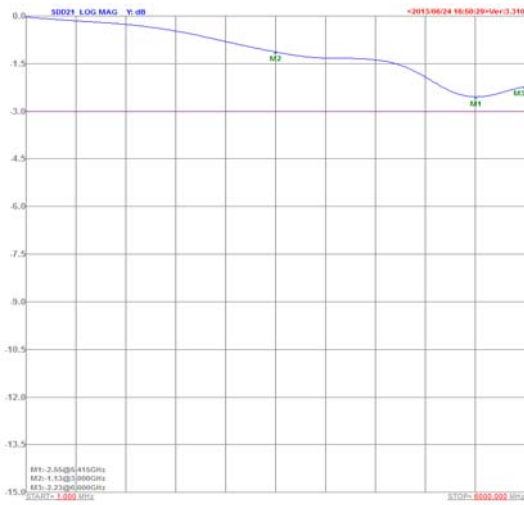

Insertion Loss For USB3.0 Testing:

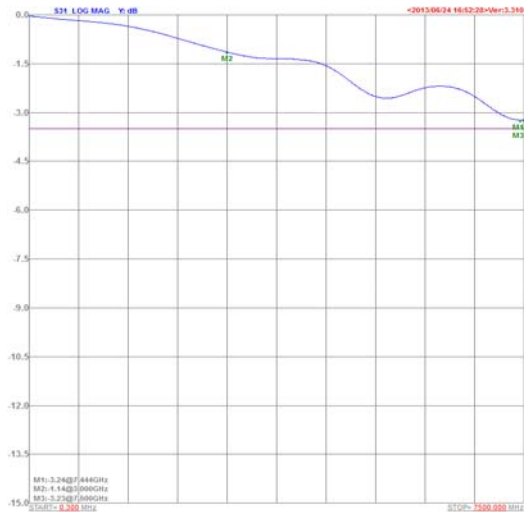

TDR For HDMI Testing:

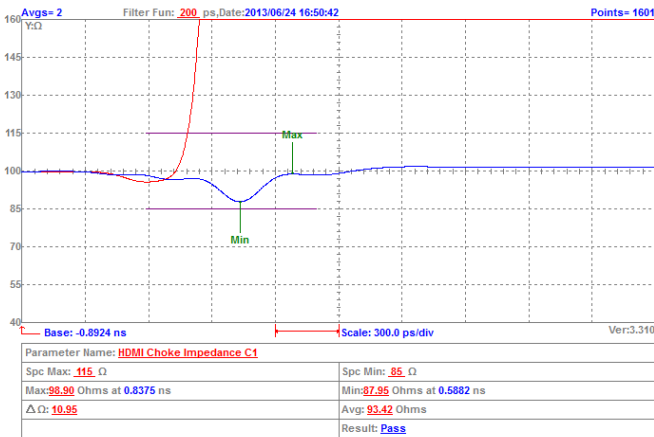

TDR For USB3.0 Testing:

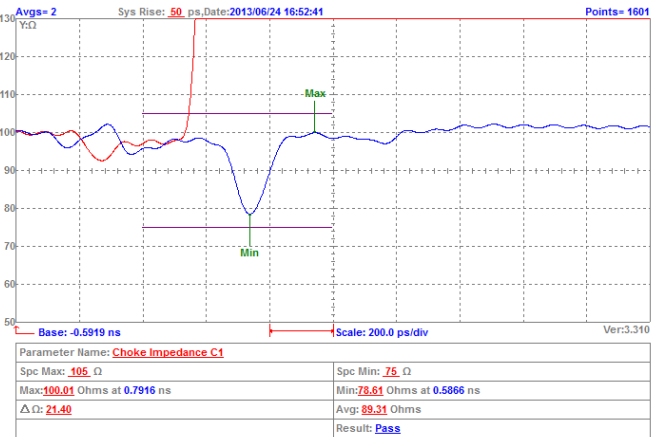

Eye Diagram For HDMI Testing:

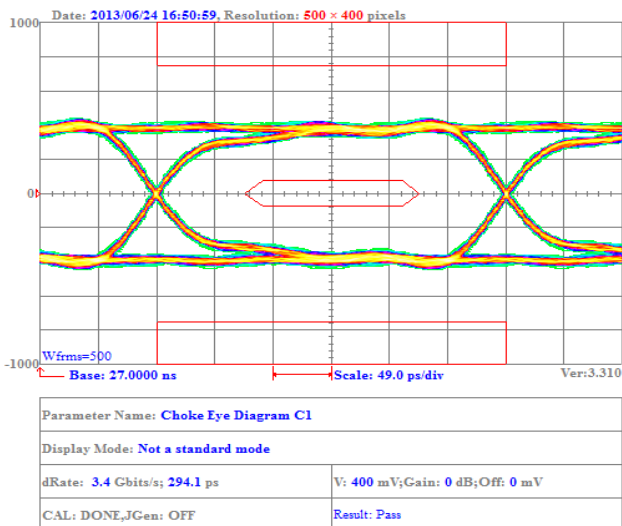

Eye Diagram For USB3.0 Testing:

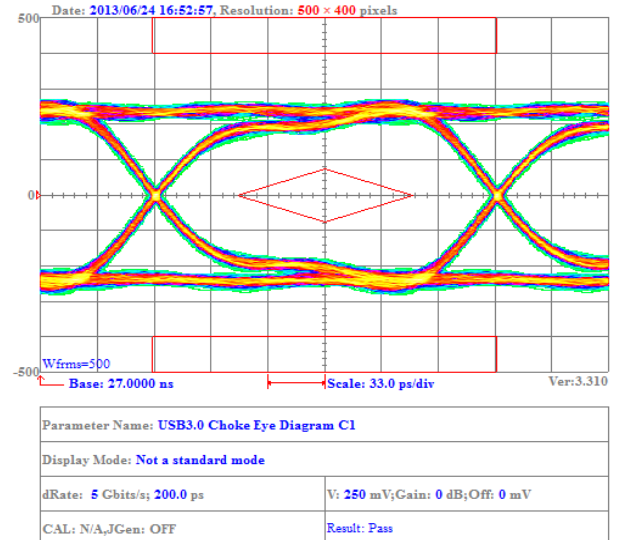

Electrical Characteristics

Part Number	Impedance (Ω)	Test Frequency (MHz)	Tolerance (±%)	Idc (mA) Max	Rated Voltage (Vdc)	Rdc (Ω) Max	Insulation Resistance (MΩ) Min
CMMI21T-500Y-N	50	100	25	500	50	0.20	10
CMMI21T-670Y-N	67	100	25	500	50	0.30	10
CMMI21T-900Y-N	90	100	25	330	50	0.30	10
CMMI21T-121Y-N	120	100	25	330	50	0.35	10
CMMI21T-131Y-N	130	100	25	300	50	0.40	10

- When ordering, please specify tolerance and packaging codes
- Tolerance : Y = ±25%
- Packaging : Clear tape and reel { standard }
- Z : HP4286A / HP4287A / Agilent E4991A + Agilent16197A
- Rdc(single line) :CH502BC
- Idc : HP4284A+HP42841A/HP4285A+HP42841A
- Insulation Resistance : Agilent HP4339B
- Operating temperature range from -40°C to 105°C . (Including self - temperature rise)

Test Instruments : HP4291A Material/Impedance Analyzer

Typical Impedance vs. Frequency

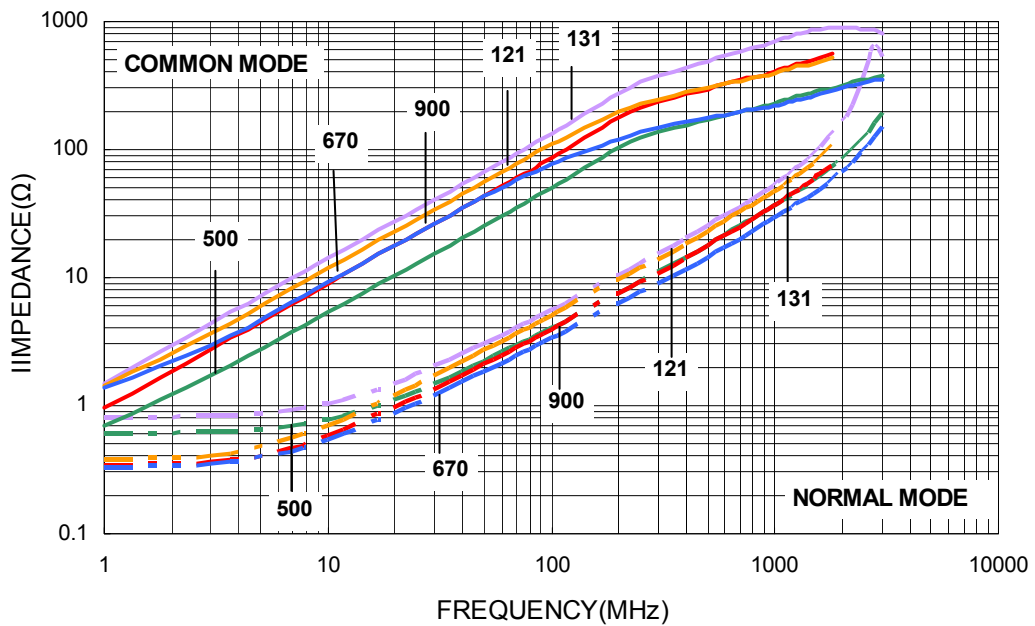

CMMI21T-500Y-N

Insertion Loss For HDMI Testing:

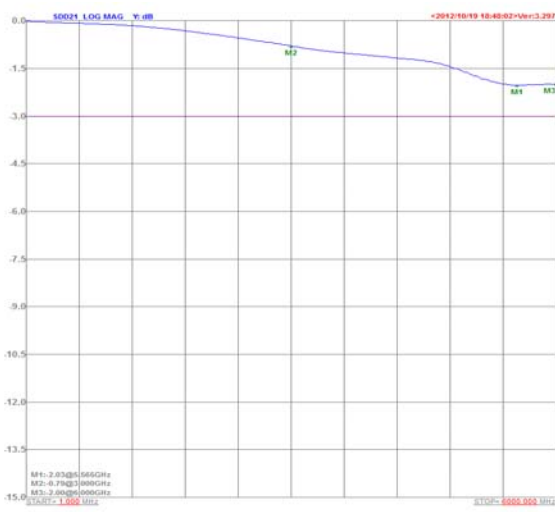

Insertion Loss For USB3.0 Testing:

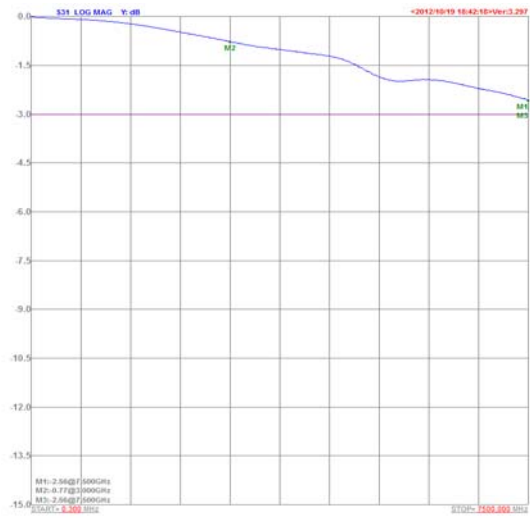

TDR For HDMI Testing:

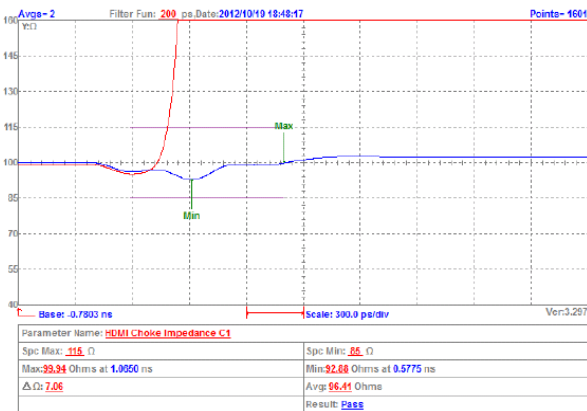

TDR For USB3.0 Testing:

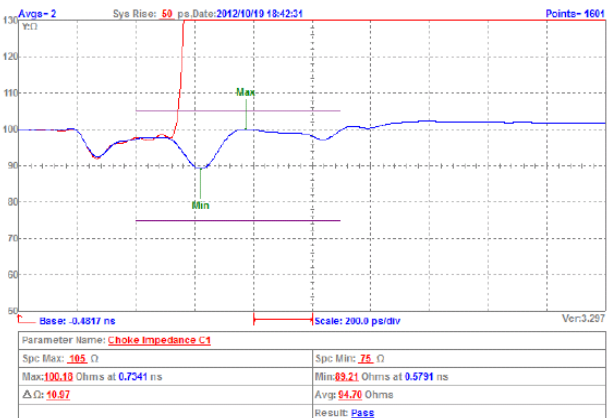

Eye Diagram For HDMI Testing:

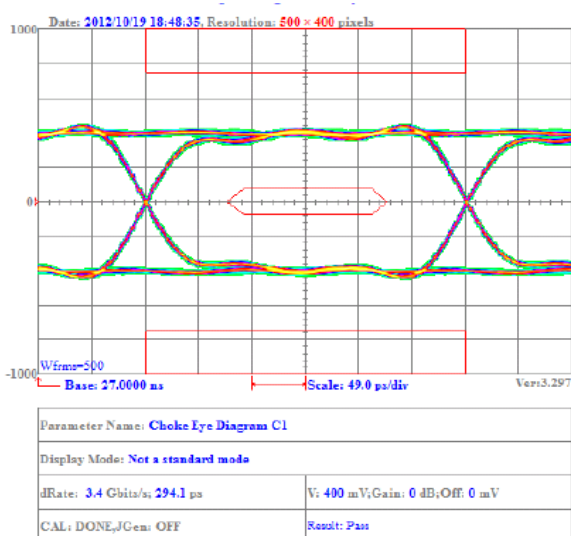

Eye Diagram For USB3.0 Testing:

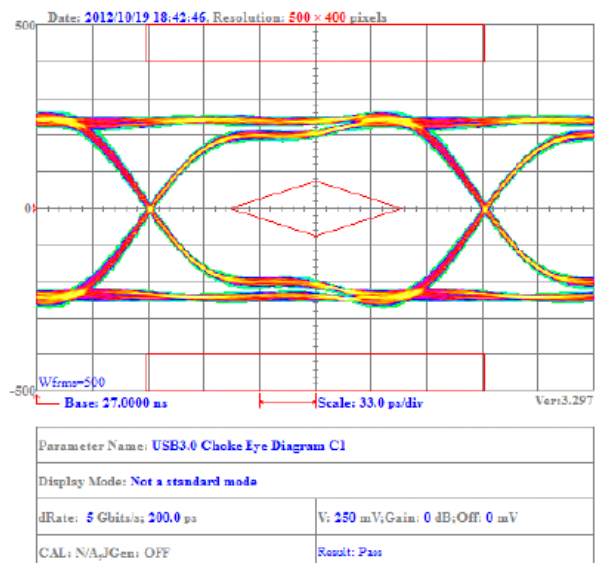

CMMI21T-670Y-N

Insertion Loss For HDMI Testing:

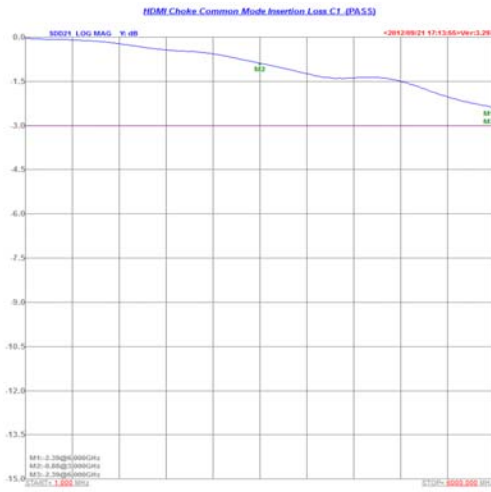

Insertion Loss For USB3.0 Testing:

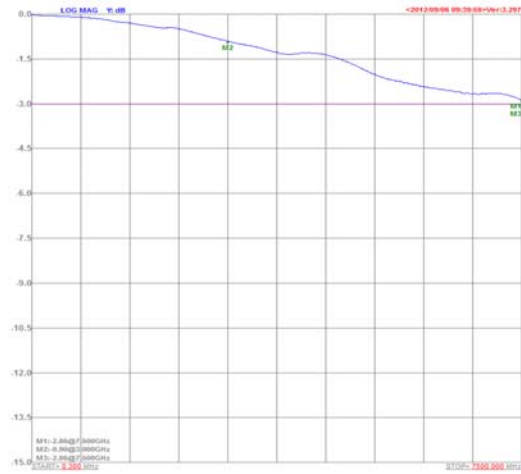

TDR For HDMI Testing:

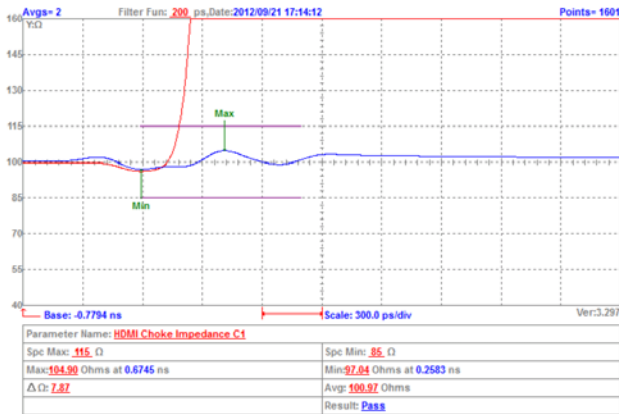

TDR For USB3.0 Testing:

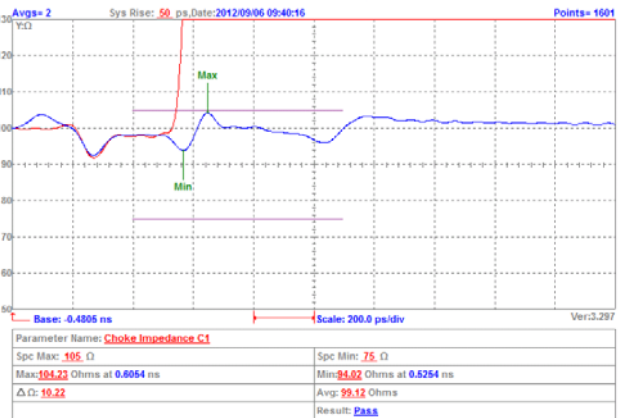

Eye Diagram For HDMI Testing:

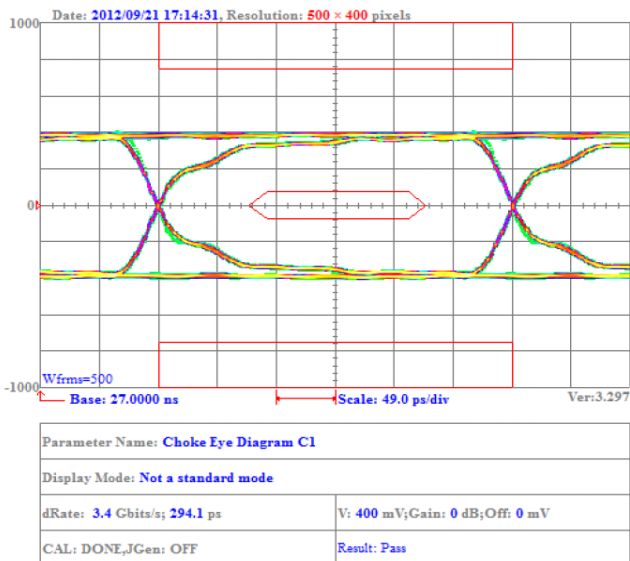

Eye Diagram For USB3.0 Testing:

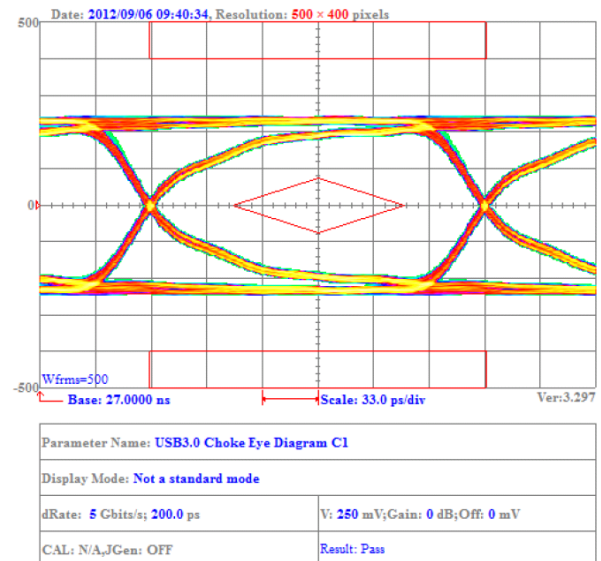

CMMI21T-900Y-N

Insertion Loss For HDMI Testing:

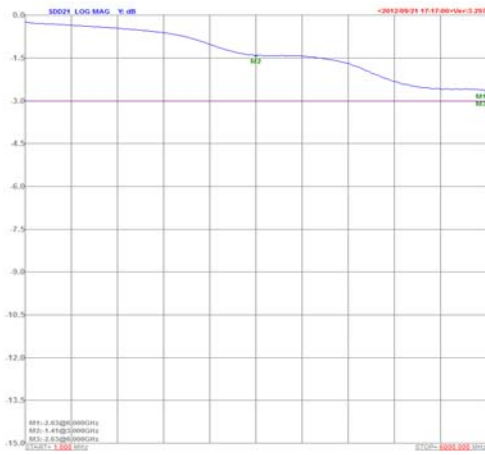

Insertion Loss For USB3.0 Testing:

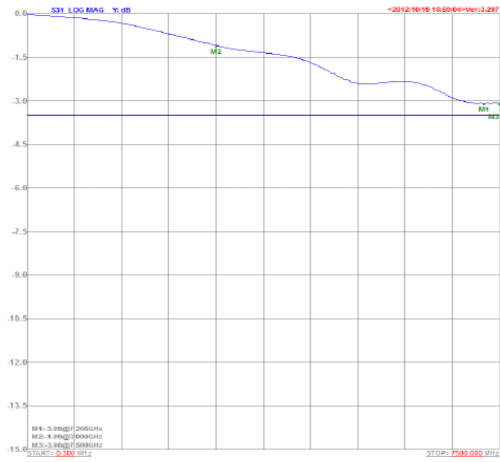

TDR For HDMI Testing:

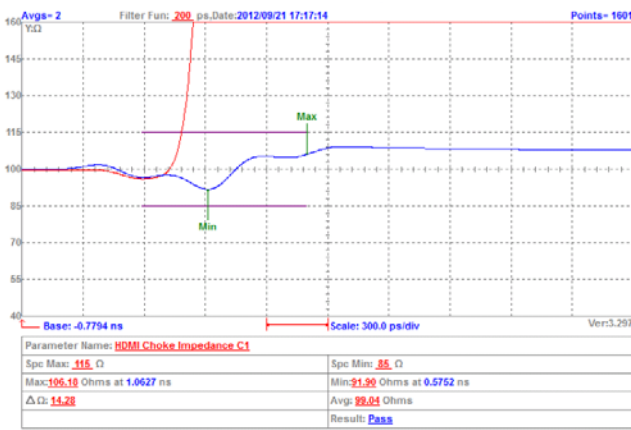

TDR For USB3.0 Testing:

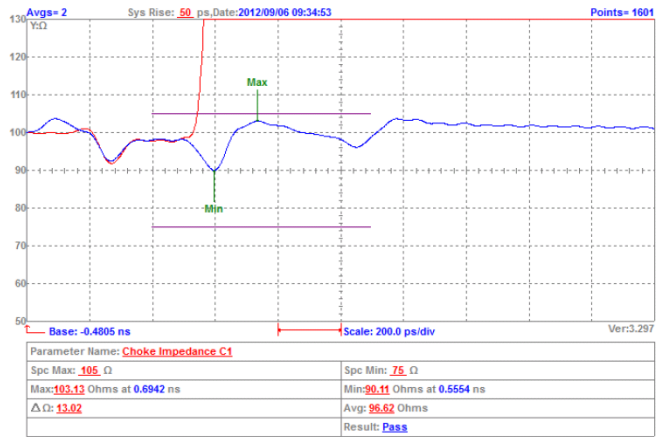

Eye Diagram For HDMI Testing:

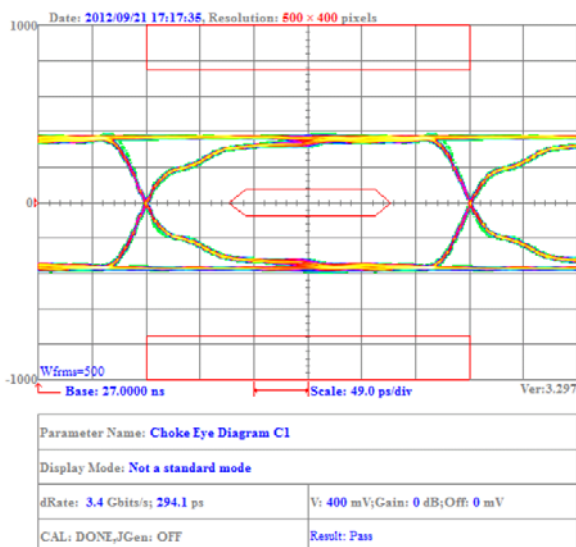

Eye Diagram For USB3.0 Testing:

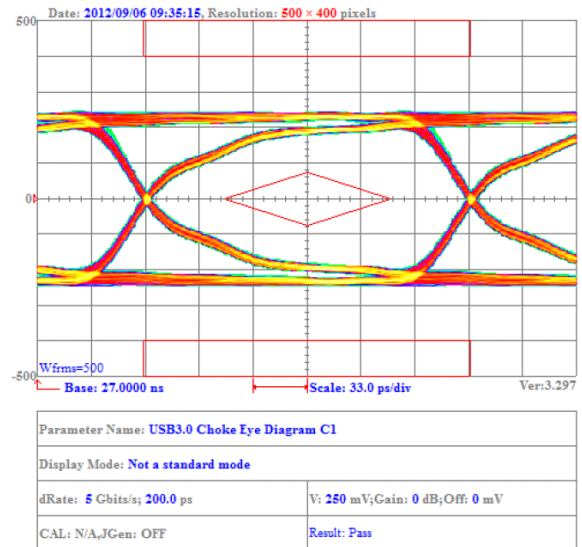

CMMI21T-121Y-N

Insertion Loss For HDMI Testing:

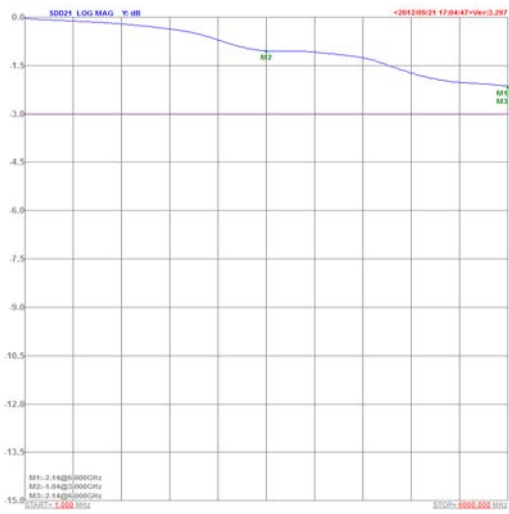

Insertion Loss For USB3.0 Testing:

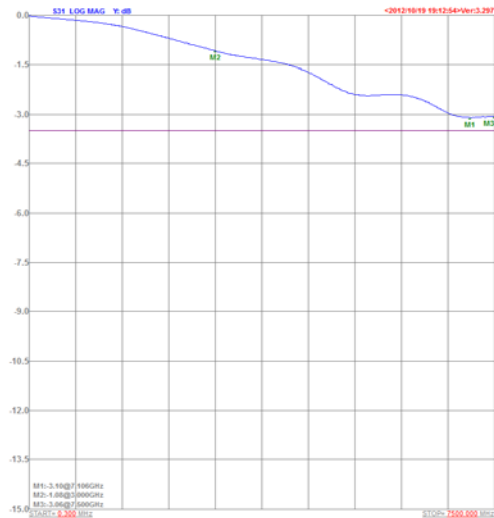

TDR For HDMI Testing:

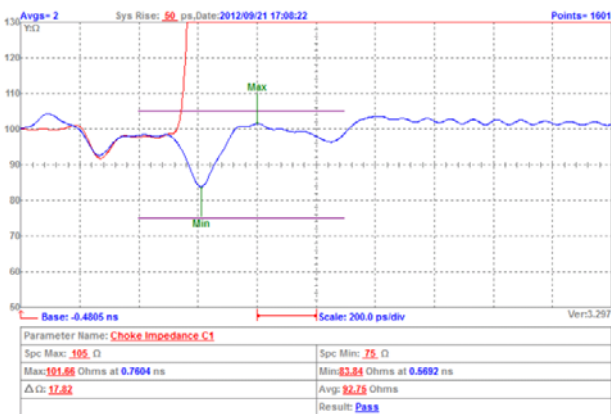

TDR For USB3.0 Testing:

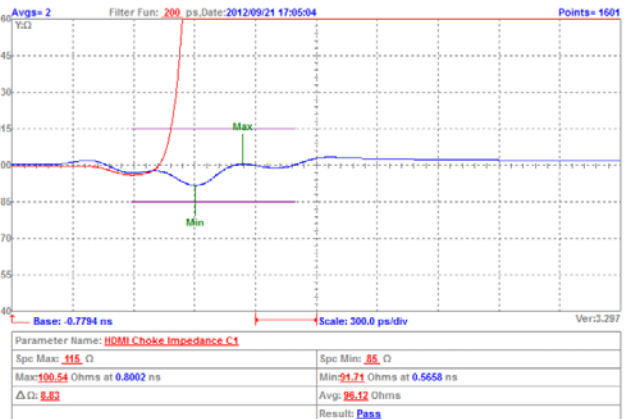

Eye Diagram For HDMI Testing:

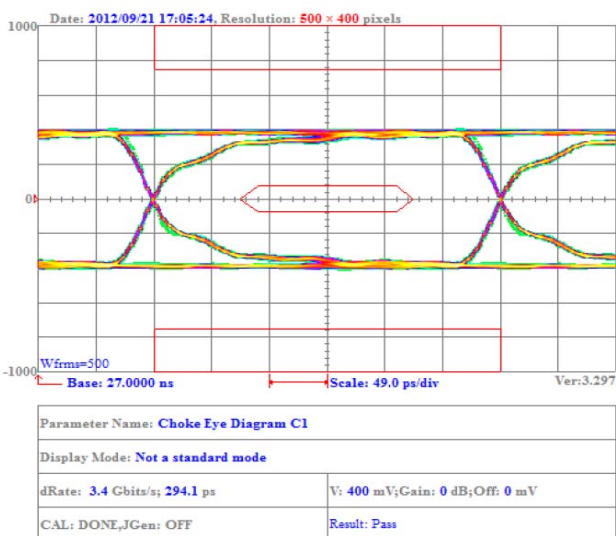

Eye Diagram For USB3.0 Testing:

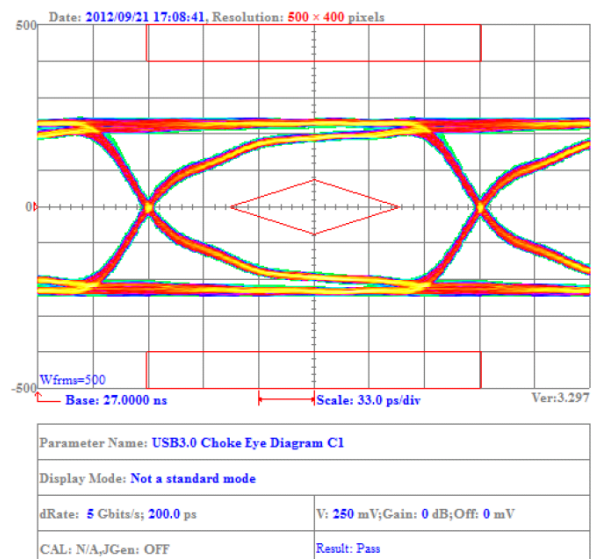

CMMI21T-131Y-N

Insertion Loss For HDMI Testing:

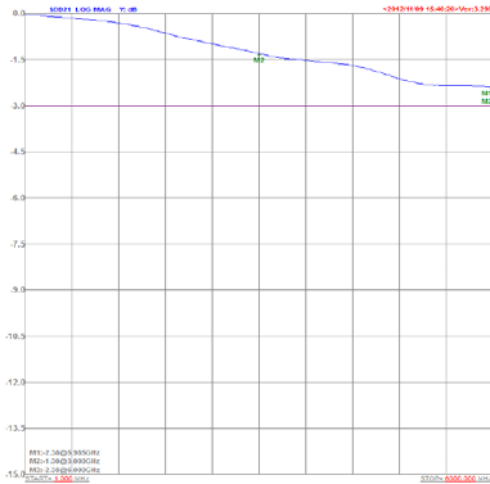

Insertion Loss For USB3.0 Testing:

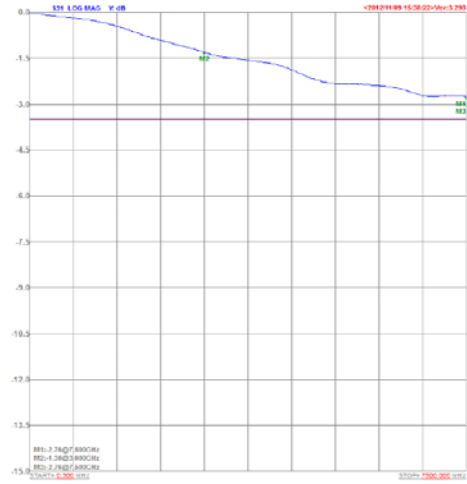

TDR For HDMI Testing:

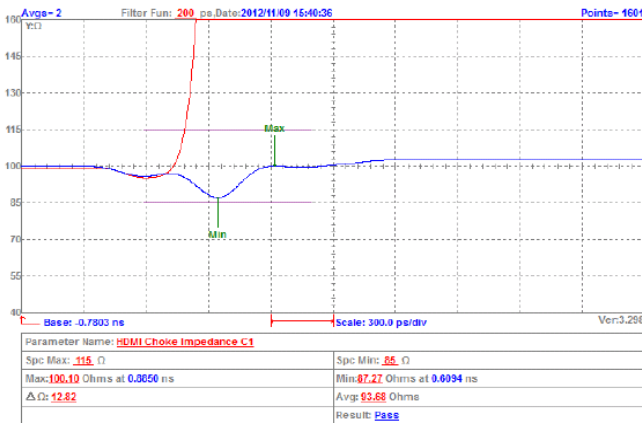

TDR For USB3.0 Testing:

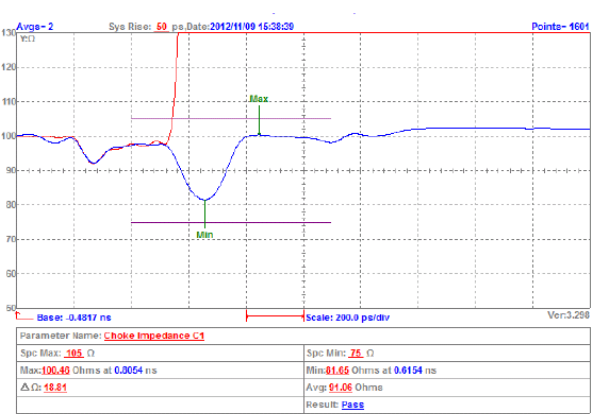

Eye Diagram For HDMI Testing:

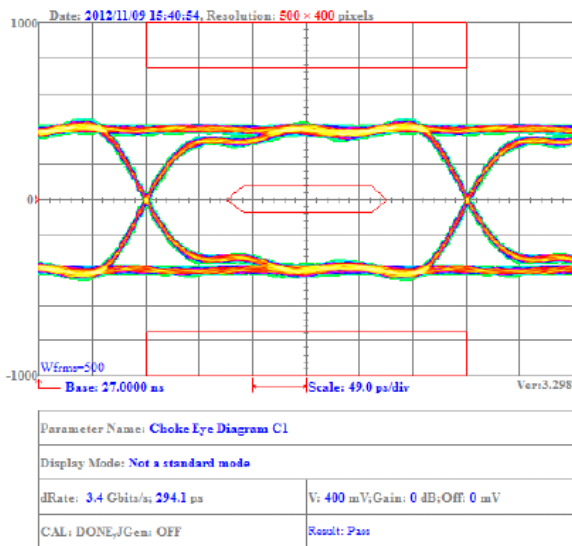

Eye Diagram For USB3.0 Testing:

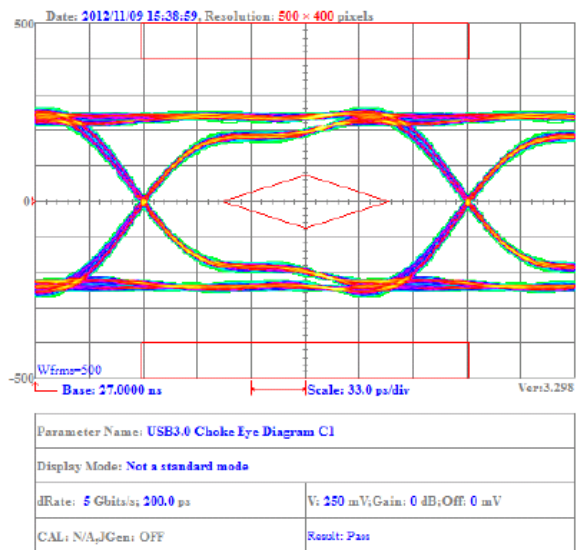

Packaging Specifications

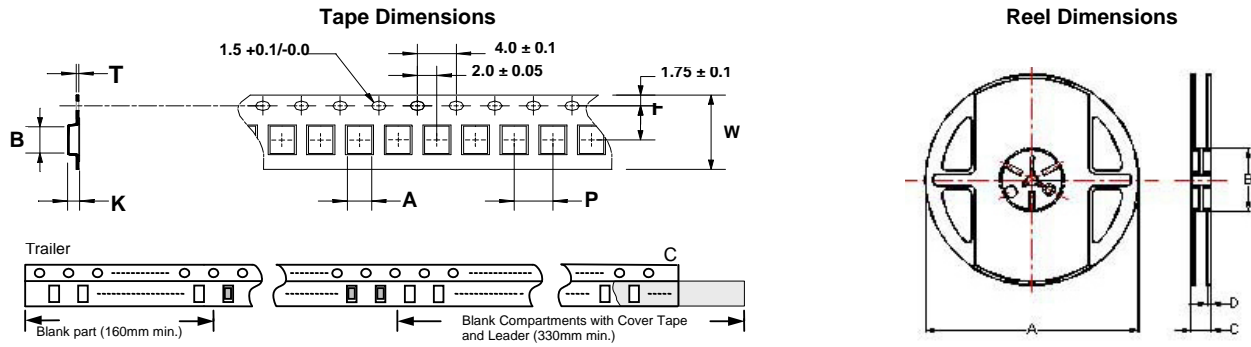

Dimensions in mm

TYPE	Tape Dimensions							Reel Dimensions				Quantity PCS / Reel
	A	B	T	W	P	F	K	A	B	C	D	
CMMI11	1.10	1.40	0.25	8	4	3.5	1.00	178	60	12	1.5	2000
CMMI21	1.50	2.25	0.24	8	4	3.5	1.35	178	60	12	1.5	2000



Total Solution Provider for EMI, Power and RF.

Inductors Leaded Components



DMI Series



DMI series is designed with low RDC and ultra large current. Its molded magnetic shielded type is suitable for high-density mounting and ultra low buzz noise. Soldering conditions can be easily confirmed when mounting onto the board. This series also Provides customers with embossed carrier type packaging for automatic mounting machine.

Features

- Shield construction
- Ultra low buzz noise, due to un-assembly structure
- 100% Lead free

Applications

- High density DC/DC converters
- POL convertes
- High current VRM/VRD for notebook / Server / desktop CPUs
- High speed charger

Product Identification

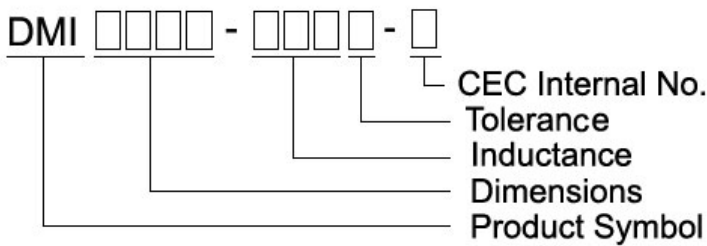

Shapes and Dimensions

FIG 1

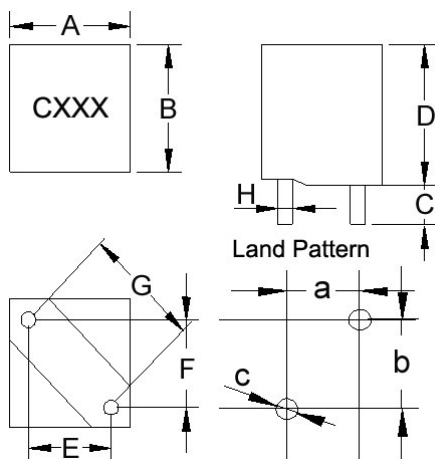

FIG 2

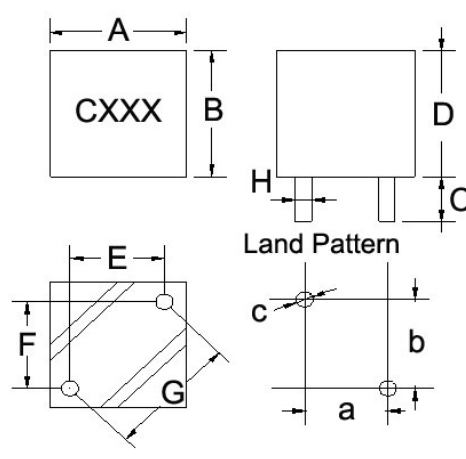
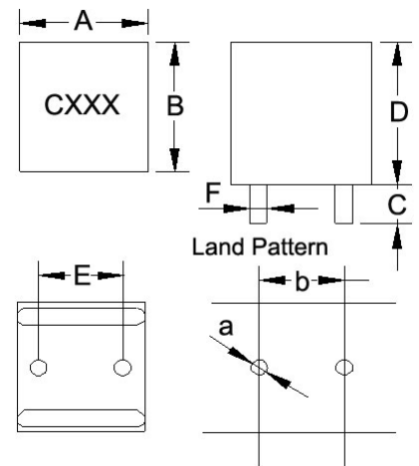

FIG 3



Leaded Power Chokes DMI Series

Dimensions in mm

TYPE	FIG	A	B	C	D	E	F	G	H	a	b	c
DMI0807-1R0M-N	3	8.5±0.5	8.5±0.5	3.4±0.5	7.5Max	5.0±0.5	0.8±0.1	-	-	1.3	5.5	-
DMI0808-R30M-N	1	8.5Max	8.5Max	3.4±0.5	9.0Max	4.7±0.5	4.7±0.5	6.6±0.5	1.1±0.1	5.2	5.2	1.6
DMI0808-1R0M-N	3	9.0Max	9.0Max	3.4±0.5	9.0Max	5.0±0.5	0.8±0.1	-	-	1.3	5.5	-
DMI0809-R56M-N	2	8.5Max	8.5Max	3.4±0.5	9.5Max	4.7±0.5	4.7±0.5	6.6 ^{+0.3} _{-0.5}	1.2±0.1	5.2	5.2	1.7
DMI0809-1R0M-N	1	8.0Max	8.0Max	3.4±0.5	9.5Max	4.2±0.5	4.2±0.5	5.9±0.5	1.1±0.1	4.7	4.7	1.6
DMI0809-2R2M-N	1	8.0Max	8.0Max	3.4±0.5	9.5Max	4.2±0.5	4.2±0.5	5.9±0.5	0.9±0.1	4.7	4.7	1.4
DMI0909-R25M-N	2	9.0Max	8.2Max	3.4±0.5	9.5Max	6.5±0.5	2.7±0.5	6.85±0.5	1.2±0.1	7.0	3.2	1.7
DMI1009-R68M-N	2	10.5Max	10.5Max	3.4±0.5	9.8Max	5.6±0.5	5.6±0.5	7.9±0.5	1.4±0.1	6.1	6.1	1.9
DMI1009-1R2M-N	2	10.5Max	10.5Max	3.4±0.5	9.8Max	5.6±0.5	5.6±0.5	7.9±0.5	1.3±0.1	6.1	6.1	1.8
DMI1108-R30M-N	1	11.5Max	9.5Max	3.4±0.5	8.5Max	6.6±0.5	4.2±0.5	7.8±0.5	1.5±0.1	7.1	4.7	2.0
DMI1108-R36M-N	1	11.7Max	9.7Max	3.5±0.5	8.8Max	6.6±0.5	4.2±0.5	7.8±0.5	1.4±0.1	7.1	4.7	1.9
DMI1108-R60M-N	1	11.7Max	11.7Max	3.5±0.5	8.5Max	6.3±0.5	5.7±0.5	8.5±0.5	1.5±0.1	6.8	6.2	2.0
DMI1108-1R8M-N	1	11.7Max	11.7Max	3.5±0.5	8.5Max	6.6±0.5	6.6±0.5	9.3±0.5	1.2±0.1	7.1	7.1	1.7
DMI1109-R30M-N	1	11.5±0.5	11.5±0.5	3.4±0.5	9.5±0.5	7.3±0.5	6.0±0.5	9.4±0.5	1.4±0.1	7.8	6.5	1.9
DMI1109-R56M-N	1	11.7Max	9.7Max	3.5±0.5	9.5Max	6.6±0.5	4.2±0.5	7.8±0.5	1.3±0.1	7.1	4.7	1.8
DMI1109-R68M-N	2	11.8Max	11.8Max	3.4±0.5	9.8Max	6.7±0.5	6.0±0.5	9 ^{+0.3} _{-0.5}	1.5±0.1	7.2	6.5	2.0
DMI1109-1R2M-N	2	11.5Max	11.5Max	3.4±0.5	9.8Max	6.7±0.5	6.0±0.5	9 ^{+0.3} _{-0.5}	1.5±0.1	7.2	6.5	2.0
DMI1109-1R5M-N	1	11.5±0.5	11.5±0.5	3.4±0.5	9.5±0.5	7.3±0.5	7.3±0.5	10.3±0.5	1.4±0.1	7.8	7.8	1.9
DMI1110-R60M-N	1	11.6Max	11.6Max	3.4±0.5	10Max	7.3±0.5	6.0±0.5	9.4±0.3	1.4±0.1	7.8	6.5	1.9
DMI1110-1R1M-N	1	11.6Max	11.6Max	3.2±0.5	10Max	6.7±0.5	6.0±0.5	9.0±0.5	1.4±0.1	7.2	6.5	1.9
DMI1208-R22M-N	2	12Max	12Max	3.4±0.5	8.0Max	7.3±0.5	6.0±0.5	9.4±0.5	1.4±0.1	7.8	6.5	1.9
DMI1208-R36M-N	1	11.5±0.5	11.5±0.5	3.5±0.5	7.4±0.2	5.7±0.5	6.3±0.5	8.5±0.5	1.5±0.1	6.2	6.8	2.0
DMI1208-R47M-N	2	12Max	12Max	3.4±0.5	8.0Max	7.3±0.5	6.0±0.5	9.4±0.5	1.4±0.1	7.8	6.5	1.9
DMI1208-R56M-N	2	12Max	12Max	3.4±0.5	8.0Max	7.3±0.5	6.0±0.5	9.4±0.5	1.4±0.1	7.8	6.5	1.9
DMI1209-R33M-N	2	12Max	12Max	3.4±0.5	9.0Max	7.3±0.5	6.0±0.5	9.4±0.5	1.4±0.1	7.8	6.5	1.9
DMI1209-R47M-N	2	12Max	12Max	3.4±0.5	9.0Max	7.3±0.5	6.0±0.5	9.4±0.5	1.4±0.1	7.8	6.5	1.9
DMI1209-R68M-N	2	12Max	12Max	3.4±0.5	9.0Max	7.3±0.5	6.0±0.5	9.4±0.5	1.4±0.1	7.8	6.5	1.9
DMI1209-1R0M-N	2	12Max	12Max	3.4±0.5	9.0Max	7.3±0.5	6.0±0.5	9.4±0.5	1.5±0.1	7.8	6.5	2.0
DMI1209-2R5M-N	1	12Max	12Max	3.4±0.5	9.0Max	6.6±0.5	6.6±0.5	9.3±0.5	1.2±0.1	7.1	7.1	1.7
DMI1210-R30M-N	1	12Max	12Max	3.4±0.5	10Max	7.3±0.5	6.0±0.5	9.4±0.5	1.4±0.1	7.8	6.5	1.9
DMI1210-R47M-N	1	12Max	12Max	3.4±0.5	10Max	7.3±0.5	6.0±0.5	9.4±0.5	1.4±0.1	7.8	6.5	1.9
DMI1210-1R8M-N	2	12Max	12Max	3.4±0.5	10.5Max	6.0±0.5	6.0±0.5	8.5±0.5	1.1±0.1	6.5	6.5	1.6
DMI1210-4R7M-N	1	12Max	12Max	3.4±0.5	12Max	7.0±0.5	7.0±0.5	10±0.5	1.1±0.1	7.5	7.5	1.6

Leaded Power Chokes – DMI Series

Electrical Characteristics

Part Number	Inductance (mH)	Tolerance (±%)	Test Frequency (KHz)	RDC (m Ω) Max	Isat (A) Typ	Irms (A) Typ
DMI0808-R30M-N	0.30	20	100/ 1V	1.0	35	32
DMI0808-1R0M-N	1.00	20	100/ 1V	4.0	12	16
DMI0809-R56M-N	0.56	20	100/ 1V	1.3	25	25
DMI0809-1R0M-N	1.00	20	100/ 1V	1.8	23	35
DMI0809-2R2M-N	2.20	20	100/ 1V	3.5	13	17
DMI0909-R25M-N	0.25	20	100/ 1V	0.8	28	35
DMI1108-R30M-N	0.30	20	100/ 1V	1.0	50	38
DMI1108-R36M-N	0.36	20	100/ 1V	0.7	50	43
DMI1108-1R8M-N	1.80	20	100/ 1V	3.0	24	24
DMI1109-R56M-N	0.56	20	100/ 1V	1.08	50	37
DMI1109-R68M-N	0.68	20	100/ 1V	1.2	40	35
DMI1110-R60M-N	0.60	20	100/ 1V	1.2	40	42
DMI1110-1R1M-N	1.10	20	100/ 1V	1.5	35	28
DMI1208-R22M-N	0.22	20	100/ 1V	0.6	75	38
DMI1208-R47M-N	0.47	20	100/ 1V	0.9	55	38
DMI1208-R56M-N	0.56	20	100/ 1V	0.9	45	38
DMI1209-R33M-N	0.33	20	100/ 1V	0.9	70	35
DMI1209-R47M-N	0.47	20	100/ 1V	0.9	50	38
DMI1209-R68M-N	0.68	20	100/ 1V	1.2	45	35
DMI1209-1R0M-N	1.00	20	100/ 1V	1.5	35	35
DMI1209-2R5M-N	2.50	20	100/ 1V	2.6	25	27
DMI1210-R47M-N	0.47	20	100/ 1V	1.0	50	30
DMI1210-1R8M-N	1.80	20	100/ 1V	3.3	29	22
DMI1210-4R7M-N	4.70	20	100/ 1V	6.0	12	17

- Customized Specifications are welcome .
- Isat for inductance drops 20% from its value without current
- Irms for a 40 °C rise above 25 °C ambient.
- Tested L: WK4237METER

RDC: HK502BC METER

Isat, Irms : WK3260B/ 3265B METER

Electrical Characteristics

Part Number	Inductance (mH)	Tolerance (±%)	Test Frequency (KHz)	RDC (m Ω) Max	Isat (A) Typ	Irms (A) Typ
DMI0807-1R0M-N	1.00	20	100/ 1V	4.0	28	15
DMI1009-R68M-N	0.68	20	100/ 1V	1.2	49	30
DMI1009-1R2M-N	1.20	20	100/ 1V	1.7	33	28
DMI1108-R60M-N	0.60	20	100/ 1V	1.0	40	35
DMI1109-R30M-N	0.30	20	100/ 1V	0.7	46	40
DMI1109-1R2M-N	1.20	20	100/ 1V	1.2	40	30
DMI1109-1R5M-N	1.50	20	100/ 1V	1.85	42	28
DMI1208-R36M-N	0.36	20	100/ 1V	0.8	60	40
DMI1210-R30M-N	0.30	20	100/ 1V	0.65	45	40

- Customized Specifications are welcome .
- Isat for inductance drops 30% from its value without current
- Irms for a 40 °C rise above 25 °C ambient.
- Tested L: WK4237METER

RDC: HK502BC METER

Isat, Irms : WK3260B/ 3265B METER

Packaging

PLATE DIMENSIONS

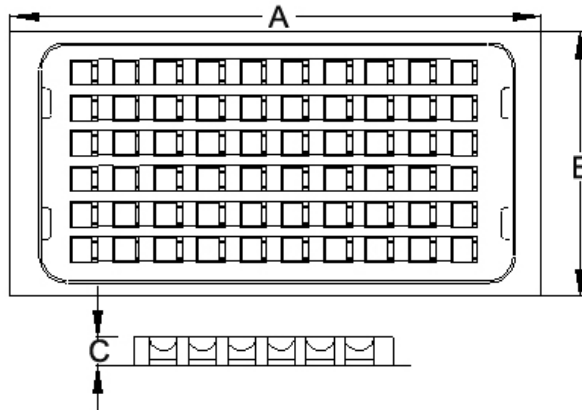

PACKAGING QUANTITY

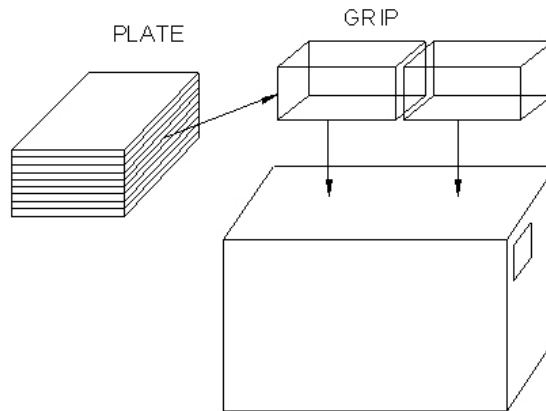

Dimensions in mm

TYPE	PLATE DIMENSIONS			QUANTITY				
	A	B	C	BULK	PLATE	PLATE/GRIP	GRIP	BOX
DMI0707	250	220	10	✓	100	10	2	2000
DMI0807	250	220	10	✓	100	10	2	2000
DMI0808	250	220	10	✓	100	10	2	2000
DMI0809	250	220	10	✓	100	10	2	2000
DMI0909	250	220	13.5	✓	100	8	2	1600
DMI1009	250	220	13.5	✓	100	8	2	1600
DMI1108	250	220	13.5	✓	100	8	2	1600
DMI1109	250	220	13.5	✓	100	8	2	1600
DMI1110	250	220	13.5	✓	100	8	2	1600
DMI1208	250	220	13.5	✓	100	8	2	1600
DMI1209	250	220	13.5	✓	100	8	2	1600
DMI1210	250	220	13.5	✓	100	8	2	1600
DMI1212	250	220	13.5	✓	100	8	2	1600
DMI1213	250	220	12	✓	50	8	2	800
DMI1214	250	220	12	✓	50	8	2	800
DMI1215	250	220	12	✓	50	8	2	800

CPUD Series

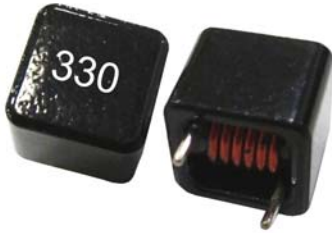

CPUD series is designed for low RDC and ultra large current application. Its assembly model magnetic shielded type is suitable for high-density mounting and ultra low buzz noise. Soldering conditions can be easily confirmed when mounting onto the board.

Features

- Excellent for power line DC-DC conversion applications
- Shielded construction
- Low DCR/ μH , in this package series
- Handle high transient current spikes without saturation
- Ultra low buzz noise, due to composite construction

Applications

- Excellent for power line DC-DC conversion applications used in power switching, personal computers and other handheld electronic equipment

Product Identification

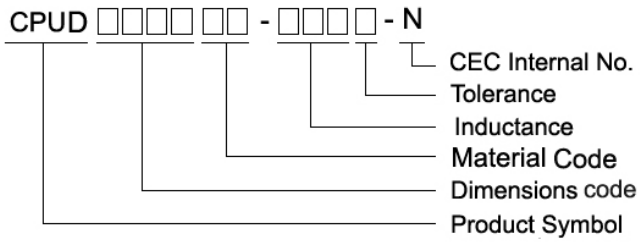

Shapes and Dimensions

FIG 1

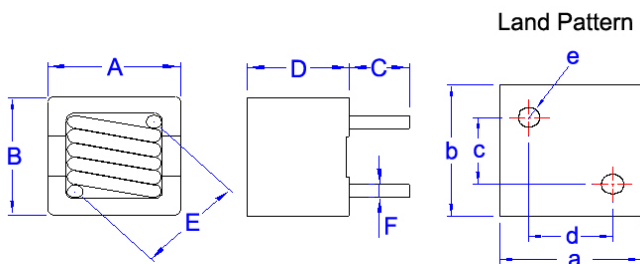
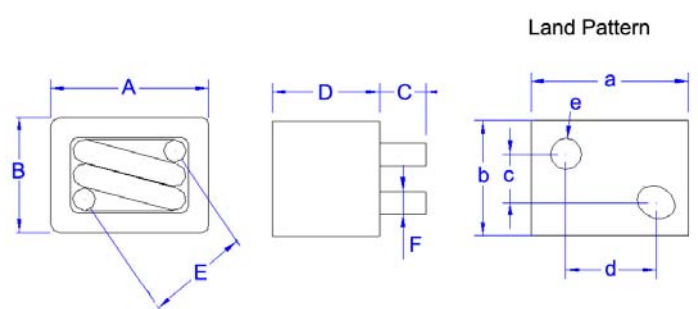

FIG 2



Dimensions in mm

TYPE	FIG	A	B	C	D	E	F	a	b	c	d	e
CPUD0806MN	1	8.2^{+0}	8.2^{+0}	3.5 ± 0.5	7.5^{+0}	6.5 ± 0.5	0.8 ± 0.1	9.0	9.0	4.3 ± 0.5	4.9 ± 0.5	2
CPUD1108IR	2	11.7^{+0}	9.7^{+0}	3.5 ± 0.5	8.5^{+0}	7.8 ± 0.5	1.4 ± 0.1	12.0	10.0	4.2 ± 0.5	6.6 ± 0.5	2
CPUD1310IR	2	13.5^{+0}	12.5^{+0}	3.5 ± 0.5	10^{+0}	10.5 ± 0.5	1.0 ± 0.1	14.2	13.2	7.0 ± 0.5	7.8 ± 0.5	2

Electrical Characteristics

Part Number	Inductance (μ H)	Tolerance (\pm %)	Test Frequency (KHz)	RDC ($m\Omega$) \pm 8%	Isat (A) Max	Irms (A) Max	Marking
CPUD0806MN-R60M-N	0.6	20	100	2.1	24	20	R60
CPUD0806MN-1R0M-N	1.0	20	100	3.0	15	18	1R0
CPUD0806MN-1R5M-N	1.5	20	100	4.5	11	13	1R5
CPUD0806MN-2R2M-N	2.2	20	100	4.5	8	13	2R2
CPUD0806MN-3R3M-N	3.3	20	100	6.8	7	11	3R3
CPUD0806MN-4R7M-N	4.7	20	100	12.0	5	7	4R7
CPUD1108IR-R30M-N	0.30	20	100	0.65	50	43	R30
CPUD1108IR-R56M-N	0.56	20	100	1.00	42	35	R56
CPUD1108IR-1R0M-N	1.0	20	100	2.00	50	28	1R0
CPUD1108IR-1R5M-N	1.5	20	100	3.65	30	20	1R5
CPUD1108IR-2R0M-N	2.0	20	100	5.20	27	15	2R0
CPUD1310IR-1R0M-N	1.0	20	100	1.15	42	32	1R0
CPUD1310IR-1R5M-N	1.5	20	100	1.85	42	26	1R5
CPUD1310IR-2R0M-N	2.0	20	100	3.50	35	21	2R0
CPUD1310IR-3R3M-N	3.3	20	100	5.00	22	17	3R3
CPUD1310IR-4R7M-N	4.7	20	100	8.60	17	12	4R7

- Isat for inductance drops 20% from its value without current
- I rms for a 40°C rise above 25°C ambient.
- Customized Specifications are available.
- Tested L: WK4237METER
RDC: HK502BC METER
Isat - I rms : WK3260B/ 3265B METER

Packaging

PLATE DIMENSIONS

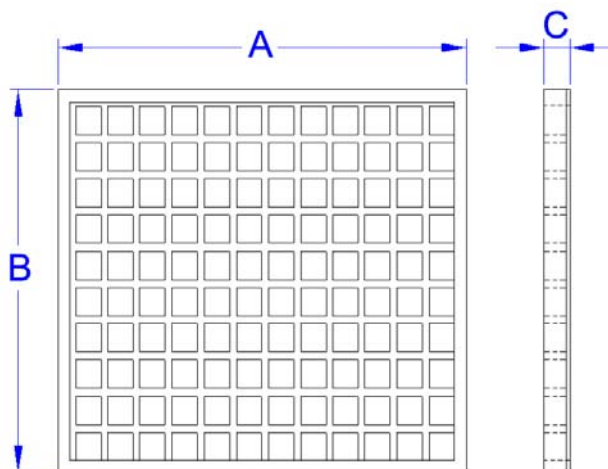

PACKAGING QUANTITY

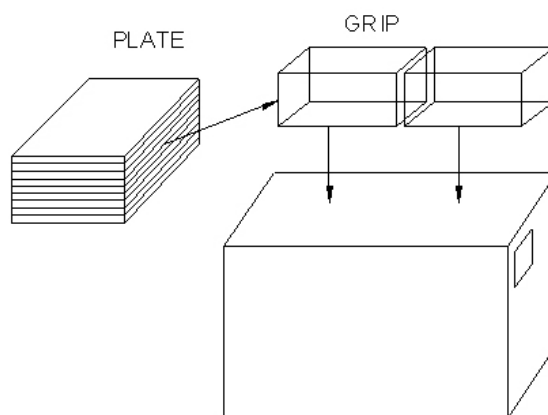

Dimensions in mm

TYPE	PLATE DIMENSIONS			QUANTITY				
	A	B	C	BULK	PLATE	PLATE/GRIP	GRIP	BOX
CPUD0806MN	255	210	14	✓	200	10	2	4000
CPUD1108IR	230	150	12	✓	120	10	2	2400
CPUD1310IR	230	150	15	✓	100	10	2	2000

Certificate

CERTIFICATE
 Number: 203406-2
 The management system of
Chilisin Electronics Corp.
 No. 29, Lane 301, Tehshing Rd,
 Hosing Village, Hukou Hsing
 ROC-Hsinchu Hsien
 Taiwan

Including the implementation meets the requirements of the standard
ISO 9001:2008

Scope:
 Design, manufacture, sales and distribution of inductors, RF components, sensors, protection devices and magnetic components

Certificate expiry date: 11 August 2014
 Certified for the first time: 7 April 2004
 Certificate effective date: 8 August 2011

DEKRA Certification B.V.

 Mr. J. J. Zuijdam
 Managing Director

Mr. H. J. Beltman
 Certification Manager

© Integral publication of this certificate and adjoining reports is allowed

All testing, inspection, auditing and certification activities of the former KEMA Quality are an integral part of the DEKRA Certification Group.

DEKRA Certification B.V. | Uithoornweg 215, 6972 AR Arnhem P.O. Box 1181, 6602 ED Arnhem, The Netherlands
 T +31 26 380 2300 F +31 26 382 2650 www.dekra-certification.com Company registration 0302026

BUREAU VERITAS
 Certification

Certification
 Awarded to
CHILISIN ELECTRONICS CORP.
 奇力新電子股份有限公司

NO. 29, LANE 301, TEH-HSIN ROAD, HOSIN, HUKOU HSIENCHU, TAIWAN, R.O.C.
 奇力新電子股份有限公司 301 巷 29 號
 奇力新 奇力新

Bureau Veritas Certification certifies that the Management System of the above organization has been audited and found to be in accordance with the requirements of the management system standards detailed below

Standards
ISO 14001:2004

Scope of supply
 DESIGN, MANUFACTURE, SALES AND DISTRIBUTION OF INDUCTORS, FILTERS, RF COMPONENTS, SENSORS, PROTECTION DEVICES, AND MAGNETIC COMPONENTS
 電感、濾波器、RF 元件、保護裝置、磁元件之設計、製造與銷售

Original Approval Date: 14 December 2004

Subject to the standard and conformity operations of the organization's Management System, this certificate is valid until: 13 Dec. 2013
 To check the certificate validity please call +862 2 2670 7655
 Further clarifications regarding the scope of this certificate and the applicability of the management system requirements may be obtained by consulting the organization

Date: 25 May 2010
 Certificate Number: TW15042E

DEKRA Certification B.V. | Uithoornweg 215, 6972 AR Arnhem P.O. Box 1181, 6602 ED Arnhem, The Netherlands
 T +31 26 380 2300 F +31 26 382 2650 www.dekra-certification.com Company registration 0302026

CERTIFICATE
ISO/TS 16949:2009

DEKRA
 Certification

hereby certifies that the company
Chilisin Electronics Corp.

Location
 No. 29, Lane 301, Tehshing Rd Hosing Village, Hukou Hsing * ROC-303 Hsinchu Hsien
Business field:
 Design, manufacture of inductors / filters, RF components, sensors protection devices and magnetic components for automotive applications

has implemented a quality management system and applies it effectively. Audit report placed in agreement with the requirements of ISO/TS 16949:2009 (2009:09-15). Evidence of conformity was found during the cert. cat on audit Report No. 2004101-2 With 7.3 Product Development

Date of the first certification: 12 08 2008
 This certificate is valid from: 08 08 2011
 This certificate is valid to: 07 08 2014
 Certificate registration no.: 102411082
 IATF number: 0126385

DEKRA Certification GmbH | Heubornstraße 10 | D-70336 Stuttgart | www.dekra-certification.com

SONY

2011 / 08 / 15

Notification of Green Partner Certification

Attn : Chilisin Electronics Corp.

Thank you for your cooperating Sony Green Partner Audit.
 We will inform you of new certified factories and Green Partner validity expiry date.

経銷工場 / Green Partner Certified Factories

FC	MC Name(ENH)	FC Name(ENG)	Expiry Date
FC004116	Chilisin Electronics Corp.		2013/08/31
FC011007	Dongguan Chilisin Electronics Co., Ltd.		2013/08/31

Green Partner Secretariat
 Procurement Group
 Sony Corporation

SAMSUNG **Eco-Partner Certificate**

Certificate Number : **66C-6816**
 Certificate Validity : **Apr.'11 ~ Apr.'13**

Samsung Electronics hereby certifies that
CHILISIN ELECTRONICS CORP.
 as Eco-Partner Affiliate Company. This company has fulfilled the Samsung Electronics Standards for control of substances with environmental impacts within products, and has established stable environmental quality control system.

Apr.08th, 2011
 Yoon-Woo Lee
 Vice Chairman S.C.E.O

Yoon Woo Lee

Samsung Electronics Co., Ltd.