

# *The use of soft ferrites for interference suppression*

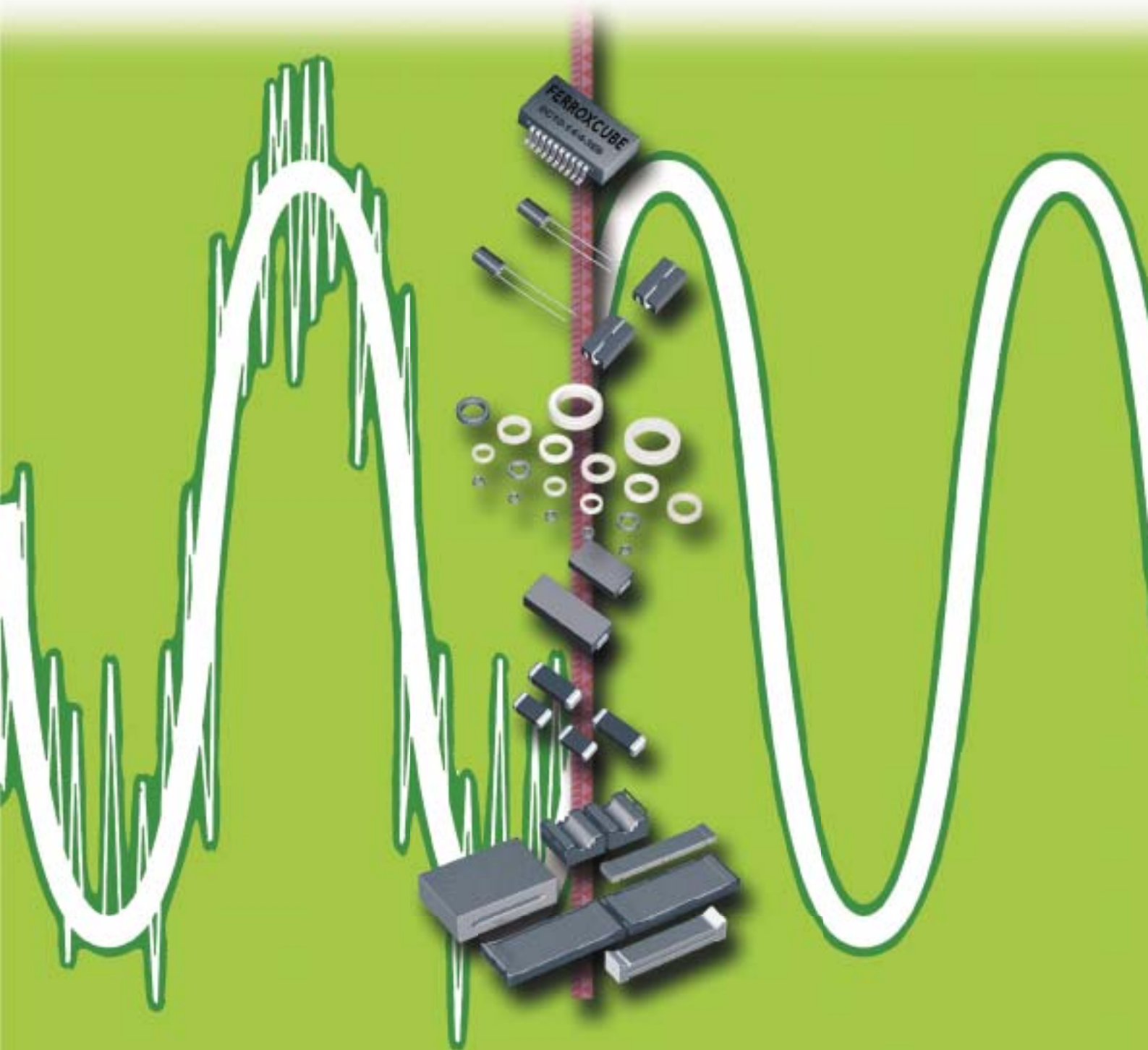

# The Use of Soft Ferrites for Interference Suppression

## Contents

Introduction	1
General principles of EMC	2
EMC regulations	2
Material specifications	7
EMI-suppression product lines	12
Applications	14
Design considerations	18
Impedance concept	18
Literature, software and sample boxes	19

# I. Introduction

In the field of electromagnetic compatibility several trends attribute to a growing necessity of EMC engineering.

### **In signal processing :**

- Change from analog to digital (steep pulse edges, overshoot, ringing).
- Increase of clock frequencies.

### **In power conversion :**

- Change from linear to switched-mode supplies (high switching frequency, harmonics).
- Increase of switching frequencies.

These trends, directed to functional upgrading or reducing cost, inevitably also contribute to an increasing level of electromagnetic interference (EMI) emissions. Together with the increasing use of electronics this leads to a general EMC degradation. As a consequence, EMC legislation is getting world-wide more strict.

The most important regulations are the European Norms (EN) which are applicable in all European Union (EU) and European Free Trade Associated (EFTA) countries, FCC in United States and VCCI in Japan. The uniform legislation in the European Union is along the lines of the EMC directive 89/336/EEC. For every product to which no specific European norm applies, a general regulation is mandatory. These are the so called Generic Requirements (residential, commercial and light industry: EN 61000-6-3 for emissions and EN 61000-6-1 for immunity). This includes all electric and electronic products, no matter how trivial they seem to be !

Of course the first step to avoid interference problems is a good design practice, to tackle the problem right from the start. This can be insufficient if the interference is directly related to the inherent operating principle and too late if the interference is detected not earlier

than in the final design phase. In such cases extra suppression components are necessary, like ferrites, capacitors or shielding elements.

Ferrites provide a solution to many problems of conducted and (indirectly) radiated interference.

They can be applied almost anywhere :

- Shifted on wire or cable as beads, tubes or cable shields.
- Mounted on PCB as beads-on-wire, wideband chokes, SMD inductors, multilayer suppressors or integrated inductive components.
- Ring cores or U cores in mains filters, in the circuit, in a separate box or moulded in a connector.
- Wideband chokes or coiled rod inductors in electrical appliances or motors.

No ground connections are necessary as ferrites are connected in series with the interfering circuit and not in parallel as in the case of a capacitor. The wideband, lossy impedance makes ferrites well-suited as RF suppressor component.



## 2. General principles of EMC

### 2.a. Regulations

Historically, all EMI regulations stated emission limits only. These define the maximum level of interference allowed as a function of frequency. In case of conducted interference it applies to the voltage on all inputs and outputs of the equipment, in case of radiated interference it applies to the field strength at a certain distance. Often two levels are stated:

- Class A for commercial and industrial areas.
- Class B for domestic and residential areas.

Class B is always stricter than class A. Also immunity is becoming subject of regulation. Taking into account the severity of the EMC problem, equipment must also be able to operate without functional degradation in a minimum EMI ambient. The difference between the actual level of emissions or susceptibility and the EMC limits is the required attenuation by filtering or shielding.

### 2.b. Sources and propagation

The source determines whether the interference is a transient or random variation in time (commutation motors, broadcast transmitters etc.) or a periodic signal (e.g. switched-mode power supplies). The frequency spectrum will be continuous in the first case and a line spectrum in the second. In practice, the minimum and maximum frequency involved are much more relevant and both types of sources can be broadband. Random variations are broadband if

they are very fast, harmonic disturbances if the basic frequency is high or if the deviation from a sine wave is considerable.

Interferences can propagate as an electromagnetic wave in free space. Suppression then requires shielding with conductive materials. Also propagation occurs via conductive paths such as the mains network, to which the majority of electrical equipment is connected. Below 30 MHz this is the main propagation mode. Suppression is done with a high impedance in series (inductor), a low impedance in parallel (capacitor) or a combination of both (filter).

Propagation via the mains can take place in two different modes : common and differential mode. Apart from phase and null which carry the supply current, there is the safety earth connection, which is generally taken as a reference.

### Common-mode :

Phase and null interference voltages are equal. This is likely to occur if phase and null are close together and interference is coupling in from an external field (radiation or cross-talk).

### Differential-mode :

Phase and null interference voltages have opposite phase angle but equal magnitude. This is likely to occur in case of switching equipment connected to the mains. In general a combination of both types can be present.

### 2.c. Suppression with ferrites

At RF frequencies a ferrite inductor shows a high impedance which suppresses unwanted interference. The resulting voltage over the load impedance will be lower than without suppression component, the ratio of the two is the insertion loss, see Fig. 2.

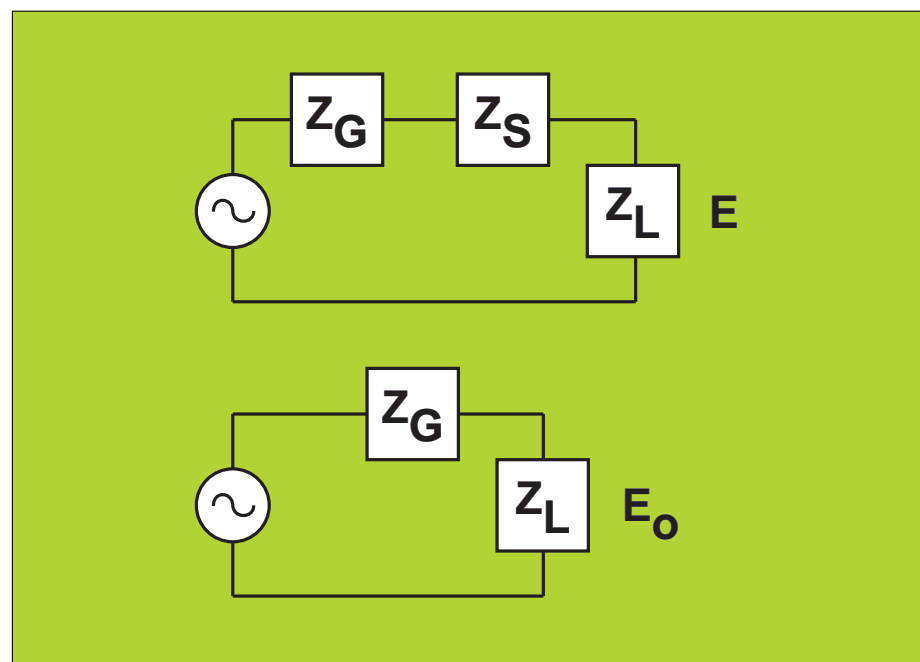

Fig. 2 Insertion loss of an inductor.

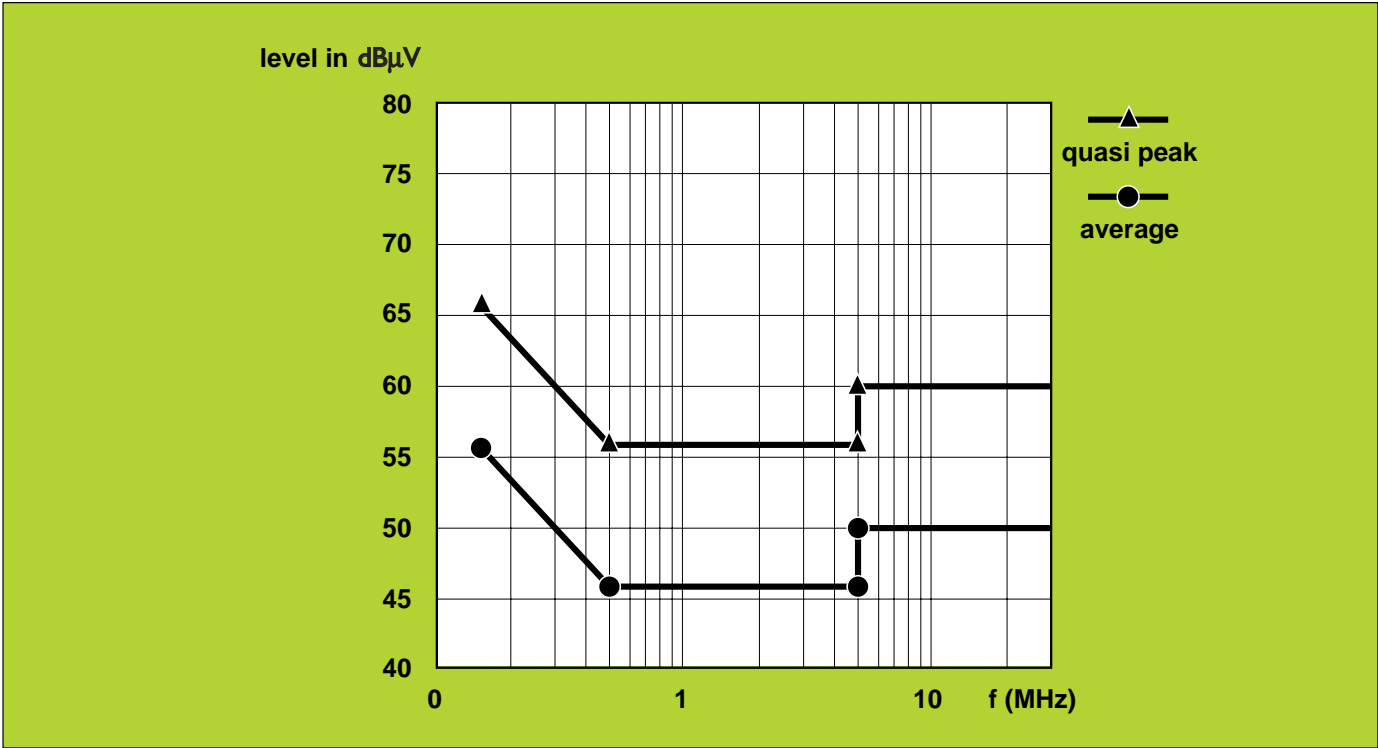

Fig. 1a European generic emission norm 61000-6-3 (residential, commercial, light industry).

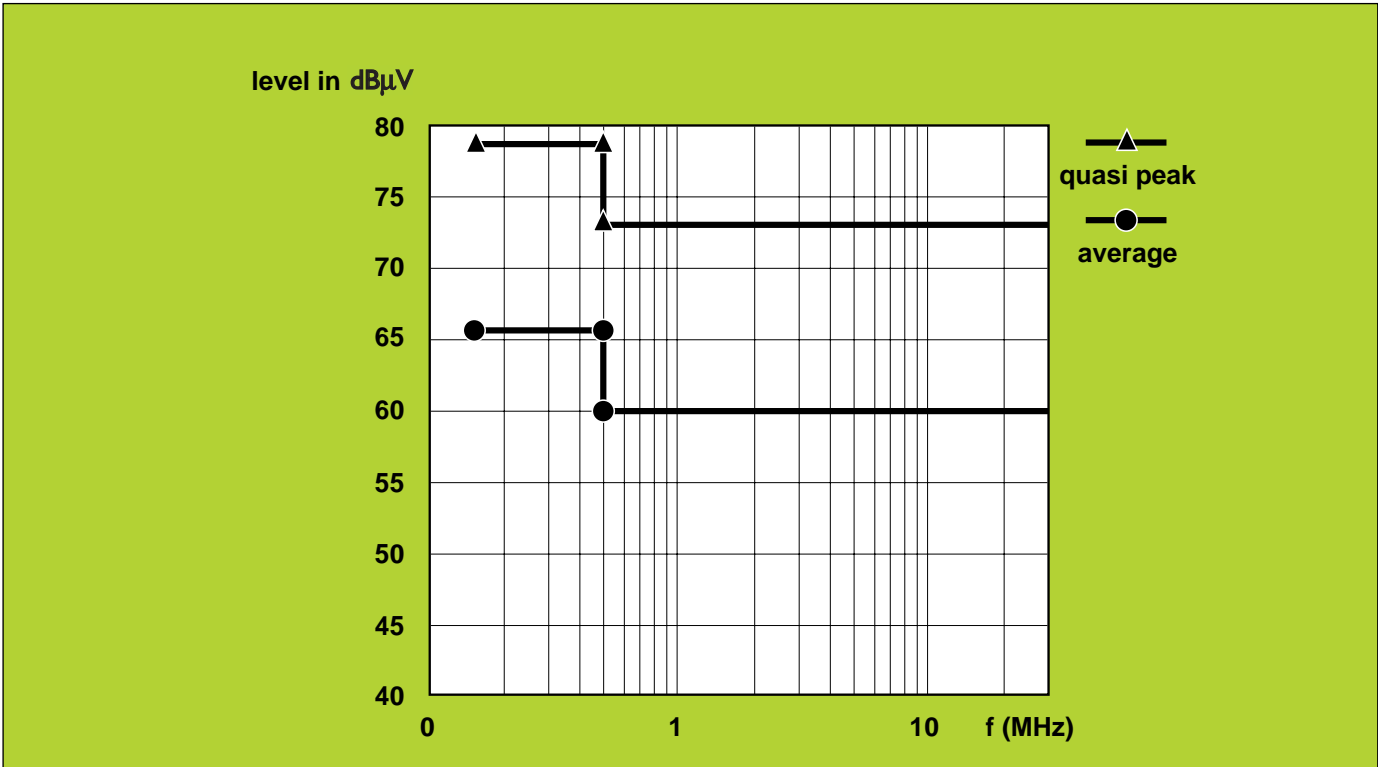

Fig. 1b European generic emission norm 61000-6-1 (industrial environment).

The insertion loss is expressed as :

$$IL = 20 \cdot \log_{10} (E_o/E) \quad [\text{dB}]$$

$$= 20 \cdot \log_{10} \frac{|Z_G+Z_L+Z_S|}{|Z_G+Z_L|} \quad [\text{dB}]$$

The decibel (dB) as a unit is practical because interference levels are also expressed in dB. However insertion loss depends on source and load impedance, so it is not a pure product parameter like impedance (Z). In the application, source and load impedance generally are not 50 Ω resistive. They might be reactive, frequency dependent and quite different from 50 Ω.

Conclusion : insertion loss is a standardized parameter for comparison, but it will not predict directly the attenuation in the application.

At low frequency, a ferrite inductor is a low-loss, constant self-inductance. Interferences occur at elevated frequencies and there the picture changes. Losses start to increase and at a certain frequency, the ferrimagnetic resonant frequency, permeability drops rapidly and the impedance becomes almost completely resistive. At higher frequencies it even behaves like a lossy capacitor. While for most applications the operating frequency should stay well below this resonance, effective interference suppression is achieved up to much higher frequencies. The impedance peaks at the resonant frequency and the ferrite is effective in a wide frequency band around it. The material choice follows from the

critical interference frequencies; ideally they should coincide with the ferrimagnetic resonance frequency, the top of the impedance curve. According to Snoek's law, this resonant frequency is inversely proportional to the initial permeability, which gives us a guide for material choice. The higher the interference frequency, the lower the material permeability should be. The whole RF spectrum can be covered with a few materials if the right permeability steps are chosen. At the resonant frequency and above, the impedance is largely resistive, which is a favourable characteristic of ferrites.

- *Firstly*, a low-loss inductance can resonate with a capacitance in series (positive and negative reactance), leading to almost zero

impedance and interference ***amplification!*** A resistor cannot resonate and is reliable independent of source and load impedances.

- *Secondly*, a resistance dissipates interfering signals rather than reflecting them to the source. Small oscillations at high frequency can damage semiconductors or negatively affect circuit operation and therefore it is better to absorb them.
- *Thirdly*, the shape of the impedance curve changes with the material losses. A lossy material will show a smooth variation of impedance with frequency and a real wideband attenuation. Interferences often have a wideband spectrum to suppress.



## 2.d. Current-compensation

Ferrite inductors inserted separately in both lines suppress both common and differential mode interference. However, saturation by the supply current can be a problem. Remedies are a low permeability material, a gapped or open circuit core type. Disadvantage is the larger number of turns required to achieve the same inductance, leading to higher copper losses. All this can be overcome with current-compensation. Phase and null supply currents are opposite and have equal magnitude. If both conductors pass through the same holes in the ferrite core, the net current is theoretically zero and no saturation occurs. In other words, these currents generate opposite fluxes of equal magnitude that cancel out.

In practice, some stray flux will occur. The stray flux paths will not coincide and these fluxes do not cancel out.

### Examples of current-compensated inductors :

- A ring core with two windings with equal number of turns. The winding directions are such that the incoming current through one winding and the equally large outgoing current through the other generate opposite fluxes of equal magnitude. Current-compensation would be almost ideal with both windings along the total circumference, one over the other. But in practical cases each winding is placed on one half of the ring core because of insulation requirements.
- A twisted wire inductor, which is wound with the twisted wire pair as if it were a single wire.

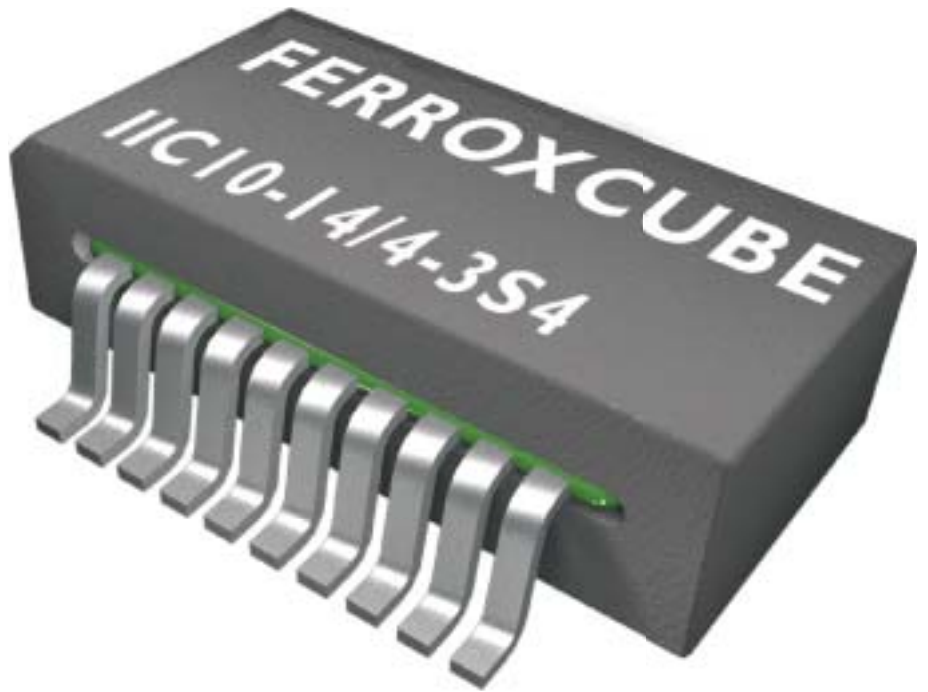

- A tube or round cable shield shifted on a coaxial cable.
- A flat cable shield, shifted on a flat cable. Here the net current of all inductors together is zero.

In case of an I/O cable, such as coax or flat cable, the problem will not be saturation by high current. The reason for the current-compensation is now that the actual signal is also of RF frequency and it would be suppressed together with the interference. The current-compensated inductor has one limitation: it is only active against common-mode interference. However the small leakage inductance will also suppress some differential-mode interference.



*Assortment of EMI-suppression ferrite products*



### 3. Material specifications

There are different material categories :

- **Manganese-zinc ferrites (MnZn)**

These ferrites have a high permeability but also a low resistivity and are most effective at low frequencies. The ferrites 3S3 and 3S4 have a higher resistivity and are real wideband materials as well. 3S5 has been designed for high dc bias at high temperature.

- **Nickel-zinc ferrites (NiZn)**

These materials usually have a lower permeability but much higher electrical resistivity than the manganese-zinc ferrites and are effective up to 1000 MHz. 4S60 has the highest permeability and 4S3 was added for HF suppression.

- **Iron powder**

Permeability of this material is also low but bandwidth is less than for nickel-zinc ferrites because of their low resistivity. Their main advantage is a saturation flux density which is much higher than for ferrites, so they are suitable for very high bias currents.

The main material parameters are given in the table while the typical impedance curves are given in Fig. 5. For manganese zinc ferrites the frequency at which the impedance peaks, is given in Fig. 6.

**Main material parameters.**

The impedance peak frequency versus permeability curve clearly confirms Snoek's law. For the nickel

zinc ferrites the same law is valid, but at high frequency the picture is more complex. Apart from resonant losses, eddy current losses will play an important role. They reduce the impedance at high frequencies for manganese zinc ferrites. For nickel zinc ferrites they are not very important below 100 MHz due to the much higher resistivity. The 4A15 curve in Fig. 5 peaks at 100 MHz although permeability is higher than that of 3B1. A second complicating factor is parasitic coil capacitance. The 4B1 and 4C65 curves (measured on the same ring size and with equal number of turns for comparison) are limited by coil capacitance, whereas the 4S2 and 4S3 curves of Fig. 9 and 10 were measured on a bead (N=1) and peaks at higher frequency.

Type	Material	$\mu_i$	$B_{sat}$ (mT)	$T_c$ (°C)	$\rho$ ( $\Omega m$ )
Manganese Zinc	3E8	18000	350	100	0.1
	3E7	15000	400	130	0.1
	3E6	12000	400	130	0.1
	3E5	10000	400	120	0.5
	3E26	7000	450	155	0.5
	3E27	6000	400	150	0.5
	3C11	4300	400	125	1
	3S1	4000	400	125	1
	3S5	3800	545	255	10
	3C90	2300	450	220	5
	3S4	1700	350	110	$10^3$
	3B1	900	400	150	0.2
	3S3	250	350	200	$10^4$
	Nickel Zinc	4S60	2000	260	100
4A15		1200	350	125	$10^5$
4S2		700	350	125	$10^5$
4S3		250	350	250	$10^5$
4C65		125	350	350	$10^5$
Iron Powder	2P90	90	1600	140 *	low



## New materials

Some materials have been added in recent years :

### • Manganese-zinc ferrite 3S5

In order to meet the EMI regulations in the frequency range from 150 kHz up to 30 MHz, FERROXCUBE has introduced its new 3S5 EMI suppression material. Although several ferrites are available for this frequency range, hardly any material can keep its absolute value of complex permeability (defining the inductor's impedance) when operating on a bias field (DC current) at high temperature. With the introduction of 3S5, FERROXCUBE is filling this gap. Applying 3S5 in an inductor gives EMI suppression over the full frequency range and has the major benefit of sufficient permeability even when high bias currents together with high temperature are applied.

### Preferred applications

With the ever increasing demand of interference suppression, 3S5 can be applied in those applications where both high operating temperatures (140 °C) and high currents are involved e.g. power lines in industrial, but especially automotive environments. Suppressing of interference signals along these lines can be achieved by inserting 3S5-based inductors. Suitable core shapes are those that are generally used for EMI suppression.

### • Nickel-zinc ferrite 4S60

New EMI material 4S60 is the high permeability NiZn ferrite ( $\mu_i = 2000$ ) with high resistivity for EMI applications in the frequency range around 30 MHz. Due to its high permeability, 4S60 allows reducing size, if the upgoing slope of the impedance curve is important.

Being 4S60 recommended when wideband impedance is needed for noise filters, preferred applications are:

- Line attenuation
- Current compensated chokes
- Common mode coils

### • Manganese-zinc ferrite 3S3

FERROXCUBE introduces also the high frequency EMI suppression material capable to attenuate unwanted interference up to 1 GHz, the 4S3 material.

With the ever increasing demand of EMI suppression materials for higher frequencies, the material 4S3 completes actual FXC EMI range materials providing designers the capability of suppressing interference up to 1 GHz. Beyond broadband impedance material 4S2, the 4S3 offer excellent impedance for higher frequencies being the attenuation optimum between 250 MHz and 1GHz.

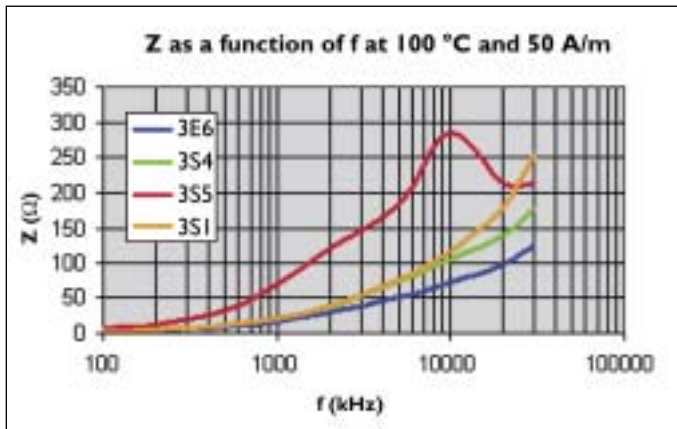

**Fig. 3 Impedance curves at 100 °C, measured on a toroid Ø14 x Ø9 x 5 mm with 5 turns**

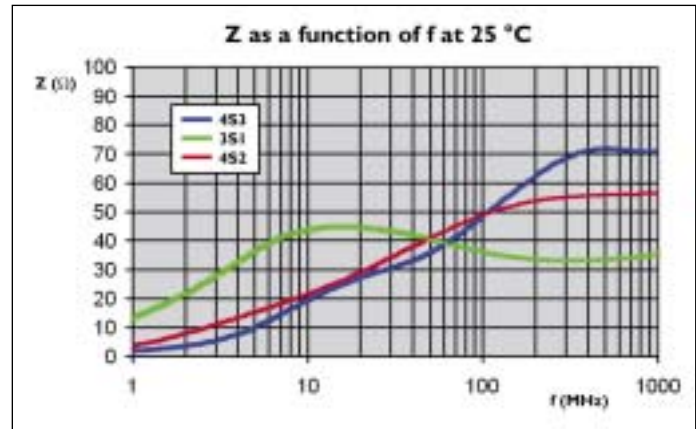

**Fig. 4 Impedance curves at 25 °C, measured on an SMD bead 3 x 3 x 4.6 mm with 5 turns**

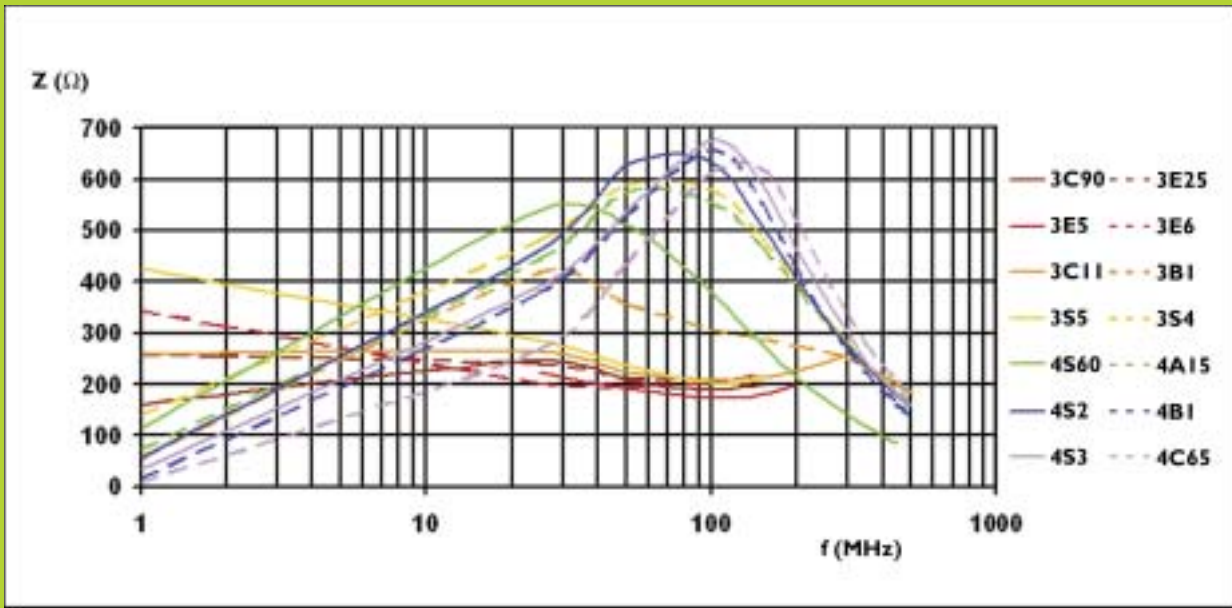

Fig. 5 Impedance versus frequency for several ferrite materials. (measured on TN14/915 ring cores with 5 turns)

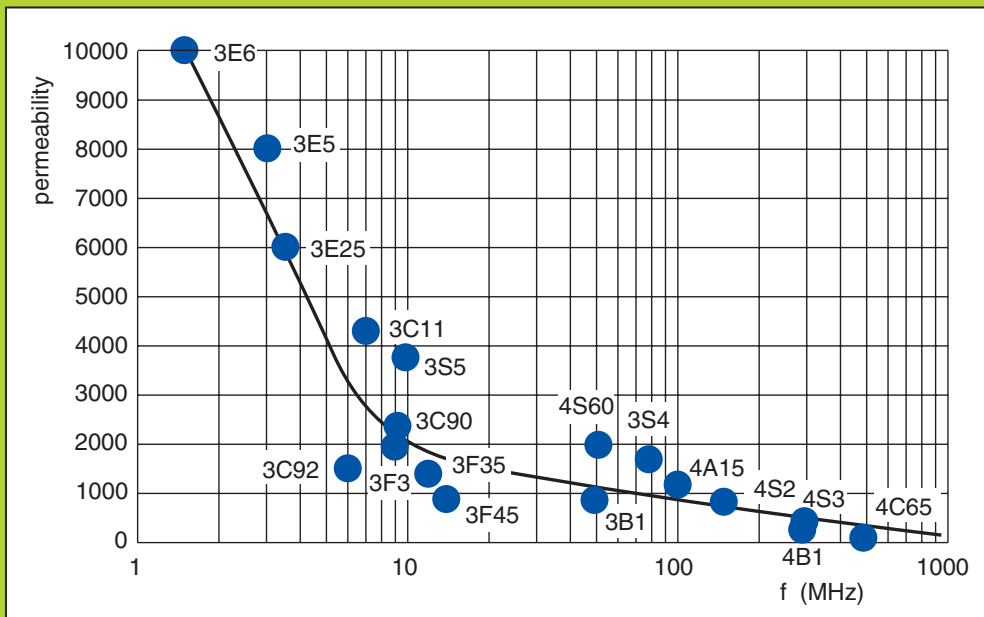
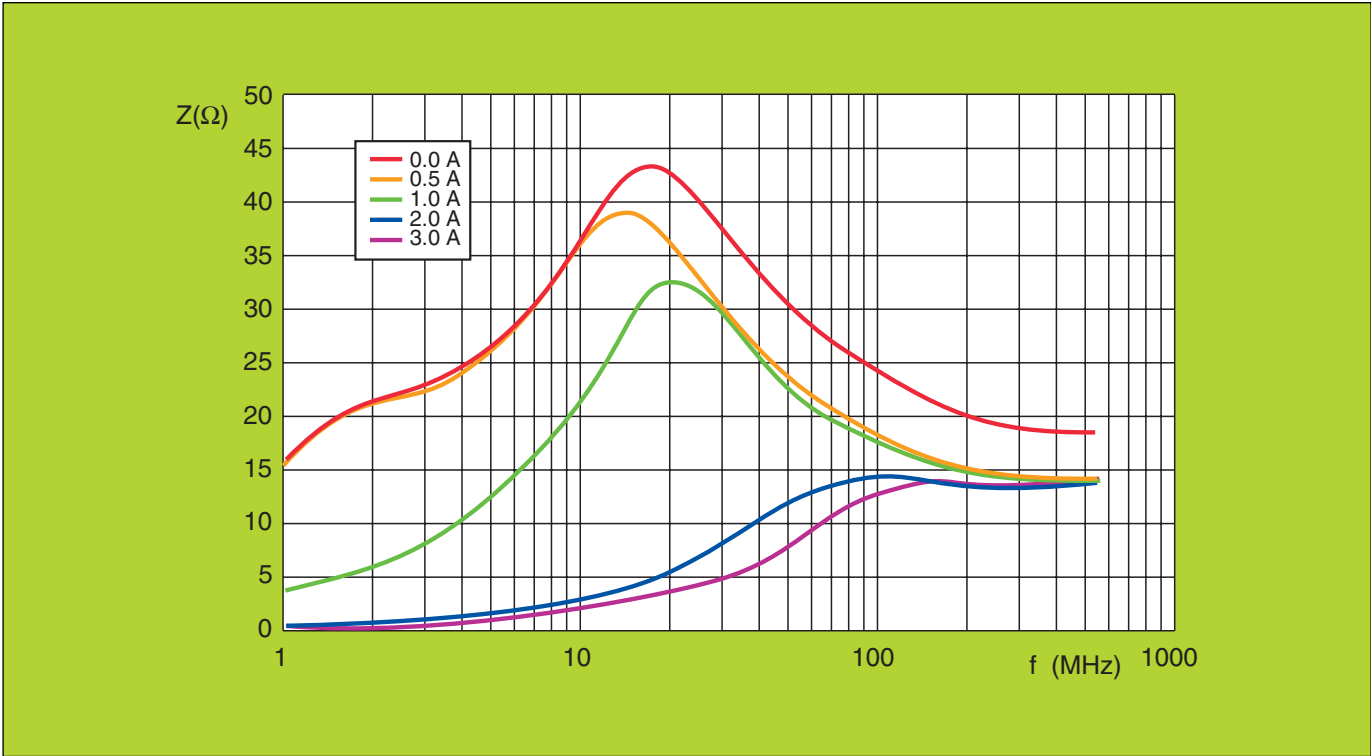
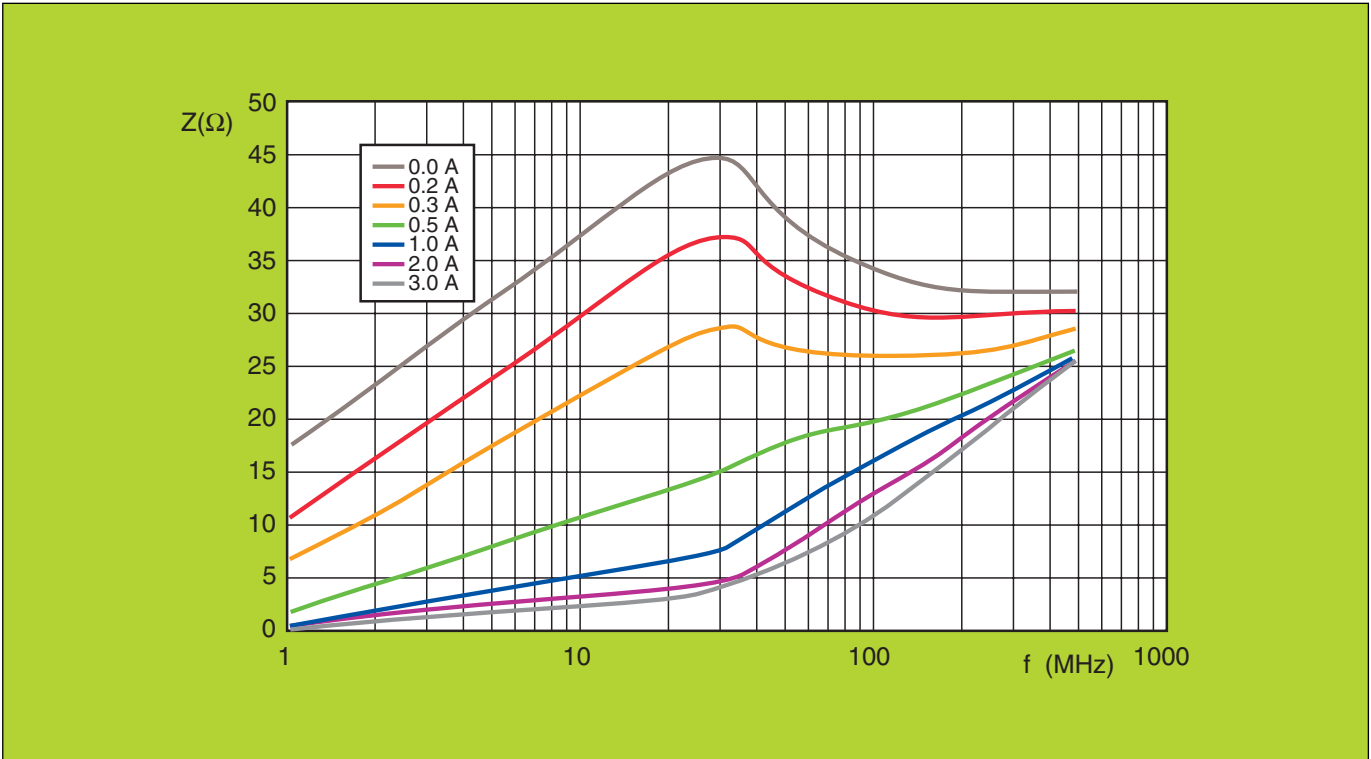

Fig. 6 Frequency of impedance peak for some ferrite materials.



**Fig. 7 Effect of bias current on the impedance of a 3S1 SMD bead. ( measured on BDS3/3/4.6 beads)**



**Fig. 8 Effect of bias current on the impedance of a 3S5 SMD bead. ( measured on BDS3/3/4.6 beads)**

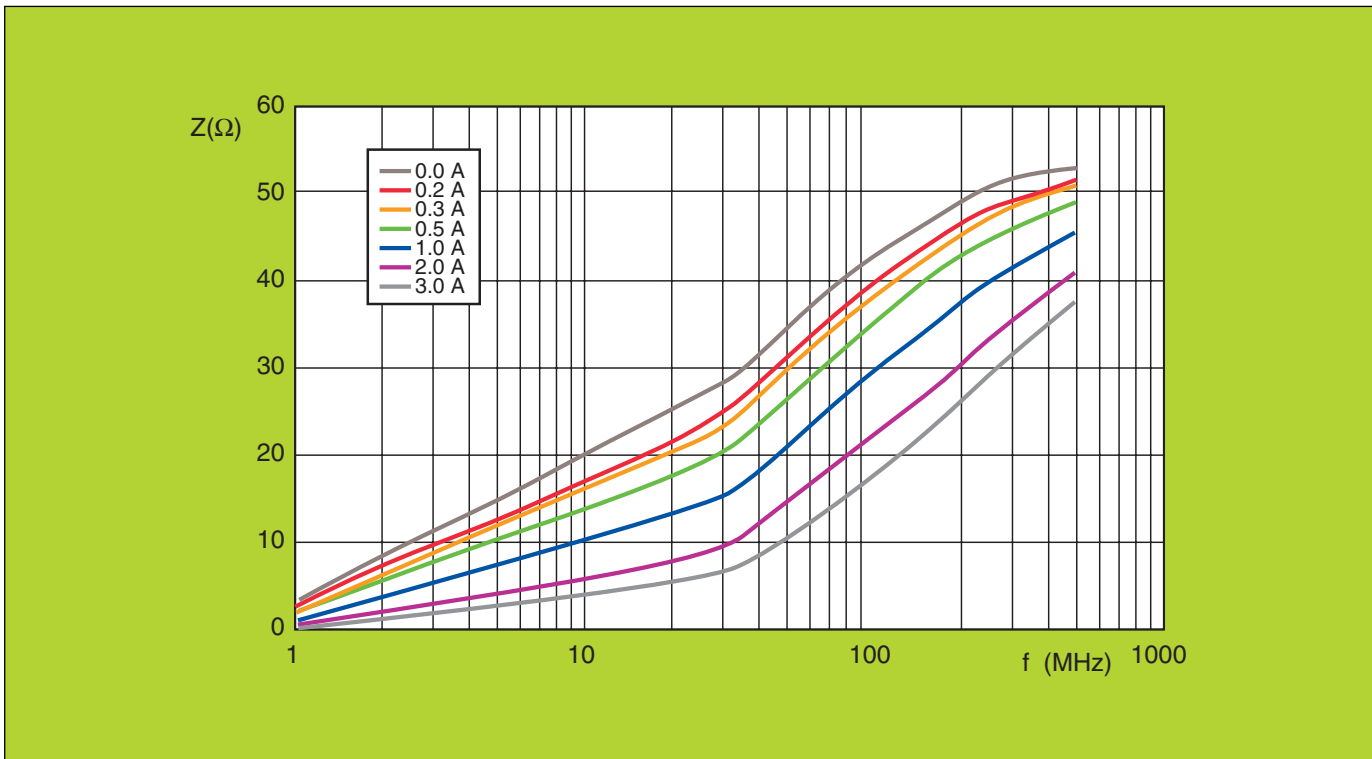

**Fig. 9 Effect of bias current on the impedance of a 4S2 SMD bead. ( measured on BDS3/3/4.6 beads)**

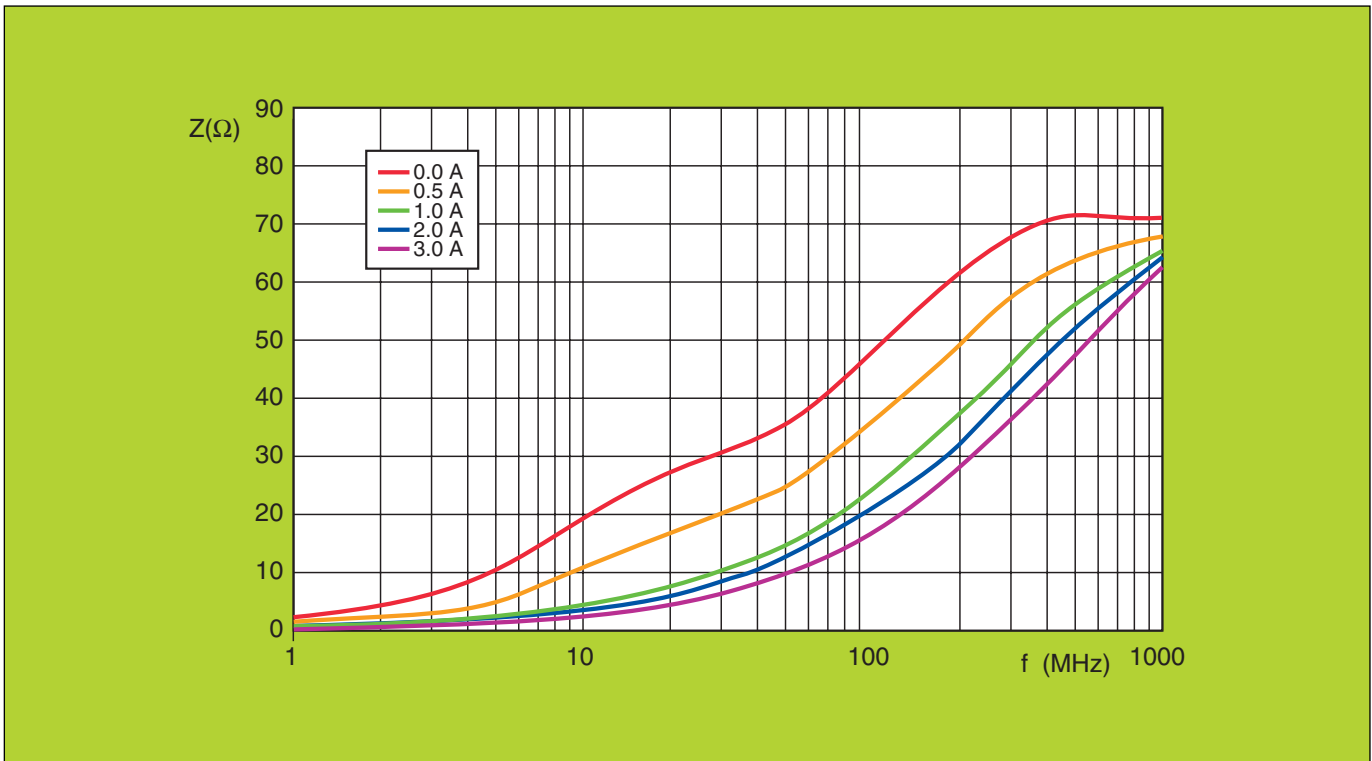

**Fig. 10 Effect of bias current on the impedance of a 4S3 SMD bead. ( measured on BDS3/3/4.6 beads)**

## 4. EMI suppression product lines

A variety of shapes is used for EMI suppression (see the table below). For most of these product types Ferroxcube have defined a standard range with balanced size distribution and logical material selection. Apart from the standard range, products

can be custom designed to fit a specific application. Solderability and taping are in accordance with accepted IEC and EIA norms. A thorough quality control is maintained in all stages of the production process : raw materials inspection, powder batch control, statistical process control (SPC) and production batch control as final inspection. Our production facilities

are certified to ISO 9001 and ISO 14001. For detailed information on product lines, ask for the appropriate product brochure, see at the back. Sample boxes are available to support the designer.

Type	Shape	Main applications
magnetically closed cores	ferrite ring cores iron powder rings tubes beads multihole cores cable shields plate with holes	mains filters lamp dimmers round cable shielding wire & component lead filtering wire filtering (multi-turn) round & flat cable shielding flat cable connector shielding
magnetically open cores	rods bobbin cores	commutation motors in cars power line chokes
inductors	beads-on-wire SMD beads & chokes wideband chokes multilayer suppressors integrated inductive components	PCB supply line / RF filtering PCB supply line / RF filtering domestic appliances, various PCB supply line / RF filtering PCB supply line / RF filtering
Ferroxfoil absorber	flexible sheet	where ever radiation occurs

**Table 2 : Product shapes with their main applications**

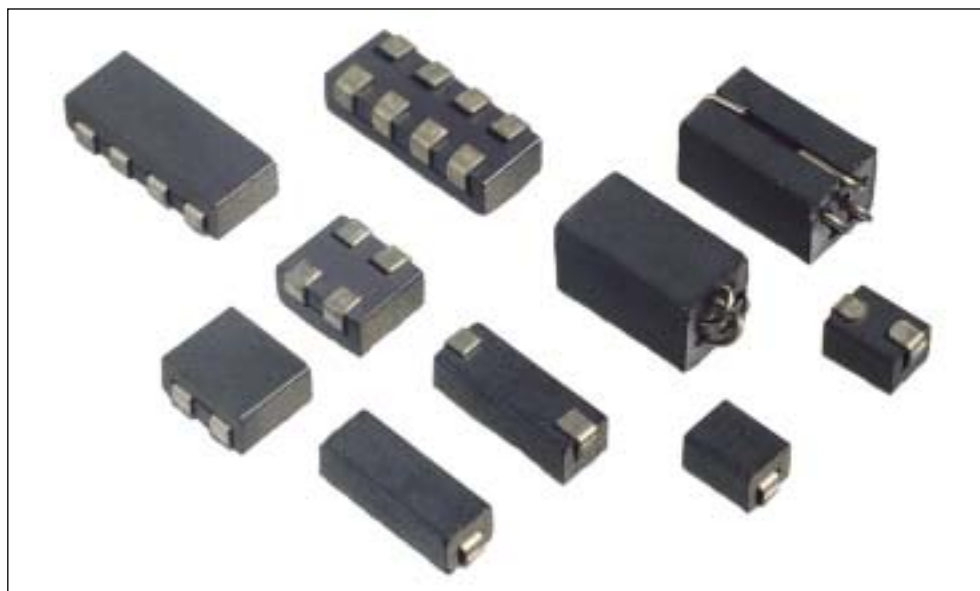

**Range of SMD beads and chokes**



## 5. EMI suppression applications

Whereas the material choice is derived from the EMI frequency band, the core shape and way of winding are largely determined by practical considerations and possible saturation by the load current. According to the last criterion, three application groups can be distinguished : small signal, intermediate and power.

### 5.a. Small signal applications

- **Coaxial cable shielding**

(round cable shield, tubes, ring cores)

- **Flat cable shielding**

(rectangular cable shield)

If the cable carries an information signal, either analog or digital, saturation will be no issue. This is typically the case with cable shielding. Inside diameter is fixed by the cable dimensions and impedance adjusted mainly by the length

and / or number of shields. Impedance depends linearly on length and only logarithmically on the outside dimensions. The product can be in one piece for mounting during manufacturing or split for retrofit solution. A split product uses special clamps to prevent a parasitic air gap with loss of impedance. A very simple (temporal) retrofit solution for flexible cable is winding a few turns on a ring core of large diameter. The large inner diameter and short length (small impedance) are compensated by using more than one turn. The suppression is only common mode.

- **Cable connector shielding**  
(plate with holes)

A built-in suppression for the connector of a flat cable is a ferrite plate with holes fitting over the separate pins. The material must be nickel-zinc to prevent short-circuit. Because the holes are close together, this configuration approximates the common mode

configuration of the above mentioned cable shields.

### 5.b. Intermediate applications

- **Component lead filtering**  
(beads)

Beads are small tubes especially designed for suppression. If a specific known component is the source, e.g. a diode causing overshoot oscillations when entering the non-conductive state, then the bead is shifted directly over the leads of this component.

- **PCB inductors**

(beads-on-wire, SMD beads & chokes, gapped SMD beads, multilayer suppressors, integrated inductive components)

If the source is not known, but the propagation path can be identified, e.g. the DC power supply lines or a fast digital clock line, then this line should be blocked. The bead has two equivalents :

- for through-hole mounting a bead-on-wire (bead glued on a wire, axially taped and reeled).
- for surface mounting an SMD bead (bead with flat wire, blister taped and reeled).

A larger impedance can be achieved with a multi-turn choke. For even higher attenuation either a multilayer suppressor or a complete filter can be made by adding capacitors. SMD ceramic multi-layer capacitors (CMC) are best suited for this purpose because of their very small lead inductance and excellent high-frequency characteristics.





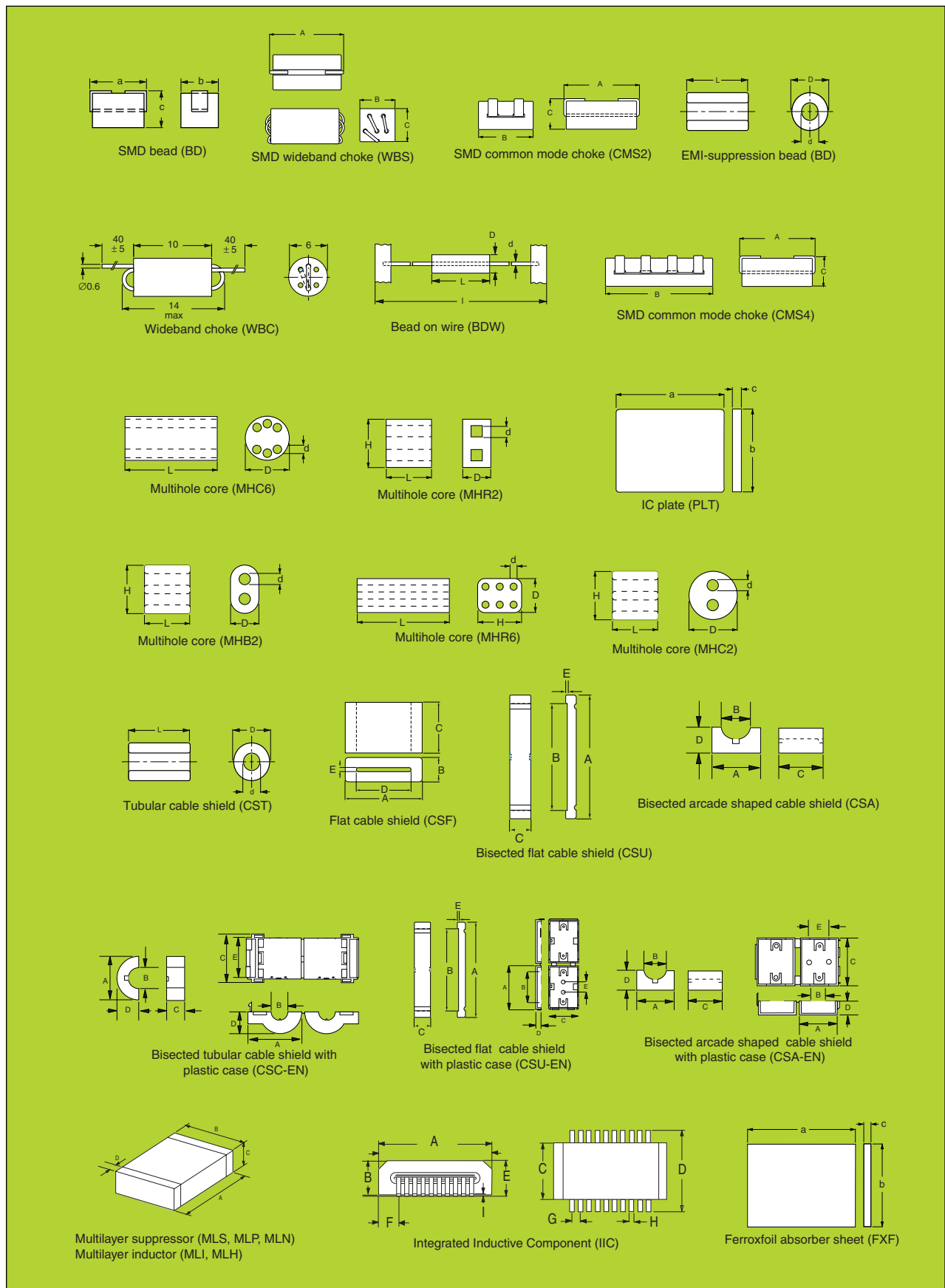

**Fig. 11 Overview of small signal suppression products**

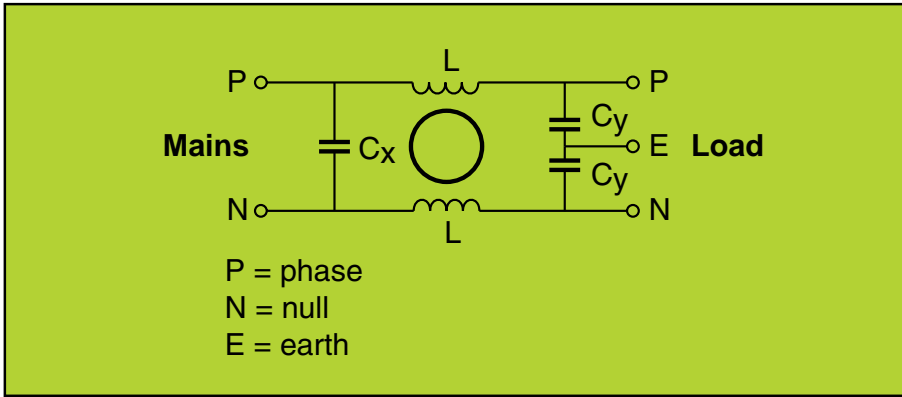

**Fig. 12 Typical mains filter configuration.**

**• Wire filtering**

(beads, two-hole cores)  
 If only the printed circuit board that generates the interference is known, then the wires connecting it with other system boards should be filtered. Wires can be filtered with a bead like component leads. To achieve more impedance, multihole cores are a good solution. The wire is simply drawn through several holes until sufficient impedance is achieved. The system parts are not necessarily boards. In an electric shaver for instance you will find a filter between mains plug and motor consisting often of a bead on either lead, combined with 3 capacitors.

**• Wideband chokes**

Wideband chokes are mounted on different places, often not on circuit boards. Their main advantage is a combination of high impedance and large bandwidth. The wires are wound through holes in the core, thus separating them physically and reducing parasitic coil capacitance. Several insulated types are available to prevent short-circuit between wire bends or of wire bends with other metallic parts.

**5.c. Power applications**

**• Current-compensated chokes in mains filters**

(ferrite ring cores)

Most equipment nowadays has switched-mode power supplies to reduce volume and weight. Electronic circuits have been miniaturised constantly and the remaining subsystems set the size limits. A television set is not much more than a picture tube and a power supply. For EMC purposes, a mains filter is necessary. The same holds for the electronic ballast of energy-saving fluorescent lamps. Mains filters are also manufactured as separate components.

The following components can be found in mains filters :

- two inductors L on the same core for low-frequency attenuation (harmonics of the switching frequency)
- two  $C_y$  capacitors for additional common-mode attenuation (at higher frequencies)
- a  $C_x$  capacitor for differential-mode attenuation

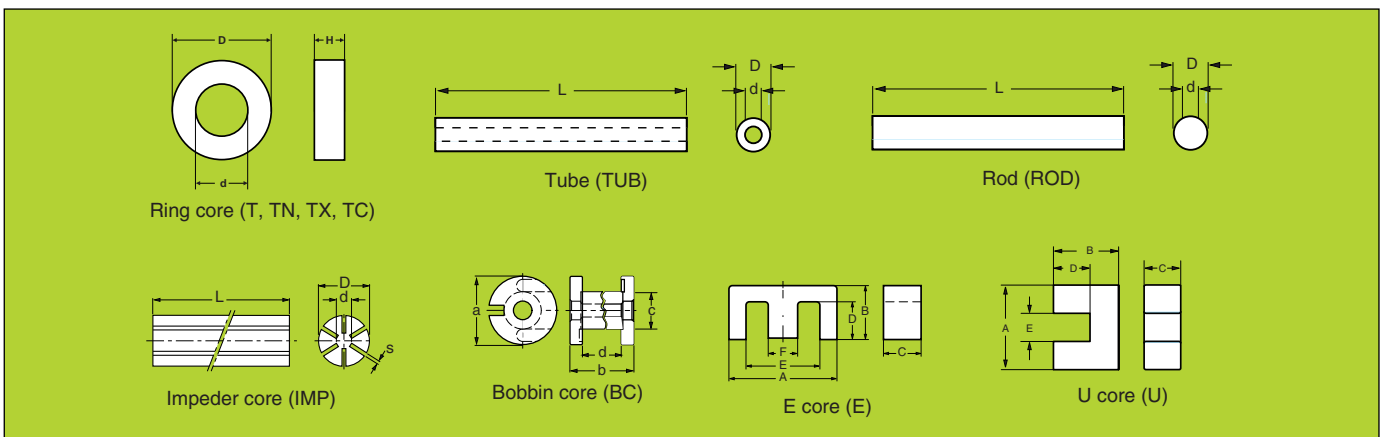

**Fig. 13 Some products used in power applications.**

The choke has to fulfil contradicting requirements : high inductance as well as high rated current. To prevent an unpractical choke size, current-compensation is applied to a ring core in a high-permeability material (see also section 2.d.). Many variations exist according to the specific equipment type, e.g. the compensated choke alone can be moulded in the plug of TV supply cables.

- **Lamp dimmers**

(iron powder ring cores)

Fluorescent lamps cannot be dimmed like incandescent lamps simply by decreasing voltage, because below their threshold they turn off. Electronic dimmers use a variable part of the supply voltage period by means of delayed thyristor ignition. The harmonics of the mains frequency require iron powder i.s.o. laminated silicon iron to reduce eddy current losses. On the ignition instant a parasitic ringing can be observed, of which the frequency (a few MHz) is determined by parasitic inductances and capacitances in the circuit. At MHz frequencies the losses of iron powder are large and the ringing is dissipated in a few periods. Ferrites have much less losses and would reflect a large part of the ringing energy, which could damage the semiconductors of the control circuitry.

- **Power line chokes**

(bobbin cores)

If chokes operate on separate power lines and current-compensation is not possible, then an open core type must be chosen. To reach a high inductance, hundreds of turns can be necessary and a bobbin core is the appropriate shape.



**Range of multilayer suppressors in standard EIA sizes 0402 to 1812**

- **Electric commutation motors in cars (rods)**

In a modern car, many electric commutation motors are applied. There are a starter motor, a fuel pump, small ventilators, screen wiper motors, window lift motors, sun roof motors etc. The commutation

is accompanied by high-frequency sparks which cause RF interference. This will be picked up by the FM radio, but if motor functions are regulated electronically, also safety is at stake. Large currents are involved, starter motor current can be as high as 40 A. Due to the frequency (FM band around 100 MHz) the inductance does not have to be very large and a rod with a single layer winding is the right choice. Motor temperatures can reach 150 °C, so the Curie temperature of the ferrite should be well over 200 °C, in combination with good HF impedance behaviour. The low permeability is no problem in a rod shape. 3S3 is the ideal material for this application.

### **5.d. Radiation suppression applications**

- **IC plates and absorber sheets**

Thin film technology and IC plates provide electromagnetic shielding for multiple applications. IC plates based on an ultra thin ferrite sintered into the form of a plate have been designed specially to be attached on a CPU, or any integrated circuit which requires EMI shielding to assure perfect operation. Ferrofoil thin film sheets based on an absorptive electromagnetic shielding material consist of magnetic material and resin. They suppress noise radiated from electronic equipment over a wide range of frequencies, offer flexibility in fabrication and yield excellent performance for many frequency ranges, being its advantages even relevant for RFID HF band application. Other examples of its use are mobile devices including notebook PCs, digital cameras and cell phones, computer main board, imaging chip.

## 6. Design considerations

Even without any trials or calculations, a lot of problems can be avoided beforehand by good design practices. In order of priority they are :

- avoid generating interference (minimize clock rate, smoothen pulse shape),
- keep it far away (separate power components and circuits from the rest)
- impede its propagation (minimize conductor path length and component lead length),
- suppress with ferrites and capacitors.

The following points should be considered while taking EMI-suppression measures :

- The insertion of ferrite components lowers equally emission and susceptibility, the essence is blocking the propagation path. The ferrite should always be located as close to the source as possible. All intermediate circuitry and cable length acts as antenna and produces radiated interference. The same holds for capacitors or any type of suppression component.
- The ferrite and the conductor should be close together. Beads, tubes and cable shields should fit close around the wire or cable and other core shapes should be wound tightly. If not, then stray flux is present, which converts into mutual inductance if other circuit parts are close enough to be in the stray field.
- Especially for open core types like

rods and bobbin cores, the stray flux can be a problem. Bobbin cores are better than rods. Apart from keeping distance to other circuit parts, the positioning is important. For long thin rods a horizontal position is the best. The core axis is horizontal, so the magnetic field is almost parallel to the PCB and the induced electric field almost perpendicular. This results in only low induced voltages in PCB tracks.

- For inductors with many turns, the winding method influences the parasitic coil capacitance. Too much capacitance causes early frequency roll-off of the impedance.

Ways to reduce parasitic capacitance are multi-chamber winding (separation of turns in groups), and 90 degree cross-winding (electrical decoupling of adjacent turns).

- Capacitors should always be connected with leads as short as possible, because the leads have parasitic inductance (in the order of 10 nH/cm) which causes early frequency roll-off in the attenuation curve. In general filters should be layed-out as compact as possible.

## Appendix A. Impedance concept

### A.1. Material

The impedance curve can be translated to a pure material curve, the so-called complex permeability curve. As impedance consists of a reactive and a resistive part, permeability should have two parts too to represent this. The real part corresponds to the reactance, positive for an inductance, negative for a capacitance, and the imaginary

part to the losses.

$$\begin{aligned} \mathbf{Z} &= j\omega \cdot (\mu' - j\mu'') \cdot L_o \\ &= \omega \cdot \mu'' \cdot L_o + j\omega \cdot \mu' \cdot L_o \end{aligned}$$

$$\mathbf{Z} = \mathbf{R} + j\mathbf{X} \rightarrow$$

$$\mathbf{R} = \omega \cdot \mu'' \cdot L_o ,$$

$$\mathbf{X} = \omega \cdot \mu' \cdot L_o \quad (\omega = 2 \cdot \pi \cdot f)$$

$$\begin{aligned} |\mathbf{Z}| &= \sqrt{(\mathbf{R}^2 + \mathbf{X}^2)} \\ &= \omega \cdot L_o \cdot \sqrt{(\mu'^2 + \mu''^2)} \end{aligned}$$

Where  $L_o$  is the inductance if initial permeability were equal to 1 :

$$L_o = \mu_o \cdot n^2 \cdot A_e / l_e$$

$$(\mu_o = 4 \pi \times 10^{-7} = 1.2566 \times 10^{-6} \text{ [H/m]})$$

For the calculation of effective magnetic dimensions  $A_e$  and  $l_e$ , see next paragraph.

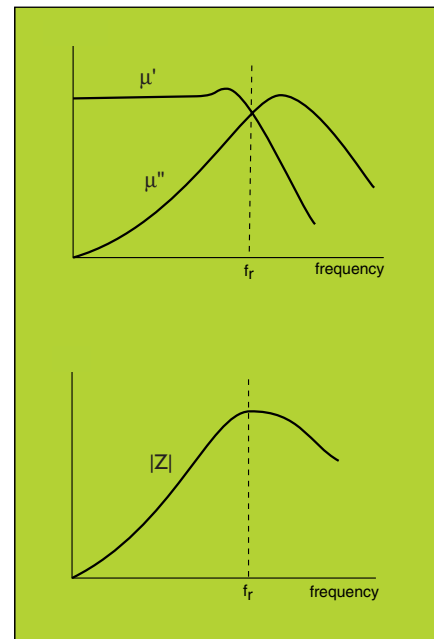

Fig. 14 Complex permeability and impedance.

## A.2. Core size

The choice of a suppression product is made in two steps. First the material choice corresponding to the interference frequencies occurring and afterwards the right core size and turns for the impedance level required.

The simplest way of calculation is taking the impedance curve of a reference core of the same material. Calculation from complex permeability is another possibility, but it's more bothersome. Two factors have to be corrected : effective magnetic dimensions and turns.

$$Z :: N^2 \cdot A_e / l_e \rightarrow$$

$$Z = Z_o \cdot (N^2 / N_o^2) \cdot (A_e / A_{eo}) \cdot (l_{eo} / l_e)$$

The parameters with index o correspond to the reference core. The number of turns N is always an integer number. Half a turn geometrically is 1 turn magnetically. For a bead with a single wire going through,  $N = 1$  turn. The effective magnetic dimensions  $A_e$  (area) and  $l_e$  (length) are calculated from geometric dimensions according to IEC 205. For complicated geometries this involves complex formulas. Therefore the suppliers usually specify these data in their handbooks. For a cylindrical geometry (ring core, tube, bead, bead-on-wire) a simple formula applies :

$$A_e / l_e = h / (2 \cdot \pi) \cdot \ln(OD/ID)$$

**OD** = outer diameter

**ID** = inner diameter

**h** = height

## A.3. Bias current

Often a DC supply or AC mains current is passing through the inductor to allow normal operation of the connected equipment. This current induces a high field strength in the ferrite core, which can lead to saturation. Impedance then decreases along with permeability, especially for low frequencies. The influence of a bias current can be calculated. The induced field strength is directly proportional to the current :

$$H = n \cdot I / l_e$$

Whether this field causes a significant saturation or not, can be seen in the curve of permeability versus bias field. However, this only indicates the decrease of inductance at low frequency. The impedance

at high frequency decreases less. Again, impedance can be calculated from reference curves if they show impedance versus frequency with bias current as a parameter. First, bias current is translated to the current that would induce the same field strength in the reference core, which means the same state of core saturation :

$$I_o = I \cdot (n/n_o) \cdot (l_{eo}/l_e)$$

For a ring core, tube or bead the effective length is

$$l_e = \pi \cdot \ln(OD/ID) / (1/ID - 1/OD)$$

Now the relative impedance decrease will be the same :

$$Z_{bias} = Z \cdot (Z_o \text{ bias} / Z_o)$$

## Literature, Software and Sample Boxes

### General catalogues & Software

Data Handbook : Soft ferrites and Accessories  
Soft Ferrites and Accessories Design Tools Disk

### Specific brochures

Ferroxfoil flexible sheet EMI absorber  
SMD Beads and Chokes  
Gapped SMD beads for power inductors  
3S5 the new medium frequency EMI ferrite for high bias current conditions  
SMD wideband choke with extra metallization  
Wideband Chokes  
Cable Shielding  
Power Inductors  
Multilayer Suppressors and Inductors  
IIC Integrated Inductive Components  
3S4 a new Soft Ferrite for EMI suppression  
3S3 a new Soft Ferrite for EMI suppression

### Sample boxes

SAMPLEBOX9	SMD Beads and Chokes
SAMPLEBOX10	Cable Shielding
SAMPLEBOX11	EMI-suppression Products
SAMPLEBOX12	Multilayer suppressors
SAMPLEBOX13	Multilayer inductors
SAMPLEBOX14	IIC
SAMPLEBOX14A	IIC demo board



**FERROXCUBE**

A YAGEO COMPANY

If you require impedance graphs or other detailed product data,  
which are not presented in this brochure,  
please visit our website at :

**[www.ferroxcube.com](http://www.ferroxcube.com)**