

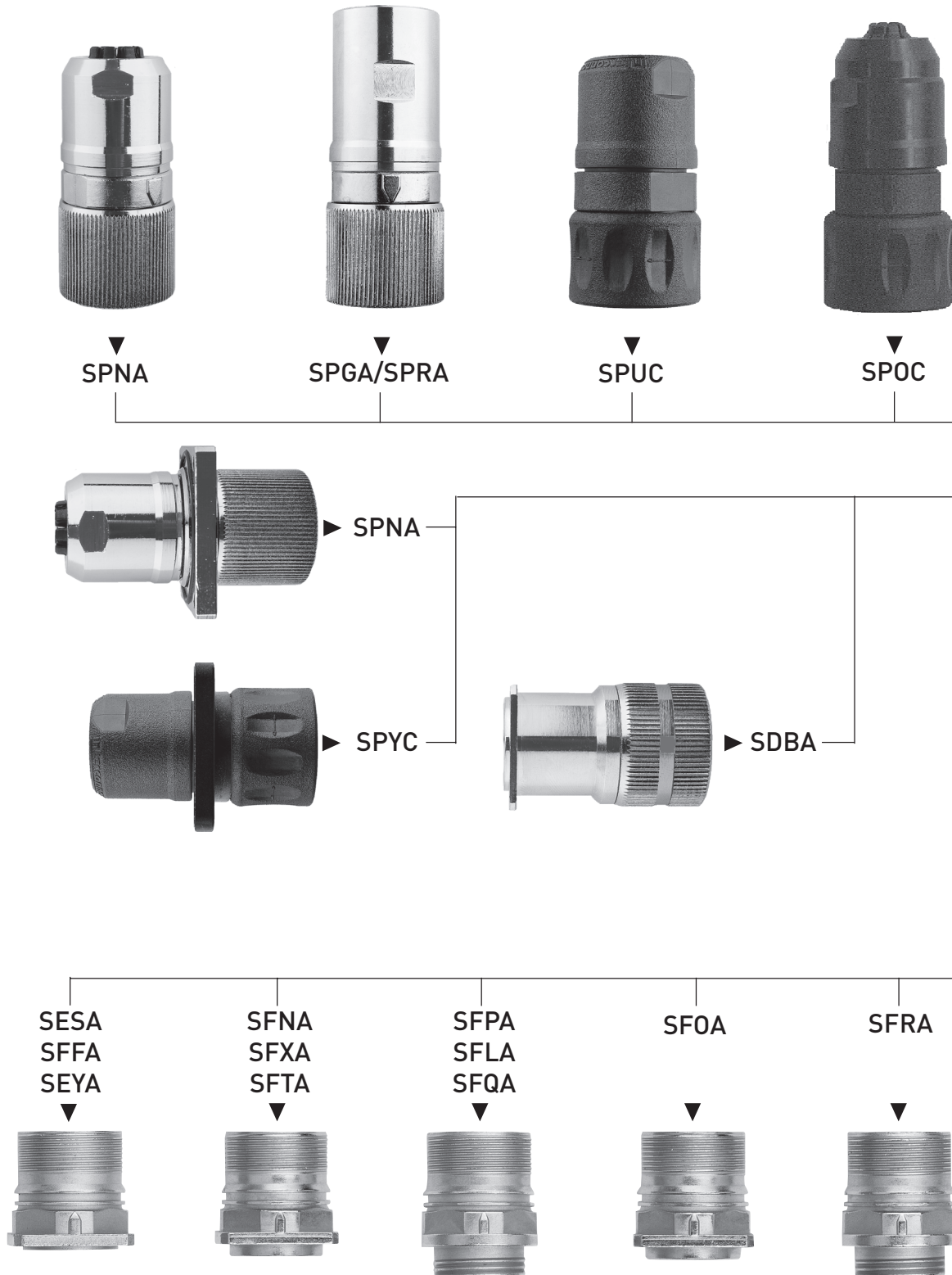

Signalrundsteckverbinder Serie S Circular signal connectors series S

Bauformübersicht Type overview





Signalrundsteckverbinder Serie S Circular signal connectors series S

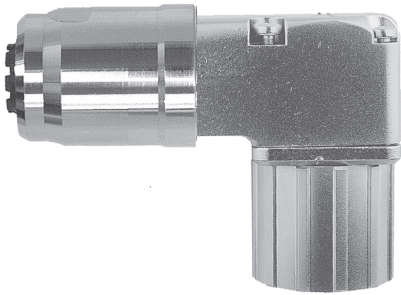

▼
SPHA

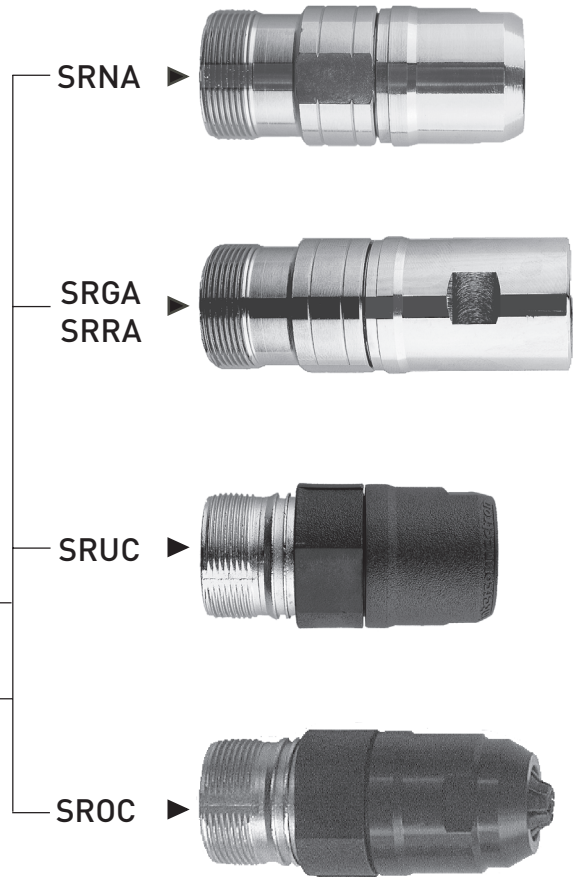

SRNA ▶

SRGA
SRRA ▶

SRUC ▶

SROC ▶

SRWC

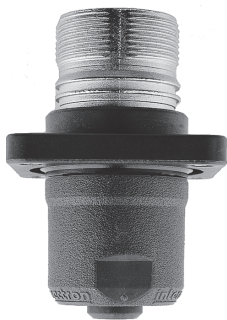

SRNA



Serie Y series Y

SEAB



SFMB
SFYB

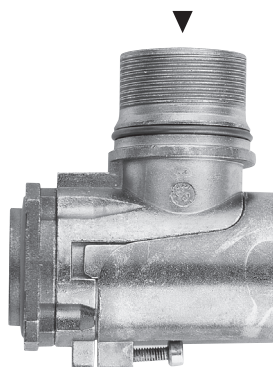

YEAG

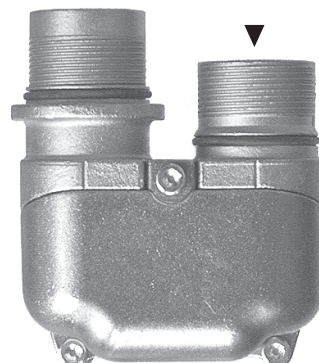



Signalrundsteckverbinder Serie S Circular signal connectors series S

Einbaudosen für Isolierkörper mit Lötkontakten

Receptacles for insulation bodies with solder cup

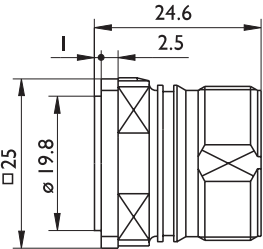
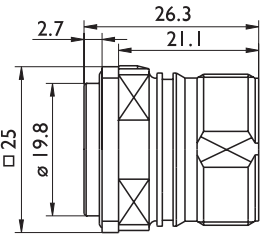
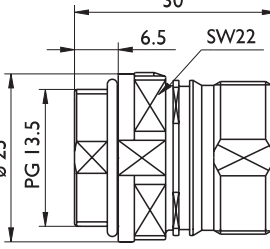
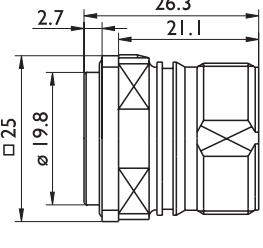
Darstellung Beschreibung Bestellbezeichnung	layout description part number code	Gehäuse shell	Kontaktart, Anschlußart	contact gender termination
Einbaudose mit axialer Abdichtung zum Gerät Flanschbohrung 2,7 mm Bestellbezeichnung inkl. O-Ring als Vibrationsschutz auf Anfrage	 <p>receptacle with axial sealing to the device, mounting holes for flange 2.7 mm part number incl. O-ring against vibration on demand</p>	SESA	Stift pin Buchse socket	Lötkelch solder cup Lötkelch solder cup
Einbaudose mit axialer Abdichtung zum Gerät Flanschbohrung 2,7 mm Bestellbezeichnung inkl. O-Ring als Vibrationsschutz auf Anfrage	 <p>receptacle with axial sealing to the device, mounting holes for flange 2.7 mm part number incl. O-ring against vibration on demand</p>	SFNA	Stift pin Buchse socket	Lötkelch solder cup Lötkelch solder cup
Einbaudose mit Anschlußgewinde Pg 13,5 Bestellbezeichnung inkl. O-Ring als Vibrationsschutz auf Anfrage	 <p>receptacle with threaded connection Pg 13.5 part number incl. O-ring against vibration on demand</p>	SFPA	Stift pin Buchse socket	Lötkelch solder cup Lötkelch solder cup
Einbaudose mit axialer Abdichtung zum Gerät Flanschbohrung 3,2 mm Bestellbezeichnung inkl. O-Ring als Vibrationsschutz auf Anfrage	 <p>receptacle with axial sealing to the device, mounting holes for flange 3.2 mm part number incl. O-ring against vibration on demand</p>	SFXA	Stift pin Buchse socket	Lötkelch solder cup Lötkelch solder cup



Signalrundsteckverbinder Serie S Circular signal connectors series S

6- bis 12polige Isolierkörper 6 to 12 way insulation bodies

		Polbilder: Darstellung Anschlußseite						contact arrangements: view termination side						Kabelklemmung cable clamp
		06C (6 x 2)	06E (6 x 2)	07A (7 x 2)	09C (8 x 1 / 1 x 2)	09A (9 x 1)	12E (12 x 1)							
		06C	06E	07A	09C	09A	12E	MSBN	MSBN	MSBN	MSAB	MSAN	MSAN	000
		06C	06E	07A	09C	09A	12E	FSBN	FSBN	FSBN	FSAB	FSAN	FSAN	000
		06C	06E	07A	09C	09A	12E	MSBN	MSBN	MSBN	MSAB	MSAN	MSAN	000
		06C	06E	07A	09C	09A	12E	FSBN	FSBN	FSBN	FSAB	FSAN	FSAN	000
		06C	06E	07A	09C	09A	12E	MSBN	MSBN	MSBN	MSAB	MSAN	MSAN	000
		06C	06E	07A	09C	09A	12E	FSBN	FSBN	FSBN	FSAB	FSAN	FSAN	000



Signalrundsteckverbinder Serie S Circular signal connectors series S

Einbaudosen IP 67 ungesteckt Receptacles IP 67 unmated

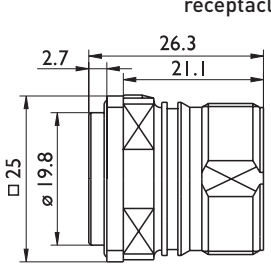
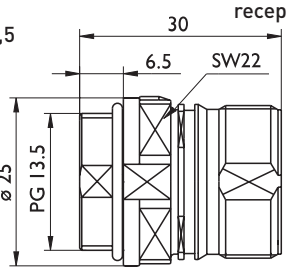
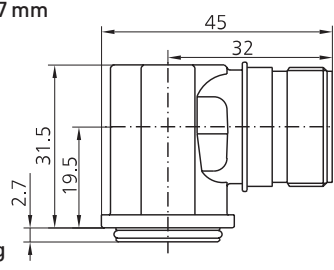
Darstellung Beschreibung Bestellbezeichnung	layout description part number code	Gehäuse shell	Kontaktart, Anschlußart contact gender termination	Polbild Darstellung Anschlußseite contact arrangement view termination side				
				12A [12 x 1]	17A [17 x 1]	Kabelklemmung cable clamp		
Einbaudose mit axialer Abdichtung zum Gerät Flanschbohrung 2,7 mm  Bestellbezeichnung inkl. O-Ring als Vibrationsschutz auf Anfrage	receptacle with axial sealing to the device, mounting holes for flange 2.7 mm part number incl. O-ring against vibration on demand	SFOA	Stift / pin Crimp*	12A	MREN	17A	MREN	000
Einbaudose mit Anschlußgewinde Pg 13,5  Bestellbezeichnung inkl. O-Ring als Vibrationsschutz auf Anfrage	receptacle with threaded connection Pg 13.5 part number incl. O-ring against vibration on demand	SFRA	Stift / pin Crimp*	12A	MREN	17A	MREN	000
Winkeldose mit axialer Abdichtung zum Gerät Flanschbohrung 2,7 mm  Bestellbezeichnung inkl. O-Ring als Vibrationsschutz auf Anfrage	angled receptacle with axial sealing to the device, mounting holes for flange 2.7 mm part number incl. O-ring against vibration on demand	SEAB	Stift / pin Crimp*	12A	MREN	17A	MREN	00002

Montagefenster für alle Einbaudosen
mit Montageflansch
6- bis 21polig

Drilling drawing for all receptacles
with mounting flange
6 to 21 way

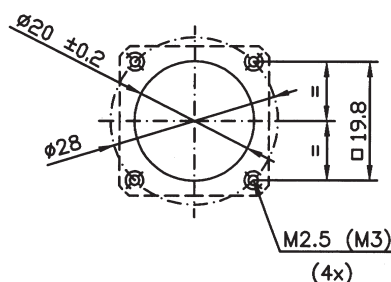



* Einlötfste auf Anfrage
* through board solder on demand



Signalrundsteckverbinder Serie S Circular signal connectors series S

**Kontaktstifte nur für
Einbaudosen IP 67 ungesteckt**

**Pins only for
receptacles IP 67 unmated**

Typ	type	A	E*	M			
Kontakt-durchmesser [mm]	contact-diameter [mm]	1	1	1			
Bestellbezeichnung und Darstellung	part number layout	 021.029.1020	 021.129.1020	 021.165.1020			
Anschlußquerschnitt** [mm ²] (AWG)	termination cross section** [mm ²] (AWG)	0,14 - 0,34 (26 - 22)	0,24 - 1,0 (24 - 18)	0,24 - 1,0 (24 - 18)			
maximaler Leiterdurchmesser [mm]	maximum conductor-diameter [mm]	-	1,3	-			
maximaler Isolations-durchmesser [mm]	maximum insulation-diameter [mm]	1,2	-	1,8			
für folgende Polzahlen	for following numbers of contact	12 / 17	12 / 17	12 / 17			

Werkzeugzuordnung Tooling

Crimpzange	crimping tool	B 150	B 150	B 150			
Positionierer	positioner	B 055/A	B 055/A	B 055/A			
Einbauwerkzeug	insertion tool	B 118	B 118	B 118			
Ausbauwerkzeug	extraction tool	B 038A	B 038A	B 038A			

* Standardkontaktstift / standard pin

**Die Angaben der Crimpbereiche beziehen sich auf nicht verdichtete Standardleitungen und -litzen gemäß DIN VDE 0295

**Mentioned crimp ranges only valid with non compressed standard cables and wires acc. to DIN VDE 0295



Signalrundsteckverbinder Serie S Circular signal connectors series S

Stecker für 6- bis 17polige Isolierkörper

Plugs for 6 to 17 way insulation bodies

Darstellung Beschreibung Bestellbezeichnung	layout description part number code	Gehäuse shell	Kontaktart, contact gender Anschlußart termination	
Stecker mit variabler Schirmanbindung und Kabelklemmung von \varnothing 5,5 - 12 mm 	plug with variable shield connection and cable clamp from \varnothing 5.5 to 12 mm	SPNA	gestanzte HCS™ Kontakte stamped HCS™ contacts gedrehte Crimpkontakte machined crimp contacts Lötkehl solder cup	HCS™ separat bestellen! order HCS™ separately!
Stecker mit variabler Schirmanbindung, Kabelklemmung von \varnothing 5,5 - 12 mm und Anschlußgewinde M 20x1,5/Pg 13,5 	plug with variable shield connection and cable clamp from \varnothing 5.5 to 12 mm and threaded connection M 20X1,5/Pg 13.5	M 20 x 1,5 SPRA Pg 13,5 SPGA	gestanzte HCS™ Kontakte stamped HCS™ contacts gedrehte Crimpkontakte machined crimp contacts Lötkehl solder cup	HCS™ separat bestellen! order HCS™ separately!
Stecker, Kunststoffgehäuse, mit Schirmanbindung, Kabelklemmungen siehe Seite 47 	plug, plastic shell, shielded and cable clamp shown on page 47	SPUC	gestanzte HCS™ Kontakte stamped HCS™ contacts gedrehte Crimpkontakte machined crimp contacts Lötkehl solder cup	HCS™ separat bestellen! order HCS™ separately!
Stecker, Kunststoffgehäuse, variable Schirmanbindung, variable Kabelklemmung \varnothing 5,5 - 12 mm 	plug, plastic shell, variable shield connection, variable cable clamp \varnothing 5,5 - 12 mm	SPOC	gestanzte HCS™ Kontakte stamped HCS™ contacts gedrehte Crimpkontakte machined crimp contacts Lötkehl solder cup	HCS™ separat bestellen! order HCS™ separately!
Ausführung mit Flansch auf Anfrage 	flange version on demand	SPHA	gestanzte HCS™ Kontakte stamped HCS™ contacts gedrehte Crimpkontakte machined crimp contacts Lötkehl solder cup	HCS™ separat bestellen! order HCS™ separately!



Signalrundsteckverbinder Serie S Circular signal connectors series S

6- bis 9polige Isolierkörper 6 to 9 way insulation bodies

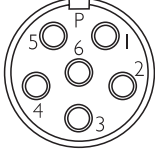
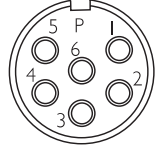
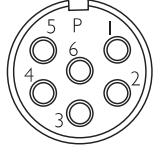
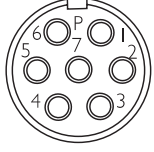
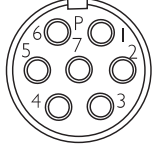
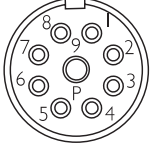
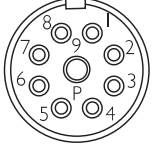
		Polbilder: Darstellung Anschlußseite						contact arrangements: view termination side						Kabelklemmung cable clamp		
																
		06D (6 x 2)	06F (6 x 2)	06H (6 x 2)	07B (7 x 2)	07D (7 x 2)	09D (8 x 1 / 1 x 2)	09F (8 x 1 / 1 x 2)								
		--	--	--	MRRN	--	--	--	--	--	--	--	--	169		
	06D	--	06F	--	--	--	MRRN	--	--	--	--	09F	MRSR			
		MSBN	--	MSBN	--	MSBN	--	MSAB	--	--	--	--	--			
	06D	--	06F	--	FRRN	--	FRRN	--	--	--	--	09F	FROR			
		FSBN	--	FSBN	--	FSBN	--	FSAB	--	--	--	--	--			
	06D	--	06F	--	MRRN	--	MRRN	--	--	--	--	09F	MRSR		000	
		MSBN	--	MSBN	--	MSBN	--	MSAB	--	--	--	--	--			
	06D	--	06F	--	FRRN	--	FRRN	--	--	--	--	09F	FROR			
		FSBN	--	FSBN	--	FSBN	--	FSAB	--	--	--	--	--			
	06D	--	06F	--	MRRN	--	MRRN	--	--	--	--	09F	MRSR			001 003 005 ...
		MSBN	--	MSBN	--	MSBN	--	MSAB	--	--	--	--	--			
	06D	--	06F	--	FRRN	--	FRRN	--	--	--	--	09F	FROR			
		FSBN	--	FSBN	--	FSBN	--	FSAB	--	--	--	--	--			
	06D	--	06F	--	MRRN	--	MRRN	--	--	--	--	09F	MRSR	169		
		MSBN	--	MSBN	--	MSBN	--	MSAB	--	--	--	--	--			
	06D	--	06F	--	FRRN	--	FRRN	--	--	--	--	09F	FROR			
		FSBN	--	FSBN	--	FSBN	--	FSAB	--	--	--	--	--			
	06D	--	06F	--	MRRN	--	MRRN	--	--	--	--	09F	MRSR		17003	
		MSBN	--	MSBN	--	MSBN	--	MSAB	--	--	--	--	--			
	06D	--	06F	--	FRRN	--	FRRN	--	--	--	--	09F	FROR			
		FSBN	--	FSBN	--	FSBN	--	FSAB	--	--	--	--	--			

Kontakte siehe Seite 14 - 17
contacts are shown on page 14 - 17



Signalrundsteckverbinder Serie S Circular signal connectors series S

Stecker für 6- bis 17polige Isolierkörper

Plugs for 6 to 17 way insulation bodies

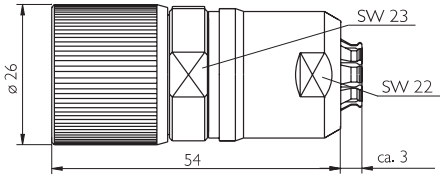
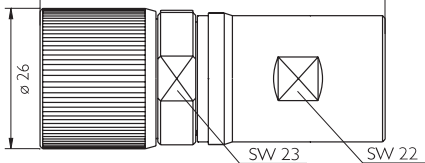
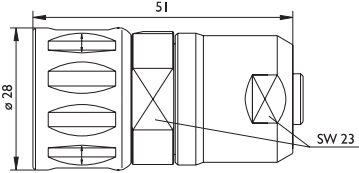
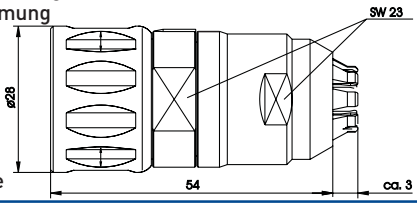
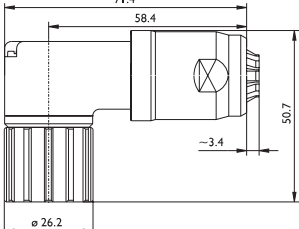
Darstellung Beschreibung Bestellbezeichnung	layout description part number code	Gehäuse shell	Kontaktart, contact gender Anschlußart termination		
Stecker mit variabler Schirmanbindung und Kabelklemmung von \varnothing 5,5 - 12 mm 	plug with variable shield connection and cable clamp from \varnothing 5.5 to 12 mm	SPNA	Stiff pin Buchse socket	gestanzte HCS™ Kontakte stamped HCS™ contacts gedrehte Crimpkontakte machined crimp contacts Lötkehl solder cup gestanzte HCS™ Kontakte stamped HCS™ contacts gedrehte Crimpkontakte machined crimp contacts Lötkehl solder cup	HCS™ separat bestellen! order HCS™ separately!
Stecker mit variabler Schirmanbindung, Kabelklemmung von \varnothing 5,5 - 12 mm und Anschlußgewinde M 20x1,5/Pg 13,5 	plug with variable shield connection and cable clamp from \varnothing 5.5 to 12 mm and threaded connection M 20x1,5/Pg 13.5	M 20x1,5 SPRA SPGA	Stiff pin Buchse socket	gestanzte HCS™ Kontakte stamped HCS™ contacts gedrehte Crimpkontakte machined crimp contacts Lötkehl solder cup gestanzte HCS™ Kontakte stamped HCS™ contacts gedrehte Crimpkontakte machined crimp contacts Lötkehl solder cup	HCS™ separat bestellen! order HCS™ separately!
Stecker, Kunststoffgehäuse, mit Schirmanbindung, Kabelklemmungen siehe Seite 47 	plug, plastic shell, shielded and cable clamp shown on page 47	SPUC	Stiff pin Buchse socket	gestanzte HCS™ Kontakte stamped HCS™ contacts gedrehte Crimpkontakte machined crimp contacts Lötkehl solder cup gestanzte HCS™ Kontakte stamped HCS™ contacts gedrehte Crimpkontakte machined crimp contacts Lötkehl solder cup	HCS™ separat bestellen! order HCS™ separately!
Stecker, Kunststoffgehäuse, variable Schirmanbindung, variable Kabelklemmung \varnothing 5,5 - 12 mm 	plug, plastic shell, variable shield connection, variable cable clamp \varnothing 5,5 - 12 mm	SPOC	Stiff pin Buchse socket	gestanzte HCS™ Kontakte stamped HCS™ contacts gedrehte Crimpkontakte machined crimp contacts Lötkehl solder cup gestanzte HCS™ Kontakte stamped HCS™ contacts gedrehte Crimpkontakte machined crimp contacts Lötkehl solder cup	HCS™ separat bestellen! order HCS™ separately!
Ausführung mit Flansch auf Anfrage 	angled plug with variable shield connection and cable clamp from \varnothing 7.7 to 14.5 mm	SPHA	Stiff pin Buchse socket	gestanzte HCS™ Kontakte stamped HCS™ contacts gedrehte Crimpkontakte machined crimp contacts Lötkehl solder cup gestanzte HCS™ Kontakte stamped HCS™ contacts gedrehte Crimpkontakte machined crimp contacts Lötkehl solder cup	HCS™ separat bestellen! order HCS™ separately!



Signalrundsteckverbinder Serie S Circular signal connectors series S

9- bis 17polige Isolierkörper 9 to 17 way insulation bodies

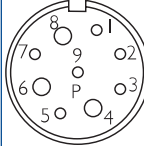
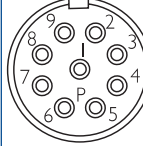
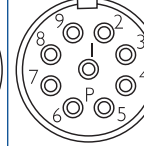
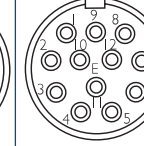
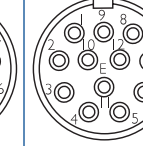
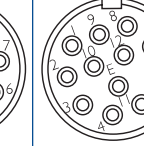
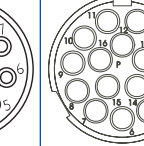
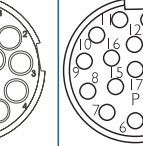
		Polbilder: Darstellung Anschlußseite				contact arrangements: view termination side				Kabelklemmung cable clamp	
											
		09H (6 x 1 / 3 x 2)	09B (9 x 1)	09K (9 x 1)	12F (12 x 1)	12S (12 x 1)	12U (12 x 1 Code 20°)	16B (16 x 1)	17H (17 x 1)		
		--	--	NNNN	--	NNNN	NNNN	NNNN	NNNN	169	
09H	MRSR	09B	--	MRSN	12F	--	MRSN	16B	MRSN		MRSN
	--		MSAN	--	MSAN	--	--	--	--		
09H	FROR	09B	--	FRON	12F	--	FRON	16B	FRON		FRON
	--		FSAN	--	FSAN	--	--	--	--		
09H	MRSR	09B	--	MRSN	12F	--	MRSN	16B	MRSN		MRSN
	--		MSAN	--	MSAN	--	--	--	--		
09H	FROR	09B	--	FRON	12F	--	FRON	16B	FRON		FRON
	--		FSAN	--	FSAN	--	--	--	--		
09H	MRSR	09B	--	MRSN	12F	--	MRSN	16B	MRSN		MRSN
	--		MSAN	--	MSAN	--	--	--	--		
09H	FROR	09B	--	FRON	12F	--	FRON	16B	FRON		FRON
	--		FSAN	--	FSAN	--	--	--	--		
09H	MRSR	09B	--	MRSN	12F	--	MRSN	16B	MRSN	MRSN	
	--		MSAN	--	MSAN	--	--	--	--		
09H	FROR	09B	--	FRON	12F	--	FRON	16B	FRON	FRON	
	--		FSAN	--	FSAN	--	--	--	--		
09H	MRSR	09B	--	MRSN	12F	--	MRSN	16B	MRSN	MRSN	
	--		MSAN	--	MSAN	--	--	--	--		
09H	FROR	09B	--	FRON	12F	--	FRON	16B	FRON	FRON	
	--		FSAN	--	FSAN	--	--	--	--		
09H	MRSR	09B	--	MRSN	12F	--	MRSN	16B	MRSN	MRSN	
	--		MSAN	--	MSAN	--	--	--	--		
09H	FROR	09B	--	FRON	12F	--	FRON	16B	FRON	FRON	
	--		FSAN	--	FSAN	--	--	--	--		

Kontakte siehe Seite 14 - 17
contacts are shown on page 14 - 17



Signalrundsteckverbinder Serie S Circular signal connectors series S

Stecker für 6- bis 17polige Isolierkörper

Plugs for 6 to 17 way insulation bodies

Darstellung Beschreibung Bestellbezeichnung	layout description part number code	Gehäuse shell	Kontaktart, Anschlußart contact gender termination	
Stecker mit Flansch, variable Schirmanbindung und Kabelklemmung von \varnothing 5,5 - 12 mm		SPNA	Stift pin gestanzte HCS™ Kontakte stamped HCS™ contacts Gedrehte Crimpkontakte machined crimp contacts Lötkelch solder cup	HCS™ separat bestellen! order HCS™ separately!
Stecker, Kunststoffgehäuse mit Flansch und Schirmanbindung, Kabelklemmungen siehe Seite 47		SPYC	Stift pin gestanzte HCS™ Kontakte stamped HCS™ contacts Gedrehte Crimpkontakte machined crimp contacts Lötkelch solder cup	HCS™ separat bestellen! order HCS™ separately!
Durchführung mit axialer Abdichtung zum Gerät		SDBA	Stift pin gestanzte HCS™ Kontakte stamped HCS™ contacts Gedrehte Crimpkontakte machined crimp contacts Stifte mit Lötkelch auf Anfrage pins with solder cup on demand	HCS™ separat bestellen! order HCS™ separately!
Stecker mit variabler Schirmanbindung und Kabelklemmung von \varnothing 7,7 - 14,5 mm		SPFA	Stift pin gestanzte HCS™ Kontakte stamped HCS™ contacts Gedrehte Crimpkontakte machined crimp contacts	HCS™ separat bestellen! order HCS™ separately!
plug with variable shield connection and cable clamp from \varnothing 7.7 to 14.5 mm			Buchse socket gestanzte HCS™ Kontakte stamped HCS™ contacts Gedrehte Crimpkontakte machined crimp contacts	HCS™ separat bestellen! order HCS™ separately!



Signalrundsteckverbinder Serie S Circular signal connectors series S

6- bis 9polige Isolierkörper 6 to 9 way insulation bodies

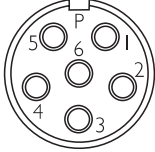
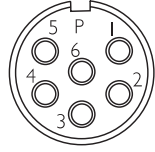
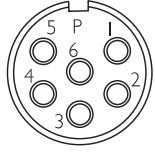
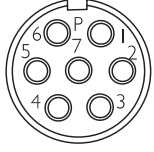
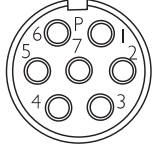
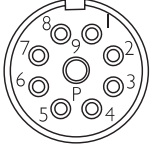
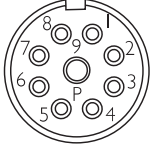
		Polbilder: Darstellung Anschlußseite						contact arrangements: view termination side						Kabelklemmung cable clamp	
															
		06D (6 x 2)	06F (6 x 2)	06H (6 x 2)	07B (7 x 2)	07D (7 x 2)	09D (8 x 1 / 1 x 2)	09F (8 x 1 / 1 x 2)							
		--	--	--	--	--	--	--							
	06D	--	06F	--	06H	MRRN	07B	--	07D	MRRN	09D	--	09F	MRSR	16914
		MSBN		MSBN		---		MSBN		---		MSAB		---	
		--	--	--	--	--	--	--	--	--	--	--	--	--	
	06D	--	06F	--	06H	FRRN	07B	--	07D	FRRN	09D	--	09F	FROR	001 003 005 ...
		FSBN		FSBN		--		FSBN		--		FSAB		--	
		--	--	--	--	--	--	--	--	--	--	--	--	--	
	06D	--	06F	--	06H	MRRN	07B	--	07D	MRRN	09D	--	09F	MRSR	000
		MSBN		MSBN		--		MSBN		--		MSAB		--	
		--	--	--	--	--	--	--	--	--	--	--	--	--	
	06D	--	06F	--	06H	FRRN	07B	--	07D	FRRN	09D	--	09F	FROR	170
		FSBN		FSBN		--		FSBN		--		FSAB		--	
		--	--	--	--	--	--	--	--	--	--	--	--	--	
		--	--	--	06H	MRRN			07D	MRRN			09F	MRSR	170
		--	--	--		--				--			--	--	
		--	--	--	06H	FRRN			07D	FRRN			09F	FROR	
		--	--	--		--				--			09F	MRSR	170
		--	--	--		--				--			--	--	
		--	--	--		--				--			09F	FROR	
		--	--	--		--				--			--	--	

Kontakte siehe Seite 14 - 17
contacts are shown on page 14 - 17



Signalrundsteckverbinder Serie S Circular signal connectors series S

Stecker für 6- bis 17polige Isolierkörper

Plugs for 6 to 17 way insulation bodies

Darstellung Beschreibung Bestellbezeichnung	layout description part number code	Gehäuse shell	Kontaktart, Anschlußart	contact gender termination	
<p>Stecker mit Flansch, variable Schirmanbindung und Kabelklemmung von \varnothing 5,5 - 12 mm</p>	<p>plug with flange, variable shield connection and cable clamp from \varnothing 5.5 to 12 mm</p>	SPNA	<p>gestanzte HCS™ Kontakte stamped HCS™ contacts</p> <p>Gedrehte Crimpkontakte machined crimp contacts</p> <p>Lötkelch solder cup</p>	<p>Stift pin</p> <p>Buchse socket</p>	<p>HCS™ separat bestellen! order HCS™ separately!</p>
<p>Stecker, Kunststoffgehäuse mit Flansch und Schirmanbindung, Kabelklemmungen siehe Seite 47</p>	<p>plug, plastic shell with flange, shielded and cable clamp shown on page 47</p>	SPYC	<p>gestanzte HCS™ Kontakte stamped HCS™ contacts</p> <p>Gedrehte Crimpkontakte machined crimp contacts</p> <p>Lötkelch solder cup</p>	<p>Stift pin</p> <p>Buchse socket</p>	<p>HCS™ separat bestellen! order HCS™ separately!</p>
<p>Durchführung mit axialer Abdichtung zum Gerät</p>	<p>bushing with axial sealing to the device</p>	SDBA	<p>gestanzte HCS™ Kontakte stamped HCS™ contacts</p> <p>Gedrehte Crimpkontakte machined crimp contacts</p> <p>Stifte mit Lötkelch auf Anfrage pins with solder cup on demand</p>	<p>Stift pin</p> <p>Buchse socket</p>	<p>HCS™ separat bestellen! order HCS™ separately!</p>
<p>Stecker mit variabler Schirmanbindung und Kabelklemmung von \varnothing 7,7 - 14,5 mm</p>	<p>plug with variable shield connection and cable clamp from \varnothing 7.7 to 14.5 mm</p>	SPFA	<p>gestanzte HCS™ Kontakte stamped HCS™ contacts</p> <p>Gedrehte Crimpkontakte machined crimp contacts</p>	<p>Stift pin</p> <p>Buchse socket</p>	<p>HCS™ separat bestellen! order HCS™ separately!</p>



Signalrundsteckverbinder Serie S Circular signal connectors series S

9- bis 17polige Isolierkörper 9 to 17 way insulation bodies

		Polbilder: Darstellung Anschlußseite				contact arrangements: view termination side							
										Kabelklemmung cable clamp			
		09H (6 x 1 / 3 x 2)	09B (9 x 1)	09K (9 x 1)	12F (12 x 1)	12S (12 x 1)	12U (12 x 1 Code 20°)	16B (16 x 1)	17H (17 x 1)				
		--	--	NNNN	--	NNNN	NNNN	NNNN	NNNN				
	09H	MRSR	09B	MRSN	12F	MRSN	12U	MRSN	16B	MRSN	17H	MRSN	
		--	MSAN	---	MSAN	---	---	---	---				
		--	--	NNNN	--	NNNN	NNNN	NNNN	NNNN				
	09H	FROR	09B	FRON	12F	FRON	12U	FRON	16B	FRON	17H	FRON	
		--	FSAN	--	FSAN	--	--	--	--				
		--	--	NNNN	--	NNNN	NNNN	NNNN	NNNN				
	09H	MRSR	09B	MRSN	12F	MRSN	12U	MRSN	16B	MRSN	17H	MRSN	
		--	MSAN	--	MSAN	--	--	--	--				
		--	--	NNNN	--	NNNN	NNNN	NNNN	NNNN				
	09H	FROR	09B	FRON	12F	FRON	12U	FRON	16B	FRON	17H	FRON	
		--	FSAN	--	FSAN	--	--	--	--				
		--	--	NNNN	--	NNNN	NNNN	NNNN	NNNN				
	09H	MRSR		09K	MRSN	12S	MRSN	12U	MRSN	16B	MRSN	17H	MRSN
		--			--	--	--	--	--				
		--		NNNN			NNNN	NNNN	NNNN			NNNN	
	09H	FROR		09K	FRON	12S	FRON	12U	FRON	16B	FRON	17H	FRON
		--			--	--	--	--	--				
		--		NNNN			NNNN	NNNN	NNNN			NNNN	
				09K	FRON	12S	MRSN	12U	FRON	16B	MRSN	17H	MRSN
					--	--	--	--	--				
				NNNN			NNNN	NNNN	NNNN			NNNN	
				09K	FRON	12S	FRON	12U	FRON	16B	FRON	17H	FRON
					--	--	--	--	--				

Kontakte siehe Seite 14 - 17
contacts are shown on page 14 - 17



Signalrundsteckverbinder Serie S Circular signal connectors series S

Kupplungen für 6- bis 17polige Isolierkörper

Extensions for 6 to 17 way insulation bodies

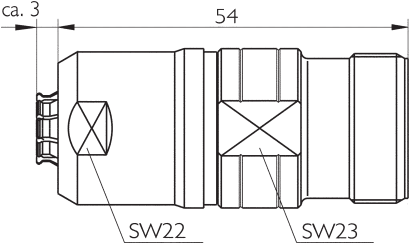
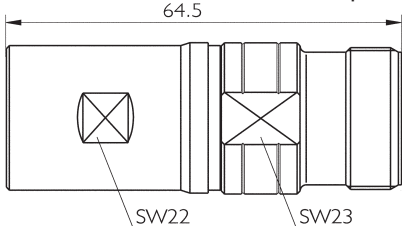
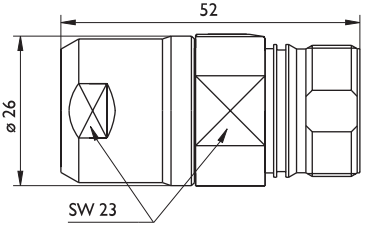
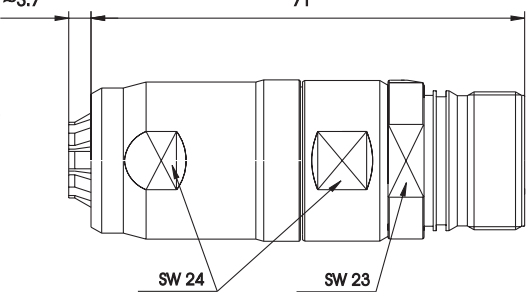
Darstellung Beschreibung Bestellbezeichnung	layout description part number code	Gehäuse shell	Kontaktart, Anschlußart	contact gender termination	
Kupplung mit variabler Schirmanbindung und Kabelklemmung von \varnothing 5,5 - 12 mm 	extension with variable shield connection and cable clamp from \varnothing 5.5 to 12 mm SW22 SW23	SRNA	Stift pin	gestanzte HCS™ Kontakte stamped HCS™ contacts	HCS™ separat bestellen! order HCS™ separately!
				Gedrehte Crimpkontakte machined crimp contacts	
			Buchse socket	Lötkelch solder cup	
				gestanzte HCS™ Kontakte stamped HCS™ contacts	HCS™ separat bestellen! order HCS™ separately!
			Stift pin	Gedrehte Crimpkontakte machined crimp contacts	
				Lötkelch solder cup	
Kupplung mit variabler Schirmanbindung, Kabelklemmung von \varnothing 5,5 - 12 mm und Anschlußgewinde M 20x 1,5/Pg 13,5 	extension with variable shield connection cable clamp from \varnothing 5.5 to 12 mm and threaded connection M 20x1,5/Pg 13.5 M 20 x 1,5 Pg 13,5 SW22 SW23	SRRA		gestanzte HCS™ Kontakte stamped HCS™ contacts	HCS™ separat bestellen! order HCS™ separately!
		SRGA		Gedrehte Crimpkontakte machined crimp contacts	
Kupplung, Kunststoffgehäuse, mit Schirmanbindung, Kabelklemmungen siehe Seite 47 	extension, plastic shell, with shield connection and cable clamp shown on page 47 SW 23 part number incl. O-ring against vibration on demand	SRUC	Stift pin	Lötkelch solder cup	
				gestanzte HCS™ Kontakte stamped HCS™ contacts	HCS™ separat bestellen! order HCS™ separately!
Bestellbezeichnung inkl. O-Ring als Vibrationsschutz auf Anfrage			Buchse socket	Gedrehte Crimpkontakte machined crimp contacts	
				Lötkelch solder cup	
Kupplung mit variabler Schirmanbindung und Kabelklemmung von \varnothing 7,7 - 14,5 mm; Bestellbezeichnung inkl. O-Ring als Vibrationsschutz auf Anfrage 	extension with variable shield connection and cable clamp from \varnothing 7.7 to 14.5 mm; part number incl. O-ring against vibration on demand SW 24 SW 23	SRFA	Stift pin	Gedrehte Crimpkontakte machined crimp contacts	
			Buchse socket	Gedrehte Crimpkontakte machined crimp contacts	



Signalrundsteckverbinder Serie S Circular signal connectors series S

Kupplungen für 6- bis 17polige Isolierkörper

Extensions for 6 to 17 way insulation bodies

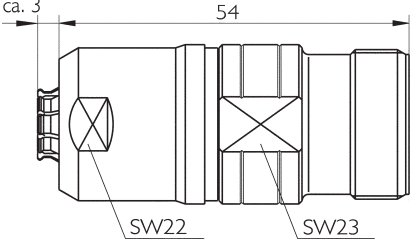
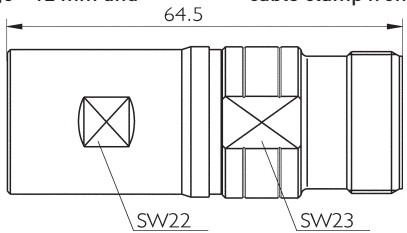
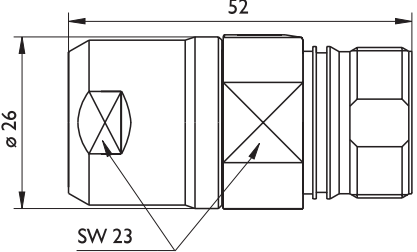
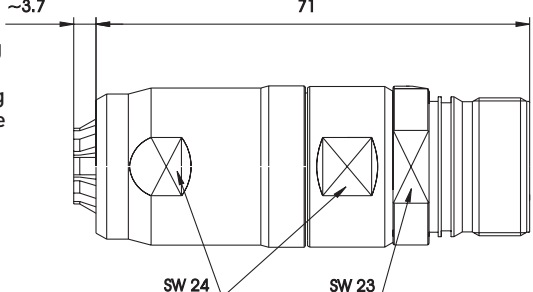
Darstellung Beschreibung Bestellbezeichnung	layout description part number code	Gehäuse shell	Kontaktart, Anschlußart	contact gender termination	
Kupplung mit variabler Schirmanbindung und Kabelklemmung von \varnothing 5,5 - 12 mm 	extension with variable shield connection and cable clamp from \varnothing 5.5 to 12 mm SW22 SW23	SRNA	Stift pin	gestanzte HCS™ Kontakte stamped HCS™ contacts	HCS™ separat bestellen! order HCS™ separately!
				Gedrehte Crimpkontakte machined crimp contacts	
			Buchse socket	gestanzte HCS™ Kontakte stamped HCS™ contacts	HCS™ separat bestellen! order HCS™ separately!
				Gedrehte Crimpkontakte machined crimp contacts	
Kupplung mit variabler Schirmanbindung, Kabelklemmung von \varnothing 5,5 - 12 mm und Anschlußgewinde M 20x 1,5/Pg 13,5 	extension with variable shield connection cable clamp from \varnothing 5.5 to 12 mm and threaded connection M 20x1,5/Pg 13.5 M 20 x 1,5 Pg 13,5 SW22 SW23	SRRA	Stift pin	gestanzte HCS™ Kontakte stamped HCS™ contacts	HCS™ separat bestellen! order HCS™ separately!
		SRGA	Buchse socket	gestanzte HCS™ Kontakte stamped HCS™ contacts	HCS™ separat bestellen! order HCS™ separately!
Kupplung, Kunststoffgehäuse, mit Schirmanbindung, Kabelklemmungen siehe Seite 47 	extension, plastic shell, with shield connection and cable clamp shown on page 47 part number incl. O-ring against vibration on demand SW 23	SRUC	Stift pin	gestanzte HCS™ Kontakte stamped HCS™ contacts	HCS™ separat bestellen! order HCS™ separately!
		Buchse socket	gestanzte HCS™ Kontakte stamped HCS™ contacts	HCS™ separat bestellen! order HCS™ separately!	
Kupplung mit variabler Schirmanbindung und Kabelklemmung von \varnothing 7,7 - 14,5 mm; Bestellbezeichnung inkl. O-Ring als Vibrationsschutz auf Anfrage 	extension with variable shield connection and cable clamp from \varnothing 7.7 to 14.5 mm; part number incl. O-ring against vibration on demand SW 24 SW 23	SRFA	Stift pin	Gedrehte Crimpkontakte machined crimp contacts	
		Buchse socket	Gedrehte Crimpkontakte machined crimp contacts		



Signalrundsteckverbinder Serie S Circular signal connectors series S

Kupplungen für 6- bis 17polige Isolierkörper

Extensions for 6 to 17 way insulation bodies

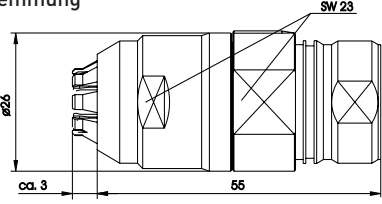
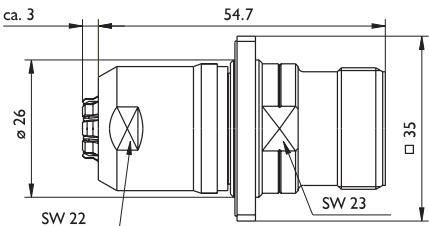
Darstellung Beschreibung Bestellbezeichnung	layout description part number code	Gehäuse shell	Kontaktart, Anschlußart	contact gender termination	
Kupplung Kunststoffgehäuse, mit variabler Schirmanbindung und variabler Kabelklemmung von $\varnothing 5,5 - 12$ mm 	extension , plastic shell, with variable shield connection and variable cable clamp from $\varnothing 5.5$ to 12 mm flange version on demand	SROC	Stift pin	gestanzte HCS™ Kontakte stamped HCS™ contacts	HCS™ separat bestellen! order HCS™ separately!
				Gedrehte Crimpkontakte machined crimp contacts	
Ausführung mit Flansch auf Anfrage			Buchse socket	gestanzte HCS™ Kontakte stamped HCS™ contacts	HCS™ separat bestellen! order HCS™ separately!
				Gedrehte Crimpkontakte machined crimp contacts	
Lötkelch solder cup					
Kupplung mit Montageflansch, mit variabler Schirmanbindung und Kabelklemmung von $\varnothing 5,5 - 12$ mm 	extension with mounting flange with variable shield connection and cable clamp from $\varnothing 5.5$ to 12 mm	SRNA	Stift pin	gestanzte HCS™ Kontakte stamped HCS™ contacts	HCS™ separat bestellen! order HCS™ separately!
				Gedrehte Crimpkontakte machined crimp contacts	
Lötkelch solder cup					
Kupplung mit Montageflansch, Kunststoffgehäuse, mit Schirmanbindung, Kabelklemmungen siehe Seite 47 Bestellbezeichnung inkl. O-Ring als Vibrationsschutz auf Anfrage	extension with mounting flange, plastic shell, with shield connection and cable clamp shown on page 47 part number incl. O-ring against vibration on demand	SRWC	Stift pin	gestanzte HCS™ Kontakte stamped HCS™ contacts	HCS™ separat bestellen! order HCS™ separately!
				Gedrehte Crimpkontakte machined crimp contacts	
Lötkelch solder cup					
			Buchse socket	gestanzte HCS™ Kontakte stamped HCS™ contacts	HCS™ separat bestellen! order HCS™ separately!
				Gedrehte Crimpkontakte machined crimp contacts	
Lötkelch solder cup					

Montagefenster für Stecker
mit Montageflansch
SRWC .../SPYC ...
6- bis 21polig

Drilling drawing for plugs
with mounting flange
SRWC .../SPYC ...
6 to 21 way

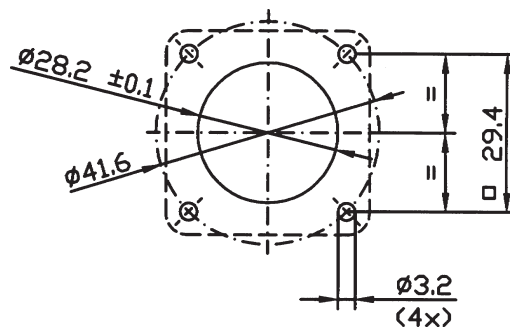



Signalrundsteckverbinder Serie S Circular signal connectors series S

6- bis 9polige Isolierkörper 6 to 9 way insulation bodies

		Polbilder: Darstellung Anschlußseite						contact arrangements: view termination side						Kabelklemmung cable clamp
		06C (6 x 2)	06E (6 x 2)	06G (6 x 2)	07A (7 x 2)	07C (7 x 2)	09C (8 x 1 / 1 x 2)	09E (8 x 1 / 1 x 2)						
		--	--	--	--	--	--	--						
	06C	--	06E	--	06G	MRRN	07A	--	07C	MRRN	09C	--	09E	MRSR
		MSBN		MSBN		--		MSBN		--		MSAB		--
		--	--	--	--	--	--	--						
	06C	--	06E	--	06G	FRRN	07A	--	07C	FRRN	09C	--	09E	FROR
		FSBN		FSBN		--		FSBN		--		FSAB		--
		--	--	--	--	--	--	--						
	06C	--	06E	--	06G	MRRN	07A	--	07C	MRRN	09C	--	09E	MRSR
		MSBN		MSBN		--		MSBN		--		MSAB		--
		--	--	--	--	--	--	--						
	06C	--	06E	--	06G	FRRN	07A	--	07C	FRRN	09C	--	09E	FROR
		FSBN		FSBN		--		FSBN		--		FSAB		--
		--	--	--	--	--	--	--						
	06C	--	06E	--	06G	MRRN	07A	--	07C	MRRN	09C	--	09E	MRSR
		MSBN		MSBN		--		MSBN		--		MSAB		--
		--	--	--	--	--	--	--						
	06C	--	06E	--	06G	FRRN	07A	--	07C	FRRN	09C	--	09E	FROR
		FSBN		FSBN		--		FSBN		--		FSAB		--

Kontakte siehe Seite 14 - 17
contacts are shown on page 14 - 17

Montagefenster für Stecker
mit Montageflansch
SRNA...01/SPNA...14
6- bis 21polig

Drilling drawing for plugs
with mounting flange
SRNA...01/SPNA...14
6 to 21 way

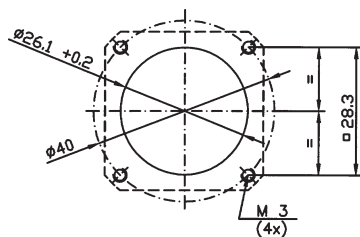



Signalrundsteckverbinder Serie S Circular signal connectors series S

Kupplungen für 6- bis 17polige Isolierkörper

Extensions for 6 to 17 way insulation bodies

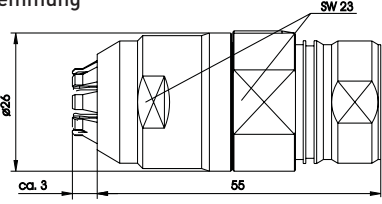
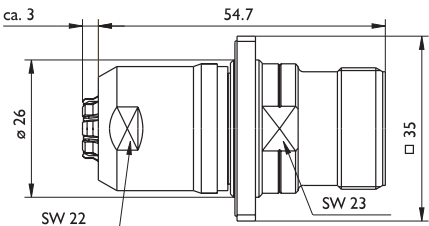
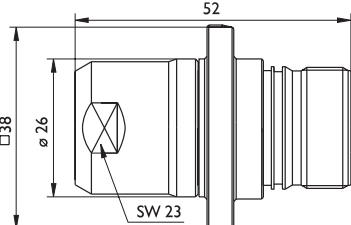
Darstellung Beschreibung Bestellbezeichnung	layout description part number code	Gehäuse shell	Kontaktart, Anschlußart	contact gender termination	
Kupplung Kunststoffgehäuse, mit variabler Schirmanbindung und variabler Kabelklemmung von $\varnothing 5,5 - 12$ mm 	extension , plastic shell, with variable shield connection and variable cable clamp from $\varnothing 5.5$ to 12 mm flange version on demand	SROC	gestanzte HCS™ Kontakte stamped HCS™ contacts Gedrehte Crimpkontakte machined crimp contacts Lötkehlch solder cup	HCS™ separat bestellen! order HCS™ separately!	Stift pin
					Buchse socket
Kupplung mit Montageflansch, mit variabler Schirmanbindung und Kabelklemmung von $\varnothing 5,5 - 12$ mm 	extension with mounting flange with variable shield connection and cable clamp from $\varnothing 5.5$ to 12 mm	SRNA	gestanzte HCS™ Kontakte stamped HCS™ contacts Gedrehte Crimpkontakte machined crimp contacts Lötkehlch solder cup	HCS™ separat bestellen! order HCS™ separately!	Stift pin
					Buchse socket
Kupplung mit Montageflansch, Kunststoffgehäuse, mit Schirmanbindung, Kabelklemmungen siehe Seite 47 Bestellbezeichnung inkl. O-Ring als Vibrationsschutz auf Anfrage 	extension with mounting flange, plastic shell, with shield connection and cable clamp shown on page 47 part number incl. O-ring against vibration on demand	SRWC	gestanzte HCS™ Kontakte stamped HCS™ contacts Gedrehte Crimpkontakte machined crimp contacts Lötkehlch solder cup	HCS™ separat bestellen! order HCS™ separately!	Stift pin
					Buchse socket

Montagefenster für Stecker
mit Montageflansch
SRWC .../SPYC ...
6- bis 21polig

Drilling drawing for plugs
with mounting flange
SRWC .../SPYC ...
6 to 21 way

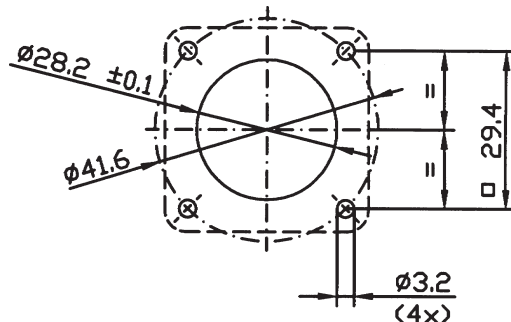



Signalrundsteckverbinder Serie S Circular signal connectors series S

9- bis 17polige Isolierkörper 9 to 17 way insulation bodies

		Polbilder: Darstellung Anschlußseite				contact arrangements: view termination side						
										Kabelklemmung cable clamp		
		09G (6 x 1 / 3 x 2)	09A (9 x 1)	09J (9 x 1)	12E (12 x 1)	12T (12 x 1)	12V (12 x 1 Code 20°)	16A (16 x 1)	17G (17 x 1)			
		--	--	NNNN	--	NNNN	NNNN	NNNN	NNNN		169	
	09G	MRSR	09A	MRSN	12E	MRSN	MRSN	MRSN	MRSN	17G		MRSN
		--	MSAN	--	MSAN	--	--	--	--	--		--
		--	--	NNNN	--	NNNN	NNNN	NNNN	NNNN	17G		NNNN
	09G	FROR	09A	FRON	12E	FRON	FRON	FRON	FRON	17G		FRON
		--	FSAN	--	FSAN	--	--	--	--	--		--
		--	--	NNNN	--	NNNN	NNNN	NNNN	NNNN	17G		NNNN
	09G	MRSR	09A	MRSN	12E	MRSN	MRSN	MRSN	MRSN	17G		MRSN
		--	MSAN	--	MSAN	--	--	--	--	--		--
		--	--	NNNN	--	NNNN	NNNN	NNNN	NNNN	17G		NNNN
	09G	FROR	09A	FRON	12E	FRON	FRON	FRON	FRON	17G		FRON
		--	FSAN	--	FSAN	--	--	--	--	--		--
		--	--	NNNN	--	NNNN	NNNN	NNNN	NNNN	17G	NNNN	
	09G	MRSR	09A	MRSN	12E	MRSN	MRSN	MRSN	MRSN	17G	MRSN	
		--	MSAN	--	MSAN	--	--	--	--	--	--	
		--	--	NNNN	--	NNNN	NNNN	NNNN	NNNN	17G	NNNN	
	09G	FROR	09A	FRON	12E	FRON	FRON	FRON	FRON	17G	FRON	
		--	FSAN	--	FSAN	--	--	--	--	--	--	

Kontakte siehe Seite 14 - 17
contacts are shown on page 14 - 17

Montagefenster für Stecker
mit Montageflansch
SRNA ...01/SPNA ...14
6- bis 21polig

Drilling drawing for plugs
with mounting flange
SRNA ...01/SPNA ...14
6 to 21 way

