

# Heraeus



**Components for the Automotive Industry**











# Automotive in Focus – Components, Materials and Technologies for the Automotive Industry

In close cooperation with automotive OEMs and suppliers, Heraeus develops innovative, technical components and materials for the automotive industry.

For electronics Heraeus produces among others bonding wires, special thick film and solder pastes, precious metal powders and ultrafine solder powders, and polymers. Heraeus products are used, for instance, in power electronics and many control devices, e.g. for the transmission, engines, ABS (Anti-lock Braking System), and airbags. A variety of metal and precious metal parts from Heraeus ensures the smooth functioning of the electrical safety systems, e.g. emergency braking and lane assist systems, and the ESP (Electronic Stability Program).

At the same time, platinum temperature sensors and catalyst coatings are employed in the exhaust systems of cars, trucks, and motorcycles. The platinum temperature sensors monitor, among other things, the turbocharger and the burn-off of the diesel particle filter.

Heraeus was founded in 1851. Today the precious metal and technology group is globally represented on a very broad basis with a comprehensive product portfolio and occupies leading positions in all important market segments. This strategy gives the company security in times of crisis. This is further assured by the company's own precious metal cycle and trading, which are also a mainstay in combating fluctuating market situations.

	Transmission Control	04
	Exhaust Line	06
	Power Assisted Steering	08
	Spark Plugs	10
	Cockpit	12
	Headlights	14
	Sensors	16
	Power Electronics for Electro-mobility	18
	Safety	20
	Heraeus Service and Quality Assurance	22

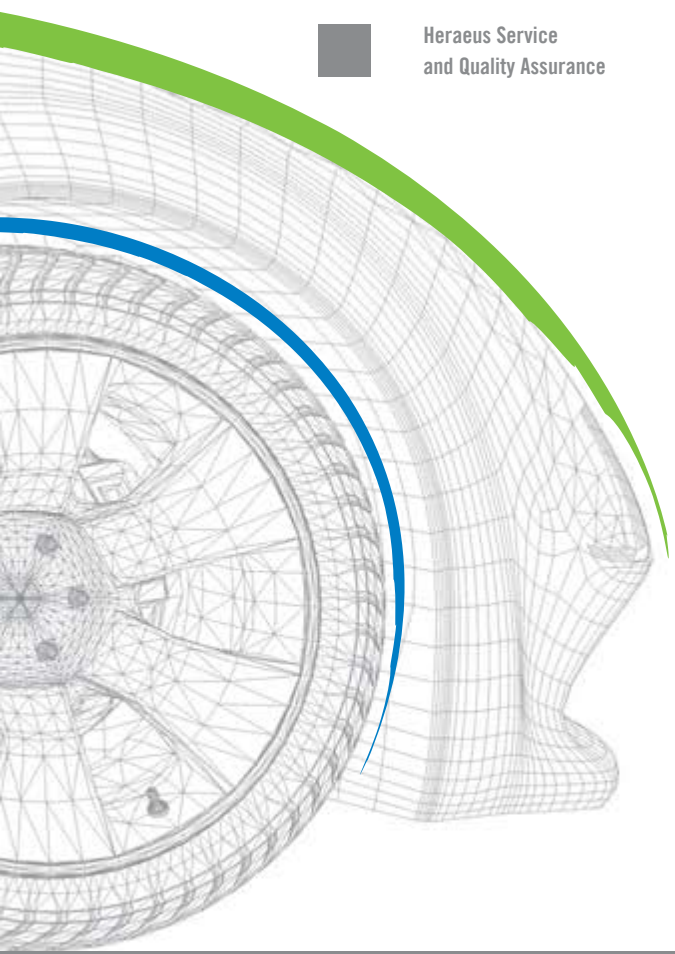

With its global emphasis and almost 13,000 employees, the "Fortune 500" company Heraeus is in every market. Having a localized presence Heraeus can adjust to the requirements of individual countries. The Heraeus Precious Metal and Technology group achieved total sales of 22 billion Euros in 2010.



[www.heraeus-materials-technology.com](http://www.heraeus-materials-technology.com)  
[www.heraeus-precious-metals.com](http://www.heraeus-precious-metals.com)  
[www.heraeus-automotive.com](http://www.heraeus-automotive.com)



# Transmission Control



## The Right Gear

Heraeus contributes a considerable proportion to the flawless functioning of various electronic modules in the transmission control system.

Whether in solder pastes, conducting and SMT adhesives, or sinter adhesives – products from Heraeus are used in many components of the transmission control system.

The Heraeus AISi:Bond roll clad strips and Heraeus AISi:Pads ensure high reliability in combination with Heraeus bonding wires. The same applies to the precision stamped parts and micro-metal- composite parts. Furthermore, conductor, dielectric and resistor pastes are used for  $Al_2O_3$  and LTCC (Low Temperature Cofiring Ceramic).



Conductive adhesives, sinter adhesives, solder pastes and SMT adhesives

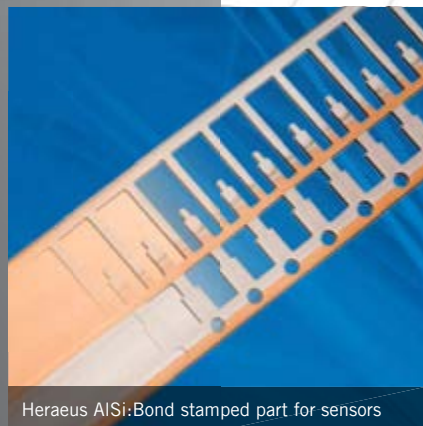

Heraeus AISi:Bond stamped part for sensors

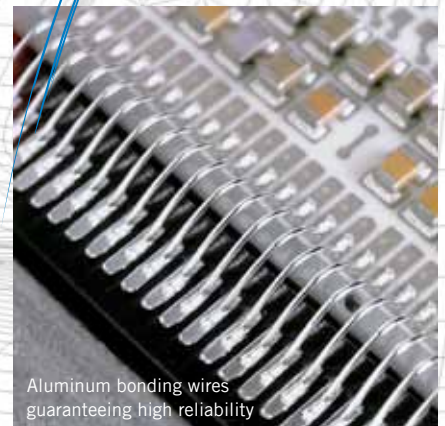

Aluminum bonding wires guaranteeing high reliability

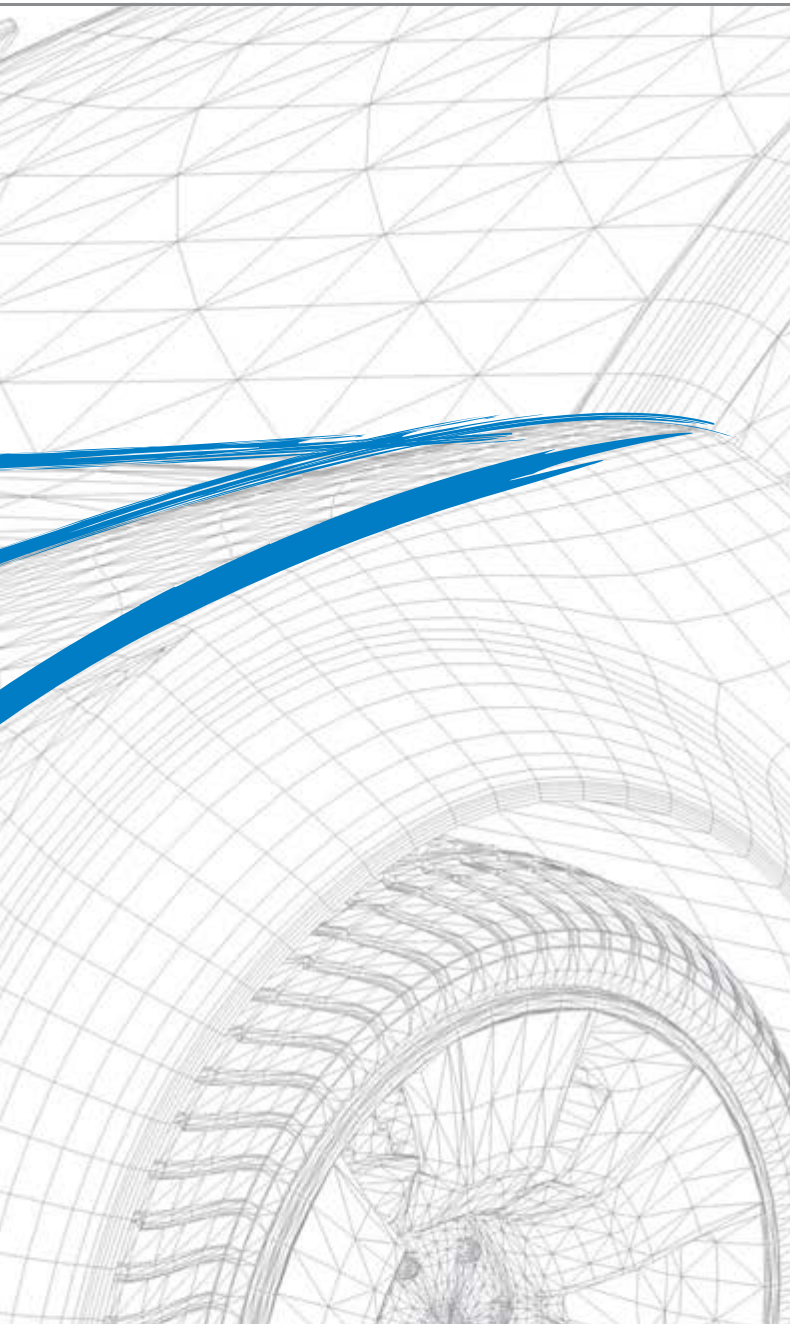

By courtesy of  
Continental AG, Hannover

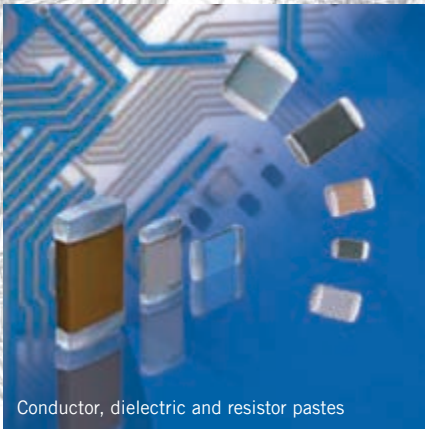

Conductor, dielectric and resistor pastes

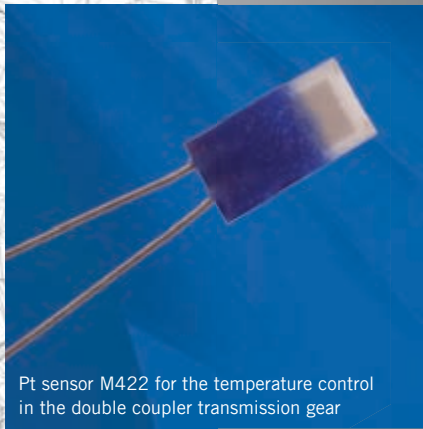

Pt sensor M422 for the temperature control  
in the double coupler transmission gear





# Exhaust Line



## A Clean Matter

The HeraPur® catalysts ensure the reliable achievement of legal limits in the exhaust line of vehicles. They are used for gas, gasoline, and diesel engines in cars, commercial vehicles, motorcycles, and quads.

Heraeus has years of experience with innovative catalyst coatings which reduce the emissions in the exhaust far below the legal requirements.

The minimized use of precious metal guarantees high cost efficiency. Customer specified catalysts for small series are also a strength of Heraeus. Platinum pastes and high temperature overglazes for the exhaust line are further important contributions of the precious metal and technology company.

AlSi:Bond roll clad strips also ensure the flawless functioning of the sensor system in the exhaust line.

Precision stamped parts and micro-metal-composite parts round off the range offered for this field. The reliable operation of the exhaust line is, furthermore, ensured by the roll clad strip in the lambda-probe plug connector, the lambda-probe strip for sealing rings, and the connecting wires of the sensors.



Catalyst coating



Emission control catalysts

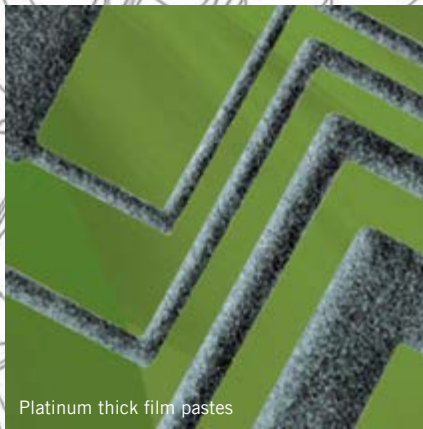
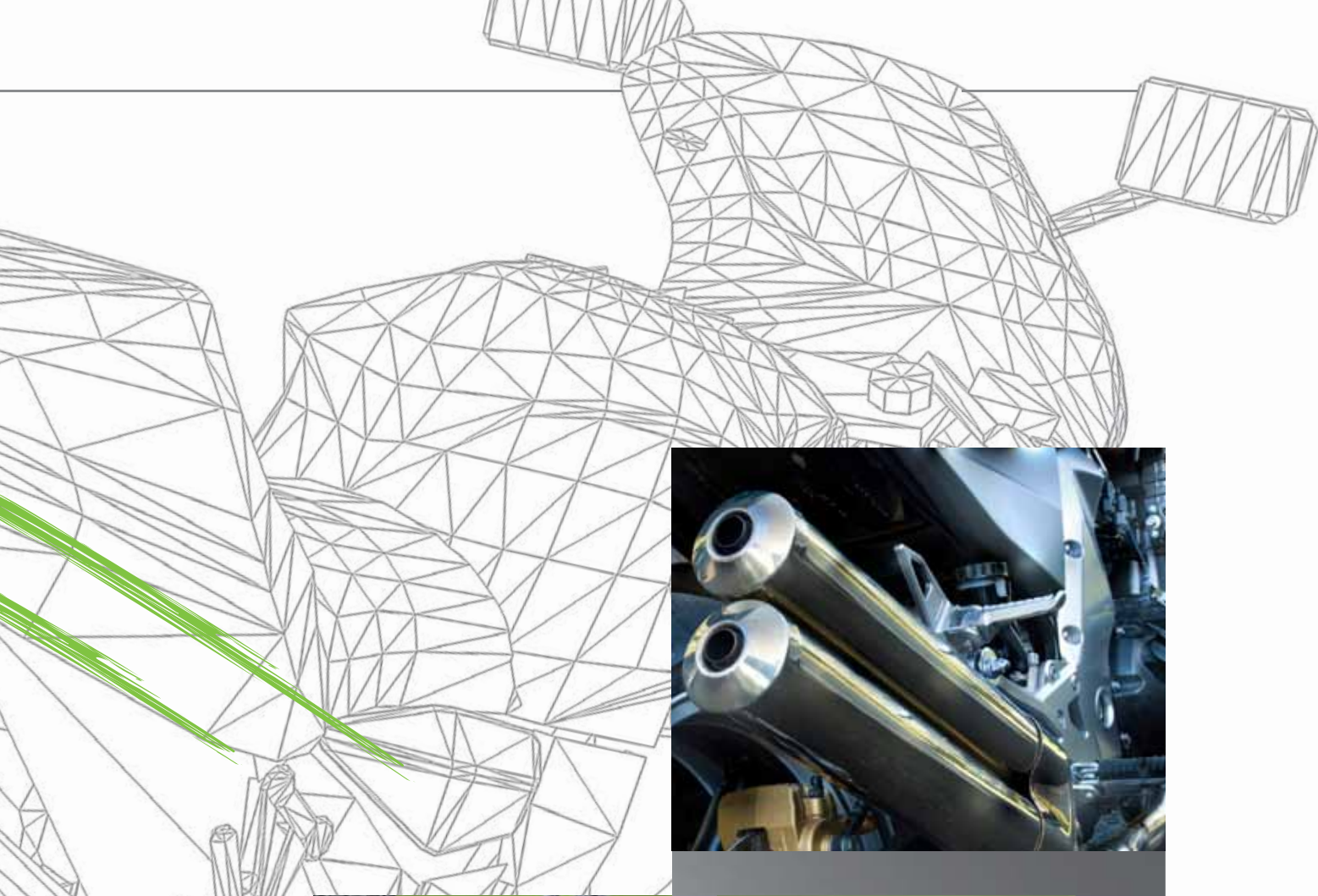

Platinum thick film pastes



Bonding wires in control electronics for reliable contacting

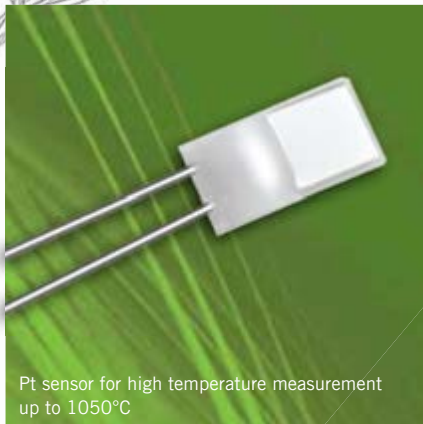

Pt sensor for high temperature measurement up to 1050°C

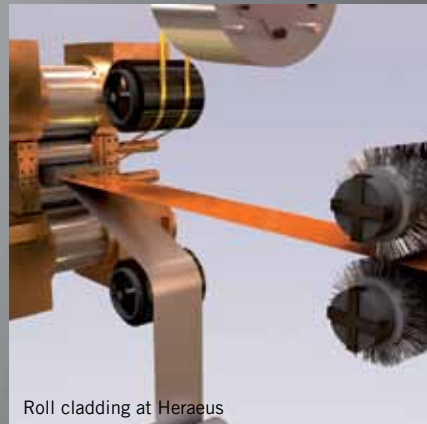

Roll cladding at Heraeus





# Power Assisted Steering



## Setting the Direction

It makes no difference which vehicle you are steering – it will without doubt contain highly specialized products from Heraeus.

Bonding wires, solder pastes, conductive, SMT and also sinter adhesives from the Contact Materials Division ensure basic connections and also attach the components firmly so that they will function flawlessly under extreme conditions.

Heraeus AISi:Bond roll clad strips, Heraeus AISi:Pad surface coated bonding pads, precision stamped parts and micro-metal-composite parts from the Engineered Materials Division are the correct choice to guarantee the safe functioning of the mechatronic components in the control devices for power assisted steering.

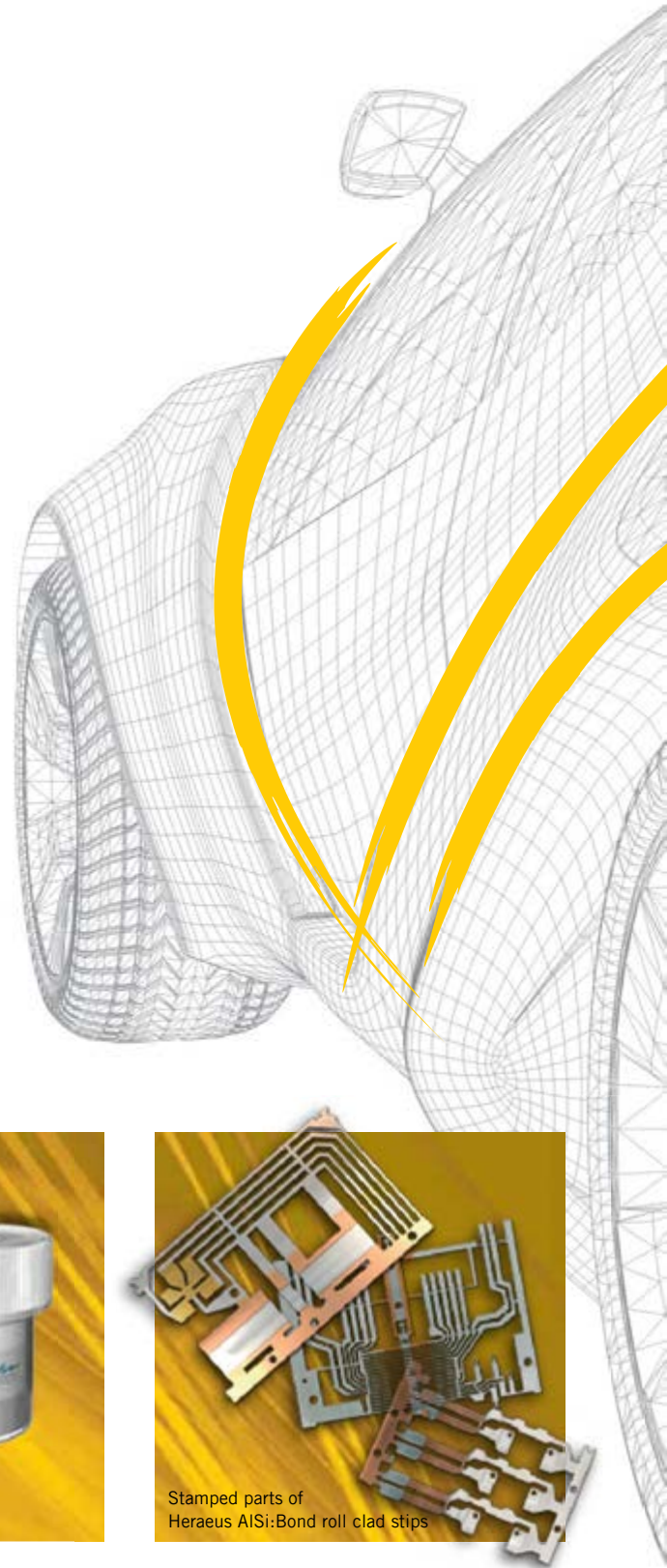

Solder pastes and SMT adhesives



Conductive and sinter adhesives



Stamped parts of Heraeus AISi:Bond roll clad strips



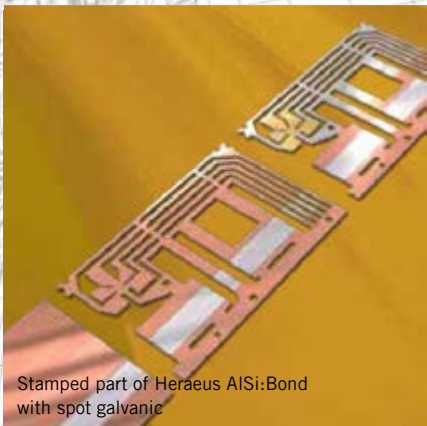
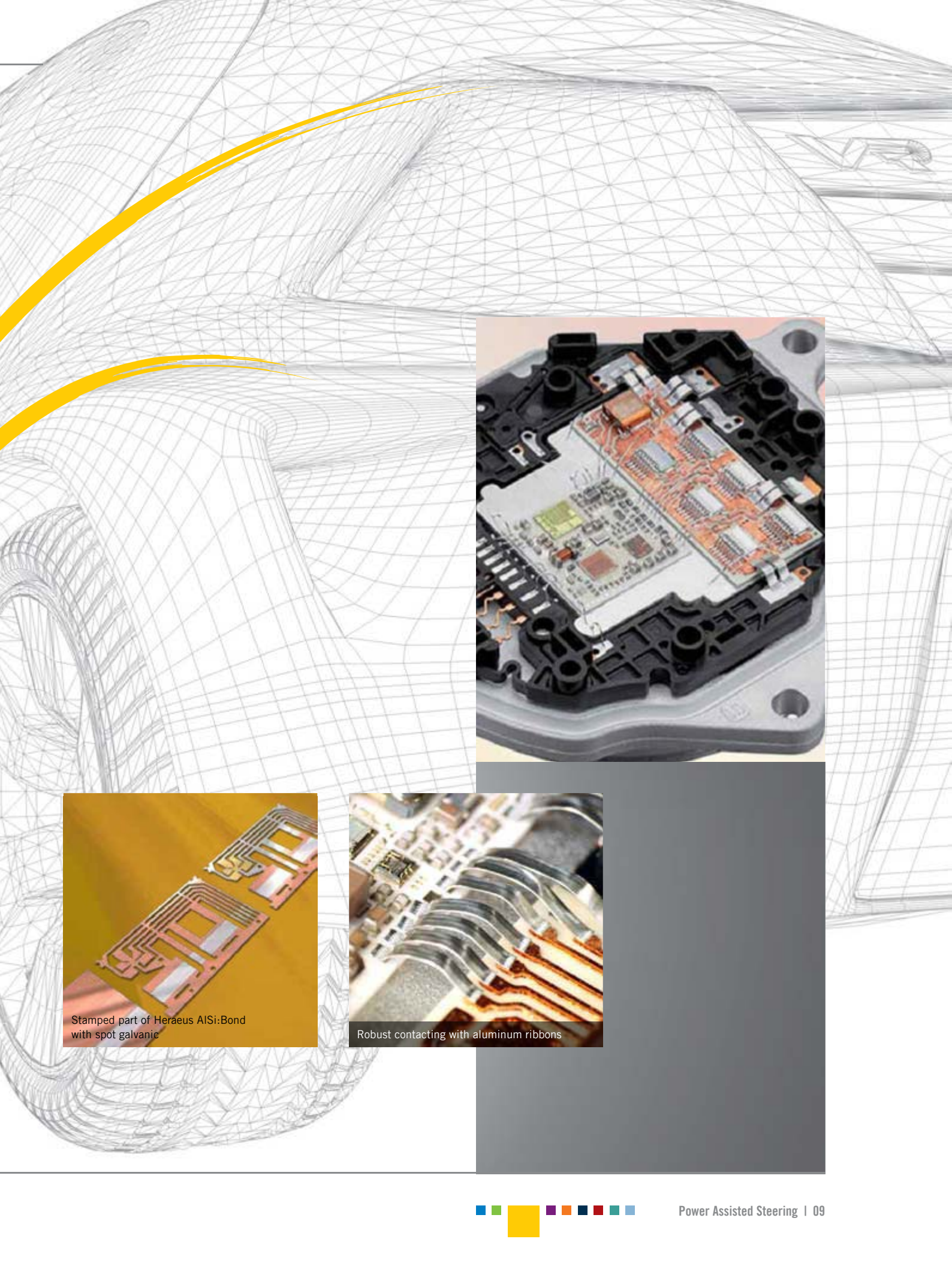

Stamped part of Heraeus AISi:Bond with spot galvanic



Robust contacting with aluminum ribbons



# Spark Plugs



## Large Spark – Low Consumption, Long Service Life

For the efficient use of our resources, a combustion engine must operate with optimized consumption. Clean combustion is a vital requirement and state-of-the-art spark plugs are essential to achieve this. Heraeus offers high performance electrode materials and composite materials of platinum and iridium alloys which are employed as the center and ground electrodes of the spark plugs.

The broad range of spark plug materials and formed parts fulfills the high demands of the manufacturers. The materials are found, in particular, in high performance spark plugs. The good resistance to erosion and burn-off gives a long service life.

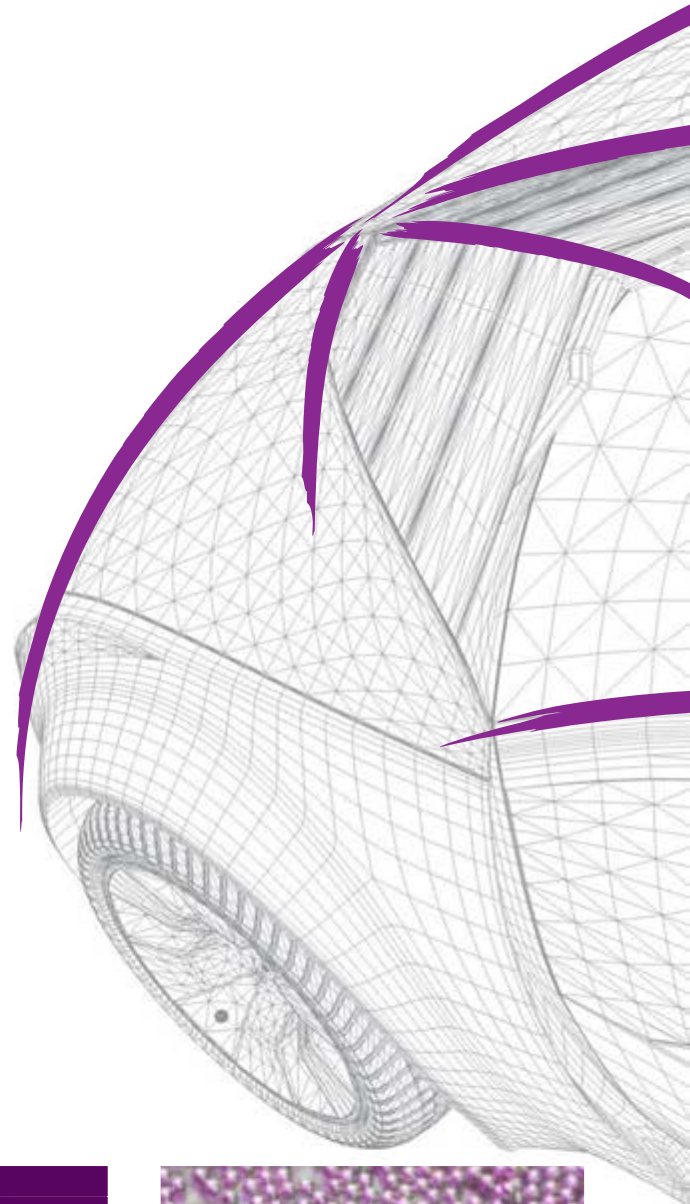

Rods made of PtIrRh alloys



Rods and cuttings made of Ir alloys

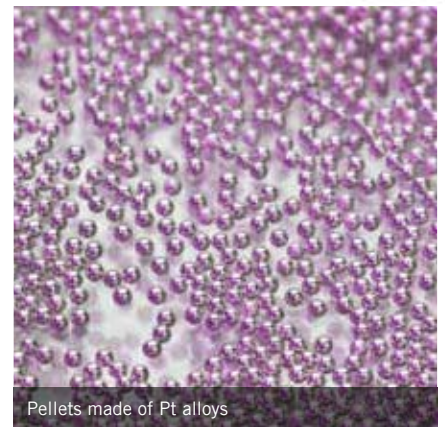

Pellets made of Pt alloys



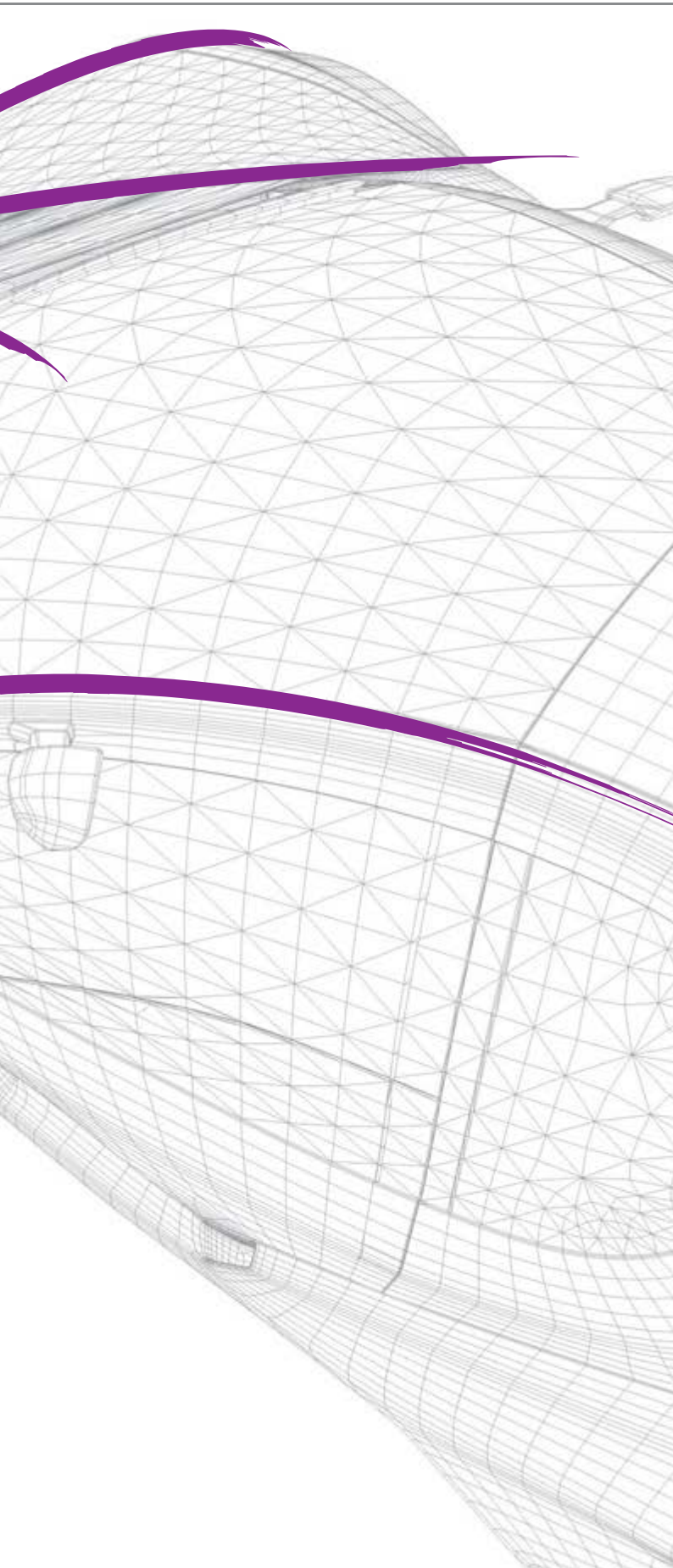

By courtesy of Robert Bosch GmbH

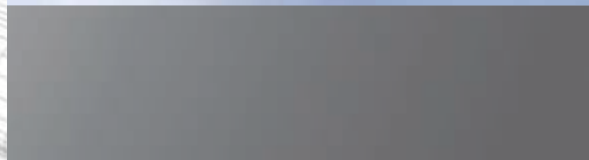

# Cockpit



## Innovative Vision

Due to increasing electronic systems, the cockpit is becoming more and more important as the visual control center of a vehicle. Heraeus and its Business Units make a valuable contribution here to providing the driver in an attractive visual form with the innumerable pieces of information which the systems in the vehicle collect and supply.

Solder pastes and SMT adhesives from Heraeus guarantee the secure and durable connections of the electronic components which collect and transmit the information. Contact parts for switches are offered, as are thick film pastes, and gold-plated springs for fuel sender.

The PVD (Physical Vapour Deposition) process is a key technology for producing functional coatings on glass. Heraeus is a leader in the development and manufacture of the coating materials and sputtering targets required. Sputtering targets from Heraeus are also employed in the foil coating of LCDs (Liquid Crystal Displays) and automatic dipping mirrors.



Sputtering targets



Solder pastes and SMT adhesives





By courtesy of Delphi Deutschland GmbH

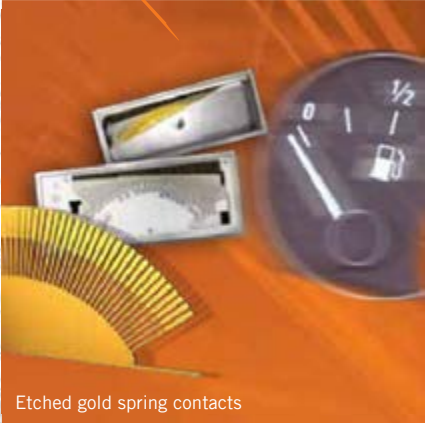

Etched gold spring contacts



Thick film pastes for fuel sender

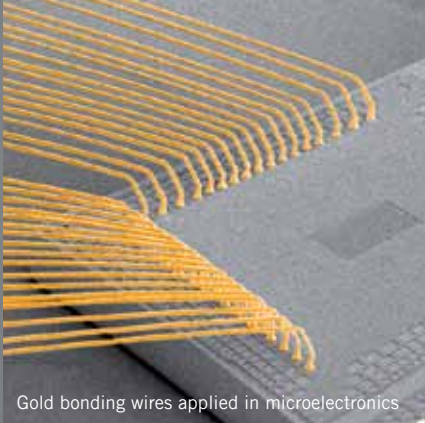

Gold bonding wires applied in microelectronics



# Headlights



## Improved Light Yield

Trend setting lighting technology is now taken for granted in automobiles. The latest lighting techniques such as LEDs (Light Emitting Diodes) and OLEDs (Organic Light Emitting Diodes) ensure pleasing and informative lighting of the interior and the safe illumination of the road ahead and its surroundings.

The sinter and solder pastes together with the conductive and sinter adhesives from Heraeus permit an improved and more efficient light yield in the field of illumination technology. They also satisfy the increased demands with regard to the thermal management in the component while maintaining temperature stability.

Precision stamped parts and micro-metal-composite parts offer the possibility of miniaturizing the systems. Furthermore, AlSi:Pad surface coated bond pads, bonding wires, and ribbons together with conductor, dielectric and resistor pastes from Heraeus can be used in the increasingly smaller control circuits.

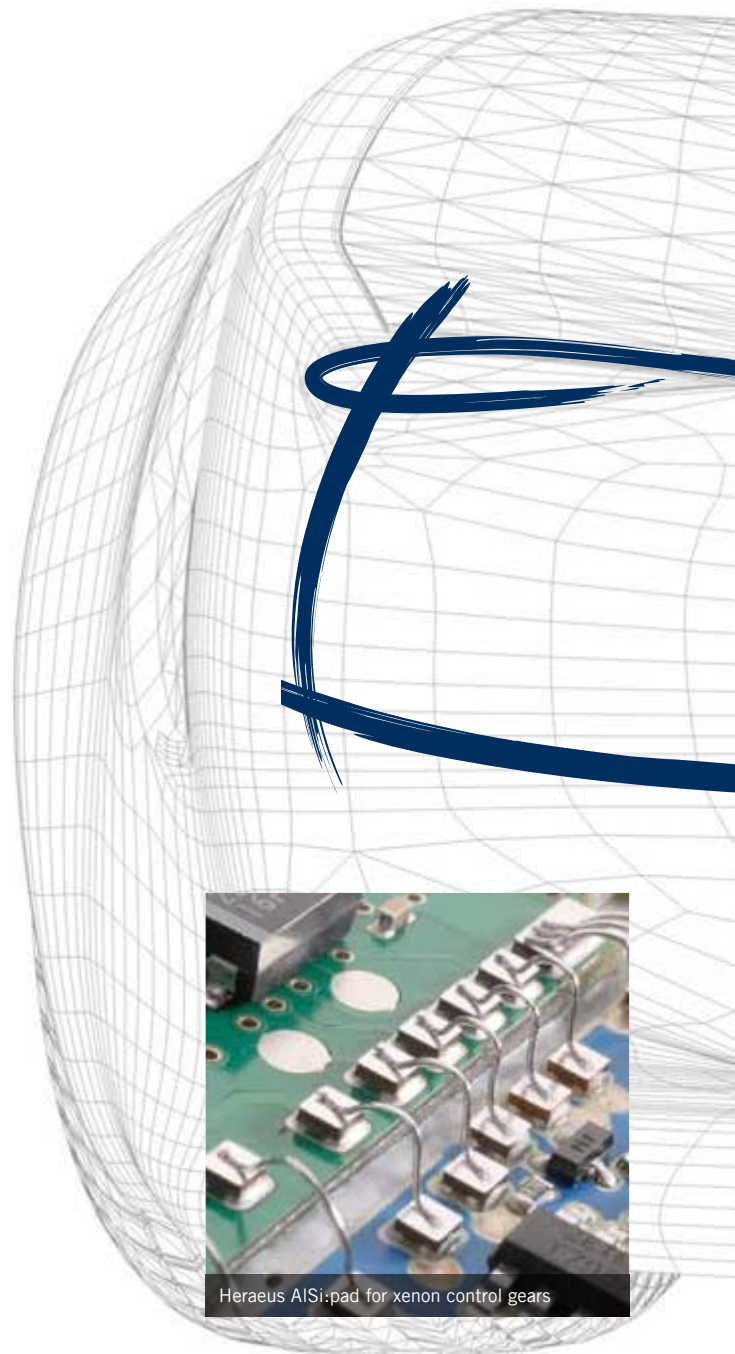

Heraeus AlSi:pad for xenon control gears





By courtesy of  
HELLA KGaA Hueck & Co., Lippstadt

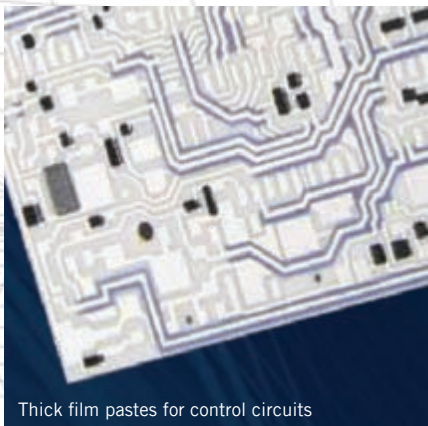

Thick film pastes for control circuits

by courtesy of Wells MFG. L.P., USA



Gold bonding wires for LED contacting



Sinter pastes, sinter adhesives,  
conductive adhesives and solder pastes



# Sensors



## The “Eyes” of Technology

Heraeus provides a wide variety of materials for the sensors in motor vehicles. These are, for example, bonding wires of aluminum and gold, AlSi:Bond roll clad strips, and precision stamped parts in various degrees of finishing. These are supplemented by solder pastes, conductive and SMT adhesives, resinate, dielectric and conductor pastes, sealing glasses and sinter adhesives.

All materials ensure secure connections within the components and also between the individual components. Multi-wire wiper contacts ensure the perfect operation of potentiometer sensors for the pedal and the start-stop system and also for the throttle valve and the air conditioning regulator.

At the same time platinum temperature sensors are used in car and truck exhaust systems to monitor turbochargers and diesel particle filters. Heraeus maintains a leading position in this field with its platinum thin film measurement probes made to customer specification.

The majority of the platinum thin film sensors in the motor vehicle are used to monitor critical temperatures or to regulate processes. They are used for the optimum post-treatment of exhaust gas, assessing the oil condition, monitoring the oil temperature in automatic transmissions, at measurement points in the turbocharger, and in safety functions, e.g. in burners for engine block heaters.



Conductive adhesives, sinter pastes, sinter adhesives and solder pastes



Sensors for high temperature control at the turbo charger



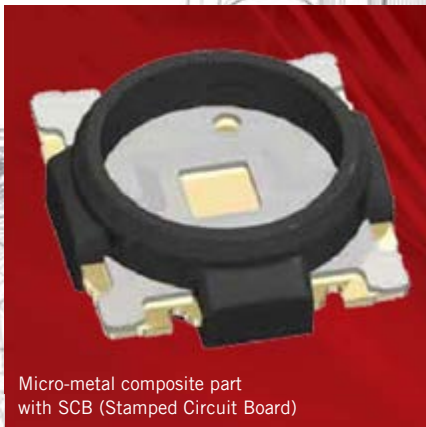
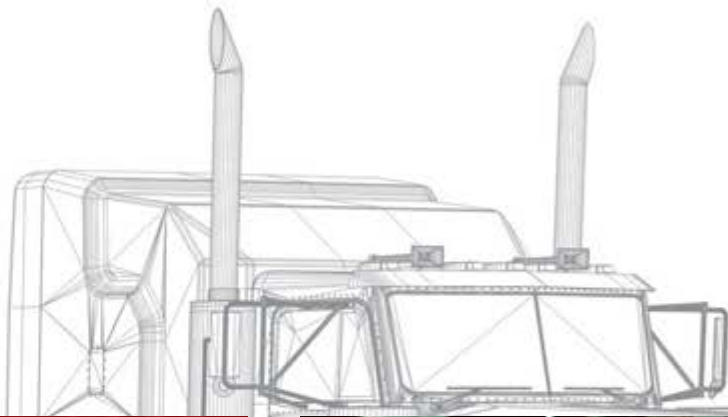

Micro-metal composite part with SCB (Stamped Circuit Board)



Gold and aluminum bonding wires for precise contacting



Multi-wire wiper contacts for potentiometric sensors

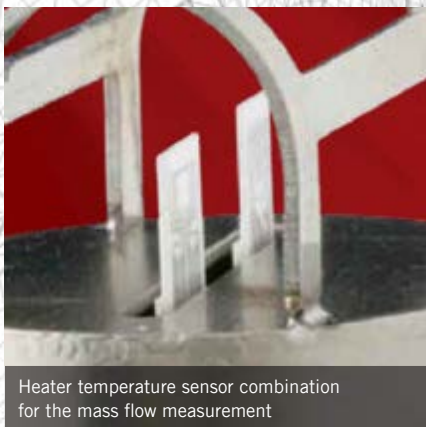

Heater temperature sensor combination for the mass flow measurement

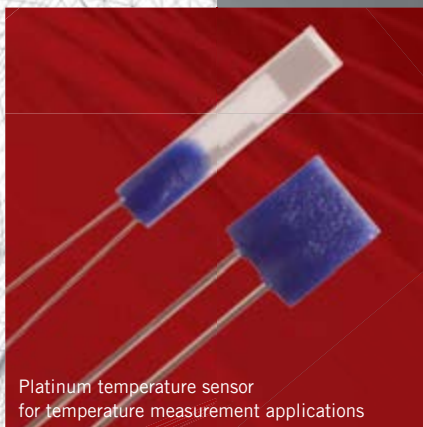

Platinum temperature sensor for temperature measurement applications

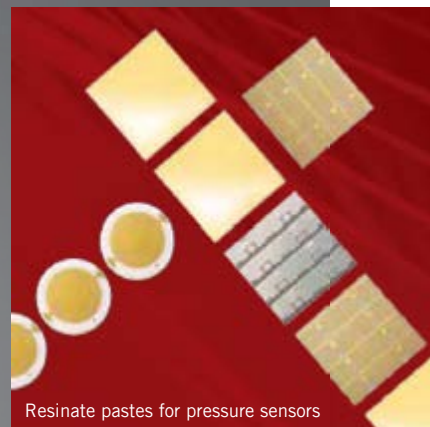

Resinate pastes for pressure sensors



# Power Electronics for Electro-mobility



## Trend Setting Drive Concepts

Electronic power assisted steering, automatic start-stop systems, electric bikes and scooters, hybrid drives, electric motors, and fuel cells: with its products Heraeus is ideally prepared for the mobile future.

Take, for example, the solder and sinter pastes, adhesives, and also the bonding wires and ribbons used for contacting chips in power electronics. Heraeus AISi:Bond roll clad strips, Heraeus AISi:Pad surface coated bond pads, precision stamped parts and micro-metal-composite parts guarantee robust joining technology and thus the efficient and dynamic power development in modern vehicles.

Where high currents flow, thick film printable silver and copper pastes from Heraeus are used. This is the case, for example, in the electrical servo-steering, the control systems for the water and oil pumps and the voltage converter for electric and hybrid vehicles.

Heraeus supplies special fuel cell pastes and other products for the fuel cell which is used as an alternative drive system and efficient substitute for the vehicle battery. These pastes are produced to customer order. The product range is complemented by organic chemicals and precious metal powders for the development and manufacture of SOFC (Solid Oxide Fuel Cells).

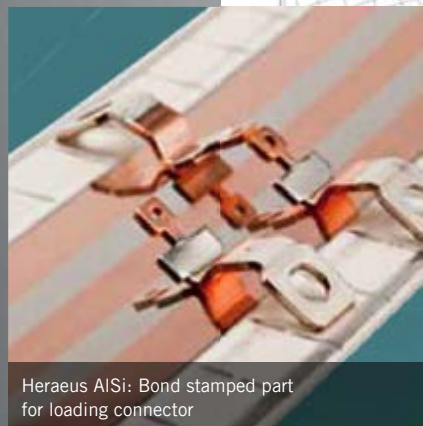
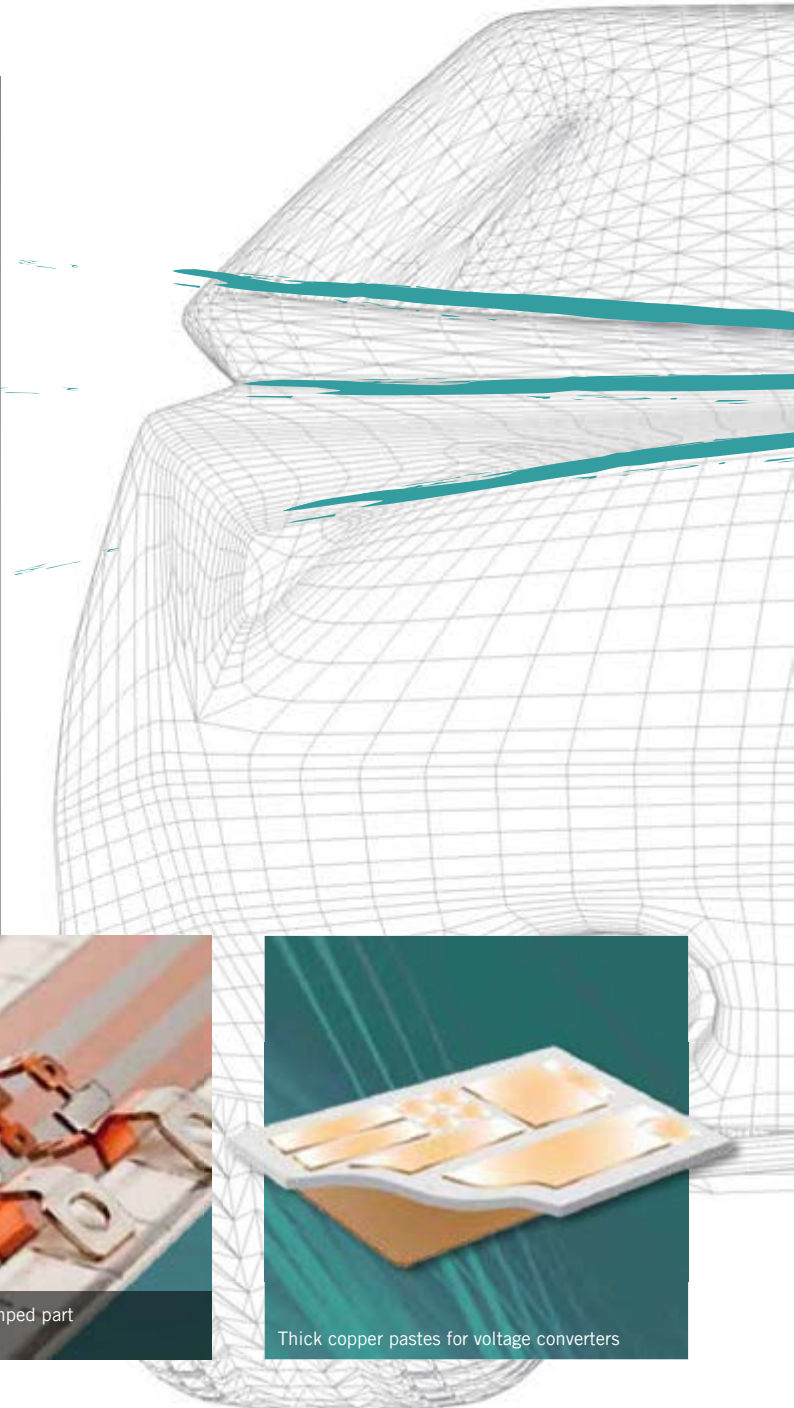

Heraeus AISi: Bond stamped part for loading connector

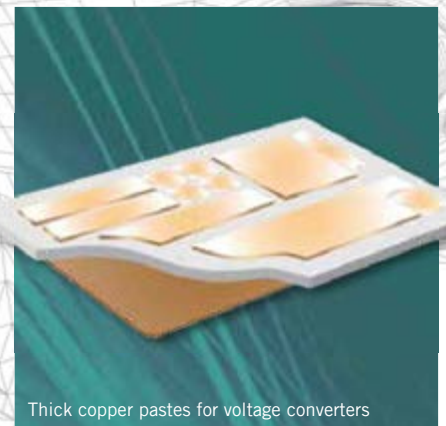

Thick copper pastes for voltage converters



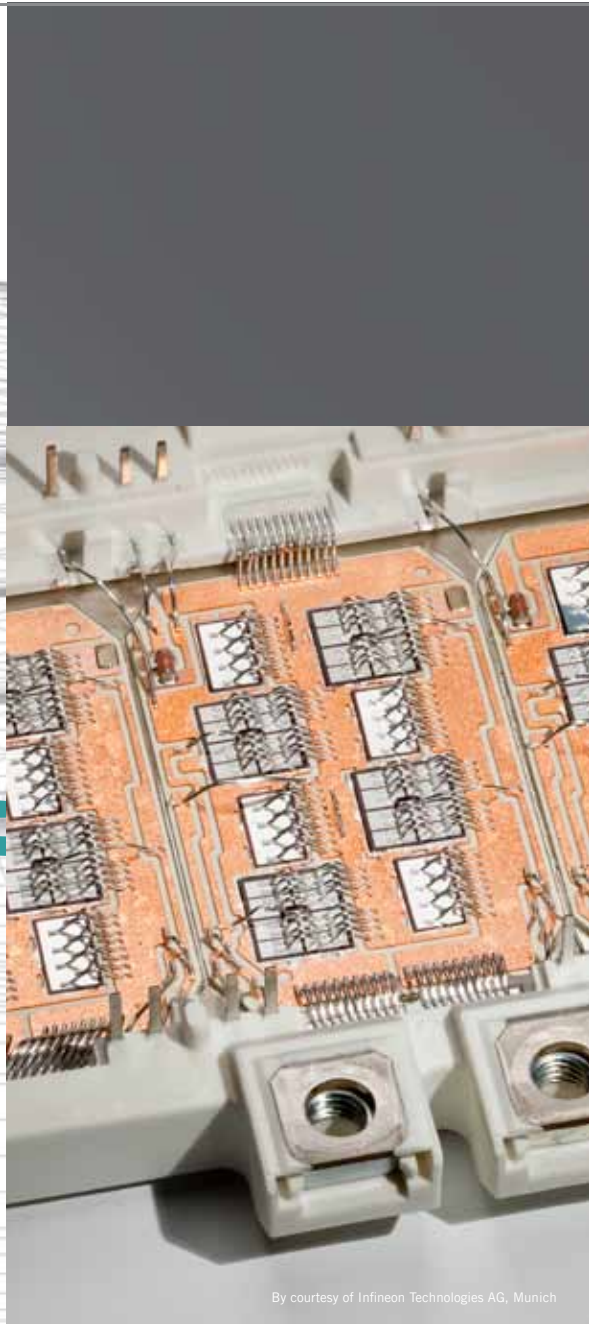
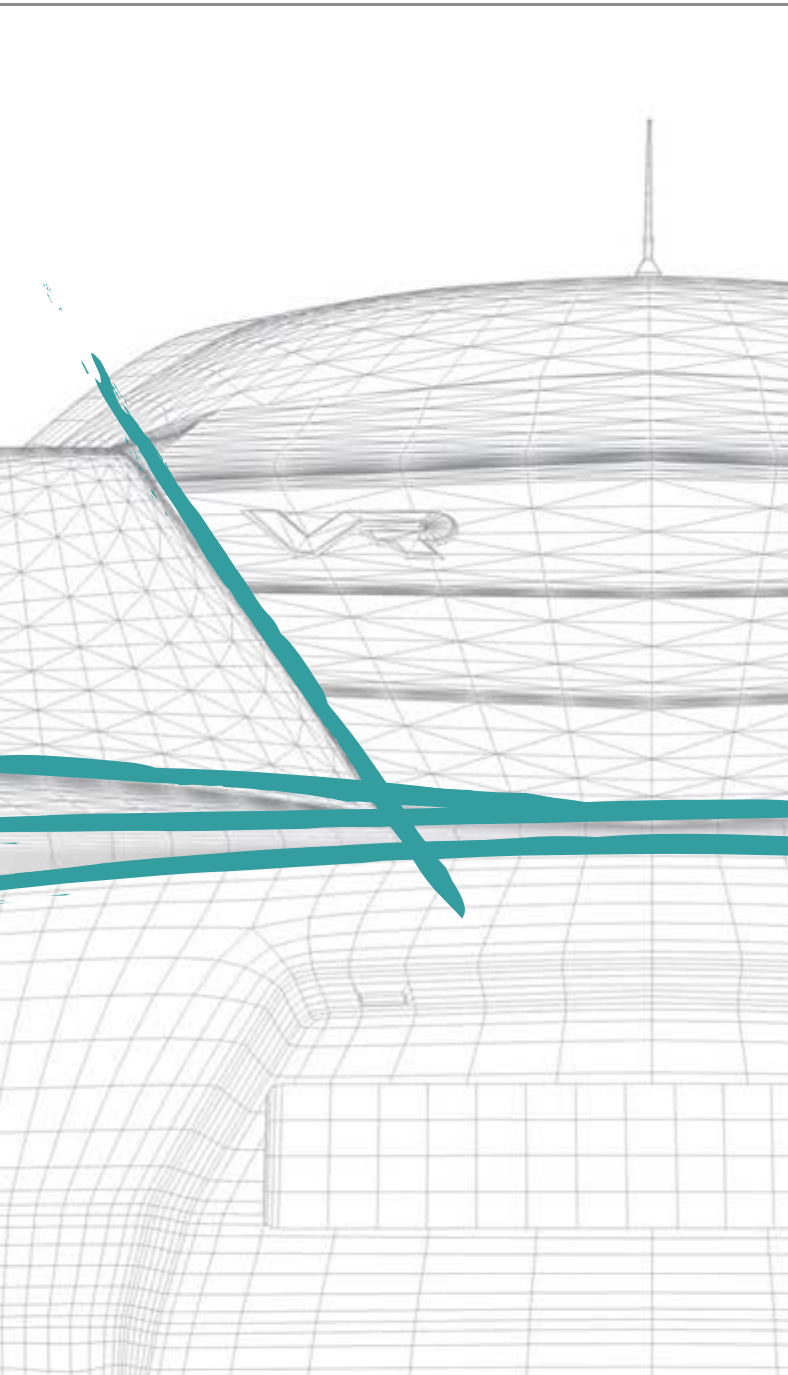

By courtesy of Infineon Technologies AG, Munich



Solder pastes, sinter pastes, sinter and conductive adhesives



Aluminum ribbons transmitting high electric load



Pastes for fuel cells



# Safety



## Safety Starts with Detail

Modern motor vehicles fulfill the highest demands regarding the personal safety of the occupants and other road users. In the event of a collision, the necessary protective measures are activated within a fraction of a second by products from Heraeus.

The solder pastes and SMT adhesives in the airbag control device ensure, for example, the perfect functioning of this component – it transmits the ignition signal to the precious metal wires (also from Heraeus) in the airbag igniter. You will also find products from Heraeus, for example, in the automatic distance control system, the braking control units, the emergency braking and lane assist systems, the ESP, and tire pressure monitors.

But the more familiar products from Heraeus are also responsible for safety in vehicles: contact springs with high contacting reliability in the seatbelt switch indicate whether the belt lock sits correctly in order to initialize the activation of the airbag system – jointly with seat recognition and active crash sensors.

- LANE ASSISTANT
- NIGHT VISION SYSTEM
- BLIND SPOT ASSISTANT
- ANTI-LOCK BRAKE SYSTEM
- AIRBAG SYSTEM
- BRAKE ASSIST SYSTEM
- ELECTRONIC STABILITY PR
- DISTANCE CONTROL ASSIST
- EMERGENCY BRAKE ASSIST
- TIREDNESS SENSOR



Solder pastes and SMT adhesives



PROGRAM  
T SYSTEM  
TANCE

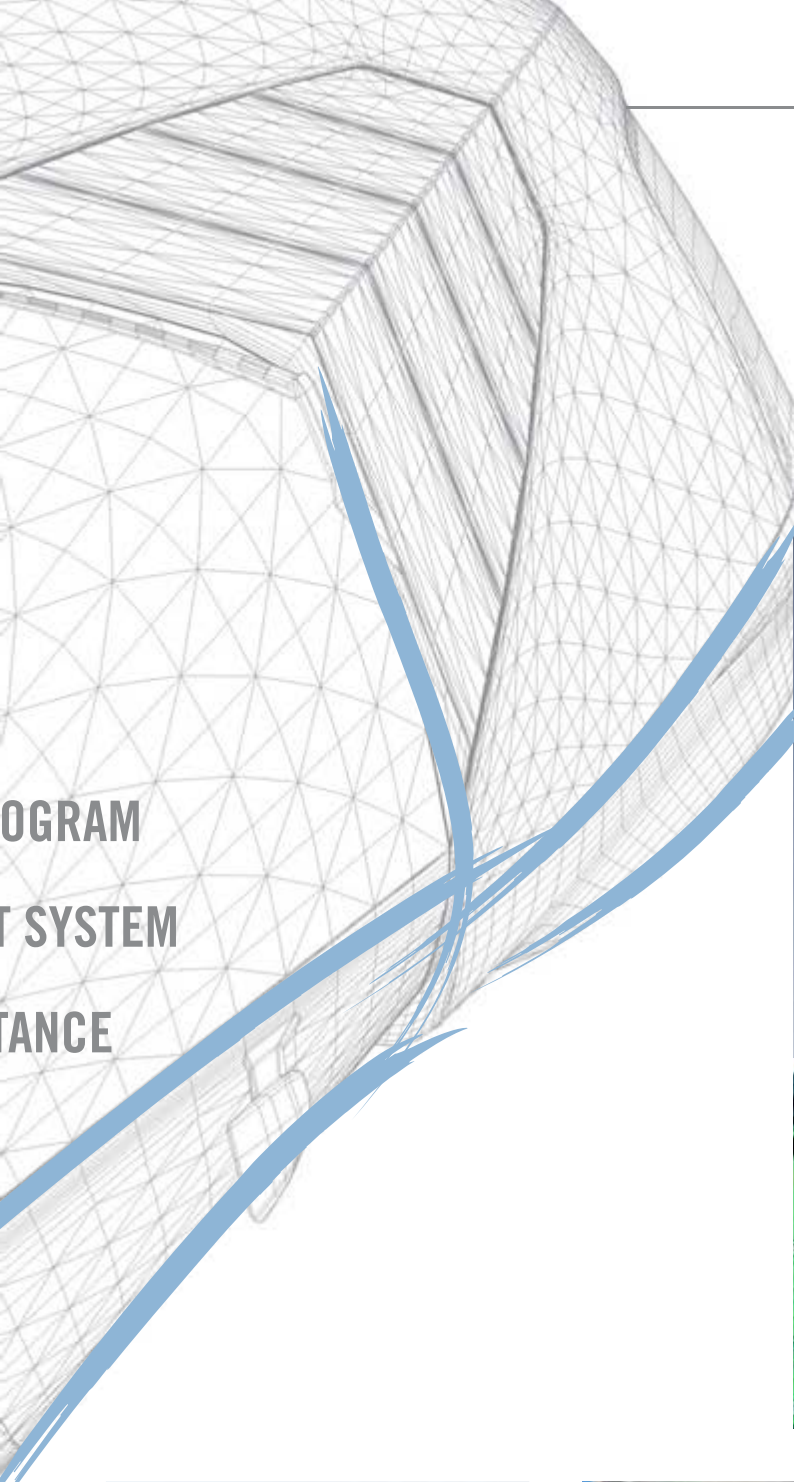

By courtesy of  
Robert Bosch GmbH



By courtesy of Continental AG, Hannover



Resistance wires for airbag initiators



Airbag wire in initiator



Contact springs for safety belt lock switches



# Heraeus Service and Quality Assurance



## Quality at the Highest Level

The central analysis laboratories of Heraeus, which specialize in physical and chemical analysis problems, perfectly complement the applications laboratories which are focused on the main manufacturing processes.

The advance of precious metals into an enormous variety of fields, e.g. the manufacture of conductive adhesives for electronic components, has led to the expansion of the range of analyses to also include methods for organic substances. In particular, chromatographic, thermo-analytical and micro-biological methods are named here. The main focus of the work is precious metal analysis followed by the characterization of surfaces of the parts to be joined. For this purpose, specialists inspect the suitability for bonding, adhesive joining, and soldering in the micron and nanometer ranges.

Heraeus has four laboratories for these investigations:

- Technical applications center for electronic circuit assembly and semiconductor applications
- Bonding laboratory
- Metallurgical laboratory
- Chemical laboratory

With the production equipment, which is available in many of these areas, investigations can be carried out under conditions relevant to applications, e.g. in the packaging of electronic circuits and in new in-house developments. The available machinery is from well known companies and international partners.





Scanning electron microscope (SEM)

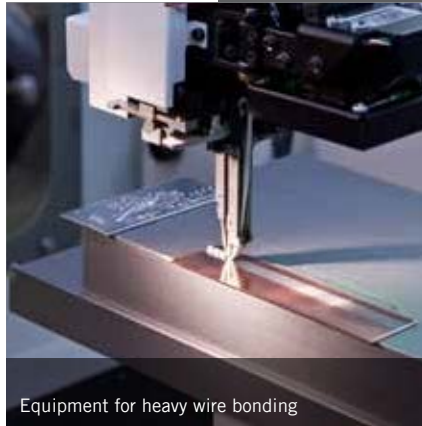

Equipment for heavy wire bonding



High speed bonding in our bonding laboratory

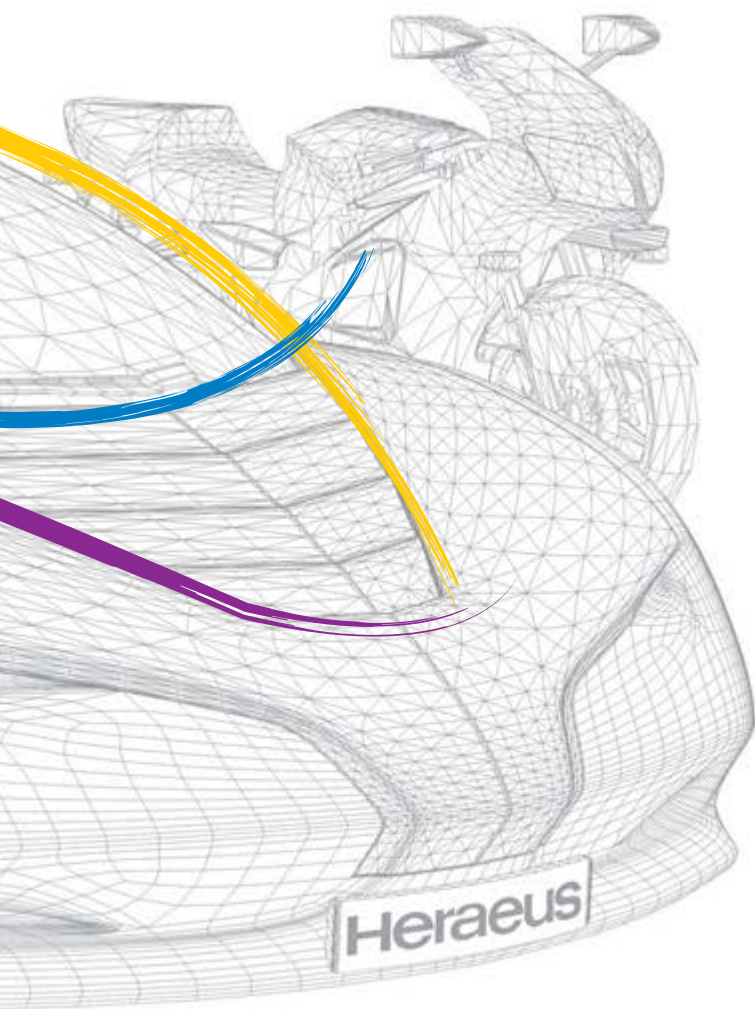

### Precious Metal Cycle and Management

An in-house precious metal management system with industrial precious metal trading guarantees the complete representation of all processes in the precious metal cycle – from purchasing to recycling the valuable materials.

The central precious metal management is at the heart of the complete precious metal cycle. Here are the purchasing and sales (through the precious metals trading) and the management of the return of products containing precious metals. In the refining, the precious metals are won in the required grades of purity.

The reclaiming of precious metals from production residues and used products has decisive commercial and ecological significance. Thus the precious metal cycle is completed by the recycling and refining.

The great strength of Heraeus lies in the creation of uniform global standards, production processes and purities.

[www.heraeus-trading.com](http://www.heraeus-trading.com)  
[www.heraeus-recycling.com](http://www.heraeus-recycling.com)



**Heraeus Materials Technology GmbH & Co. KG**

Heraeusstr. 12 - 14  
63450 Hanau, Germany  
Phone +49 6181.35-0  
Fax +49 6181.35-3131  
hmt@heraeus.com  
www.heraeus-materials-technology.com

**Heraeus Precious Metals GmbH & Co. KG**

Heraeusstr. 12 - 14  
63450 Hanau, Germany  
Phone +49 6181.35-0  
Fax +49 6181.35-3588  
hpm@heraeus.com  
www.heraeus-precious-metals.com

[www.heraeus-automotive.com](http://www.heraeus-automotive.com)

