

# BUS BAR SOLUTIONS

Electrical Power Distribution



**MERSEN**

Eldre | Ferraz Shawmut | R-Theta

# ELDRE IS NOW MERSEN

## ELDRE IS NOW MERSEN

Eldre is now part of the Mersen family. Mersen is known worldwide for providing expertise to customers for safety and reliability of electrical power. With the addition of Eldre to the Mersen family, Mersen adds laminated bus bar to its extensive portfolio of products, creating a powerful bundled product offering for the protection of power electronics.

## WHAT IS LAMINATED BUS BAR?

Laminated bus bar is an engineered component consisting of layers of fabricated copper separated by thin dielectric materials, laminated into a unified structure. Sizes and applications range from surface-mounted bus bars the size of a fingertip to multilayer bus bars that exceed 20 feet in length. Laminated bus bar solutions are routinely used for low volumes up through tens of thousands per week.

## WHY CHOOSE LAMINATED BUS BAR?

Bus bars reduce system costs, improve reliability, increase capacitance, and eliminate wiring errors. They also lower inductance and lower impedance. Plus, the physical structure of bus bars offers unique features in mechanical design. For example, complete power distribution subsystems can also act as structural members of a total system. Multilayer bus bars offer a structural integrity that wiring methods just can't match.

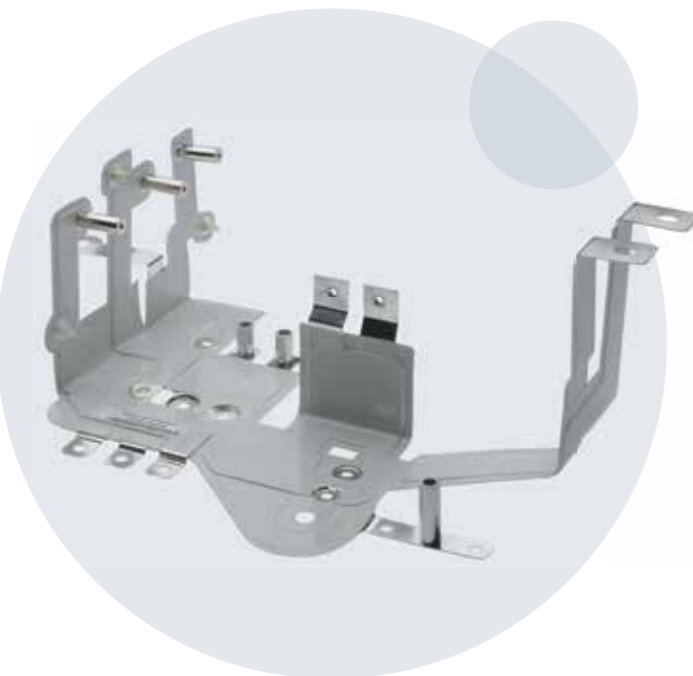

## A REPUTATION FOR QUALITY

Mersen's reputation for outstanding technical expertise, product quality, and engineered safety is the result of over a century of design and manufacturing knowledge, coupled with state-of-the-art equipment in three ISO-9001 registered facilities. Each facility manufactures single and multilayer bus bars, as well as fully integrated solutions in which the laminated bus bar also serves as a platform for a multitude of discreet components:

- In Europe, our 5,000 m<sup>2</sup> plant in Angers is a center of excellence for laminated bus bar solutions
- In North America, our 110,000 ft<sup>2</sup> plant in Rochester, New York is a vertically integrated center of excellence for all power distribution solutions, plus AS9100C registered
- In Asia, a brand-new 6,500 m<sup>2</sup> facility in Shanghai, China offers full manufacturing capability of all power and bus bar solutions

Our commitment to quality is clearly evident from the very beginning of the design process, right through to the production of the last part. Our Quality System is designed with defect prevention in mind and is certified to AS9100. Our staff of professional engineers and experienced designers develops the tooling and manufacturing methods, procedures, and process parameters to meet our customers' specifications.

With over sixty years of experience in designing laminated bus bars and complete in-house manufacturing capability, we have the flexibility and expertise to respond to our customers' requirements through:

- quality control and quality assurance
- engineering and design
- chemical milling
- electroplating
- assembly
- epoxy encapsulation
- tool and die design and build
- metal fabrication
- metal joining
- die cutting
- laminating
- electrostatic powder coating

# POWER ELECTRONICS BUNDLING SOLUTIONS

## TURN TO MERSEN FOR CUSTOMIZED ELECTRICAL PROTECTION SOLUTIONS FOR POWER ELECTRONICS

Combine Mersen square body semiconductor fuses with Mersen's thermal protection and laminated bus bar offerings for an optimized system solution to support your power electronics designs. As a design partner with extensive application

and product expertise, Mersen is able to maximize system performance, lower total costs, and reduce time to market. Our dedicated power electronics team is available to customize a solution for you.

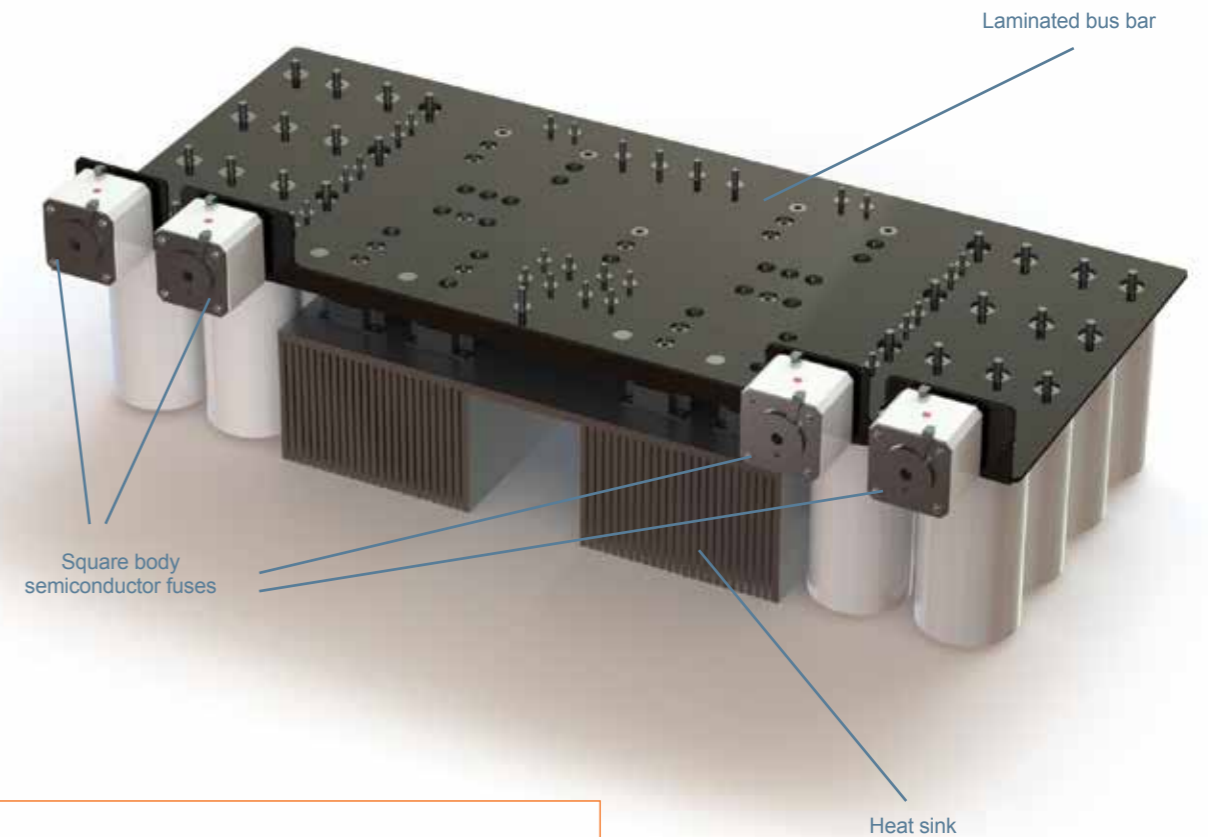

**For Power Electronics solution inquiries, contact [pesupport.nby@mersen.com](mailto:pesupport.nby@mersen.com)**

# PEACE OF MIND...

...in the confidence and comfort from over one hundred years of success and technical innovation

...because each design is a unique solution, based on millions of man-hours of experience

...in a working relationship with vertically integrated factories recognized worldwide for excellence

...from a quality-driven, production-based approach to manufacturing.

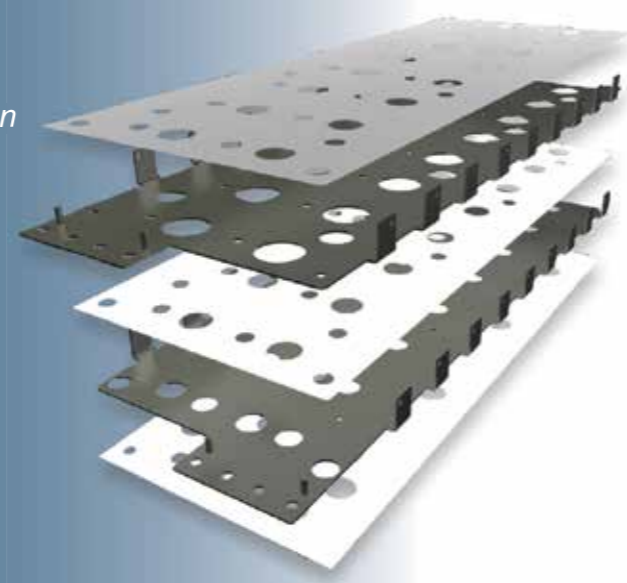

## SUPERIOR QUALITY FROM DESIGN THROUGH MANUFACTURE

From the first design consultation through dock-to-stock shipments, Mersen provides customers with innovative power distribution solutions. You're always assured that we've omitted nothing in our quest for customer satisfaction. Let us offer you the same peace of mind that thousands of other companies have enjoyed for more than 60 years. Here are just a few reasons:

- **State-of-the-art metal fabrication** is a key component to producing quality product. Our state-of-the-art metal fabrication is maintained in-house and includes CNC fabricators, photo-chemical machining, production punch presses ranging up to 200 tons, CNC press brakes, and various edge conditioning processes. We offer a wide range of metal joining processes including ultrasonic welding, induction brazing, torch brazing, and soldering.
- **Plating** – Our complete, in-house plating department can produce almost any finish to meet your needs. Our finishing includes tin, tin-lead, nickel, copper, silver, and gold. Plating under tight, laboratory-controlled conditions, we monitor and control plating thickness to required specifications to meet all customer requirements. Careful data monitoring, in-process controls, and x-ray testing combine to ensure a quality finish.
- **Precision manufacturing of dielectric components** is crucial in laminated bus bar production. To ensure quality, we maintain calibrated humidity and temperature controlled conditions to store our insulation. Precision steel rule dies are used for cutting the insulation, ensuring uniformity of size to produce quality bus bars.
- **Properly selected insulation** is the key factor to a bus bar's electrical integrity. We utilize a wide variety of dielectric materials, including Nomex, Tedlar, Mylar, Kapton, Epoxy-Glass, GPO, Gafex, and Phenolics; readily available to meet virtually any specification. In addition to traditional sheet lamination systems, we maintain our own electrostatic powder coating department that produces a quality epoxy finish with high dielectric protection for bus bars with geometric forms, or those used in harsh environments.
- **Assembly and Lamination** is controlled using sophisticated laminating systems specifically designed and manufactured for each bus bar. Hardware and interconnection devices can be added before or after the laminating and plating process.



WHAT IS A LAMINATED BUS BAR?

pg 2



POWER ELECTRONICS

pg 6



ALTERNATIVE ENERGY

pg 8



TRANSPORTATION

pg 10



DEFENSE & AEROSPACE

pg 12



INDUSTRIAL

pg 14



COMPUTERS

pg 16



TELECOM

pg 20



VALUE ADDED

pg 24

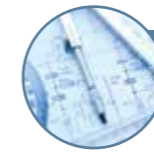

LAMINATED BUS BAR DESIGN GUIDE

pg 30

# POWER ELECTRONICS

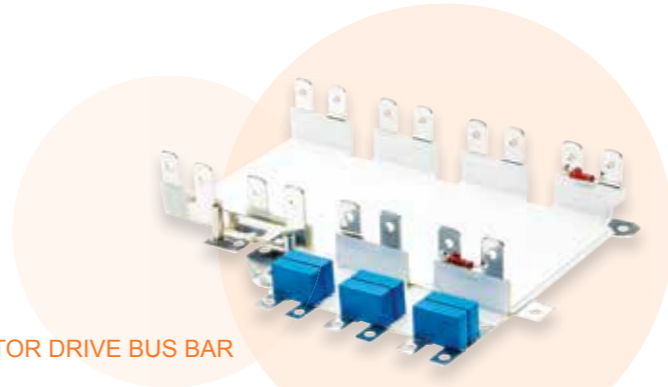
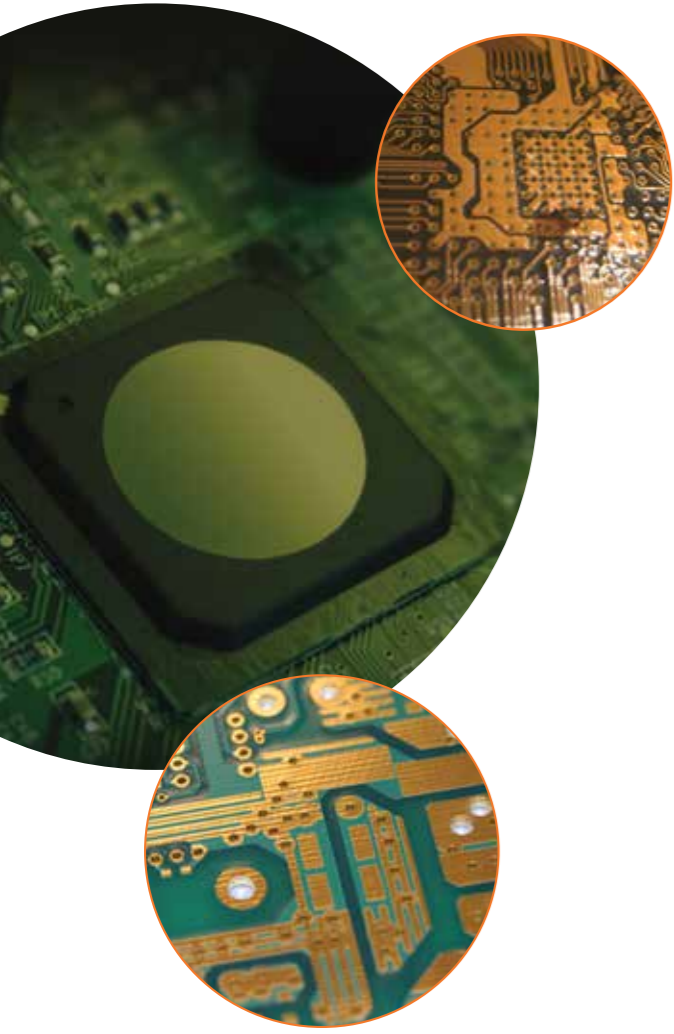

## MOTOR DRIVE BUS BAR

Thin copper conductors, separated by insulation material of only thousandths of an inch, provides the ultimate in low inductance for IGBT-based motor drives. Incorporating electrolytic capacitors into the same structure simplifies packaging and reduces the effects of transient overshoots. Note the addition of Snubber Capacitors and Resistors built into the laminated bus bar!

Size: 7" x 9" | Thickness: .040" | Voltage: 475VDC | Current: 150A



## CAPACITOR BUS BAR FOR MOTOR DRIVE

Six electrolytic capacitors are easily connected to this edge-sealed, two-layer laminated bus bar providing a low inductance power path for a low horsepower, variable speed motor drive. Note the use of a bonded insulator strip along the length of the bus bar to provide additional "creepage" protection between the plus and minus terminals.

Size: 1.8" x 6.3" | Thickness: .040" | Voltage: 480VDC | Current: 60A

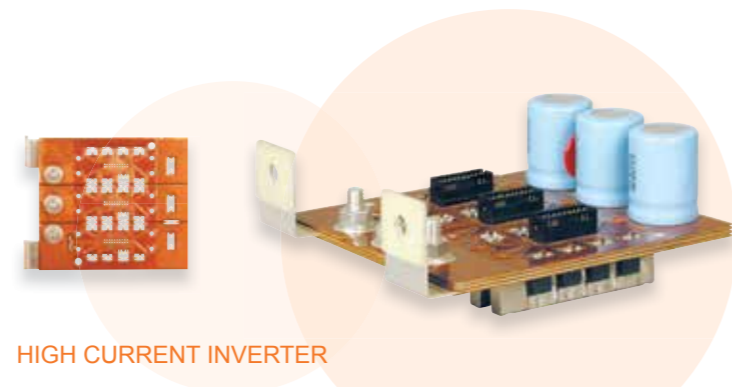

## HIGH CURRENT INVERTER

A laminated bus bar assembly consisting of three power layers and one signal layer with a total of 59 conductors providing a very low inductance power path and complete gate drive circuitry all designed for a wave-solder assembly process. This bus bar is used in a system powered by 24 MOSFETs. It includes Electrolytic Capacitors, heatsinks, and MOVs.

Size: 5" x 7" | Conductors: .060" (gate circuit: .025") | Voltage: 28VDC | Current: 1000A peak

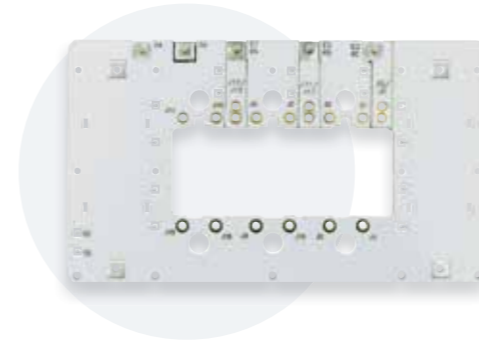

## SPACECRAFT POWER INVERTER

High-current circuit board design using laminated technology for IGBTs and support components. Includes gold plating, quick connect mounting. This laminated bus bar is an enhanced design of a typical IGBT bus bar. Manufactured to be easily serviced, the design uses gold high current sockets, which are soldered into the DC layers. The design also accommodates resistors and MOVs, soldered right into the assembly. Completely edge-filled perimeter, the bus bar also has insulated mounting holes.

Size: 6" x 12" | Thickness: .040" | Voltage: 220V | Current: 75A

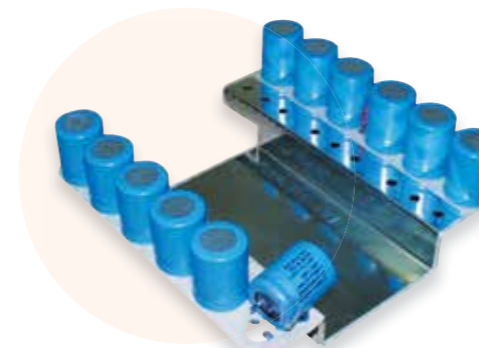

## MOUNTING STRUCTURE FOR CAPACITOR BANK

Laminated bus bars provide a low inductance connection for capacitors. The assembly was designed for an automated production process and the assembly is the DC capacitor bank used in conjunction with high-current, high-speed switching applications. Positive and negative layers are formed and laminated without outside insulation. This design includes two rows of capacitors soldered into position.

Length: 8" | Width: 7.5" | Voltage: 28V | Current: 100A

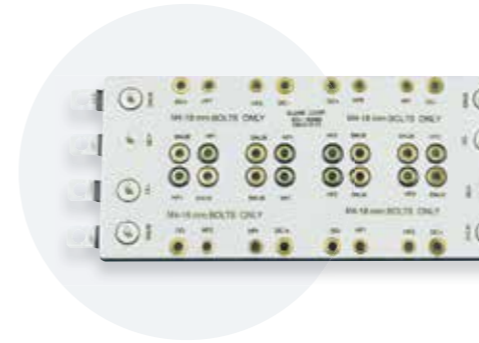

## HIGH-FREQUENCY WELDING

Connecting a complex network including Power IGBTs, Diodes, Resistors, and Film Capacitors, this multilayer epoxy edge-filled bus bar provides a compact low inductance solution. Thirty-two bushings are brazed into position and maintain tightly controlled coplanar mounting surfaces on both top and bottom. Alternating the plus and minus layers throughout the assembly counters the skin effect of high frequencies.

Size: 5" x 9" | Voltage: 115VDC | Current: 125A | Thickness: .030" x .060"



## HIGH FREQUENCY INVERTER

High-frequency applications present a unique thermal challenge requiring the addition of water-cooling for efficient operation. When thermal considerations exceed conventional means of heat dissipation, one option is to add water-cooling to the system. This design contains five cooling lines soldered directly onto the epoxy powder coated conductors to maintain a constant temperature. Due to the high frequency of the AC voltage, "skin effect" plays a big role in the heat created from the bus and without this additional cooling, the bus would surely overheat.

Size: 9" x 32" | Thickness: .030" and .060" | Voltage: 600V | Current: 700A

With the introduction of the IGBT in the early 1990s, a new era of design sophistication began. The higher switching speed of today's IGBT demands a low inductance power path which is uniquely delivered by the Mersen laminated bus bar.

Mersen's innovative Power Electronic designs provide the ultimate in low inductance DC power which is the "life blood," securing the best suppression of parasitic transients and safe operation for long life. The Mersen laminated bus bar is the key component of the DC power circuit, enabling the IGBT / Electrolytic Capacitor circuit to provide perfect power and trouble-free service.

Engage Mersen's design team on your next project and see first hand our ingenuity at work!

# ALTERNATIVE ENERGY



As the depletion of fossil fuels drives our attention towards alternate energy sources to power our daily lives, Mersen's laminated bus bars can be found in new, but familiar territory.

Whether it's in Solar, Wind Power, or Fuel Cells, the creation of DC energy feeds directly through Mersen's low inductance laminated bus bars into an IGBT and capacitor circuit, delivering the safe and efficient power our customers demand.

Mersen's quality-engineered laminated bus bars use state-of-the-art materials and manufacturing techniques that minimize weight and maximize simplicity!

## HYBRID VEHICLES

Designed with automotive reliability in mind, this two-layer, laminated bus bar joins parallel rows of batteries together in a hybrid vehicle application.

Size: 3" x 4" | Thickness: .093" | Voltage: 60VDC | Current: 40A

## SOLAR POWER

Multilayer, laminated bus bar used in a Photovoltaic Inverter application. Diodes, IGBTs, and Electrolytic Capacitors are all easily interconnected in one compact power distribution structure.

Size: 16" x 28" | Voltage: 48VDC | Current: 240A | Conductors: .050"

## MASS TRANSIT

This rugged two-layer, four-conductor bus bar is production built for a Hybrid Transit Inverter application. The perimeter is a laminated sealed-edge construction. It shows the system simplicity of combining capacitors and IGBTs into a single bus bar system.

Size: 12" x 18" | Thickness: .125" | Voltage: 475V | Current: 250A per layer

## WINDMILL INVERTER

This laminated bus bar design demonstrates excellent packaging efficiency. By designing all electrical connection points for the IGBTs, Capacitors, I/O, and monitoring devices in one clean bus bar, overall system reliability is improved and optimal electrical performance is assured.

Size: 16" x 28" | Thickness: .093" and .25" | Voltage: 480V | Current: 240A

## PUBLIC TRANSPORTATION

One of the hallmarks for Alternate Energy applications is packaging components in tight confines. This laminated bus bar packs nine electrolytic capacitors in a tight package in between two rows of IGBTs. This arrangement is a natural fit for laminated bus bar technology!

Size: 4" x 8" x 24" | Conductors: .040" each | Voltage: 400VDC | Current: 350A

# TRANSPORTATION



Whether it's carrying the high current necessary to power heavy equipment, rail, and subway cars—or reducing weight and enhancing packaging efficiency for the latest aircraft and hybrid vehicles—Mersen laminated bus bars bring unique advantages to the transportation industry that are not available with traditional wiring or single conductor bars. The electrical performance of Mersen-engineered laminated bus bar is a key component to success throughout the transportation industry.

A properly engineered laminated bus bar provides the lowest overall system inductance and the most balanced and distributed capacitance, making it the perfect match for the high demands of the transportation equipment industry. Mersen laminated bus bars help transportation equipment manufacturers achieve their reliability goals, thus lowering warranty costs and enhancing customer satisfaction.

## ALTERNATE FUEL SYSTEMS

Fuel cells and hybrid electric vehicles require rugged, reliable power distribution. Heavy duty construction with epoxy powder coating as a dielectric allows this laminated bus bar design to perform to specifications in harsh environments.

Size: 6" x 14" | Voltage: 600VDC | Current: 150A | Conductors: .125"

## TRACTION DRIVE

Modern traction drives combine high current and high voltage in highly confined spaces. Mersen's design experience utilizes individually laminated conductors, glass insulation spacers, and unique copper bushing "vias" to achieve an efficient, concentrated package with a minimum of special tools.

Size: 7" x 11" | Conductors: .040" | Voltage: 1200VDC | Current: 250A

## LOCOMOTIVE

The laminated bus bar shown here represents a single-phase leg for a large three-phase inverter powering modern AC locomotives. Long term durability and continuous operation in hostile environments demand high quality and consistency. The laminated bus bar has molded-sealed edges and fully insulated mounting holes, built and tested to meet customer partial discharge requirements.

Size: 11" x 20" | Thickness: .050" | Voltage: 600V | Current: 140A

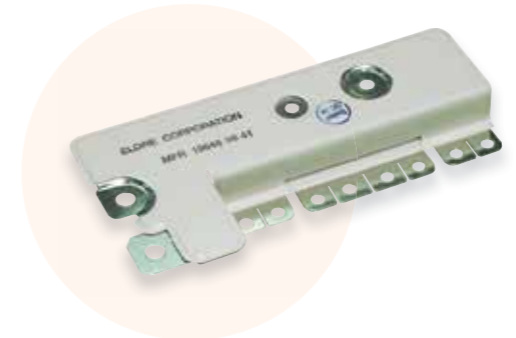
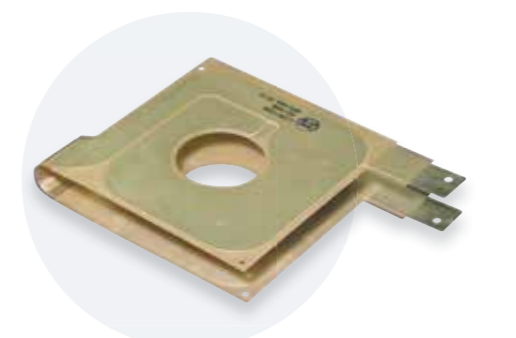
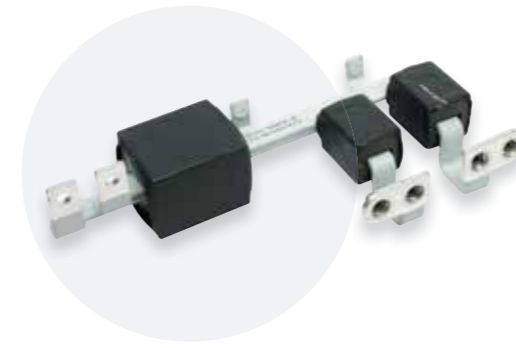

## ELECTRIC VEHICLE POWER DISTRIBUTION

When power has to be routed through tight confines that twist and turn, Mersen's epoxy powder coating provides 100% dielectric protection. This two-conductor laminated assembly includes bonded ceramic chokes, nylon reinforced mounting holes, and floating clinch hardware for easy installation and optimized electrical performance in an automotive environment.

Size: 4" x 9" | Conductors: .125" | Voltage: 150VDC | Current: 100A

## HIGH-END AUDIO / PCB BUS BAR

Uniquely designed two-layer, 18 conductor, PCB-style bus bar saves valuable board space while delivering low-impedance power to power-semiconductors in automotive sound systems. All conductors are made of .025" copper, plated for solderability and the entire assembly is formed at a right angle.

Length: 10" | Width: 1.5" | Voltage: 12V | Current: 6A to 16A

## ELECTRIC VEHICLE CHARGE PORT

Planar power technology is enhanced through laminating with thin dielectric materials which yields a sealed, rugged structure. This design is formed into a "U" shape and is electrically tested underwater to assure performance.

Size: 7" square | Thickness: .020" | Voltage: 140VDC | Current: 40A

## ELECTRIC VEHICLE POWER ELECTRONICS

Individually laminated, this two-conductor bus bar connects electrolytic capacitors and IGBTs in a small, lightweight package for an EV Inverter.

Size: 3" x 6" | Conductors: .020" | Voltage: 150VDC | Current: 60A

## LOCOMOTIVE TRACTION DRIVE

High horsepower traction drives benefit from the low inductance power path made possible by Mersen laminated bus bars. Laminated bus bars are the essential component that ties IGBTs and capacitors together. By minimizing system inductance, transient over-shoots are reduced which greatly simplifies the need for complex snubber circuitry. Laminated bus bar designs for motor drives can contain a number of modular bus bars, linked together, to connect all of the system components into one complete system.

Length: 10.5" | Width: 8" | Voltage: 600VDC | Current: 650A

# DEFENSE & AEROSPACE



Uncompromising performance and reliability are a must for defense and aerospace systems. That is why laminated bus bars designed by Mersen are commonplace in a wide range of defense applications, including missile guidance equipment, phase-array radar systems, sonar and radar tracking stations, airborne equipment, tanks, submarines, and numerous space programs. Mersen's laminated bus bars offer other advantages for defense use, too. Their superior electrical characteristics help defense systems achieve maximum electrical performance and efficiency. Laminated bus bars are also known to provide the most compact means of packaging, achieving the highest overall system performance where physical space is a premium. And, because bus bars can be engineered to double as a structural support member, they contribute to system strength and rigidity at the same time. If that's not enough, Mersen's laminated bus bars simplify field service too, which makes it easier to keep mission critical equipment up and running.



## HIGH-CURRENT BOARD LEVEL

Dense packaging is a hallmark of laminated bus bars as shown in this 20-layer edge filled design with Kapton insulation to withstand high temperatures from soldering. Made for a special defense application, the design distributes power through wide tabs inserted and soldered into a backplane. Power inputs are located at one end for easy connection with a cable assembly.

Size: 1.2" x 10" | Conductors: .020" per layer | Voltage: 12VDC | Current: 50A per conductor



## AEROSPACE POWER DISTRIBUTION

This complex, nine layer, low inductance laminated bus bar is engineered to perform at very high altitudes in a confined area. It interconnects custom power modules through brazed bushings and clinch-type hardware. The high temperature Kapton insulation is entirely epoxy edge filled around each individual layer.

Size: 6" x 11" | Thickness: .025" per layer | Voltage: 300VDC | Current: 60A



## SURFACE MOUNT FOR DEFENSE POWER ELECTRONICS

Used in tandem, one as a high-temp, high-current board for switching components and the other is densely populated with chip capacitors. The use of Kapton insulation allows full solderability for surface mount components. Both bus bars are epoxy edge filled and designed to withstand extremely demanding conditions of temperature and altitude.

Length: approximately 4" (each) | Voltage: 200VDC | Current: 260A | Conductors: .025" and .050"

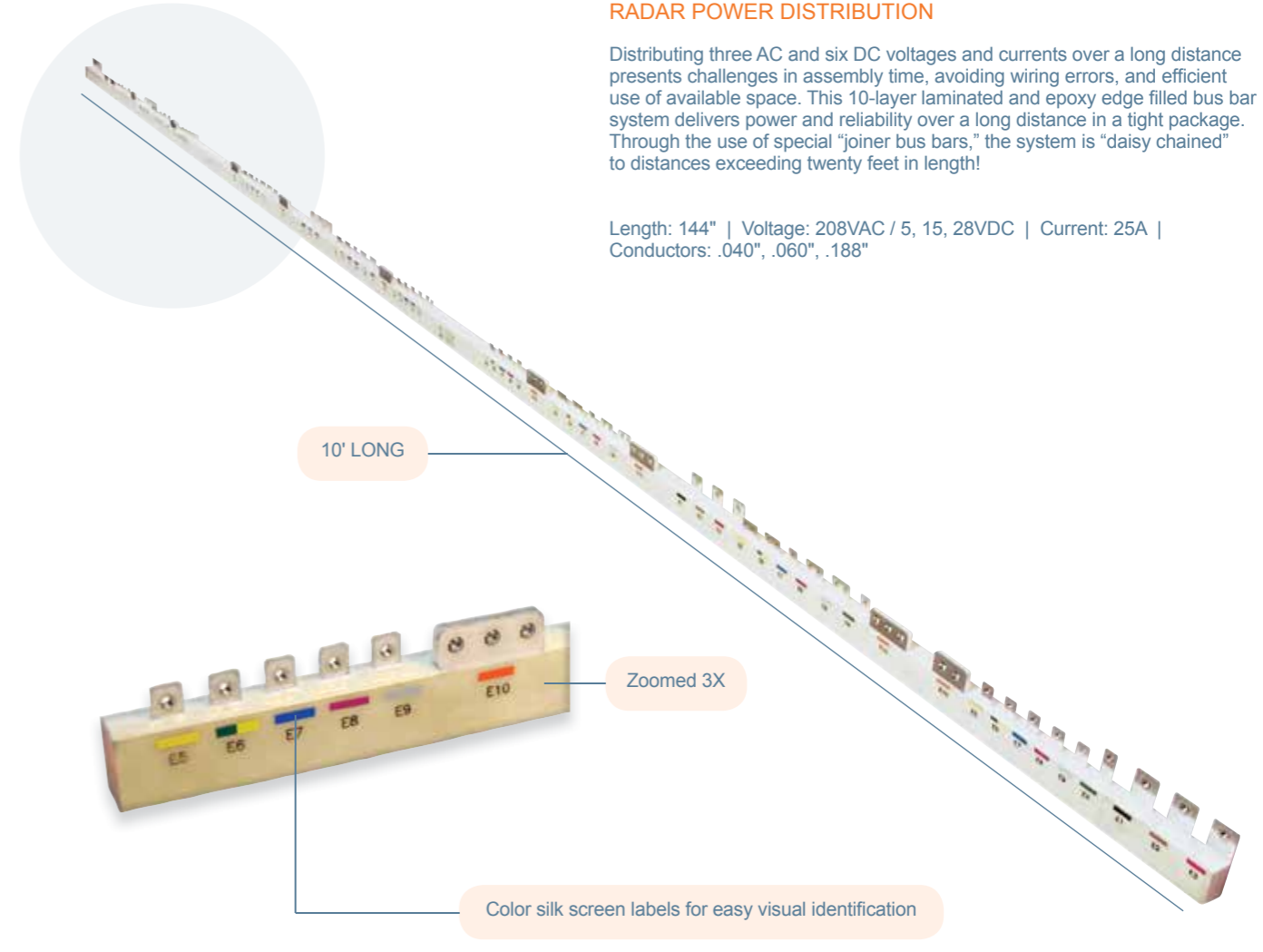

## RADAR POWER DISTRIBUTION

Distributing three AC and six DC voltages and currents over a long distance presents challenges in assembly time, avoiding wiring errors, and efficient use of available space. This 10-layer laminated and epoxy edge filled bus bar system delivers power and reliability over a long distance in a tight package. Through the use of special "joiner bus bars," the system is "daisy chained" to distances exceeding twenty feet in length!

Length: 144" | Voltage: 208VAC / 5, 15, 28VDC | Current: 25A | Conductors: .040", .060", .188"

10' LONG

Zoomed 3X

Color silk screen labels for easy visual identification

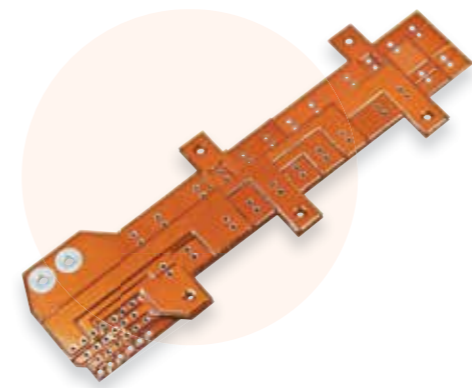

## LAMINATED POWER BACKPLANE

High-current power distribution is easily handled with this six layer, twenty-one conductor laminated bus bar. Designed to function as a "high-current backplane," a bank of special connectors are soldered directly to the bus bar, and used to distribute power within a turret control system.

Size: 3" x 11" | Conductors: .030" | Voltage: 12VDC | Current: 30A

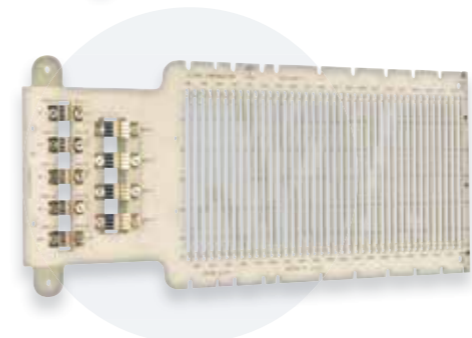

## MISSILE GUIDANCE SYSTEM

A complex and unique laminated bus bar design provides high-power distribution over a backplane with solder tabs for output connectors and gold plated input connections. This application for a laminated bus bar provides power within a Missile Guidance system. The pluggable input connections on this laminated bus bar are gold plated to provide low resistance and high reliability between the bus bar and its subsystem. Forty pairs of outputs from the bus bar to the backplane are made by solder connections. The bus bar is entirely encapsulated using epoxy edge fill provide a complete hermetic seal.

Size: 8" x 18" | Conductors: .040" | Voltage: 48V | Current: 190A

# INDUSTRIAL



The rough and rugged world of the industrial environment demands a constant and consistent supply of quality products delivered right to the production floor.

Mersen's industrial bus bar design solutions extend over half a century, delivering the ultimate in optimized, laminated bus bars to countless manufacturers of motor drives, fork lift trucks, welding machines, power generators, industrial testing machines, and much more! Mersen's laminated bus bar designs provide application specific characteristics, achieving a consistent level of performance that cannot be matched through wires, cables, or simple bars of copper!



## RACK MOUNT POWER DISTRIBUTION

Mounted inside a circuit breaker power tray, individual bus bars are nested in a machined FR-4 frame to provide output connections. This assembly assures proper safety separation as well as single component installation.

Size: 6" x 12" | Voltage: 48V | Current: 280A | Conductors: .125"



## MEDICAL IMAGING

This space-saving design incorporates five conductors in two layers with clinch hardware at each end. Its laminated, edge-sealed construction is formed to stay out of the way within a tightly packaged medical testing device.

Size: 8"L x 7"W x 6"H | Voltages: 3.3V, 5V, 12V | Current: 75A | Conductors: .040"

## MOTOR ARMATURE BUS BAR

This six-conductor circular bus bar is comprised of three 2-conductor laminated sub-assemblies bonded together. The unified structure provides a clean transition from power entry to motor windings. Glass mounting supports are bonded to the structure creating a rigid installation.

Size: 20" diameter | Conductor: .125" | Voltage: 48V | Current: 250A per layer

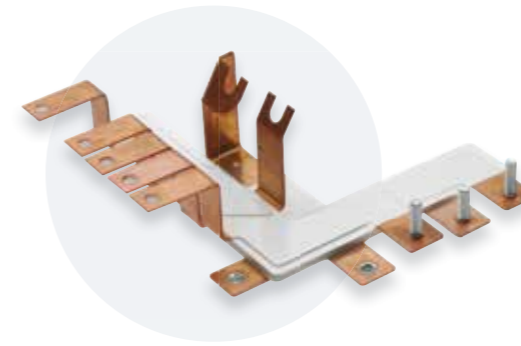

## FORK LIFT TRUCK BUS BAR

Six-conductor, laminated bus bar assembly combines DC and AC bus bars, as well as a fuse connection, all in one compact package! The system is designed to fit perfectly in a limited space and provides power to a variable speed motor in a rugged industrial environment.

Size: 7" x 7" | Current: 150A | Voltage: 42V | Conductors: .060"



## COMPACT IGBT BUS BAR

This unique laminated IGBT bus bar delivers low-inductance DC power within a confined area. The design also includes six separate bus bars arranged as AC output with in-line diode connections.

Size: 4" x 19" | Conductors: .050" | Voltage: 600VDC/150VAC | Current: 120A (DC) / 220A (AC)



## INDUSTRIAL INVERTER BUS BAR

Designed for low-inductance IGBT phase bus bar through 90 degree formed input connections, including raised top contact surfaces to accommodate snubber capacitors. High-temperature insulation material easily handles the demanding thermal requirements.

Size: 8" x 12" | Voltage: 475VDC | Current: 200A | Conductors: .080"



## FREQUENCY INVERTER BUS BAR

An excellent layout containing two large DC bus bars, along with the three AC output bus bars laminated directly on top making a complete laminated power distribution system all under a single part number! Note the inclusion of Faston tabs for current sensing and press-fit studs for balancing resistors.

Size: 13" x 18" | Current: 820A | Voltage: 550VDC | Conductors: .060" and .125"



## VARIABLE FREQUENCY DRIVE

This simple, yet complex design incorporates DC and AC bus bars, plus accommodations for three current sensors at the AC output points, all built into a flexible, geometric package designed to fit into a tight, confined operating area!

Size: 10" x 15" | Current: 100A | Voltage: 550VDC | Conductors: .040" and .060"



# COMPUTERS



## PCB TO PCB

Two bus bar examples for DC power connections between circuit boards. These assemblies use an edge sealed construction and employ a special insulating washer that allows compression of the two conductors onto the board while insulating the fastener from the live conductor.

Size: 0.5" x 2" | Thickness: .030" x .060" | Voltage: 48V | Current: 35A



## INFORMATION STORAGE SYSTEMS

These bus bars are stamped, brazed, machined, and colored-coded epoxy powder coating dielectric insulation for differing voltages. Power interconnects directly from the power supply with included hardware so you get everything in one rugged package.

Size: 1.2" x 19" | Voltage: 48VDC | Current: 300A



## SUPERCOMPUTER BUS BAR

Modern supercomputer systems operate at extremely low voltages and require a high concentration of current. This two-conductor bus bar assembly is constructed from machined, stamped, and soldered components that are insulated with a high-quality epoxy powder coating, then laminated together to provide a low inductance power path distributed across a large circuit board or backplane.

Size: 2" x 19" | Voltage: 3VDC | Current: 450A

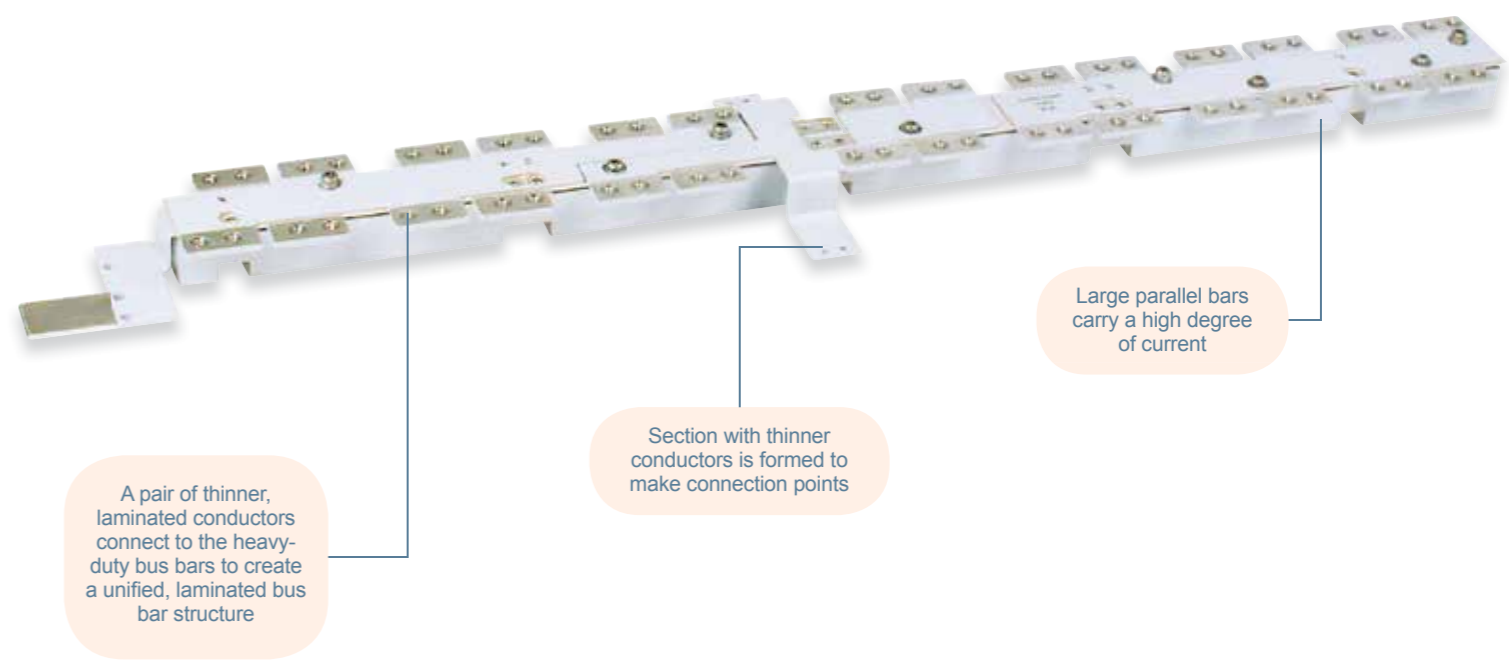

A pair of thinner, laminated conductors connect to the heavy-duty bus bars to create a unified, laminated bus bar structure

Section with thinner conductors is formed to make connection points

Large parallel bars carry a high degree of current

As data volume and broadband use continue to expand, performance demands increase for high-speed servers, blade servers, network backbone equipment, engineering work stations, and such data storage systems as disk arrays.

Mersen laminated bus bars help these computer equipment designers meet that challenge, offering uncompromising electrical performance while minimizing EMI, RFI, and crosstalk. The low profile of a laminated bus bar provides computer equipment manufacturers with the ultimate package efficiency, ease of service, and consistent quality necessary to satisfy the most demanding customers.

A properly engineered power distribution plan utilizing laminated bus bars can also include thermal management, with the bus bar acting as a heatsink. The bus bar's form-fitting designs can help increase the air flow within a system where space is at a premium.

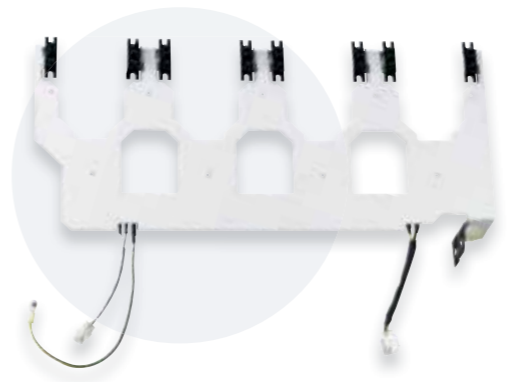

## POWER BACKPLANE

Distributing power to eight blades in a large server is easily accomplished with this two-conductor laminated bus bar complete with blind mate power connectors. Short cable assemblies are built into the bus bar for system monitoring. Formed tabs at bottom accommodate in-line fuse connections.

Size: 16" x 28" | Voltage: 48VDC | Current: 240A | Conductors: .060"

# COMPUTERS

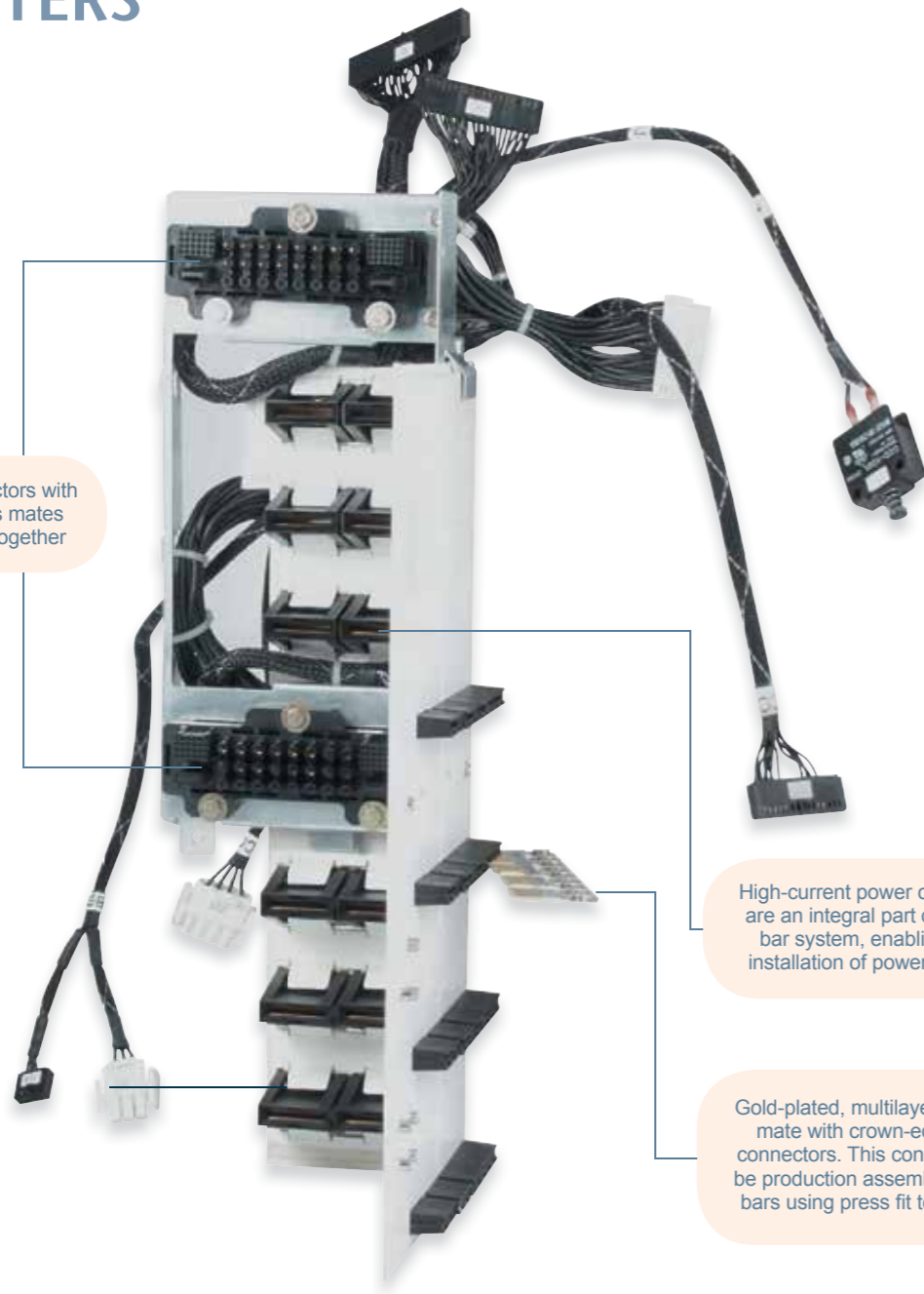

Drawer-type connectors with integrated harness mates power and signal together

High-current power connectors are an integral part of the bus bar system, enabling easy installation of power supplies

Gold-plated, multilayer bus bars mate with crown-edge type connectors. This connector can be production assembled to bus bars using press fit technology

## HIGH-END SERVER

An excellent combination of value! This multilayer, laminated bus bar incorporates several different connectors for both power and signal, and through careful engineering, a wire harness is used for signal distribution. Mersen can engineer fully tested and serialized solutions to solve your power distribution challenge!

Size: 5" x 9" x 17" | Voltage: 48V | Current: 400A

Press fit power connectors installed directly into bus bar conductors

Note three conductors tightly laminated through form

High-current connectors fastened to bus bar

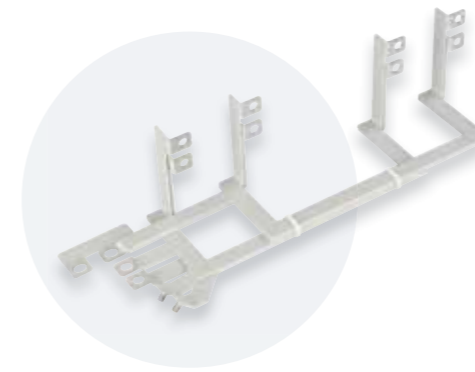

## COMPUTER BACKPLANE POWER DISTRIBUTION

Epoxy powder coating allows multiple conductors, formed to differing geometries, to be assembled into a single unit. Insulated and bonded together, this assembly carries power to the backplane without adding costly and complex layers to the backplane.

Length: 14" | Thickness: .060" | Voltage: 3VDC and 5VDC | Current: 100A

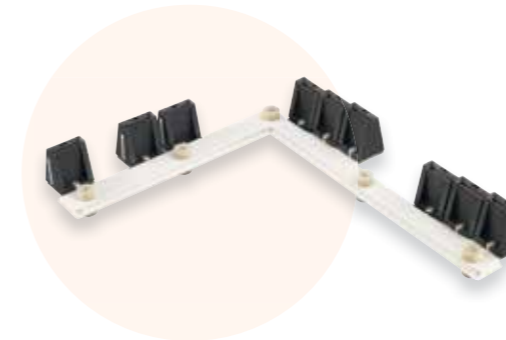

## COMPUTER BACKPLANE

Redundant power supplies plug into this laminated bus bar design and feed high-current power into the computer backplane. Note the five glass (FR-4) mounting supports, which are bonded to the structure, to create a rigid, insulated mounting system. Nine "Crown Clip" high-current connectors distribute power from the power supply onto the backplane.

Size: 12" x 9" | Thickness: .125" per layer | Voltage: 48V | Current: 250A per layer

## POWER DISTRIBUTION FOR OPTICAL SYSTEMS

Power distribution bus bar used in Optical Network System. This efficient and compact bus bar is designed to provide 48V power onto a backplane from its power supply, through circuit protection, common and differential mode inductors, film capacitors, and resistors, all without the need for a separate PCB for the soldered connections of the resistors and capacitors!

Size: 5" X 18" | Voltage: 48VDC | Current: 75A | Conductors: .050"

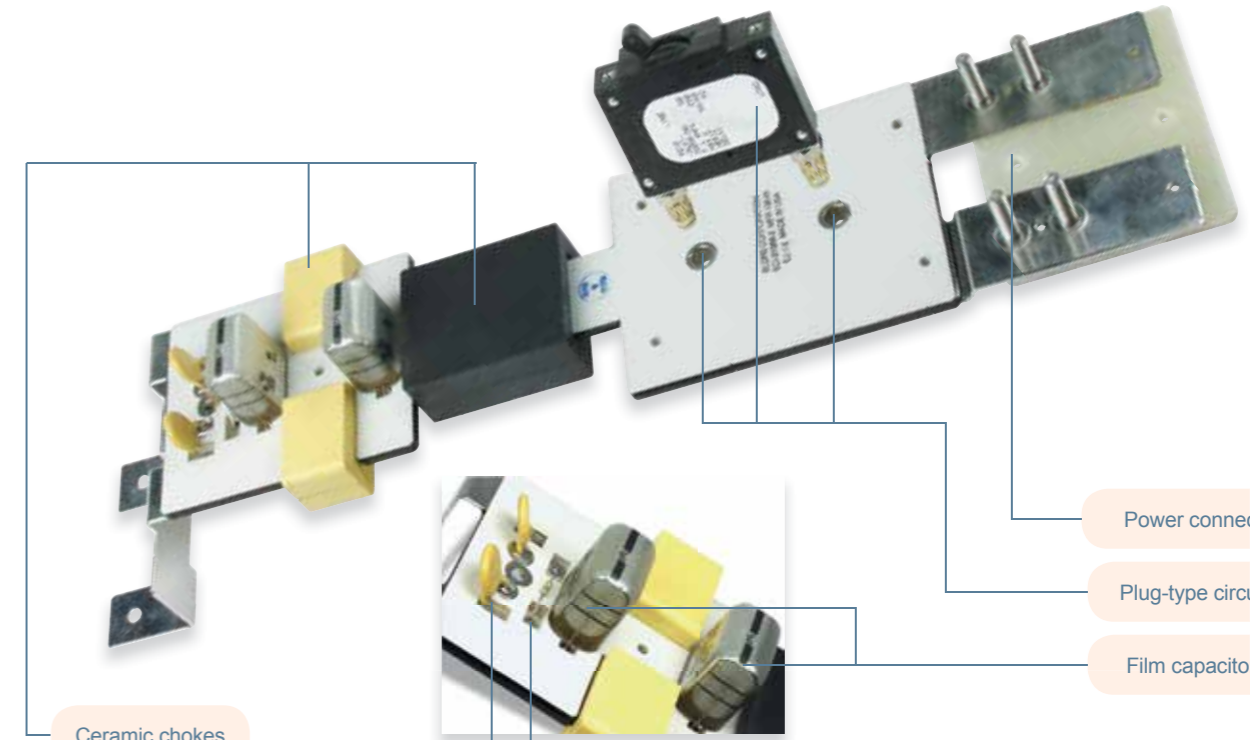

Ceramic chokes

Resistor and MOV network

Power connector points

Plug-type circuit breaker

Film capacitors

# TELECOM

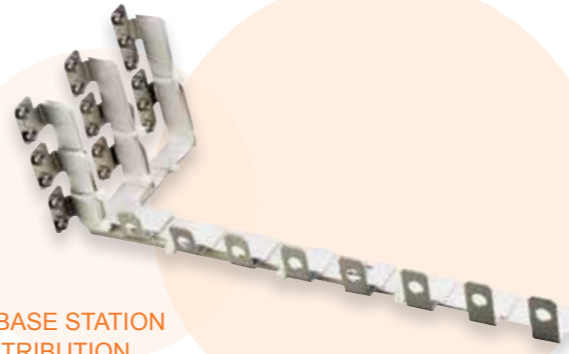

## CELLULAR BASE STATION POWER DISTRIBUTION

An economical design that carries power from multiple power supplies onto the backplane within a Base Station Cabinet. Individually laminated and assembled together reducing a complex wiring scheme to a simple component, saving both space and assembly time.

Size: 7" x 7" x 19" | Voltage: 48VDC | Conductor thickness: .060" | Current: 125A



## INTERNET BUS BAR SYSTEM

U-shaped, with angled power input tabs, feeding around a rack-mounted frame. The unit also has plated, soldered bushings for bullet-style circuit breakers.

Size: 5" x 9" x 17" | Voltage: 48V | Current: 400A | Conductors: .060"



## REDUNDANT POWER INPUT

When system requirements call for redundant power supplies, laminated bus bars are ideal! This two-layer design utilizes press-fit sockets for power supply input and mates downstream with a custom power distribution network.

Size: 3.5" x 8" | Voltage: 48VDC | Current: 50A | Conductors: .125"



## ROUTER BACKPLANE DISTRIBUTION

Two-conductor laminated bus bars designed to distribute DC power from dual power supplies across the backplane of an internet router. The insulation system uses a molded-edge seal around the perimeter as a cost-effective means of providing the proper creepage distance between the two conductors while protecting the individual conductors from dust and contaminants. Due to the low voltage of the system, Mersen engineers assure that the design has sufficient cross sectional area for a minimal voltage drop.

Size: 12" x 18" | Voltage: 48VDC | Current: 250A | Conductors: .090"



## BACKPLANE POWER DISTRIBUTION

Sixteen-layer laminated bus bar distributes +48V and return across a back plane in a rack system for a network routing application. Heavy-gauge clinch hardware and anti-rotation tabs accommodate cable connections. The entire assembly is hermetically sealed using epoxy edge fill.

Size: 1" x 18" | Conductors: .032" | Current: 75A per layer | Voltage: 48VDC

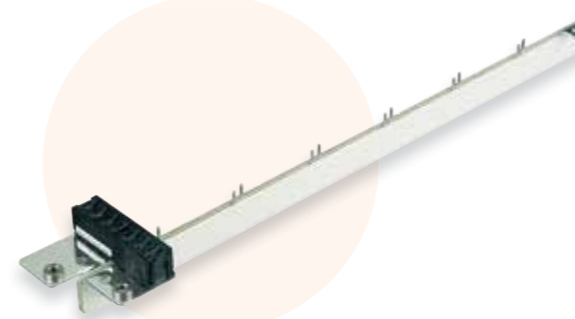

## TELECOMMUNICATIONS BOARD LEVEL POWER DISTRIBUTION

When board space is at a premium, laminated bus bars provide the perfect space-saving solution. The bus bar is designed to be soldered into a PCB and includes an integrated connector, which allows for interchangeability of either the power supply or PCB.

Size: 0.6" x 10" | Conductors: .050" | Current: 80A | Voltage: 60VDC

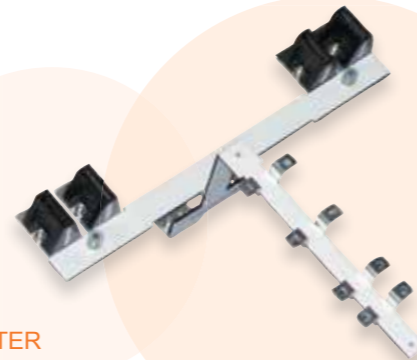

## INTERNET ROUTER

This two-conductor bus bar distributes DC power within an internet router. The laminated structure utilizes tabs with offset forms and clinch hardware to mount directly onto the midplane, while allowing for proper airflow. High-current pluggable connectors are mounted directly to the bus bar for interchangeable power supplies.

Length: 18" | Width: 12" | Voltage: +5V, -5V | Current: 110A

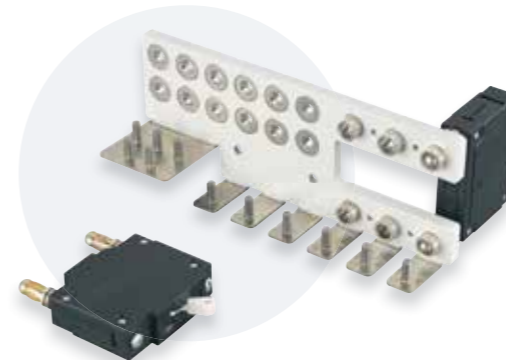

## CIRCUIT BREAKER BUS BAR

This seven conductor, nickel-plated assembly receives filtered input power, routed through pluggable breakers and directed to output terminals within a rack-mounted system. Such compact routing offers improved packaging and improved air flow—both key benefits of laminated bus bars.

Size: 3" x 6" | Voltage: 48VDC | Current: 75A | Conductors: .060"

In the intensely competitive telecommunications market, manufacturers of equipment for Cellular Base Stations and Internet Routers must offer their customers exceptional performance and dependability. With their consistent quality, excellent electrical characteristics, minimal EMI, RFI, and crosstalk, Mersen laminated bus bars provide the perfect solution!

Mersen laminated bus bars offer telecommunications equipment manufacturers many other advantages too — including ease of assembly, superior thermal management, reduced weight, packaging efficiency, and overall cost-effectiveness over alternative means of power distribution.

## TELECOM POWER DISTRIBUTION

Part of a rack-mounted circuit breaker network, this three-conductor, single-layer laminated bus bar assembly is used to provide power connections to a group of circuit breakers. Power connections are made at each end and three banks of Faston tabs provide A, B, and Ground connections for twenty circuit breakers.

Size: 10" x 3" x 3" | Voltage: 48VDC | Current: 480A | Conductors: .125"

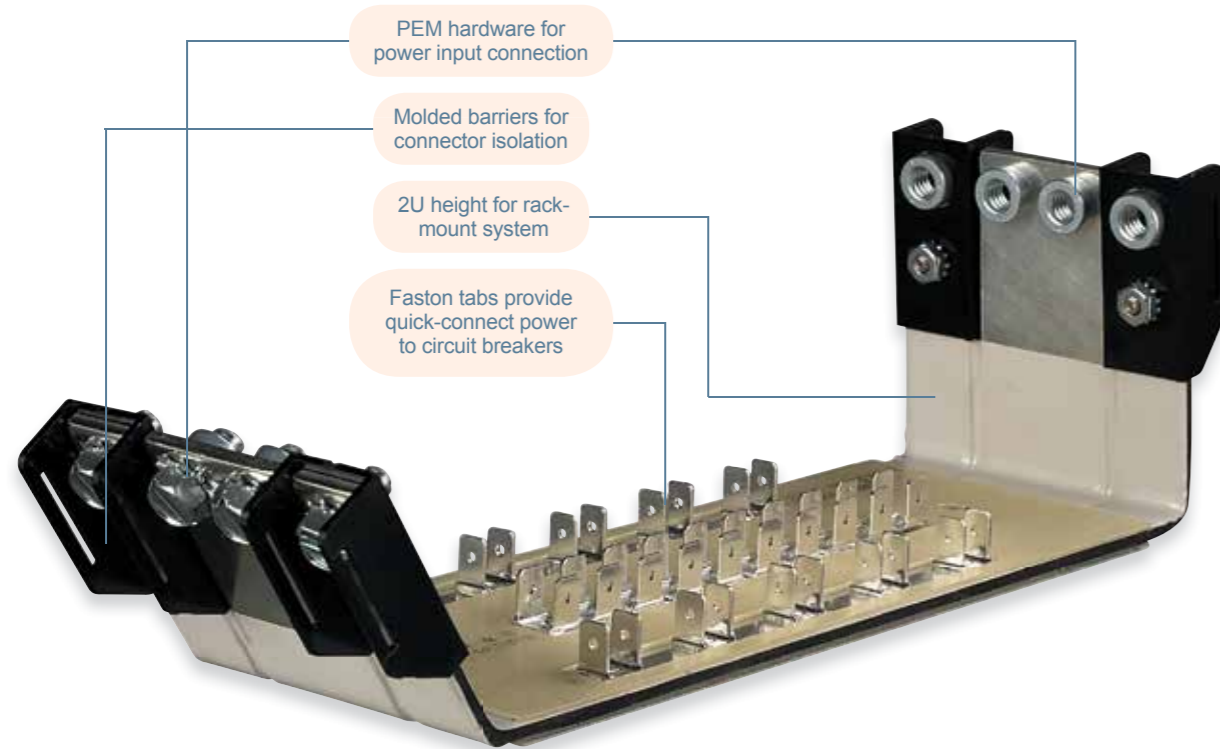

## FILTERED POWER INPUT BUS BAR

A two-conductor bus bar routing filters DC power through ring lugs and clinch hardware, terminating in multiple power connectors mounted in a 1U rack-mounted power drawer.

Size: 1.5" x 9" | Voltage: 48VDC | Current: 200A | Conductors: .050"



## BACKPLANE POWER DISTRIBUTION

Three-phase shielded power is fed from a single power supply, extending horizontally along a backplane. Eleven sets of gold-plated pins, engineered to pass directly through the backplane, ensure high reliability and low contact resistance connections to individual boards.

Size: 7" x 18" | Voltage: 12V | Current: 48A | Conductors: .040"

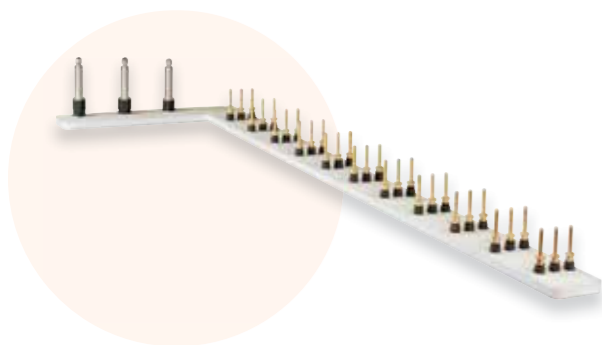

## INTERNET ROUTER BACKPLANE BUS BAR

Three power supplies feed this DC bus bar assembly through a repeating series of blade-style pluggable output "tabs" along its length. The long, narrow design makes short jump connections clean and easy for board mounted pluggable connectors. The manufacturer benefits from the efficient, low-profile design, and clean distributed capacitance that are the natural results of laminated bus bars.

Size: 5" x 12" x 18" | Thickness: .050" and .125" | Voltage: +5V, -5V | Current: 130A



## TELECOM POWER DISTRIBUTION

Redundant Power Supplies plug directly into this four-layer, six-conductor laminated bus bar through high-current power connectors and feed three separate voltages into this base station application. System outputs are fed through special silver-plated pins, installed as an integral part of the bus bar.

Size: 6" x 14" | Voltage: 48VDC | Current: 220A | Conductors: .125"

Heavy-duty power clips installed for mating with power supplies

Power pins are press-fit and soldered

Four-layer, edge-filled bus bar

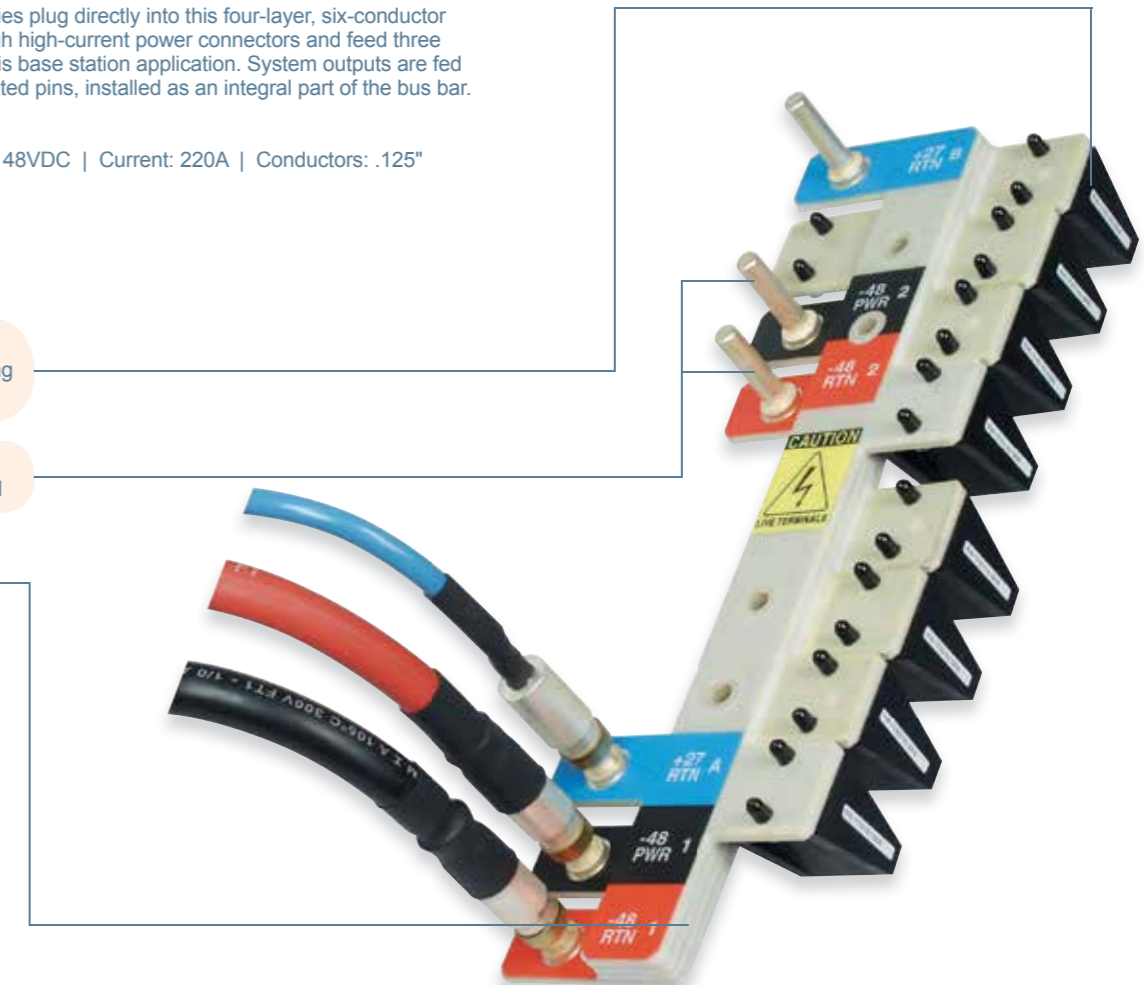

# VALUE ADDED

## PDA UNIT BEFORE BUS BAR

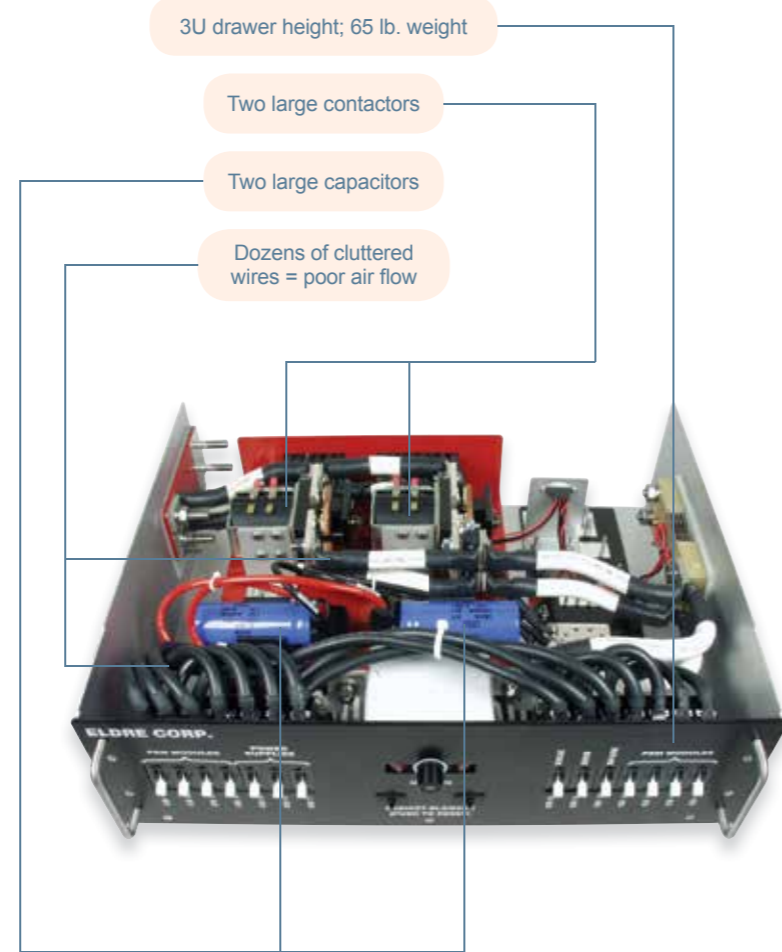

Multilayer bus bars offer a structural integrity that wiring methods just can't match. Mersen's Value Added bus bar designs incorporate a variety of components built right in. Each one is safety tested and certified, all designed to help simplify your life at the system assembly level.

Every day Mersen's innovation delivers complete multi-component bus bar and power distribution assemblies around the world to our dedicated family of customers.

## PDA UNIT WITH BUS BAR

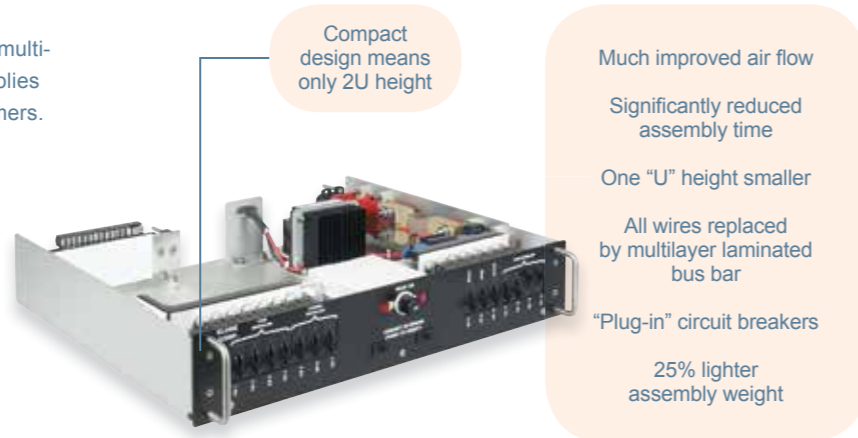

## PDA ASSEMBLY RE-ENGINEERED USING BUS BAR TECHNOLOGY



## PDA BUS BAR

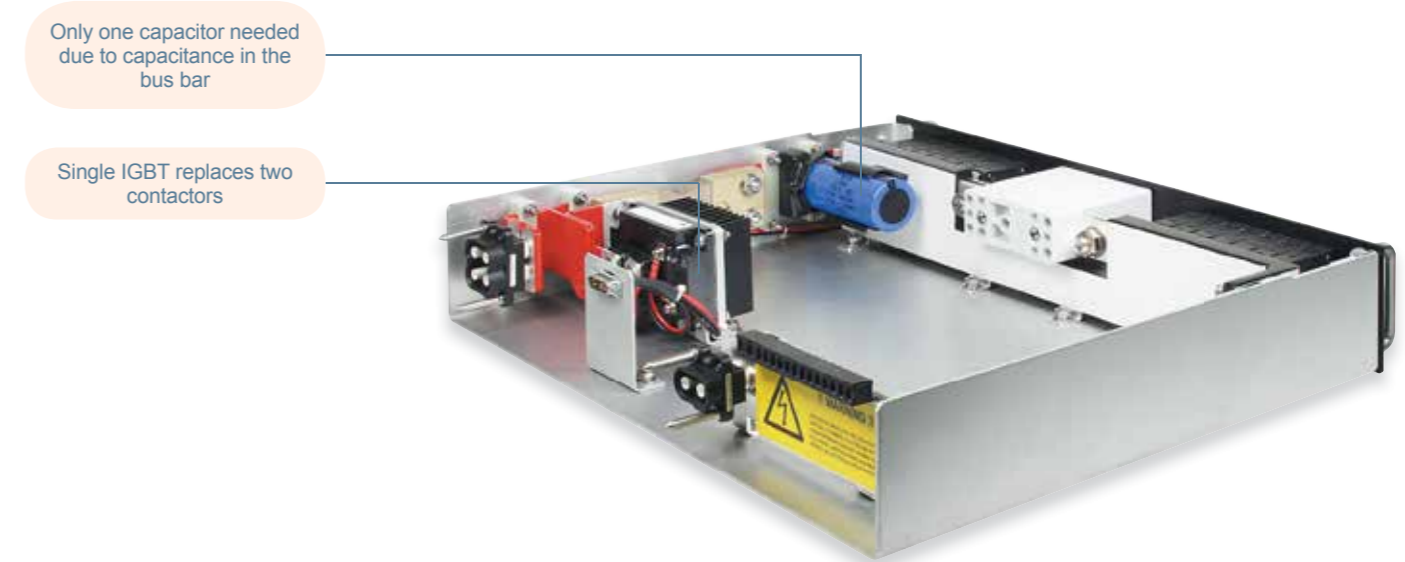

## REAR VIEW

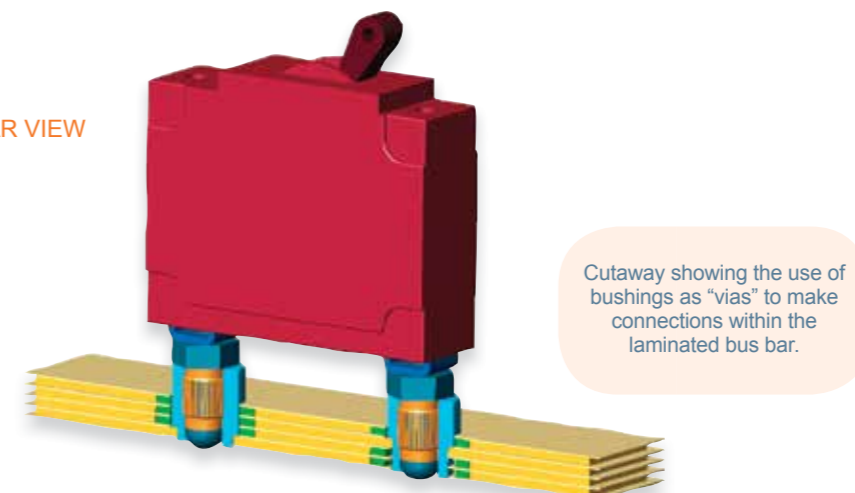

# VALUE ADDED

PDA ASSEMBLY A HIT IN STAGE LIGHTING SYSTEMS!

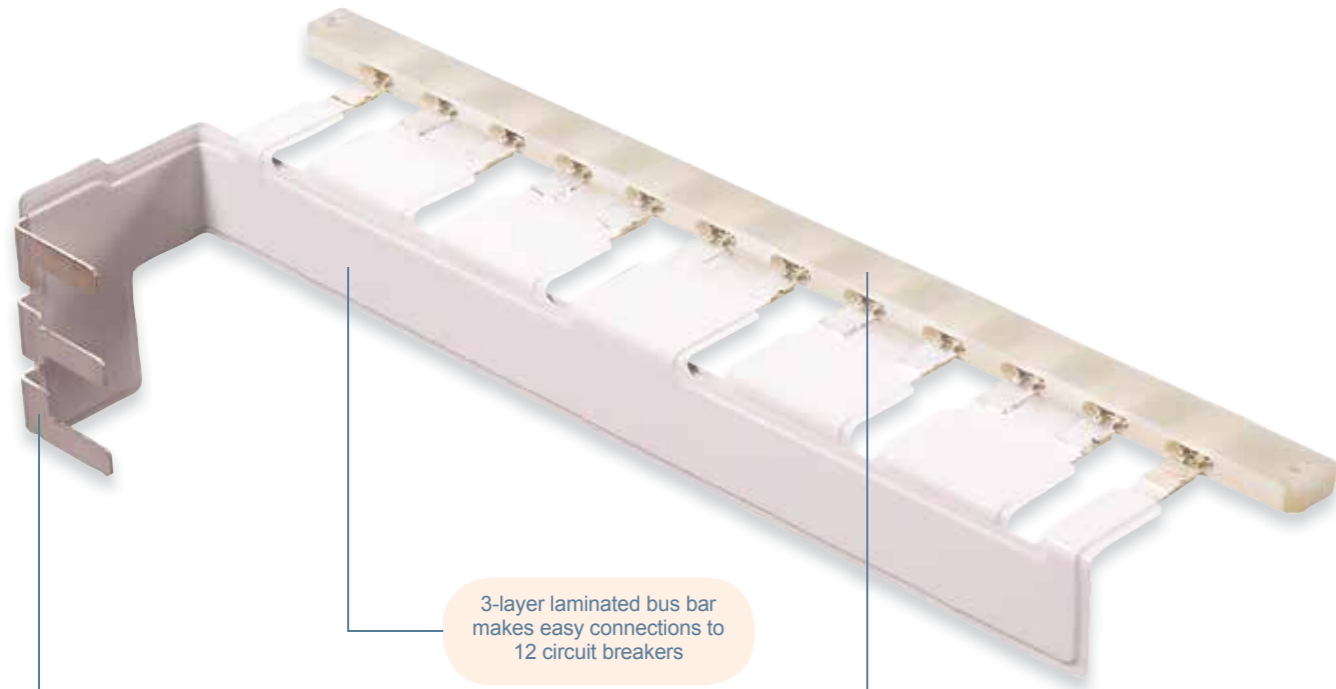

3-layer laminated bus bar makes easy connections to 12 circuit breakers

Easy connection with contactors

Faston connections inside protective FR-4 glass



The design concept for this project was to create a rugged, lightweight power distribution system for a production lighting application. Due to the predictable performance characteristics of the solid copper conductors used in laminated bus bars (instead of the bulk and uncertainty of wires), the creativity of the design team was tapped. Total success was achieved through compact packaging, light weight, and simplified assembly

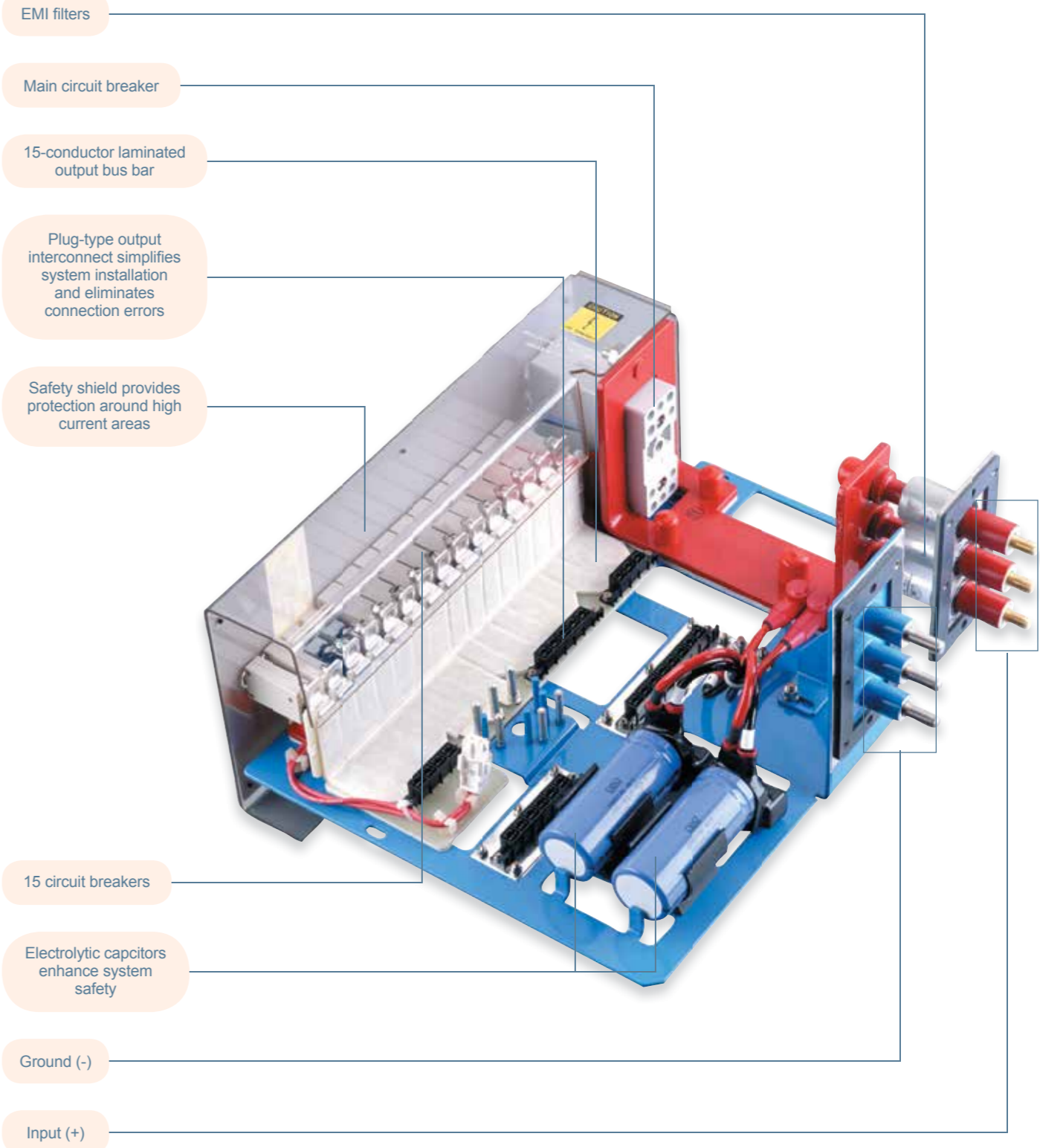

## PLATFORM FOR CIRCUIT BREAKER CONFIGURATIONS

Created as a total power distribution scheme, Mersen engineers worked with the client to create a bus bar structure that accepts input power and ground, divides the power through 15 circuit breakers, and routes the various currents to modular output connections. Mersen laminated bus bars can be engineered to be made with an infinite number of connectors, fuses, capacitors, resistor networks, filters, surge protectors, and circuit breakers. Our complete value-added assemblies are supplied fully tested and ready for installation. Manufacturing benefits by reduced assembly and test time, purchasing benefits by keeping track of fewer items (reducing inventory).

Length: 8" | Width: 7.5" | Voltage: 28V | Current: 700A

# VALUE ADDED

## POWER & SIGNAL DISTRIBUTION

A series of small power supplies parallel to provide system power in a 19" rack application. Input connectors are press-fit into both the bus bar and PCBs for system simplicity. Attached to this bus bar's right side is its mate, a 60" long vertical bus bar with pluggable output connectors for system distribution. Along the top section, signal output reports system intelligence to monitor each power supply's performance.

Size: 4" x 10" x 16" | Voltage: 24VDC | Current: 300A | Conductors: .050"



## RACK MOUNT PDA - POWER & SIGNAL

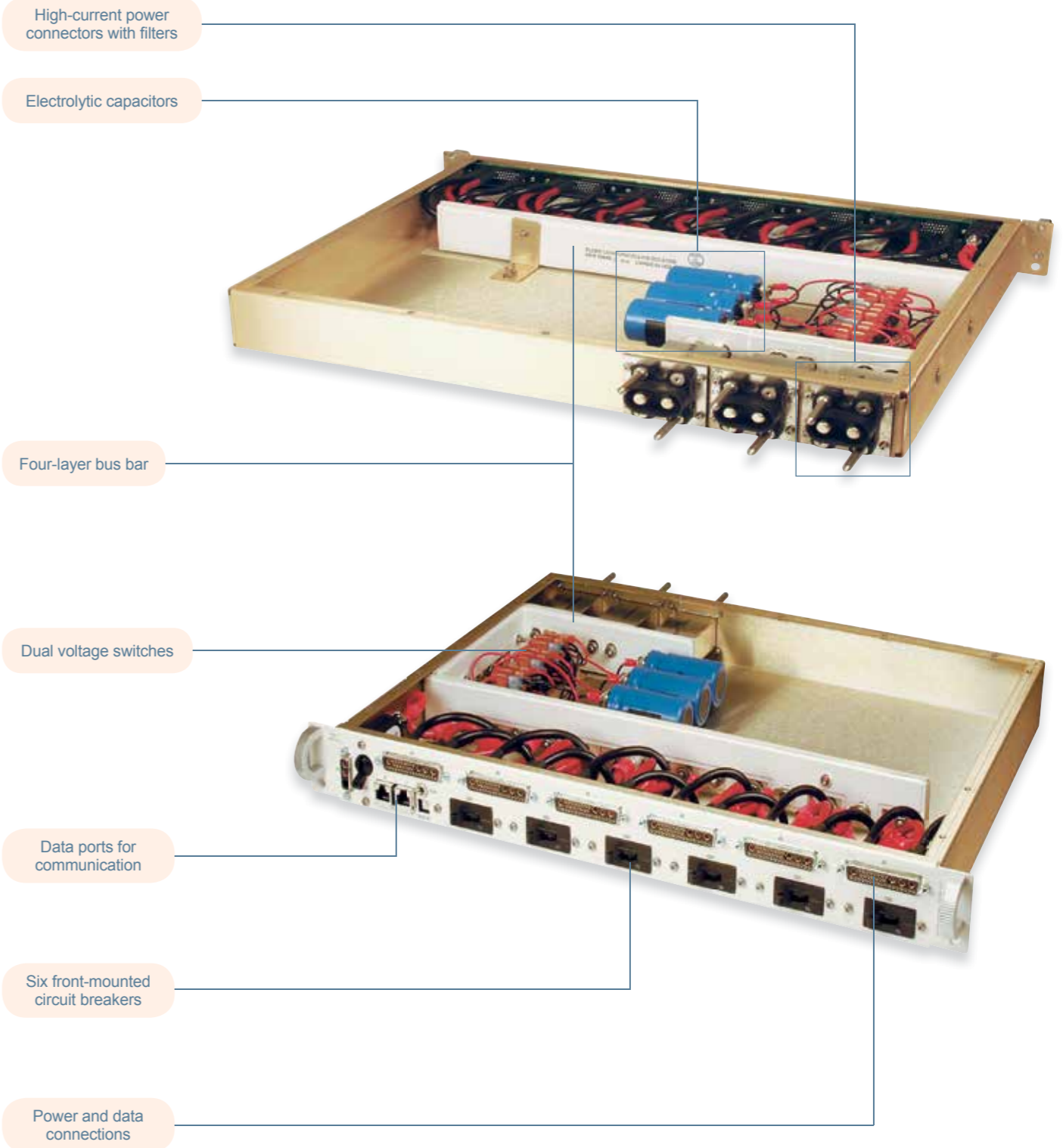
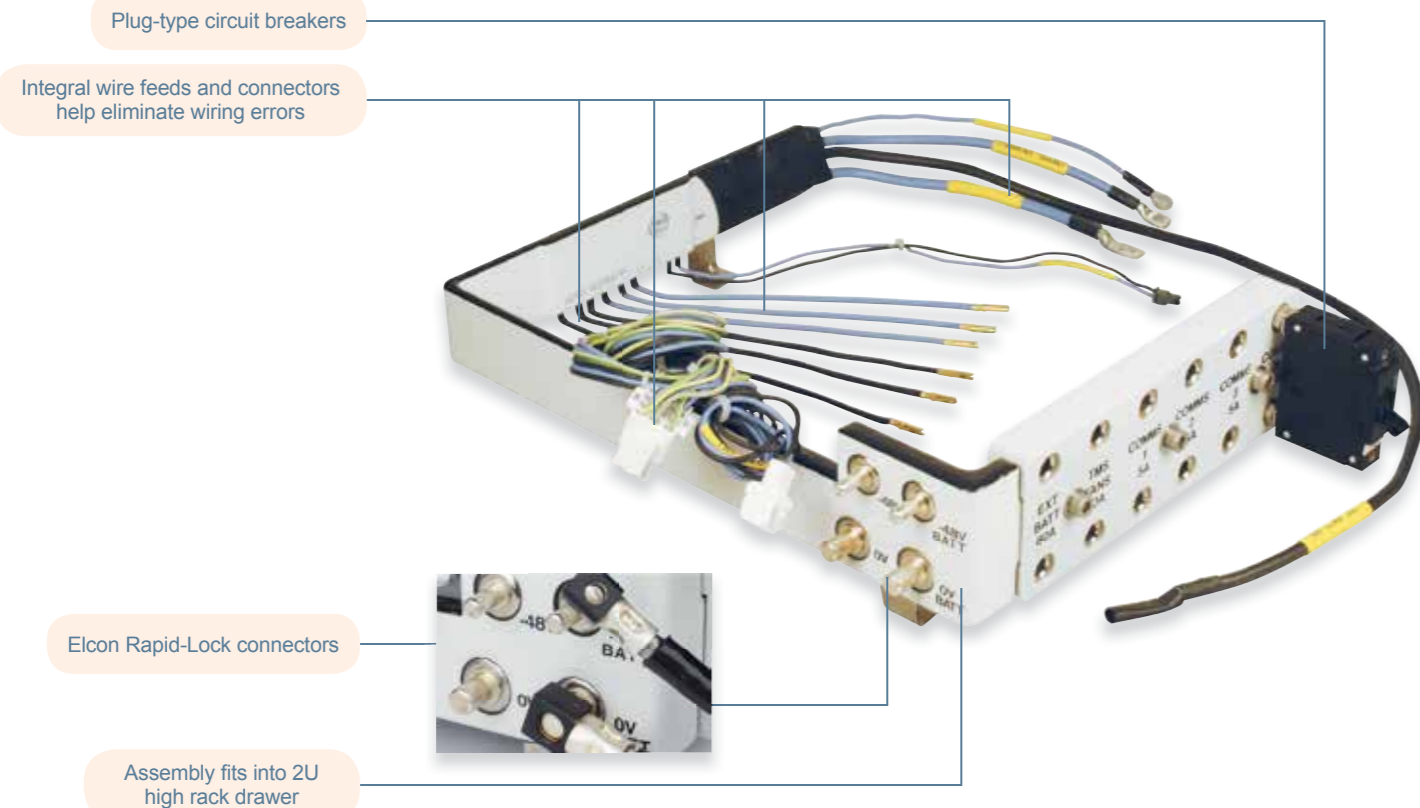

## RACK MOUNTED POWER DISTRIBUTION ASSEMBLY

Mersen engineers work closely with customers to design complete rack mounted power distribution assemblies. This PDA contains a J-shaped, four-layer laminated bus bar, three input filters, six circuit breakers, sense monitoring, and dual voltage switches. Tested, serialized, and completely labeled, each PDA is ready for system installation by the customer.

Size: 19" x 2U | Voltage: 125V/250V (switchable) | Current: 450A

# LAMINATED BUS BAR DESIGN GUIDE



## CONDUCTORS

Conductor material selection is critical in meeting electrical performance and mechanical rigidity requirements. Common materials used are copper, aluminum, and a variety of copper alloys. The material chosen, the mechanical constraints, and the electrical performance for the specific application determine the conductor's minimum mechanical dimensions (see Conductor Size in the Electrical Design section).

Thermal considerations may require system ventilation to remove excess heat from the bus bar. In this case, bus bar configuration might be low in profile, thereby changing the orientation of the bus structure and the airflow. Bus bars may also serve to remove heat from components by performing as a heat sink.

The selection of tabs or terminations may determine conductor thickness if there's a need to accept studs, nuts, tabs or threaded inserts. Minimum mechanical requirements for the connection style chosen must be considered for overall efficiency and cost effectiveness.

## GROUNDS

The ground return conductor should be equal in size and circular mil area to its corresponding voltage conductor. A few advantages of a separate ground return are:

1. double the effective capacitance;
2. greater area for cooling, to minimize the voltage drop due to temperature rise;
3. drastically reduced intercoupling effects; and
4. the opportunity for advantageous shielding between levels, obtained by the use of interleaved grounds.

## MOUNTING

To mount a bus bar to an assembly structure, hardware (studs, holes, etc.) can be manufactured into the conductors. An alternative ground plane may be added as support for the bus bar assembly and to provide a platform for mounting hardware.

The physical structure of bus bars offers unique features in mechanical design. For example, complete power distribution subsystems can also act as structural members of a total system. The proper design of bus bars depends on an application's mechanical and electrical requirements. This section includes basic formulas and data to aid design engineers in specifying bus bars for power distribution systems. Once an outline of a bus bar has been established, specific design and manufacturing considerations will affect the cost (See Cost Considerations).

We've provided basic design criteria to help you specify bus bars for your application. The information required to specify a bus bar includes conductor material, number of conductors (including ground), dimensions (length, width, and thickness), interconnection schemes, mounting configuration (if required), type of finish, and choice of insulation material.

## FINISH

Mersen offers in-house conductor plating in tin, tin/lead, nickel, silver, or gold. Plating is a major consideration in designing a bus bar because it is the point of contact for all bus bar electrical connections. The plating can provide advantageous electrical properties, decreasing the voltage drop. When gold is used, it is generally only plated on termination surfaces to minimize cost.

## INSULATION

Bus bars use many different types of adhesive-coated insulation materials to permit structure layers to be laminated together. There are added benefits from an electrical perspective. Insulation provides an inside and outside barrier to its installed environment. Insulations can increase the capacitance and lower the inductance and impedance. Commonly used insulation materials are Nomex®, Tedlar®, Mylar®, Kapton®, Ultem®, Mylar/Tedlar, Tedlar/Mylar/Tedlar, Valox®, epoxy-glass, heat shrink tubing, and epoxy powder coating. There are many different thicknesses of these insulation materials available. Contact a Mersen engineer for more information. Special insulations are available upon request.

## COST CONSIDERATIONS

Prices of bus bar assemblies vary depending upon quantity ordered. In addition, individual dimensional characteristics, materials, manufacturing techniques, the interconnection scheme, plating finish, insulation, and hardware requirements affect overall cost.

Mersen engineers are available to assist in developing the most efficient and cost-effective design to provide solutions to any power distribution problem. The earlier we are involved in your design process, the more cost effective your solution is likely to be. Early involvement enables us to optimize both ease of manufacturing and turnaround time. We recommend that you contact a new-product development engineer before you start designing your laminated bus bar power distribution system.

## ELECTRICAL DESIGN

Important characteristics of laminated bus bars are resistance, series inductance, and capacitance. As performance parameters of electronic equipment and components become more stringent, these characteristics take on even more importance. In determining the impedance of a power distribution system, these characteristics are significant in solving two of the most important problems for designers—resistance and noise. It is important, therefore, to understand the electrical characteristics of the laminated bus bar.

Figure 1 shows a basic two-conductor laminated bus bar and Figure 2 shows its equivalent circuit. The bus bar is composed of two parallel conducting plates separated by a dielectric.

The equivalent circuit illustrates the associated inductance (L), capacitance (C), and resistance (R), which are most often uniformly distributed along the bus bar. We discuss the basic relationships between physical dimensions and electrical parameters in the following analysis.



Figure 1.  
Physical Representation.



Figure 2.  
Electrical Equivalent

## CONDUCTOR SIZE

Calculating conductor size is very important to the electrical and mechanical properties of a bus bar. Electrical current-carrying requirements determine the minimum width and thickness of the conductors. Mechanical considerations include rigidity, mounting holes, connections, and other subsystem elements. The width of the conductor should be at least three times the thickness of the conductor.

Additions of tabs and mounting holes change the cross-sectional area of the conductor, creating potential hot spots on the bus bar. The maximum current for each tab or termination must be considered to avoid hot spots.

Cross-sectional area and the length determine bus bar conductor size. Cross-sectional area (A) is equal to conductor thickness (t) multiplied by conductor width (w).

$$A = (t)(w) \text{ inches}^2$$

A value of approximately 400 circular mils per ampere is a traditional basis for design of single conductors. Since bus bars are not round, circular mils must be converted to mils squared (simply multiply the circular mils value by 0.785).

The following formula determines the minimum cross-sectional area of a conductor. This area should be increased by five percent for each additional conductor laminated into the bus structure. This extra five percent is a safety factor compensating for the compounding heat gain within the conductors.

This equation calculates the minimum cross-sectional area necessary for current flow:

$$A = 400(I)(0.785)[1+.05(N-1)](1*10^{-6}) \text{ inches}^2$$

A = cross-sectional area of the conductor in inches<sup>2</sup>

I = Max DC current in amperes

N = Number of conductors in the bus assembly

To calculate the cross-sectional area of an AC current source, you must take frequency into consideration (see the section on Skin Effect).



Note: This formula has a breakdown point at approximately 400 amps of current. For calculations involving larger currents, we suggest you contact a Mersen engineer. In addition, you can find ampacity charts and comparative graphs at the Copper Development Association's website, [www.copper.org](http://www.copper.org).

## CAPACITANCE

Capacitance of the bus arrangement depends upon the dielectric material and physical dimensions of the system. Capacitance varies only slightly with frequency change, depending on the stability of the dielectric constant. This variation is negligible and therefore is omitted in this analysis:

$$C = \frac{0.225(K)(w)(\ell)}{(d)} \text{ picofarads}$$

Increased capacitance results in a decreasing characteristic impedance. Low impedance means greater effective signal suppression and noise elimination. It is therefore desirable to develop maximum capacitance between conductor levels. This may be achieved by:

1. keeping the dielectric as thin as possible, consistent with good manufacturing and design practices
2. using dielectrics having a high relative permittivity (k factor)

## SKIN EFFECT

Because of skin effect phenomena, inductance and resistance are dependent on frequency. At high frequency, currents tend to flow only on the surface of the conductor. Therefore the depth of penetration of the electromagnetic energy determines the effective conducting volume.

The skin depth is given by:

$$SD = \frac{1}{\sqrt{\pi(f)(M)(1/\rho)}} \text{ inches}$$

For Copper:

$$SD = \frac{2.6}{\sqrt{f}} \text{ inches}$$

As frequency increases, inductance decreases to a limiting value, whereas the resistance increases indefinitely as the frequency approaches infinity.

## INDUCTANCE

Maintaining a low inductance results in a low characteristic impedance and greater noise attenuation. When minimum inductance is a design objective, consider these tips:

1. Minimize the dielectric thickness.
2. Maximize the conductor width.
3. Increase the frequency.

There are two types of inductance to be determined: internal inductance, which is a result of flux linkages within a conductor and external inductance, which is determined by the orientation of the two current-carrying conductors.

Distribution of current throughout a conductor at high frequencies is concentrated near the surfaces (called the "skin effect"). The internal flux is reduced and it is usually sufficient to consider only the external inductance. At low frequencies, however, the internal inductance may become an appreciable part of the total inductance. The formula for calculating the internal inductance at a low frequency is extremely lengthy and thus omitted in this analysis.

The formula for external inductance is:

$$L = \frac{31.9(d)(\ell)}{(w)} \text{ nanohenrys}$$

High-Frequency Inductance ( $t > SD$ )

$$L_t = \frac{31.9(d+SD)(\ell)}{(w)} \text{ nanohenrys}$$

## RESISTANCE

To calculate the DC conductor resistance, the following formula applies (Resistance at 20°C):

$$R_{DC} = \frac{\rho(\ell)}{(w)(t)} \text{ ohms}$$

$$R_{DC} = \frac{0.68 \times (10^{-6})(\ell)}{(w)(t)} \text{ ohms}$$

To determine DC conductor resistance at temperatures above 20°C, use this formula:

$\alpha$  = Temp. coefficient of resistivity of copper at 20°C is 0.00393

$$R_2 = R(1 + 0.00393(T_2 - T_1)) \text{ ohms}$$

$$R_2 = \text{Resistance at elevated temp}$$

$R_2$  = Resistance at elevated temperature ( $T_2$ )

$R$  = Resistance at 20°C ( $T_1$ )

For high frequencies the skin depth is taken into consideration. The formula for AC resistance is:

For ( $t > 2SD$ )

$$R_{AC} = \frac{2(\ell)\rho}{(SD)(w)} \text{ ohms}$$

AC resistance at 20°C

$$R_{AC} = \frac{2(\ell)0.68 \times 10^{-6}}{(SD)(w)} \text{ ohms}$$

## VOLTAGE DROP

As current travels across a conductor, it loses voltage. This is caused by the resistivity of the conductor. The losses are referred to as voltage drop. Use this formula to calculate the voltage drop across the conductors:

$$V_D = 2(R)(I)$$

$$R = \frac{\rho(\ell)}{(w)(t)} \text{ ohms}$$

$$VD = \frac{2(\rho)(I)(\ell)}{(w)(t)} \text{ Volts}$$

## IMPEDANCE

In the design of laminated bus bars, you should consider maintaining the impedance at the lowest possible level. This will reduce the transmission of all forms of EMI (electromagnetic interference) to the load.

Increasing capacitance and reducing inductance are the determining factors in eliminating noise.

The formula for calculating characteristic impedance is:

$$Z = \sqrt{L/C} \text{ ohms}$$

Table of Definitions

Table of Definitions	
A	Cross sectional area of a conductor in inches <sup>2</sup>
C	Capacitance in picofarads
$\delta$	Thickness of dielectric in inches
$\rho$	Resistivity of the conductor in ohms/inch
f	Frequency in hertz
I	Current in amps
K	Dielectric constant
$\ell$	Length of conductor in inches
L	Inductance in nano henrys
$L_t$	Total inductance at high frequency
M	Permeability of nonmagnetic materials = $31.9 \times 10^{-9}$ henrys/inch
R	Resistance in ohms
SD	Skin depth in inches
t	Thickness of the conductor in inches
$T_1$	Temperature at point 1 in C°
$T_2$	Temperature at point 2 in C°
w	Width of conductor in inches
$V_d$	Voltage drop in volts
$\pi$	Pi = 3.141592
$\alpha$	Temperature coefficient of resistivity
z	Impedance

## RESISTANCE, INDUCTANCE, AND CAPACITANCE COMPARISONS



### TWISTED PAIR

#10 AWG wire (solid) — 36" long  
 Insulation thickness (approx.) = .030"  
 Conductor area = .00815 in<sup>2</sup>  
 RDC (calculated) = .006 ohms

### MERSEN BUS BARS

Mersen bus bar — 36" long x 1.5" wide x .010" thick  
 Insulation thickness = .006" AMRON™ 2—5  
 Conductor area = .015 in<sup>2</sup>  
 RDC (calculated) = .0032 ohms

Freq (Hz)	RAC (ohms)	L (μhenrys)	C (pfd)
10 <sup>3</sup>	0.006	0.700	50.0
10 <sup>6</sup>	0.078	0.464	53.6
10 <sup>7</sup>	0.160	0.478	48.1

Freq (Hz)	RAC (ohms)	L (μhenrys)	C (pfd)
10 <sup>3</sup>	0.0032	0.0200	6400
10 <sup>6</sup>	0.0190	0.0060	6085
10 <sup>7</sup>	0.0610	0.0058	7480

#18 AWG wire (stranded) — 36" long  
 Insulation thickness (approx.) = .015"  
 Conductor Area = .00127 in<sup>2</sup>  
 RDC (calculated) = .038 ohms

Mersen bus bar — 36" long x .125" wide x .010" thick  
 Insulation thickness = .006" AMRON 2—5  
 Conductor Area = .00125 in<sup>2</sup>  
 RDC (calculated) = .038 ohms

Freq (Hz)	RAC (ohms)	L (μhenrys)	C (pfd)
10 <sup>3</sup>	0.038	0.800	52.5
10 <sup>6</sup>	0.275	0.557	57.3
10 <sup>7</sup>	1.300	0.540	52.0

Freq (Hz)	RAC (ohms)	L (μhenrys)	C (pfd)
10 <sup>3</sup>	0.038	0.3000	700
10 <sup>6</sup>	0.233	0.0738	678
10 <sup>7</sup>	0.738	0.0614	667

## TYPICAL CONVERSION CHARACTERISTICS

Wire Size Gauge	RAC (ohms)	Cir Mils	Sq Inches	Thick (in.)	Width (in.)	Current Carrying Capacity (amps)	DC Resistance of a 2-Conductor Bus (milliohm/ft)
22	.0253	640	.0005	.005	.101	1.52	32.44
16	.0508	2580	.0020	.005	.406	6.13	8.04
14	.0641	4110	.0032	.005	.646	9.75	5.05
10	.1019	10380	.0082	.010	.815	24.62	2.00
8	.1285	16510	.013	.015	.865	39.35	1.26
4	.2043	41740	.033	.030	1.092	99.20	.500
0	.3249	106000	.084	.045	1.850	252.00	.200
00	.3648	133000	.105	.045	2.320	316.00	.160

## INSULATION

Mersen utilizes many insulation systems to meet different applications. These systems combine the dielectric materials detailed in the table on the next page. By combining different materials with selective edge-conditioning techniques, our insulating systems are designed to exceed any and all of your electrical, mechanical, and environmental requirements.

Amron™ dielectric products were specifically developed for use in the manufacture of bus bars. Many of the products are coated with a B-stage resin that is reactivated during the assembly process. Most of our insulating systems are UL Recognized. Reference [www.ul.com](http://www.ul.com) for a material listing. File No. E53800.

**AMRON 1:** Series 1 are polyvinyl fluoride (PVF) films. PVF films are chemical- and solvent-resistant, demonstrate excellent molding characteristics, and have both a high dielectric constant (K-factor) as well as a high dielectric strength (Trade name: Tedlar®).

**AMRON 2:** Series 2 are aromatic polyamide polymer papers. Mechanical toughness, thermal stability, and solvent resistance are some of its characteristics (Trade name: Nomex®).

**AMRON 3:** Series 3 are polyimide films. These films are recommended for high temperature applications (Trade name: Kapton®).

**AMRON 4:** Series 4 is a composite film, made up of Amron 6 and Amron 1. Used exclusively as outside insulation, these films provide an excellent scuff-resistant coating (Mylar/Tedlar).

**AMRON 5:** Series 5 is also a composite film made up of Amron 6 and Amron 1. These films are used as internal insulation and are recommended for high dielectric strength applications (Tedlar/Mylar/Tedlar).

**AMRON 6:** Series 6 are polyethylene terephthalate (PET) films. PET are polyester films which offer an excellent balance of electrical, chemical, thermal, and physical properties (Trade name: Mylar®).

**AMRON 7:** Series 7 is a composite insulator made up of Amron 2 and Amron 6. This composite combines the mechanical toughness of Nomex with the electrical properties of Mylar (Nomex/Mylar/Nomex).

**AMRON 8:** Series 8 are laminated sheets constructed from continuous-filament type glass fabric with a flame-retardant epoxy resin binder. Good fabrication, high dielectric, and physical strengths make this material suitable for many electrical applications (NEMA Grade FR-4).

**AMRON 9:** Series 9 are epoxy powder coatings. These coatings exhibit exceptional durability. Amron 9 should be used where conventional insulation, due to part geometry, is not practical.

Note: The insulations listed above are standard materials used in the manufacture of our bus bars. Many other dielectric materials, among them Valox®, Ultem®, and PEN, can be incorporated into your design to meet specific requirements.

Be sure to consult with a Mersen application engineer in selecting insulation, as values may fluctuate after insulation has been applied.

## BUS BAR INSULATION TECHNIQUES

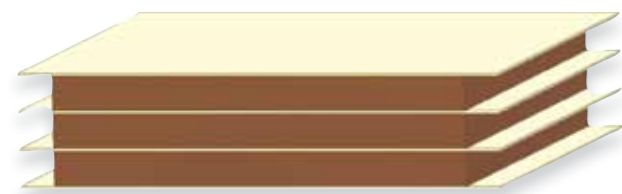
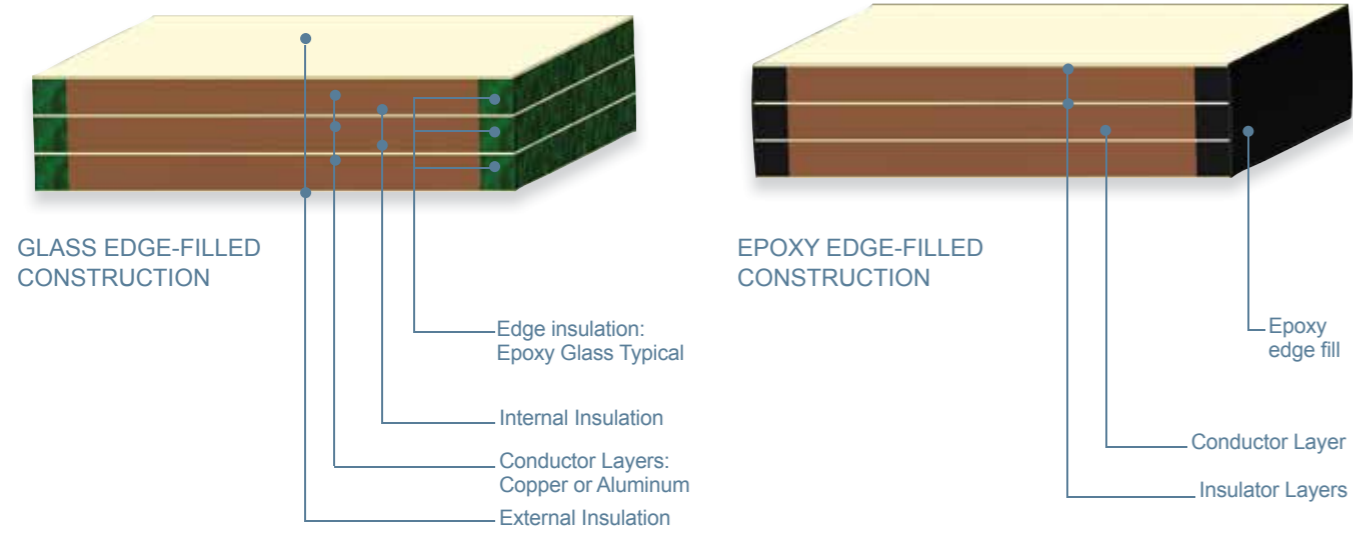

OPEN LAMINATED CONSTRUCTION

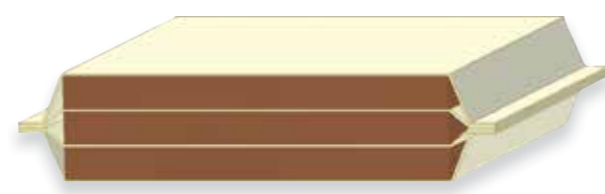

MOLDED/SEALED CONSTRUCTION

## STANDARDS

These lists detail the specifications that our standard conductor material, insulation, and plating processes meet. Incorporating these standards into your own specifications (notes) will help reduce manufacturing costs and reduce cycle times.

Conductor Material		
CDA 110	Copper	ASTM B152/B187
CDA 260	Brass	ASTM B36
CDA 510	Phosphate Bronze	ASTM B103
CDA 172	Beryllium Cu. 25	ASTM B194/B196
CDA 194	Copper Alloy	ASTM B465
Alloy 42	Nickel/Iron	ASTM F-30
1100-H12	Alloy Aluminum	ASTM B209

Insulation		
Amron 1	Tedlar®/PVF	L-P-1040
Amron 2	Nomex®	MIL-I-24204
Amron 3	Kapton®	MIL-P-46112
Amron 6	Mylar®/PET	MIL-I-631
Amron 8	FR-4	MIL-I-24768/27
Amron 9	Epoxy Powder Coating	ASTM D3451
Amron 10	Ultem®	
Amron 11	Valox®	
Epoxy Edge Fill	Black or White	MIL-I-16923

Plating	
Tin	ASTM B545
Nickel	QQ-N-290/AMS 2403
Electroless Nickel	MIL-C-26074
Sulfamate Nickel	MIL-P-27418
Gold	ASTM B488
Silver	QQ-S-365
Copper	AMS 2418
Tin-Lead (60/40)	AMS-P-81728; ASTM B579
Tin-Lead (90/10)	MIS-41177
Anodize	MIL-A-8625
Chromate	MIL-C-5541
Passivate	QQ-P-35

# GLOSSARY OF TERMS

## Capacitance

Measured in farads, it is the opposition to voltage changes in an alternating current circuit, causing voltage to lag behind current; exhibited by two conductors separated by an insulator.

## Capacitor

A passive electronic component that stores energy in the form of an electrostatic field. In its simplest form, a capacitor consists of two conducting plates separated by an insulating material called the dielectric. The capacitance is directly proportional to the surface areas of the plates, and is inversely proportional to the separation between the plates. Capacitance also depends on the dielectric constant of the material separating the plates.

## Choke

An inductor designed to present a high impedance to alternating current.

## Clearance

The clearance is defined as shortest distance through the air between two conductive elements.

## Common Collector Connection

Same as grounded collector connection. Also called the emitter-follower. A mode of operation for a transistor in which the collector is common to both the input and the output circuits and is usually connected to one of the power rails.

## Common Emitter Connection

Same as grounded emitter connection. A mode of operation for a transistor in which the emitter is common to the input and output circuits. The base is the input terminal and the collector is the output terminal.

## Conductivity

How easily something allows electric current to pass through it. If a substance is a good conductor or highly conductive (for example copper or brass), it will allow electrons to pass freely through it, offering only minor resistance.

## Corona

A luminous discharge due to ionization of the air surrounding a conductor caused by a voltage gradient exceeding a certain critical value.

## Corona Extinction Voltage (CEV)

The highest voltage at which a continuous corona of specified pulse amplitude no longer occurs, as the applied voltage is gradually decreased from above the corona inception value.

## Corona Inception Voltage (CIV)

The lowest voltage at which a continuous corona of specified pulse amplitude occurs as the applied voltage is gradually increased.

## Creepage Distance

The shortest distance separating two conductors as measured along a surface touching both conductors.

## Dielectric

Nonconducting material used to isolate and/or insulate energized electrical components.

## Dielectric Constant (K)

The property of the dielectric material that determines how much electric energy can be stored in a capacitor of a particular size by a value of applied voltage.

## Dielectric Strength

The maximum voltage an insulating material can withstand without breaking down.

## EMI, RFI

Acronyms for various types of electrical interference: electromagnetic interference and radio-frequency interference.

## Hi-Pot Test (High Potential Test)

A test performed by applying a high voltage for a specified time to two isolated points in a device to determine the adequacy of insulating material.

## Impedance

(Z) Measured in ohms, it is the total opposition to the flow of current offered by a circuit. Impedance consists of the vector sum of resistance and reactance.

## Insulation Resistance

The resistance offered, usually measured in megaohms, by an insulating material to the flow of current resulting from an impressed DC voltage.

## Insulators

Materials which prevent the flow of electricity. Nonconductive materials used to separate electric circuits.

## Inverter

An electric or electronic device for producing alternating current from direct current.

## Partial Discharge

A type of localized discharge resulting from transient gaseous ionization in an insulation system when the voltage stress exceeds a critical value.

## Resistance

R and measured in ohms. Opposition to current flow and dissipation of energy in the form of heat.

## Self-inductance

The property of a conductor that produces an induced voltage in itself with changing current. The term inductance alone means self-inductance. When a varying current in one conductor induces a voltage in a neighboring conductor, the effect is called mutual inductance.

## Shield

Partition or enclosure around components in a circuit to minimize the effects of stray magnetic and radio-frequency fields.

## Shunt

A low-value precision resistor used to monitor current.

## Snubber

A resistor-capacitor (RC) network used to reduce the rate of rise of voltage in switching applications.

## Voltage Drop

Conductors carrying current always have inherent resistance or impedance to the current flow. Voltage drop is the amount of voltage loss that occurs through all or part of the circuit due to impedance.

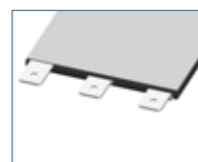

**THREE-LAYER BUS BAR WITH INDEPENDENT FASTON TABS AT LONG END**



**PRESS-FIT BUSHINGS WITH CROWN BAND INSERTS**

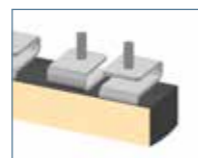

**FLEXIBLE TABS FOR LOW PROFILE AREAS**

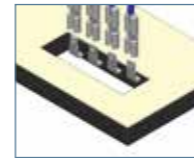

**FASTON TABS FROM INSIDE THE BUS BAR, SAVES SPACE**



**BOLT ON TABS CONFINED WITHIN THE BUS BAR, SAVES SPACE AND MATERIAL**

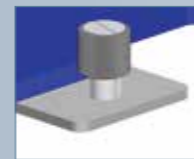

**PANEL HARDWARE**

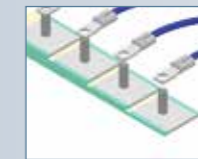

**CLINCH HARDWARE FOR RING LUGS**

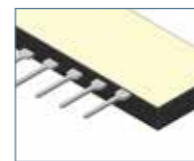

**SQUARE PINS FOR SOLDER CONNECTIONS OR WIRE WRAP**



**FASTON TABS EXTENDING BEYOND THE BUS BAR OR WITHIN**



**MOLDER HARDWARE, IDEAL FOR THIN MATERIALS AND HIGH TORQUE APPLICATIONS**



**FASTON TABS ALONG THE EDGE WITH FORMS FOR EASY ACCESS**

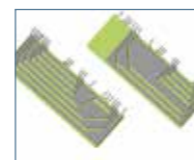

**MULTILAYER AND MULTI-CONDUCTOR TABS FOR PCB POWER**



**FLANGE TAB CONSTRUCTION WITH CLINCH HARDWARE**



**RING LUG TERMINATIONS USING CLINCH STUD HARDWARE IN FORMED TABS**



**SOLDER PIN CONNECTION WITH THERMAL RELIEF**

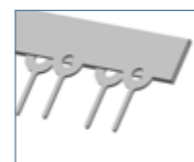

**SOLDER PINS FOR PCB CONNECTION WITH THERMAL RELIEF HOLES IN BUS BAR**

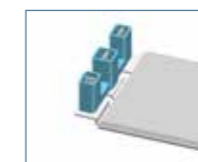

**CONNECTORS IN PLASTIC HOUSING, SOLDERED INTO EACH CONDUCTOR**

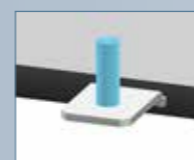

**CLINCH STUD HARDWARE IN SIDE TAB INTERCONNECT (NOTE OFFSET FORM IN TAB)**

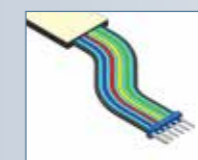

**FLEX CIRCUIT INTEGRATED INTO BUS BAR FOR FLEXIBLE INTERCONNECTION**





**HIGH CURRENT POWER RECEPTACLE WITH CROWN-BAND INSERTS**



**THREE-LAYER BUS BAR UTILIZING EMBOSSED "DIMPLES" FOR COPLANAR INTERCONNECTION**



 Main production sites  
 Industrial or commercial branch

**MERSEN**  
*Expertise, our source of energy*

**A WORLD LEADER  
 in safety & reliability  
 for electrical power**

## A GLOBAL PLAYER

Global expert in materials and equipment for extreme environments and in the safety and reliability of electrical equipment.

Mersen designs innovative solutions to address its clients' specific needs to enable them to optimize their manufacturing process in sectors such as Energy, Transportation, Electronics, Chemical, Pharmaceutical and Process Industries.

**MERSEN Rochester**  
 1500 Jefferson Road  
 Rochester, NY 14623  
 USA  
 T: 585 427 7280  
 F: 585 272 0018

**MERSEN France**  
 2-4 rue du Déry  
 49480 St Sylvain d'Anjou  
 France  
 T: +33 (2) 41 96 15 40  
 F: +33 (2) 41 96 88 40

**MERSEN Shanghai**  
 No. 55-A6. Shu Shan Road  
 Songjiang 201611  
 Shanghai  
 T: +8621 67602388