



Automation for a Changing World

Delta Intelligent Sensorless Vector Control Drive CP2000 Series



www.delta.com.tw/ia

 **DELTA**
Smarter. Greener. Together.

WHY CP2000?

IABG green technology

Delta Industrial Automation, an energy-saving product provider, is proud to introduce the CP2000 Series, a new sensorless vector control drive for HVAC systems and for pump and fan applications.

The CP2000 features all the functions you need for the ultimate in operation efficiency including intelligent PID control, sensorless vector control, a multi-segment V/F control curve and a soft start function, which are excellent for variable torque loads and constant horsepower load applications.





2000

Water Circulation Pump Control

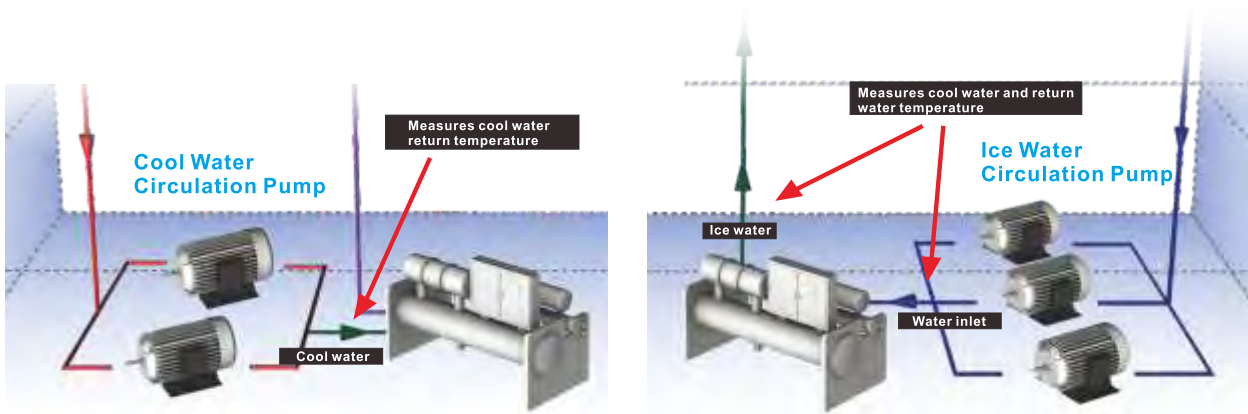

Figure1:Multi-Pumps Control

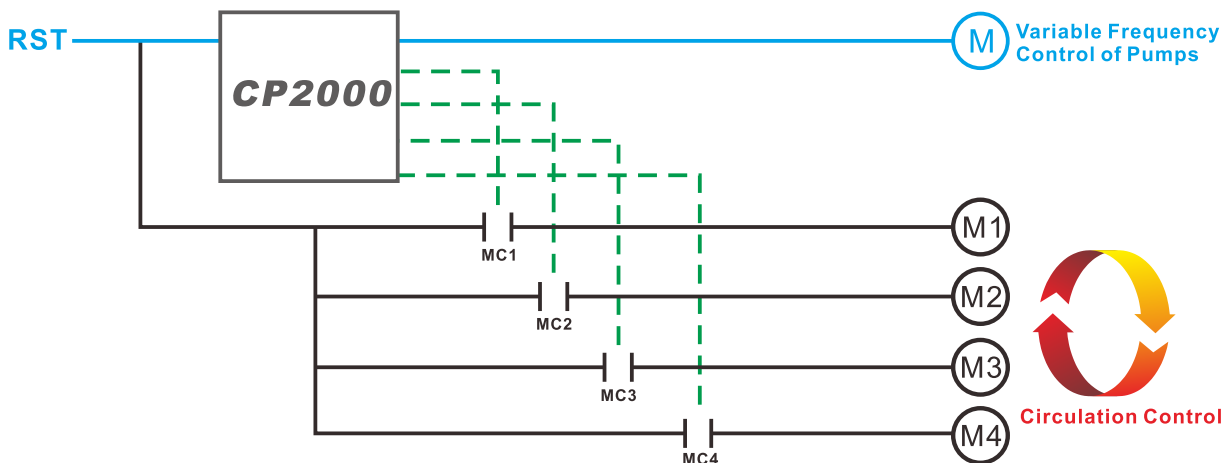

Figure 2: Fixed Amount and Circulation Control

Features

- 01 LCD keypad - An easy-to-use text panel and the TP Editor software allows users to self-define the main page screen
- 02 Quick setting - Allows the user to self-define the parameter groups and parameter duplication for fast and easy installation
- 03 Modular design - Provides flexible extension and is easy to maintain
- 04 High-speed communications includes BACnet and MODBUS - Optional communication cards that are available upon purchase: ProfiBUS-DP, DeviceNet, MODBUS TCP, EtherNet-IP and CANopen
- 05 Long life cycle
- 06 PCB (Printed Circuit Board) - Enhances drive durability in critical environments
- 07 Fire mode and Bypass functions - Provides continuous pressure to extract smoke when emergencies occur
- 08 Various modes for fans/pumps applications - PID control, sleep/wake up functions, flying start and skip frequency
- 09 Multi-pumps control - Synchronously controls up to 8 motors at one time and provides fixed amount and fixed time circulation control
- 10 Built-in 10K step PLC programming capacity and Real Time Clock

Advanced Drive Technology

High Performance Variable Frequency Drive Technology

1. SVC Sensorless vector control
2. Dual rating design (Light duty & Normal duty)
3. Excellent variable torque control

Modular Design

1. Hot plug LCD keypad
2. I/O extension card
3. Various communication cards
4. Removable fans

Versatile Drive Control

1. Built-in Programmable Logic Controller
2. Built-in brake unit*
3. Networking drive system
4. Auto energy saving design

Environmental Adaptability

1. 50°C operation temperature
2. Built-in DC choke*
3. Coated circuit boards
4. Built-in EMI filter*
5. Global safety standards (CE/UL/cUL)



*Note: Please refer to the Product Specification

Standard Models

Power range: 230V 0.75~90kW, 460V: 0.75~400kW

230V (kW)	0.75	1.5	2.2	3.7	5.5	7.5	11	15	18.5	22	30	37	45	55	75	90	
230V (HP)	1	2	3	5	7.5	10	15	20	25	30	40	50	60	75	100	125	
Frame Size	A					B			C			D		E			
460V (kW)	0.75	1.5	2.2	3.7	4.0	5.5	7.5	11	15	18.5	22	30	37	45	55	75	90
460V (HP)	1	2	3	5	5	7.5	10	15	20	25	30	40	50	60	75	100	125
Frame Size	A					B			C			D					
460V (kW)	110	132	160	185	220	280	315	355	400								
460V (HP)	150	175	215	250	300	375	425	475	536								
Frame Size	E		F		G		H										

Standards

• CE

Low Voltage :

EN61800-5-1

EMC :

EN61000-3-12, EN61800-3

IEC61000-6-2, IEC61000-6-4

IEC61000-4-2, IEC61000-4-3

IEC61000-4-4, IEC61000-4-5

IEC61000-4-6, IEC61000-4-8

• UL, cUL

• C-Tick

• ROHS



High-Speed Network

- Advanced network functions.
 - Built-in MODBUS RS-485
 - Built-in BACnet MS/TP
- Provides various communication network cards and field bus cards.



Building Automation Applications

- 4-points adjustable V/F control - Real-time adjustment of input voltage under variable torque load environments, especially for pump and fan applications.
- Flying start and momentary power loss restart functions.
- Skip frequency function avoids mechanical resonance and protects equipment.
- Low-current protection function prevents no-loads operation.
- All models support BACnet protocols saving building wiring costs.

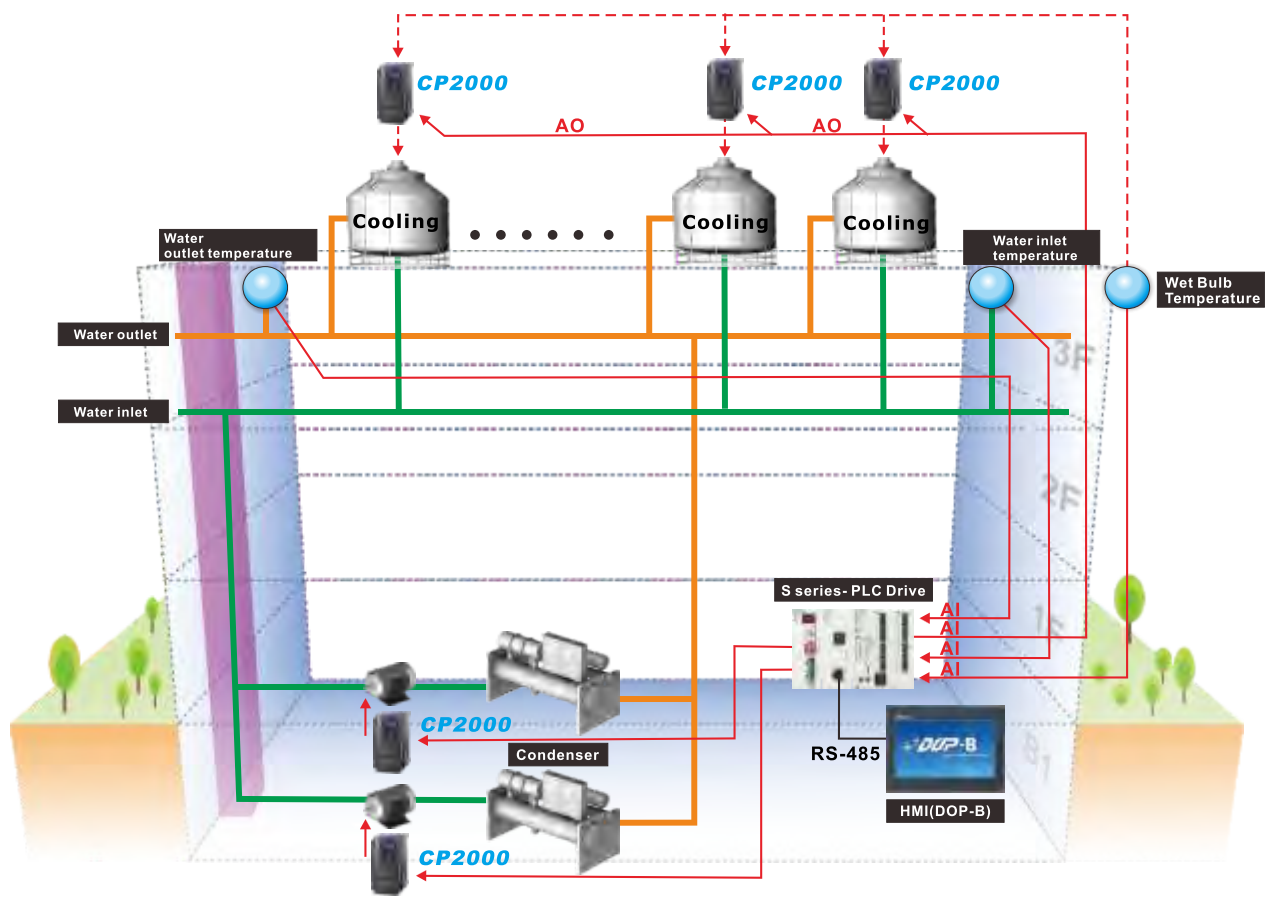

Excellent Motor Performance

- Sensorless Vector Control (SVC) and Auto-tuning functions improve the motor performance for variable torque load applications.
- Deceleration Energy Backup (dEb) function decelerates motor to a stop when sudden power failure occurs and protects the equipment from damage.
- Auto adjusting acceleration/deceleration speed reduces mechanical vibration when activated or stops the machine for a smooth operation process.
- Energy saving control functions include PID control, sleep/wakeup mode and auto-energy saving mode.

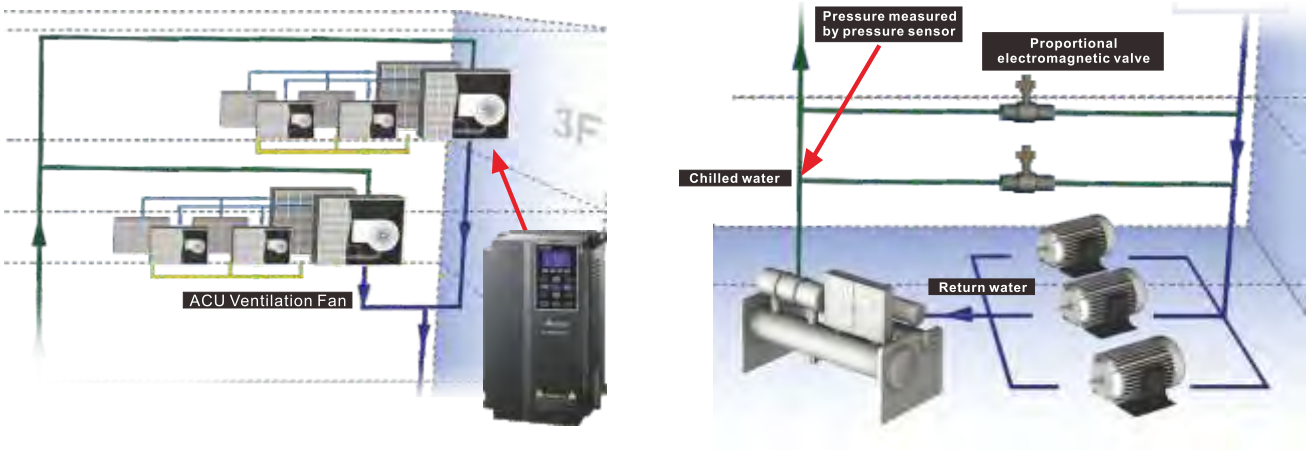

Intelligent Programmable Logic Controller

- Built-in 10K steps PLC function - Provides distribution control and independent control functions when connecting to a network system.
- Real-time clock - Facilitates writing the PLC program for ON/OFF chronology, daylight savings function and more.

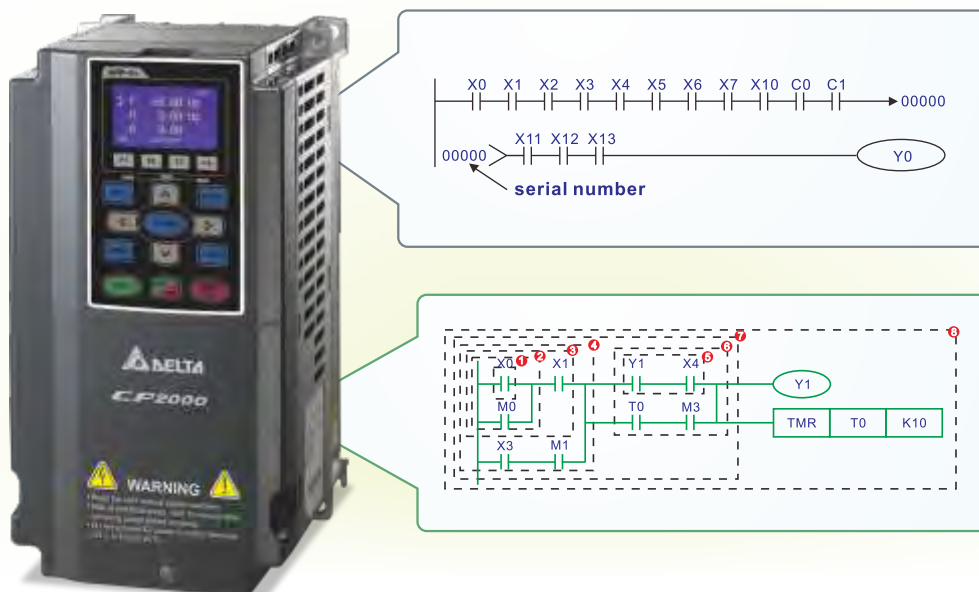

Modular Design

Modular design provides excellent motor drive control functions as well as easy installation and maintenance. Accessories include input/output extension cards, communication cards, hot plug LCD keypad, removable terminal blocks and removable fans.

- KPC-CCO1 Keypad
- Easy to install and remove with one press
- Standard RJ45 network cable



- The product nameplate shows the input/output voltage, input/output current, frequency range, and more.



- RFI Switch



- Removes the safety screws on the top cover. Press on two sides to remove the cover to begin the wiring process.



- Modularized fan design, easy to change, easy to clean for longer product life.



Flexible Application for Different Environments

- Built-in DC choke*
- Built-in EMI Filter*
- Enhanced coating on the control board's PCB to ensure reliability of VFD in an adverse environment.
- The electronic components of the drive are isolated from the cooling system to reduce heat interference. Dissipated heat can be discharged by flange-mounting installation, and forced fan cooling can import cold air into the heat sink. The system of heat dissipation can be optimized by these two cooling methods for the best performance.

*Note: Please refer to the Product Specification



Operating Environment

DO NOT expose the AC motor drive to harsh environments, such as dust, direct sunlight, corrosive/ inflammable gasses humidity, liquid or vibrations. The salt in the air must be less than 0.01mg/cm² per year.

Environment	Installation location	IEC60364-1/IEC60664-1 Pollution degree 2, Indoor use only		
	Surrounding Temperature	Storage/ Transportation	-25°C ~ +70°C	
		No-condensation, non-frozen		
	Rated Humidity	Operation	Max. 90%	
		Storage/ Transportation	Max. 95%	
		No condensed water		
	Air Pressure	Operation/ Storage	86 to 106 kPa	
		Transportation	70 to 106 kPa	
	Pollution Level	IEC721-3-3		
		Operation	Class 3C2 : Class 3S2	
Storage		Class 2C2 : Class 2S2		
Transportation		Class 1C2 : Class 1S2		
Altitude	No concentrate			
	Operation	If AC motor drive is installed at altitude 0~1000m, follow normal operation restriction. If it is installed at altitude 1000~3000m, decrease 2% of rated current or lower 0.5 of temperature for every 100m increase in altitude. Maximum altitude for Corner Grounded is 2000m.		
Package Drop	Storage/ Transportation	ISTA procedure 1A(according to weight) IEC60068-2-31		
Vibration	1.0mm, peak to peak value range from 2Hz to 13.2 Hz; 0.7G~1.0G range from 13.2Hz to 55Hz; 1.0G range from 55Hz to 512 Hz. Complies with IEC 60068-2-6			
Impact	IEC/EN 60068-2-27			
Operation Position	Max. allowed offset angle±10° (under normal installation position)			

Specification for Operation Temperature and Protection Level

Model	Frame	Top cover	Conduit Box	Protection Level	Operation Temperature
VFDxxxxCPxxx-21	Frame A~C 230V: 0.75~30kW 460V: 0.75~37kW	Remove top cover	Standard conduit plate	IP20/UL Open Type	ND: -10°C ~50°C LD: -10°C ~40°C
		Standard with top cover		IP20/UL Type1/NEMA1	ND: -10°C ~40°C LD: -10°C ~40°C
	Frame D~H 230V: above 37kW 460V: above 45kW	N/A	No conduit box	IP20/UL Type1/NEMA1	ND: -10°C ~40°C LD: -10°C ~40°C
VFDxxxxCPxxx-00	Frame D~H 230V: above 37kW 460V: above 45kW	N/A	No conduit box	IP00 IP20/UL Open Type 	ND: -10°C ~50°C LD: -10°C ~40°C (ND=Normal Duty LD=Light Duty)

Product Specifications

230V

Frame Size		A					B			C			D		E		
Model : VFD-___CP23-__		007	015	022	037	055	075	110	150	185	220	300	370	450	550	750	900
Output Rating	Light Duty	Rated Output Capacity (kVA)															
	Light Duty	Rated Output Current (A)															
	Light Duty	Applicable Motor Output(kW)															
	Light Duty	Applicable Motor Output(HP)															
	Light Duty	Overload Tolerance															
	Normal Duty	Rated Output Capacity (kVA)															
	Normal Duty	Rated Output Current (A)															
	Normal Duty	Applicable Motor Output(kW)															
	Normal Duty	Applicable Motor Output(HP)															
	Normal Duty	Overload Tolerance															
Input Rating	Max. Output Frequency (Hz)																
	Carrier Frequency (kHz)																
	Input Current (A) Light Duty																
	Input Current (A) Normal Duty																
	Rated Voltage/Frequency																
	Operating Voltage Range																
	Frequency Tolerance																
	Cooling Method		Natural Cooling / Fan Cooling														
	Braking Chopper		Frame A,B,C Built-in / Frame D and above: Optional														
	DC Choke		Frame A,B,C Optional / Frame D and above: 3% built-in														
EMI Filter		Optional															



460V

Frame		A							B			C			
Models : VFD-___CP43-__ VFD-___CP4E-__		007	015	022	037	040	055	075	110	150	185	220	300	370	
Output Rating	Light Duty	Rated Output Capacity(kVA)													
	Light Duty	Rated Output Current (A)													
	Light Duty	Applicable Motor Output(kW)													
	Light Duty	Applicable Motor Output(HP)													
	Light Duty	Overload Tolerance													
	Normal Duty	Rated Output Capacity(kVA)													
	Normal Duty	Rated Output Current (A)													
	Normal Duty	Applicable Motor Output(kW)													
	Normal Duty	Applicable Motor Output(HP)													
	Normal Duty	Overload Tolerance													
Input Rating	Max. Output Frequency (Hz)														
	Carrier Frequency (kHz)														
	Input Current (A) Light Duty														
	Input Current (A) Normal Duty														
	Rated Voltage/Frequency														
	Operating Voltage Range														
	Frequency Tolerance														
	Cooling Method		Natural Cooling / Fan Cooling												
	Braking Chopper		Frame A,B,C Built-in												
	DC Choke		Frame A,B,C Optional												
EMI Filter		Frame A, B, C of VFD___CP4E-___, EMI filter Built-in Frame A, B, C of VFD___CP43E-___, EMI filter not Built-in													

*Rated current for B type model (e.g. VFD015CP43B-21).

460V

Frame		D				E		F		G		H				
Models VFD-___CP43-___		450	550	750	900	1100	1320	1600	1850	2200	2800	3150	3550	4000		
Output Rating	Light Duty	Rated Output Capacity(kVA)														
		73	88	120	143	175	207	247	295	367	422	491	544	613		
		Rated Output Current (A)														
		91	110	150*	180	220	260*	310	370*	460	530	616	683	770		
		Applicable Motor Output(kW)														
		45	55	75	90	110	132	160	185	220	280	315	355	400		
		Applicable Motor Output(HP)														
		60	75	100	125	150	175	215	250	300	375	425	475	536		
		Overload Tolerance														
		120% of rated current for 1 minute														
Normal Duty		Rated Output Capacity(kVA)														
		58	73	88	120	143	175	207	247	295	367	438	491	544		
		Rated Output Current (A)														
		73	91	110	150	180	220	260	310	370	460	550	616	683		
		Applicable Motor Output(kW)														
	37	45	55	75	90	110	132	160	185	220	280	315	355			
	Applicable Motor Output(HP)															
	50	60	75	100	125	150	175	215	250	300	375	425	475			
	Overload Tolerance															
	120% of rated current for 1 minute;160% of rated current for 3 seconds															
	Max. Output Frequency (Hz)				600.00Hz										400.00Hz	
	Carrier Frequency (kHz)				2~10kHz(6KHz)										2~9kHz(4KHz)	
Input Rating	Input Current (A) Light Duty		91	110	150	180	220	260	310	370	460	530	616	683	770	
	Input Current (A) Normal Duty		74	101	114	157	167	207	240	300	380	400	494	555	625	
	Rated Voltage/Frequency		3-Phase AC 380V~480V(-15%~+10%), 50/60Hz													
	Operating Voltage Range		323~528Vac													
	Frequency Tolerance		47~63Hz													
	Cooling Method		Fan Cooling													
	Braking Chopper		Frame D and above: Optional													
DC Choke		Frame D and above: 3% built-in														
EMI Filter		Frame D and above: Optional														

Control Characteristics	Control Method	1: V/F(V/F control), 2: SVC(Sensorless Vector Control)													
	Starting Torque	Reach up to 160% or above at 0.5Hz													
	V/F Curve	4 point adjustable V / F curve and square curve													
	Speed Response Ability	5Hz													
	Torque Limit	Light Duty: Max. 130% torque current; Normal Duty: Max. 170% torque current													
	Torque Accuracy	±5%													
	Max. Output Frequency (Hz)	230V series: 600.00Hz (55kW and above: 400.00Hz); 460V series: 600.00Hz (90kW and above: 400.00Hz)													
	Frequency Output Accuracy	Digital command:±0.01%, -10°C~+40°C, Analog command: ±0.1%, 25±10°C													
	Output Frequency Resolution	Digital command: 0.01Hz, Analog command: max. output frequency x 0.03/60Hz (±11 bit)													
	Overload Tolerance	Light duty: 120% of rated current for 1 minute; Normal duty: 120% of rated current for 1 minute;160% of rated current for 3 seconds													
	Frequency Setting Signal	0~+10V, 4~20mA, 0~20mA, pulse input													
	Accel. / Decel. Time	0.00~600.00/0.0~6000.0 seconds													
	Main Control Function	Fault restart	Torque limit	Smart stall	Dwell	3-wire sequence									
		Speed search	Parameter copy	JOG frequency	Slip compensation	Torque compensation									
	S-curve accel/decel	Energy saving control	Accel/Decel. Time switch	Frequency upper/lower limit settings	Momentary power loss ride thru										
	PID control (with sleep function)	Auto-Tuning (rotational, stationary)	DC injection braking at start/stop	BACnet Communication	MODBUS communication (RS-485 Rj45, max. 115.2 kbps)										
	Over-torque detection			16-step speed (max)											
Fan Control	230V series: Models higher than VFD150CP23(included) are PWM control; Models lower than VFD150CP23(not included) are on / off switch control. 460V series: Models higher than VFD150CP43(included) are PWM control; Models lower than VFD150CP43(not included) are on / off switch control.														
Protection Characteristics	Motor Protection	Electronic thermal relay protection													
	Over-current Protection	Light Duty: Over-current protection for 200% rated current, Normal Duty: Over-current protection for 240% rated current, Current clamp 『Light duty: 130~135%』 『Normal duty: 170~175%』													
	Over-voltage Protection	230: drive will stop when DC-BUS voltage exceeds 410V 460: drive will stop when DC-BUS voltage exceeds 820V													
	Over-temperature Protection	Built-in temperature sensor													
	Stall Prevention	Stall prevention during acceleration, deceleration and running independently													
	Restart After Instantaneous Power Failure	Parameter setting up to 20 seconds													
	Grounding Leakage Current Protection	Leakage current is higher than 50% of rated current of the AC motor drive													
International Certifications	  GB 12668.3														

Wiring

Wiring Diagram for Frame A~C, 3-phase power is provided

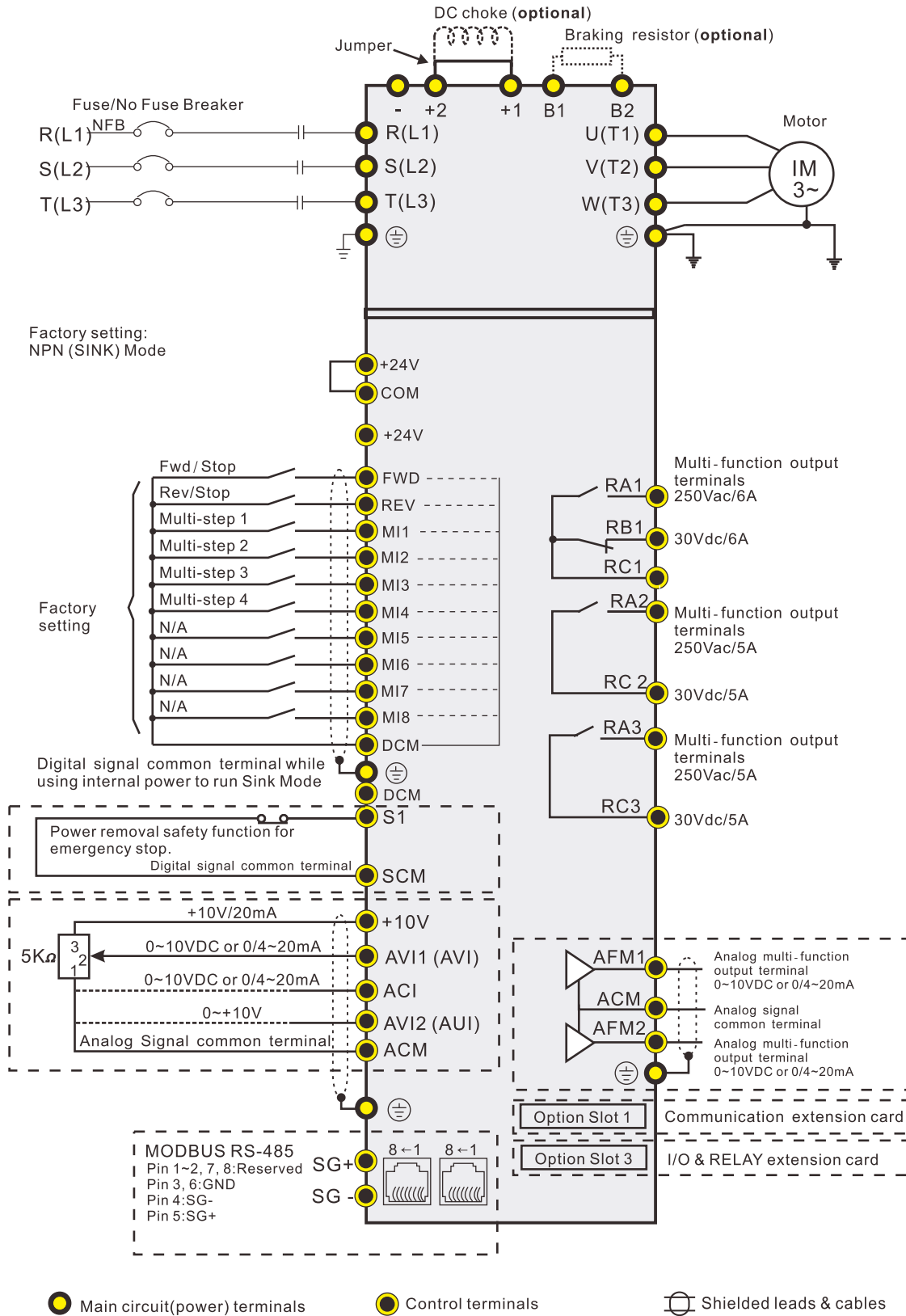

Note: It is recommended NOT to connect any phase advance capacitor or automatic power factor regulator (APFR) directly to the motor drive. If it is necessary to connect any of them, please make sure a reactor is installed between the motor drive and phase advance capacitor(APFR).

Wiring Diagram for Frame D, 3-phase power is provided

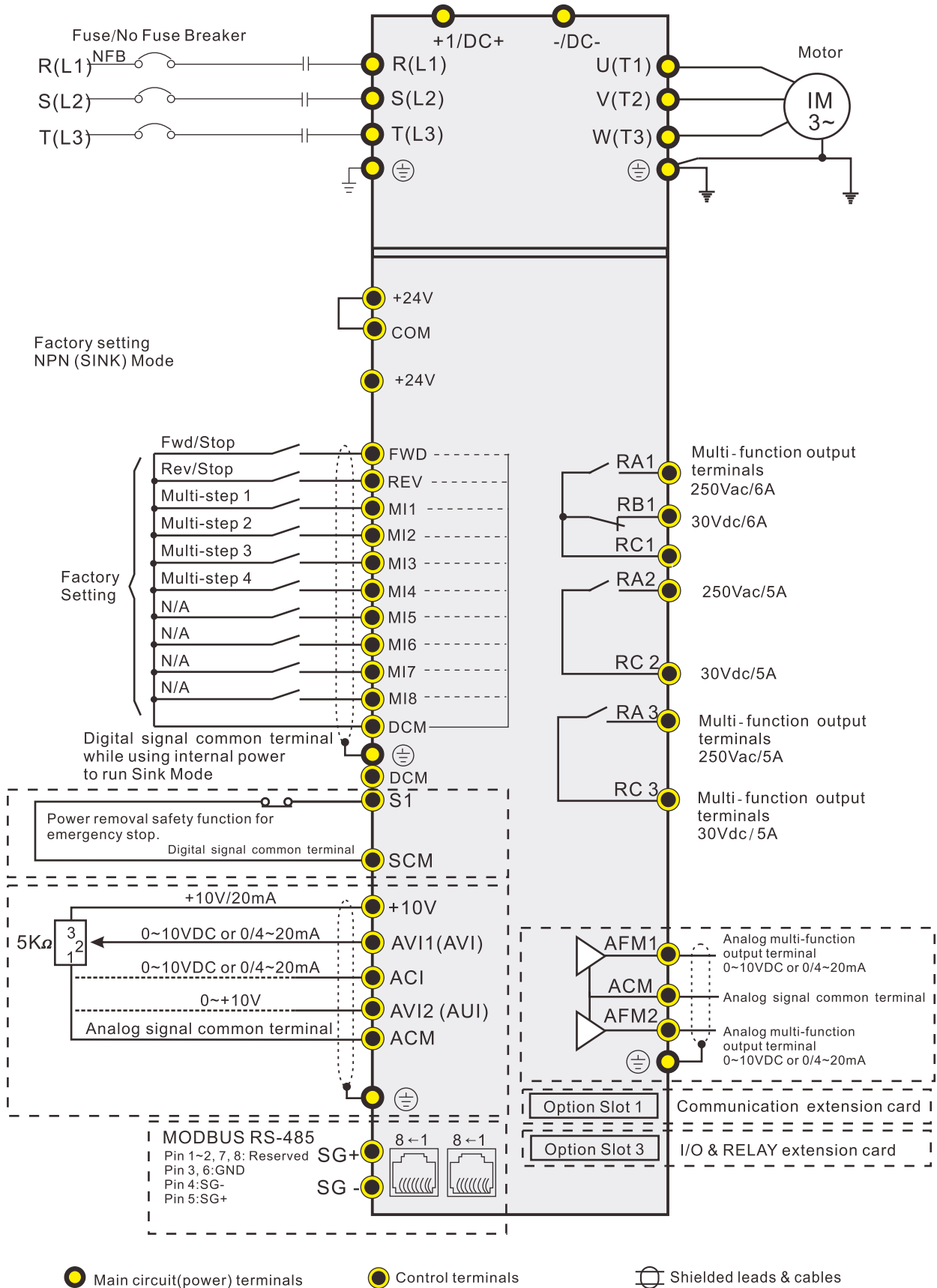

Wiring

Wiring diagram for frame E and above, 3-phase power is provided

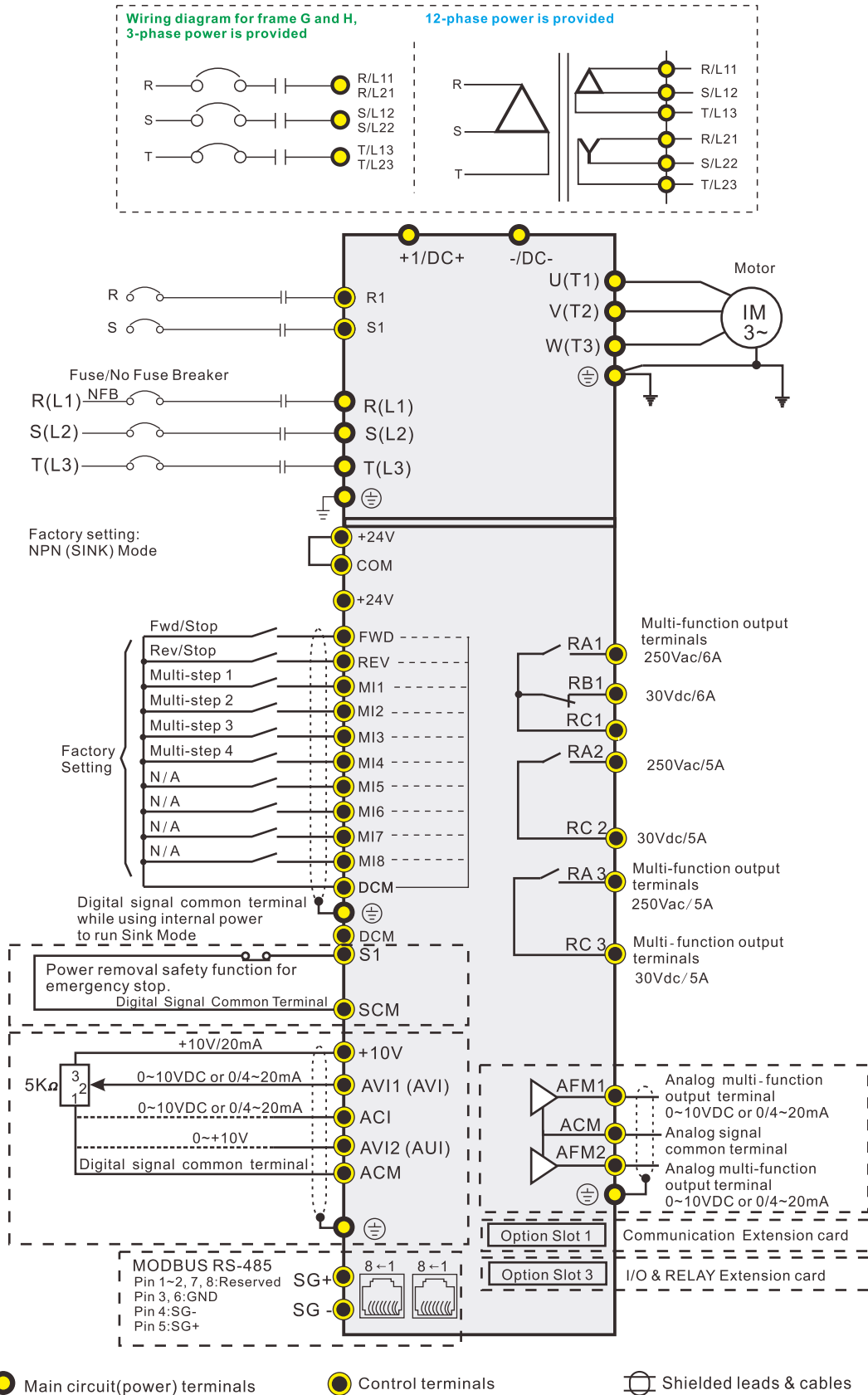

Dimensions

Digital Keypad

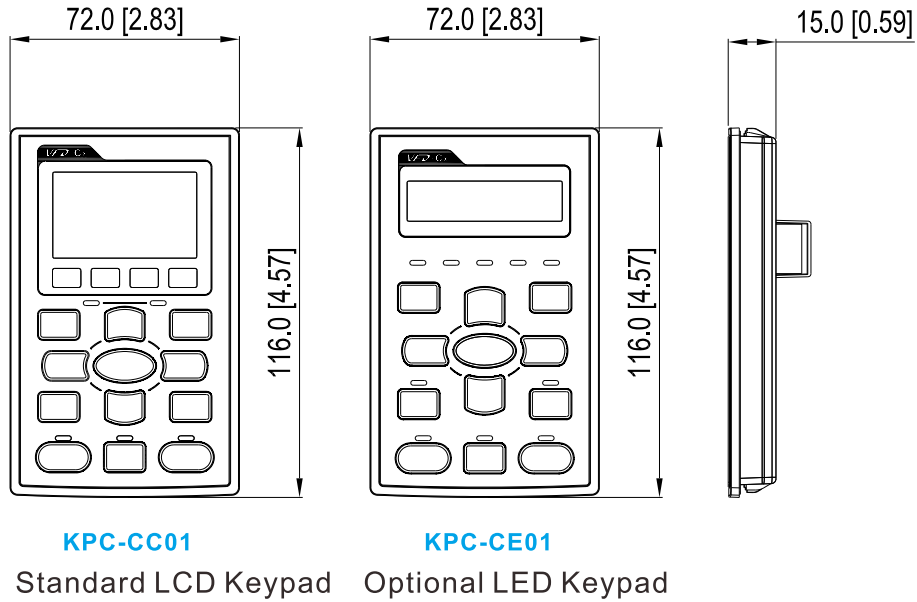

Frame A

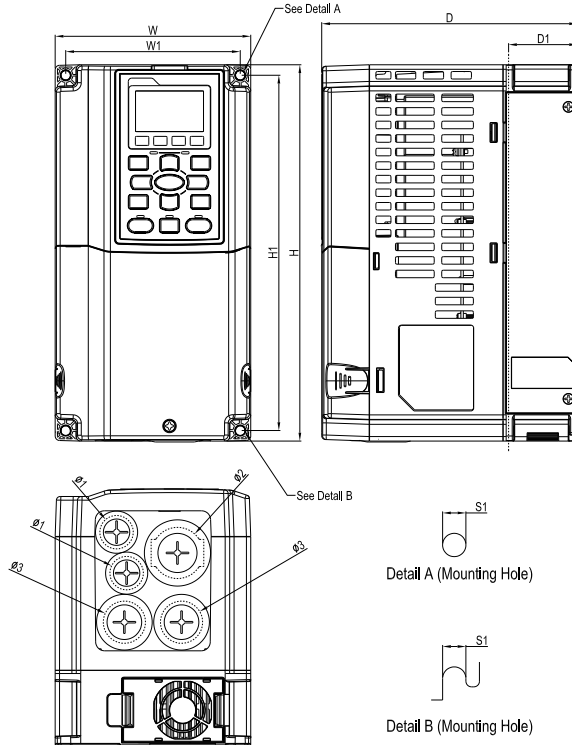

MODEL

VFD007CP23A-21	VFD055CP43B-21
VFD015CP23A-21	VFD075CP43B-21
VFD022CP23A-21	VFD007CP4EA-21
VFD037CP23A-21	VFD015CP4EB-21
VFD055CP23A-21	VFD022CP4EB-21
VFD007CP43A-21	VFD037CP4EB-21
VFD015CP43B-21	VFD040CP4EB-21
VFD022CP43B-21	VFD055CP4EB-21
VFD037CP43B-21	VFD075CP4EB-21
VFD040CP43A-21	

Unit : mm[inch]

Frame		W	H	D	W1	H1	D1*	S1	Ø1	Ø2	Ø3
A	mm	130.0	250.0	170.0	116.0	236.0	45.8	6.2	22.2	34.0	28.0
	inch	[5.12]	[9.84]	[6.69]	[4.57]	[9.29]	[1.80]	[0.24]	[0.87]	[1.34]	[1.10]

D1* : Flange mounting

Dimensions

■ Frame B

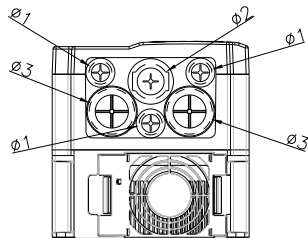
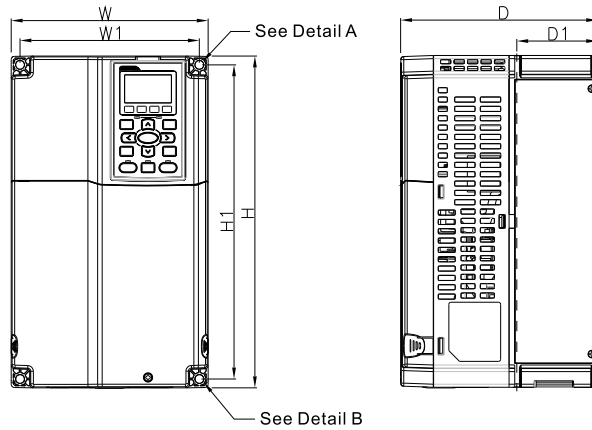

Detail A (Mounting Hole)



Detail B (Mounting Hole)

MODEL

- VFD075CP23A-21
- VFD110CP23A-21
- VFD150CP23A-21
- VFD110CP43B-21
- VFD150CP43B-21
- VFD185CP43B-21
- VFD110CP4EB-21
- VFD150CP4EB-21
- VFD185CP4EB-21

Unit : mm[inch]

Frame		W	H	D	W1	H1	D1*	S1	Ø1	Ø2	Ø3
B	mm	190.0	320.0	190.0	173.0	303.0	77.9	8.5	22.2	34.0	28.0
	inch	[7.48]	[12.60]	[7.48]	[6.81]	[11.93]	[3.07]	[0.33]	[0.87]	[1.34]	[1.10]

D1* : Flange mounting

■ Frame C

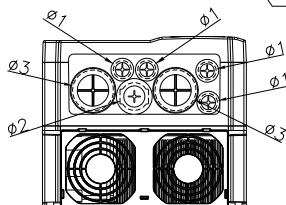
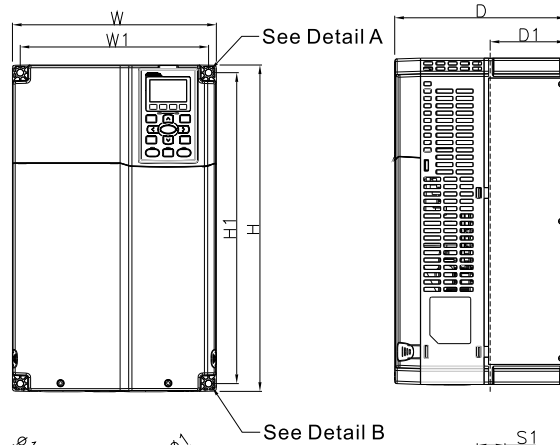

Detail A (Mounting Hole)



Detail B (Mounting Hole)

MODEL

- VFD185CP23A-21
- VFD220CP23A-21
- VFD300CP23A-21
- VFD220CP43A-21
- VFD300CP43B-21
- VFD370CP43B-21
- VFD220CP4EA-21
- VFD300CP4EB-21
- VFD370CP4EB-21

Unit : mm[inch]

Frame		W	H	D	W1	H1	D1*	S1	Ø1	Ø2	Ø3
C	mm	250.0	400.0	210.0	231.0	381.0	92.9	8.5	22.2	34.0	50.0
	inch	[9.84]	[15.75]	[8.27]	[9.09]	[15.00]	[3.66]	[0.33]	[0.87]	[1.34]	[1.97]

D1* : Flange mounting

■ Frame D1 / D0-1

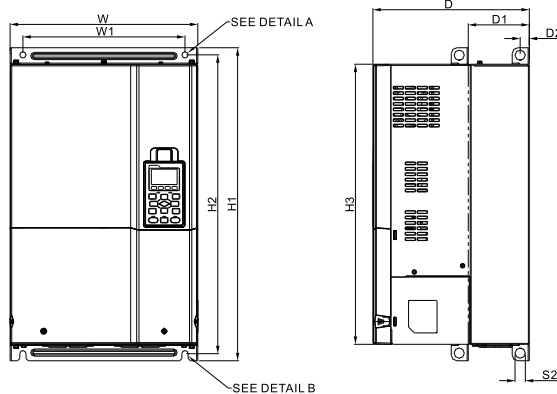

MODEL

FRAME_D1
 VFD370CP23A-00
 VFD450CP23A-00
 VFD750CP43B-00
 VFD900CP43A-00

FRAME_D0-1
 VFD450CP43S-00
 VFD550CP43S-00

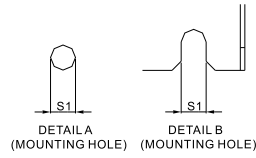
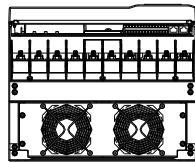

Unit : mm[inch]

Frame	W	H	D	W1	H1	H2	H3	D1*	D2	S1	S2	Ø1	Ø2	Ø3	
D1	mm	330.0	-	275.0	285.0	550.0	525.0	492.0	107.2	16.0	11.0	18.0	-	-	-
	inch	[12.99]	-	[10.83]	[11.22]	[21.65]	[20.67]	[19.37]	[4.22]	[0.63]	[0.43]	[0.71]	-	-	-

Frame	W	H	D	W1	H1	H2	H3	D1*	D2	S1	S2	
D0-1	mm	280.0	-	255.0	235.0	500.0	475.0	442.0	94.2	16.0	11.0	18.0
	inch	[11.02]	-	[10.04]	[9.25]	[19.69]	[18.70]	[17.40]	[3.71]	[0.63]	[0.43]	[0.71]

D1* : Flange mounting

■ Frame D2 / D0-2

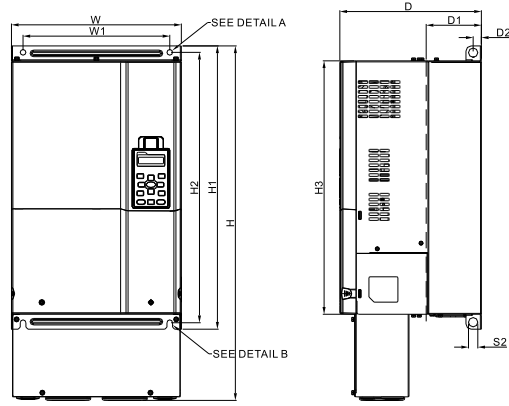

MODEL

FRAME_D2
 VFD370CP23A-21
 VFD450CP23A-21
 VFD750CP43B-21
 VFD900CP43A-21

FRAME_D0-2
 VFD450CP43S-21
 VFD550CP43S-21

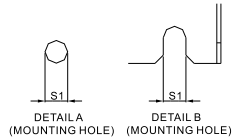
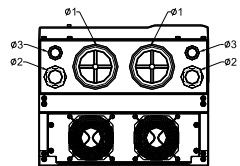

Unit : mm[inch]

Frame	W	H	D	W1	H1	H2	H3	D1*	D2	S1	S2	Ø1	Ø2	Ø3	
D2	mm	330.0	688.3	275.0	285.0	550.0	525.0	492.0	107.2	16.0	11.0	18.0	76.2	34.0	22.0
	inch	[12.99]	[27.10]	[10.83]	[11.22]	[21.65]	[20.67]	[19.37]	[4.22]	[0.63]	[0.43]	[0.71]	[3.00]	[1.34]	[0.87]

Frame	W	H	D	W1	H1	H2	H3	D1*	D2	S1	S2	Ø1	Ø2	Ø3	
D0-2	mm	280.0	614.4	255.0	235.0	500.0	475.0	442.0	94.2	16.0	11.0	18.0	62.7	34.0	22.0
	inch	[11.02]	[24.19]	[10.04]	[9.25]	[19.69]	[18.70]	[17.40]	[3.71]	[0.63]	[0.43]	[0.71]	[2.47]	[1.34]	[0.87]

D1* : Flange mounting

Dimensions

■ Frame E1

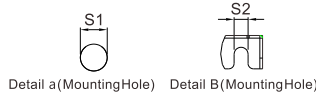
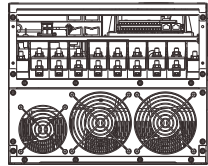
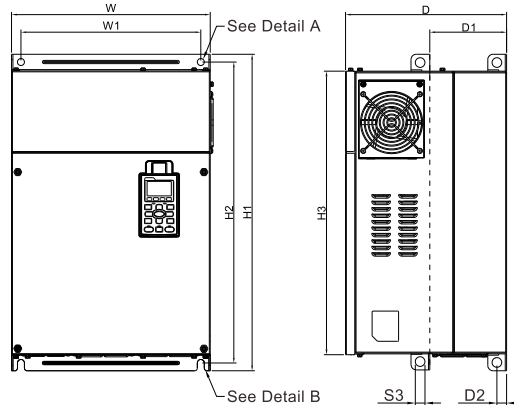

MODEL

- VFD550CP23A-00
- VFD750CP23A-00
- VFD900CP23A-00
- VFD1100CP43A-00
- VFD1320CP43B-00

Unit : mm[inch]

Frame		W	H	D	W1	H1	H2	H3	D1*	D2	S1,S2	S3	Ø1	Ø2	Ø3
E1	mm	370.0	-	300.0	335.0	589	560.0	528.0	143.0	18.0	13.0	18.0	-	-	-
	inch	[14.57]		[11.81]	[13.19]	[23.19]	[22.05]	[20.80]	[5.63]	[0.71]	[0.51]	[0.71]			

D1* : Flange mounting

■ Frame E2

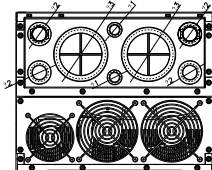
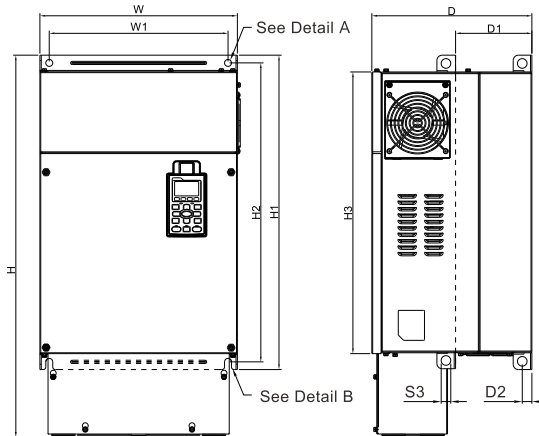

MODEL

- VFD550CP23A-21
- VFD750CP23A-21
- VFD900CP23A-21
- VFD1100CP43A-21
- VFD1320CP43B-21

Unit : mm[inch]

Frame		W	H	D	W1	H1	H2	H3	D1*	D2	S1,S2	S3	Ø1	Ø2	Ø3
E2	mm	370.0	715.8	300.0	335.0	589	560.0	528.0	143.0	18.0	13.0	18.0	22.0	34.0	92.0
	inch	[14.57]	[28.18]	[11.81]	[13.19]	[23.19]	[22.05]	[20.80]	[5.63]	[0.71]	[0.51]	[0.71]	[0.87]	[1.34]	[3.62]

D1* : Flange mounting

■ Frame F1

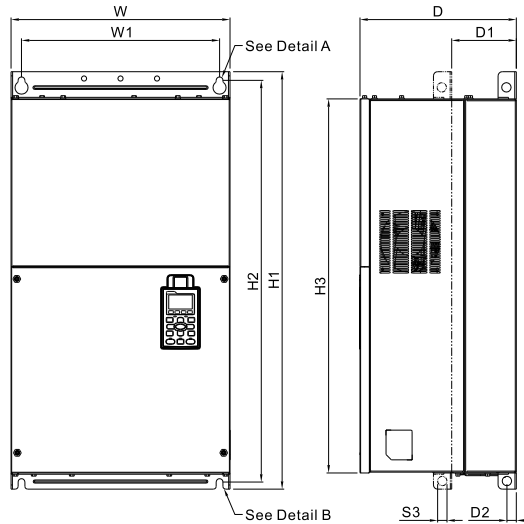

MODEL

VFD1600CP43A-00
VFD1850CP43B-00

Unit : mm[inch]

Frame	W	H	D	W1
F1	mm 420.0 inch [16.54]	-	300.0 [11.81]	380.0 [14.96]

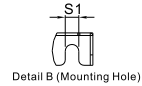
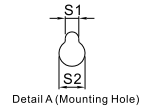
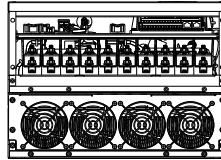

Frame	H1	H2	H3	D1*	D2	S1	S2	S3	Ø1	Ø2	Ø3
F1	mm 800.0 inch [31.50]	770.0 [30.32]	717.0 [28.23]	124.0 [4.88]	18.0 [0.71]	13.0 [0.51]	25.0 [0.98]	18.0 [0.71]	-	-	-

D1* : Flange mounting

■ Frame F2

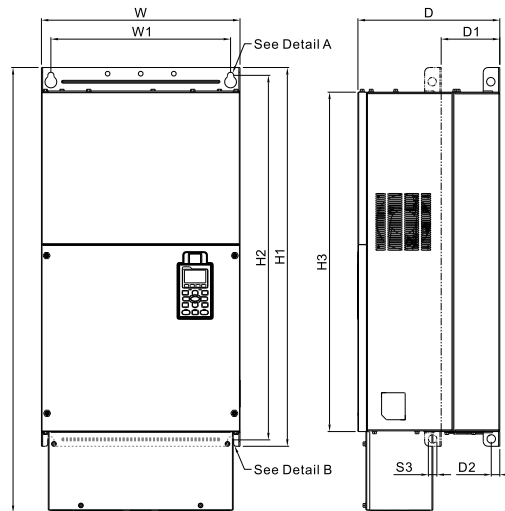

MODEL

VFD1600CP43A-21
VFD1850CP43B-21

Unit : mm[inch]

Frame	W	H	D	W1
F2	mm 420.0 inch [16.54]	940.0 [37.00]	300.0 [11.81]	380.0 [14.96]

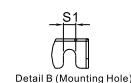
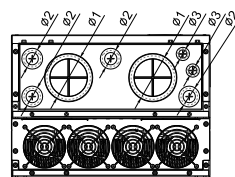

Frame	H1	H2	H3	D1*	D2	S1	S2	S3	Ø1	Ø2	Ø3
F2	mm 800.0 inch [31.50]	770.0 [30.32]	717.0 [28.23]	124.0 [4.88]	18.0 [0.71]	13.0 [0.51]	25.0 [0.98]	18.0 [0.71]	92.0 [3.62]	35.0 [1.38]	22.0 [0.87]

D1* : Flange mounting

Dimensions

■ Frame G1

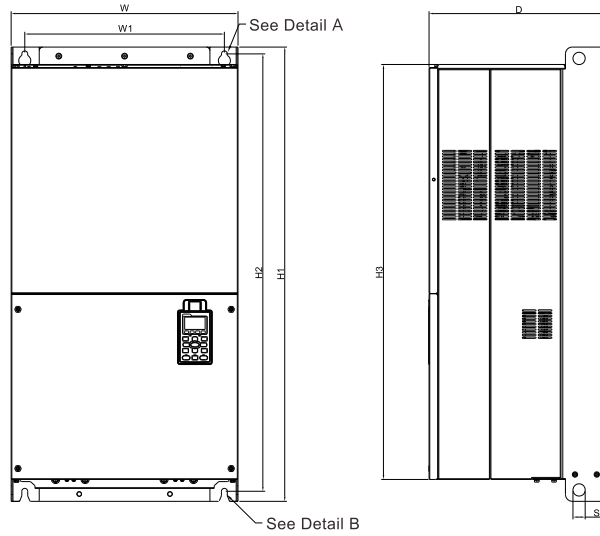

MODEL

VFD2200CP43A-00
VFD2800CP43A-00 Unit : mm[inch]

Frame	W	H	D
G1	mm	500.0	-
	inch	[19.69]	[15.63]

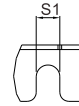
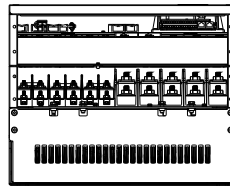

Detail a (MountingHole) Detail B (MountingHole)

Frame	W1	H1	H2	H3	S1	S2	S3	Ø1	Ø2	Ø3	
G1	mm	440.0	1000.0	963.0	913.6	13.0	26.5	27.0	-	-	-
	inch	[217.32]	[39.37]	[37.91]	[35.97]	[0.51]	[1.04]	[1.06]			

■ Frame G2

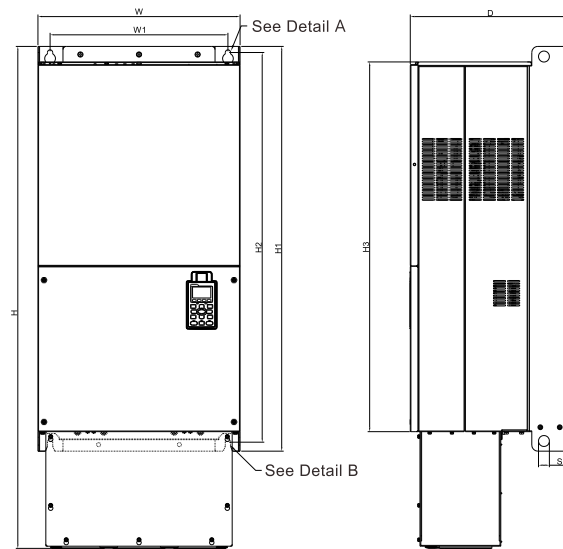

MODEL

VFD2200CP43A-21
VFD2800CP43A-21 Unit : mm[inch]

Frame	W	H	D
G2	mm	500.0	1240.2
	inch	[19.69]	[48.83]

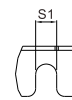
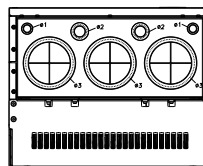

Detail a (MountingHole) Detail B (MountingHole)

Frame	W1	H1	H2	H3	S1	S2	S3	Ø1	Ø2	Ø3	
G2	mm	440.0	1000.0	963.0	913.6	13.0	26.5	27.0	22.0	34.0	117.5
	inch	[217.32]	[39.37]	[37.91]	[35.97]	[0.51]	[1.04]	[1.06]	[0.87]	[1.34]	[4.63]

■ Frame H1

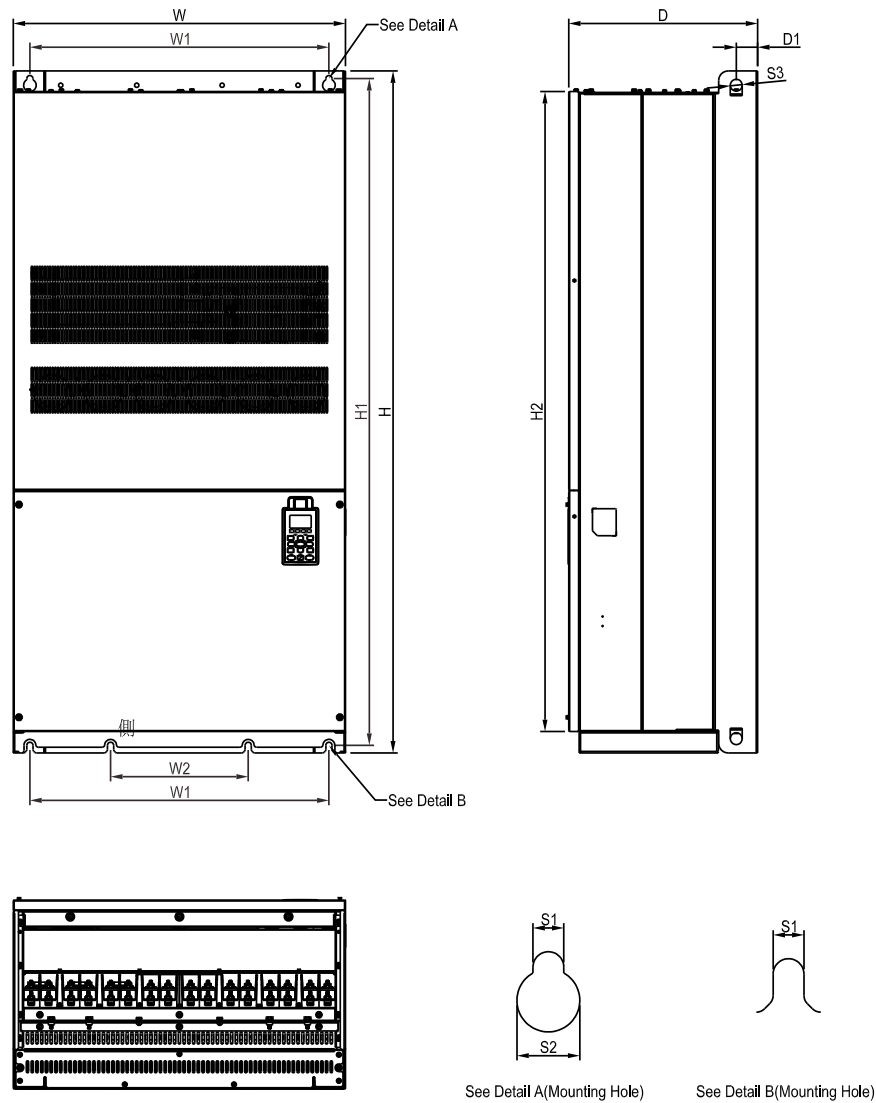

MODEL

VFD3150CP43A-00
 VFD3550CP43A-00
 VFD4000CP43A-00

Unit : mm[inch]

Frame	W	H	D	W1	W2	W3	W4	W5	W6	H1	H2	H3	H4
H1	mm inch	700.0 [27.56]	1435.0 [56.5]	398.0 [15.67]	630.0 [24.80]	290.0 [11.42]	-	-	-	1403.0 [55.24]	1346.6 [53.2]	-	-

Frame	H5	D1	D2	D3	D4	D5	D6	S1	S2	S3	Ø1	Ø2	Ø3
H1	mm inch	-	45.0 [1.77]	-	-	-	-	13.0 [0.51]	26.5 [1.04]	25.0 [0.98]	-	-	-

Dimensions

■ Frame H2

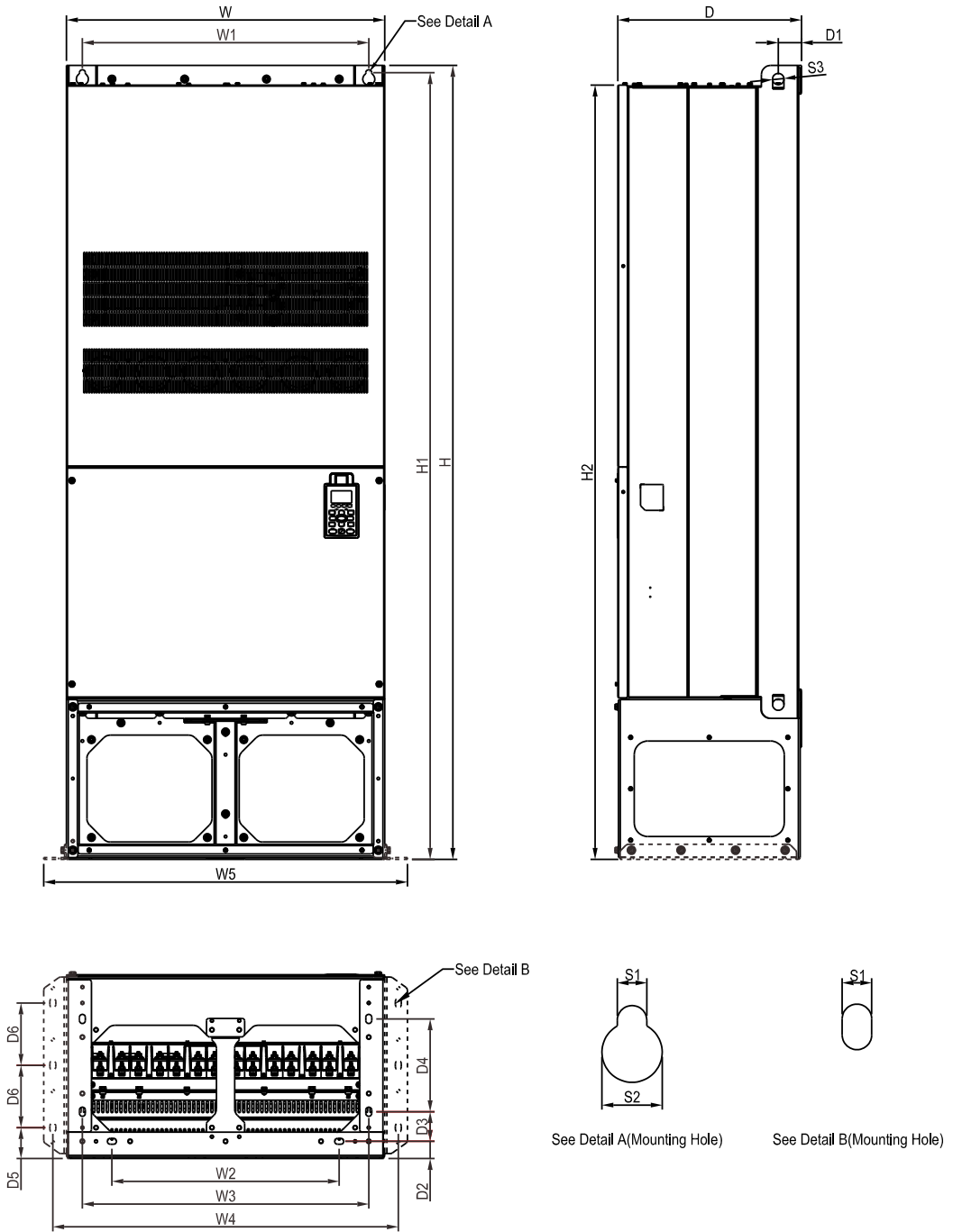

MODEL

VFD3150CP43C-00
 VFD3550CP43C-00
 VFD4000CP43C-00

Unit : mm[inch]

Frame	W	H	D	W1	W2	W3	W4	W5	W6	H1	H2	H3	H4	
H2	mm	700.0	1745.0	404.0	630.0	500.0	630.0	760.0	800.0	-	1729.0	1701.6	-	-
	inch	[27.56]	[68.70]	[15.91]	[24.80]	[19.69]	[24.80]	[29.92]	[31.50]	-	[68.07]	[66.99]	-	-

Frame	H5	D1	D2	D3	D4	D5	D6	S1	S2	S3	Ø1	Ø2	Ø3
H2	mm	-	51.0	38.0	65.0	204.0	68.0	137.0	13.0	26.5	25.0	-	-
	inch	-	[2.01]	[1.50]	[2.56]	[8.03]	[2.68]	[5.39]	[0.51]	[1.04]	[0.98]	-	-

■ Frame H3

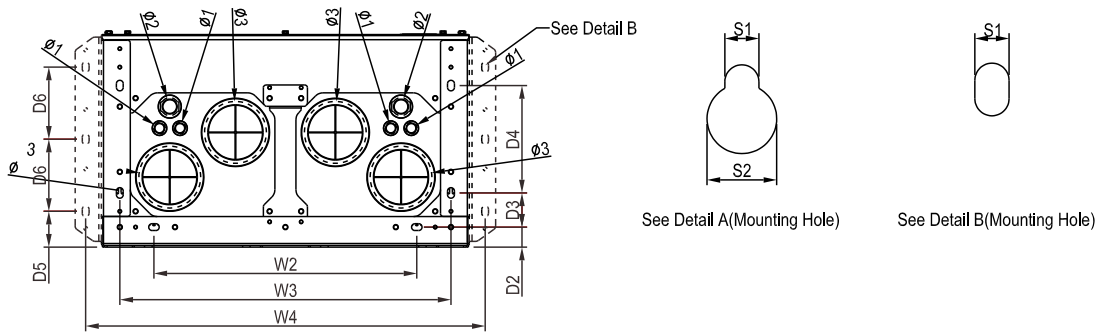
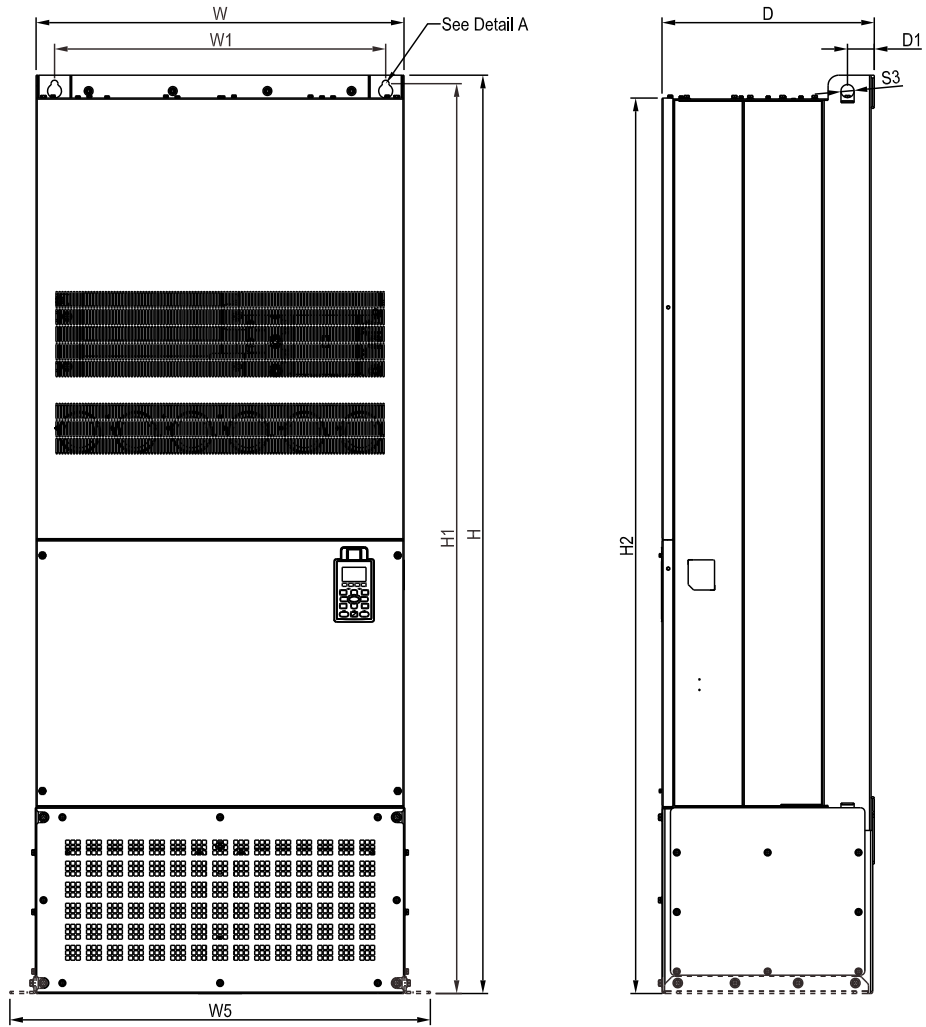

MODEL

VFD3150CP43C-21
 VFD3550CP43C-21
 VFD4000CP43C-21

Unit : mm[inch]

Frame		W	H	D	W1	W2	W3	W4	W5	W6	H1	H2	H3	H4
H3	mm	700.0	1745.0	404.0	630.0	500.0	630.0	760.0	800.0	-	1729.0	1701.6	-	-
	inch	[27.56]	[68.70]	[15.91]	[24.80]	[19.69]	[24.80]	[29.92]	[31.50]	-	[68.07]	[66.99]	-	-
Frame		H5	D1	D2	D3	D4	D5	D6	S1	S2	S3	$\phi 1$	$\phi 2$	$\phi 3$
H3	mm	-	51.0	38.0	65.0	204.0	68.0	137.0	13.0	26.5	25.0	22.0	34.0	117.5
	inch	-	[2.01]	[1.50]	[2.56]	[8.03]	[2.68]	[5.39]	[0.51]	[1.04]	[0.98]	[0.87]	[1.34]	[4.63]

Option Cards

EMC-D42A

		Terminals	Descriptions
		 <p>I/O Extension Card</p>	COM
MI10~ MI13	Refer to parameters 02-26~02-29 to program the multi-function inputs MI10~MI13. Internal power is applied from terminal E24: +24Vdc±5% 200mA, 5W External power +24Vdc: max. voltage 30Vdc, min. voltage 19Vdc, 30W ON: the activation current is 6.5mA OFF: leakage current tolerance is 10µA		
MO10~MO11	Multi-function output terminals (photocoupler) Duty-cycle: 50% Max. output frequency: 100Hz Max. current: 50mA Max. voltage: 48Vdc		
MXM	Common for multi-function output terminals MO10, MO11(photocoupler) Max 48Vdc 50mA		

EMC-D611A

		Terminals	Descriptions
			AC
MI10~ MI15	Refer to Pr. 02.26~ Pr. 02.31 for multi-function input selection Input voltage: 100~130VAC Input frequency: 57~63Hz Input impedance: 27Kohm Terminal response time: ON: 10ms OFF: 20ms		

EMC-R6AA

		Terminals	Descriptions
		 <p>Relay Extension Card</p>	RA10~RA15 RC10~RC15

EMC-BPS01

		Terminals	Descriptions
		 <p>Power Shift Card</p>	24V GND

CMC-MOD01



Features

- MDI/MDI-X auto-detect
- Virtual serial port.
- Supports MODBUS TCP protocol
- AC motor drive keypad/Ethernet configuration
- E-mail alarm
- Baud rate: 10/100Mbps auto-detect

Network Interface

Interface	RJ-45 with Auto MDI/MDIX
Number of ports	1 Port
Transmission method	IEEE 802.3, IEEE 802.3u
Transmission cable	Category 5e shielding 100M
Transmission speed	10/100 Mbps Auto-Detect
Network protocol	ICMP, IP, TCP, UDP, DHCP, SMTP, MODBUS OVER TCP/IP, Delta Configuration

CMC-EIP01



Features

- MDI/MDI-X auto-detect
- Supports MODBUS TCP and Ethernet/IP protocol
- Baud rate: 10/100Mbps auto-detect
- AC motor drive keypad/Ethernet configuration
- Virtual serial port

Network Interface

Interface	RJ-45 with Auto MDI/MDIX
Number of ports	1 Port
Transmission method	IEEE 802.3, IEEE 802.3u
Transmission cable	Category 5e shielding 100M
Transmission speed	10/100 Mbps Auto-Detect
Network protocol	ICMP, IP, TCP, UDP, DHCP, HTTP, SMTP, MODBUS OVER TCP/IP, EtherNet/IP, Delta Configuration

CMC-PD01



Features

- Supports PZD control data exchange.
- Supports PKW polling AC motor drive parameters.
- Supports user diagnosis function.
- Auto-detects baud rates; supports Max. 12Mbps.

PROFIBUS DP Connector

Interface	DB9 connector
Transmission method	High-speed RS-485
Transmission cable	Shielded twisted pair cable
Electrical isolation	500VDC

Communication

Message type	Cyclic data exchange
Module name	CMC-PD01
GSD document	DELA08DB.GSD
Company ID	08DB (HEX)
Serial transmission speed supported (auto-detection)	9.6kbps; 19.2kbps; 93.75kbps; 187.5kbps; 125kbps; 250kbps; 500kbps; 1.5Mbps; 3Mbps; 6Mbps; 12Mbps (bits per second)

Option Cards

CMC-DN01



Features

- Based on the high-speed communication interface of Delta HSSP protocol, able to conduct immediate control of AC motor drive.
- Supports Group 2 only connection and polling I/O data exchange.
- For I/O mapping, supports Max. 32 words of input and 32 words of output.
- Supports EDS file configuration in DeviceNet configuration software.
- Supports all baud rates on DeviceNet bus: 125kbps, 250kbps, 500kbps and extendable serial transmission speed mode.
- Node address and serial transmission speed can be set up on AC motor drive.
- Power supplied from AC motor drive.

DeviceNet Connector

Interface	5-PIN open removable connector. Of 5.08mm PIN interval
Transmission method	CAN
Transmission cable	Shielded twisted pair cable (with 2 power cables)
Transmission speed	125kbps, 250kbps, 500kbps and extendable serial transmission speed mode
Network protocol	DeviceNet protocol

AC Motor Drive Connection Port

Interface	50 PIN communication terminal
Transmission method	SPI communication
Terminal function	1. Communicating with AC motor drive 2. Transmitting power supply from AC motor drive
Communication protocol	Delta HSSP protocol

EMC-COP01



RJ-45 Pin Definition

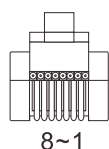

8~1

Male

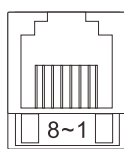

8~1

Female

Pin	Pin name	Definition
1	CAN_H	CAN_H bus line (dominant high)
2	CAN_L	CAN_L bus line (dominant low)
3	CAN_GND	Ground/0V/V-
7	CAN_GND	Ground/0V/V-

Specifications

Interface	RJ-45
Number of ports	1 Port
Transmission method	CAN
Transmission cable	CAN standard cable
Transmission speed	1M 500k 250k 125k 100k 50k
Communication protocol	CANopen

■ CANopen Communication Cable

Model: TAP-CB03, TAP-CB04

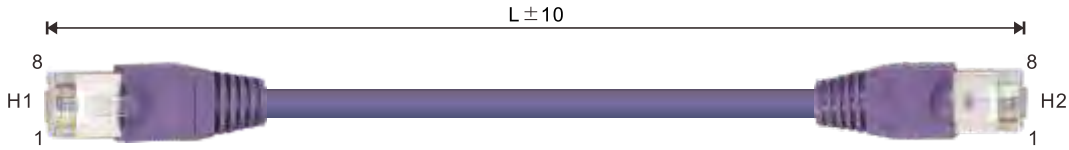

Title	Part No.	L	
		mm	inch
1	TAP-CB03	500±10	19±0.4
2	TAP-CB04	1000±10	39±0.4

■ CANopen Breakout Box

Model: TAP-CN03



■ Digital Keypad Accessories: RJ45 Extension Leads and CMC-EIP01 Cables



Applicable Models : CBC-K3FT、CBC-K5FT、CBC-K7FT、CBC-K10F、CBC-K16FT

Title	Part No.	Explanation
1	CBC-K3FT	RJ45 extension lead, 3 feet (approximately 0.9m)
2	CBC-K5FT	RJ45 extension lead, 5 feet (approximately 1.5m)
3	CBC-K7FT	RJ45 extension lead, 7 feet (approximately 2.1m)
4	CBC-K10FT	RJ45 extension lead, 10 feet (approximately 3m)
5	CBC-K16FT	RJ45 extension lead, 16 feet (approximately 4.9m)



Ordering Information

<p>Frame A</p> 	<p>230V: 0.75kW~5.5kW</p> <p>460V: 0.75kW~7.5kW</p>	<p>VFD007CP23A-21 VFD015CP23A-21 VFD022CP23A-21 VFD037CP23A-21 VFD055CP23A-21</p>	<p>VFD007CP43A-21 VFD015CP43B-21 VFD022CP43B-21 VFD037CP43B-21 VFD040CP43A-21 VFD055CP43B-21 VFD075CP43B-21</p>	<p>VFD007CP4EA-21 VFD015CP4EB-21 VFD022CP4EB-21 VFD037CP4EB-21 VFD040CP4EA-21 VFD055CP4EB-21 VFD075CP4EB-21</p>				
<p>Frame B</p> 	<p>230V: 7.5kW~15kW</p> <p>460V: 11kW~18.5kW</p>	<p>VFD075CP23A-21 VFD110CP23A-21 VFD150CP23A-21</p>	<p>VFD110CP43B-21 VFD150CP43B-21 VFD185CP43B-21</p>	<p>VFD110CP4EB-21 VFD150CP4EB-21 VFD185CP4EB-21</p>				
<p>Frame C</p> 	<p>230V: 18.5kW~30kW</p> <p>460V: 22kW~37kW</p>	<p>VFD185CP23A-21 VFD220CP23A-21 VFD300CP23A-21</p>	<p>VFD220CP43A-21 VFD300CP43B-21 VFD370CP43B-21</p>	<p>VFD220CP4EA-21 VFD300CP4EB-21 VFD370CP4EB-21</p>				
<p>Frame D</p> 	<p>230V: 37kW~45kW</p> <p>460V: 45kW~90kW</p>	<table border="0"> <tbody> <tr> <td data-bbox="667 1193 906 1352"> <p>Frame D1: VFD370CP23A-00 VFD450CP23A-00 VFD750CP43B-00 VFD900CP43A-00</p> </td> <td data-bbox="922 1193 1161 1352"> <p>Frame D2: VFD370CP23A-21 VFD450CP23A-21 VFD750CP43B-21 VFD900CP43A-21</p> </td> </tr> <tr> <td data-bbox="667 1375 906 1473"> <p>Frame D0-1: VFD450CP43S-00 VFD550CP43S-00</p> </td> <td data-bbox="922 1375 1161 1473"> <p>Frame D0-2: VFD450CP43S-21 VFD550CP43S-21</p> </td> </tr> </tbody> </table>			<p>Frame D1: VFD370CP23A-00 VFD450CP23A-00 VFD750CP43B-00 VFD900CP43A-00</p>	<p>Frame D2: VFD370CP23A-21 VFD450CP23A-21 VFD750CP43B-21 VFD900CP43A-21</p>	<p>Frame D0-1: VFD450CP43S-00 VFD550CP43S-00</p>	<p>Frame D0-2: VFD450CP43S-21 VFD550CP43S-21</p>
<p>Frame D1: VFD370CP23A-00 VFD450CP23A-00 VFD750CP43B-00 VFD900CP43A-00</p>	<p>Frame D2: VFD370CP23A-21 VFD450CP23A-21 VFD750CP43B-21 VFD900CP43A-21</p>							
<p>Frame D0-1: VFD450CP43S-00 VFD550CP43S-00</p>	<p>Frame D0-2: VFD450CP43S-21 VFD550CP43S-21</p>							
<p>Frame E</p> 	<p>230V: 55kW~90kW</p> <p>460V: 110kW~132kW</p>	<table border="0"> <tbody> <tr> <td data-bbox="667 1536 906 1733"> <p>Frame E1: VFD550CP23A-00 VFD750CP23A-00 VFD900CP23A-00 VFD1100CP43A-00 VFD1320CP43B-00</p> </td> <td data-bbox="922 1536 1161 1733"> <p>Frame E2: VFD550CP23A-21 VFD750CP23A-21 VFD900CP23A-21 VFD1100CP43A-21 VFD1320CP43B-21</p> </td> </tr> </tbody> </table>			<p>Frame E1: VFD550CP23A-00 VFD750CP23A-00 VFD900CP23A-00 VFD1100CP43A-00 VFD1320CP43B-00</p>	<p>Frame E2: VFD550CP23A-21 VFD750CP23A-21 VFD900CP23A-21 VFD1100CP43A-21 VFD1320CP43B-21</p>		
<p>Frame E1: VFD550CP23A-00 VFD750CP23A-00 VFD900CP23A-00 VFD1100CP43A-00 VFD1320CP43B-00</p>	<p>Frame E2: VFD550CP23A-21 VFD750CP23A-21 VFD900CP23A-21 VFD1100CP43A-21 VFD1320CP43B-21</p>							
<p>Frame F</p> 	<p>460V: 160kW~185kW</p>	<table border="0"> <tbody> <tr> <td data-bbox="667 1843 906 1942"> <p>Frame F1: VFD1600CP43A-00 VFD1850CP43B-00</p> </td> <td data-bbox="922 1843 1161 1942"> <p>Frame F2: VFD1600CP43A-21 VFD1850CP43B-21</p> </td> </tr> </tbody> </table>			<p>Frame F1: VFD1600CP43A-00 VFD1850CP43B-00</p>	<p>Frame F2: VFD1600CP43A-21 VFD1850CP43B-21</p>		
<p>Frame F1: VFD1600CP43A-00 VFD1850CP43B-00</p>	<p>Frame F2: VFD1600CP43A-21 VFD1850CP43B-21</p>							

Frame G 	460V: 220kW~280kW	Frame G1: VFD2200CP43A-00 VFD2800CP43A-00	Frame G2: VFD2200CP43A-21 VFD2800CP43A-21	
Frame H 	460V: 315kW~400kW	Frame H1: VFD3150CP43A-00 VFD3550CP43A-00 VFD4000CP43A-00	Frame H2: VFD3150CP43C-00 VFD3550CP43C-00 VFD4000CP43C-00	Frame H3: VFD3150CP43C-21 VFD3550CP43C-21 VFD4000CP43C-21

Model Name

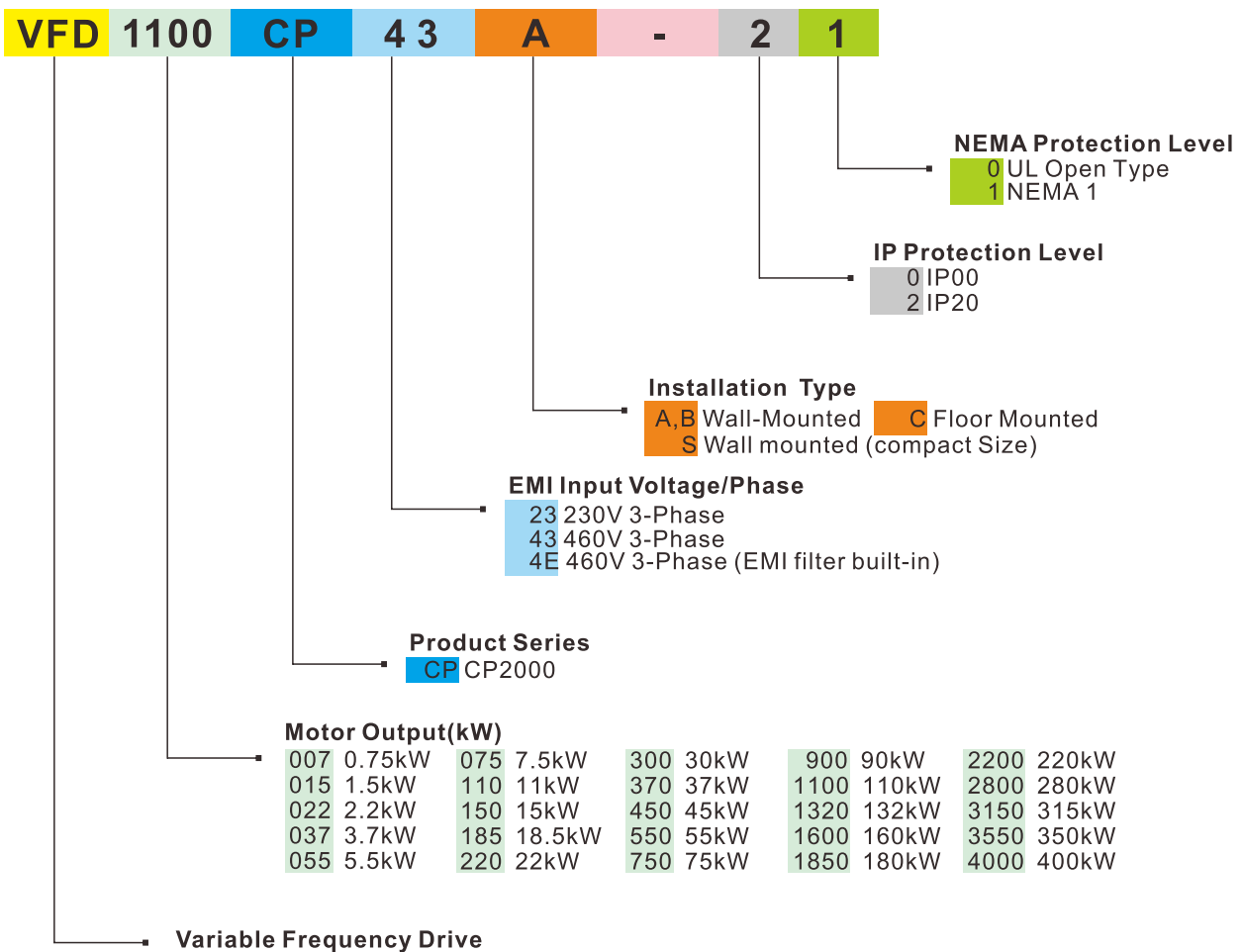



Attention

Standard Motors

Used with 400V Standard Motors

It is recommended to add an AC output reactor when using with a 400V standard motor to prevent damage to motor insulation.

Torque Characteristics and Temperature Rise

When a standard motor is drive controlled, the motor temperature will be higher than with DOL operation.

Please reduce the motor output torque when operating at low speeds to compensate for less cooling efficiency.

For continuous constant torque at low speeds, external forced motor cooling is recommended.

Vibration

When the motor drives the machine, resonances may occur, including machine resonances.

Abnormal vibration may occur when operating a 2-pole motor at 60Hz or higher.

Noise

When a standard motor is drive controlled, the motor noise will be higher than with DOL operation.

To lower the noise, please increase the carrier frequency of the drive. The motor fan can be very noisy when the motor speed exceeds 60Hz.

Special Motors

High-speed Motor

To ensure safety, please try the frequency setting with another motor before operating the high-speed motor at 120Hz or higher.

Explosion-proof Motor

Please use a motor and drive that comply with explosion-proof requirements.

Submersible Motor & Pump

The rated current is higher than that of a standard motor.

Please check before operation and select the capacity of the AC motor drive carefully.

The motor temperature characteristics differ from a standard motor, please set the motor thermal time constant to a lower value.

Brake Motor

When the motor is equipped with a mechanical brake, the brake should be powered by the mains supply.

Damage may occur when the brake is powered by the drive output. Please DO NOT drive the motor with the brake engaged.

Gear Motor

In gearboxes or reduction gears, lubrication may be reduced if the motor is continuously operated at low speeds.

Please DO NOT operate in this way.

Synchronous Motor

These motors need suitable software for control. Please contact Delta for more information.

Single-phase Motor

Single-phase motors are not suitable for being operated by an AC Motor Drive. Please use a 3-phase motor instead when necessary.

Environmental Conditions

Installation Position

1. The drive is suitable for installation in a place with ambient temperature from -10 to 50 .
2. The surface temperature of the drive and brake resistor will rise under specific operation conditions. Therefore, please install the drive on materials that are noncombustible.
3. Ensure that the installation site complies with the ambient conditions as stated in the manual.

Wiring

Limit of Wiring Distance

For the remote operation, please use twist-shielding cable and the distance between the drive and control box should be less than 20m.

Maximum Motor Cable Length

Motor cables that are too long may cause overheating of the drive or current peaks due to stray capacitance.

Please ensure that the motor cable is less than 30m.

If the cable length can't be reduced, please lower the carrier frequency or use an AC reactor.

Choose the Right Cable

Please refer to current value to choose the right cable section with enough capacity or use recommended cables.

Grounding

Please ground the drive completely by using the grounding terminal.

How to Choose the Drive Capacity

Standard Motor

Please select the drive according to applicable motor rated current listed in the drive specification.

Please select the next higher power AC drive in case higher starting torque or quick acceleration/deceleration is needed.

Special Motor

Please select the drive according to: Rated current of the drive > rated current of the motor

Transportation and Storage

Please transport and store the drive in a place that meets environment specifications.

Peripheral Equipment

Molded-Case Circuit Breakers (MCCB)

Please install the recommended MCCB or ELCB in the main circuit of the drive and make sure that the capacity of the breaker is equal to or lower than the recommended one.

Add a Magnetic Contactor(MC) in the Output Circuit

When a MC is installed in the output circuit of the drive to switch the motor to commercial power or other purposes, please make sure that the drive and motor are completely stopped and remove the surge absorbers from the MC before switching it.

Add a Magnetic Contactor (MC) in the Input Circuit

Please only switch the MC ONCE per hour or it may damage the drive. Please use RUN/STOP signal to switch many times during motor operation.

Motor Protection

The thermal protection function of the drive can be used to protect the motor by setting the operation level and motor type (standard motor or variable motor). When using a high-speed motor or a water-cooled motor the thermal time constant should be set to a lower value.

When using a longer cable to connect the motor thermal relay to a motor, high-frequency currents may enter via the stray capacitance.

It may result in malfunctioning of the relay as the real current is lower than the setting of thermal relay. Under this condition, please lower the carrier frequency or add an AC reactor to solve this.

DO NOT Use Capacitors to Improve the Power Factor

Use a DC reactor to improve the power factor of the drive. Please DO NOT install power factor correction capacitors on the main circuit of the drive to prevent motor faults due to over current.

Do NOT Use Surge Absorber

Please DO NOT install surge absorbers on the output circuit of the drive.

Lower the Noise

To ensure compliance with EMC regulations, usually a filter and shielded wiring is used to lower the noise.

Method Used to Reduce the Surge Current

Surge currents may occur in the phase-lead capacitor of the power system, causing an overvoltage when the drive is stopped or at low loads.

It is recommended to add a DC reactor to the drive.