

CATALOGO DE
ESQUEMAS NORMALIZADOS



INTERRUPTORES
CONMUTADORES

FUNCION ELECTRICA

Referencia	Descripción	Página
CONMUTADORES PARA APARATOS DE MEDIDA		
B-001	CONMUT. VOLTIM. 1 FASE 1 POLO	1
B-002	CONMUT. VOLTIM. 1 FASE 2 POLOS	1
B-003	CONMUT. VOLT. 2 FASES 2 POLOS	1
B-004	VOLTIMETRO 3 FASES ENTRE SI	1
B-005	VOLTIMETRO 3 FASES CON NEUTRO	1
B-006	VOLTIMETRO 2 POLOS 4 TENSIONES	1
B-007	VOLT. 3 F. ENTRE SI CON NEUTRO	2
B-008	VOLTIMETRO 2 LINEAS TRIFASICAS	2
B-009	VOLTIMETRO 2 POLOS 6 TENSIONES	2
B-010	VOLTIMET. 3 F. y F. CON NEUTRO	2
B-017	AMPERIMET. 3 TRAF. 3 F. UNIP.	2
B-018	AMPERIMET. 2 TRAF. 3 F. UNIP.	3
B-019	AMPERIM. 2 y 3 TRAF. 3 F. UNIP.	3
B-020	AMPERIMETRO 2 BOBINAS 1 POLO	3
B-021	AMPERIMETRO 3 FASES SIN NEUTRO	3
B-030	VOLTIMETRO y AMPERIMETRO	3
B-031	VOLTIM. y AMPERIM. C/TRANSF.	4
B-032	VOLTIM. y AMPERIM. 2 F. 1 BOB. 1 VOLT.	3
B-033	VOLTIM. y AMPERIM. C/NEUTRO	4
B-034	VOLTIM. y AMPERIM. C/NEUTRO	4
B-035	VOLTIM. y AMPERIM. C/TRANSF.	5
B-036	AMPERIMETRO 4 TRAF. 4 C. UNIP.	5
B-038	AMPERIMET. 3 TRAF. 3 C. BIPOL.	5
B-039	AMPERIMET. 4 TRAF. 4 C. BIPOL.	6
B-043	CONMUTADOR DE WATIMETRO	6
B-046	AMPERIM. 1 TRAF. CONEX. UNIP.	6
B-047	AMPERIM. 2 TRAF. CONEX. UNIP.	6
B-048	AMPERIM. 3 TRAF. CONEX. UNIP.	7
B-050	FACTOR DE POTENCIA 1 BOBINA	7
B-051	FACTOR DE POTENCIA 2 BOBINAS	7
B-053	FACTOR DE POTENCIA 2 LINEAS TRIFAS	7
B-060	CONMUTADOR SINCRONIZADOR	7
MANIPULADORES		
B-172	MANIP. 2 POLOS CERR. C/RETOR.	8
B-173	MANIP. 2 POLOS ABIER. C/RETOR.	8
B-174	MANIP. 1 POLO ABIERTO C/RETOR.	8
B-175	MANIP. 1 POLO CERRADO C/RETOR.	8
B-176	MANIPULADOR PARO-MARCHA	8
B-177	MANIP. PARO-MARCHA 2 CONTACT.	8
B-178	MANIP. CONTACTOR PARO-MARCHA	8
B-179	MANIPULADOR 2 CONTACTORES	8
B-180	MANIPULADOR EST-TRIANG	9
B-181	MANIP. EST.-TRIAN. C/INVERSION	9
B-182	MANIP. MOTOR 2 VELOC.DAHLANDER	9
INTERRUPTORES		
B-200	INTERRUPTOR UNIPOLAR	10
B-201	INTERRUPTOR BIPOLAR	10
B-202	INTERRUPTOR TRIPOLAR	10
B-203	INTERRUPTOR TETRAPOLAR	10
B-204	INTERRUPTOR UNIPOLAR C/RETORNO	10
B-205	INTERRUPTOR BIPOLAR C/RETORNO	10
B-206	INTERRUPTOR TRIPOLAR C/RETORNO	10
B-207	INTERRUP. TETRAPOLAR C/RETORNO	10
B-290	INTERRUPTOR UNIPOLAR a 90°	11
B-291	INTERRUPTOR BIPOLAR a 90°	11

FUNCION ELECTRICA

Referencia	Descripción	Página
B-292	INTERRUPTOR TRIPOLAR a 90°	11
B-293	INTERRUPTOR TETRAPOLAR a 90°	11
INVERSORES		
B-227	INVERSOR BIPOLAR C/RETORNO a 0	12
B-228	INVERSOR TRIPOLAR C/RETOR. a 0	12
B-400	INVERSOR BIPOLAR	12
B-401	INVERSOR TRIPOLAR	12
CONMUTADORES CON POSICION "0"		
B-210	CONMUTADOR UNIPOLAR 1-0-2	13
B-211	CONMUTADOR BIPOLAR 1-0-2	13
B-212	CONMUTADOR TRIPOLAR 1-0-2	13
B-213	CONMUTADOR TETRAPOLAR 1-0-2	13
B-214	CONMUT. UNIPOLAR 1-0-2 C/RETOR	13
B-215	CONMUT. BIPOLAR 1-0-2 C/RETOR.	13
B-216	CONMUT. TRIPOLAR 1-0-2 C/RETOR	13
B-218	CONMUT. UNIPOLAR 1-0-2 a 90°	14
B-219	CONMUT. BIPOLAR 1-0-2 a 90°	14
B-294	CONMUTADOR TETRAPOLAR 1-0-2 a 90°	14
B-299	CONMUTADOR TRIPOLAR 1-0-2 a 90°	14
CONMUTADORES SIN POSICION "0"		
B-220	CONMUTADOR UNIPOLAR 1-2	15
B-221	CONMUTADOR BIPOLAR 1-2	15
B-222	CONMUTADOR TRIPOLAR 1-2	15
B-223	CONMUTADOR TETRAPOLAR 1-2	15
B-295	CONMUT. UNIPOLAR 1-2 C/RETORNO	15
B-296	CONMUT. BIPOLAR 1-2 C/RETORNO	15
B-297	CONMUT. TRIPOLAR 1-2 C/RETORNO	16
B-298	CONMUT. TETRAPOLAR 1-2 C/RETORNO	16
CONMUTADORES DE POSICIONES SIN POSICION "0"		
B-230	CONMUTADOR UNIPOLAR 1-2-3	17
B-231	CONMUTADOR UNIPOLAR 1-2-3-4	17
B-232	CONMUTADOR UNIPOLAR 1-2-3-4-5	17
B-233	CONMUT. UNIPOLAR del 1 al 6	17
B-234	CONMUT. UNIPOLAR del 1 al 7	17
B-235	CONMUT. UNIPOLAR del 1 al 8	18
B-236	CONMUT. UNIPOLAR del 1 al 9	18
B-237	CONMUT. UNIPOLAR del 1 al 10	18
B-238	CONMUT. UNIPOLAR del 1 al 11	19
B-239	CONMUT. UNIPOLAR del 1 al 12	19
B-250	CONMUTADOR BIPOLAR 1-2-3	22
B-251	CONMUTADOR BIPOLAR 1-2-3-4	23
B-252	CONMUTADOR BIPOLAR 1-2-3-4-5	23
B-253	CONMUTADOR BIPOLAR 1-2-3-4-5-6	23
B-254	CONMUT. BIPOLAR 1-2-3-4-5-6-7	23
B-255	CONMUT. BIPOLAR del 1 al 8	24
B-256	CONMUT. BIPOLAR del 1 al 9	24
B-257	CONMUT. BIPOLAR del 1 al 10	25
B-258	CONMUT. BIPOLAR del 1 al 11	25
B-259	CONMUT. BIPOLAR del 1 al 12	26
B-270	CONMUTADOR TRIPOLAR 1-2-3	30
B-271	CONMUTADOR TRIPOLAR 1-2-3-4	30
B-272	CONMUTADOR TRIPOLAR 1-2-3-4-5	31
B-273	CONMUT. TRIPOLAR 1-2-3-4-5-6	31
B-274	CONMUT. TRIPOLAR 1-2-3-4-5-6-7	32
B-275	CONMUT. TRIPOLAR del 1 al 8	32

FUNCION ELECTRICA

FUNCION ELECTRICA

Referencia	Descripción	Página	Referencia	Descripción	Página
CONMUADORES DE POSICIONES CON POSICION "0"			CONMUTADORES DE POLOS 2 VELOCIDADES		
B-240	CONMUTADOR UNIPOLAR 0-1-2	20	B-440	CONM. 2 VELOC. 1 DEVAN. 0-1-2	41
B-241	CONMUTADOR UNIPOLAR 0-1-2-3	20	B-441	CONM. 2 VELOC. 1 DEVAN. 1-0-2	42
B-242	CONMUTADOR UNIPOLAR 0-1-2-3-4	20	B-442	CONM. 2 VEL. C/INV. 2-1-0-1-2	42
B-243	CONMUT. UNIPOLAR 0-1-2-3-4-5	20	B-443	CONM. 2 VELOC. GIRO 1 DIRECC.	42
B-244	CONMUT. UNIPOLAR 0-1-2-3-4-5-6	20	B-444	CONM. 2 VELOC. para CONTACTOR	42
B-245	CONMUT. UNIPOLAR del 0 al 7	21	B-445	CONMUT. 2 VELOC. 0-ESTR.-1-2	43
B-246	CONMUT. UNIPOLAR del 0 al 8	21	B-446	CONMUT. 2 VELOC. C/INVERSION	43
B-247	CONMUT. UNIPOLAR del 0 al 9	21	B-449	CONMUT. 2 VELOC. ARROLL. SEPAR.	43
B-248	CONMUT. UNIPOLAR del 0 al 10	22	B-450	CONM. 2 VELOC. 2 DEVAN. 0-1-2	43
B-249	CONMUT. UNIPOLAR del 0 al 11	22	B-451	CONMUT. 2 VELOCIDADES 0-1-2	44
B-260	CONMUTADOR BIPOLAR 0-1-2	26	B-453	CONMUTADOR 0-1-2 C/INVERSION	44
B-261	CONMUTADOR BIPOLAR 0-1-2-3	26	B-454	CONM. 2 VEL. ARR. en EST.-TRI.	44
B-262	CONMUTADOR BIPOLAR 0-1-2-3-4	27	CONMUTADORES DE POLOS 3 VELOCIDADES		
B-263	CONMUTADOR BIPOLAR 0-1-2-3-4-5	27	B-455	CONMUT. 3 VELOCIDADES 0-1-2-3	44
B-264	CONMUT. BIPOLAR 0-1-2-3-4-5-6	27	B-456	CONM.3 VEL 3-2-1-2-1-2-3 C/INV	45
B-265	CONMUT. BIPOLAR del 0 al 7	28	B-457	CONMUT. 3 VELOCIDADES 0-1-2-3	45
B-266	CONMUT. BIPOLAR del 0 al 8	28	B-458	CONMUT. 3 VELOCIDADES C/INVER	45
B-267	CONMUT. BIPOLAR del 0 al 9	29	B-459	CONMUT. 3 VELOCIDADES 0-1-2-3	45
B-268	CONMUT. BIPOLAR del 0 al 10	29	B-460	CONM.3 VEL 3-2-1-2-1-2-3 C/INV	46
B-269	CONMUT. BIPOLAR del 0 al 11	30	B-601	CONMUT. 3 VELOCIDADES 0-1-2-3	46
B-280	CONMUTADOR TRIPOLAR 0-1-2	33	B-602	CONMUT. 3 VELOCIDADES 0-1-2-3	46
B-281	CONMUTADOR TRIPOLAR 0-1-2-3	33	B-603	CONMUT. 3 VELOCIDADES 0-1-2-3	46
B-282	CONMUTADOR TRIPOLAR 0-1-2-3-4	33	B-605	CONMUT. 3 VELOCIDADES 0-1-2-3	47
B-283	CONMUT. TRIPOLAR 0-1-2-3-4-5	34	B-606	CONMUT. 3 VELOCIDADES 0-1-2-3	47
B-284	CONMUT. TRIPOLAR 0-1-2-3-4-5-6	34	B-607	CONMUT. 3 VELOCIDADES 0-1-2-3	47
B-285	CONMUT. TRIPOLAR del 0 al 7	35	B-608	CONMUT. 3 VELOCIDADES 0-1-2-3	47
CONMUTADORES DE GRUPO, SERIE Y PARALELO			B-609	CONMUT. 3 VELOCIDADES 0-1-2-3	48
B-310	CONMUTADOR 2 GRUPOS UNIPOLAR	36	B-610	CONMUT. 3 VELOCIDADES 0-1-2-3	48
B-311	CONMUTADOR 3 GRUPOS UNIPOLAR	36	B-613	CONMUT. 3 VELOCIDADES 0-1-2-3	48
B-312	CONMUTADOR 2 GRUPOS BIPOLAR	36	B-614	CONMUT. 3 VELOCIDADES 0-1-2-3	48
B-313	CONMUTADOR 3 GRUPOS BIPOLAR	36	B-615	CONMUT. 3 VELOCIDADES 0-1-2-3	49
B-314	CONMUTADOR 2 GRUPOS TRIPOLAR	36	B-616	CONMUT. 3 VELOCIDADES 0-1-2-3	49
B-315	CONMUTADOR 3 GRUPOS TRIPOLAR	37	B-617	CONMUT. 3 VELOCIDADES 0-1-2-3	49
B-316	CONMUTADOR 3 GRUPOS EST.-TRIAN	36	B-618	CONMUT. 3 VELOCIDADES 0-1-2-3	49
B-330	CONMUT. 2 GRUPOS SERIE UNIPOLAR	37	CONMUTADORES DE POLOS 4 VELOCIDADES		
B-331	CONMUT. 2 GRUPOS SERIE BIPOLAR	37	B-461	CONMUT. 4 VELOC. 0-1-2-3-4	50
B-332	CONMUT. 2 GRUPOS SERIE TRIPOLAR	37	B-462	CONMUT. 4 VELOC. C/INVERS	50
B-340	CONMUT. GRUP.SERIE-PARAL.TRI.	37	B-604	CONMUT. 4 VELOCIDADES 0-1-2-3-4	50
CONMUTADORES ESTRELLA-TRIANGULO			B-611	CONMUT. 4 VELOCIDADES 0-1-2-3-4	51
B-410	ESTRELLA-TRIANGULO NORMAL	38	B-612	CONMUT. 4 VELOCIDADES 0-1-2-3-4	51
B-411	ESTRELLA-TRIANG. RETORNO a 0	38	B-619	CONMUT. 4 VELOCIDADES 0-1-2-3-4	51
B-412	EST.-TRIAN. RETOR. y POS.FRENO	38	B-620	CONMUT. 4 VELOCIDADES 0-1-2-3-4	52
B-413	ESTR.-TRIANG. NORMAL C/INVERS.	38	CONTROLLERS		
B-414	CONMUT.ESTR.-TRIANG.INV.C/RET.	39	B-464	CONTROLLERS	52
B-415	CONMUT.ESTR.-TRIANG.GIRO EN 1 DIR.	39	B-465	CONTROLLERS	52
B-416	ESTR.TRIANG.CONTACT.CERR.POS.0	39			
B-417	ESTRELLA-TRIANGULO SELECTOR	39			
B-418	ESTRELLA-TRIANGULO CONTACTOR	40			
B-419	EST.TRIANG.SIMPLIF. para CONT.	40			
B-420	ESTR.TRIANG. C/CONTACT. e INV.	40			
B-425	ARRANCADOR C/RETOR. MANIVELA 1	41			
B-426	ARRANCADOR CON INVERSION	41			
B-427	ARRANCADOR a 125 y 220 A.	41			
B-622	ARRANCADOR MOTOR MONO C/INVER.	41			

Ref.	Pag.	Descripción
B-001	1	CONMUT. VOLTIM. 1 FASE 1 POLO
B-002	1	CONMUT. VOLTIM. 1 FASE 2 POLOS
B-003	1	CONMUT. VOLT. 2 FASES 2 POLOS
B-004	1	VOLTIMETRO 3 FASES ENTRE SI
B-005	1	VOLTIMETRO 3 FASES CON NEUTRO
B-006	1	VOLTIMETRO 2 POLOS 4 TENSIONES
B-007	2	VOLT. 3 F. ENTRE SI CON NEUTRO
B-008	2	VOLTIMETRO 2 LINEAS TRIFASICAS
B-009	2	VOLTIMETRO 2 POLOS 6 TENSIONES
B-010	2	VOLTIMET. 3 F. y F. CON NEUTRO
B-017	2	AMPERIMET. 3 TRAF. 3 F. UNIP.
B-018	3	AMPERIMET. 2 TRAF. 3 F. UNIP.
B-019	3	AMPERIM. 2 y 3 TRAF. 3 F. UNIP.
B-020	3	AMPERIMETRO 2 BOBINAS 1 POLO
B-021	3	AMPERIMETRO 3 FASES SIN NEUTRO
B-030	3	VOLTIMETRO y AMPERIMETRO
B-031	4	VOLTIM. y AMPERIM. C/TRANSF.
B-032	3	VOLTIM. y AMPERIM. 2 F. 1 BOB. 1 VOLT.
B-033	4	VOLTIM. y AMPERIM. C/NEUTRO
B-034	4	VOLTIM. y AMPERIM. C/NEUTRO
B-035	5	VOLTIM. y AMPERIM. C/TRANSF.
B-036	5	AMPERIMETRO 4 TRAF. 4 C. UNIP.
B-038	5	AMPERIMET. 3 TRAF. 3 C. BIPOL.
B-039	6	AMPERIMET. 4 TRAF. 4 C. BIPOL.
B-043	6	CONMUTADOR DE WATIMETRO
B-046	6	AMPERIM. 1 TRAF. CONEX. UNIP.
B-047	6	AMPERIM. 2 TRAF. CONEX. UNIP.
B-048	7	AMPERIM. 3 TRAF. CONEX. UNIP.
B-050	7	FACTOR DE POTENCIA 1 BOBINA
B-051	7	FACTOR DE POTENCIA 2 BOBINAS
B-053	7	FACTOR DE POTENCIA 2 LINEAS TRIFAS.
B-060	7	CONMUTADOR SINCRONIZADOR
B-172	8	MANIP. 2 POLOS CERR. C/RETOR.
B-173	8	MANIP. 2 POLOS ABIER. C/RETOR.
B-174	8	MANIP. 1 POLO ABIERTO C/RETOR.
B-175	8	MANIP. 1 POLO CERRADO C/RETOR.
B-176	8	MANIPULADOR PARO-MARCHA
B-177	8	MANIP. PARO-MARCHA 2 CONTACT.
B-178	8	MANIP. CONTACTOR PARO-MARCHA
B-179	8	MANIPULADOR 2 CONTACTORES
B-180	9	MANIPULADOR EST-TRIANG
B-181	9	MANIP. EST.-TRIAN. C/INVERSION
B-182	9	MANIP. MOTOR 2 VELOC.DAHLANDER
B-200	10	INTERRUPTOR UNIPOLAR
B-201	10	INTERRUPTOR BIPOLAR
B-202	10	INTERRUPTOR TRIPOLAR
B-203	10	INTERRUPTOR TETRAPOLAR
B-204	10	INTERRUPTOR UNIPOLAR C/RETORNO
B-205	10	INTERRUPTOR BIPOLAR C/RETORNO

Ref.	Pag.	Descripción
B-206	10	INTERRUPTOR TRIPOLAR C/RETORNO
B-207	10	INTERRUP. TETRAPOLAR C/RETORNO
B-210	13	CONMUTADOR UNIPOLAR 1-0-2
B-211	13	CONMUTADOR BIPOLAR 1-0-2
B-212	13	CONMUTADOR TRIPOLAR 1-0-2
B-213	13	CONMUTADOR TETRAPOLAR 1-0-2
B-214	13	CONMUT. UNIPOLAR 1-0-2 C/RETOR
B-215	13	CONMUT. BIPOLAR 1-0-2 C/RETOR.
B-216	13	CONMUT. TRIPOLAR 1-0-2 C/RETOR
B-218	14	CONMUT. UNIPOLAR 1-0-2 a 90°
B-219	14	CONMUT. BIPOLAR 1-0-2 a 90°
B-220	15	CONMUTADOR UNIPOLAR 1-2
B-221	15	CONMUTADOR BIPOLAR 1-2
B-222	15	CONMUTADOR TRIPOLAR 1-2
B-223	15	CONMUTADOR TETRAPOLAR 1-2
B-227	12	INVERSOR BIPOLAR C/RETORNO a 0
B-228	12	INVERSOR TRIPOLAR C/RETOR. a 0
B-230	17	CONMUTADOR UNIPOLAR 1-2-3
B-231	17	CONMUTADOR UNIPOLAR 1-2-3-4
B-232	17	CONMUTADOR UNIPOLAR 1-2-3-4-5
B-233	17	CONMUT. UNIPOLAR del 1 al 6
B-234	17	CONMUT. UNIPOLAR del 1 al 7
B-235	18	CONMUT. UNIPOLAR del 1 al 8
B-236	18	CONMUT. UNIPOLAR del 1 al 9
B-237	18	CONMUT. UNIPOLAR del 1 al 10
B-238	19	CONMUT. UNIPOLAR del 1 al 11
B-239	19	CONMUT. UNIPOLAR del 1 al 12
B-240	20	CONMUTADOR UNIPOLAR 0-1-2
B-241	20	CONMUTADOR UNIPOLAR 0-1-2-3
B-242	20	CONMUTADOR UNIPOLAR 0-1-2-3-4
B-243	20	CONMUT. UNIPOLAR 0-1-2-3-4-5
B-244	20	CONMUT. UNIPOLAR 0-1-2-3-4-5-6
B-245	21	CONMUT. UNIPOLAR del 0 al 7
B-246	21	CONMUT. UNIPOLAR del 0 al 8
B-247	21	CONMUT. UNIPOLAR del 0 al 9
B-248	22	CONMUT. UNIPOLAR del 0 al 10
B-249	22	CONMUT. UNIPOLAR del 0 al 11
B-250	22	CONMUTADOR BIPOLAR 1-2-3
B-251	23	CONMUTADOR BIPOLAR 1-2-3-4
B-252	23	CONMUTADOR BIPOLAR 1-2-3-4-5
B-253	23	CONMUTADOR BIPOLAR 1-2-3-4-5-6
B-254	23	CONMUT. BIPOLAR 1-2-3-4-5-6-7
B-255	24	CONMUT. BIPOLAR del 1 al 8
B-256	24	CONMUT. BIPOLAR del 1 al 9
B-257	25	CONMUT. BIPOLAR del 1 al 10
B-258	25	CONMUT. BIPOLAR del 1 al 11
B-259	26	CONMUT. BIPOLAR del 1 al 12
B-260	26	CONMUTADOR BIPOLAR 0-1-2
B-261	26	CONMUTADOR BIPOLAR 0-1-2-3



Ref.	Pag.	Descripción
B-262	27	CONMUTADOR BIPOLAR 0-1-2-3-4
B-263	27	CONMUTADOR BIPOLAR 0-1-2-3-4-5
B-264	27	CONMUT. BIPOLAR 0-1-2-3-4-5-6
B-265	28	CONMUT. BIPOLAR del 0 al 7
B-266	28	CONMUT. BIPOLAR del 0 al 8
B-267	29	CONMUT. BIPOLAR del 0 al 9
B-268	29	CONMUT. BIPOLAR del 0 al 10
B-269	30	CONMUT. BIPOLAR del 0 al 11
B-270	30	CONMUTADOR TRIPOLAR 1-2-3
B-271	30	CONMUTADOR TRIPOLAR 1-2-3-4
B-272	31	CONMUTADOR TRIPOLAR 1-2-3-4-5
B-273	31	CONMUT. TRIPOLAR 1-2-3-4-5-6
B-274	32	CONMUT. TRIPOLAR 1-2-3-4-5-6-7
B-275	32	CONMUT. TRIPOLAR del 1 al 8
B-280	33	CONMUTADOR TRIPOLAR 0-1-2
B-281	33	CONMUTADOR TRIPOLAR 0-1-2-3
B-282	33	CONMUTADOR TRIPOLAR 0-1-2-3-4
B-283	34	CONMUT. TRIPOLAR 0-1-2-3-4-5
B-284	34	CONMUT. TRIPOLAR 0-1-2-3-4-5-6
B-285	35	CONMUT. TRIPOLAR del 0 al 7
B-290	11	INTERRUPTOR UNIPOLAR a 90°
B-291	11	INTERRUPTOR BIPOLAR a 90°
B-292	11	INTERRUPTOR TRIPOLAR a 90°
B-293	11	INTERRUPTOR TETRAPOLAR a 90°
B-294	14	CONMUTADOR TETRAPOLAR 1-0-2 a 90°
B-295	15	CONMUT. UNIPOLAR 1-2 C/RETORNO
B-296	15	CONMUT. BIPOLAR 1-2 C/RETORNO
B-297	16	CONMUT. TRIPOLAR 1-2 C/RETORNO
B-298	16	CONMUT. TETRAPOLAR 1-2 C/RETORNO
B-299	14	CONMUTADOR TRIPOLAR 1-0-2 a 90°
B-310	36	CONMUTADOR 2 GRUPOS UNIPOLAR
B-311	36	CONMUTADOR 3 GRUPOS UNIPOLAR
B-312	36	CONMUTADOR 2 GRUPOS BIPOLAR
B-313	36	CONMUTADOR 3 GRUPOS BIPOLAR
B-314	36	CONMUTADOR 2 GRUPOS TRIPOLAR
B-315	37	CONMUTADOR 3 GRUPOS TRIPOLAR
B-316	36	CONMUTADOR 3 GRUPOS EST.-TRIAN
B-330	37	CONMUT. 2 GRUPOS SERIE UNIPOLAR
B-331	37	CONMUT. 2 GRUPOS SERIE BIPOLAR
B-332	37	CONMUT. 2 GRUPOS SERIE TRIPOLAR
B-340	37	CONMUT. GRUP.SERIE-PARAL.TRI.
B-400	12	INVERSOR BIPOLAR
B-401	12	INVERSOR TRIPOLAR
B-410	38	ESTRELLA-TRIANGULO NORMAL
B-411	38	ESTRELLA-TRIANG. RETORNO a 0
B-412	38	EST.-TRIAN. RETOR. y POS.FRENO
B-413	38	ESTR.-TRIANG. NORMAL C/INVERS.
B-414	39	CONMUT.ESTR.-TRIANG.INV.C/RET.
B-415	39	CONMUT.ESTR.-TRIANG.GIRO EN 1 DIR.
B-416	39	ESTR.TRIANG.CONTACT.CERR.POS.0

Ref.	Pag.	Descripción
B-417	39	ESTRELLA-TRIANGULO SELECTOR
B-418	40	ESTRELLA-TRIANGULO CONTACTOR
B-419	40	EST.TRIANG.SIMPLIF. para CONT.
B-420	40	ESTR.TRIANG. C/CONTACT. e INV.
B-425	41	ARRANCADOR C/RETOR. MANIVELA 1
B-426	41	ARRANCADOR CON INVERSION
B-427	41	ARRANCADOR a 125 y 220 A.
B-440	41	CONM. 2 VELOC. 1 DEVAN. 0-1-2
B-441	42	CONM. 2 VELOC. 1 DEVAN. 1-0-2
B-442	42	CONM. 2 VEL. C/INV. 2-1-0-1-2
B-443	42	CONM. 2 VELOC. GIRO 1 DIRECC.
B-444	42	CONM. 2 VELOC. para CONTACTOR
B-445	43	CONMUT. 2 VELOC. 0-ESTR.-1-2
B-446	43	CONMUT. 2 VELOC. C/INVERSION
B-449	43	CONMUT. 2 VELOC. ARROLL. SEPAR.
B-450	43	CONM. 2 VELOC. 2 DEVAN. 0-1-2
B-451	44	CONMUT. 2 VELOCIDADES 0-1-2
B-453	44	CONMUTADOR 0-1-2 C/INVERSION
B-454	44	CONM. 2 VEL. ARR. en EST.-TRI.
B-455	44	CONMUT. 3 VELOCIDADES 0-1-2-3
B-456	45	CONM.3 VEL 3-2-1-2-1-2-3 C/INV
B-457	45	CONMUT. 3 VELOCIDADES 0-1-2-3
B-458	45	CONMUT. 3 VELOCIDADES C/INVER
B-459	45	CONMUT. 3 VELOCIDADES 0-1-2-3
B-460	46	CONM.3 VEL 3-2-1-2-1-2-3 C/INV
B-461	50	CONMUT. 4 VELOC. 0-1-2-3-4
B-462	50	CONMUT. 4 VELOC. C/INVERS
B-464	52	CONTROLLERS
B-465	52	CONTROLLERS
B-601	46	CONMUT. 3 VELOCIDADES 0-1-2-3
B-602	46	CONMUT. 3 VELOCIDADES 0-1-2-3
B-603	46	CONMUT. 3 VELOCIDADES 0-1-2-3
B-604	50	CONMUT. 4 VELOCIDADES 0-1-2-3-4
B-605	47	CONMUT. 3 VELOCIDADES 0-1-2-3
B-606	47	CONMUT. 3 VELOCIDADES 0-1-2-3
B-607	47	CONMUT. 3 VELOCIDADES 0-1-2-3
B-608	47	CONMUT. 3 VELOCIDADES 0-1-2-3
B-609	48	CONMUT. 3 VELOCIDADES 0-1-2-3
B-610	48	CONMUT. 3 VELOCIDADES 0-1-2-3
B-611	51	CONMUT. 4 VELOCIDADES 0-1-2-3-4
B-612	51	CONMUT. 4 VELOCIDADES 0-1-2-3-4
B-613	48	CONMUT. 3 VELOCIDADES 0-1-2-3
B-614	48	CONMUT. 3 VELOCIDADES 0-1-2-3
B-615	49	CONMUT. 3 VELOCIDADES 0-1-2-3
B-616	49	CONMUT. 3 VELOCIDADES 0-1-2-3
B-617	49	CONMUT. 3 VELOCIDADES 0-1-2-3
B-618	49	CONMUT. 3 VELOCIDADES 0-1-2-3
B-619	51	CONMUT. 4 VELOCIDADES 0-1-2-3-4
B-620	52	CONMUT. 4 VELOCIDADES 0-1-2-3-4
B-622	41	ARRANCADOR MOTOR MONO C/INVER.

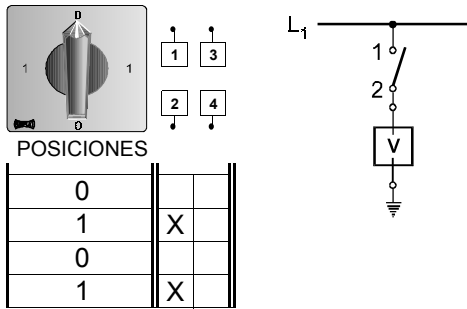

B-001 VOLTIMETRO
1 Fase c.a. 1 Polo c.c.
1 Piso

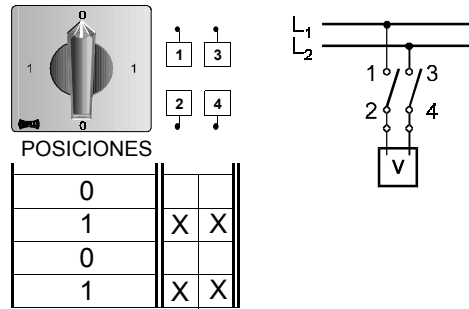

B-002 VOLTIMETRO
1 Fase c.a. 2 Polos c.c.
1 Piso

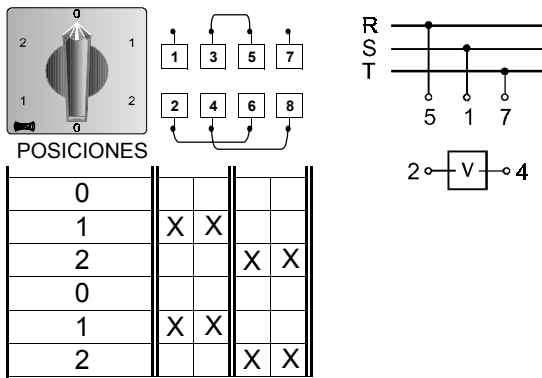

B-003 VOLTIMETRO
2 Fases c.a. 2 Polos c.c.
2 Pisos

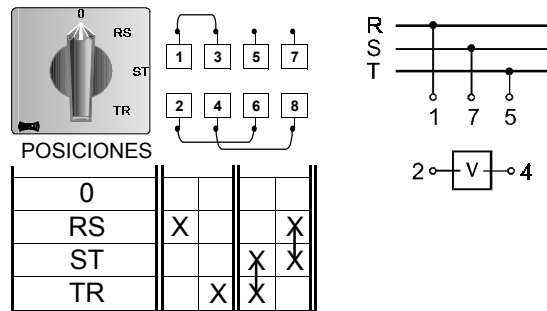

B-004 VOLTIMETRO
3 Fases entre sí
2 Pisos

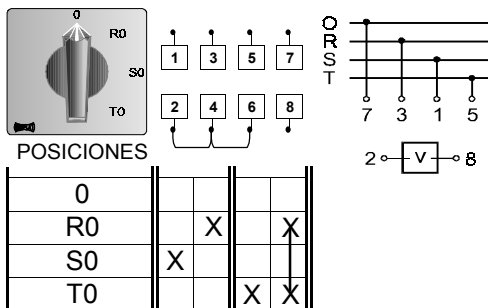

B-005 VOLTIMETRO
3 Fases con neutro
2 Pisos

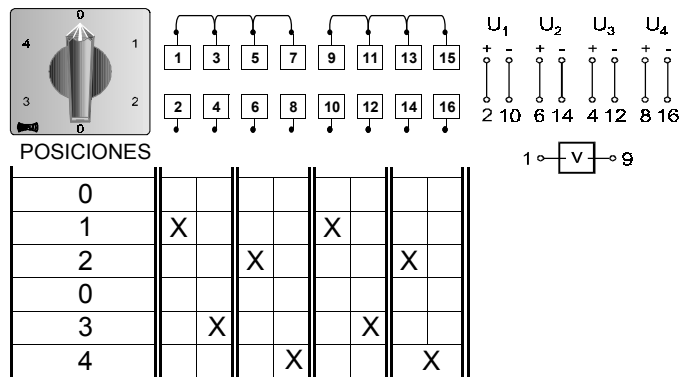

B-006 VOLTIMETRO
2 Polos 4 Tensiones
4 Pisos

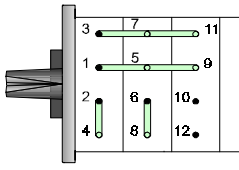
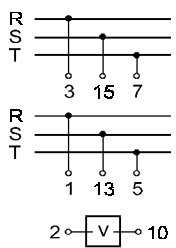
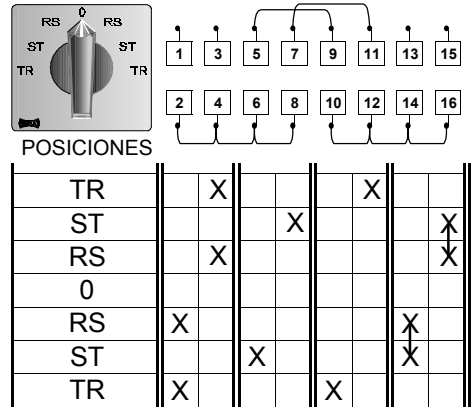
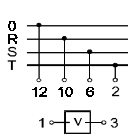
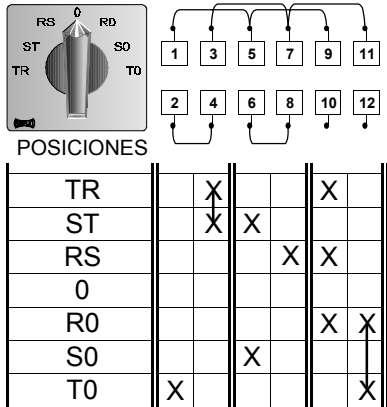

B-007 VOLTIMETRO
3 Fases entre si y cada fase con neutro
3 Pisos

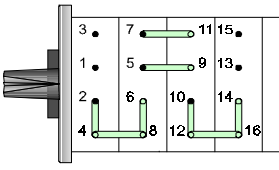

B-008 VOLTIMETRO
2 Líneas Trifásicas
4 Pisos

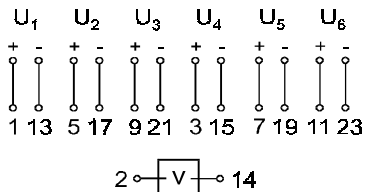
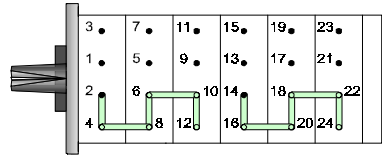
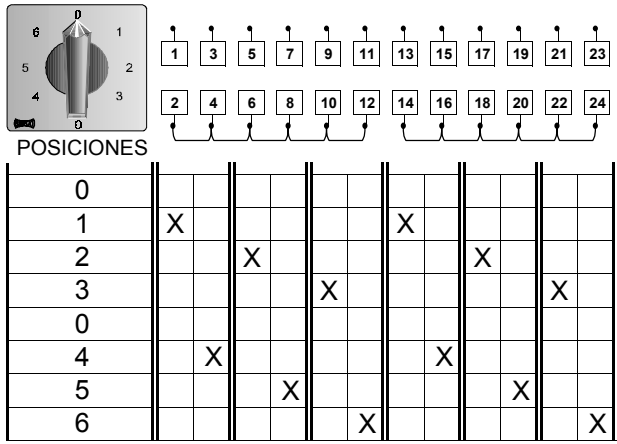

B-009 VOLTIMETRO
2 Polos 6 Tensiones
6 Pisos

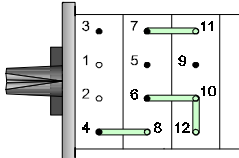
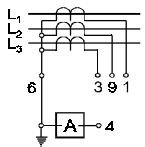
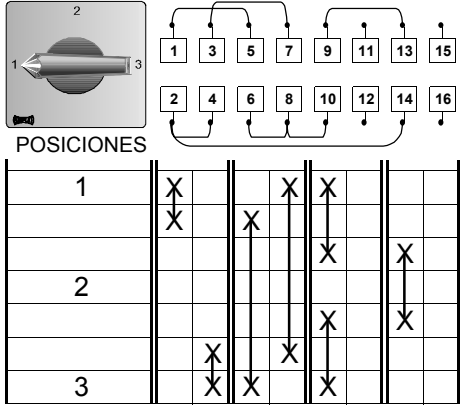
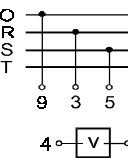
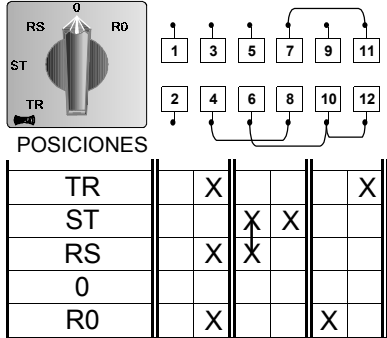

B-010 VOLTIMETRO
3 Fases entre si y 1 Fase con neutro
3 Pisos

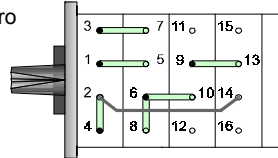

B-017 AMPERIMETRO
3 Bobinas, 3 Fases Unipolar
4 Pisos

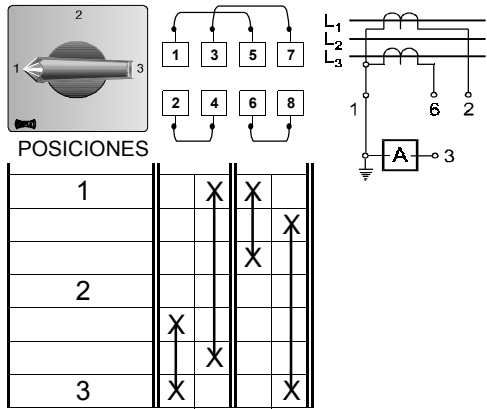

B-018 AMPERIMETRO
2 Bobinas 3 Fases Unipolar
2 Pisos

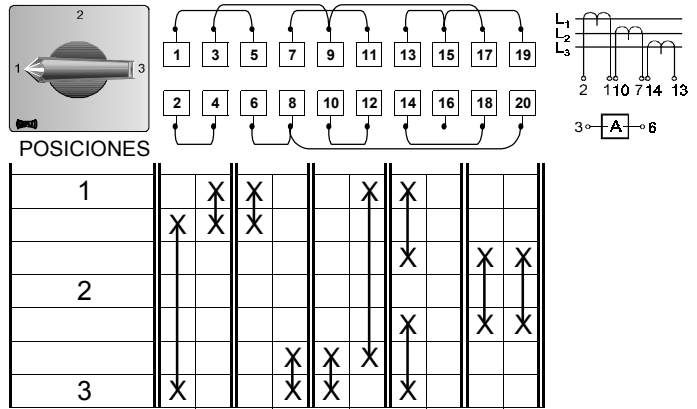

B-019 AMPERIMETRO
3 Fases, Especial
5 Pisos

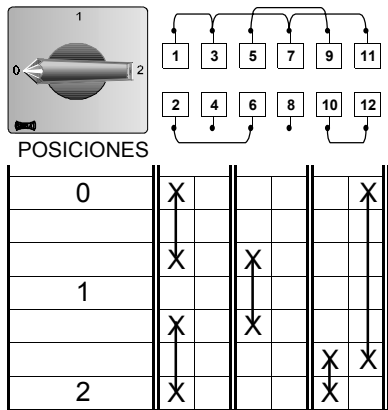
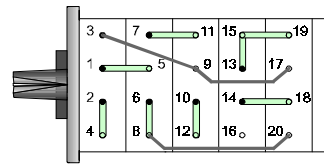
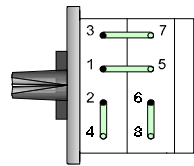

B-020 AMPERIMETRO
2 Bobinas 1 Polo
3 Pisos

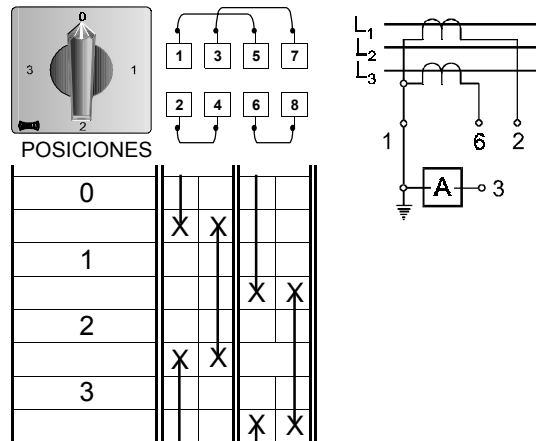

B-021 AMPERIMETRO
3 Fases sin neutro
2 Pisos

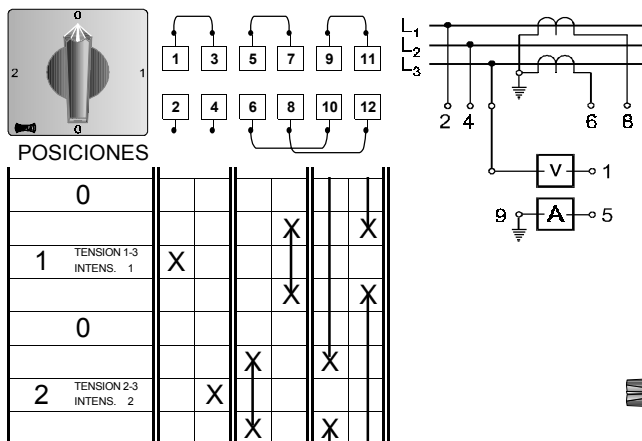
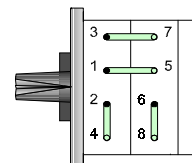
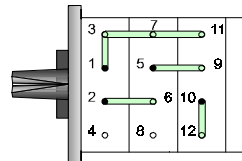

B-030 VOLTIMETRO AMPERIMETRO
3 Fases 2 Bobinas 2 Voltajes
3 Pisos

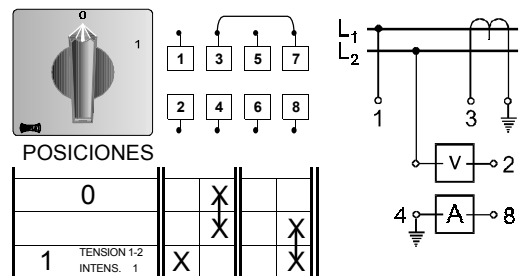

B-032 VOLTIMETRO AMPERIM.
2 Fases 1 Bobina 1 Voltaje
2 Pisos

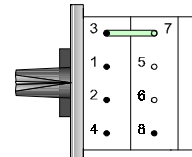
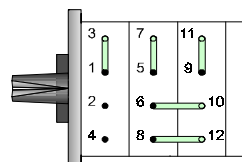

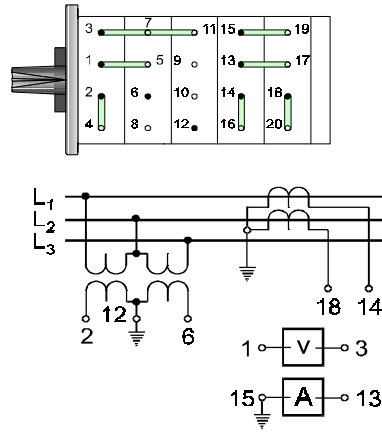
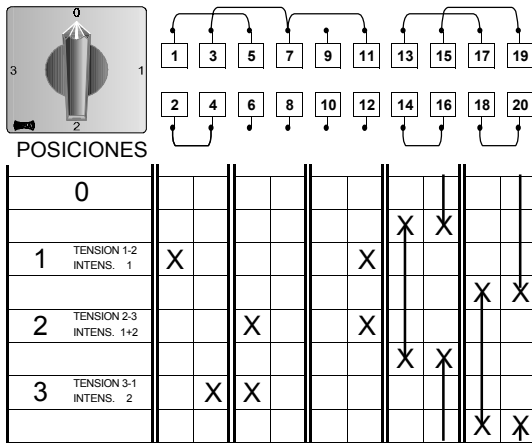

B-031 VOLTIMETRO AMPERIMETRO
3 Fases 2 Bobinas Voltímetro con Transformador
5 Pisos

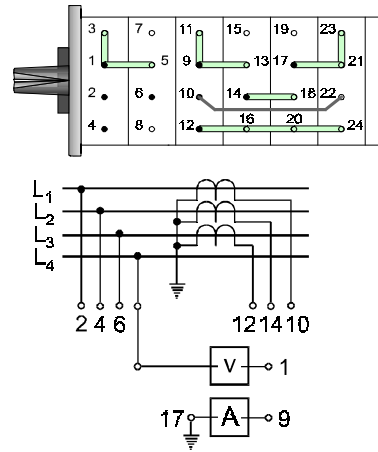
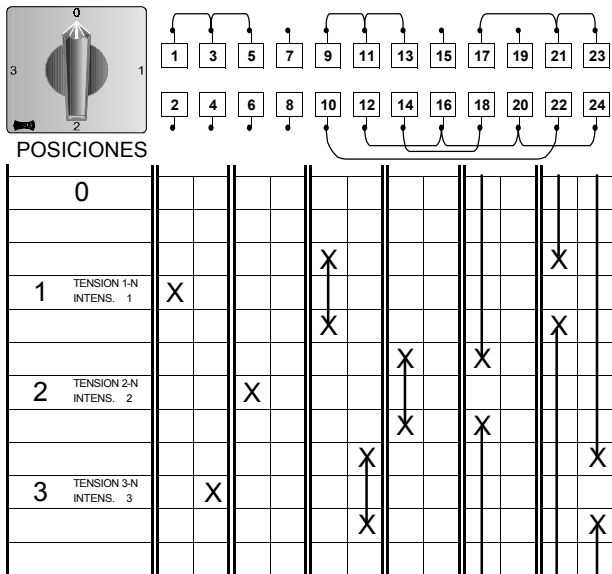

B-033 VOLTIMETRO AMPERIMETRO
3 Fases y neutro 3 Bobinas
6 Pisos

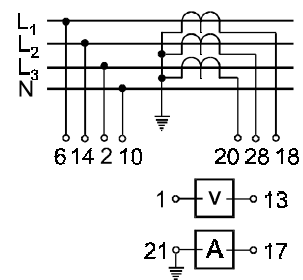
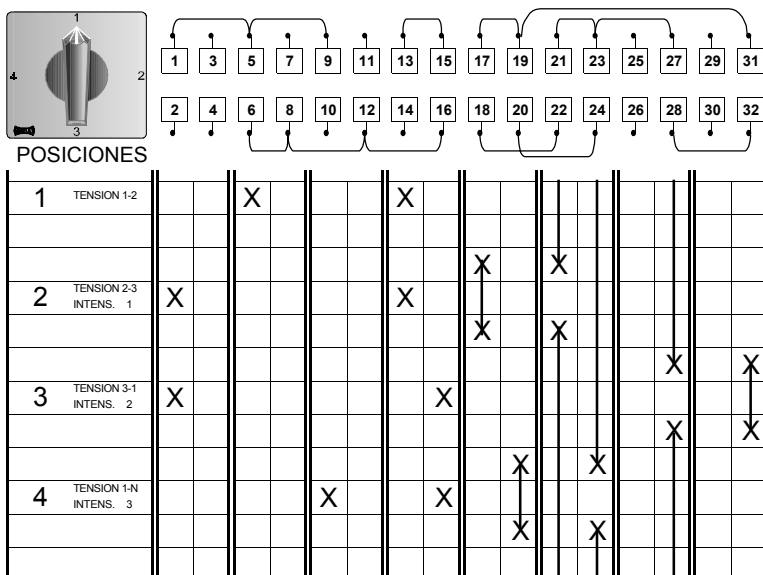

B-034 VOLTIMETRO AMPERIMETRO
3 Fases y neutro 3 Bobinas 4 Voltajes
8 Pisos

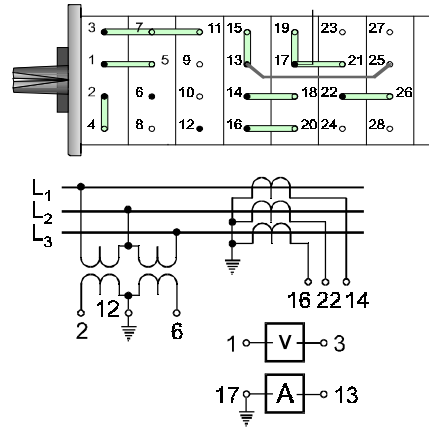
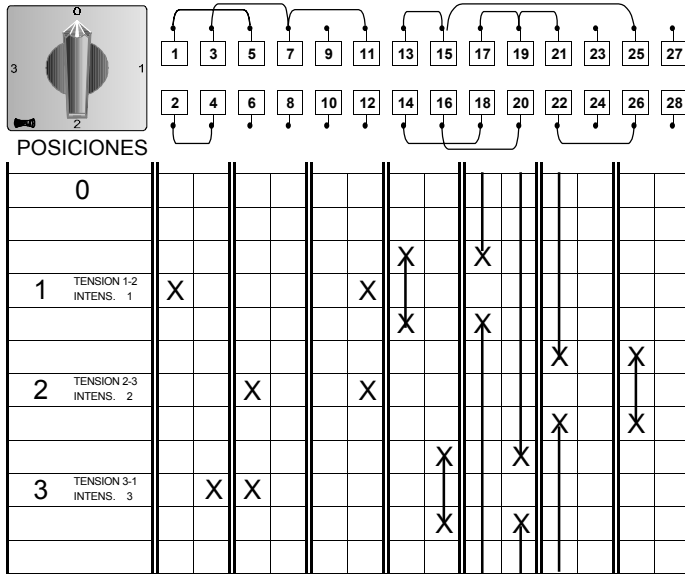

B-035 VOLTIMETRO AMPERIMETRO
3 Fases 3 Bobinas Voltímetro c/ Transformador
7 Pisos

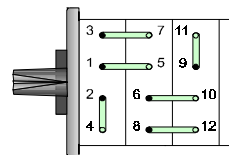
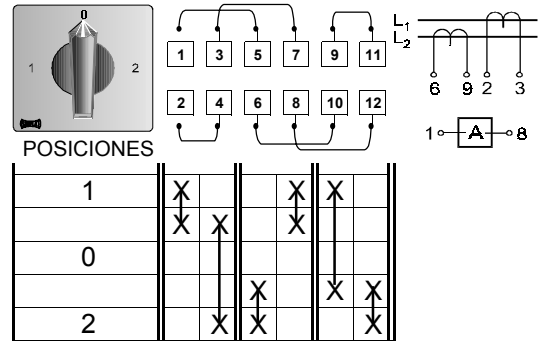
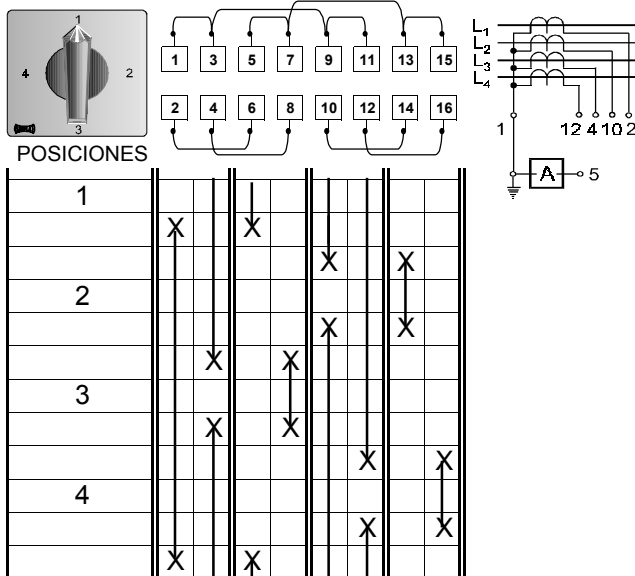

B-037 AMPERIMETRO
2 Bobinas Bipolar
3 Pisos

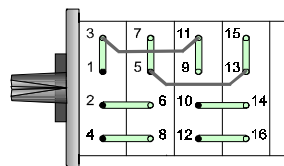

B-036 AMPERIMETRO
4 Líneas 4 Bobinas Unipolar
4 Pisos

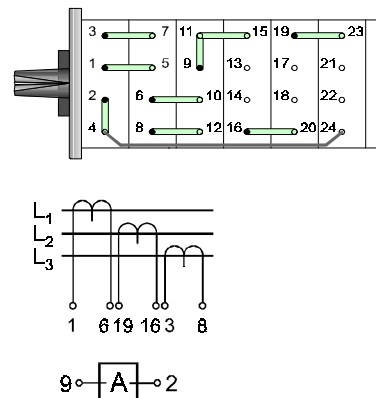
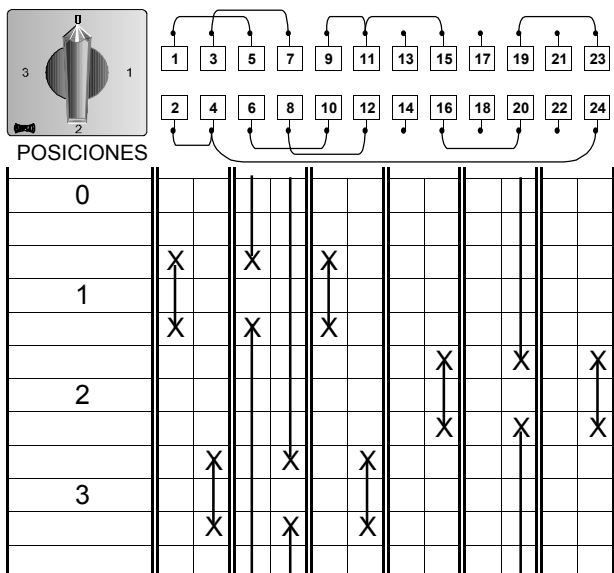

B-038 AMPERIMETRO
3 Bobinas Bipolar
6 Pisos

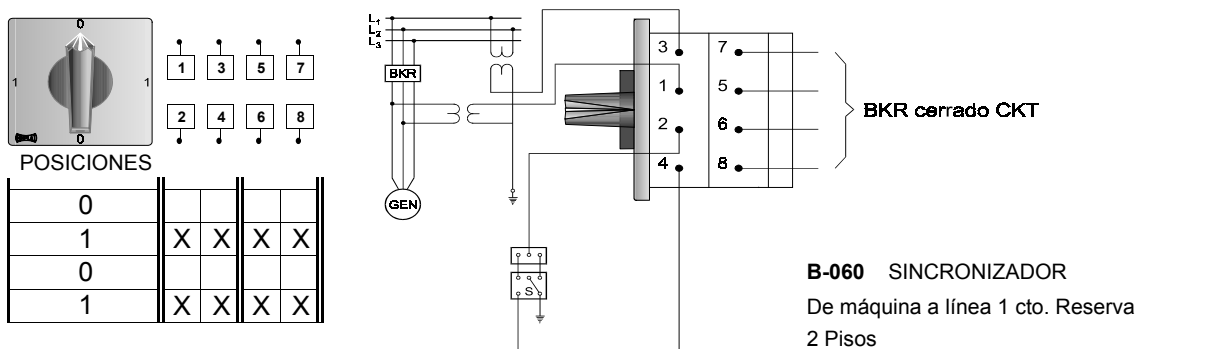
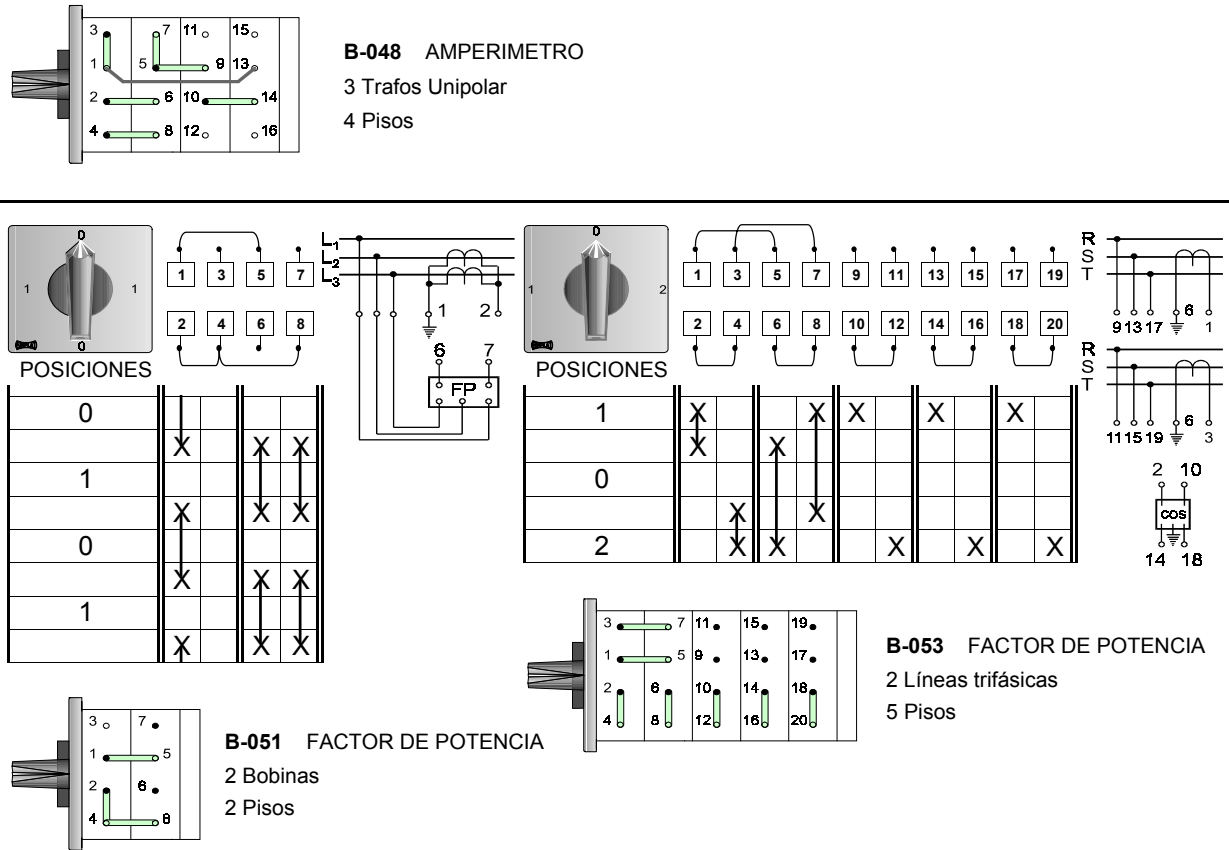
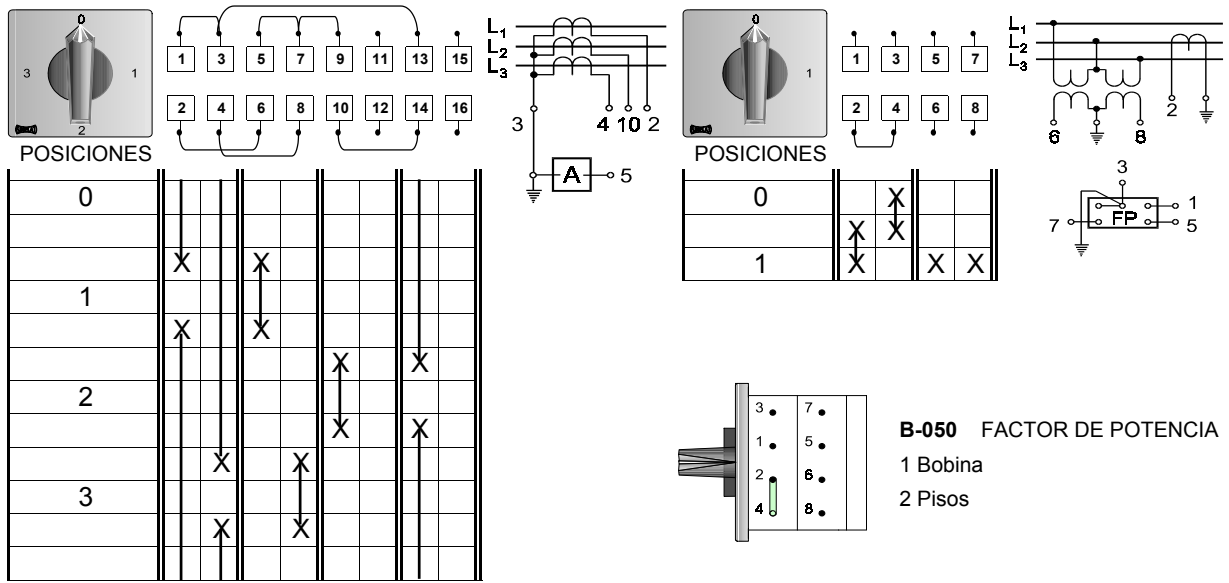

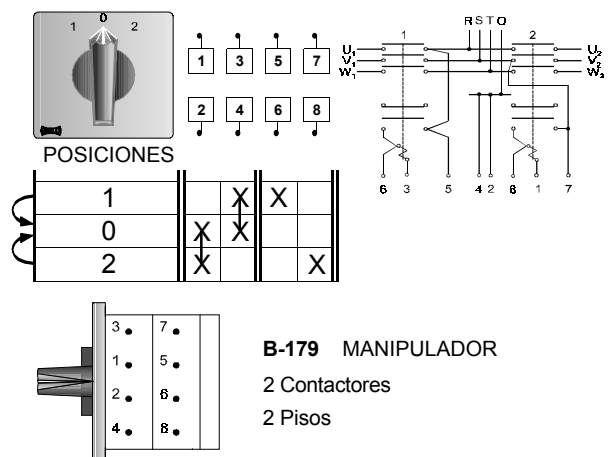
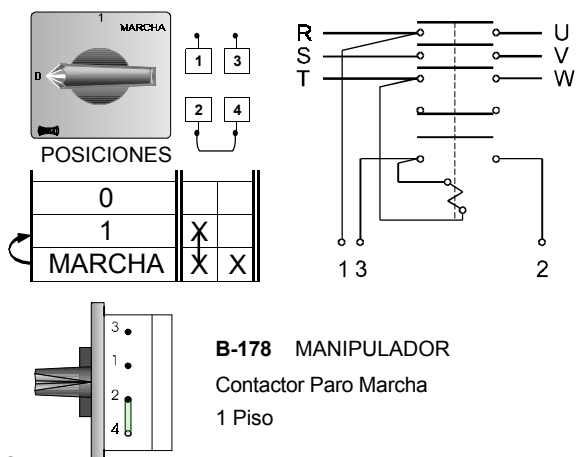
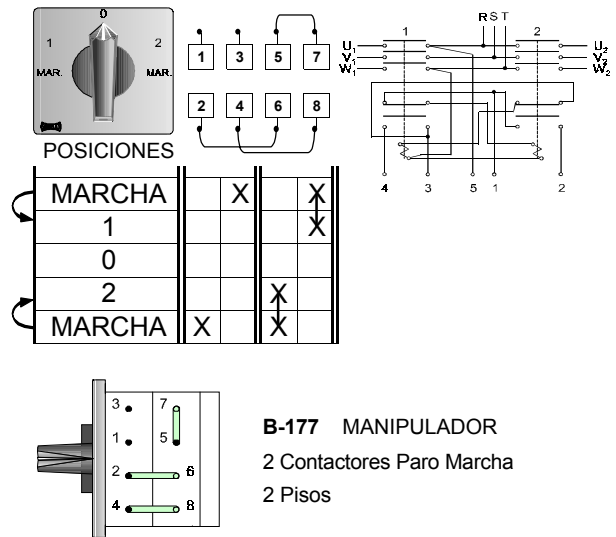
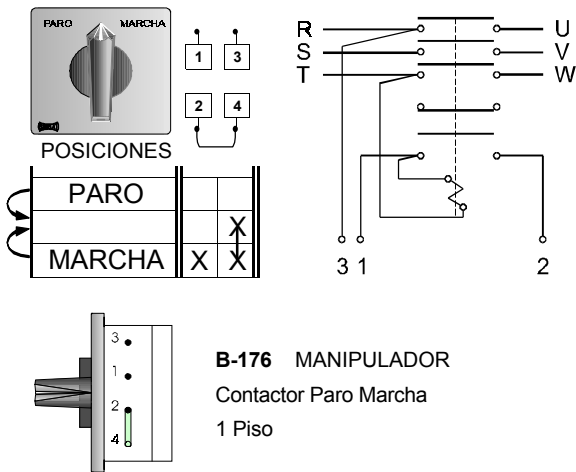
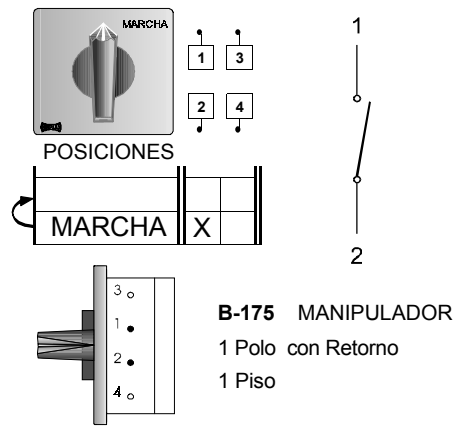
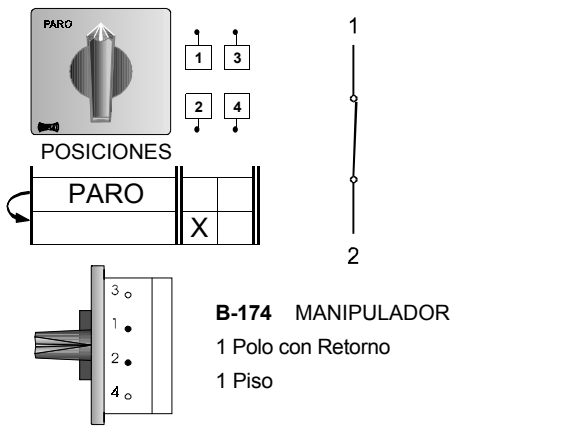
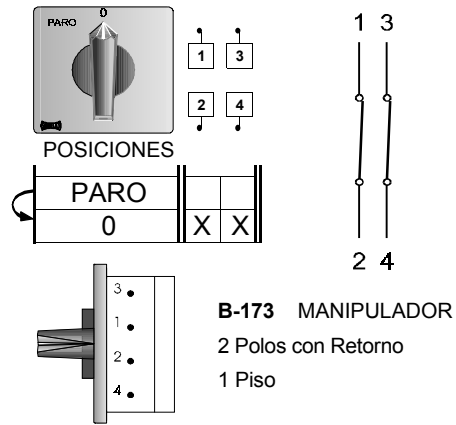
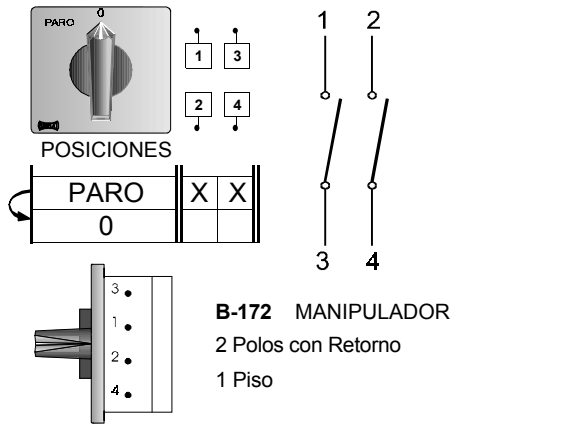

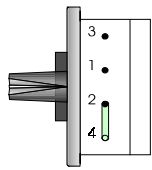
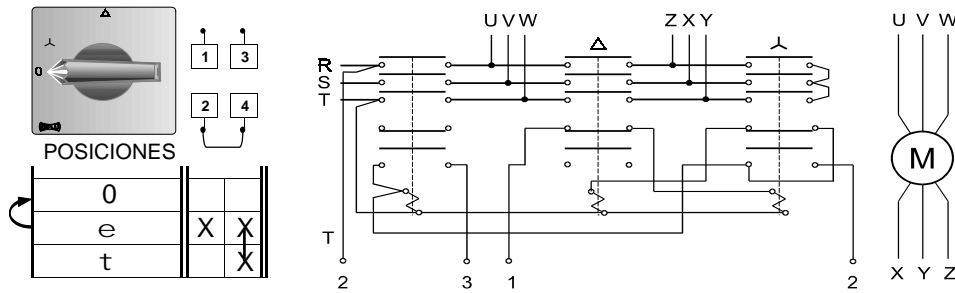

B-180 MANIPULADOR
Arranque Motor Estrella-Triángulo con contactores
1 Piso

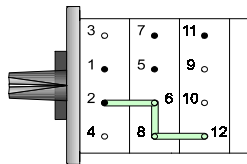
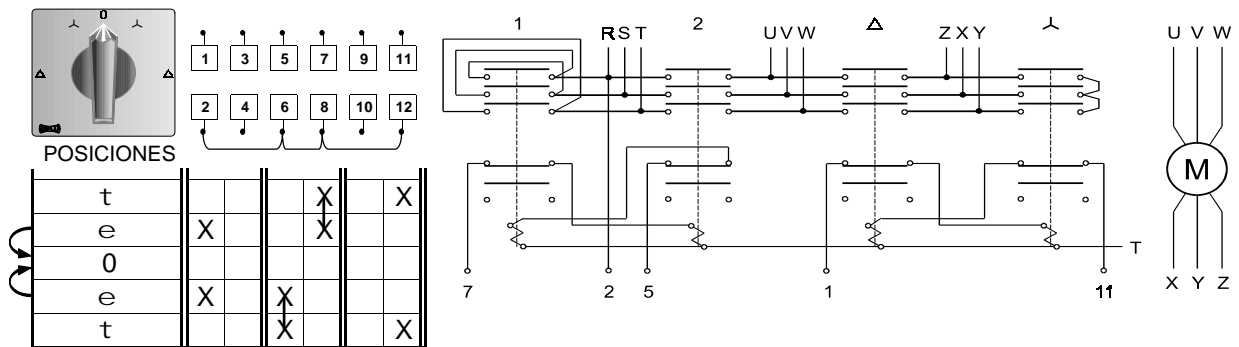

B-181 MANIPULADOR
Arranque Motor Estrella-Triángulo con Contactores e Inversión de marcha
3 Pisos

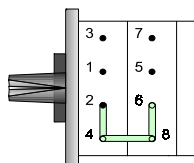
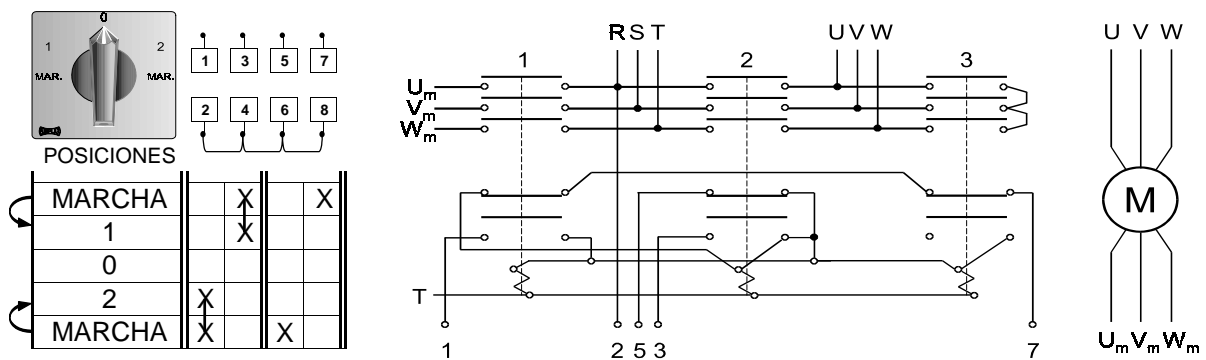

B-182 MANIPULADOR
Motor 2 Velocidades Dahlander con Contactores
2 Pisos

INTERRUPTORES

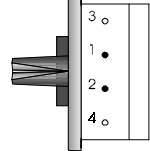
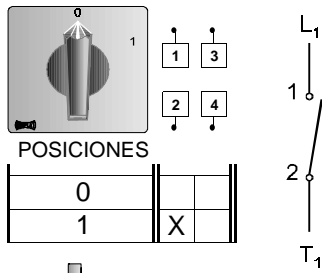

B-200 INTERRUPTOR
Unipolar
1 Piso

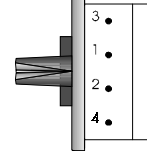
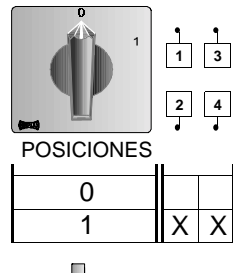

B-201 INTERRUPTOR
Bipolar
1 Piso

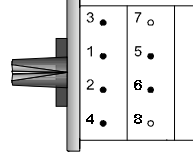
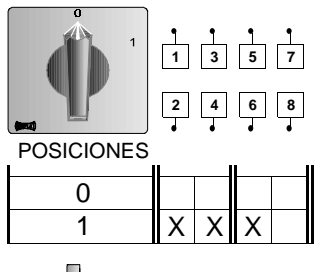

B-202 INTERRUPTOR
Tripolar
2 Pisos

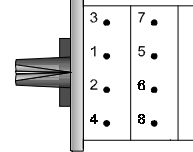
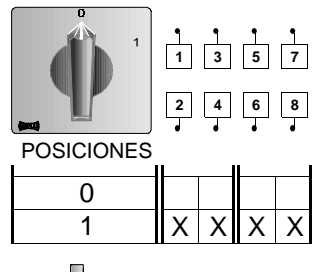

B-203 INTERRUPTOR
Tetrapolar
2 Pisos

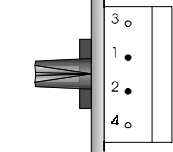
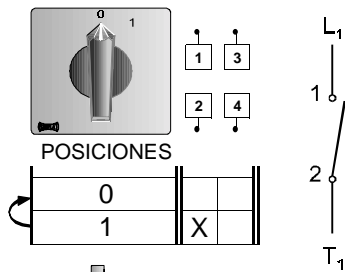

B-204 INTERRUPTOR
Unipolar con retorno a "0"
1 Piso

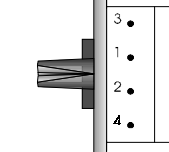
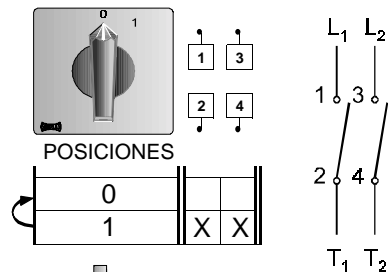

B-205 INTERRUPTOR
Bipolar con retorno a "0"
1 Piso

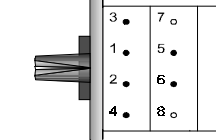
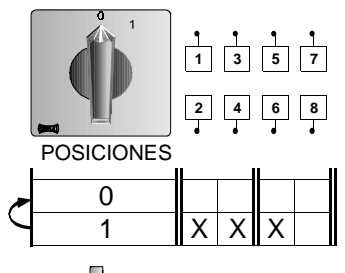

B-206 INTERRUPTOR
Tripolar con retorno a "0"
2 Pisos

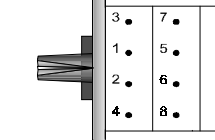
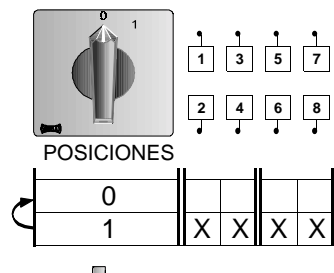

B-207 INTERRUPTOR
Tetrapolar con retorno a "0"
2 Pisos

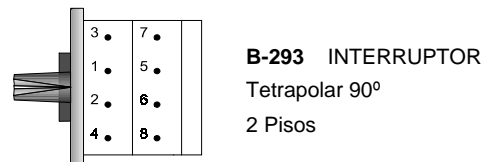
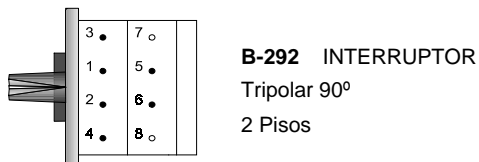
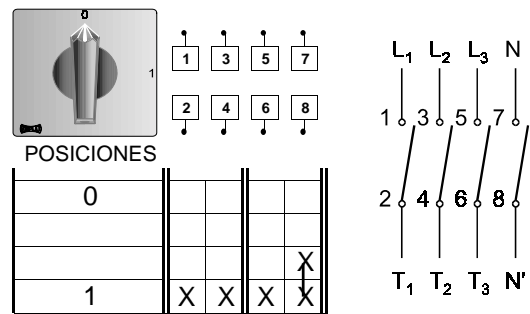
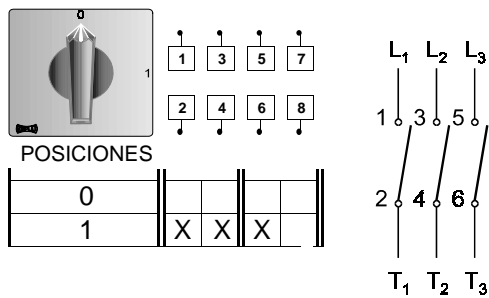
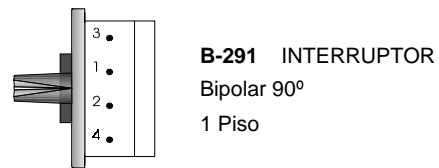
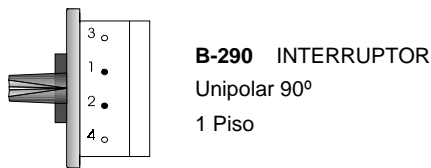
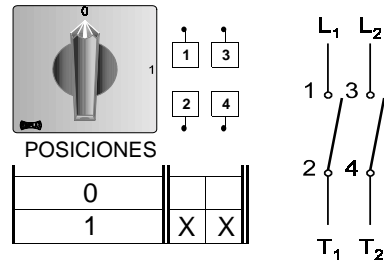
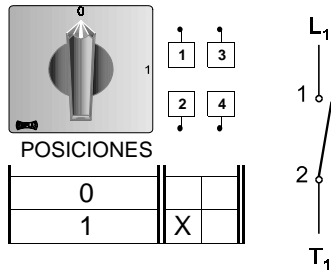

Cuando el interruptor sea de más de cuatro polos, se añadirá el número de éstos a la referencia del unipolar

Ejemplo: Interruptor de 7 polos.
Se pedirá:

INTERRUPTOR B-200/7

El número máximo de polos es 24. Para un mayor número de polos consútenos.

INVERSORES

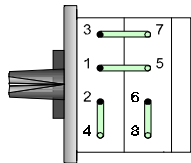
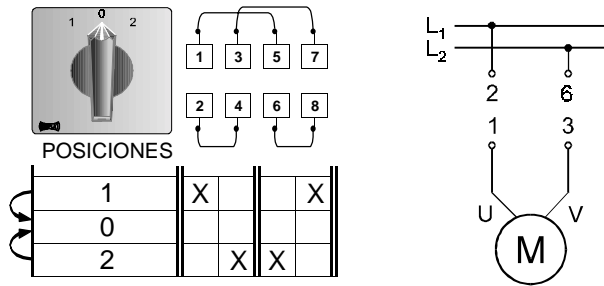

B-227 INVERSOR
Bipolar con retorno a "0"
2 Pisos

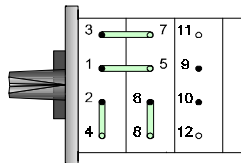
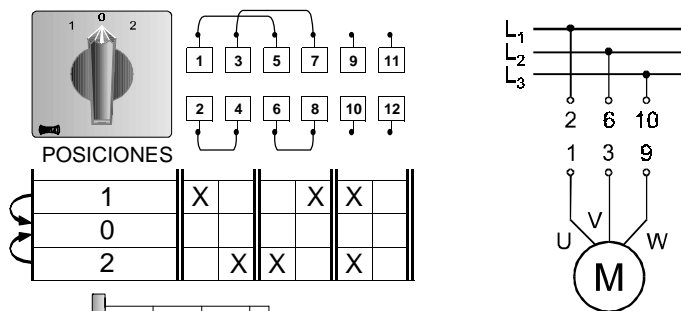

B-228 INVERSOR
Tripolar con retorno a "0"
3 Pisos

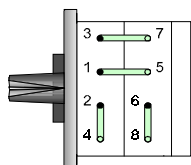
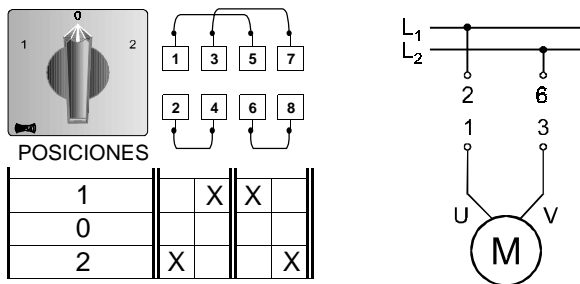

B-400 INVERSOR
Bipolar
2 Pisos

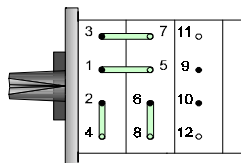
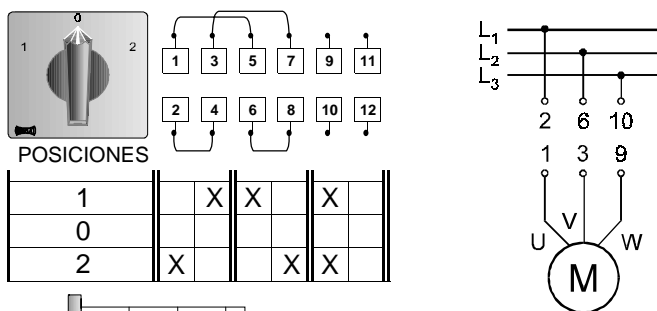

B-401 INVERSOR
Tripolar
3 Pisos

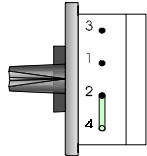
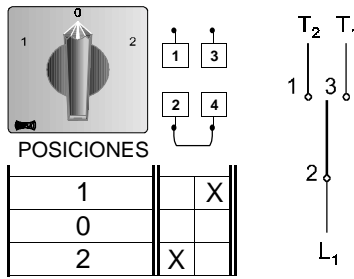

B-210 CONMUTADOR (con "0")
Unipolar
1 Piso

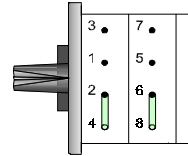
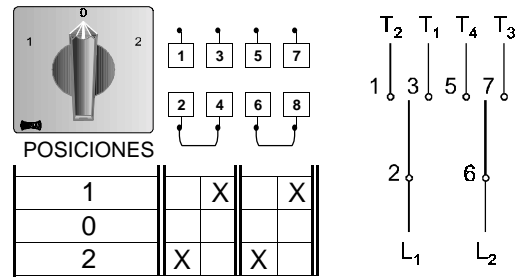

B-211 CONMUTADOR (con "0")
Bipolar
2 Pisos

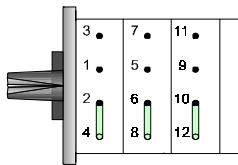
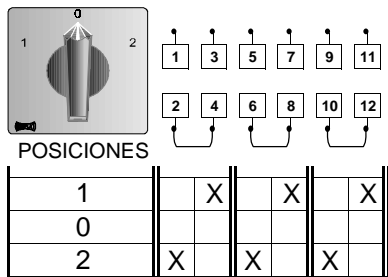

B-212 CONMUTADOR (con "0")
Tripolar
3 Pisos

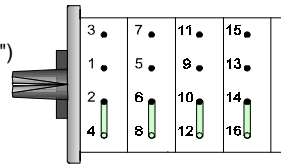
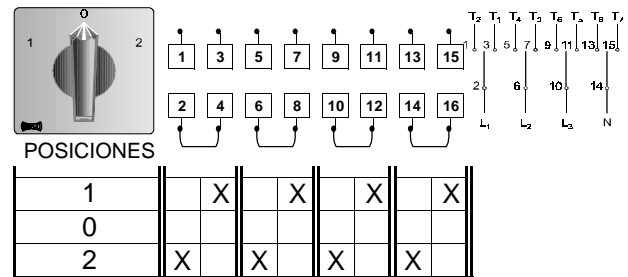

B-213 CONMUTADOR (con "0")
Tetrapolar
4 Pisos

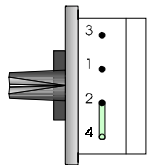
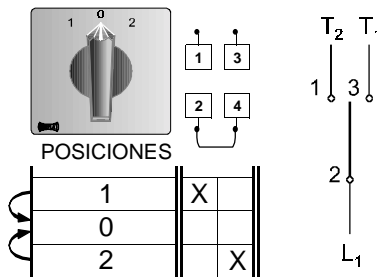

B-214 CONMUTADOR (con "0")
Unipolar con retorno a "0"
1 Piso

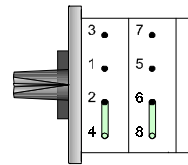
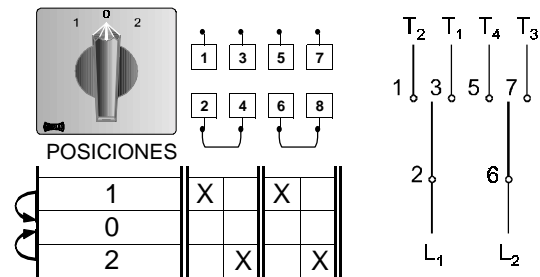

B-215 CONMUTADOR (con "0")
Bipolar con retorno a "0"
2 Pisos

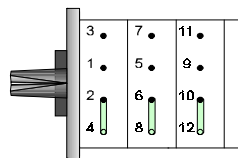
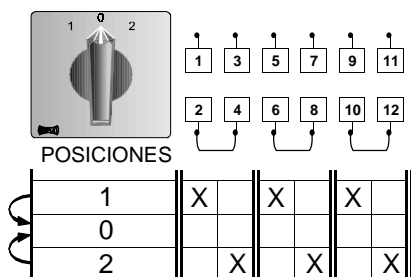

B-216 CONMUTADOR (con "0")
Tripolar con retorno a "0"
3 Pisos

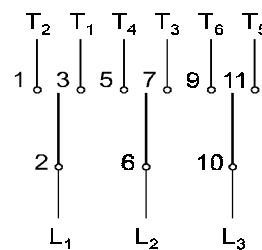

CONMUTADORES

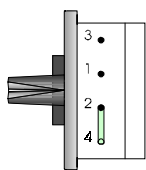
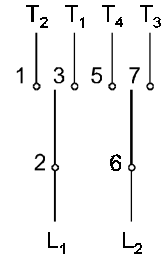
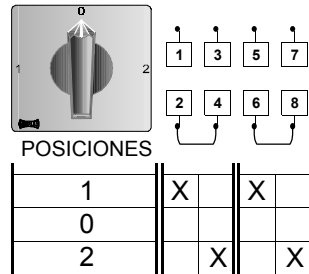
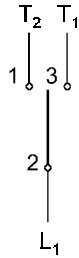
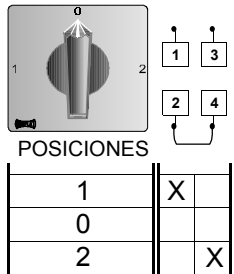

B-218 CONMUTADOR (con "0")
Unipolar 90°
1 Piso

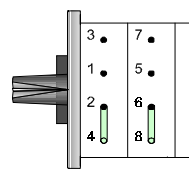

B-219 CONMUTADOR (con "0")
Bipolar 90°
2 Pisos

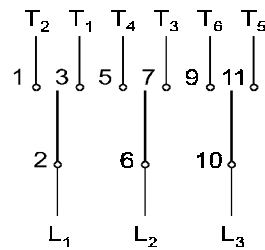
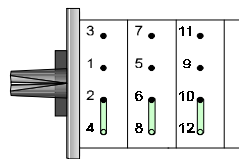
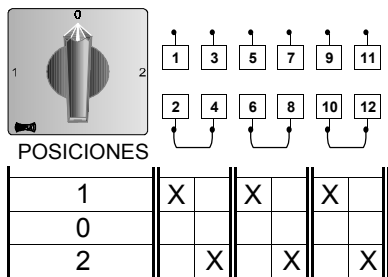

B-299 CONMUTADOR (con "0")
Tripolar 90°
3 Pisos

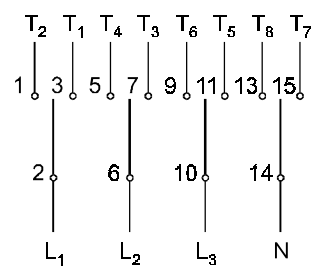
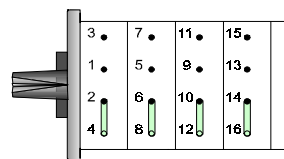
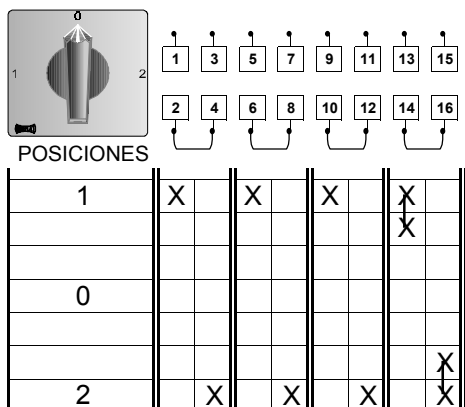

B-294 CONMUTADOR (con "0")
Tetrapolar 90°
4 Pisos

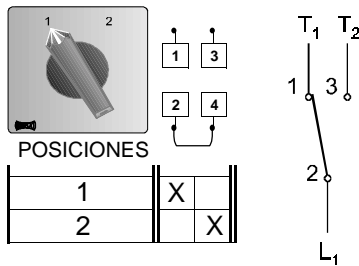

POSICIONES

1	X	
2		X

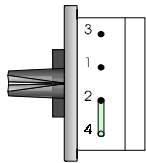

B-220 CONMUTADOR (sin "0")
Unipolar
1 Piso

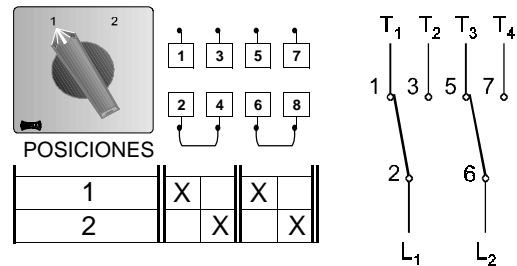

POSICIONES

1	X		X
2		X	X

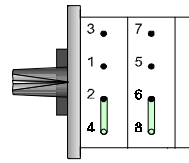

B-221 CONMUTADOR (sin "0")
Bipolar
2 Pisos

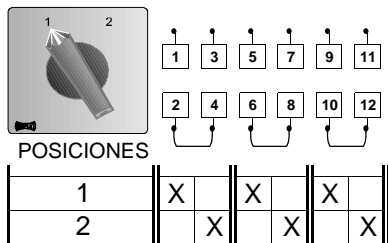

POSICIONES

1	X		X		X
2		X		X	X

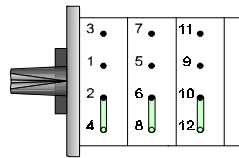

B-222 CONMUTADOR (sin "0")
Tripolar
3 Pisos

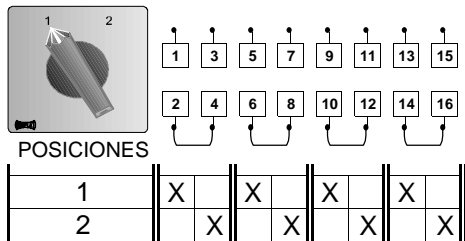
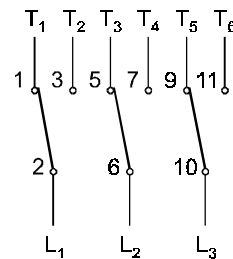

POSICIONES

1	X		X		X		X
2		X		X		X	X

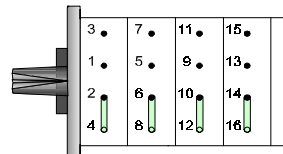

B-223 CONMUTADOR (sin "0")
Tetrapolar
4 Pisos

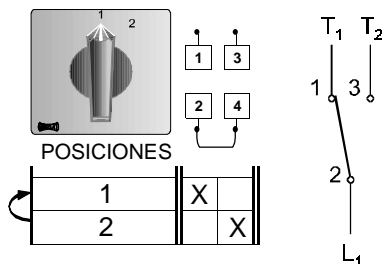
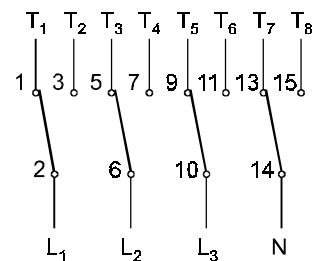

POSICIONES

1	X	
2		X

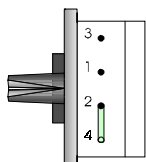

B-295 CONMUTADOR (sin "0")
Unipolar con retorno a "1"
1 Piso

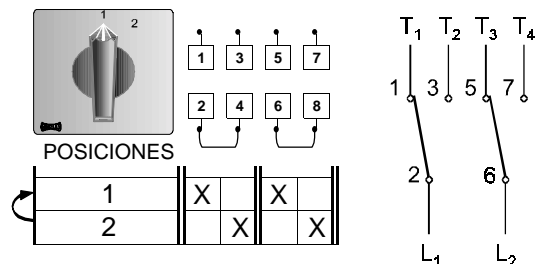

POSICIONES

1	X		X
2		X	X

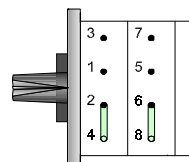

B-296 CONMUTADOR (sin "0")
Bipolar con retorno a "1"
2 Pisos

CONMUTADORES

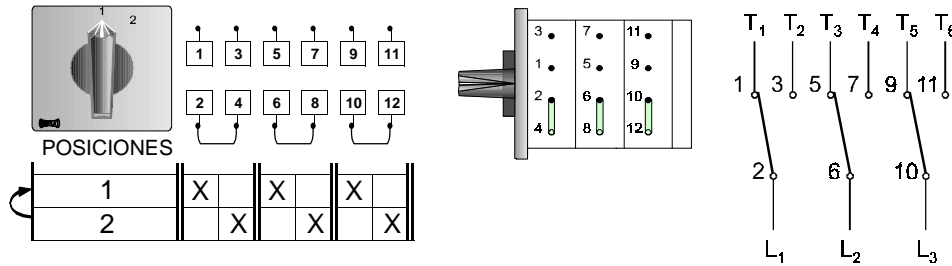

B-297 CONMUTADOR (sin "0")
 Tripolar con retorno a "1"
 3 Pisos

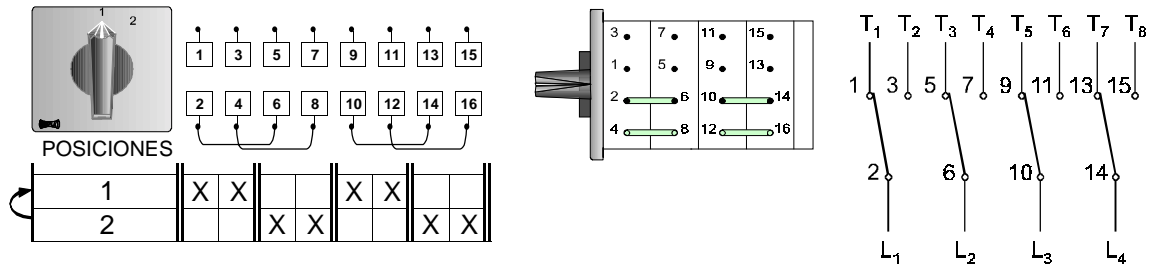

B-298 CONMUTADOR (sin "0")
 Tetrapolar con retorno a "1"
 4 Pisos

Cuando el interruptor sea de más de cuatro polos, se añadirá el número de éstos a la referencia del unipolar

Ejemplo: Interruptor de 7 polos con "0".
 Se pedirá:

INTERRUPTOR B-210/7

Ejemplo: Interruptor de 7 polos sin "0".
 Se pedirá:

INTERRUPTOR B-220/7

El número máximo de polos es de 12. Para mayor número de polos consúltenos.

CONMUTADORES DE POSICIONES SIN "0" UNIPOLARES

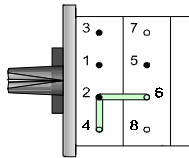
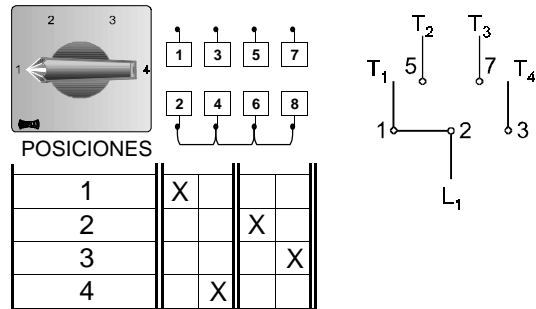
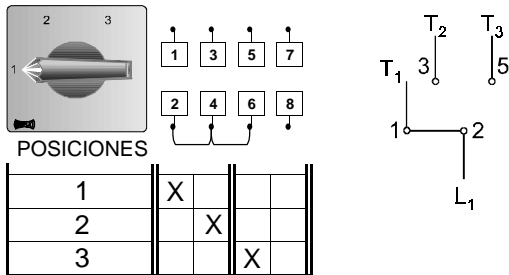

B-230 CONMUTADOR
3 Posiciones
2 Pisos

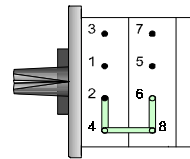

B-231 CONMUTADOR
4 Posiciones
2 Pisos

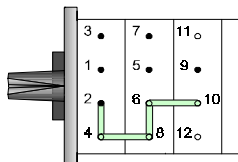
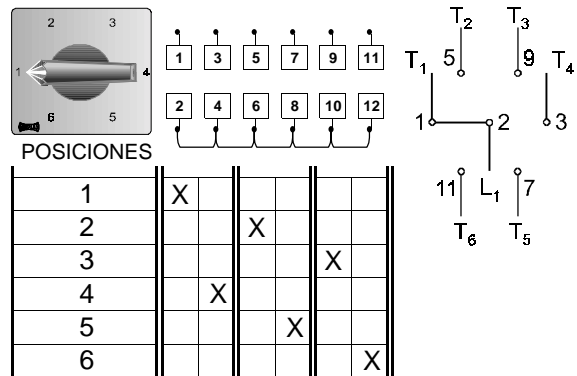
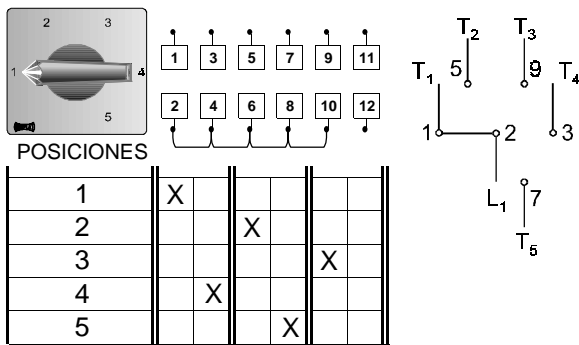

B-232 CONMUTADOR
5 Posiciones
3 Pisos

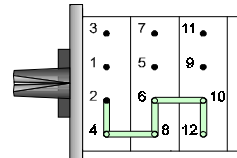

B-233 CONMUTADOR
6 Posiciones
3 Pisos

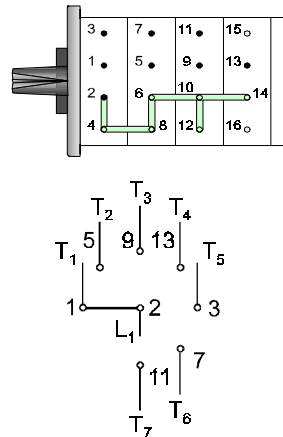
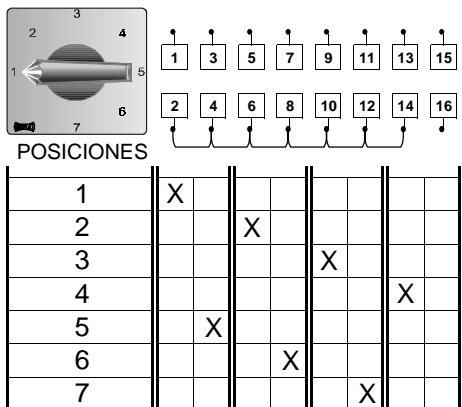

B-234 CONMUTADOR
7 Posiciones
4 Pisos

CONMUTADORES DE POSICIONES

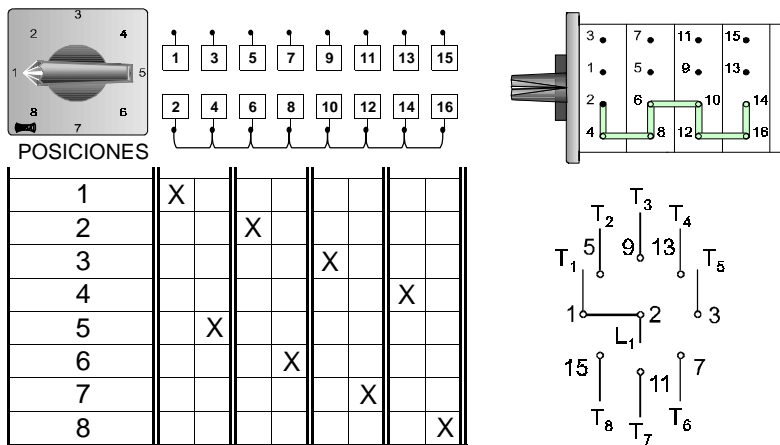

B-235 CONMUTADOR

8 Posiciones
4 Pisos

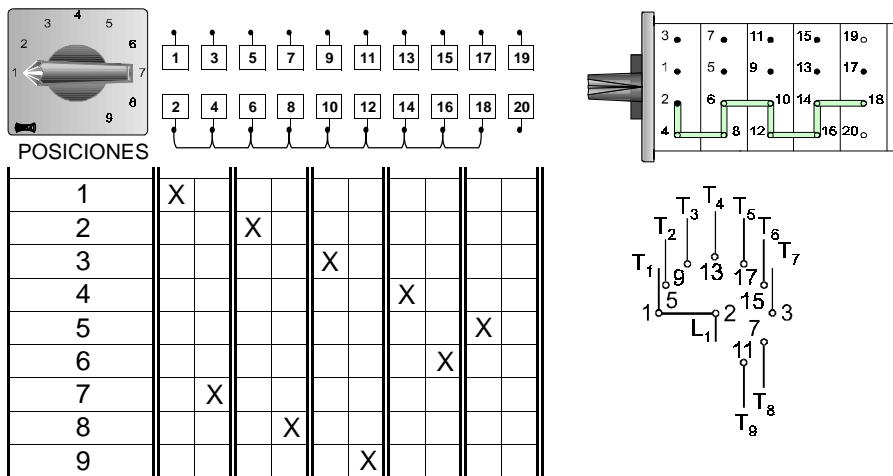

B-236 CONMUTADOR

9 Posiciones
5 Pisos

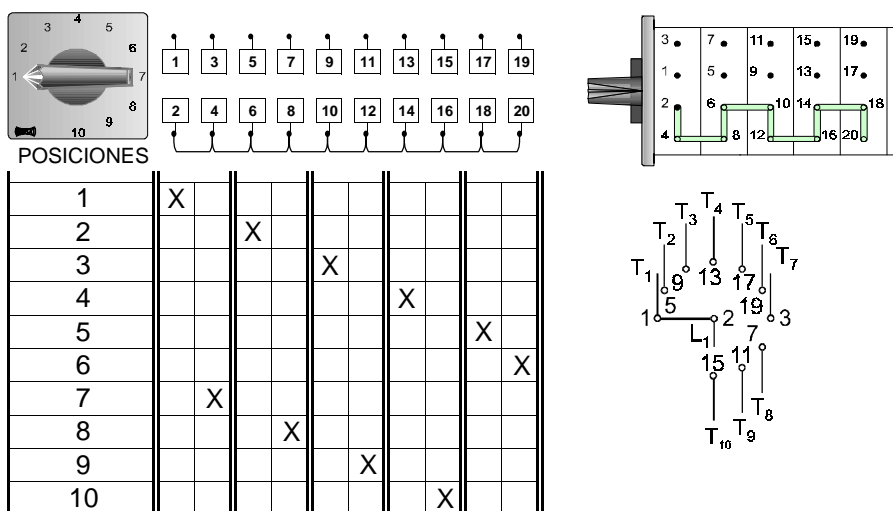

B-237 CONMUTADOR

10 Posiciones
5 Pisos



CONMUTADORES DE POSICIONES

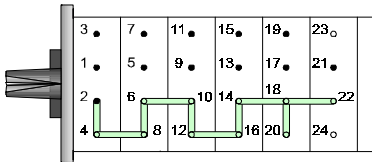
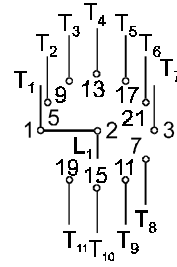
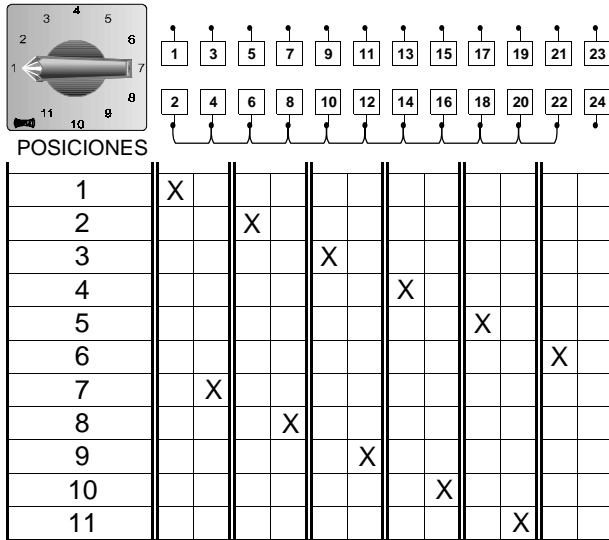

B-238 CONMUTADOR

11 Posiciones

6 Pisos

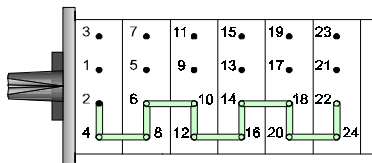
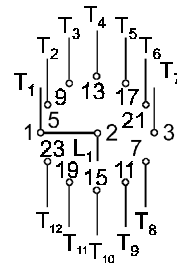
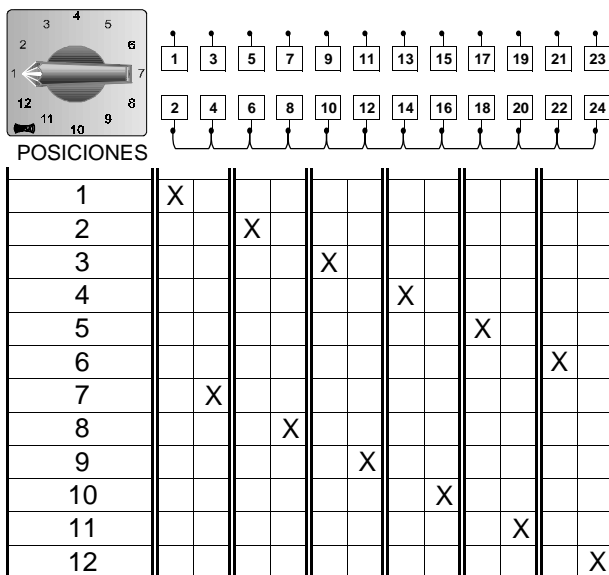

B-239 CONMUTADOR

12 Posiciones

6 Pisos

CONMUTADORES DE POSICIONES CON "0" UNIPOLARES

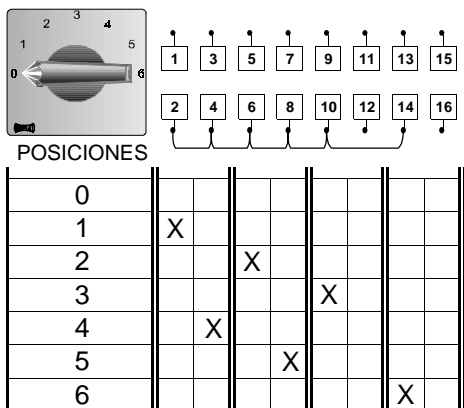
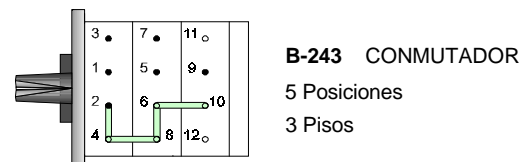
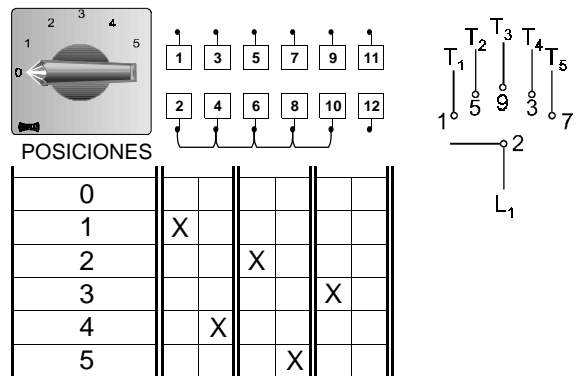
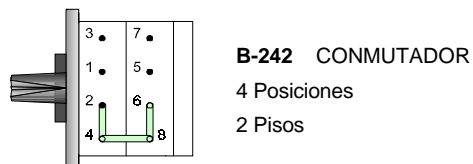
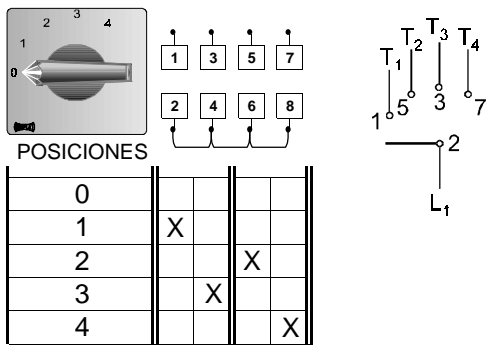
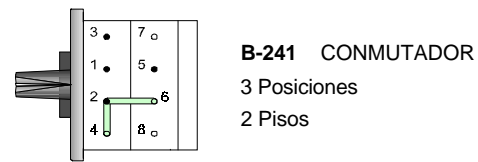
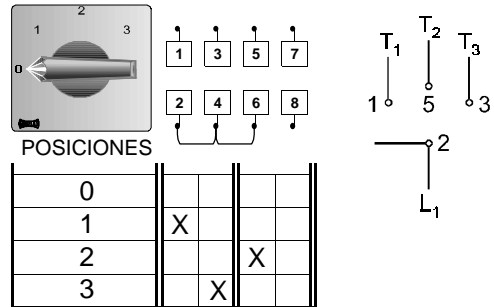
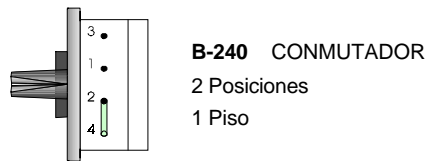
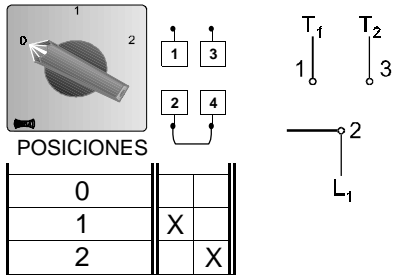

B-244 CONMUTADOR
6 Posiciones
4 Pisos

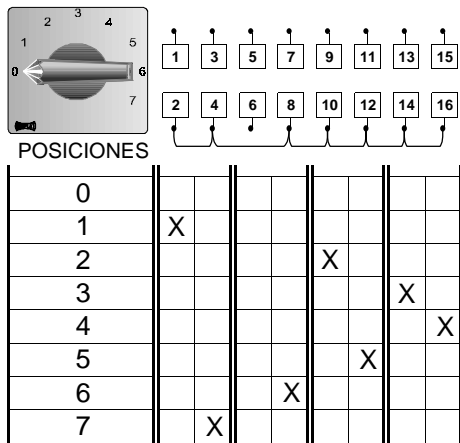

B-245 CONMUTADOR

7 Posiciones

4 Pisos

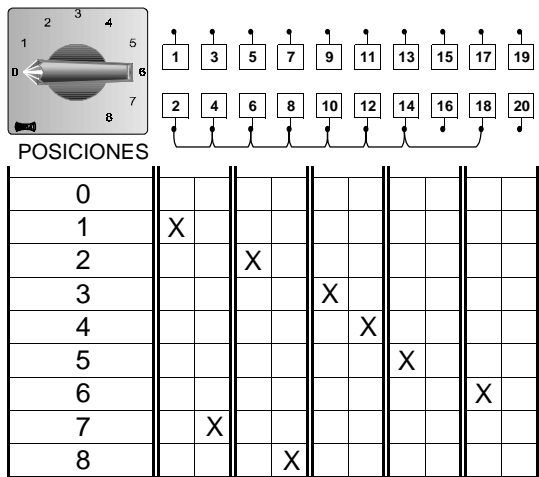

B-246 CONMUTADOR

8 Posiciones

5 Pisos

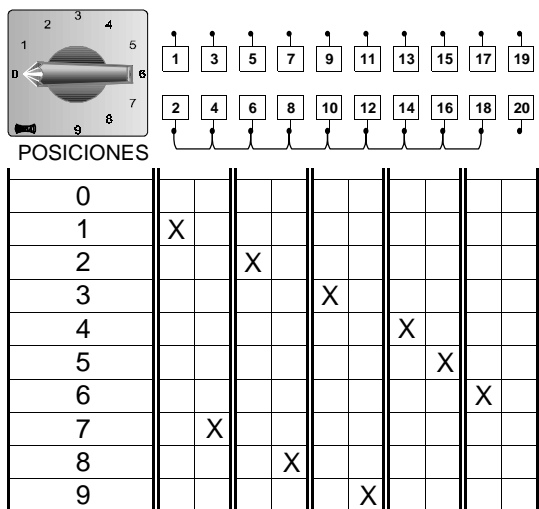

B-247 CONMUTADOR

9 Posiciones

5 Pisos

CONMUTADORES DE POSICIONES

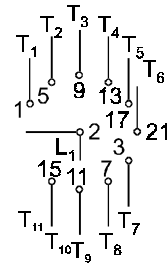
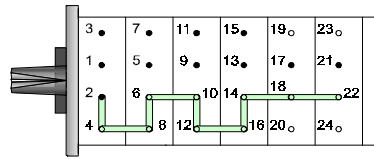
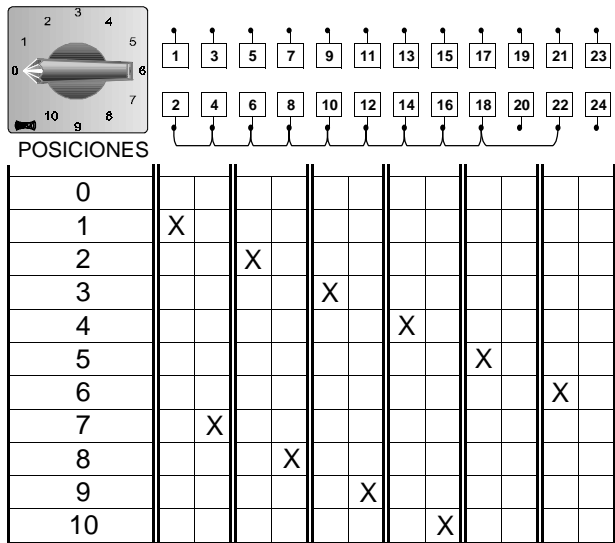

B-248 CONMUTADOR

10 Posiciones
6 Pisos

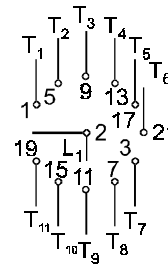
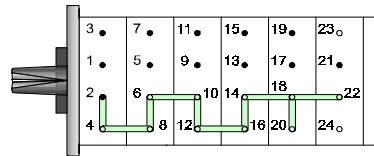
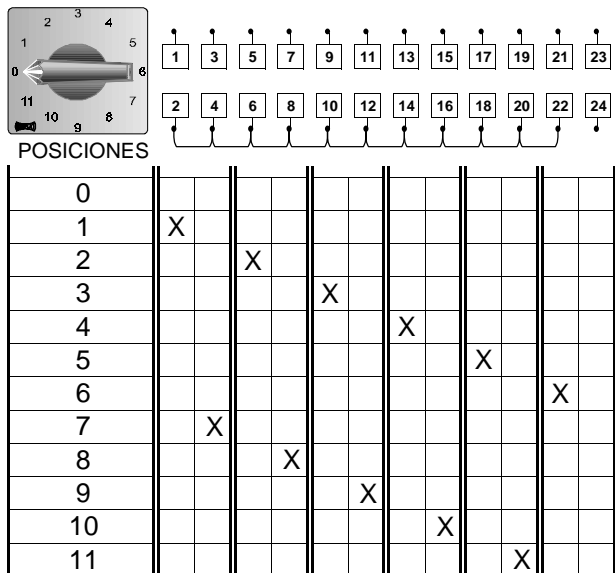

B-249 CONMUTADOR

11 Posiciones
6 Pisos

CONMUTADORES DE POSICIONES SIN "0" BIPOLARES

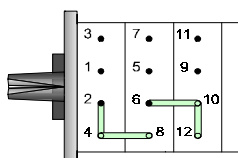
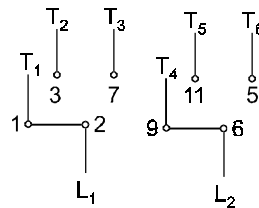
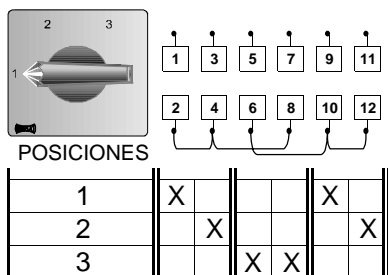

B-250 CONMUTADOR

3 Posiciones
3 Pisos

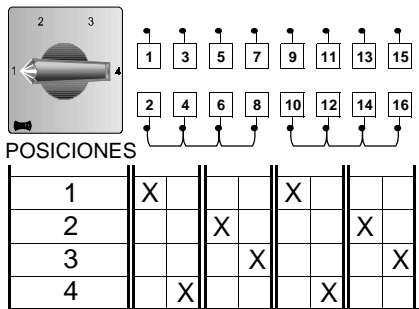

B-251 CONMUTADOR

4 Posiciones

4 Pisos

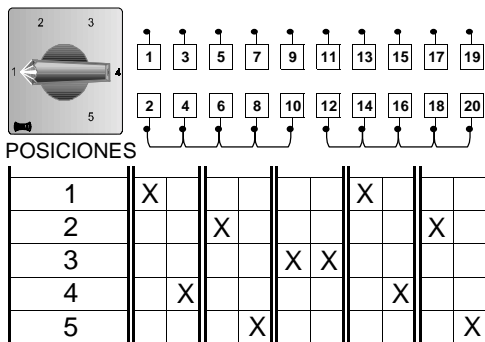
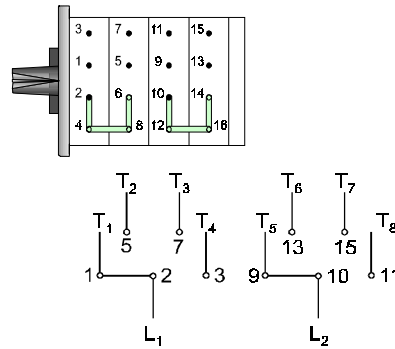

B-252 CONMUTADOR

5 Posiciones

5 Pisos

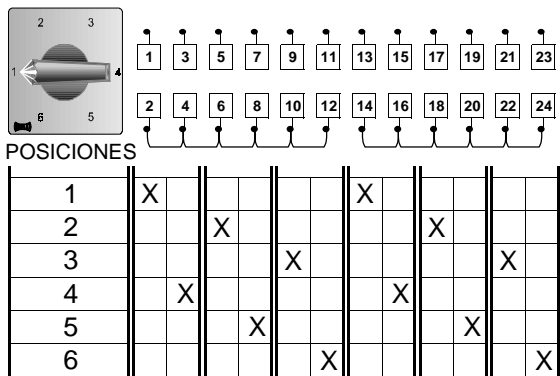
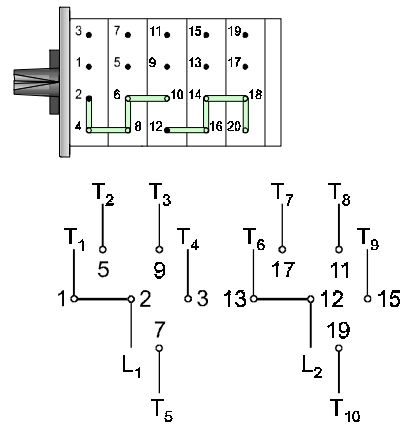

B-253 CONMUTADOR

6 Posiciones

6 Pisos

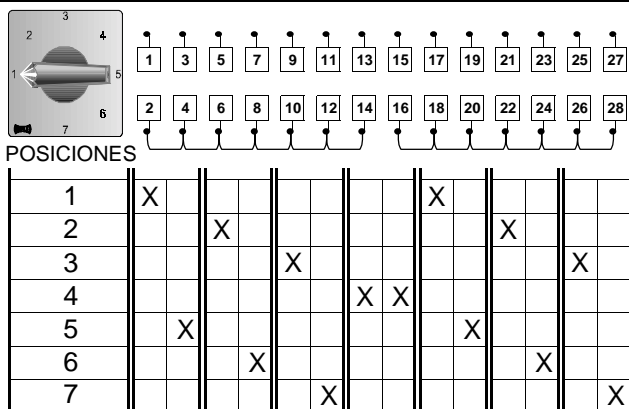
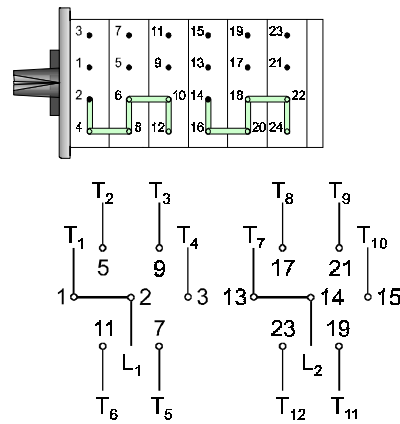

B-254 CONMUTADOR

7 Posiciones

7 Pisos

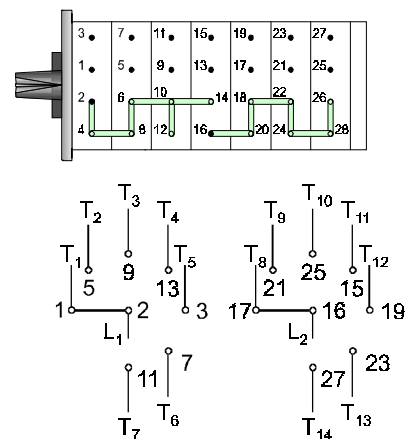

CONMUTADORES DE POSICIONES

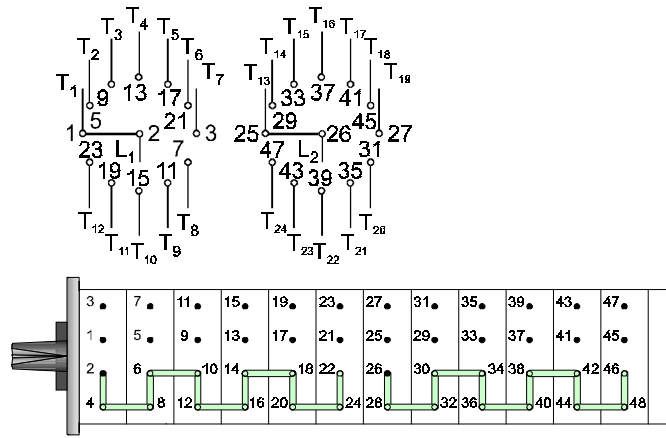
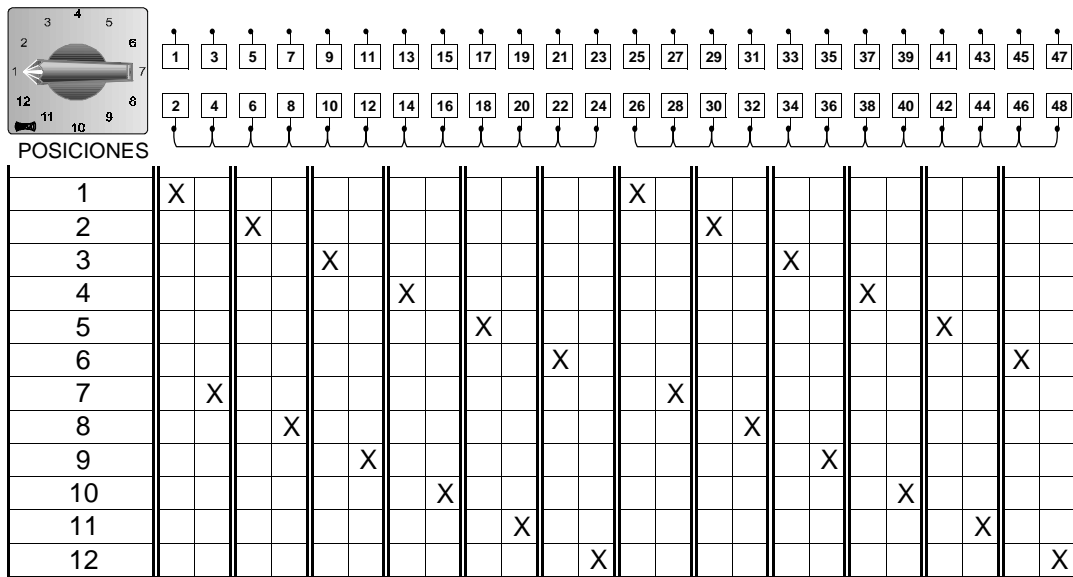

B-259 CONMUTADOR
12 Posiciones
12 Pisos

CONMUTADORES DE POSICIONES CON "0" BIPOLARES

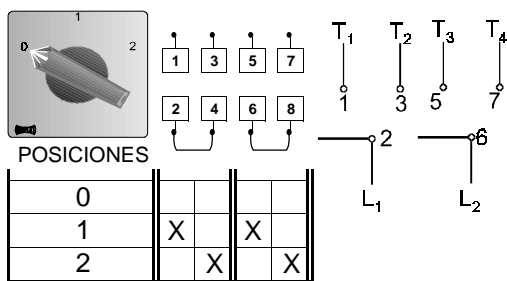

B-260 CONMUTADOR
2 Posiciones
2 Pisos

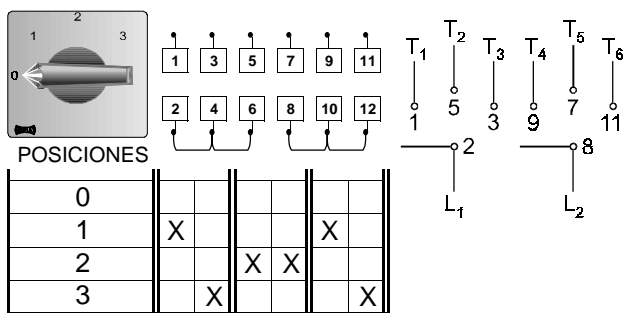

B-261 CONMUTADOR
3 Posiciones
3 Pisos



CONMUTADORES DE POSICIONES

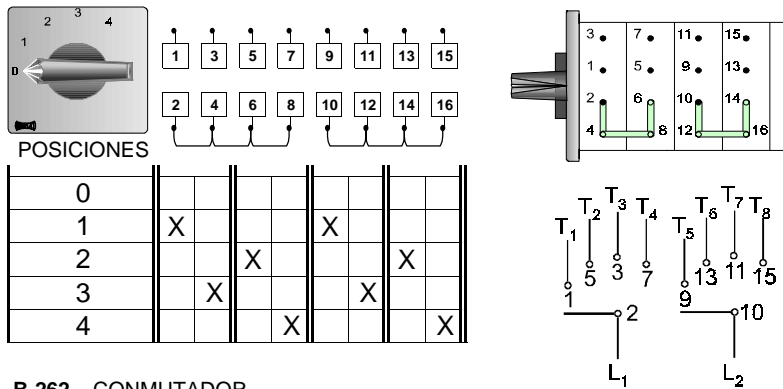

B-262 CONMUTADOR

4 Posiciones
4 Pisos

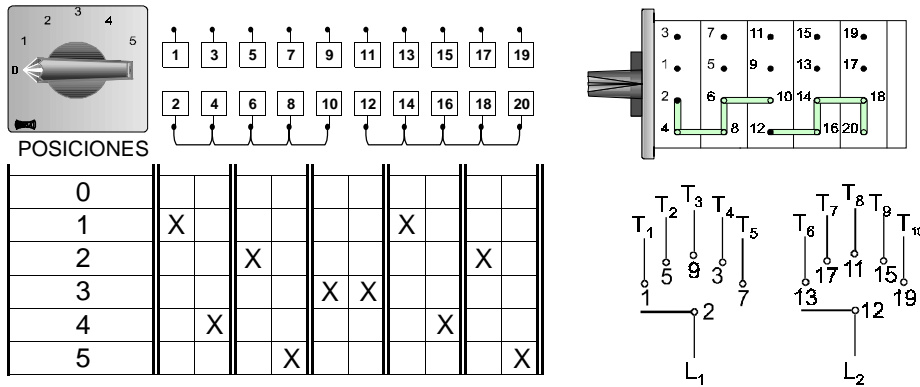

B-263 CONMUTADOR

5 Posiciones
5 Pisos

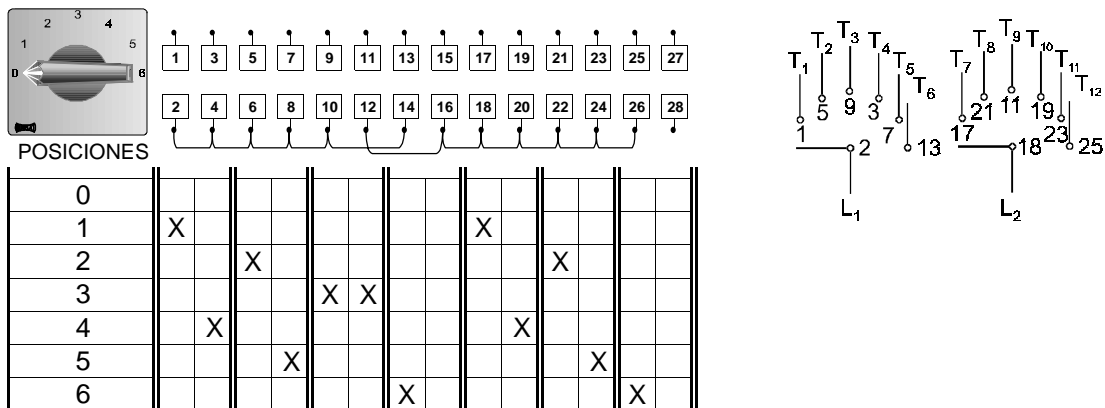

B-264 CONMUTADOR

6 Posiciones
7 Pisos

CONMUTADORES DE POSICIONES

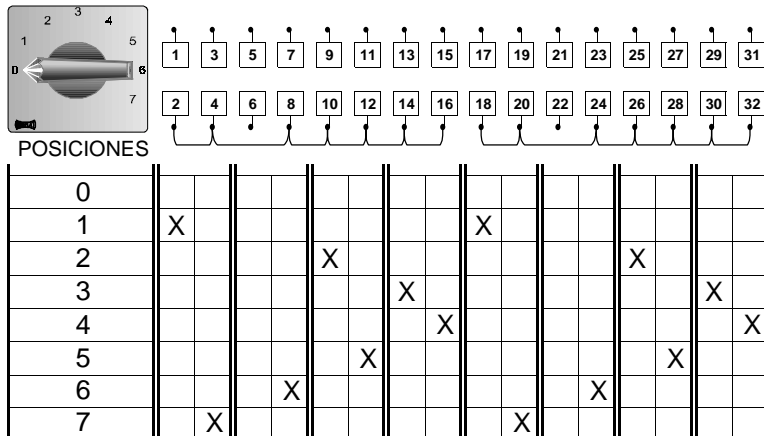

POSICIONES	1	2	3	4	5	6	7
0							
1	X					X	
2			X				X
3				X			X
4					X		X
5			X				X
6		X				X	
7	X						X

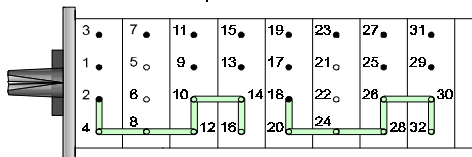
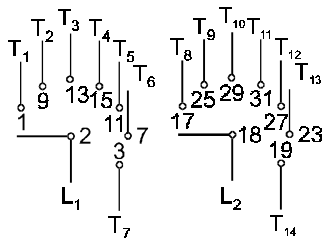

B-265 CONMUTADOR
7 Posiciones
8 Pisos

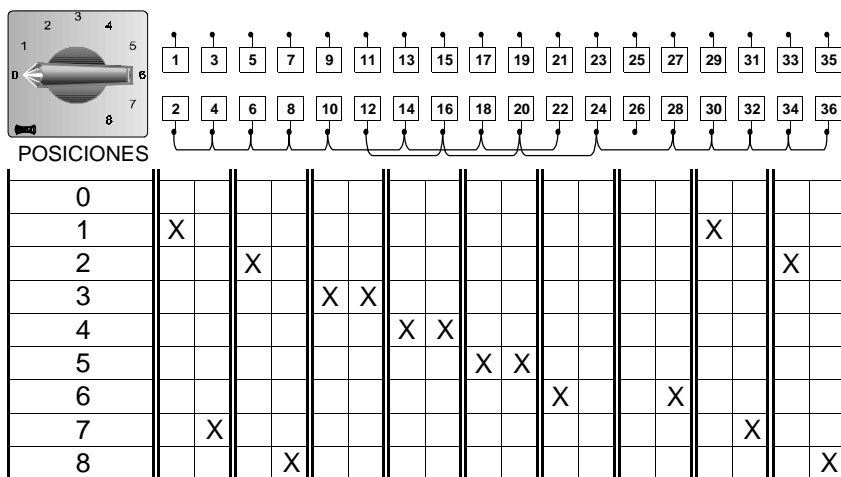

POSICIONES	1	2	3	4	5	6	7	8
0								
1	X							X
2		X						X
3			X	X				
4				X	X			
5					X	X		
6						X	X	
7	X							X
8		X						X

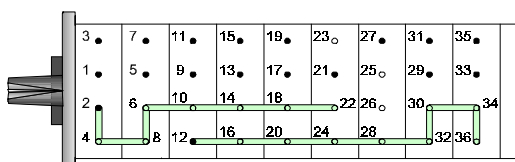
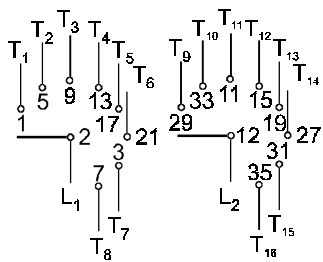

B-266 CONMUTADOR
8 Posiciones
9 Pisos

CONMUTADORES DE POSICIONES

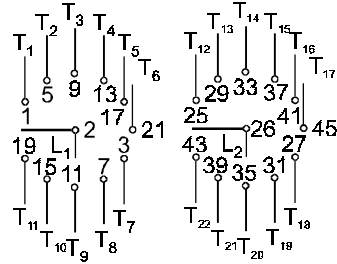
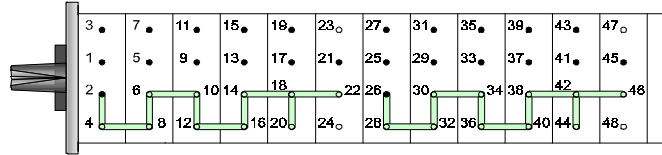
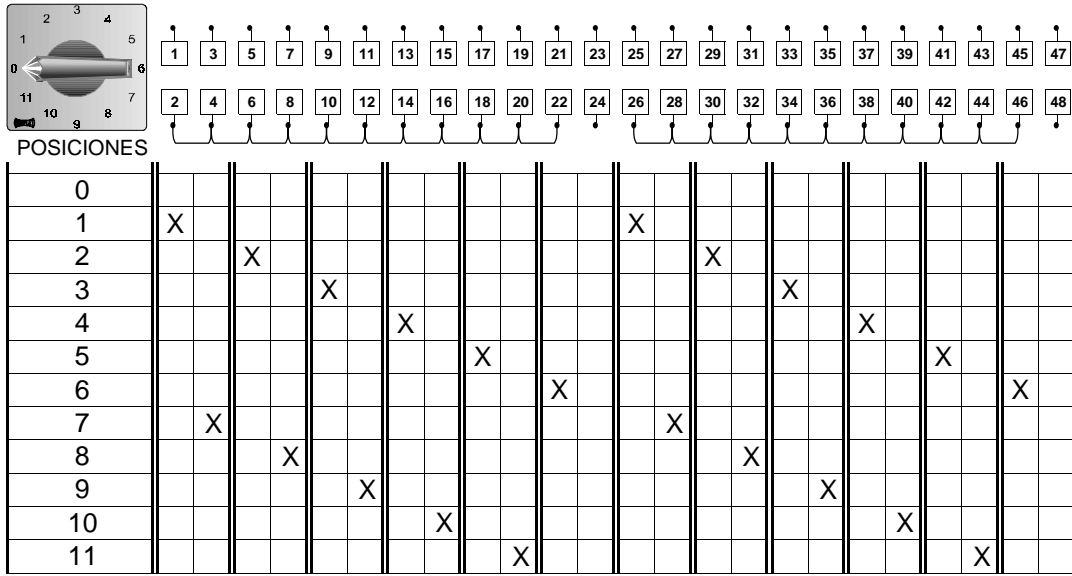

B-269 CONMUTADOR

11 Posiciones

12 Pisos

CONMUTADORES DE POSICIONES SIN "0" TRIPOLARES

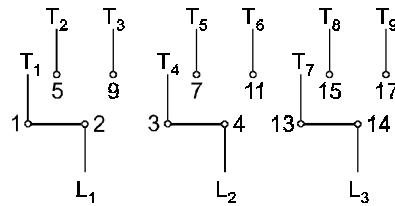
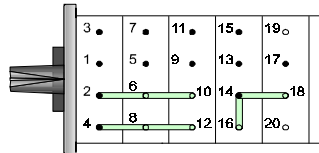
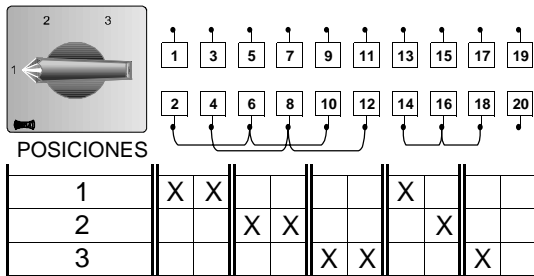

B-270 CONMUTADOR

3 Posiciones

5 Pisos

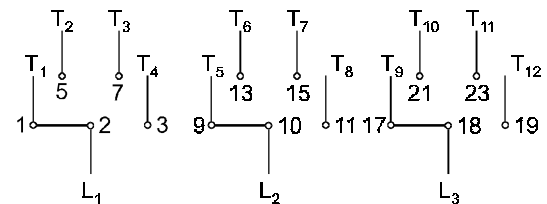
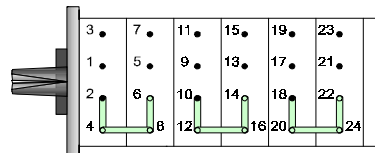
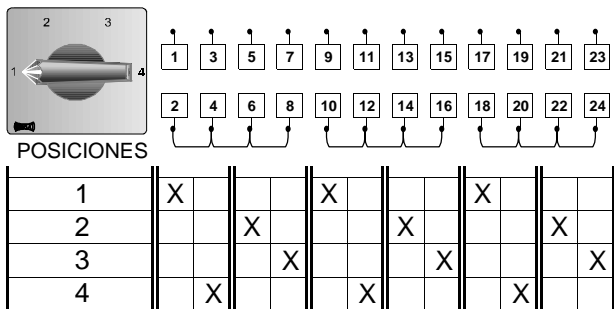

B-271 CONMUTADOR

4 Posiciones

6 Pisos

CONMUTADORES DE POSICIONES CON "0" TRIPOLARES

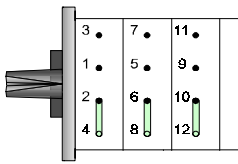
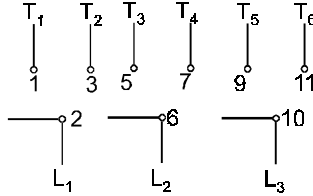
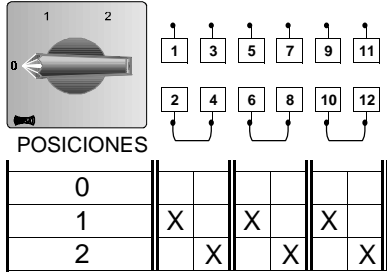

B-280 CONMUTADOR
2 Posiciones
3 Pisos

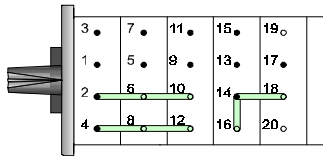
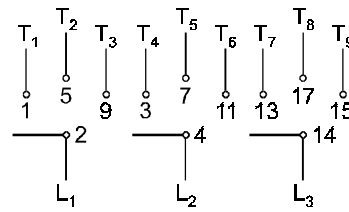
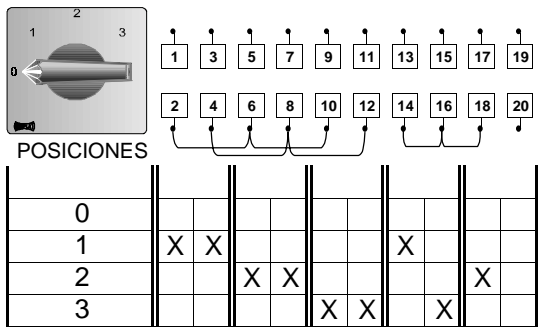

B-281 CONMUTADOR
3 Posiciones
5 Pisos

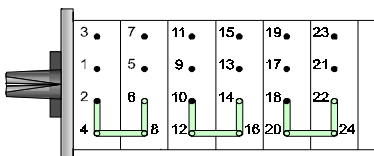
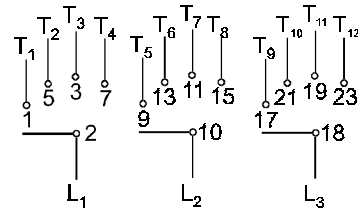
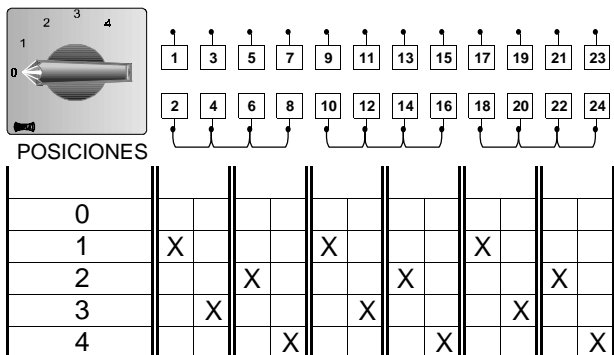

B-282 CONMUTADOR
4 Posiciones
6 Pisos

CONMUTADORES DE GRUPO

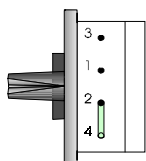
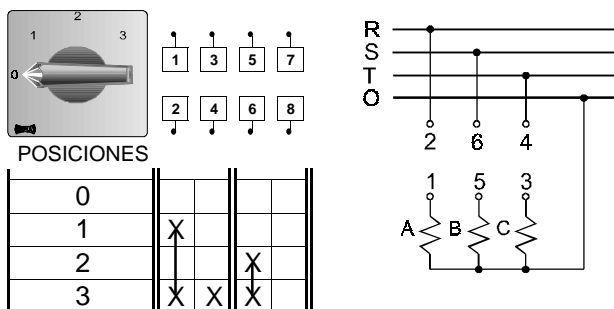
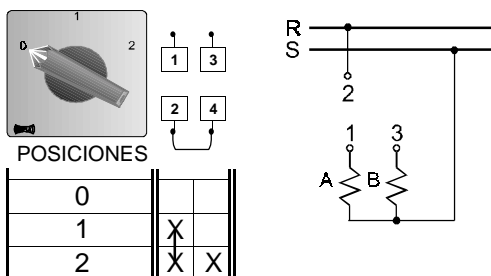

B-310 CONMUTADOR
2 Grupos unipolar
1 Piso

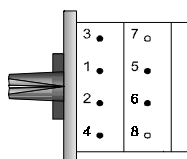

B-311 CONMUTADOR
3 Grupos unipolar
2 Pisos

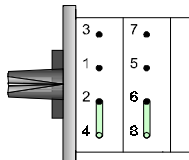
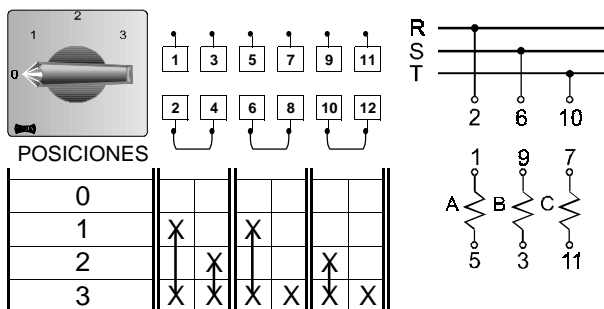
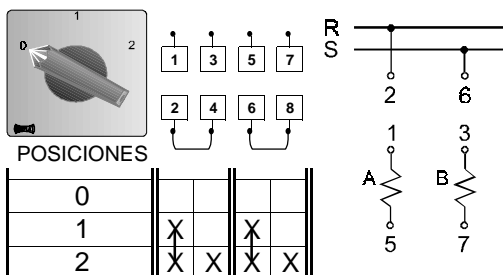

B-312 CONMUTADOR
2 Grupos bipolar
2 Pisos

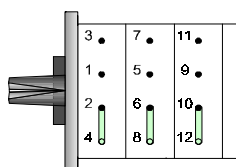

B-313 CONMUTADOR
3 Grupos tripolar
3 Pisos

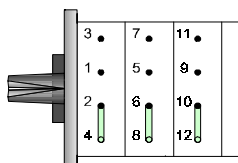
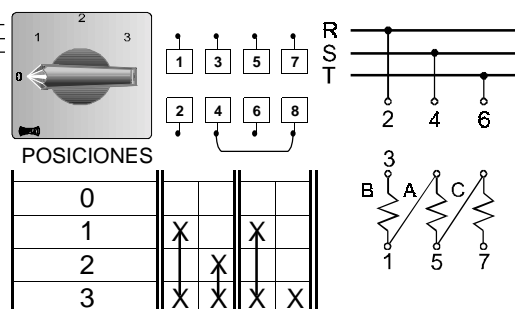
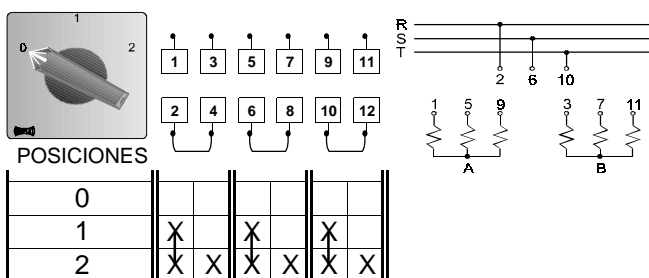

B-314 CONMUTADOR
2 Grupos tripolar
3 Pisos

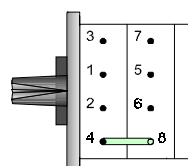

B-316 CONMUTADOR
3 Grupos estrella triángulo
2 Pisos

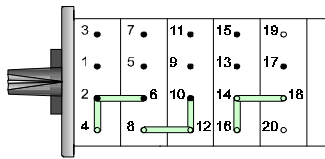
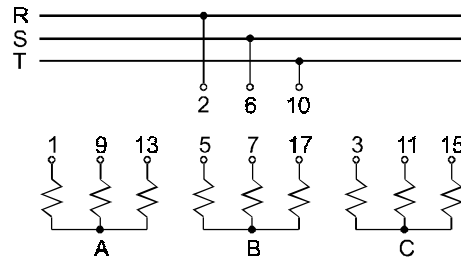
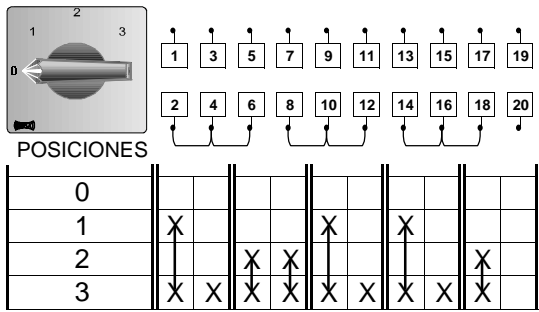

B-315 CONMUTADOR
3 Grupos tripolar
5 Pisos

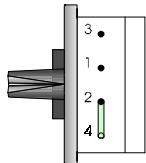
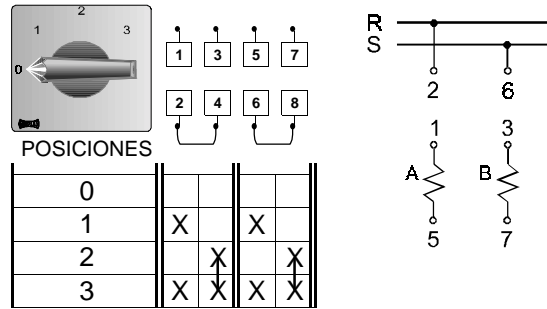
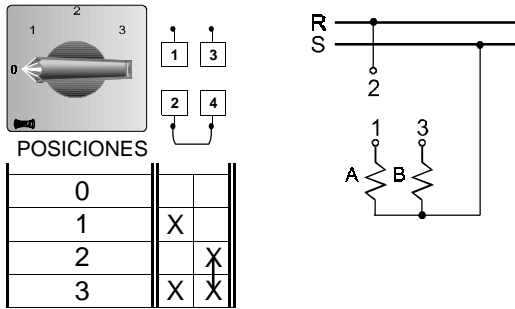

B-330 CONMUTADOR
2 Grupos serie unipolar
1 Piso

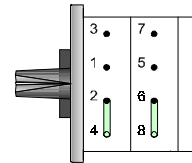

B-331 CONMUTADOR
2 Grupos serie bipolar
2 Pisos

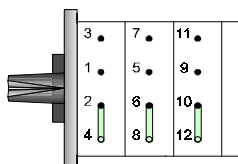
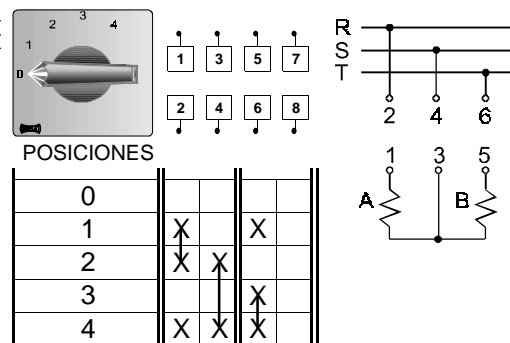
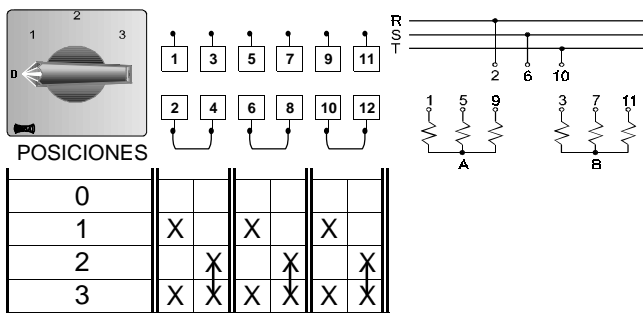

B-332 CONMUTADOR
2 Grupos serie tripolar
3 Pisos

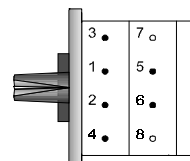

B-340 CONMUTADOR
2 Grupos serie paralelo tripolar
2 Pisos

ARRANCADORES ESTRELLA-TRIÁNGULO

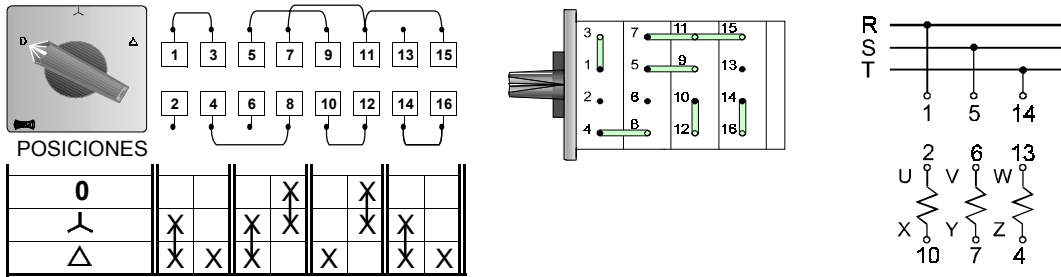

B-410 ARRANCADOR
Normal
4 Pisos

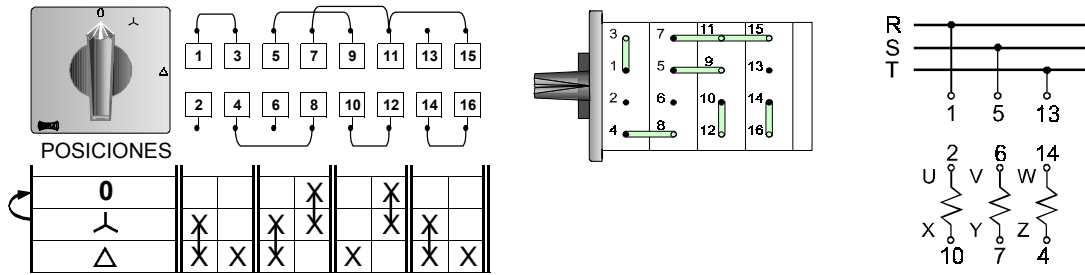

B-411 ARRANCADOR
Retorno de estrella a "0"
4 Pisos

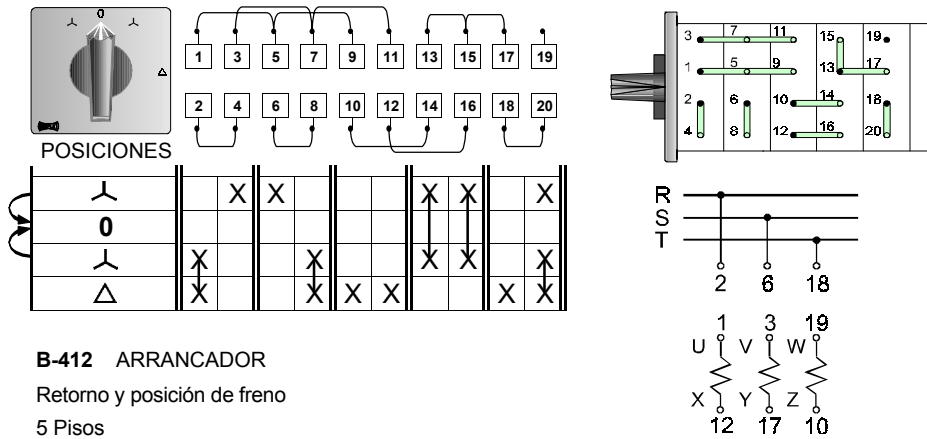

B-412 ARRANCADOR
Retorno y posición de freno
5 Pisos

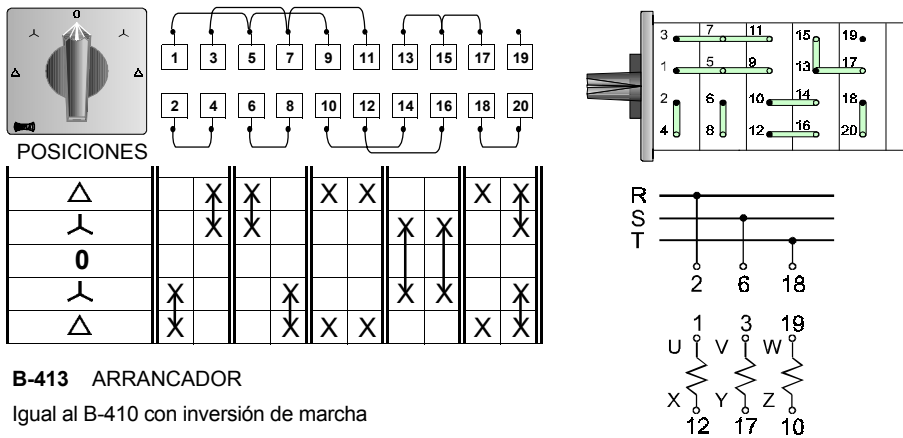

B-413 ARRANCADOR
Igual al B-410 con inversión de marcha
5 Pisos

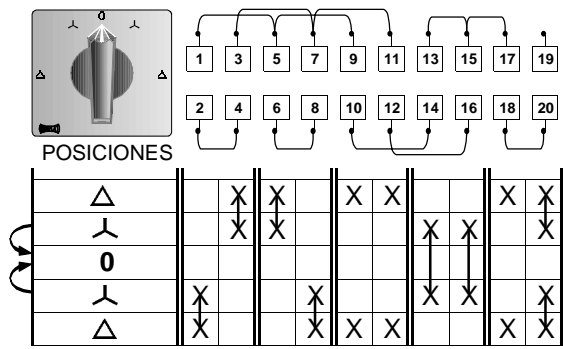

B-414 ARRANCADOR
Igual al B-413 con retornos de estrella a "0"
5 Pisos

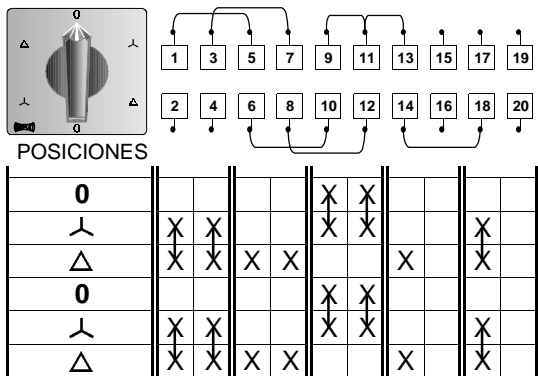
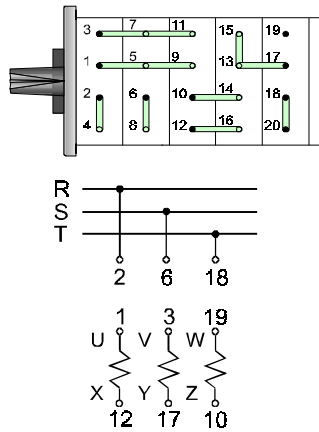

B-415 ARRANCADOR
Giro en una sola dirección
5 Pisos

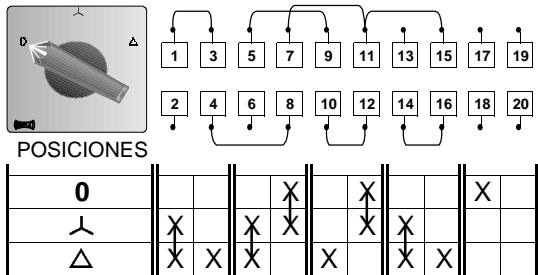
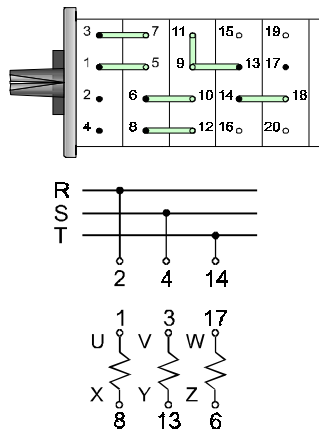

B-416 ARRANCADOR
Con contactor cerrado en posición "0"
5 Pisos

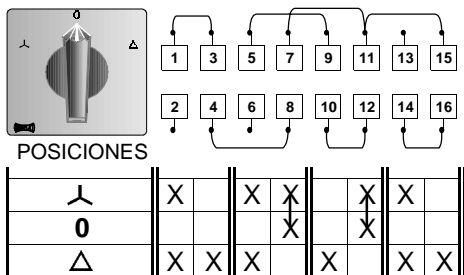
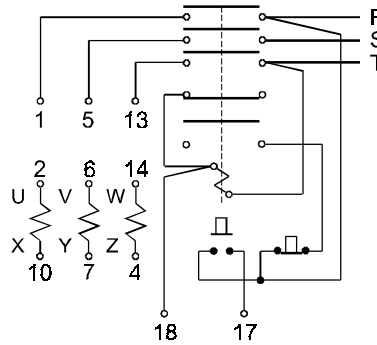

B-417 ARRANCADOR
Selector
4 Pisos

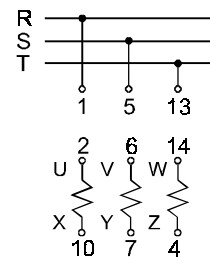
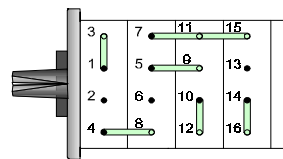

CONMUTADORES PARA CONTROL DE MOTORES

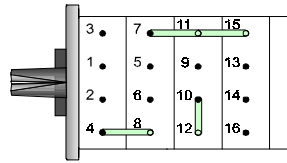
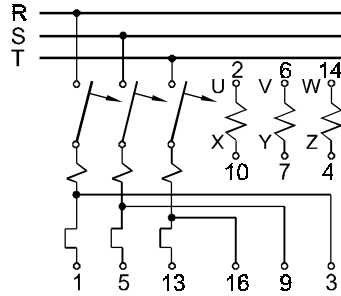
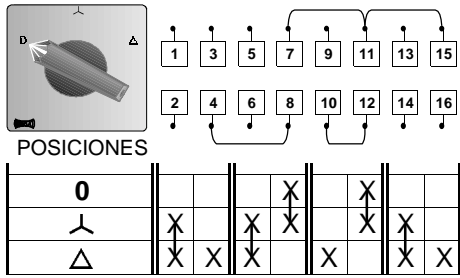

B-418 ARRANCADOR
 Contactor y protección sobre cargas
 4 Pisos

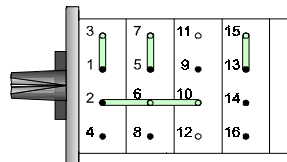
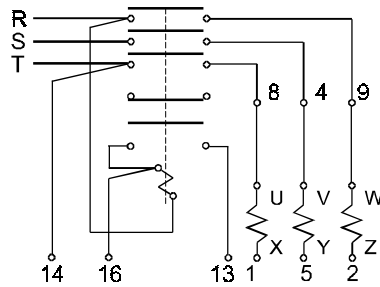
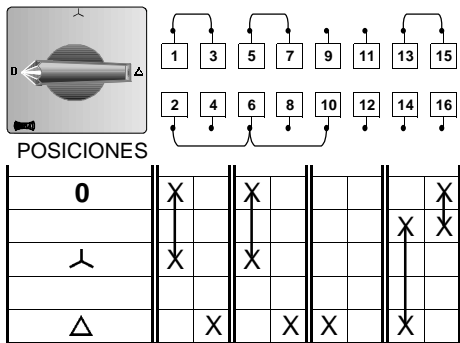

B-419 ARRANCADORES ESTRELLA-TRIANGULO
 Simplificado para contactor
 4 Pisos

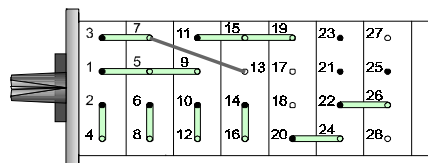
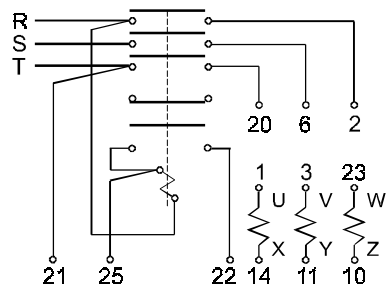
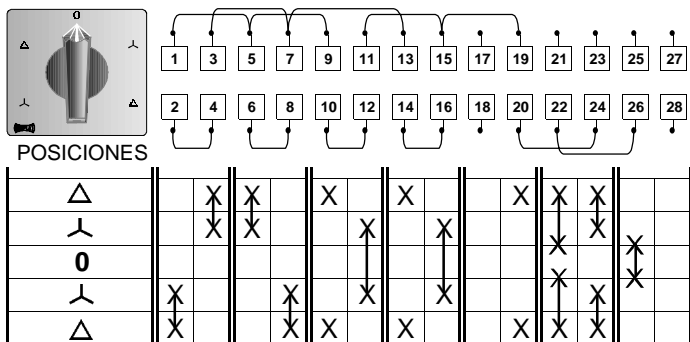

B-420 ARRANCADOR
 Con contactores inversión de marcha
 7 Pisos

ARRANCADORES PARA MOTORES FASE PARTIDA

B-425 ARRANCADOR
Arranque y retorno de marcha a "1".
2 Pisos

B-426 ARRANCADOR
Igual al B-425 con inversor
3 Pisos

B-427 ARRANCADOR
Arranque a 125 V ó 220 V.
3 Pisos

B-622 ARRANCADOR
Motor monofásico con inversión
3 Pisos

CONMUTADORES DE POLOS 2 VELOCIDADES

B-440 CONMUTADOR
1 Devanado 0-1-2
4 Pisos

CONMUTADORES PARA CONTROL DE MOTORES

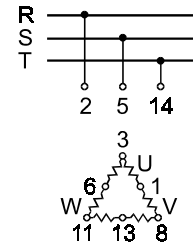
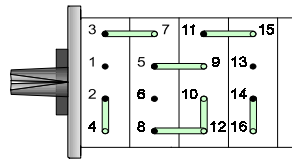
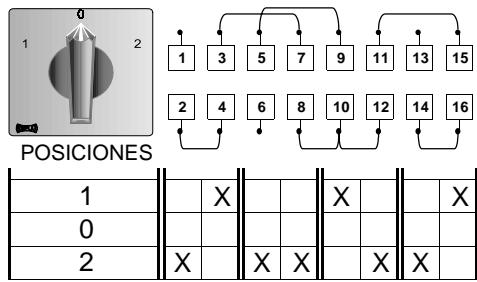

B-441 CONMUTADOR

1 Devanado 1-0-2
4 Pisos

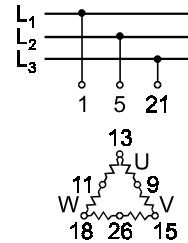
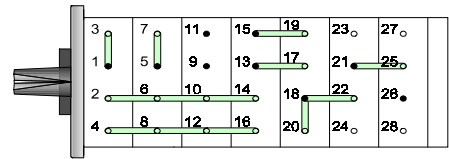
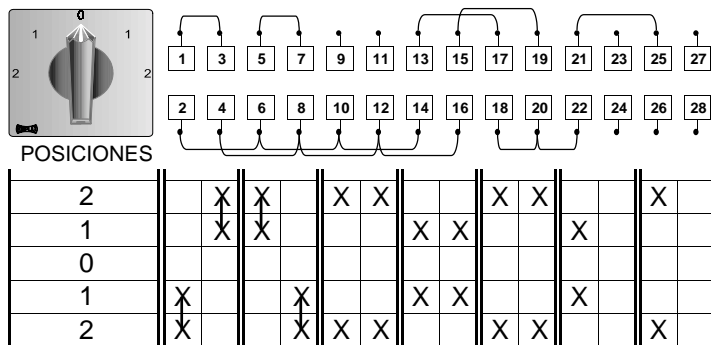

B-442 CONMUTADOR

1 Bobinado con inversión de marcha
7 Pisos

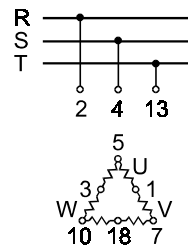
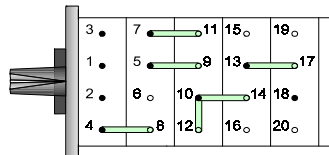
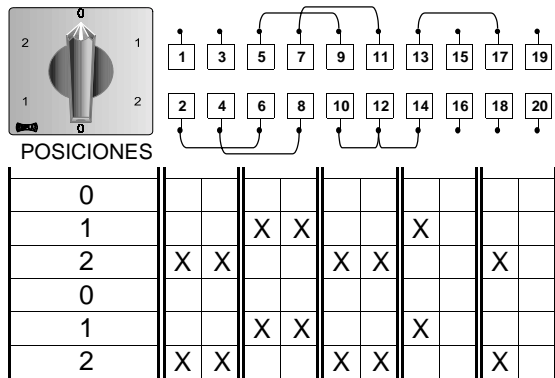

B-443 CONMUTADOR

1 Devanado, giro unidireccional del mando
5 Pisos

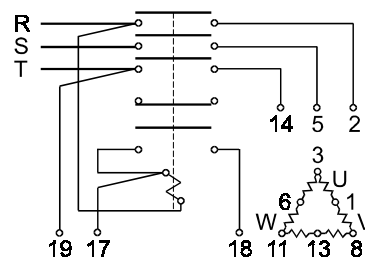
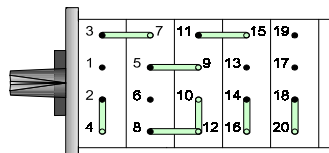
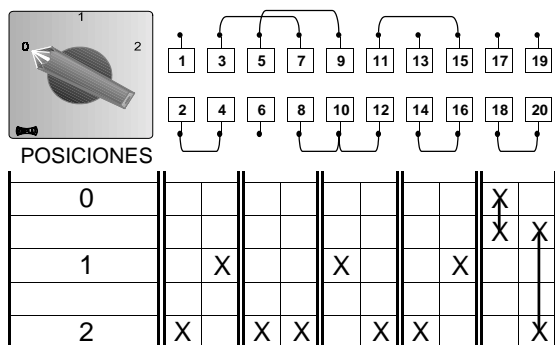

B-444 CONMUTADOR

1 Devanado para contactores
5 Pisos

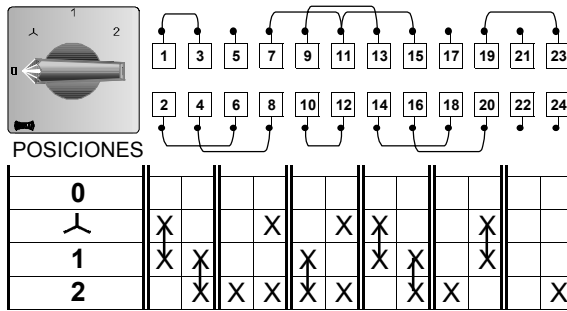

B-445 CONMUTADOR
 1 Devanado 0-Estrella-1-2
 6 Pisos

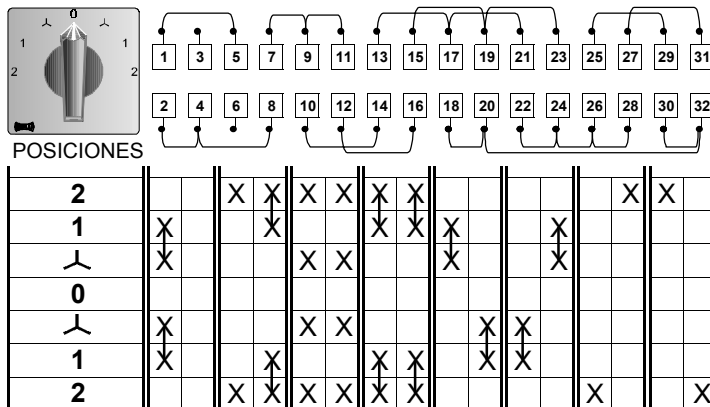
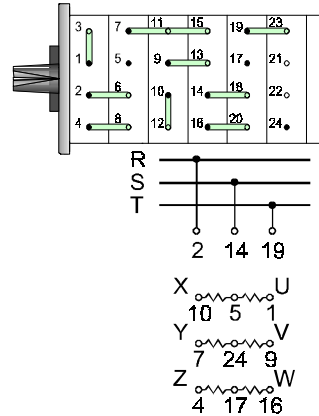

B-446 CONMUTADOR
 1 Devanado 0-Estrella-1-2 con inversión de marcha
 8 Pisos

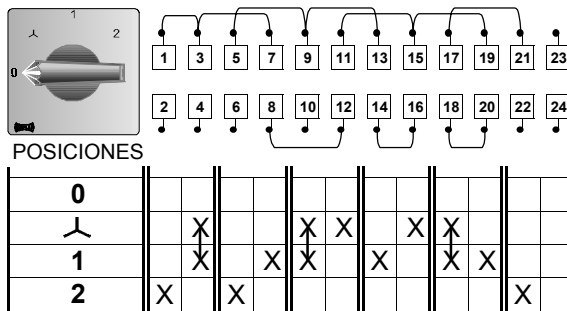
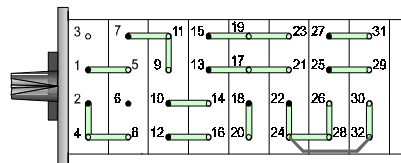

B-449 CONMUTADOR
 Arrollamiento separado 0-Estrella-1-2
 6 Pisos

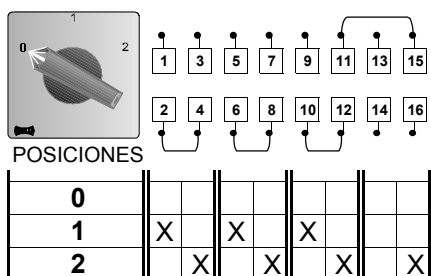
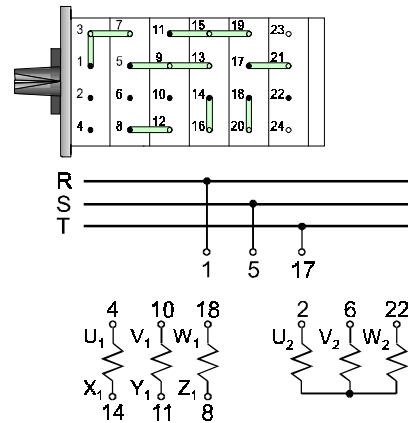

B-450 CONMUTADOR
 2 Devanados 0-1-2
 4 Pisos

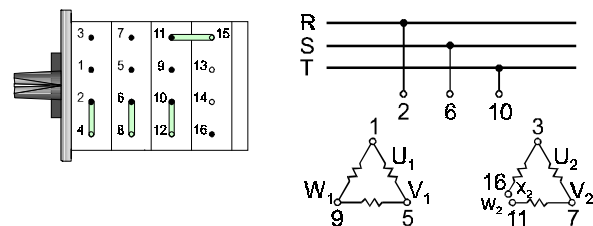

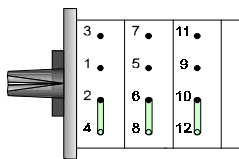
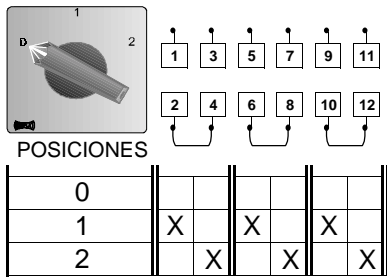

B-451 CONMUTADOR

2 velocidades 2 devanados 0-1-2 en Estrella-Triángulo
3 Pisos

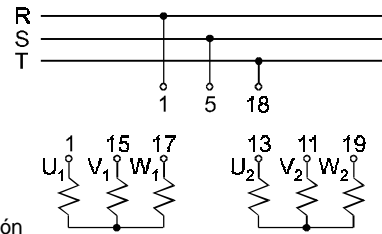
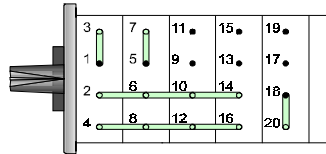
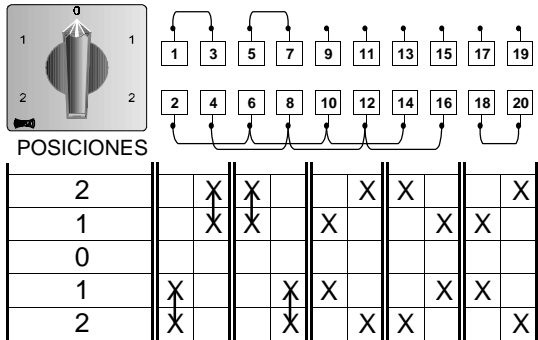
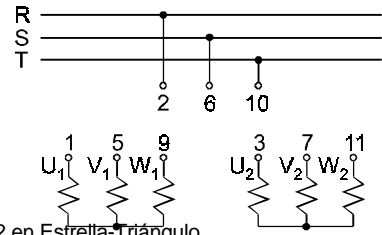

B-453 CONMUTADOR

2 Velocidades 2 Devanados 0-1-2 en estrella/Triángulo con Inversión
5 Pisos

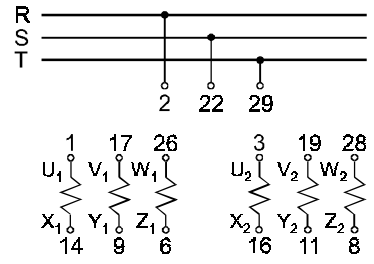
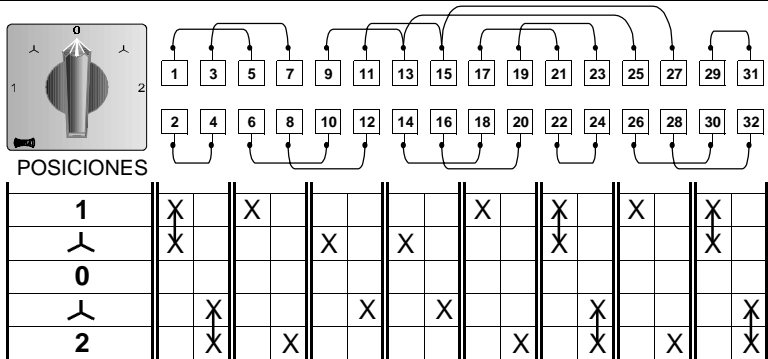

B-454 CONMUTADOR

2 velocidades 2 devanados 0-Estrella-Triángulo
8 Pisos

CONMUTADORES DE POLOS 3 VELOCIDADES

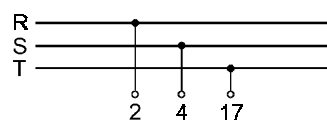
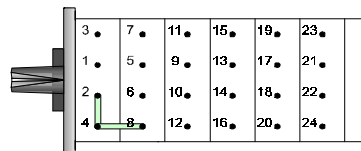
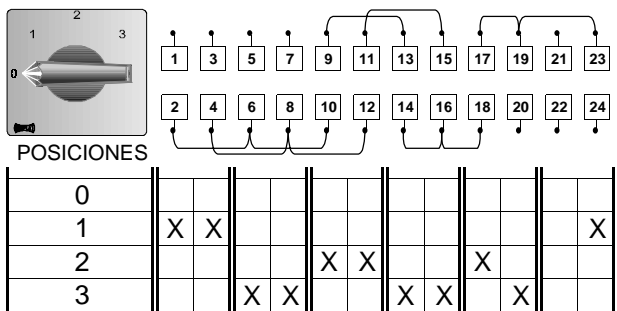

B-455 CONMUTADOR

3 velocidades 2 devanados 0-1-2-3
6 Pisos

B-456 CONMUTADOR
3 velocidades 2 devanados con Inversión
9 Pisos

POSICIONES	1	3	5	7	9	11	13	15	17	19	21	23	25	27	29	31	33	35
3		X	X			X	X			X		X						X
2		X	X			X			X	X							X	
1		X	X		X			X			X							
0	X			X		X			X			X						
1	X			X		X			X			X						
2	X			X		X			X			X						
3	X			X		X			X			X						

B-457 CONMUTADOR
Conmutador 3 velocidades 2 arrollamientos
6 Pisos

POSICIONES	1	3	5	7	9	11	13	15	17	19	21	23
0												
1				X	X			X				
2	X	X										X
3			X	X			X	X		X		

B-458 CONMUTADOR
Conmutador 3 velocidades 2 arrollamiento con inversión
9 Pisos

POSICIONES	1	3	5	7	9	11	13	15	17	19	21	23	25	27	29	31	33	35
3		X	X			X	X			X	X			X	X			X
2		X	X			X			X	X				X				
1		X	X		X			X			X							
0	X			X		X			X			X						
1	X			X		X			X			X						
2	X			X		X			X			X						
3	X			X		X			X			X						

B-459 CONMUTADOR
Conmutador 3 velocidades 2 arrollamientos
6 Pisos

POSICIONES	1	3	5	7	9	11	13	15	17	19	21	23
0												
1				X	X			X				
2	X	X										X
3			X	X			X	X		X		

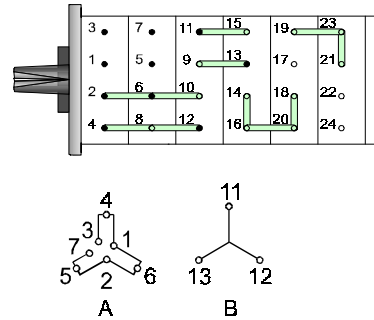
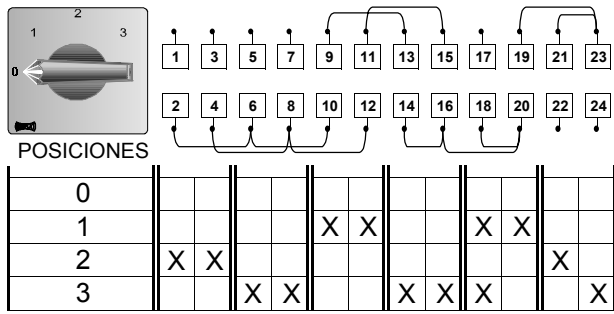

B-605 CONMUTADOR

2 Arrollamientos por constante

6 Pisos

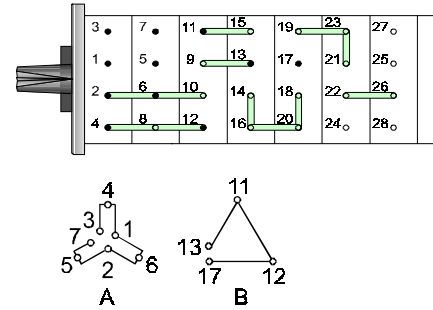
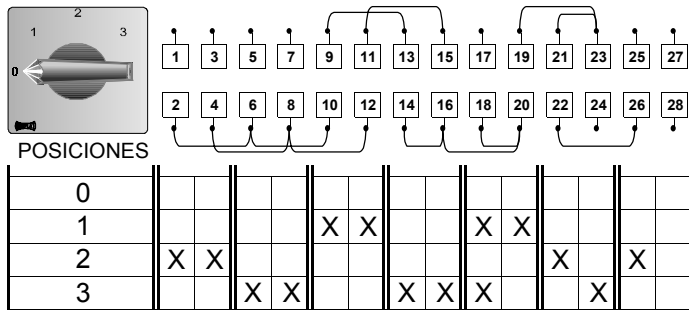

B-606 CONMUTADOR

2 Arrollamientos por constante

7 Pisos

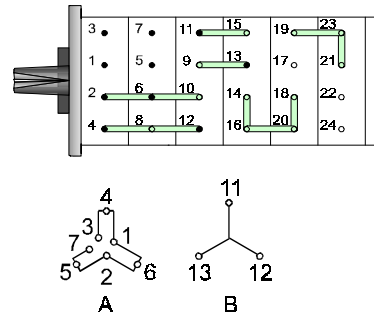
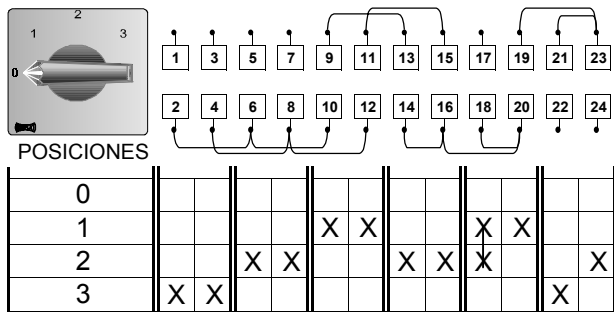

B-607 CONMUTADOR

2 Arrollamientos por constante

6 Pisos

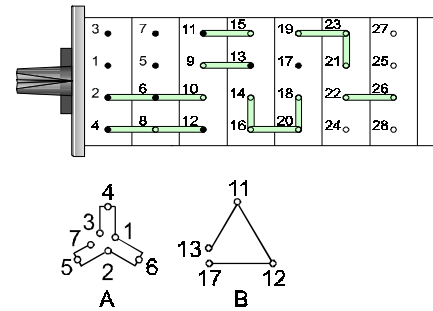
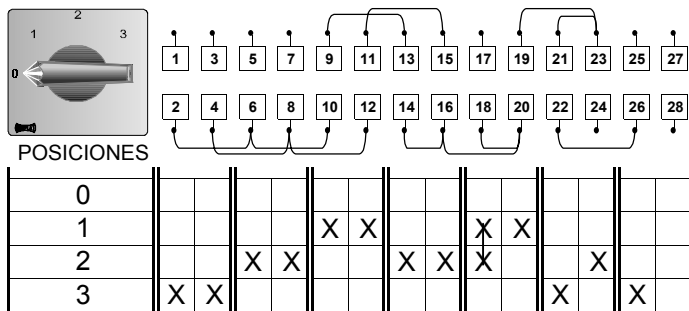

B-608 CONMUTADOR

2 Arrollamientos por constante

7 Pisos

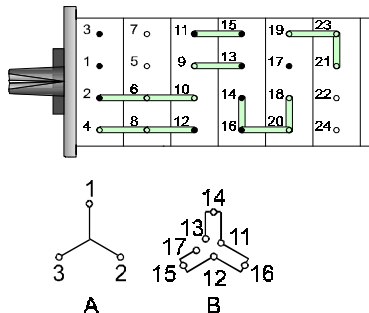
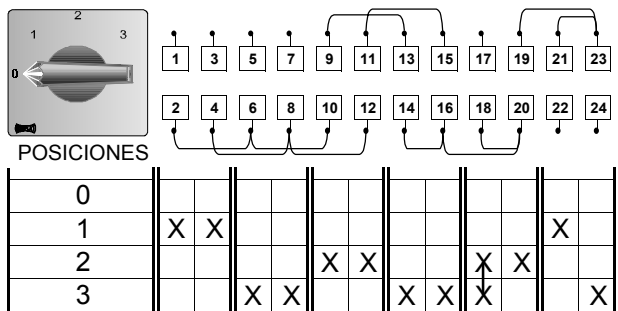

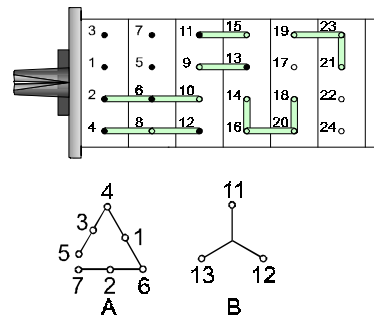
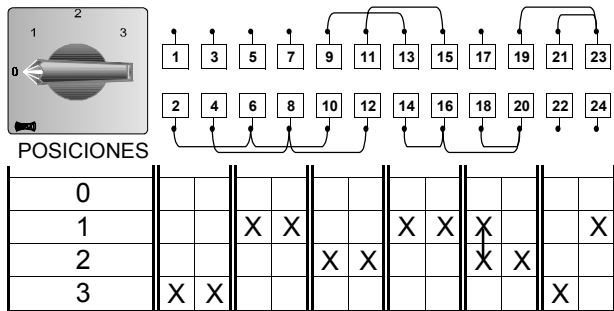

B-615 CONMUTADOR

2 Arrollamientos potencia constante

6 Pisos

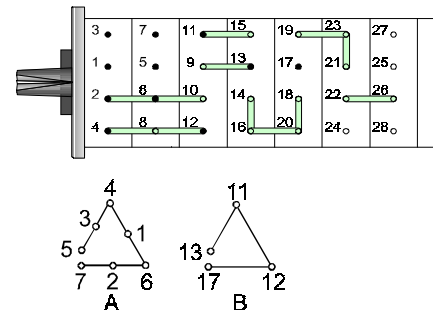
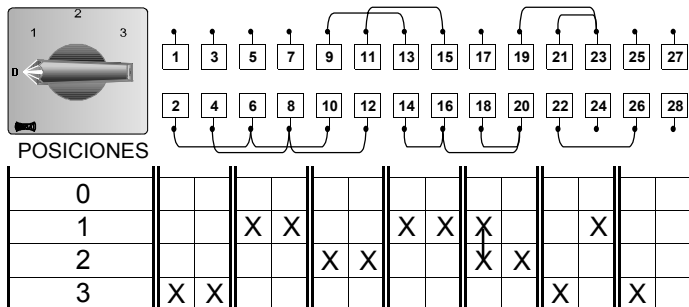

B-616 CONMUTADOR

2 Arrollamientos potencia constante

7 Pisos

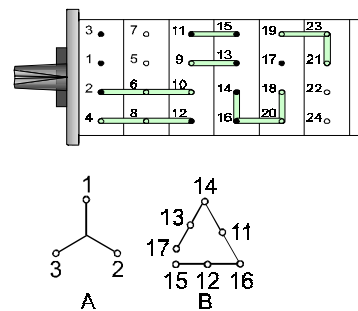
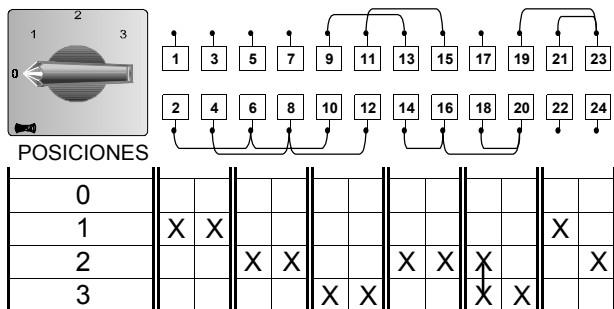

B-617 CONMUTADOR

2 Arrollamientos potencia constante

6 Pisos

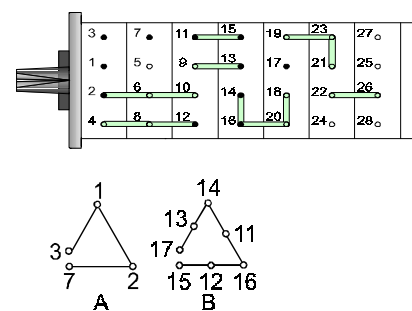
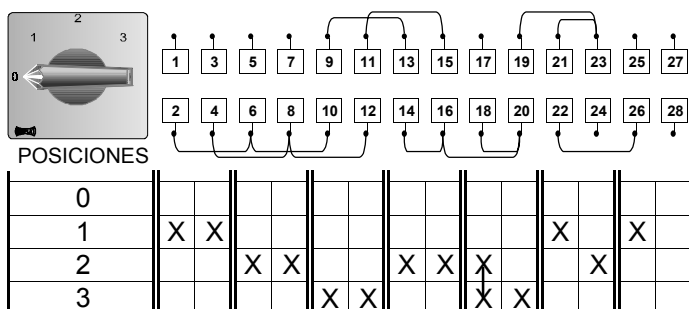

B-618 CONMUTADOR

2 Arrollamientos potencia constante

7 Pisos

