

Radiomonitoring & Radiolocation Catalog 2016



R&S®DDF5GTS
High-Speed Scanning Direction Finder



R&S®EM100XT
Digital Compact Receiver

Rohde & Schwarz provides a wide range of signal intelligence, electronic warfare and spectrum monitoring solutions. Standalone products as well as turnkey systems support numerous tasks, from signal detection and analysis to evaluation of emitter geolocation and many other vital measurements.



R&S®Mobile Monitoring Solutions



R&S®MobileLocator

Radiomonitoring & Radiolocation Catalog 2016

Chapter	Contents	Page
	Company Profile	2
	Our business fields	2
	Rohde&Schwarz worldwide	6
	Global service and sales locations	7
	Trademarks	7
1	Antennas	9
	Formulas	
2	Receivers	19
	Introduction	
3	Direction Finders	61
	Introduction into Theory of Direction Finding	
4	Analyzers	113
	Introduction	
5	System Devices and Accessories	141
6	Off-the-Shelf Software and Systems	151
7	System Applications	201
8	Appendix	231

For more than 80 years, Rohde & Schwarz has stood for quality, precision and innovation in all fields of wireless communications.



The privately owned company group has a global presence. It develops, produces and markets a wide range of electronic capital goods for industry, infrastructure operators and government customers.

Rohde & Schwarz is among the market leaders in all of its business fields, offering innovative solutions in a wide range of areas such as wireless communications, EMC test and measurement, TV broadcasting, TV test and measurement, encryption technology and the interception and analysis of radio signals.

Numerous subsidiaries and representatives not only ensure competent and customer-oriented on-site support anywhere in the world, they also safeguard customer investments with comprehensive service and support offerings.

Our business fields

Test and measurement

T&M instruments and systems for wireless communications, automotive, general purpose electronics and aerospace and defense applications

Broadcast and media

Broadcast, T&M and studio equipment for network operators, broadcasters, studios, the film industry and manufacturers of entertainment electronics

Secure communications

Communications systems for air traffic control (ATC) and armed forces, encryption technology for government authorities and critical infrastructures

Cybersecurity

Security products to protect IT infrastructures against cyber attacks

Radiomonitoring and radiolocation

Spectrum monitoring systems and radiomonitoring equipment for regulatory authorities as well as for homeland and external security

Test and measurement

Rohde & Schwarz is one of the world's largest manufacturers of electronic test and measurement equipment. Our products set standards in research, development, production and service. As a key partner of industry, network operators and public institutions, we offer a broad spectrum of market-leading solutions for state-of-the-art technologies, including LTE-Advanced, the wireless standard of the next generation, as well as for microwave applications up to 500 GHz. New applications in the automotive and aerospace fields, in material research and in video technology promote the trend toward ever higher frequencies in electronics. Rohde & Schwarz meets the growing demand by offering cutting-edge products for signal generation, signal analysis, network analysis and power measurements. The company is systematically expanding its oscilloscope portfolio to meet the wide-ranging needs of customers, also in the lower price segment with products that are ideal for general lab applications.

Our test and measurement portfolio

- ▮ Test and measurement solutions for all wireless technologies
 - Wireless device testers
 - Infrastructure testers
 - Protocol testers
 - Conformance/preformance testers
 - Drive test solutions
 - Test systems and accessories
- ▮ Signal and spectrum analyzers
- ▮ Network analyzers
- ▮ Oscilloscopes
- ▮ Signal generators
- ▮ Mobile network testing
- ▮ EMC and field strength test solutions
- ▮ Power meters and voltmeters
- ▮ Audio analyzers
- ▮ Modular instruments
- ▮ Power supplies
- ▮ RF and microwave accessories
- ▮ System components
- ▮ Broadcasting and video T&M and monitoring solutions (see next page)

Test and measurement.



Broadcast and media

TV viewers and radio listeners in more than 80 countries receive their programs via Rohde&Schwarz transmitters. Our broadcast, T&M and studio equipment is advancing digital broadcasting and the processing of high-resolution video formats around the globe. For example, the first terrestrial UltraHD TV program is broadcast over Rohde&Schwarz transmitters.

We offer broadcasters, studios and network operators solutions for the production, post production and distribution of audiovisual signals. Our solutions support all formats and resolutions, and cover the entire signal processing chain – from the recording location to the network feed via headends to terrestrial broadcasting.

Rohde&Schwarz supplies producers of consumer electronics with all necessary T&M equipment for the development and production of satellite receivers, TVs and other consumer electronics equipment, also and especially for high-resolution formats such as UltraHD. Rohde&Schwarz multistandard platforms cover the wide variety of broadcast and video technologies, providing great flexibility at all stages of the value chain.

Secure communications

Radiocommunications systems Today's military missions are typically based on joint operations in a multinational environment. The key to success is achieving information superiority through network centric operations. Rohde&Schwarz supplies interoperable radiocommunications systems for deployment on land, at sea and in the air. Our solutions use efficient encryption methods that satisfy the highest national and international security standards. With powerful waveforms, high data rates and support of IP-based applications, the R&S®SDTR software defined tactical radio opens up new fields of application.

Civil air traffic control agencies in 80 countries and at more than 200 airports and ATC centers count on reliable radio systems from Rohde&Schwarz. The company offers complete, state-of-the-art, IP-based communications solutions – from the controller working position to the antenna.

Encryption technology Rohde&Schwarz develops highly secure products for protected voice and data transmission via wireless and fixed links – for the military, government authorities and critical infrastructures.

Cybersecurity

Reliable organizations estimate that cyber attacks, especially theft of intellectual property, cause worldwide economic damage in the three-digit billion dollar range. Intangible assets are not the only industry assets that need

Our broadcasting portfolio

- Digital and analog TV transmitters for all power classes and all conventional standards worldwide
- Digital and analog sound broadcast transmitters
- Audio/video headends
- Broadcasting and video T&M and monitoring solutions
- Hardware and software for professional film and video post production

Our secure communications portfolio

- Integrated communications systems for
 - Civil and military air traffic control (ATC)
 - Army
 - Navy
 - Air force
- Encryption technology for all classification levels

Broadcast and media.



Secure communications.



protection. Confidential personal data, which can run to large volumes in the financial sector, health care and online commerce, also has to be protected.

We offer a wide portfolio of technologically leading solutions for protecting IT infrastructures. These range from easy-to-administrate, all-in-one security solutions for small and medium-sized enterprises (SME) to next-generation firewalls for large companies.

Radiomonitoring and radiolocation

The demand for mobile, wireless exchange of information is continually increasing, but the usable frequency spectrum for radiocommunications and broadcasting is limited. As a result, it can be expensive when the market determines the price, e.g. in spectrum auctions. That is why it is important that regulatory authorities ensure proper technical and legal use of the spectrum. Network operators also have a vital interest in an error-free, performance-optimized infrastructure and require technical means to ensure this service. Rohde&Schwarz provides the necessary equipment.

The company's receivers, direction finders, signal analyzers, antennas and customized systems have made Rohde&Schwarz a reliable partner to its customers for decades. Applications include sovereign spectrum management by regulatory authorities and technical monitoring of radio networks by their operators as well as securing

critical infrastructures such as power plants and also radiomonitoring to ensure homeland and external security.

Services

Rohde&Schwarz operates a global service network in order to safeguard the investments of its customers. The following on-site services are offered worldwide:

- ▮ Calibration
- ▮ Maintenance and repair
- ▮ Product updates and upgrades

Rohde&Schwarz regional service centers, plants and specialized subsidiaries provide a wide range of additional services:

- ▮ System integration, system support
- ▮ Installation and commissioning
- ▮ Application support
- ▮ Development of customized modules, instruments and systems, software development
- ▮ Mechanical and electrical design
- ▮ Manufacturing to order
- ▮ Technical documentation
- ▮ Logistics concepts

Service that adds value

- ▮ Worldwide
- ▮ Local and personalized
- ▮ Customized and flexible
- ▮ Uncompromising quality
- ▮ Long-term dependability

Our cybersecurity portfolio

- ▮ Unified threat management
- ▮ (UTM) firewall solutions
- ▮ Next-generation firewalls
- ▮ Crypto products

Our radiomonitoring and radiolocation portfolio

- ▮ Signal intelligence systems (SIGINT)
- ▮ Spectrum monitoring systems
- ▮ Satellite monitoring systems
- ▮ Signal analysis systems
- ▮ Receivers
- ▮ Direction finders
- ▮ Antennas
- ▮ Solutions for analyzing IP data streams

Radiomonitoring and radiolocation.



Services.



Rohde & Schwarz

worldwide

Headquarters

At company headquarters in Munich, around 2500 employees work in research and development, central sales and service, marketing and administration.

Contact

Corporate communications

Rohde & Schwarz GmbH & Co. KG
Corporate Communications
Mühldorfstraße 15
81671 Munich, Germany
Phone +49 89 4129 139 58
Fax +49 89 4129 135 63
press@rohde-schwarz.com

Sales

The addresses of the local sales companies can be found at: www.sales.rohde-schwarz.com

Customer support

Our regional support centers will be happy to answer any questions regarding our products and service:

- Europe, Africa, Middle East
Phone +49 89 4129 123 45
customersupport@rohde-schwarz.com
- North America
Phone 1 888 837 87 72 (1 888 TEST RSA)
customer.support@rsa.rohde-schwarz.com
- Latin America
Phone +1 410 910 79 88
customersupport.la@rohde-schwarz.com
- Asia Pacific
Phone +65 65 13 04 88
customersupport.asia@rohde-schwarz.com
- China
Phone +86 800 810 82 28 (+86 400 650 58 96)
customersupport.china@rohde-schwarz.com

Plants

Memmingen plant

info.memmingen@rohde-schwarz.com

Teisnach plant

info.teisnach@rohde-schwarz.com

Vimperk plant

info.vimperk@rohde-schwarz.com

Singapore and Malaysia plants

Phone +65 6307 0000

Subsidiaries

Arpège SAS

arpege@arpege-defense.com

Rohde & Schwarz DVS GmbH

info.dvs@rohde-schwarz.com

GEDIS GmbH

sales.gedis@rohde-schwarz.com

ipoque GmbH

info@ipoque.com

R&S Systems GmbH

info.rssys@rohde-schwarz.com

Rohde & Schwarz SIT GmbH

info.sit@rohde-schwarz.com

RPG Radiometer Physics GmbH

info@radiometer-physics.de

Rohde & Schwarz Topex S.A.

sales.topex@rohde-schwarz.com

SwissQual AG

info@swissqual.com

Global service and sales locations



Trademarks

Trade names are trademarks of the owners

- R&S® is a registered trademark of Rohde & Schwarz GmbH & Co. KG.
Example: R&S®ESMD wideband monitoring receiver
- Windows is a registered trademark of Microsoft Corp., USA
- WiMAX Forum is a registered trademark of the WiMAX Forum. WiMAX, the WiMAX Forum logo, WiMAX Forum Certified and the WiMAX Forum Certified logo are trademarks of the WiMAX Forum
- CDMA2000® is a registered trademark of the Telecommunications Industry Association (TIA-USA)

Published by

Rohde & Schwarz GmbH & Co. KG
 Compilation, layout: Silke Knobloch, Department GF-MC1
 Translation: Department GF-MC7

Chapter 1

Antennas

Receiving signals from 100 Hz to 40 GHz

The Rohde&Schwarz product line encompasses a wide range of highly sensitive active and passive antennas for mobile and stationary use, providing complete coverage of the 100 Hz to 40 GHz frequency range. Especially in radiomonitoring and radiolocation applications, our broadband antennas minimize the number of antennas needed. Our monitoring antennas can be easily arranged on a single mast using both directional and/or omnidirectional elements to provide optimum reception for any polarized signal. All antennas are fit for use under extreme weather conditions. Besides single antenna products we offer complete systems as well. These antenna systems can be controlled easily and efficiently with a commercial PC and our software running under Windows XP or Windows 7.

Rohde&Schwarz offers an extensive line of equipment for the microwave range:

- Antenna reflectors of different sizes with optimized shape
- Optimized broadband feeds with high polarization decoupling even at 26.5 GHz
- Integrated preamplifiers for system optimization
- Complete antenna systems for full coverage from 850 MHz to 40 GHz

Description	Page
Formulas	11
Antenna Selection Guide	17

Antennas are specified in the

[HF – VHF/UHF – SHF Antennas Catalog \(PD 0758.0368.42\)](#)

Formulas

General	
Prefix	Value
T (Tera)	10^{12}
G (Giga)	10^9
M (Mega)	10^6
k (kilo)	10^3
h (hecto)	10^2
da (deca)	10^1
d (deci)	10^{-1}
c (centi)	10^{-2}
m (milli)	10^{-3}
μ (micro)	10^{-6}
n (nano)	10^{-9}
p (pico)	10^{-12}
f (femto)	10^{-15}
a (atto)	10^{-18}

Frequency ranges				
Range	f	λ	Classification	Principal use
VLF	3 kHz to 30 kHz	100 km to 10 km	Very low frequency	Submarines
LF	30 kHz to 300 kHz	10 km to 1 km	Low frequency	Beacons
MF	300 kHz to 3 MHz	1000 m to 100 m	Medium frequency	AM broadcasting
HF	3 MHz to 30 MHz	100 m to 10 m	High frequency	Shortwave communications
VHF	30 MHz to 300 MHz	10 m to 1 m	Very high frequency	FM, TV, ATC
UHF	300 MHz to 3 GHz	1 m to 0.1 m	Ultra high frequency	TV, LAN, cellular services, GPS, ATC
SHF	3 GHz to 30 GHz	10 cm to 1 cm	Super high frequency	Radar, GSO satellites, data transmission
EHF	30 GHz to 300 GHz	10 mm to 1 mm	Extremely high frequency	Radar, automotive applications

Frequency notations		
Frequency	Old band notation	New band notation
0.5 GHz to 1.0 GHz	–	C
1.0 GHz to 2.0 GHz	L	D
2.0 GHz to 3.0 GHz	S	E
3.0 GHz to 4.0 GHz	S	F
4.0 GHz to 6.0 GHz	C	G
6.0 GHz to 8.0 GHz	C	H
8.0 GHz to 10.0 GHz	X	I
10.0 GHz to 12.5 GHz	X	J
12.5 GHz to 18.0 GHz	Ku	J
18.0 GHz to 20.0 GHz	K	J

Frequency notations		
Frequency	Old band notation	New band notation
20.0 GHz to 26.5 GHz	K	K
26.5 GHz to 40.0 GHz	Ka	K
40.0 GHz to 60.0 GHz	Q, V, W	L
60.0 GHz to 100.0 GHz	W	M

Measures of length	
Distance	Equivalent to
1 meter (m)	= 10 decimeters (dm) = 100 centimeters (cm) = 1000 millimeters (mm) = 1 000 000 micrometers (μm)
1 kilometer (km)	= 1000 m
1 sea mile	= 10 cable lengths = 1852 m
1 English statute mile	= 1760 yards = 1609 m
1 yard	= 3 feet = 36 inches = 91.44 cm
1 inch (in)	= 25.4 mm (accurately 25.399956 mm)

Inch to mm	
Inch	mm
1/64	0.397
1/32	0.794
1/16	1.587
1/8	3.175
3/16	4.762
1/4	6.350
3/8	9.525
1/2	12.700
5/8	15.875
3/4	19.050
7/8	22.225
1	25.400

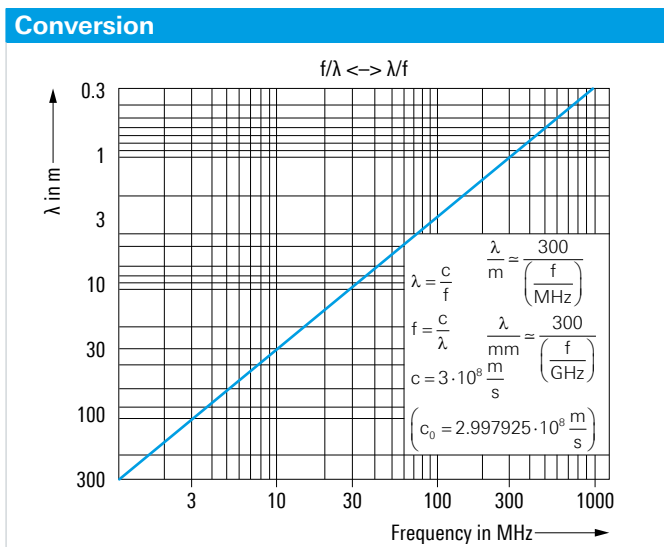

Reflection, matching

s	VSWR	r	Reflection coefficient	a _R	Return loss	
s	r	a _R	(VSWR)	V ← V →	P _{refl} in %	a _R in dB 20 lg (V ← / V →)
1.01	0.005					46.1
1.02	0.010	0.01				40.1
1.03	0.015	0.02				36.6
1.04	0.020	0.04				34.2
1.05	0.024	0.06				32.3
1.06	0.029	0.08				30.7
1.07	0.034	0.11				29.4
1.08	0.038	0.15				28.3
1.09	0.043	0.19				27.3
1.10	0.048	0.23				26.4
1.11	0.052	0.27				25.6
1.12	0.057	0.32				24.9
1.13	0.061	0.37				24.3
1.14	0.065	0.43				23.7
1.15	0.070	0.49				23.1
1.16	0.074	0.55				22.6
1.17	0.078	0.61				22.1
1.18	0.083	0.68				21.7
1.19	0.087	0.75				21.2
1.20	0.091	0.83				20.8
1.30	0.130	1.70				17.7
1.40	0.167	2.78				15.6
1.50	0.200	4.00				14.0
1.60	0.231	5.33				12.7
1.70	0.259	6.72				11.7
1.80	0.286	8.16				10.9
1.90	0.310	9.63				10.2
2.00	0.333	11.10				9.5
2.20	0.375	14.1				8.5
2.40	0.412	17.0				7.7
2.60	0.444	19.8				7.0
2.80	0.474	22.4				6.5
3.00	0.500	25.0				6.0
3.50	0.556	30.9				5.1
4.00	0.600	36.0				4.4
5.00	0.667	44.4				3.5
6.00	0.714	51.0				2.9
7.00	0.750	56.2				2.5
8.00	0.778	60.5				2.2
10.0	0.818	66.9				1.7
20.0	0.905	81.9				0.9
50.0	0.961	92.3				0.3

$s = \frac{1+ r }{1- r }$ $s = \frac{10^{0.05a_R+1}}{10^{0.05a_R-1}}$	$r = \frac{s-1}{s+1}$ $r = \frac{1}{10^{0.05a_R}}$	$a_R = 20 \lg \left(\frac{s+1}{s-1} \right)$ $a_R = 20 \lg \left(\frac{1}{ r } \right)$
---	--	---

Smith diagram

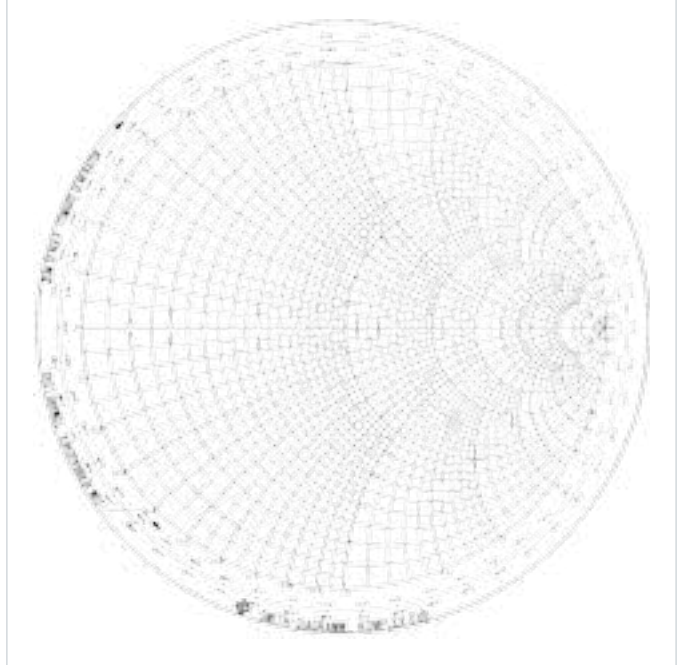

VSWR and return loss

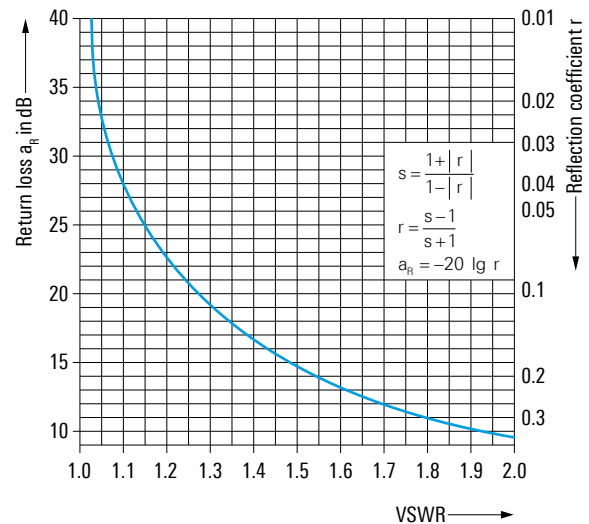
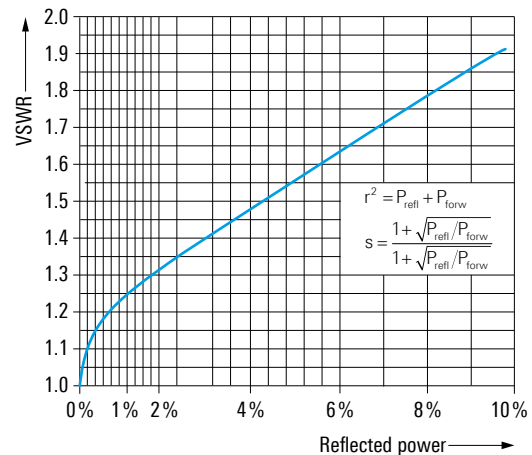

Voltage and power ratio

Levels ¹⁾			
Type of level	Definition	Unit	Abbreviation
Absolute power level	$10 \lg \frac{P}{1 \text{ mW}}$	dB(mW)	dBm
	$10 \lg \frac{P}{1 \text{ W}}$	dB(W)	dBW
Absolute voltage level	$20 \lg \frac{V}{1 \mu\text{V}}$	dB(μV)	dBμV
	$20 \lg \frac{V}{1 \text{ V}}$	dB(V)	dBV
Power density level referred to frequency	$10 \lg \frac{P/W}{\Delta f/\text{Hz}}$	dB(W/Hz)	–
Power density level referred to antenna surface	$10 \lg \frac{P/W}{A/\text{m}^2}$	dB(W/m ²)	–
Field strength level	$20 \lg \frac{E}{1 \mu\text{V/m}}$	dB(μV/m)	–
Relative level	$10 \lg \frac{P}{P_0}$ ¹⁾	–	dBr

¹⁾ P₀ = base power level.

Power, voltage

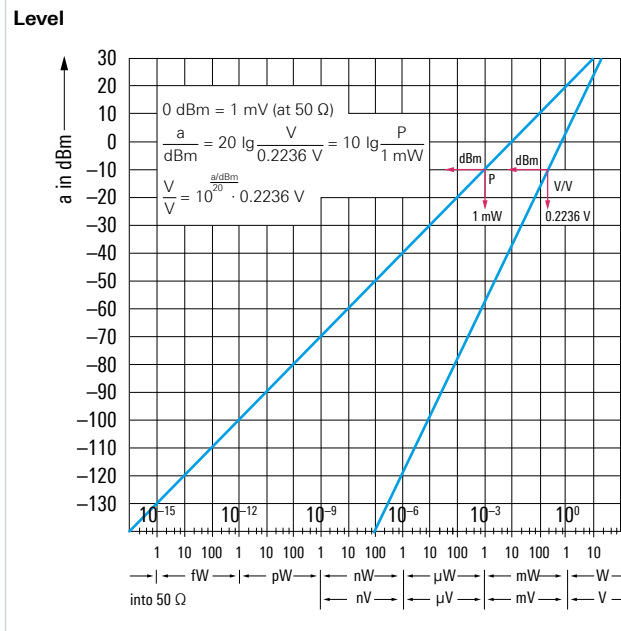

Power, voltage

Spherical coordinates

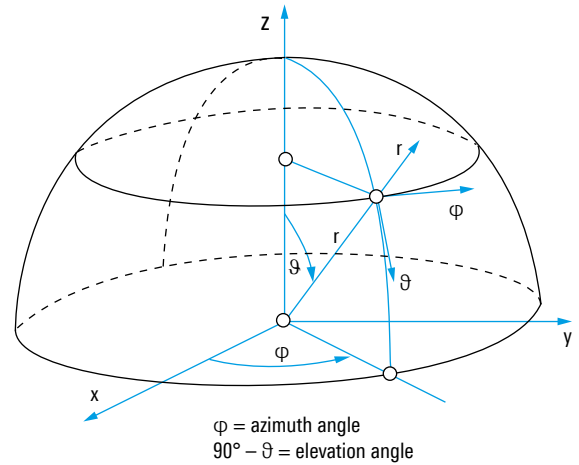

Inductance, capacitance

Cylindrical coil

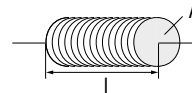

$$L \approx V_0 \cdot V_l \cdot N^2 \frac{A}{l}$$

$$\mu_0 = 4\pi \cdot 10^{-7} \frac{\text{Vs}}{\text{Am}}$$

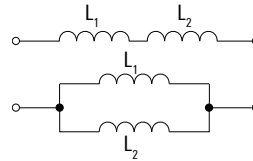

$$L_{\text{total}} = L_1 + L_2$$

$$L_{\text{total}} = \left(\frac{1}{L_1} + \frac{1}{L_2} \right)^{-1}$$

Inductance, capacitance

Plate capacitor

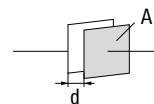

$$C \approx \epsilon_0 \cdot \epsilon_r \frac{A}{d}$$

$$\epsilon_0 = 8.8541 \cdot 10^{-12} \frac{\text{F}}{\text{m}}$$

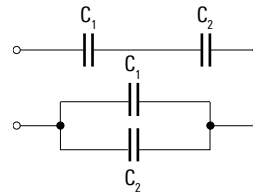

$$C_{\text{total}} = \left(\frac{1}{C_1} + \frac{1}{C_2} \right)^{-1}$$

$$C_{\text{total}} = C_1 + C_2$$

Frequency of a resonant circuit

$$f_0 = \frac{1}{2 \cdot \pi \cdot \sqrt{L \cdot C}}$$

f₀ = resonant frequency
 L = inductance
 C = capacitance

Intrinsic impedance of free space

$$Z_0 = \sqrt{\frac{\mu_0}{\epsilon_0}} = 120 \cdot \pi \Omega \approx 377 \Omega$$

Z_0 = intrinsic impedance of free space in Ω
 μ_0 = permeability of vacuum
 ϵ_0 = permittivity of vacuum

Correlation of E field and H field based on intrinsic impedance of free space

$$E = Z_0 \cdot H \quad \text{or} \quad H = \frac{E}{Z_0}$$

E = incident electric field strength
 H = incident magnetic field strength

Coaxial line impedance

$$Z_L \approx 60 \Omega \cdot \frac{1}{\sqrt{\epsilon_r}} \ln \left(\frac{D}{d} \right)$$

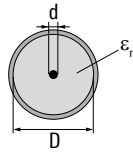

Z_L = line impedance
 ϵ_r = relative permittivity (dimensionless)
 D = outer diameter in m (see drawing)
 d = inner diameter in m (see drawing)

Symmetrical line impedance

$$Z_L \approx 120 \Omega \cdot \frac{1}{\sqrt{\epsilon_r}} \ln \left(\frac{2D}{d} \right) \quad (\text{valid for: } d \ll D)$$

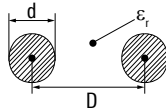

Z_L = line impedance
 ϵ_r = relative permittivity (dimensionless)
 D = spacing between the two lines in m (see drawing)
 d = diameter of each line in m (see drawing)

Directivity

$$D = \frac{P_{\max}}{P_{\text{av}}} \quad \text{and} \quad d = 10 \lg D$$

D = directivity of antenna (without any losses, linear, dimensionless)
 P_{\max} = maximum radiated power density in boresight direction of antenna
 P_{av} = average radiated power density of a spherical isotropic radiator
 d = logarithmic directivity value of antenna in dB

Gain (including ohmic losses)

$$G = \frac{P_{\max}}{P_{\text{av}0}} \quad \text{and} \quad g = 10 \lg G$$

G = gain of antenna (linear, dimensionless)
 P_{\max} = maximum radiated power density in boresight direction of antenna
 $P_{\text{av}0}$ = average radiated power density of a spherical isotropic radiator with an input power equal to that of the antenna of interest
 g = logarithmic gain value of antenna in dB

Radiation efficiency

$$\eta = \frac{G}{D} \quad \text{or} \quad G = \eta \cdot D$$

η = radiation efficiency of antenna (dimensionless)
 G = gain of antenna (including ohmic losses, dimensionless)
 D = directivity of antenna (without any losses, dimensionless)

Practical gain (including ohmic losses and mismatch losses)

$$G_p = G \cdot (1 - |r|^2)$$

G_p = practical gain of antenna (including ohmic losses and mismatch losses, dimensionless)
 G = gain of antenna (including ohmic losses, dimensionless)
 r = reflection coefficient (dimensionless)

Gain of active antennas

$$G_p = D \cdot G_e \quad \text{and} \quad g_p = 10 \lg G_p$$

G_p = practical gain of active antenna (dimensionless)
 D = directivity of passive antenna part (without any losses, dimensionless)
 G_e = gain of electronic circuit of antenna (dimensionless)
 g_p = logarithmic gain of active antenna

Effective aperture

$$A_e = G \cdot \frac{\lambda^2}{4\pi} \quad \text{or} \quad G = A_e \cdot \frac{4\pi}{\lambda^2}$$

A_e = effective aperture of antenna
 G = gain of antenna including ohmic losses (dimensionless)
 λ = wavelength of electromagnetic wave

Aperture efficiency ¹⁾

$$\epsilon_{\text{ap}} = \frac{A_e}{A_p}$$

ϵ_{ap} = aperture efficiency (dimensionless)
 A_e = effective aperture of antenna
 A_p = physical (geometrical) aperture of antenna

¹⁾ Significant for aperture antennas only (e.g. horns, reflectors).

Effective antenna length²⁾

$$h_e = \frac{V}{E} \quad \text{or} \quad V = E \cdot h_e \quad \text{and} \quad V = E \cdot \cos\theta \cdot \frac{\lambda}{\pi} \cdot \sqrt{\frac{R_r \cdot G}{Z_0}}$$

$$h_e = 2 \cdot \sqrt{\frac{R_r \cdot A_e}{Z_0}} \quad \text{or} \quad A_e = \frac{h_e^2 \cdot Z_0}{4 \cdot R_r}$$

h_e = effective antenna length

V = induced voltage

E = incident electric field strength

θ = angle between polarization angles of antenna and wave

λ = wavelength of electromagnetic wave

R_r = radiation resistance of antenna

G = gain of antenna including ohmic losses (linear, dimensionless)

Z_0 = intrinsic impedance of free space

A_e = effective aperture of antenna

Antenna factor

(only valid for a 50 Ω matched system)

$$K = \frac{E}{V} \quad \text{and} \quad K = \frac{2}{h_e}$$

K = antenna factor (linear)

E = incident electric field strength

V = induced voltage at a 50 Ω matched measurement device

h_e = effective antenna length

$$K = \frac{9.73}{\lambda \cdot \sqrt{G_p}}$$

λ = wavelength of electromagnetic wave

G_p = practical gain of antenna (including ohmic and mismatch losses, dimensionless)

$k = 20 \lg K$

k = logarithmic value of antenna factor

Free-space field strength (far field)

$$E_0 = \frac{\sqrt{30 \Omega \cdot P_t \cdot G_t}}{r}$$

E_0 = free-space field strength (far field)

P_t = transmitted power

G_t = gain of transmitting antenna including ohmic losses (linear, dimensionless)

r = distance from transmitting antenna

²⁾ Significant for electrical short and simple antennas only (e.g. a rod for low frequencies).

Friis transmission formula³⁾

$$\frac{P_r}{P_t} = \frac{A_{er} \cdot A_{et}}{r^2 \cdot \lambda^2} = \frac{G_t \cdot G_r}{(4\pi r/\lambda)^2}$$

P_r = received power

P_t = transmitted power

A_{er} = effective aperture of receiving antenna

A_{et} = effective aperture of transmitting antenna

G_t = gain of transmitting antenna (linear, dimensionless)

G_r = gain of receiving antenna (linear, dimensionless)

λ = wavelength

r = distance between antennas

Maximum received power³⁾

$$P_r = P_t \cdot G_t \cdot G_r \cdot \left(\frac{\lambda}{4\pi r}\right)^2$$

P_r = received power

P_t = transmitted power

G_t = gain of transmitting antenna (linear, dimensionless)

G_r = gain of receiving antenna (linear, dimensionless)

λ = wavelength

r = distance between antennas

³⁾ Precondition: optimum alignment of both antennas with regard to polarization and boresight direction.

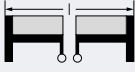
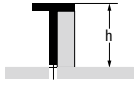
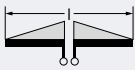
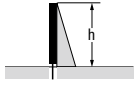
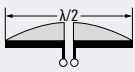
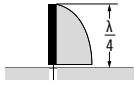
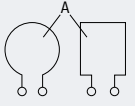
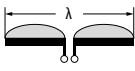
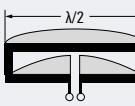
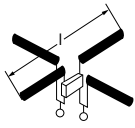
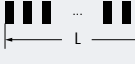
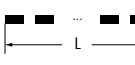
Parameters of selected antenna types						
Type of antenna	Current distribution	Directivity factor D ⁵⁾	Effective antenna length	Radiation resistance R in Ω	Field strength in direction of maximum radiation ⁶⁾ in mV/m	
Isotropic radiator		1 0 dB			$\sqrt{30} \cdot \frac{\sqrt{P/W}}{r/\text{km}}$	$173 \cdot \frac{\sqrt{P/kW}}{r/\text{km}}$
Hertz dipole with end capacitance ⁷⁾		1.5 1.8 dB	l	$80 \pi^2 \left(\frac{l}{\lambda}\right)^2$	$3 \cdot \sqrt{5} \cdot \frac{\sqrt{P/W}}{r/\text{km}}$	$212 \cdot \frac{\sqrt{P/kW}}{r/\text{km}}$
Short antenna on infinitely conducting ground with top capacitance ⁸⁾		3 4.8 dB	h	$160 \pi^2 \left(\frac{h}{\lambda}\right)^2$	$3 \cdot \sqrt{10} \cdot \frac{\sqrt{P/W}}{r/\text{km}}$	$300 \cdot \frac{\sqrt{P/kW}}{r/\text{km}}$
Short dipole without end capacitance ⁷⁾		1.5 1.8 dB	$\frac{l}{2}$	$20 \pi^2 \left(\frac{l}{\lambda}\right)^2$	$3 \cdot \sqrt{5} \cdot \frac{\sqrt{P/W}}{r/\text{km}}$	$212 \cdot \frac{\sqrt{P/kW}}{r/\text{km}}$
Short antenna on infinitely conducting ground without top capacitance ⁸⁾		3 4.8 dB	$\frac{h}{2}$	$40 \pi^2 \left(\frac{h}{\lambda}\right)^2$	$3 \cdot \sqrt{10} \cdot \frac{\sqrt{P/W}}{r/\text{km}}$	$300 \cdot \frac{\sqrt{P/kW}}{r/\text{km}}$
Half-wave dipole		1.64 2.15 dB	$\frac{\lambda}{\pi}$	73.2	$7 \cdot \frac{\sqrt{P/W}}{r/\text{km}}$	$221 \cdot \frac{\sqrt{P/kW}}{r/\text{km}}$
Quarter-wave antenna on infinitely conducting ground		3.28 5.2 dB	$\frac{\lambda}{2\pi}$	36.6	$10 \cdot \frac{\sqrt{P/W}}{r/\text{km}}$	$316 \cdot \frac{\sqrt{P/kW}}{r/\text{km}}$
Small single-turn loop in free space		1.5 1.8 dB	$\frac{2\pi A}{\lambda}$	$80 \pi^2 \frac{4\pi^2 A^2}{\lambda^4}$	$3 \cdot \sqrt{5} \cdot \frac{\sqrt{P/W}}{r/\text{km}}$	$212 \cdot \frac{\sqrt{P/kW}}{r/\text{km}}$
Full-wave dipole		2.4 3.8 dB			$6 \cdot \sqrt{2} \cdot \frac{\sqrt{P/W}}{r/\text{km}}$	$268 \cdot \frac{\sqrt{P/kW}}{r/\text{km}}$
Folded half-wave dipole		1.64 2.15 dB	$\frac{2\lambda}{\pi}$	$4 \cdot 73.2 \cong 280$	$7 \cdot \frac{\sqrt{P/W}}{r/\text{km}}$	$221 \cdot \frac{\sqrt{P/kW}}{r/\text{km}}$
Turnstile antenna (Hertz dipole) radiating in horizontal plane		0.75 1.2 dB	l	$40 \pi^2 \left(\frac{l}{\lambda}\right)^2$	$\frac{3}{2} \cdot \sqrt{10} \cdot \frac{\sqrt{P/W}}{r/\text{km}}$	$150 \cdot \frac{\sqrt{P/kW}}{r/\text{km}}$
Broadside array (Hertz dipoles) (L >> λ)		$4 \cdot \frac{L}{\lambda}$			$2 \cdot \sqrt{30} \cdot \sqrt{\frac{l}{\lambda}} \cdot \frac{\sqrt{P/W}}{r/\text{km}}$	$346 \cdot \sqrt{\frac{l}{\lambda}} \cdot \frac{\sqrt{P/kW}}{r/\text{km}}$
Collinear array (Hertz dipoles) (L >> λ)		$2 \cdot \frac{L}{\lambda}$			$2 \cdot \sqrt{15} \cdot \sqrt{\frac{l}{\lambda}} \cdot \frac{\sqrt{P/W}}{r/\text{km}}$	$245 \cdot \sqrt{\frac{l}{\lambda}} \cdot \frac{\sqrt{P/kW}}{r/\text{km}}$
Antenna with directivity D		D			$\sqrt{30} \cdot \sqrt{D} \cdot \frac{\sqrt{P/W}}{r/\text{km}}$	$173 \cdot \sqrt{D} \cdot \frac{\sqrt{P/kW}}{r/\text{km}}$

⁵⁾ Corresponds to gain for a loss-free antenna.

⁶⁾ Loss-free antenna and surroundings.

⁷⁾ $l < 0.2 \lambda$.

⁸⁾ $h < 0.2 \lambda$.

Antenna Selection Guide

Overview of antennas

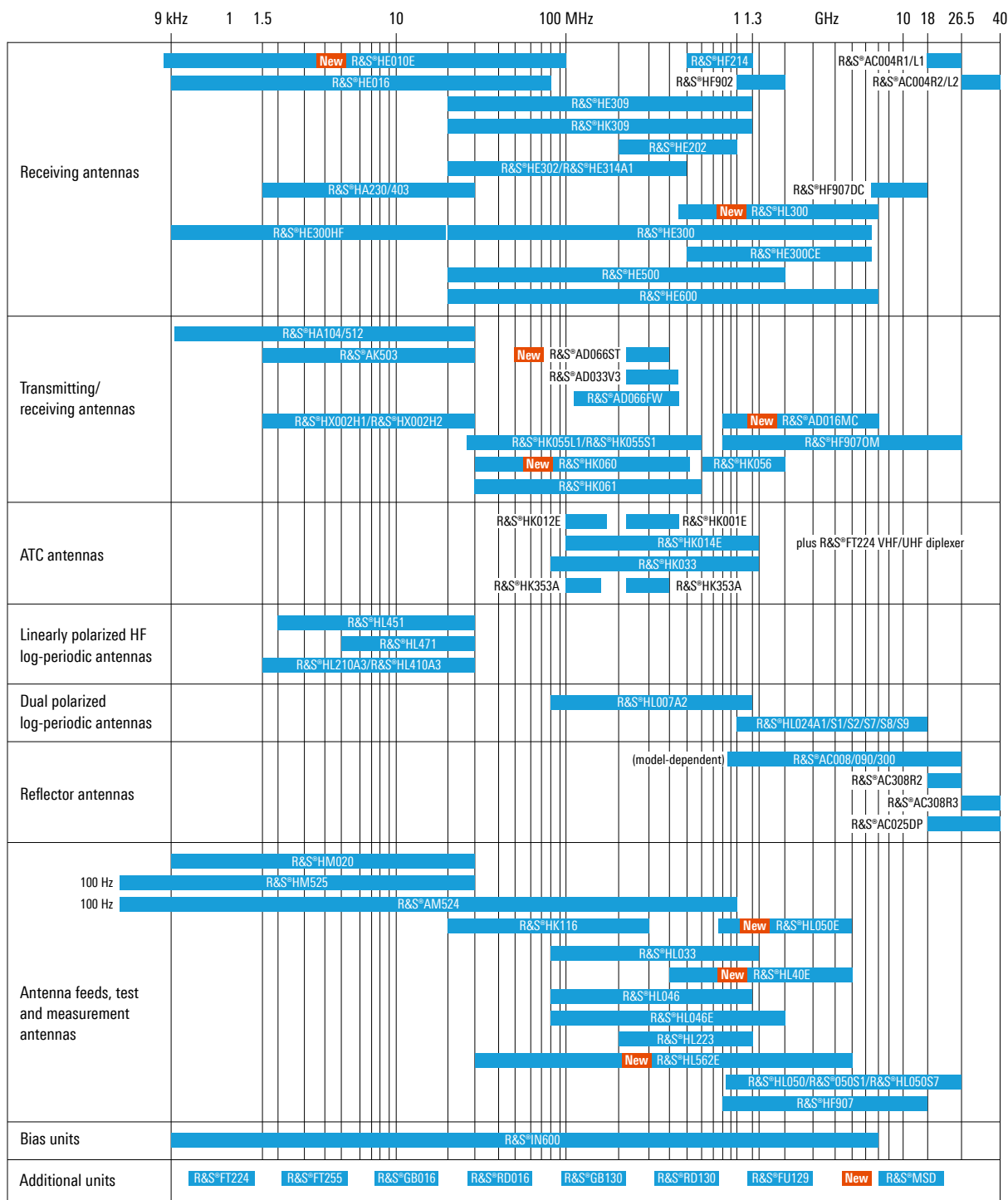



Chapter 2

Receivers

Type	Designation	Page
	Introduction	20
R&S®ESMD	Wideband Monitoring Receiver	32
R&S®EB500	Monitoring Receiver	36
New R&S®EB510	HF Monitoring Receiver	40
New R&S®EM100/R&S®EM100XT	Digital Compact Receiver	44
R&S®PR100	Portable Receiver	48
R&S®HE300	Active Directional Antenna	52
New R&S®HL300	Handheld Log-Periodic Antenna	54
R&S®HF907DC	SHF Directional Antenna with Downconverter	56
R&S®EFW	Flywheel	58

Introduction

Radiomonitoring receivers – design and applications

Basic functionalities of T&M and radiomonitoring equipment are converging to an increasing extent. As a result, cross-sectional applications beyond the equipment's original field of application become possible. Selecting the right equipment for specific monitoring and T&M tasks has thus become more difficult. The basic design features and signal processing methods of the different types of receivers can be used as fundamental decision criteria for choosing the equipment suitable for a specific task.

In the following, the differences between radiomonitoring receivers and other types of receivers are highlighted and their main design features and operating principles are presented.

Types of receivers and typical applications

Test receivers

Test receivers are available for various applications. They are divided into the following groups:

- EMI test receivers:
EMI test receivers measure conducted or radiated interference in accordance with relevant international standards (CISPR, MIL, VG, etc.). These receivers are needed to demonstrate equipment compliance with EMC standard specifications, which is the prerequisite for putting a product on the market
- Test receivers measuring useful signals:
These test receivers measure the level and the modulation of known useful signals and the bandwidth they occupy. For example, they are used to verify whether radio services comply with the limit values specified for these parameters
- Calibration test receivers:
Calibration test receivers measure the level of RF signals at extremely high accuracy and over a wide dynamic range. They are mainly used to calibrate signal sources

Spectrum analyzers

Spectrum analyzers are typically connected to the device under test (DUT) via a cable during the measurement. Featuring a broadband RF frontend, they are usually not suitable for measurements on antennas. They are mainly used in development, production, quality assurance and certification. Typical measurements include the RF level, spectral purity, adjacent channel power and spurious emissions. Today's spectrum analyzers can be used, in particular, to measure the modulation characteristics of RF signals with analog or digital modulation.

Radiomonitoring receivers

Radiomonitoring receivers are optimized specifically for spectrum monitoring tasks and differ fundamentally from test receivers and spectrum analyzers. Radiomonitoring receivers are used for the following tasks:

- Fast detection of unknown signals
- Search for activities over wide frequency ranges
- Monitoring of individual frequencies, lists of frequencies or frequency ranges
- Measurement of spectral characteristics of very short or rarely occurring signals
- Storage of activities
- Triggering of further activities after a signal is detected
- Demodulation of communications and/or transfer of demodulated signals for processing
- Integration into civil and military dedicated systems
- Homing, i.e. localization of signal sources
- Simple coverage measurements
- Measurements in line with ITU recommendations

The above tasks place special requirements on the receivers' hardware and software, the type of control via front panel or remote control interface, the provision and processing of captured data, and the receivers' integration into complex systems. Radiomonitoring receivers must be able to process antenna signals with high cumulative loads and wide dynamic range. In particular, seamless (gapless) realtime processing is a requirement that other receiver types usually cannot meet.

To meet the above requirements, radiomonitoring receivers rely on special design principles and operating methods, which are discussed in the following.

Design principles and operating methods of radiomonitoring receivers

Frontend – handling real antenna signals

Radiomonitoring receivers are operated almost exclusively on antennas in real signal scenarios. Especially when connected to omnidirectional antennas, receivers may have to cope with very high cumulative signal loads and also with a wide dynamic range between strong and weak signals in specific frequency ranges. This difficulty can be overcome by tailoring receivers to specific frequency ranges, usually to the HF, VHF/UHF and SHF bands. This makes it possible to meet the frequency-range-specific design requirements placed on the frontend.

To enable applications as universal as possible, tuners for the individual frequency ranges can be used in a single device. In this way, it is possible to cover a frequency range from 9 kHz to 26.5 GHz, for example, using a dedicated HF, VHF/UHF and SHF module each, as in the case of the R&S®ESMD. Wide-range tuners, which in the case of the R&S®PR100 cover a frequency range from 9 kHz to 7.5 GHz in a single module, do not allow the same excellent reception characteristics to be achieved across the entire frequency range, but they permit extremely compact designs. For portable receivers and their applications, the performance achievable with a single tuner module is sufficient because, among other reasons, these receivers are not operated on highly sensitive, stationary antenna systems.

How the frontend works

The receiver frontend receives the RF signal and processes it for the subsequent A/D converter.

A distinction is made between two basic concepts:

A direct-conversion receiver routes the received signal with the original frequency through preparatory stages (preselection filter, amplifier, gain control) directly to the A/D converter. With a satisfactory resolution of the A/D converter (e.g. 16 bit), this works up to input frequencies of approx. 32 MHz.

Direct-conversion receivers offer the advantages of very low phase noise and complete elimination of image frequencies, IF feedthrough, etc.

For higher frequencies (starting from approx. 20 MHz up into the SHF range), three-stage intermediate frequency (IF) conversion is used. The RF receive signal is converted in stages to the third IF of, for example, 21.4 MHz while it undergoes processing (preselection filter, amplifier, gain control) at the same time. Next, the signal is taken to the A/D converter. The use of three-stage IF conversion makes it possible to receive even very high frequency signals at 16 bit resolution of the A/D converter while offering good image frequency rejection at the same time.

Simplified block diagram of the R&S®PR100 frontend

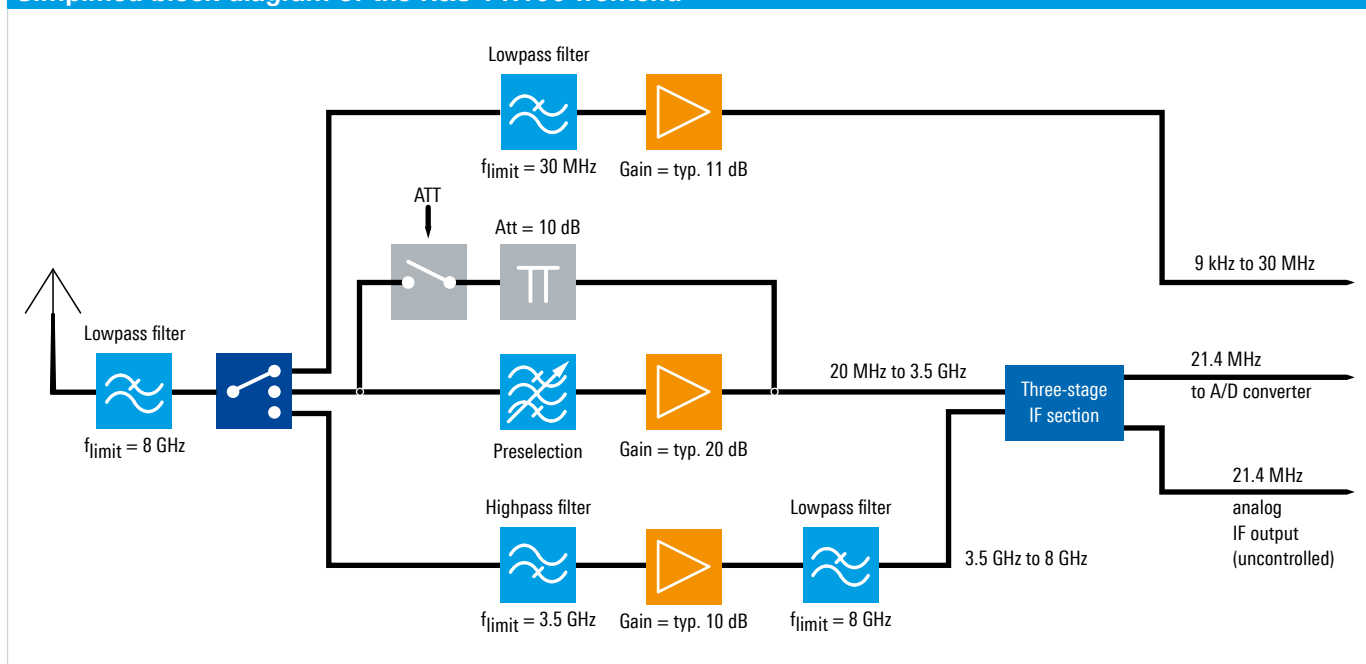

If the first IF of such a superhet receiver is above the highest receive frequency, it can be kept constant. If the IF is in the lower region of the reception range, conversion concepts that are complex but not perceivable by the user are implemented to prevent inherent spurious responses.

Another special feature found in the frontends of radiomonitoring receivers is the built-in preselection. This stage comprises multiple switchable and tunable band-pass filters that protect the first mixer stage of multiple-conversion receivers, or the A/D converter of direct-conversion receivers, against high cumulative signal loads. The preselection stage is indispensable especially when the receiver is operated on a broadband omnidirectional antenna where the cumulative signal load from numerous radio services operating over very wide frequency ranges is present at the receiver input. Without preselection, this operating mode would lead to strong intermodulation products or even drive the receiver into saturation. In contrast to fixed, switch-selected preselection filters, the use of tracking preselection ensures optimal filtering for the selected realtime bandwidth for any input frequency.

Digital signal processing

Unknown signals are normally detected by performing high-speed scans over wide frequency ranges, and then analyzed in detail in fixed-frequency mode. A radiomonitoring receiver's scan speed and probability of intercept (POI) are determined by its realtime bandwidth, sensitivity, and the type and speed of signal processing employed.

To provide high realtime bandwidth without compromising sensitivity and dynamic range, some radiomonitoring receivers from Rohde&Schwarz feature multiple different and switchable broadband receive paths. Multifunctional IF panorama displays with a wide range of setting functions are available in addition to allow powerful, in-depth analysis of detected signals.

Separate spectrum and measurement paths

Another special feature of radiomonitoring receivers is their ability to provide an overview of all signal activities in a wide frequency range while at the same time allowing detailed analysis and demodulation of individual signals.

To achieve this, the signal path is split up after A/D conversion: In the first path, the IF spectrum is calculated by means of a digital downconverter (DDC), a digital bandpass filter and an FFT stage. The user can select the bandwidth of the bandpass filter from typically 1 kHz to 10 MHz, or 20 MHz, or even 80 MHz. Results are postprocessed by means of the average, min. hold or max. hold function, as selected by the user, before the IF spectrum is output on the display or via the LAN interface. In the second path, the signal is processed for level measurement and demodulation. Here, too, the signal passes through a DDC and a bandpass filter. High-end receivers include multiple DDCs for the parallel demodulation of multiple signals.



IF spectrum, with selected demodulation bandwidth highlighted in blue. Lower part: panorama scan.

To process the different signals with optimum signal-to-noise ratio, receivers from Rohde&Schwarz contain digital IF filters with demodulation bandwidths from 150 Hz to 20 MHz in the measurement path. The filters can be selected independently of the IF bandwidth. Prior to the level measurement, the absolute value of the level is determined and weighted by means of a user-selected detector (average, max. peak, RMS or sample). The measured level is output on the display or via the LAN interface.

To demodulate analog signals, the complex baseband data passes through a bandpass filter, then undergoes automatic gain control (AGC) or manual gain control (MGC), and is finally demodulated in the AM, FM, USB, LSB, ISB, pulse or CW demodulation stage. The complex baseband data (I/Q data) of digital signals is directly output for processing after the AGC/MGC stage. Here, it is possible to output the I/Q data stream via a Gigabit LAN connection in order to buffer the stream on an external medium. Online analysis of the I/Q data stream is also possible by using appropriate software (see block diagram).

High receiver sensitivity, high signal resolution

In the following, the special aspects regarding sensitivity and signal resolution in radiomonitoring receivers are explained, assuming an IF bandwidth of 10 kHz as an example.

The IF spectrum is digitally calculated by means of a fast Fourier transform (FFT). The use of FFT computation at the IF offers a major advantage: The receiver sensitivity and signal resolution are clearly superior to those of conventional analog receivers at the same spectral display width.

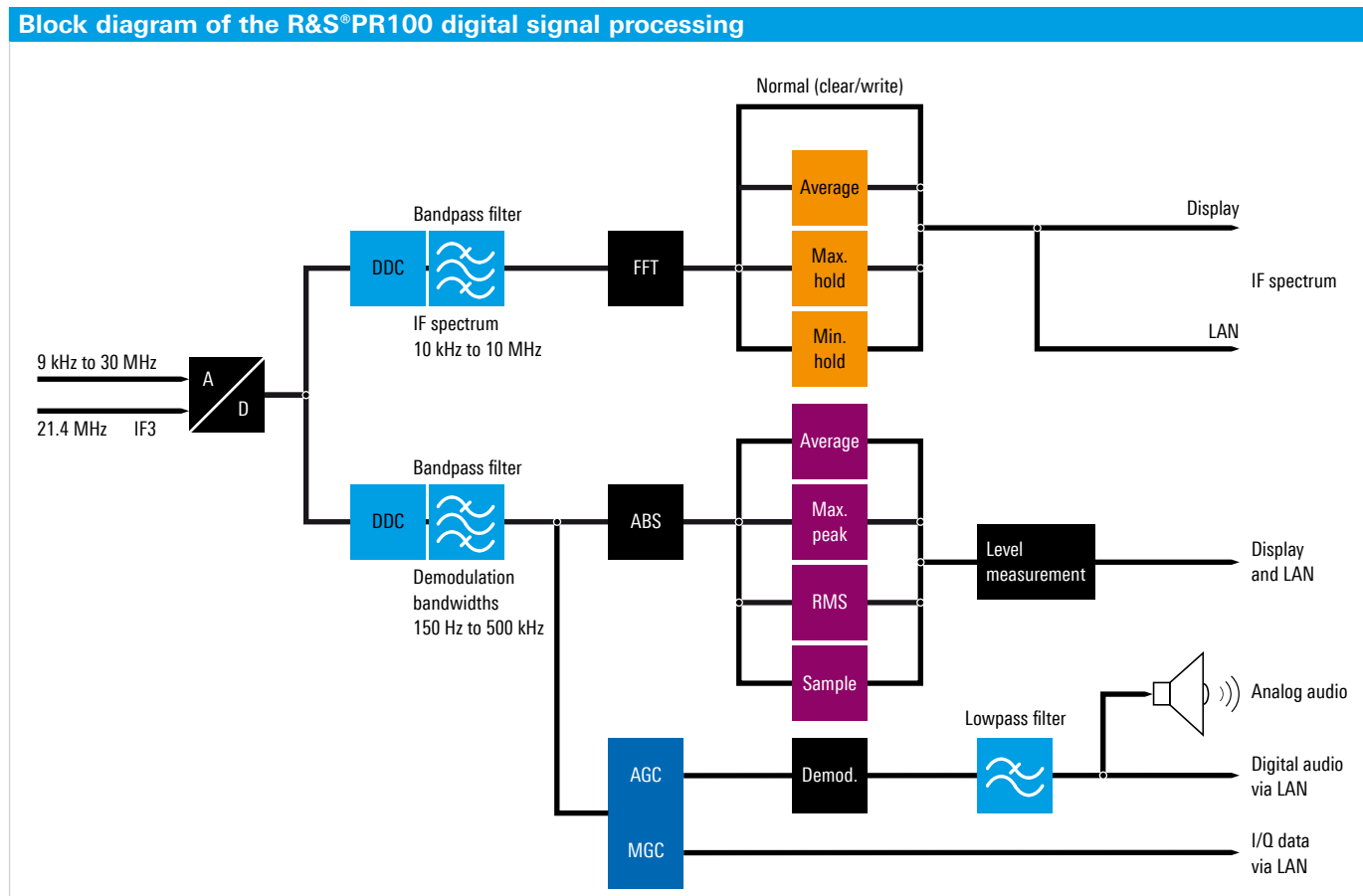

IF spectrum

FFT calculation of the IF spectrum is performed in a number of steps. These steps are described below in simplified form for an IF bandwidth of 10 kHz ($BW_{IF\ spectrum} = 10\text{ kHz}$), which yields maximum sensitivity.

Due to the finite edge steepness of the IF filter, the sampling rate f_s must be larger than the selected IF bandwidth $BW_{IF\ spectrum}$. The quotient of the sampling rate and the IF bandwidth is > 1 and is a measure of the edge steepness of the IF filter. This relationship is expressed by the following two formulas:

$$\frac{f_s}{BW_{IF\ spectrum}} = \text{const}$$

or

$$f_s = BW_{IF\ spectrum} \times \text{const}$$

The value of the constant is dependent on the selected IF bandwidth, i.e. it may vary as a function of the IF bandwidth.

For an IF bandwidth of $BW_{IF\ spectrum} = 10\text{ kHz}$, the constant is 1.28. To display a 10 kHz IF spectrum, therefore, a sampling rate of $f_s = 12.8\text{ kHz}$ is required (see upper figure).

The automatically selected FFT is assumed to have a standard length N of 2048 points in this example. To calculate these points, the 12.8 kHz sampling band is divided into 2048 equidistant frequency slices, which are also referred to as bins.

The bandwidth BW_{bin} of the frequency slices is as follows:

$$BW_{bin} = \frac{f_s}{2048} = \frac{12.8\text{ kHz}}{2048} = 6.25\text{ Hz}$$

This means that in this example only the calculated bandwidth of 6.25 Hz for each bin has to be taken into account as the noise bandwidth in the calculation of the displayed noise level (DNL) in accordance with the formula below (the effect of the window function (Blackman window) of the FFT is not considered here for simplicity's sake):

$$DNL = -174\text{ dBm} + NF + 10 \times \log(BW_{bin}/\text{Hz})$$

The quantity NF represents the overall noise figure of the receiver.

The above example shows that, due to the use of the FFT, the actual resolution bandwidth (RBW) to be taken into account in the DNL calculation is clearly smaller (i.e. BW_{bin}) than would be expected for the wide display range of 10 kHz.

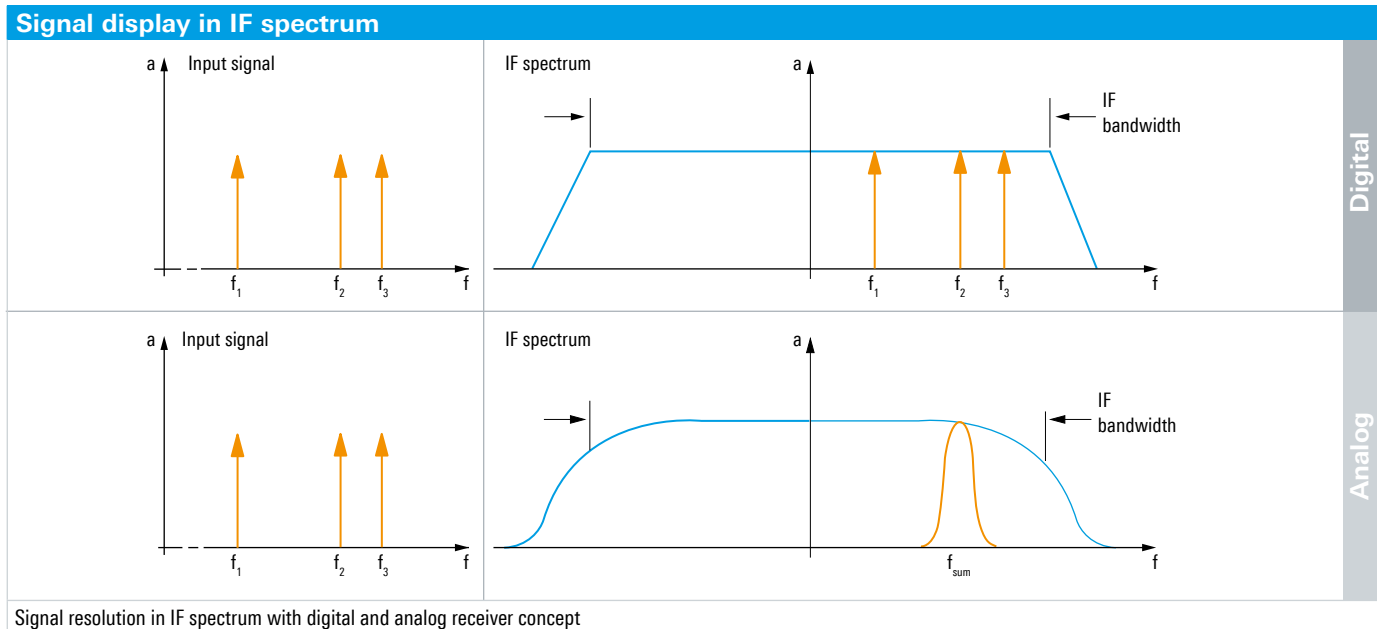
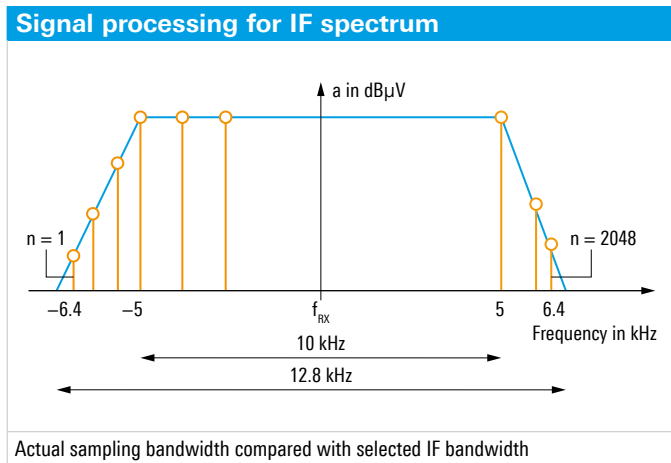

Another advantage of the high spectral resolution used in the FFT calculation is that signals located close together (e.g. f_1 , f_2 , f_3) can be captured and represented in the IF spectrum as discrete signals.

If, on an analog receiver, a resolution bandwidth equal to the set IF bandwidth was selected ($RBW = BW_{IF\text{ spectrum}}$), a sum signal f_{sum} would be displayed instead of the three discrete signals f_1 , f_2 and f_3 .

The FFT resolution can also be selected manually. This offers the advantage that the FFT resolution can be chosen to precisely match the channel spacing of the radio service to be analyzed. This ensures that the receiver will always be tuned to the center frequency of the channel in question. The channel spacings of all known radio services can be installed as FFT resolutions, with the FFT length varying between 16 and 4096 points.

High-end radiomonitoring receivers feature DSP computing power so high that up to four times the number of FFT points actually needed is available, depending on the selected realtime bandwidth. By selecting an appropriate FFT length, even closely spaced channels can be reliably detected as discrete channels. By utilizing the higher number of FFT points available, the FFT can be expanded by up to four times. The high computing power can also be used to perform FFT calculation using overlapping windows. This makes even short pulses clearly discernible in the spectrum's waterfall display.

Polychrome IF spectrum display

In the histogram mode, a multicolor (polychrome) waterfall of the IF spectrum is displayed. The polychrome spectrum display is an excellent means of visualizing short pulses or short-duration signals. It shows, in different colors, signals of different duration and frequency of occurrence. Signals with a very short duration are shown in blue in the screenshot below, whereas continuous signals appear in red. An adjustable switch-off delay ensures that even sporadic short-duration emissions are clearly distinguishable. The user can adapt the color assignment by means of diverse configuration options. If the histogram is displayed in the pulse mode, the signal duration (pulse duration) can be measured in addition. By adapting the IF bin width to the channel spacing of a specific radio service, as described under "IF spectrum", a quick assessment of TDMA channel occupancy is possible.



Various short-duration signals in the ISM band.



GSM downlink: The histogram mode reveals co-channel occupancy and the different number of occupied timeslots per channel.

Video spectrum

A video panorama is available to display the spectrum of a demodulated signal. It can be used, for example, to visualize subcarriers (pilot tone, RDS carriers) in FM signals. The AM², FM² or I/Q² modes enable the user to measure signal parameters such as the baud rate or chip rate (for DSSS signals) that are used in digital transmission methods.

Realtime capability

To provide a measure of the realtime capability of radio-monitoring receivers, a virtual scan speed is often specified. This figure designates the scan speed in scan ranges that are smaller than the receiver's maximum realtime bandwidth. Scans across this range can also be designated as realtime scans since the tuning time of the synthesizer can be ignored within the realtime bandwidth of the receiver. At a fixed frequency resolution and a sufficiently large realtime bandwidth, the speed of the realtime scan is determined solely by the receiver's computing power (see table).

When it comes to assessing a receiver's realtime capability with respect to signal processing, seamless data acquisition is the key criterion. While some "realtime receivers" are able to capture a spectrum in realtime for a specific

period of time, they do not offer sufficient processing resources to continue data acquisition without interruptions, i.e. seamlessly. Instead, data has to be buffered, and signal acquisition is interrupted in order to process and display the buffered data.

By contrast, Rohde&Schwarz radiomonitoring receivers offer two parallel signal processing paths that permit the seamless capturing and processing of signals in realtime.

For the following description, an IF bandwidth of 10 MHz is assumed. At this bandwidth, 12.8 Msample are collected per second.

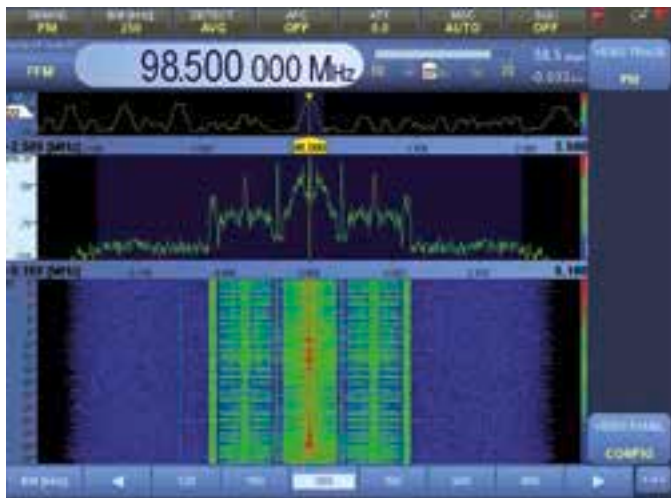

Spectrum of a demodulated FM signal.

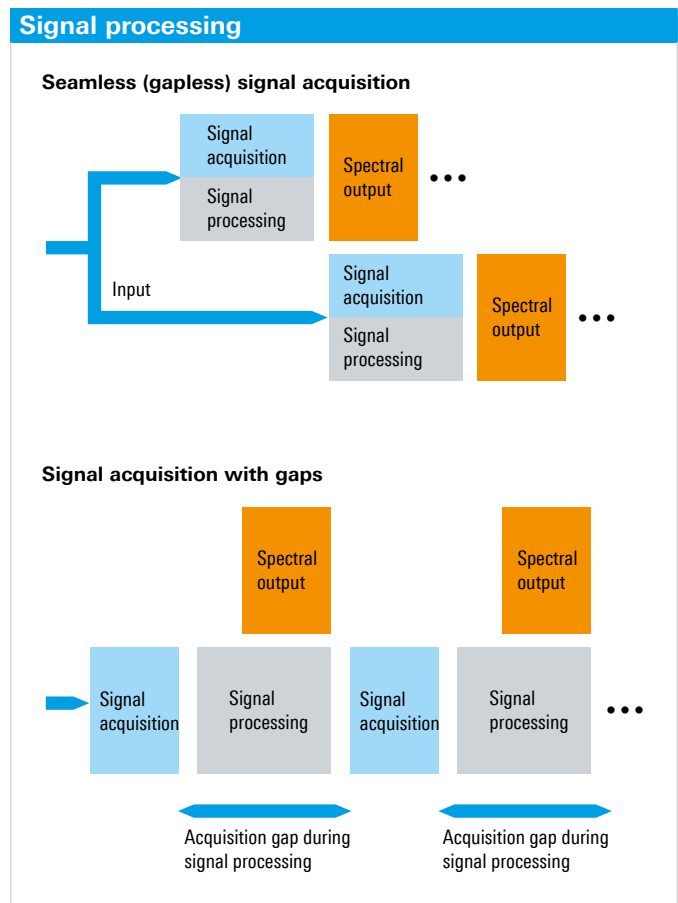

Internal computing power of the R&S®ESMD				
Frequency resolution in kHz	Number of spectra per second		Time resolution in µs	
	20 MHz realtime bandwidth	80 MHz realtime bandwidth	20 MHz realtime bandwidth	80 MHz realtime bandwidth
12.5	12500	-	80	-
25	25000		40	
50	50000		20	
100	100000		10	

An FFT with 2048 points processes 2048 samples per frame. Consequently, 6250 FFTs are required in order to process one second of the incoming data stream. Each individual FFT therefore includes samples received during a period of $1\text{ s}/6250$, which is $160\text{ }\mu\text{s}$.

The Blackman filter indicated in the bottom right figure allows the samples within each FFT frame to be described as a function without any infinite spectral components in the time domain. The spectrum can therefore be calculated very quickly. However, a sometimes substantial attenuation has to be accepted for signals that are shorter than the duration of an FFT frame and located at the boundary between two frames.

To capture a signal with 100% reliability and correctly measure its level, a minimum signal duration corresponding to two FFT frames, i.e. $320\text{ }\mu\text{s}$ in this example, would be required. If the focus is on detecting a signal rather than measuring its level correctly, considerably shorter pulses down to several hundred nanoseconds can be captured and processed. This type of processing is generally referred to as seamless (gapless), although pulses may go undetected if they are very short and located at an unfavorable position with respect to the FFT frame (see upper processing step in the figure "Overlapping FFT"). Therefore, some Rohde & Schwarz receivers offer overlap-

ping FFT. Two FFTs whose frames are shifted with respect to one another are calculated in parallel from the data stream. A sample located in the minimum of the Blackman filter curve of one FFT will then be found in the maximum of the other.

For a realtime bandwidth of 10 MHz as used in this example, a minimum signal duration of $240\text{ }\mu\text{s}$ is required to ensure 100% reliable signal acquisition and correct level measurement. For shorter pulses, the level may not be displayed correctly, and only very weak signals may go undetected.

It is evident that the use of digital signal processing in a radiomonitoring receiver offers great advantages. Extremely high sensitivity (due to very fine resolution) combines with a broad spectral overview and high scan speed to significantly increase the probability of intercept over analog receivers or spectrum analyzers.

Panorama scan

In the panorama scan mode, the spectrum is displayed across a frequency range far wider than the radiomonitoring receiver's realtime bandwidth. This mode provides users with a quick overview of the spectrum occupancy.

The principle of the panorama scan is described in detail in the following using a receiver with 10 MHz realtime bandwidth (= FFT bandwidth) as an example.

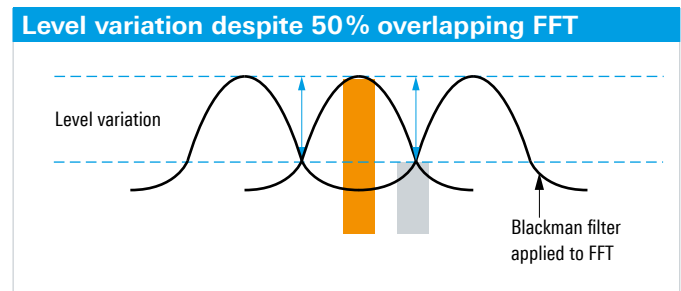
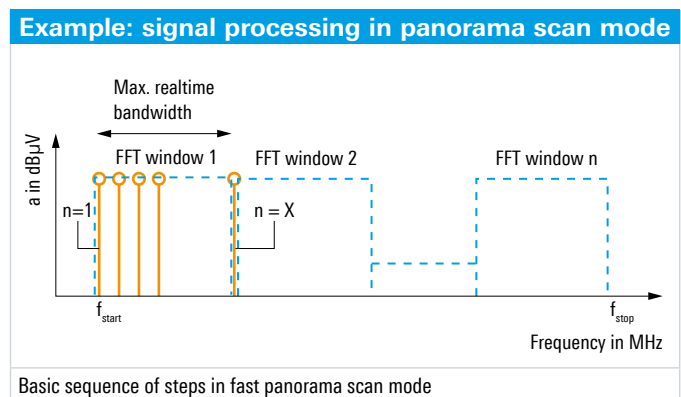
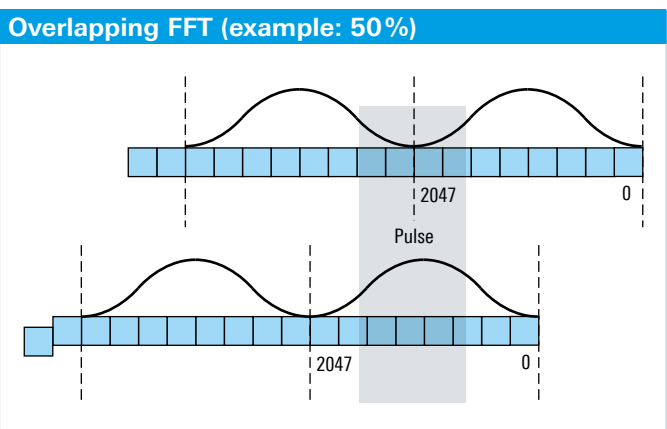
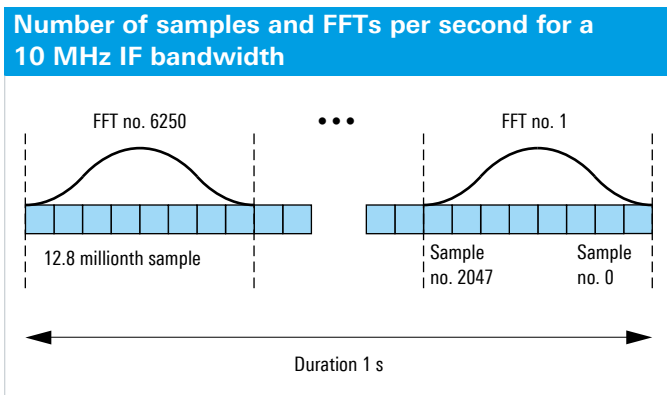

To calculate the spectrum in a panorama scan, frequency windows of a width up to the receiver's maximum possible realtime bandwidth are linked in succession. The complete, predefined scan range is traversed.

As with the IF spectrum, an FFT is used to process the broad window with finer resolution. The width of the frequency window and the FFT length (number of FFT points) are variable and are selected by the receiver.

In the panorama scan mode, the user can select among different step widths. The step width corresponds to the width of a frequency slice (bin width) as described under "IF spectrum" above. Based on the selected step width and start and stop frequency, the receiver automatically determines the required FFT length and the width of the frequency window for each scan step. The receiver selects these internal parameters so that the optimum scan speed is achieved for each step width.

In the panorama scan mode, maximum scan speed is achieved when using the maximum step width (which means maximum window width and minimum number of FFT points). In contrast, maximum sensitivity is achieved when using the minimum step width (which means minimum window width and maximum number of FFT points, resulting in minimum scan speed). The step width (bin width) for the panorama scan therefore corresponds to the resolution bandwidth (BW_{bin}) used in the DNL calculation for the IF spectrum (see DNL formula under "IF spectrum" above) and can be used to calculate the DNL for the panorama scan. Apart from this, the user selects the step width to obtain the desired frequency resolution.

A receiver's available IF bandwidth has a direct influence on the achievable panorama scan speed. Doubling the IF bandwidth (i.e. using 20 MHz instead of 10 MHz in this example) will also double the achievable scan speed. If the IF bandwidth is increased from 20 MHz to 80 MHz, the scan speed will be boosted by a factor of four.



In addition to the main demodulation path (blue), another four signals (red) can be demodulated independently of each other.

Resolution in panorama scan mode

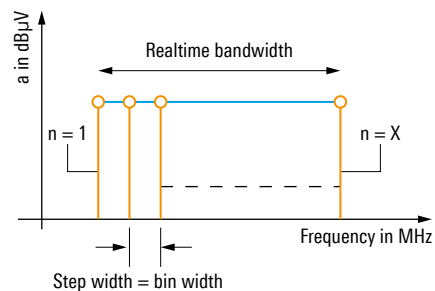

Selection of resolution for panorama scan by varying the bin width

Operating and display modes

Fixed-frequency mode

The fixed-frequency mode, in which the center frequency of the set realtime bandwidth remains unchanged, is the normal reception mode of a receiver. It is used to continuously and simultaneously process one or more signals within the realtime bandwidth. Signals are measured and demodulated in the receiver, and the resulting analog or digital IF data is output for postprocessing. Signal measurement can be carried out automatically for specific ITU standards or manually using markers on the display.

Frequency scan

In the frequency scan mode, a user-defined frequency range is scanned using fixed channel spacing. The radiomonitoring receiver steps through the frequency range and checks each channel for occupancy. The frequency scan mode is intended especially for monitoring radio services that use fixed frequency (channel) spacing. The channel spacing, the dwell time per channel, the demodulation mode and bandwidth, and the squelch setting are therefore selected globally for the entire scan range.

If a level above threshold is detected, the receiver dwells at the corresponding frequency for a preselected period of time. Occupied channels of a radio service are quickly found, demodulated and output on the loudspeaker. The frequency and relevant settings of a detected channel can be stored to memory at the press of a button during the dwell time. The memory is then available in order to call up channels quickly or to search channels in a memory scan. Conversely, occupied channels that are of no interest for further monitoring can be suppressed during the dwell time, likewise at the press of a button. These channels will no longer be displayed as the frequency scan continues. This enhances scan speed and increases the probability of intercept for signals on other channels.

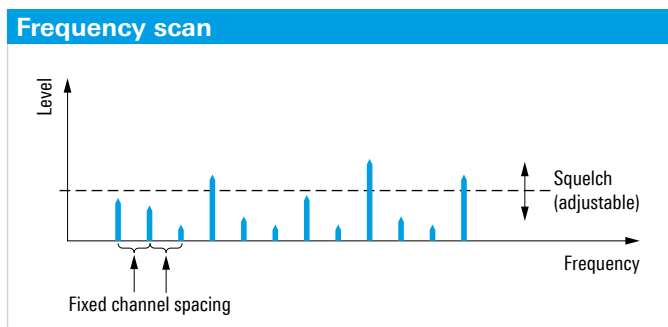

Example: resolution in panorama scan mode

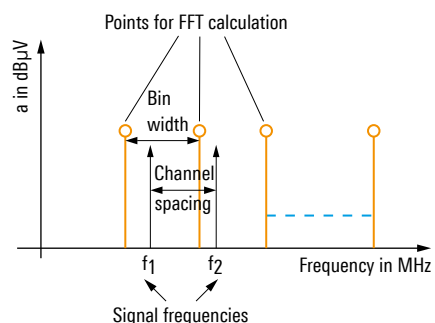

Selection of 12.5 kHz bin width to capture a radio service using 12.5 kHz channel spacing

Memory scan

Most radiomonitoring receivers have internal memory locations (channels) to which frequencies are stored; high-end instruments, for example, offer more than 10 000. A complete, individual data record can be assigned to each memory location. In addition to the frequency, a data record may include bandwidth, detector type, demodulation mode and other settings. During a scan, the selected channels are checked for occupancy in the sequence of the memory locations. The memory scan is of interest in particular if individual frequencies are to be scanned that have no fixed channel spacing or if frequency blocks are to be scanned periodically. Particularly important channels, for example a distress frequency, can be stored in multiple memory locations. It will then be checked multiple times during a scan. This will increase the probability of detecting activities on that channel over less important channels.

Waterfall

If frequencies are occupied at varying times, a waterfall diagram of the spectrum is ideal for displaying the history of frequency occupancy. The levels of the signals in the spectrum are color-coded. The waterfall display allows fast and reliable detection in particular of short-duration signals that are visible only briefly in the spectrum, and of frequency-agile signals such as chirps and hoppers. Markers in the waterfall display can be used to measure signal bandwidths and, depending on the time resolution of the waterfall, to determine signal durations.



Waterfall display with history and marker functions.

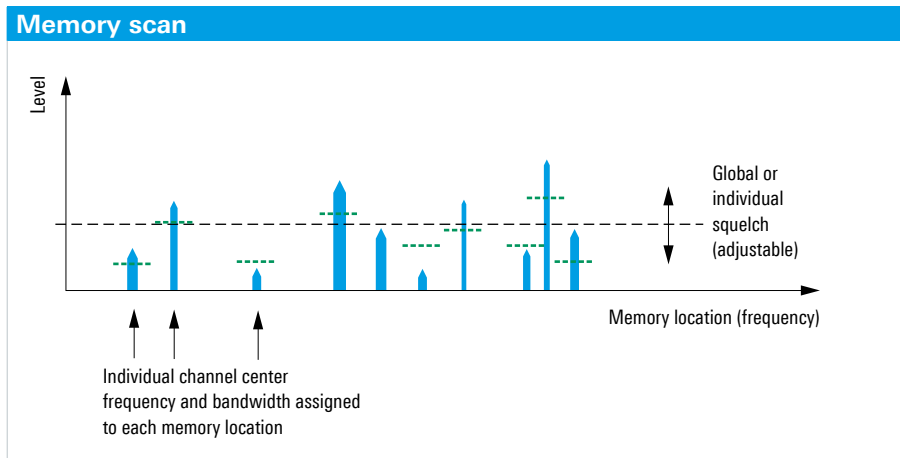

Additional functions

In addition to the excellent characteristics provided by the analog RF stages and digital signal processing, more and more functions are made available, partly in the instrument itself and partly on external computing platforms. A feature of particular importance in radiomonitoring receivers is an easy-to-integrate remote control and data interface. State-of-the-art receivers from Rohde&Schwarz include LAN interfaces and can be remote controlled by means of SCPI commands. For more information on remote control software and system integration, see "Off-the-Shelf Software and Systems" on page 151.

Direction finding (DF) is another function that can be installed directly on the instrument. Adding DF capability will expand a radiomonitoring receiver to a full-featured single-channel direction finder. For details, see "Direction Finders" on page 61.

Additional signal analysis functionality on an external computer enables the user to perform automatic scans and classifications or special analyses of signals in line with ITU-R SM, 1600 recommendations. For details, see "Analyzers" on page 113.

Overview of Rohde & Schwarz radiomonitoring receivers

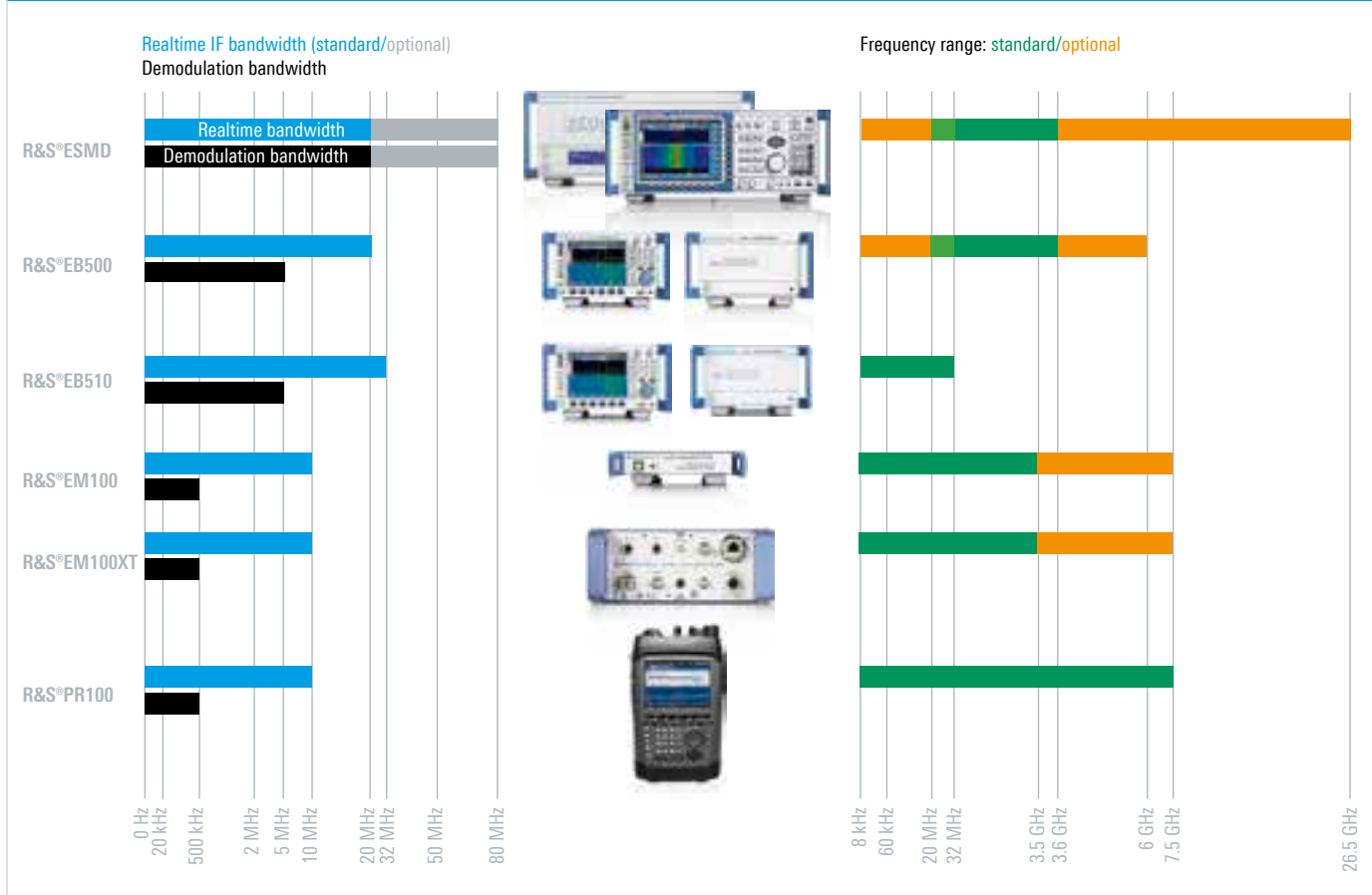

R&S®ESMD Wideband Monitoring Receiver

Premium-class signal reception

The R&S®ESMD wideband monitoring receiver was specially developed for signal search, radiomonitoring, radio detection and spectrum monitoring tasks. It performs ITU-compliant measurements and meets the requirements of security authorities and organizations. The receiver is ideal for both stationary and mobile/vehicular applications because it can be operated via the front panel or remotely controlled via LAN.

The R&S®ESMD features a wide frequency range (8 kHz to 26.5 GHz), outstanding receive characteristics, 80 MHz realtime bandwidth (base unit: 20 MHz) and a wealth of functions. Thanks to its sophisticated preselection stages, the receiver can be directly connected to a wideband monitoring antenna. This is an operating scenario that requires high large-signal immunity and high sensitivity, particularly in the presence of many strong signals.

An upgrade kit is available to turn the monitoring receiver into a high-performance, single-channel direction finder.

Hardware-accelerated multichannel processing ensures data rate efficient transmission of up to 128 parallel channels via the 1 Gbit LAN interface (for example to a multichannel analysis system solution such as R&S®CA120).

All results are output via the receiver's LAN interface, including spectra (realtime operation and scan mode), waterfall (spectrogram), demodulated audio information, level measurement data and I/Q baseband data.

Key facts

- ITU-compliant measurements and applications for security authorities and organizations
- Wide frequency range: 8 kHz to 26.5 GHz (base unit: 20 MHz to 3.6 GHz)
- Up to 80 MHz realtime bandwidth (base unit: 20 MHz)
- Time-domain analysis up to 20 MHz bandwidth
- Realtime event capture (REC) for I/Q recordings and realtime replay
- Various result displays
- Integration into customer-specific software packages from third-party suppliers thanks to open, documented remote control interface and data formats
- Internal recording and replay of spectra and waterfall data (for receivers with front panel operation or for external R&S®ESMD GUI software)
- Map display with GPS position (for receivers with front panel operation or for external R&S®ESMD GUI software)

Benefits and key features

- Frequency range from 8 kHz to 26.5 GHz
 - One radiomonitoring receiver for "all" frequencies
 - Base unit: 20 MHz to 3.6 GHz;
R&S®ESMD-HF: option for HF signal reception from 8 kHz; R&S®ESMD-SHF: option for SHF signal reception up to 26.5 GHz
 - Same size, even with all frequency options installed (19" width, 4 HU)
- Integrated antenna switch
 - Two separate inputs for HF (2) and VHF/UHF (3)
 - One SHF input
 - Automatic switching between antennas as a function of selected frequency, even during scanning
- Powerful preselection: large-signal immunity and high sensitivity
 - Reliable protection against overloading due to strong signals
 - Outstanding sensitivity due to high-gain preamplifier stage
 - Ideal monitoring receiver with wide dynamic range for all signal scenarios
 - Smooth operation, e.g. with a wideband receiving antenna (responsible for high total signal load at receiver input)



- FFT signal processing with 80 MHz realtime bandwidth (base unit: 20 MHz)
 - Realtime spectrum for detecting pulsed or frequency agile signals
 - FFT signal processing for fine frequency resolution and high sensitivity
 - FPGA implementation for top processing speed with fine resolution and sensitivity
- Extremely fast spectral scan (panorama scan) across entire frequency range
 - Extremely fast FFT scan
 - Fast spectrum overview with extremely fine resolution bandwidth
 - Combination of spectral results and waterfall display
 - Optimal determination of frequency range of interest from an unknown starting position
- Waterfall diagram for examination of signal history
 - Three-dimensional display of spectrum over frequency, time and color-coded signal level
 - History mode function to stop the waterfall and display a previous spectrum
 - Outstanding visual presentation of pulsed or frequency agile signals
 - Settable time resolution of waterfall (speed)
- Recording of spectra and waterfall data and replay of results
 - Recording of spectra and waterfall data, e.g. on a USB flash drive
 - Replay of recorded content for detailed evaluation of signals contained in spectrum
 - Identical receiver and parameter settings in recording and replay modes
 - For receivers with front panel operation or for external R&S®ESMD GUI software
- Map display with GPS position
 - Map display of current receiver location
 - Selectable display of recorded results (e.g. spectra) relative to a position
 - Map material based on OpenStreetMap (OSM)
 - For receivers with front panel operation or for external R&S®ESMD GUI software
- Polychrome spectrum to distinguish superimposed, pulsed signals
 - Display of time behavior (frequency of occurrence) of pulsed signals using color coding (for all realtime bandwidths)
 - Settable occurrence frequency threshold
 - Separate display of pulsed signals (superimposed in frequency, time and level)
- Video spectrum for display of subcarriers and transmission rates
 - Spectrum display of demodulated signal
 - Clear display of subcarriers, e.g. 19 kHz pilot tone
 - Squared video spectrum to estimate the transmission rate (baud rate) of a digitally modulated signal
- Combination of spectral results and waterfall display
- Parallel signal processing of spectral path and demodulation path
 - Two parallel signal processing paths for spectrum and demodulation
 - Interference-free demodulation with parallel display of realtime spectrum and waterfall display
 - Seamless I/Q baseband data stream for signal analysis
 - Independent setting of bandwidth and center frequency
- Level measurements with “real” wideband detector
 - Wideband level measurements up to 20 MHz bandwidth for sophisticated, digitally modulated signals
- Frequency scan and memory scan for audio demodulation on changing channels
 - Frequency scan: continuous scanning of adjacent channels, automatic demodulation of channels where level exceeds squelch, e.g. in ATC band
 - Memory scan: scanning of different radio services with variable step size and demodulation mode
 - Convenient scanning for active signals and quick availability of audio content
- 4+1 receivers in one instrument
 - R&S®ESMD-DDC option: four additional demodulation channels
 - Five software receivers in one instrument thanks to five demodulation channels (anywhere within realtime bandwidth)
 - Output of demodulated data as separate data streams via LAN interface
- Time domain analysis up to 20 MHz bandwidth
 - R&S®ESMD-ZS option: time domain analysis (zero span)
 - Amplitude and instantaneous frequency display for detailed signal analysis
 - Selection of an up to 20 MHz wide signal within the 80 MHz realtime bandwidth
- Open interfaces for remote control and data transmission
 - Two 1 Gbit Ethernet LAN interfaces for receiver remote control and result processing using Rohde & Schwarz system software (e.g. R&S®ARGUS, R&S®RAMON, R&S®CA100)
 - R&S®RX-10G option: retrofittable 10 Gbit Ethernet LAN interface
 - Documented interface description for flexible programming and data processing, even with customer-specific software package
- Interfaces for up to 80 MHz wide I/Q data streaming
 - R&S®ESMD-Control software package for receiver remote control via 1 Gbit LAN interface
 - Documentation of results on a PC (e.g. spectra and audio content), also for replaying recorded data for offline analysis
- Receiver remote control and data recording
 - R&S®ESMD-Control software package for receiver remote control via 1 Gbit LAN interface

- Documentation of results on a PC (e.g. spectra or audio content), also for replaying recorded data for offline analysis
- Multichannel signal detection and analysis in a networked system
 - R&S®ESMD-SP option: hardware-accelerated multichannel processing of I/Q data streams via 1 Gbit LAN interface, e.g. for multichannel content recovery and detection of fixed frequency and frequency agile signals
 - Further processing in a networked system, e.g. in combination with R&S®CA120 and suitable options
 - Documented interface description for flexible programming and data processing, even with customer-specific software package
- ITU-compliant measurements in the receiver
 - R&S®ESMD-IM option: ITU-compliant measurement of signal parameters for AM, FM and PM-modulated signals (e.g. modulation index, occupied bandwidth and phase deviation)
 - Offline measurement of digitally modulated signals using the R&S®CA100IS software and suitable options (in line with ITU recommendation SM.1600)
- Detection of selective call services
 - R&S®ESMD-SL option: detection of audio-based selective calls and listing of received selective call standards
 - Result filtering in line with relevant standards
- DC operation (e.g. from vehicle battery)
 - R&S®ESMD-DC option: DC power supply (12 V to 32 V DC)
 - Space-saving vehicle installation
- System time synchronization using NTP server
 - Time and date synchronization using an NTP server for simultaneous control of multiple receivers in a networked system
 - Easy comparison of measurement results received by different stations
- TDOA ready with high-accuracy timestamps and GPS synchronization of frequency and time
 - R&S®ESMD-IGT option: synchronization of receiver frequency and time using internal GPS module
 - High-accuracy timestamps in I/Q baseband data stream, ideal for use in TDOA systems
- Recording and replaying of up to 80 MHz wide I/Q data
 - Never miss an event: activation of recordings with flexible realtime event capture (REC)
 - Signals as received from an antenna: all receiver functions available when replaying I/Q data
 - Detailed display: replay of I/Q data with increased time resolution
 - Realtime display of recorded data
- Single-channel direction finder upgrade kit
 - R&S®ESMD-DF option: upgrade to single-channel direction finder
 - Direction finding of signals in frequency range up to 6 GHz
 - Reliable DF results even in difficult environments (e.g. urban areas with up to 50% reflection)
 - Parallel direction finding of all emissions within 20 MHz realtime bandwidth
- Documentation of calibration values
 - R&S®ESMD-DCV option: documentation of calibration values with calibration certificate from final production testing for a specific serial number
 - Calibration label for instrument

Specifications in brief		
Frequency		
Frequency range, receive mode	base unit with R&S®ESMD-HF option with R&S®ESMD-SHF option with R&S®ESMD-HF and R&S®ESMD-SHF options	20 MHz to 3.6 GHz 8 kHz to 3.6 GHz 20 MHz to 26.5 GHz 8 kHz to 26.5 GHz
IF bandwidths		
Bandwidth	demodulation, level and offset measurement (3 dB bandwidth), 34 filters	100/150/300/600 Hz, 1/1.5/2.1/2.4/2.7/3.1/4/4.8/6/9/12/15/30/50/120/150/250/ 300/500/800 kHz, 1/1.25/1.5/2/5/8/10/12.5/15/20 MHz
Demodulation		
Demodulation modes	all IF bandwidths IF bandwidths ≤ 9 kHz	AM, FM, φM, pulse, ISB, I/Q, analog TV LSB, USB, CW, ISB
Realtime spectrum (IF panorama)		
FFT IF panorama		gap-free, dynamically overlapping FFT operating mode: automatic or variable with selectable frequency resolution 0.625/1.25/2.5/3.125/6.25/12.5/25/31.25/50/62.5/100/125/200/ 250/312.5/500/ 625 Hz, 1/1.25/2/2.5/3.125/5/6.25/8.333/10/12.5/20/25/50/100/ 200/500 kHz, 1 MHz, 2 MHz
Span	base unit with R&S®ESMD-ADC2 and R&S®ESMD-WB options	1/2/5/10/20/50/100/200/500 kHz, 1/2/5/10/20 MHz additionally 40 MHz and 80 MHz

Specifications in brief		
Spectrum display		clear/write, average, max. hold, min. hold, histogram, pulse
Scan characteristics		
Memory scan		10000 programmable memory locations; speed: up to 1200 channels/s
Frequency scan		user-selectable start/stop frequency and step size; speed: up to 1500 channels/s
Panorama scan	with R&S®ESMD-PS option	RF spectrum with user-selectable start/stop frequency and step size 100/125/200/250/500/625 Hz, 1/1.25/2/2.5/3.125/5/6.25/8.333/10/12.5/20/25/50/100/ 200/500 kHz, 1 MHz, 2 MHz; speed: up to 270 GHz/s (in-band), up to 850 GHz/s (in-band) with 80 MHz option

Ordering information		
Designation	Type	Order No.
Wideband Monitoring Receiver, without front panel control	R&S®ESMD	4066.0004.02
Wideband Monitoring Receiver, with front panel control	R&S®ESMD	4066.0004.03
Documentation of Calibration Values	R&S®ESMD-DCV	4066.4780.02
Options		
HF Frequency Range Extension, 8 kHz to 32 MHz	R&S®ESMD-HF	4066.4100.02
SHF Frequency Range Extension, 3.6 GHz to 26.5 GHz ¹⁾	R&S®ESMD-SHF	4066.4200.02
Panorama Scan	R&S®ESMD-PS	4066.4500.02
Internal Recording	R&S®ESMD-IR	4079.7960.02
Map Display	R&S®ESMD-Map	4079.7977.02
ITU Measurement Software	R&S®ESMD-IM	4066.4400.02
Zero Span	R&S®ESMD-ZS	4079.7983.02
Selective Call Analysis	R&S®ESMD-SL	4066.4600.02
Multifunction Board	R&S®ESMD-ADC2	4079.7925.02
80 MHz IF Panorama Bandwidth ²⁾	R&S®ESMD-WB	4066.4645.02
Digital Downconverter ²⁾	R&S®ESMD-DDC	4066.4545.02
Direction Finder Upgrade Kit	R&S®ESMD-DF	4066.4300.02
DF Error Correction	R&S®ESMD-COR	4066.4745.02
DC Power Supply	R&S®ESMD-DC	4066.4000.02
Broadband I/O Data Streaming Board	R&S®ESMD-DIQ	4079.8109.02
10 Gbit Ethernet Interface (without transceiver module) ³⁾	R&S®RX-10G	4074.7604.02
Internal GPS Module and External GPS Antenna	R&S®ESMD-IGT	4079.8009.02
Record and Replay ⁴⁾	R&S®ESMD-RR	4079.7954.02
Options for hardware-accelerated signal processing (in combination with R&S®CA120)		
Signal Processing Board	R&S®ESMD-SP	4066.4268.02
DDC Signal Extraction ⁵⁾	R&S®ESMD-DDCE	4079.7760.02
High-Resolution Panorama Spectrum ⁵⁾	R&S®ESMD-HRP	4079.7902.02
Detection of Short-Time Signals ⁵⁾	R&S®ESMD-ST	4079.7883.02
Recommended extras		
19" Rack Adapter	R&S®ZZA-411	1096.3283.00
Optical Cable, for 10 Gbit, incl. two optical transceivers, length: 20 m	R&S®GX460-OCG	4094.8641.02
Copper Cable, for 10 Gbit, incl. two transceivers, length: 5 m	R&S®GX460-CCG	4094.8635.02

¹⁾ Upgrade must be performed in factory. ²⁾ Only one R&S®ESMD-ADC2 is required for both options. ³⁾ Only one R&S®ESMD-DIQ is required for this option.

⁴⁾ Only one R&S®ESMD-ADC2 is required for this option. ⁵⁾ One R&S®ESMD-ADC2 and one R&S®ESMD-SP are required for this option.

This product includes software developed by the University of California, Berkeley and its contributors.

This product includes software developed by the Kungliga Tekniska Högskolan and its contributors.

This product includes software developed by Yen Yen Lim and North Dakota State University.

This product includes software developed by the OpenSSL Project for use in the OpenSSL toolkit. (<http://www.openssl.org/>)

This product includes cryptographic software written by Eric Young (eay@cryptsoft.com) and software written by Tim Hudson (tjh@cryptsoft.com).

This product contains information from OpenStreetMap (<http://www.openstreetmap.org/>) which is made available here under the

Open Database License, ODbL (<http://opendatacommons.org/licenses/odbl/1.0/>).

R&S®EB500 Monitoring Receiver

Powerful and compact

The R&S®EB500 monitoring receiver was specially developed for signal search, radiomonitoring, radio detection and spectrum monitoring in powerful, compact systems. Due to the receiver's compact size as well as its excellent performance and energy-saving design, it is the perfect tool for radiomonitoring applications. It performs ITU-compliant measurements and meets the requirements of security authorities and organizations. The receiver is ideal for both stationary and mobile/vehicular applications because it can be operated via the front panel or remotely controlled via LAN.

The R&S®EB500 features a wide frequency range (8 kHz to 6 GHz), outstanding receive characteristics, 20 MHz realtime bandwidth and a wealth of functions.

Thanks to its sophisticated preselection stages, the receiver can be directly connected to a wideband monitoring antenna. This is an operating scenario that requires high large-signal immunity and high sensitivity, particularly in the presence of many strong signals.

An upgrade kit is available to turn the monitoring receiver into a high-performance, single-channel direction finder.

All results are output via the receiver's LAN interface, including:

- Spectra (realtime operation and scan mode)
- Waterfall (spectrogram)
- Demodulated audio information
- Level measurement data
- I/Q baseband data

Key facts

- ITU-compliant measurements and applications for security authorities and organizations
- Wide frequency range: 8 kHz to 6 GHz (base unit: 20 MHz to 3.6 GHz)
- 20 MHz realtime bandwidth
- Numerous options to increase performance
- Various result displays
- Integration into customer-specific software packages from third-party suppliers thanks to open, documented, remote control interface and data formats
- Internal recording and replay of spectra and waterfall data (for receivers with front panel operation or for external R&S®EB500-GUI software)
- Map display with GPS position (for receivers with front panel operation or for external R&S®EB500-GUI software)

Benefits and key features

- Frequency range from 8 kHz to 6 GHz
 - One monitoring receiver for "all" frequencies
 - Base unit: 20 MHz to 3.6 GHz:
 - R&S®EB500-HF: option for HF signal reception from 8 kHz
 - R&S®EB500-FE: option for SHF signal reception up to 6 GHz
 - Same size, even with all frequency options installed (½ 19" width, 3 HU)
- Integrated antenna switch
 - Two separate inputs for HF (1) and HF/VHF/UHF/SHF (1)
 - Automatic switching between antennas as a function of selected frequency, even during scanning



R&S®EB500 with display.



R&S®EB500 without display.

- Powerful preselection: large-signal immunity and high sensitivity
 - Reliable protection against overloading due to strong signals
 - Outstanding sensitivity due to high-gain preamplifier stage
 - Ideal monitoring receiver with wide dynamic range for all signal scenarios
 - Smooth operation, e.g. with a wideband receiving antenna (responsible for high total signal load at receiver input)
- FFT signal processing with 20 MHz realtime bandwidth
 - Realtime spectrum for detecting pulsed or frequency agile signals
 - FFT signal processing for fine frequency resolution and high sensitivity
 - FPGA implementation for top processing speed with fine resolution and sensitivity
- Extremely fast spectral scan (panorama scan) across entire frequency range
 - R&S®EB500-PS option: extremely fast FFT scan
 - Fast spectrum overview at fine resolution bandwidth
 - Combination of spectral results and waterfall display
 - Optimal determination of frequency range of interest from an unknown starting position
- Waterfall diagram for examination of signal history
 - Three-dimensional display of spectrum over frequency, time and color-coded signal level
 - History mode function to stop the waterfall and display a previous spectrum
 - Outstanding visual presentation of pulsed or frequency agile signals
 - Settable time resolution of waterfall (speed)
- Recording of spectra and waterfall data and replay of results
 - Recording of spectra and waterfall data, e.g. on a USB flash drive
 - Replay of recorded content for detailed evaluation of signals contained in spectrum
 - Identical receiver and parameter settings in recording and replay modes
 - For receivers with front panel operation or for external R&S®EB500-GUI software
- Map display with GPS position
 - Map display of current receiver location
 - Selectable display of recorded results (e.g. spectra) relative to a position
 - Map material based on OpenStreetMap (OSM)
 - For receivers with front panel operation or for external R&S®EB500-GUI software
- Polychrome spectrum to distinguish superimposed, pulsed signals
 - Display of time behavior (frequency of occurrence) of pulsed signals using color coding (for all realtime bandwidths)
 - Settable occurrence frequency threshold
 - Separate display of pulsed signals (superimposed in frequency, time and level)
- Video spectrum for display of subcarriers and transmission rates
 - Spectrum display of demodulated signal
 - Clear display of subcarriers, e.g. 19 kHz pilot tone
 - Squared video spectrum to estimate the transmission rate (baud rate) of a digitally modulated signal
 - Combination of spectral results and waterfall display
- Parallel signal processing of spectral path and demodulation path
 - Two parallel signal processing paths for spectrum and demodulation
 - Interference-free demodulation with parallel display of realtime spectrum and waterfall display
 - Seamless I/Q baseband data stream for signal analysis
 - Independent setting of bandwidth and center frequency
- Level measurements with “real” wideband detector
- Wideband level measurements up to 20 MHz bandwidth for sophisticated, digitally modulated signals
- Frequency scan and memory scan for audio demodulation on changing channels
 - Frequency scan: continuous scanning of adjacent channels, automatic demodulation of channels where level exceeds squelch, e.g. in ATC band
 - Memory scan: scanning of different radio services with variable step size and demodulation mode
 - Convenient scanning for active signals and quick availability of audio content
- 3+1 receivers in one instrument
 - R&S®EB500-DDC option: three additional demodulation channels
 - Four software receivers in one instrument thanks to four demodulation channels (anywhere within realtime bandwidth)
 - Output of demodulated data as separate data streams via LAN interface
- Ethernet interface for remote control and/or data transmission
 - 1 Gbit Ethernet LAN interface for receiver remote control and result processing using Rohde & Schwarz system software (e.g. R&S®ARGUS, R&S®RAMON, R&S®CA100)
 - Documented interface description for flexible programming and data processing, even with customer-specific software package

- ▮ Receiver remote control and data recording
 - R&S®EB500-Control software package for receiver remote control via 1 Gbit LAN interface
 - Documentation of results on a PC (e.g. spectra or audio content), also for replaying recorded data for offline analysis
- ▮ ITU-compliant measurements in the receiver
 - R&S®EB500-IM option: ITU-compliant measurement of signal parameters for AM, FM and PM-modulated signals (e.g. modulation index, occupied bandwidth and phase deviation)
 - Offline measurement of digitally modulated signals using the R&S®CA100IS software and suitable options (in line with ITU recommendation SM.1600)
- ▮ Detection of selective call services
 - R&S®EB500-SL option: detection of audio-based selective calls and listing of received selective call standards
 - Result filtering in line with relevant standards
- ▮ DC operation (e.g. from vehicle battery)
 - DC power supply (10 V to 32 V DC) of receiver
 - Space-saving vehicle installation
- ▮ System time synchronization using NTP server
 - Time and date synchronization using an NTP server for simultaneous control of multiple receivers in a networked system
 - Easy comparison of measurement results received by different stations
- ▮ Single-channel direction finder upgrade kit
 - R&S®EB500-DF option: upgrade to single-channel direction finder
 - Direction finding of signals in frequency range up to 6 GHz
 - Reliable DF results even in difficult environments (e.g. urban areas with up to 50 % reflection)
 - Parallel direction finding of all emissions within 20 MHz realtime bandwidth
- ▮ Documentation of calibration values
 - R&S®EB500-DCV option: documentation of calibration values with calibration certificate from final production testing for a specific serial number
 - Calibration label for instrument

Specifications in brief		
Frequency		
Frequency range, receive mode	base unit	20 MHz to 3.6 GHz
	with R&S®EB500-HF option	8 kHz to 3.6 GHz
	with R&S®EB500-FE option	20 MHz to 6 GHz
	with R&S®EB500-HF and R&S®EB500-FE options	8 kHz to 6 GHz
IF bandwidths		
Bandwidth	demodulation, level and offset measurement (3 dB bandwidth), 34 filters	100/150/300/600 Hz, 1/1.5/2.1/2.4/2.7/3.1/4/4.8/6/9/12/15/30/50/120/ 150/250/300/500/800 kHz, 1/1.25/1.5/2/5/8/10/12.5/15/20 MHz
Demodulation		
Demodulation modes	all IF bandwidths	AM, FM, φM, pulse, ISB, I/Q
	IF bandwidths ≤ 8 kHz	LSB, USB, CW, ISB
Realtime spectrum (IF panorama)		
FFT spectrum		gap-free, dynamically overlapping FFT operating mode: automatic or variable with selectable frequency resolution 0.625/1.25/2.5/3.125/6.25/12.5/25/31.25/50/ 62.5/100/125/200/250/312.5/500/ 625 Hz, 1/1.25/2/2.5/3.125/5/6.25/8.333/10/12.5/20/25/ 50/100/200/500 kHz, 1 MHz/2 MHz
Spectrum span	base unit	1/2/5/10/20/50/100/200/500 kHz, 1/2/5/10/20 MHz
Spectrum display		clear/write, average, max. hold, min. hold, histogram, pulse
Scan characteristics		
Memory scan		10 000 programmable memory locations
	speed	up to 500 channels/s
Frequency scan		user-selectable start/stop frequency and step size
	speed	up to 500 channels/s

Specifications in brief

Fast spectral scan (panorama scan)	with R&S®EB500-PS option	spectral scan with user-selectable start/stop frequency, step size (bin): 100/125/200/250/500/625 Hz, 1/1.25/2/2.5/3.125/5/6.25/8.333/10/12.5/20/25/ 50/100/200/500 kHz, 1 MHz/2 MHz
	speed	up to 75 GHz/s (in-band)

Ordering information

Designation	Type	Order No.
Monitoring Receiver, without front panel control	R&S®EB500	4072.5004.02
Monitoring Receiver, with front panel control	R&S®EB500	4072.5004.03
Documentation of Calibration Values	R&S®EB500-DCV	4072.8403.02
Options		
HF Frequency Range Extension, 8 kHz to 32 MHz	R&S®EB500-HF	4072.8003.02
SHF Frequency Range Extension, 3.6 GHz to 6 GHz	R&S®EB500-FE	4072.9300.02
Panorama Scan	R&S®EB500-PS	4072.9200.02
Internal Recording	R&S®EB500-IR	4072.9551.02
Map Display	R&S®EB500-Map	4072.9451.02
ITU Measurement Software	R&S®EB500-IM	4072.9100.02
Selective Call Analysis	R&S®EB500-SL	4072.9800.02
Digital Downconverter	R&S®EB500-DDC	4072.9500.02
Direction Finder Upgrade Kit	R&S®EB500-DF	4072.9400.02
Wideband Direction Finding	R&S®EB500-WDF	4072.9651.02
DF Error Correction	R&S®EB500-COR	4072.9600.02
External GPS Module	R&S®EB5-EGT	4073.2009.02
Recommended extras		
19" Rack Adapter (2 × R&S®EB500 side by side)	R&S®ZZA-T04	1109.4187.00
19" Rack Adapter (1 × R&S®EB500 + 1 × blind plate)	R&S®ZZA-T02	1109.4164.00
DC Power Cable	R&S®EB500-DCC	4072.7036.00

R&S®EB510 HF Monitoring Receiver

New

High-performance radiomonitoring from 8 kHz to 32 MHz

The R&S®EB510 HF monitoring receiver is designed to meet the demanding requirements of ITU-compliant radiomonitoring tasks in stationary and mobile environments. The receiver performs high-speed signal searching in the spectrum and provides very wideband demodulation as well as a spectrum overview. It can be operated via the front panel or via remote control software. It is the ideal choice for a large variety of applications – from single-station measurements to nationwide monitoring systems.

The R&S®EB510 HF monitoring receiver has an outstanding feature set for monitoring transmissions, detecting interference, finding unlicensed transmitters or even functioning as a search receiver in the HF spectrum. In addition, it is exceptionally compact and has a low-power design. The R&S®EB510 is the optimum solution for systems that need a high-end receiver but only have limited available space. When combined with analysis software (such as R&S®GX430), it becomes a complete, compact receiving and analysis system covering the frequency range from 8 kHz to 32 MHz.

The receiver can be operated with diverse antennas such as broadband omnidirectional antennas and directional antennas. To limit overloading when using wideband antennas, the R&S®EB510 is equipped with a preselection stage (as recommended by ITU). As a result, intermodulation characteristics are significantly improved.

Due to its compact size and excellent balance between performance and power consumption, the R&S®EB510 is designed not just for stationary operation but also for installation in vehicles, in vessels or in aircraft (as payload).



R&S®EB510 with front panel.



R&S®EB510 without front panel.

Key facts

- Digital direct conversion receiver from 8 kHz to 32 MHz
- IF spectrum of up to 32 MHz and parallel demodulation with bandwidths from 100 Hz to 5 MHz
- Fast panorama scan with up to 60 GHz/s across the entire frequency range
- High-speed frequency and memory scan with up to 1600 channels/s
- Polychrome IF spectrum for reliable detection of pulsed signals
- Spectrum and spectrogram (waterfall) display on receiver (model .03) or on PC via the R&S®EB510-Control software (both model .02 and model .03)
- AM, FM, I/Q, AM², FM², I/Q² video panorama
- 1 Gbit LAN interface for remote control and data output
- Comparatively low power consumption for efficient DC operation, e.g. on a vehicle battery
- Space-saving system integration due to ½ 19" width and three height units
- Classification and analysis of signals up to 5 MHz bandwidth (analog and digital modulation) through evaluation of the I/Q data stream using the R&S®GX430IS software (in offline mode)
- Multichannel digital downconversion (DDC) within realtime bandwidth

Benefits and key features

- High receiver sensitivity, high signal resolution
 - State-of-the-art FFT-based digital signal processing for high receiver sensitivity and detection of extremely weak signals without any loss in processing speed
 - Significantly superior signal resolution (compared to conventional analog broadband receivers)
- Comprehensive spectrum analysis with polychrome display
 - Polychrome display for detection and analysis of short-duration signals
 - Multiple-color spectrum display (polychrome IF spectrum) and color coding of signal duration in the spectrum
 - Distinction of overlapping short-duration signals (displayed in blue) and long-duration signals (displayed in red), e.g. wideband interference resulting from switching power supply leakage
- Wide spectrum view without scanning
 - Full 32 MHz IF spectrum display without scanning
 - Monitoring of entire HF range in a single spectral view with simultaneous demodulation
 - Panorama scan function for spectral overview with narrower preselection
- Retrieval of information through demodulation and signal analysis in a compact system
 - Online LAN transfer from an R&S®EB510 to a PC with R&S®GX430 analysis software, for example, for operating an efficient small system for signal reception and analysis
 - Online analysis or recording of captured data using R&S®GX430, provision of data for documentation, replay or subsequent additional evaluation
 - ITU-compliant signal analysis in line with ITU-R SM.1600 using R&S®GX430 and R&S®GX430IS, optimum tool for single-channel analysis and measurement of analog and digitally modulated signals in accordance with ITU requirements
- Efficient operation via remote control
 - Remote control of all receiver functions via LAN interface (SCPI command set)
 - LAN interface for providing the maximum measured data rate during receiver operation; efficient remote operation in unattended monitoring stations (interface description available, especially essential for system integrators who need to incorporate the receiver into existing software environments)
- Convenient remote control with R&S®EB510-Control software
 - Short learning curve due to straightforward menu structure and simple operation
 - Alignment of displayed signals (depending on task), optimum display on screen
 - Remote control of receiver via PC, recording of measured data on hard disk and replay of data on PC for analysis purposes
 - Expansion of remote control software functionality through options and add-ons from the R&S®RAMON software suite
- Future-ready investment
 - Wide realtime bandwidth and very high scan speed for fast and reliable detection of all signal types in the HF range
 - Reception, demodulation and processing of signals of current and future radio services in the HF spectrum

Specifications in brief		
Frequency		
Frequency range	base unit	8 kHz to 32 MHz
Demodulation		
Demodulation modes	all IF bandwidths	AM, FM, φM, pulse, I/Q
	IF bandwidths ≤ 8 kHz	LSB, USB, CW
	IF bandwidths ≥ 1 kHz	ISB
IF bandwidths		
Bandwidth	demodulation, level and offset measurements (3 dB bandwidth), 29 filters	100/150/300/600 Hz, 1/1.5/2.1/2.4/2.7/3.1/4/4.8/6/9/12/15/30/50/ 120/150/250/300/500/800 kHz, 1/1.25/1.5/2/5 MHz
IF panorama		
FFT IF panorama	up to 4096-point FFT	dynamic, overlapping FFT
	operating modes	automatic or variable with selectable frequency resolution
		0.625/1.25/2.5/3.125/6.25/12.5/25/31.25/50/62.5/ 100/125/200/250/312.5/500/625 Hz, 1/1.25/2/2.5/3.125/5/6.25/8.333/10/12.5/20/ 25/50/100/200/500 kHz, 1 MHz, 2 MHz
IF panorama span		1/2/5/10/20/50/100/200/500 kHz, 1/2/5/10/20/32 MHz
Panorama display		clear/write, average, max. hold, min. hold, histogram
Memory scan		10 000 programmable memory locations
	speed	up to 1600 channels/s
Frequency scan		user-selectable start/stop frequency and step width
	speed	up to 1600 channels/s
Panorama scan	with R&S®EB510-PS option	RF spectrum with user-selectable start/stop frequency and step width: 100/125/200/250/500/625 Hz, 1/1.25/2/2.5/3.125/5/6.25/8.333/10/12.5/20/ 25/50/100/200/500 kHz, 1 MHz, 2 MHz
	speed	up to 60 GHz/s

Ordering information		
Designation	Type	Order No.
HF Monitoring Receiver, with control front panel, frequency range from 8 kHz to 32 MHz, IF spectrum (max. 32 MHz), remote control software supplied with receiver	R&S®EB510	4091.7009.03
HF Monitoring Receiver, without control front panel, frequency range from 8 kHz to 32 MHz, IF spectrum (max. 32 MHz), remote control software supplied with receiver	R&S®EB510	4091.7009.02
Options		
Digital Downconverter, three digital downconverters for user-defined placement within realtime bandwidth	R&S®EB510-DDC	4072.9500.04
Panorama Scan, RF scan, high-speed FFT scan across user-selectable range, selectable spectral resolution	R&S®EB510-PS	4072.9200.04
ITU Measurement, ITU-compliant measurement of AM/FM-modulated signals in the R&S®EB510	R&S®EB510-IM	4072.9100.04
Internal Recording	R&S®EB510-IR	4072.9551.04
Map Display	R&S®EB510-MAP	4072.9451.04
Selective Call, selective call analysis	R&S®EB510-SL	4072.9800.04
Analysis of Signal Scenarios, in line with ITU-R SM.1600 (requires R&S®GX430 signal analysis and signal processing software)	R&S®GX430IS	4071.5817.02
Accessories		
19" Rack Adapter (2 × R&S®EB510 side by side)	R&S®ZZA-T04	1109.4187.00
19" Rack Adapter (1 × R&S®EB510 + 1 × blind plate)	R&S®ZZA-T02	1109.4164.00
DC Power Cable	R&S®EB500-DCC	4072.7036.00
Calibration documenting		
Documentation of Calibration Values	R&S®EB510-DCV	4072.8403.04

R&S®EM100/ R&S®EM100XT Digital Compact Receiver

Compact radiomonitoring from 9 kHz to 7.5 GHz

R&S®EM100 digital compact receiver

The R&S®EM100 digital compact receiver has been specifically designed as a cost-efficient mobile radiomonitoring solution. The receiver's operation via remote control software and its monitoring functionality have been optimized for tasks requiring a handoff receiver in combination with a high-speed search receiver, for example. In addition, it can be used for a variety of other applications.

The R&S®EM100 digital compact receiver has an excellent feature set for monitoring transmissions, detecting interference, locating miniature transmitters or even functioning as a handoff receiver. In addition, it is extremely compact and consumes very little power. The R&S®EM100 is the optimum solution for systems with tight budgets, combining cost efficiency with technical capabilities that yield the desired results. When combined with analysis software (such as R&S®CA100), it provides users with a compact receiving and analysis system covering a wide frequency range from 9 kHz to 7.5 GHz.

The receiver can be operated with diverse antennas such as broadband omnidirectional antennas and directional antennas.

Though compact, the entry-level R&S®EM100 receiver offers a wide range of functions otherwise available only in equipment in higher price segments. Its favorable price/performance ratio makes it an indispensable instrument

for all types of radiomonitoring tasks where space-saving integration and cost efficiency are crucial.

Thanks to its compact size and low weight, the R&S®EM100 is ideal for use in vehicles, aircraft (as a payload) and unmanned aerial vehicles (UAV).

Key facts

- Fast panorama scan with up to 1.8 GHz/s across the entire frequency range from 9 kHz to 7.5 GHz
- 10 MHz IF spectrum and demodulation with bandwidths from 150 Hz to 500 kHz
- Automatic bearing information of emissions with direction finding algorithms (20 MHz to 6 GHz)
- Spectrum and spectrogram (waterfall) display via the R&S®EM100-Control software
- Synchronization of receiver frequency and time using the R&S®ESMD-IGT internal GPS module
- High-accuracy timestamps in I/Q baseband data stream for use in TDOA systems
- LAN interface for remote control and data output
- Low power consumption for long-term operation from an autonomous power source
- Space-saving system integration due to ½ 19" width and one height unit
- Classification and analysis of signals up to 500 kHz bandwidth (analog and digital modulation) using the R&S®CA100 software
- Low weight (approx. 2.5 kg)

R&S®EM100XT digital compact receiver

The weatherproof R&S®EM100XT digital compact receiver has inherited all the functionality of the R&S®EM100. In addition, the R&S®EM100XT with IP67 protection class enables cost-efficient outdoor fixed or mobile radiomonitoring. The receiver is operated via the same user-friendly remote control software (R&S®EM100-Control) that is used for the R&S®EM100.

The robust receiver's weatherproof enclosure makes it suitable for short and long-term outdoor deployment. It is well protected against rain and dust. With the R&S®EM100XT-IG option, a GPS module can easily be installed in the device to transform the receiver into a TDOA sensor node. The R&S®EM100XT-DF option can also be added for direction finding tasks. When both options



Front panel with no control elements; remote control via LAN interface.

are installed (plus a GPS antenna and DF antenna), the R&S®EM100XT becomes a hybrid solution for effectively and accurately determining the direction from which an emitter is transmitting.

The mounting brackets (R&S®EM100XT-BR) were specially designed for conveniently fixing the device to any pole or wall structure. The tilted top-plate functions as a sun shade. Well-fitted side handles (R&S®EM100XT-HD) are available for easy transportation.

Key facts

- Same functionality as R&S®EM100
- IP67 weatherproof housing
- Integrated heating device for operating temperatures as low as -25°C
- Integrated GPS module for enhanced frequency and timing accuracy
- LAN interface for remote control and data output
- Data buffering to internal SD card for time-shifted data output via LAN interface

Benefits and key features

- High receiver sensitivity, high signal resolution
 - State-of-the-art digital signal processing for high receiver sensitivity and detection of extremely weak signals without any loss in processing speed



R&S®EM100XT with mounting bracket.



R&S®EM100XT with handles.

- Significantly superior receiver sensitivity and signal resolution (compared with conventional analog broadband receivers)
- Retrieval of information through demodulation and operation as handoff receiver
 - Analog-modulated signals demodulated directly in the receiver; contents audible using headphones
 - Digitally modulated signals converted to the baseband by means of I/Q demodulation and exported via LAN
 - Offline analysis of digital signals, e.g. with the R&S®CA100
- Monitoring receiver and signal analysis in a compact system
 - Online LAN transfer from an R&S®EM100 to a PC and to the R&S®CA100 analysis software, for example, to operate an efficient small system for signal reception and analysis
 - Recording of captured data using R&S®CA100; provision of data for documentation, replay or subsequent additional evaluation
- Efficient operation via remote control
 - Remote control of all receiver functions via LAN interface (SCPI command set in line with IEEE 488.2)
 - LAN interface for providing the maximum measured data rate during receiver operation; efficient remote operation in unattended monitoring stations (interface essential, especially for system integrators who need to incorporate the receiver into existing software environments)
- Convenient R&S®EM100-Control remote control software
 - Short learning curve due to straightforward menu structure and simple operation
 - Parameterization of displayed signals (depending on task), optimum display on screen
 - Remote control of receiver via PC, recording of measured data on hard disk, and replay of data on PC for analysis purposes
 - Expansion of remote control software functionality through options and add-ons from the R&S®RAMON software suite

DF functionality with R&S®EM100-DF upgrade kit:
 The R&S®EM100 supports DF functionality when upgraded with the R&S®EM100-DF upgrade kit. Using the patented Rohde&Schwarz single-channel correlative interferometer DF method (above 173 MHz), it provides DF accuracy and immunity to reflections comparable to that of direction finders with two or more receive paths. In the frequency range below 173 MHz, the Watson-Watt direction finding method is used. This method offers high DF accuracy even for small DF antennas. In combination with the R&S®EM100-DF upgrade kit, the R&S®EM100 becomes an accurate, compact and cost effective DF solution

The R&S®EM100 is combined with R&S®ADD107 and R&S®ADD207 compact DF antennas to provide users with a wide direction finding frequency range from 20 MHz to 6 GHz. Both the R&S®ADD107 and R&S®ADD207 compact DF antennas come with an

integrated GPS system and an electronic compass that can be used to display DF results on a map. When used with the R&S®ADD17XZ3 vehicle adapter with magnetic mount or the R&S®ADD17XZ6 wooden tripod, the solution allows quick and easy setup of DF stations and mobile direction finders

- Compact design and low power consumption
 - Compact size and low weight for effective integration in small systems
 - Particularly when installed in vehicles: compact design and low power consumption enable simultaneous operation of multiple R&S®EM100, e.g. as handoff receivers
- Future-ready investment
 - Wide frequency range and outstanding performance
 - Capable of receiving and processing signals of current and future radio services

Specifications in brief

RF data

Frequency range	base unit	9 kHz to 3.5 GHz
	with R&S®EM100-FE option	9 kHz to 7.5 GHz
RF input		
Impedance		50 Ω
Preselection	9 kHz to 30 MHz	30 MHz lowpass filter
	20 MHz to 1.5 GHz	tuned bandpass filters
	1.5 GHz to 7.5 GHz	highpass/lowpass filter combination

IF data

IF spectrum display range		1 kHz to 10 MHz, 1/2/5/10/20/50/100/200/500 kHz, 1/2/5/10 MHz
Display modes		normal (clear/write), average, max. hold, min. hold
IF demodulation bandwidths	15 filters (specified values indicate 3 dB bandwidth)	150/300/600 Hz, 1.5/2.4/6/9/15/30/50/120/150/250/300/500 kHz
Demodulation modes	all demodulation bandwidths	AM, FM, pulse, I/Q
	demodulation bandwidth ≤ 9 kHz	USB, CW
	demodulation bandwidth ≤ 9 kHz	LSB
	demodulation bandwidth ≤ 15 kHz	ISB
	demodulation bandwidth ≤ 9 kHz	CW

Scan modes

Frequency scan (FScan)	start and stop frequency, step width	user-selectable
	scan speed	up to 150 channels/s
Memory scan (MScan)	memory locations	1024, user-programmable
	scan speed	up to 150 channels/s
Panorama scan (PScan)	start and stop frequency	user-selectable
	resolution bandwidths (bin widths)	125/250/500/625 Hz, 1.25/2.5/3.125/6.25/12.5/25/50/100 kHz
	scan speed (RBW = 100 kHz, measurement time = 500 μs, RF spectrum = normal, clear/write, display mode = RF spectrum)	up to 1.8 GHz/s

DF mode

Frequency range		20 MHz to 6 GHz
DF method	20 MHz to 173 MHz	Watson-Watt
	173 MHz to 6 GHz	correlative interferometer

Ordering information		
Designation	Type	Order No.
Digital Compact Receiver, frequency range from 9 kHz to 3.5 GHz, IF spectrum (max. 10 MHz), R&S®EM100-Control remote control software (basic package)	R&S®EM100 R&S®EM100XT	4070.4800.04 4500.9008.04
Frequency Range Extension, from 3.5 GHz to 7.5 GHz	R&S®EM100-FE R&S®EM100XT-FE	4070.4669.03 4070.4669.04
Documentation of Calibration Values	R&S®EM100-DCV R&S®EM100XT-DC	4071.9906.03 4071.9906.04
Options		
Panorama Scan, RF scan, high-speed FFT scan across user-selectable scan range, selectable spectral resolution	R&S®EM100-PS R&S®EM100XT-PS	4071.9306.03 4071.9306.04
Field Strength Measurement, antenna factors are stored in the receiver for field strength calculation; the field strength is displayed directly in dBµV/m on the user interface of the remote control software	R&S®EM100-FS R&S®EM100XT-FS	4071.9506.03 4071.9506.04
Internal Recording, recording of measured data in receiver (RAM) or SD card, recording of audio data in WAV format (replay using Windows Media Player, for example), recording of I/Q data, spectra and spectrogram (waterfall) data, R&S®EM100-Control software for viewing measured data on customer PC	R&S®EM100-IR R&S®EM100XT-IR	4071.9358.03 4071.9358.04
Externally Triggered Measurements, an external sensor (not included) triggers a measurement in the R&S®EM100; the sensor is connected via the AUX interface	R&S®EM100-ETM R&S®EM100XT-ET	4071.9458.03 4071.9458.04
GPS Software Interface, for data stream processing of external GPS module (not included)	R&S®EM100-GPS R&S®EM100XT-GP	4071.9958.03 4071.9958.04
Direction Finder Upgrade Kit, adds accurate direction finding functionality to the R&S®EM100 receiver (DF antennas and cable set not included)	R&S®EM100-DF R&S®EM100XT-DF	4096.2805.03 4096.2805.04
Internal GPS Module and External GPS Antenna ¹⁾ , for synchronization of reference frequency for high-precision timestamps and TDOA	R&S®EM100-IGT R&S®EM100XT-IG	4070.4952.02 4500.9820.02
Accessories		
Power Supply, operating temperature range from 0°C to +40°C	R&S®HA-Z201	1309.6100.00
Car Adapter, operating temperature range from 0°C to +40°C	R&S®HA-Z202	1309.6117.00
GPS Receiver, external GPS receiver for the R&S®EM100	R&S®HA-Z240	1309.6700.03
19" Rack Adapter (2 × R&S®EM100 side by side)	R&S®ZZA-T31	1109.4435.00
19" Rack Adapter (1 × R&S®EM100 + 1 × blind plate)	R&S®ZZA-T32	1109.4441.00
Handles for R&S®EM100XT	R&S®EM100XT-HD	4500.0140.00
Mounting Bracket for R&S®EM100XT	R&S®EM100XT-BR	4501.0210.00
Serial Cable, for connecting the receiver with a PC for receiver configuration (e.g. with unknown IP address)	R&S®EM100-AUX	4070.4230.02
Active Omnidirectional Receiving Antenna, 20 MHz to 8 GHz,	R&S®HE600	4094.9002.02
Bias Unit	R&S®IN600	
9 kHz to 8 GHz, for supply of one active antenna, 100 V to 240 V AC		4094.3004.11
9 kHz to 8 GHz, for supply of up to two active antennas, 100 V to 240 V AC		4094.3004.12
9 kHz to 8 GHz, for supply of one active antenna, 10 V to 32 V DC		4094.3004.21
9 kHz to 8 GHz, for supply of up to two active antennas, 10 V to 32 V DC		4094.3004.22
DF antennas and accessories		
Compact VHF/UHF DF Antenna	R&S®ADD107	4090.7005.02
Compact UHF/SHF DF Antenna	R&S®ADD207	4096.0002.02
Vehicle Adapter with Magnet Mount	R&S®ADD17XZ3	4090.8801.02
Wooden Tripod	R&S®ADD17XZ6	4090.8860.02
Cable Set with Converter	R&S®ADD17XZ5	4090.8660.02

¹⁾ The R&S®EM100-GPS GPS software interface option is included in the R&S®EM100-IGT option.

R&S®PR100 Portable Receiver

On-site radiomonitoring from 9 kHz to 7.5 GHz

The R&S®PR100 portable receiver has been specifically designed for radiomonitoring applications in the field. The receiver's functions and control concept have been optimized for monitoring tasks. In addition, it can be used for a variety of other applications.

The R&S®PR100 operates in a wide frequency range from 9 kHz to 7.5 GHz. Whether used for monitoring emissions, detecting interference or locating miniature transmitters, the receiver always combines high mobility with maximum operating ease. The receiver and the R&S®HE300 active directional antenna together form a compact receiving system. The receiver can also be used in conjunction with other antennas, e.g. broadband omnidirectional antennas.

Despite its compact design, the R&S®PR100 offers a wide range of functions otherwise available only in equipment in higher price segments. Its favorable price/performance ratio makes it an indispensable instrument for all radiomonitoring tasks where high mobility and cost-efficiency are crucial.

Featuring compact size and low weight, the R&S®PR100 is ideal for use in places that cannot be accessed with a vehicle. Its low power consumption allows the receiver to operate for up to four hours on a single battery charge. The lithium-ion battery can be exchanged in a matter of seconds without any tools. The current instrument settings are automatically written to the internal memory when the receiver is switched off.

Key facts

- Fast panorama scan across the entire frequency range from 9 kHz to 7.5 GHz
- 10 MHz IF spectrum and demodulation with bandwidths from 150 Hz to 500 kHz
- Spectrum and spectrogram (waterfall) display on 6.5" color screen
- Storage of measurement data to receiver's built-in SD card
- LAN interface for remote control and data output
- Ergonomic and rugged design for portable use
- Low weight: 3.5 kg including battery
- Manual location of emissions with the R&S®HE300 active directional antenna (9 kHz to 7.5 GHz)
- Automatic location of emissions with direction finding algorithms (20 MHz to 6 GHz)
- Display of digital maps on the R&S®PR100; triangulation based on multiple, manually or automatically determined DF results



Benefits and key features

- Future-ready investment
 - Wide frequency range and outstanding performance
 - Capable of receiving and processing signals of current and future radio services
- High receiver sensitivity, high signal resolution
 - State-of-the-art digital signal processing for high receiver sensitivity and detection of extremely weak signals without any loss in processing speed
 - Significantly superior receiver sensitivity and signal resolution (compared with conventional analog receivers)
- Retrieval of information through demodulation
 - Analog-modulated signals demodulated directly in the receiver; contents audible using headphones or built-in loudspeaker
 - Digitally modulated signals converted to the baseband using I/Q demodulation and stored in the receiver or exported via LAN
 - Online and offline analysis of digitally modulated signals, e.g. with the R&S®GX430 software
- Detection of pulsed signals and radar emissions
 - Capture of short-duration pulses, such as radar emissions
 - Wide IF bandwidth for analysis of short-duration pulses and pulse packets
- Monitoring receiver and mobile data memory in a single unit
 - Collected information written directly to the receiver's built-in SD card
 - Offline analysis of data recording during monitoring
- Efficient operation via remote control
 - Full remote control via LAN interface (SCPI commands to IEEE 488.2)
 - Efficient, remote receiver operation, e.g. in unattended monitoring stations
 - R&S®PR100-Control remote control software from the R&S®RAMON software family included
- Battery operation for mobile use
 - Low weight: 3.5 kg including battery
 - Long battery-powered operation: approx. 4 hours
- Intuitive, simple operation
 - Short learning curve due to straightforward menu structure and simple operation
 - Large 6.5" color display for signal analysis

2



Top view of the R&S®PR100: maximum operating ease in a compact box.



The R&S®PR100 with the R&S®HE300 active directional antenna: The antenna comes with three modules that cover the frequency range from 20 MHz to 7.5 GHz (can be expanded to 9 kHz with optional HF module). The preamplifier is accommodated in the grip piece.

Specifications in brief		
RF data		
Frequency range		9 kHz to 7.5 GHz
RF input		
Impedance		50 Ω
Preselection	9 kHz to 30 MHz	30 MHz lowpass filter
	20 MHz to 1.5 GHz	tuned bandpass filters
	1.5 GHz to 7.5 GHz	highpass/lowpass filter combination
IF data		
IF spectrum display range		1 kHz to 10 MHz, 1/2/5/10/20/50/100/200/500 kHz, 1/2/5/10 MHz
Display modes		normal (clear/write), average, max. hold, min. hold
IF demodulation bandwidths	15 filters (specified values indicate 3 dB bandwidth)	150/300/600 Hz, 1.5/2.4/6/9/15/30/50/120/150/250/300/500 kHz
Demodulation modes	all demodulation bandwidths	AM, FM, pulse, I/Q
	demodulation bandwidth ≤ 9 kHz	LSB
	demodulation bandwidth ≤ 15 kHz	ISB
	demodulation bandwidth ≤ 9 kHz	CW
Scan modes		
Frequency scan (FScan)	start and stop frequency, step width	user-selectable
	scan speed	up to 200 channels/s
Memory scan (MScan)	memory locations	1024, user-programmable
	scan speed	up to 150 channels/s
Panorama scan (PScan)	start and stop frequency	user-selectable
	resolution bandwidths (bin widths)	125/250/500/625 Hz, 1.25/2.5/3.125/6.25/12.5/25/50/100 kHz
	scan speed (RBW = 100 kHz, measurement time = 500 μs, IF spectrum = normal, clear/write, display mode = IF spectrum)	up to 2 GHz/s
DF mode		
Frequency range		20 MHz to 6 GHz
DF method	20 MHz to 173 MHz	Watson-Watt
	173 MHz to 6 GHz	correlative interferometer
Display resolution	selectable	0.1° or 1°

Ordering information		
Designation	Type	Order No.
Base unit		
Portable Receiver, IF spectrum (max. 10 MHz), spectrogram (waterfall display), 6-cell lithium-ion battery, plug-in power supply, SD card for storing user settings, shoulder strap	R&S®PR100	4079.9011.02
Documentation of Calibration Values	R&S®PR100-DCV	4071.9906.02
Options		
Panorama Scan, RF scan, high-speed FFT scan across user-selectable scan range, selectable spectral resolution (bin width)	R&S®PR100-PS	4071.9306.02
Internal Recording, recording of measured data in the receiver (64 Mbyte RAM) or on SD card, recording of audio data in WAV format (replay using Windows Media Player, for example), recording of I/Q data, spectra and spectrogram (waterfall) data, R&S®PR100-Control software for viewing measured data on customer PC	R&S®PR100-IR	4071.9358.02
Remote Control, remote control of receiver via LAN interface (SCPI protocol); transfer of measured data via LAN interface; transfer of demodulated I/Q data (up to 500 kHz bandwidth) via LAN interface; R&S®PR100-Control software (for remote control, data recording and data playback via PC)	R&S®PR100-RC	4071.9406.02

Ordering information		
Designation	Type	Order No.
Externally Triggered Measurements, an external sensor (not supplied with the receiver) triggers a measurement in the R&S®PR100; the sensor is connected via the AUX interface	R&S®PR100-ETM	4071.9458.02
Field Strength Measurement, the field strength is calculated using antenna factors stored in the receiver; the receiver displays the field strength directly in dBµV/m	R&S®PR100-FS	4071.9506.02
SHF Frequency Processing for downconverter antennas, the downconverter unit of the R&S®HF907DC antenna is connected to the receiver via a control cable; the receiver recalculates the downconverted signals to display them with their original frequencies up to 18 GHz and with the sidebands in their original positions, thus relieving the user from having to convert signals subsequently (antenna and downconverter not supplied with the R&S®PR100-FP option)	R&S®PR100-FP	4071.9558.02
GPS Software Interface, for data stream processing of external GPS module (GPS module not included in scope of delivery)	R&S®PR100-GPS	4071.9958.02
Direction Finder Upgrade Kit, adds accurate direction finding functionality to the R&S®PR100 receiver (DF antennas and cable set not included)	R&S®PR100-DF	4096.2805.02
Accessories		
Battery Pack, 6-cell lithium-ion battery, charging cradle, plug-in power supply	R&S®PR100-BP	4071.9206.02
Suitcase Kit, hard-shell transit case with headphones and telescopic antenna and extra space for accessories	R&S®PR100-SC	4071.9258.02
Vehicle Adapter	R&S®HA-Z202	1309.6117.00
Carrying Holster, chest strap and rainproof cover	R&S®HA-Z222	1309.6198.00
Carrying Bag, soft carrying bag	R&S®HA-Z220	1309.6175.00
GPS Receiver, external GPS receiver for the R&S®PR100	R&S®HA-Z240	1309.6700.03
Active Directional Antenna, three antenna modules covering the range from 20 MHz to 7.5 GHz, grip piece housing switchable preamplifier, hard-shell transit case with extra space for R&S®PR100 (model including mechanical compass)	R&S®HE300	4067.5900.02
Active Directional Antenna, three antenna modules covering the range from 20 MHz to 7.5 GHz, grip piece housing switchable preamplifier, hard-shell transit case with extra space for R&S®PR100 (model including electronic compass and integrated GPS module)	R&S®HE300	4067.5900.03
HF Option for R&S®HE300, loop antenna from 9 kHz to 20 MHz for R&S®HE300 active directional antenna	R&S®HE300HF	4067.6806.02
SHF antenna and accessories		
SHF Directional Antenna with Downconverter	R&S®HF907DC	4070.8006.02
Cable Set	R&S®HF907DC-K1	4070.8958.02
Tripod Adapter	R&S®HF907DC-Z1	4079.3113.02
Carrying Case	R&S®HF907DC-Z2	4079.3207.02
DF antennas and accessories		
Compact VHF/UHF DF Antenna	R&S®ADD107	4090.7005.02
Compact UHF/SHF DF Antenna	R&S®ADD207	4096.0002.02
Vehicle Adapter with Magnet Mount	R&S®ADD17XZ3	4090.8801.02
Wooden Tripod	R&S®ADD17XZ6	4090.8860.02
Cable Set with Converter	R&S®ADD17XZ5	4090.8660.02

R&S®HE300 Active Directional Antenna

20 MHz (optional 9 kHz) to 7.5 GHz

Portable directional antenna for locating transmitters and interference sources

The practical and very wideband R&S®HE300 active directional antenna locates transmitters and interference sources when combined with portable receivers (e.g. R&S®PR100). The three exchangeable antenna modules supplied with the antenna cover the 20 MHz to 7.5 GHz frequency range. An additional module (R&S®HE300HF for 9 kHz to 20 MHz) is available as an option. The modules can be plugged into the handle with the correct orientation for vertical or horizontal polarization and then mechanically locked in place.

A built-in, low-noise wideband amplifier can be activated to enhance system sensitivity (active mode).

In passive mode, the amplifier is bypassed so that the R&S®HE300 can also be used in the vicinity of strong signal sources.

Two different models of the R&S®HE300 are available. Model .02 contains an analog compass for bearing determination; model .03 is equipped with an integrated GPS receiver and an electronic compass. When used with the R&S®PR100 portable receiver, the potential target can easily be located on a map using the triangulation feature.

Key facts

- Unambiguous radiation pattern
- Direction finding by orienting antenna toward maximum field strength
- Very wideband performance in a compact size
- Low weight due to optimized selection of materials
- Fatigue-proof handling
- Horizontal and vertical polarization
- Wide dynamic range
- GPS positioning, compass bearing and triangulation feature (model .03)



Specifications		
Frequency range		9 kHz to 7.5 GHz
	antenna module 1	20 MHz to 200 MHz
	antenna module 2	200 MHz to 500 MHz
	antenna module 3	500 MHz to 7.5 GHz
	optional antenna module (R&S®HE300HF)	9 kHz to 20 MHz
Polarization		horizontal and vertical (by rotating the module before plugging in)
Input impedance		50 Ω
VSWR		typ. < 2.5 (except R&S®HE300HF)
Power supply	batteries	1.5 V AA cells (6 ×)
	rechargeable cells	1.2 V (6 ×)
	external supply	7 V to 9 V DC via plug
	current drain	approx. 100 mA at +25 °C
Connector		N male on cable (approx. 1 m emerging from handle)
MTBF		> 50 000 h, in line with MIL-HDBK-217E, ground fixed, +25 °C
Permissible temperature range		-10 °C to +55 °C
GPS/electronic compass unit (only applicable for model .03 and R&S®HE300UK)	power supply (via R&S®PR100)	5 V DC ± 0.2 V
	current drain	max. 100 mA
	GPS acquisition time	approx. 40 s
	electronic compass accuracy	typ. 2° RMS for 0° elevation, typ. 4° RMS for ± 60° elevation
	compass resolution	1°
Dimensions (L × W × H)	with antenna module 1	approx. 310 mm × 90 mm × 580 mm (12.2 in × 3.5 in × 22.8 in)
Weight	antenna with antenna module 1	approx. 1.5 kg (3.3 lb)
	antenna, including transit case	approx. 7 kg (15.4 lb)

Ordering information		
Designation	Type	Order No.
Active Directional Antenna, including analog compass	R&S®HE300	4067.5900.02
Active Directional Antenna, including GPS/electronic compass	R&S®HE300	4067.5900.03
GPS/Electronic Compass Upgrade Kit	R&S®HE300UK	4080.9011.02
Recommended extras		
Portable Receiver	R&S®PR100	4079.9011.02
HF Option (9 kHz to 20 MHz)	R&S®HE300HF	4067.6806.02
Handheld Log-Periodic Antenna	R&S®HL300	4097.3005.02

R&S®HL300 Handheld Log- Periodic Antenna

450 MHz to 8 GHz

Portable directional antenna for locating transmitters and interference sources

The R&S®HL300 handheld log-periodic antenna in combination with handheld spectrum analyzers (e.g. R&S®FSH4/8/13/20) is used for determining RF parameters and localizing interference sources.

The frequency range from 450 MHz to 8 GHz is covered by a log-periodic dipole array antenna structure with a distinct directional pattern. The antenna does not have to be tuned within its frequency range.

A built-in GPS receiver with an integrated patch antenna and an electronic compass provides position and bearing data for further processing in the connected spectrum analyzer (e.g. R&S®FSH4/8/13/20).

A toggle switch on the antenna handle activates or deactivates the low noise amplifier (LNA) inside the R&S®FSH4/8/13/20, allowing the use of the system in the vicinity of strong transmitters.

Key facts

- Unambiguous and nearly frequency-independent radiation pattern
- Handy size yet extreme broadband capability
- Fatigue-free operation due to antenna design and materials used, which keep weight to a minimum
- Integrated GPS receiver and electronic compass
- Power supply via the connected R&S®FSH4/8/13/20 handheld spectrum analyzer

New



Specifications		
Frequency range		450 MHz to 8 GHz
Polarization		vertical (horizontal by turning the antenna 90°)
Input impedance		50 Ω
VSWR	450 MHz to 500 MHz	< 3
	500 MHz to 8 GHz	< 2.5
Power supply	via R&S®FSH4/8/13/20	5 V DC (± 0.2 V) (max. 100 mA)
RF connector		N male on cable (approx. 1 m emerging from handle)
MTBF		> 100 000 h (in line with SN 29500, ground benign, +45°C)
GPS acquisition time	cold start	typ. 26 s
Time pulse frequency		1 Hz
Time pulse accuracy		30 ns RMS (under good GPS conditions)
Electronic compass range	for azimuth	0° to 360° in 1° steps
	for elevation	-60° to 60° in 1° steps
Electronic compass accuracy	for 0° elevation	typ. 2° RMS
	for ±60° elevation	typ. 4° RMS
Operating temperature range		-30°C to +55°C
Dimensions	W × H × L	approx. 310 mm × 90 mm × 580 mm (12.2 in × 3.5 in × 22.8 in)
Weight		approx. 1 kg (2.2 lb)

Ordering information		
Designation	Type	Order No.
Handheld Log-Periodic Antenna	R&S®HL300	4097.3005.02
Recommended extras		
Handheld Spectrum Analyzer	R&S®FSH4/8	1309.6000.xx
Handheld Spectrum Analyzer	R&S®FSH13/20	1314.2000.xx

R&S®HF907DC SHF Directional Antenna with Downconverter

7.5 GHz to 18 GHz

Broadband directional antenna with downconverter

For locating transmitters and interference sources when used with a portable receiver (e.g. the R&S®PR100 portable receiver)

The R&S®HF907DC consists of a downconverter and an antenna fixed to it. In order to detect signal sources, the R&S®HF907DC must be connected to a receiver (e.g. the R&S®PR100 portable receiver).

Signal bearings are obtained by manually pointing the antenna in the direction of maximum field strength.

The operating frequency range is downconverted to the range below 7.5 GHz in two switchable frequency bands. Preselection filters for each frequency band suppress image frequency and IF breakthrough.

The interface and display panel contains all display and control elements and connectors and provides access to the battery compartment.

Key facts

- Manual polarization switching (horizontal, vertical, 45°)
- Distinct directional pattern
- Battery operation for portable applications
- Automatic frequency switching (when used with the R&S®PR100)
- Excellent suppression of image frequency and IF breakthrough by means of switchable preselection filters



Specifications		
Frequency range		7.5 GHz to 18 GHz
Input frequency range	band 1	7.5 GHz to 12.5 GHz
	band 2	12.5 GHz to 18 GHz
Intermediate frequency range	band 1	6.5 GHz to 1.5 GHz
	band 2	7.5 GHz to 2 GHz
Antenna polarization		horizontal, vertical or 45°, manually adjustable
Nominal impedance		50 Ω
VSWR		typ. < 2.5, peaks up to 3.5 possible
Connector		N female
Frequency accuracy		< 25 kHz
Image frequency rejection		> 30 dB; typ. > 45 dB
IF breakthrough		< -30 dB; typ. < -40 dB
Antenna gain (passive structure)		typ. 8 dBi
Total noise figure		typ. 6 dB
Conversion gain of downconverter	band 1	typ. 42 dB
	band 2	typ. 35 dB
MTBF		> 30 000 h
Permissible temperature range		-10°C to +55°C
Dimensions (W × L × D)		approx. 147 mm × 355 mm × 172 mm (5.8 in × 14.0 in × 6.8 in)
Weight		approx. 3.5 kg (7.7 lb)

Ordering information		
Designation	Type	Order No.
SHF Directional Antenna with Downconverter	R&S®HF907DC	4070.8006.02
Recommended extras		
Portable Receiver	R&S®PR100	4079.9011.02
Rechargeable battery, 12 V, 3 Ah		4052.5680.02
Cable Set	R&S®HF907DC-K1	4070.8958.02
Tripod Adapter	R&S®HF907DC-Z1	4079.3113.02
Carrying Case	R&S®HF907DC-Z2	4079.3207.02

R&S®EFW Flywheel

Manual setting of receiver parameters

The R&S®EFW flywheel adds the capability of manual parameter control by means of a rotary knob to receivers that are controlled from a PC via external software (e.g. the R&S®EM100, R&S®EM510 or R&S®EM550).

The R&S®EFW flywheel is used for manual parameter control mainly in situations where a computer mouse would not provide sufficiently high resolution. The flywheel is helpful, for example, when setting the frequency on receivers that do not have a front panel with a rotary knob. A typical example is a radiomonitoring receiver, where a rotary knob such as the R&S®EFW flywheel comes into its own as it allows frequency settings to be made with the required fine resolution.

Fine-tuning of the frequency or the beat frequency oscillator (BFO) is indispensable in particular when using single sideband (SSB) modulation or a CW mode in shortwave operation.

Depending on the software used, further parameters can be controlled using the flywheel.

Key facts

- ▮ Manual parameter control by means of a rotary knob
- ▮ Parameter setting with fine motor control
- ▮ Especially helpful in SSB and CW operation

Benefits and key features

Parameter settings with higher resolution than with a PC mouse

The R&S®EFW simulates the scroll wheel of a PC mouse. It allows the required parameters to be adjusted at high speed while providing significantly higher resolution.

Connection to a PC via a USB interface

The flywheel connects to a PC via a USB interface. It has a USB 1.1 standard interface (USB 2.0 compatible).

No additional power supply required

Power is supplied via the USB interface.

Precision ball bearing – no friction-type bearing

The use of a precision ball bearing ensures particularly smooth rotation. Operation requires minimal physical effort.

Metal knob with high rotational mass

The large overdrive of the flywheel is advantageous for setting parameters quickly.

Non-slip surface

The surface of the rotary knob is grooved to provide a secure grip.

Plug & play

No special installation is required for operating the device.

Suitable for a wide variety of applications

The flywheel can be used with all Rohde & Schwarz monitoring receivers that are controlled via external software. It can therefore also be used in system applications.



Specifications

Interface

Data interface		USB 1.1 (USB 2.0 compatible)
----------------	--	------------------------------

Standards

EMC

Electromagnetic interference (EMI)		EN55022, class B (emissions)
Electromagnetic susceptibility (EMS)		EN61000-4-2, EN61000-4-3, EN61000-4-8
Mechanical stress	vibration (sinusoidal)	EN60068-2-6
	vibration (random)	IEC60068-2-64, class B
	shock	40 g shock spectrum, in line with MIL-STD-810F, method 516.4, IEC60068-2-27

General data

Operating temperature range		0°C to +50°C
Permissible temperature range	without condensation	-10°C to +55°C
Storage temperature range		-40°C to +70°C
Humidity		max. 95%, cyclic test at +25°C/+40°C
MTBF	IEC 1709	4500000 h
Power supply		5 V (via USB interface)
Current drain		typ. 50 mA
Dimensions (H x W x D)	without feet and rotary knob	approx. 75 mm x 115 mm x 115 mm (2.95 in x 4.53 in x 4.53 in)
	depth including rotary knob	130 mm (5.12 in)
Weight		approx. 650 g (1.43 lb)

Ordering information

Designation	Type	Order No.
Flywheel	R&S®EFW	4075.5505.02

Accessories supplied

USB cable



Chapter 3

Direction Finders

Locating emissions of a few hundred microseconds

Using state-of-the-art digital technology, direction finders from Rohde&Schwarz detect any signal from 300 kHz to 3 GHz. Even extremely brief emissions of only 400 μ s (e.g. GSM) will be intercepted and located. Due to the implementation of various DF methods, the direction finders can be optimally matched to any application.

We offer a complete program

- Equipment for land-based, airborne or shipboard use
- Portable sets as well as stationary search DF systems
- Single station location (SSL) DF systems for the HF range
- As regards intercepted, located frequency hopping networks, our fast digital search direction finders and receivers featuring synchronous scanning stand every test

Type	Designation	Page
	Introduction into Theory of Direction Finding	62
New	R&S®DDF5GTS High-Speed Scanning Direction Finder	86
	R&S®DDF550 Wideband Direction Finder	88
	R&S®ADDx Multichannel DF Antennas	90
	R&S®DDF255 Digital Direction Finder	94
	R&S®DDF205 Digital Direction Finder	98
New	R&S®DDF007 Portable Direction Finder	100
New	R&S®ADDx Single-Channel DF Antennas	104
	R&S®DDF04E Digital Direction Finder for Traffic Control	108
New	R&S®DDF200M Digital Direction Finder	110

Introduction into Theory of Direction Finding

Introduction

Applications of direction finding

While direction finding for navigation purposes (referred to as cooperative direction finding) is becoming less important due to the availability of satellite navigation systems, there is a growing requirement for determining the location of emitters as the mobility of communications equipment increases:

- In radiomonitoring in line with ITU guidelines
 - Searching for sources of interference
 - Localization of non-authorized transmitters
- In security services
 - Reconnaissance of radiocommunications of criminal organizations
- In military intelligence [1]
 - Detecting activities of potential enemies
 - Gaining information on enemy's communications order of battle
- In intelligent communications systems
 - Space division multiple access (SDMA) requiring knowledge of the direction of incident waves [2]
- In research
 - Radio astronomy
 - Earth remote sensing

Another reason for the importance of direction finding lies in the fact that spread-spectrum techniques are increasingly used for wireless communications. This means that the spectral components can only be allocated to a specific emitter if the direction is known. Direction finding is therefore an indispensable first step in radiodetection, particularly since reading the contents of such emissions is usually impossible.

The localization of emitters is often a multistage process. Direction finders distributed across a country allow an emitter to be located to within a few kilometers (typ. 1% to 3% of the DF distances) by means of triangulation. The emitter location can more precisely be determined with the aid of direction finders installed in vehicles. Portable direction finders moreover allow searching within the last 100 m, for instance in buildings.



Historical development

The DF technique has existed for as long as electromagnetic waves have been known. It was Heinrich Hertz who in 1888 found out about the directivity of antennas when conducting experiments in the decimetric wave range. A specific application of this discovery for determining the direction of incidence of electromagnetic waves was proposed in 1906 in a patent obtained by Scheller on a homing DF method.

The initial DF units were polarization direction finders. They consisted of a rotatable electric or magnetic dipole whose axis was brought to coincidence with the direction of the electric or magnetic field. From the direction of polarization, the direction of incidence was then deduced. The rotating-loop direction finder is one of the best known direction finders of this type. In 1907, Bellini and Tosi discovered the DF principle that was named after them: a combination of two crossed directional antennas (e.g. loop antennas) with a moving-coil goniometer for determining the direction [1]. Despite this invention, rotating-loop direction finders were often used in the First World War (Fig. 1).

The invention made by Adcock meant a great leap forward in the improvement of the DF accuracy with respect to sky waves in the shortwave range. The pharmacist by profession realized in 1917 that with the aid of vertical linear antennas (rod antennas or dipoles) directional patterns can be generated that correspond to those of loop antennas but do not pick up any interfering horizontally polarized field components (G. Eckard proved in 1972 that this is not true in all cases [3]). It was not until 1931 that Adcock antennas were first employed in Great Britain and Germany.

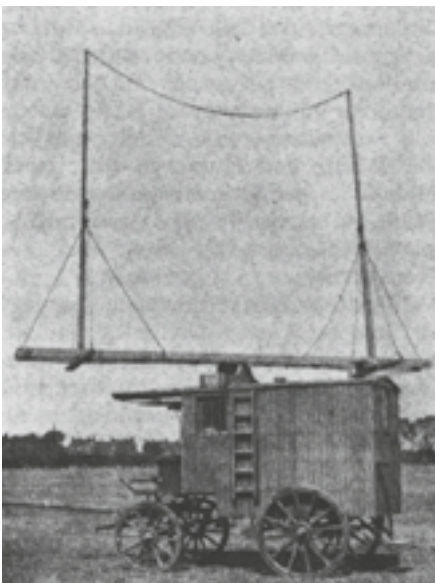

Fig. 1: Mobile rotating-loop direction finder for military use (about 1918) [1].

In 1925/26, Sir Watson-Watt took the step from the mechanically moved goniometer direction finder to the electronic visual direction finder. As from 1943, British naval vessels were equipped with crossed loops and three-channel Watson-Watt direction finders for the shortwave range ("huff-duff" for detecting German submarines).

As from 1931, camouflaged direction finders were available for use in vehicles and as portable direction finders for detecting spies.

The first shortwave direction finder operating on the Doppler principle was built in 1941. The rapid progress in the development of radar in Great Britain made it necessary to cover higher frequency ranges: In 1943, the first direction finders for "radar observation" at around 3000 MHz were delivered [1].

As from 1943, wide-aperture circular-array direction finders (Wullenweber) were built for use as remote direction finders. Since the 1950s, airports all over the world have been equipped with VHF/UHF Doppler direction finding systems for air traffic control.

In the early 1970s, digital technology made its way into direction finding and radiolocation; digital bearing generation and digital remote control are major outcomes of this development.

Since 1980, digital signal processing has been increasingly used in direction finding. It permits the implementation of the interferometer direction finder and initial approaches toward the implementation of multiwave direction finders (super-resolution). The first theoretical considerations were made much earlier, e.g. in [4].

Another important impetus for development came from the requirement for the direction finding of frequency agile emissions such as frequency hopping and spread-spectrum signals. The main result of this was the broadband direction finder, which is able to simultaneously perform searching and direction finding based on digital filter banks (usually with the aid of fast Fourier transform (FFT)) [5].

Tasks of direction finding

The task of a radio direction finder is to estimate the direction of an emitter by measuring and evaluating electromagnetic field parameters.

Usually, the azimuth α is sufficient to determine the direction; the measurement of elevation ε is of interest for emitters installed on flying platforms and especially for the direction finding of shortwave signals (Fig. 2).

Only in the case of undisturbed wave propagation is the direction of the emitter identical with the direction of incidence of the radio waves. Usually, there is a large number of partial waves arriving from different directions and making up a more or less scattered field. The direction finder takes spatial and temporal samples from this wavefront and, in the ideal case, delivers the estimated values $\hat{\alpha}$ and $\hat{\varepsilon}$ as the most probable direction of the emitter.

Bearings can be taken using the following reference directions (Fig. 3) (see also EN3312 [6]):

- Geographic north (true north) ▷ true radio bearing
- Magnetic north
- Vehicle axis ▷ relative or direct radio bearing

DF principles

Generation and characterization of electromagnetic waves

Electromagnetic waves are caused by charging and discharging processes on electrical conductors that can be represented in the form of alternating currents [7], [8].

The first assumption is based on the undisturbed propagation of a harmonic wave of wavelength λ . At a sufficiently large distance, the radial field components are largely decayed so that, limited to a small area, the wave can be

considered to be plane: Electric and magnetic field components are orthogonal to and in phase with one another and are perpendicular to the direction of propagation, which is defined by the radiation density vector (Poynting vector) \vec{S}

$$\vec{S} = \vec{E} \times \vec{H} = \vec{e}_0 \frac{|E|^2}{Z_0}$$

where E = RMS value of electric field strength
 Z_0 = characteristic impedance of free space;
 $Z_0 \cong 120 \cdot \pi \Omega$

or by the wave number vector \vec{k} (Fig. 4).

$$\vec{k} = \vec{e}_0 \frac{2\pi}{\lambda}$$

Overview of main DF principles

Direction finding relies on the basic characteristics of electromagnetic waves, which are:

- Transversality, i.e. field vectors are perpendicular to the direction of propagation
- Orthogonality of phase surfaces and direction of propagation

Every DF process essentially employs one of the following methods (Table 1 on next page):

- Method A: measures the direction of electric and/or magnetic field vectors ▷ polarization direction finders
- Method B: measures the orientation of surfaces of equal phase (or lines of equal phase if the elevation is not of interest) ▷ phase direction finder

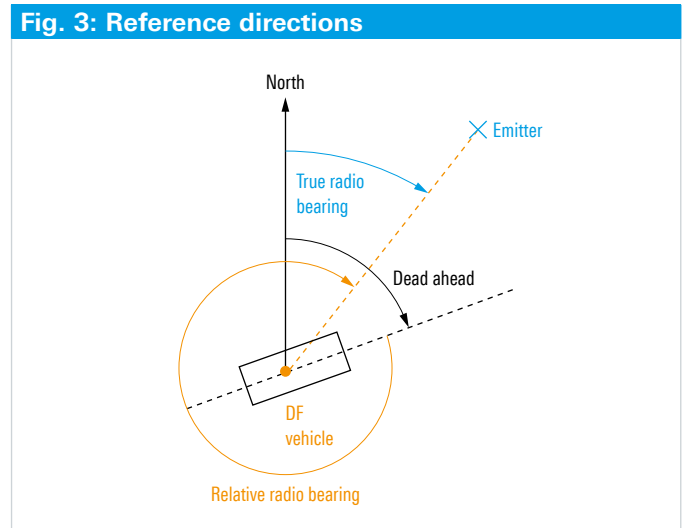
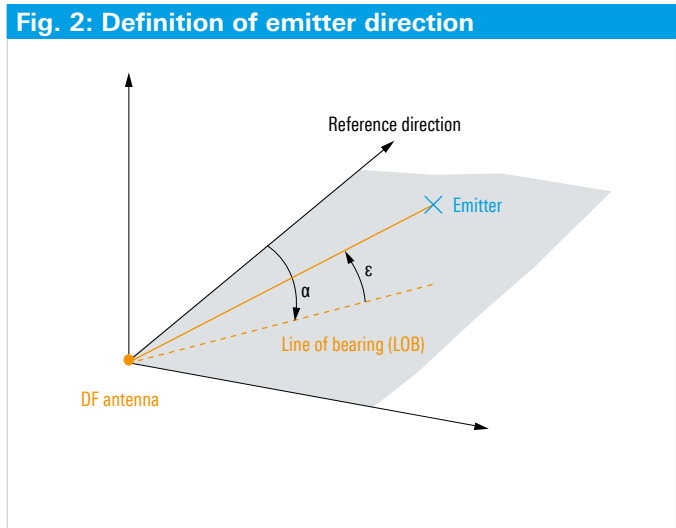

Polarization direction finders are implemented by means of dipole and loop antennas. The classic rotating-loop direction finder also belongs to this category (rotation of loop to minimum of received signal \triangleright direction of incident wave perpendicular to loop). Today, polarization direction finders are used in applications where there is sufficient space only for small antennas, e.g. in vehicles and on board ships for direction finding in the HF band. Evaluation is usually based on the Watson-Watt method (see section "Classic DF methods"). To obtain unambiguous DF results, however, the phase information must be evaluated in addition.

Phase direction finders obtain the direction information (bearing information) from the spatial orientation of lines or surfaces of equal phase. There are two basic methods:

- Direction finding based on directional patterns:
 - With this method, partial waves are coupled out at various points of the antenna system and combined at one point to form a sum signal. The maximum of the sum signal occurs at the antenna angle at which the phase differences between the partial waves are at a minimum. The sum signal is thus always orthogonal to the phase surfaces of the incident wave (maximum-signal direction finding). For minimum-signal direction finding, the partial waves are combined so that the phase differences in the direction of the incident wave become maximal and there is a distinct minimum of the received signal
- Direction finding by aperture sampling:
 - With this method, samples are taken at various points of the field and applied to evaluation circuits sequentially or in parallel. These circuits determine the bearing by linking the samples, which is today mostly done by mathematical operations

Typical examples are interferometers and Doppler direction finders.

The DF methods mentioned so far are suitable only to a limited extent for determining the directions of incidence of several waves that overlap in the frequency domain.

With the progress made in digital signal processing, the methods known from the theory of spectral estimation have been applied to the analysis of wavefront and developed. The term "sensor array processing" describes the

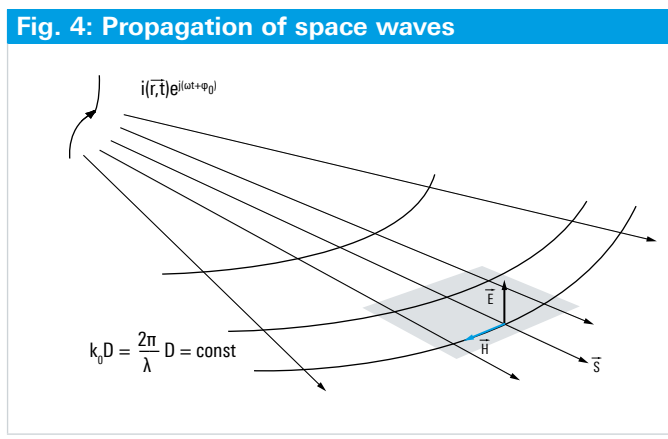

Table 1: DF principles.

Wave characteristic	Transversality	Phase surfaces	Direction of propagation	
DF principle	Polarization direction finder	Phase direction finder		
Examples		Direction finding with directional patterns	Aperture sampling	
	■ Rotating loop	Conversion phase \triangleright amplitude ■ Directional antenna Maximum-signal direction finder Minimum-signal direction finder	Direct evaluation ■ Interferometer	Sensor array processing ■ Correlation direction finder
	■ Dipole	■ Adcock with Watson-Watt evaluation	■ Rotating-field direction finder	■ Adaptive beam former
	■ Loaded loop		■ Doppler direction finder	■ MUSIC
	■ Crossed loop with Watson-Watt evaluation			■ ESPRIT

technique of gaining information about the parameters of incident waves from the signals derived from the elements, or sensors, of a sensor array (antenna array in direction finding, hydrophone array for sonar).

There are basically three different methods:

- ▮ Beamforming methods, e.g. correlation direction finder, spatial Fourier analysis, adaptive antenna
- ▮ Maximum likelihood method as the most general model-based method
- ▮ Subspace methods, e.g. MUSIC, ESPRIT

Main requirements on DF systems

- ▮ High accuracy
- ▮ High sensitivity
- ▮ Sufficient large-signal immunity
- ▮ Immunity to field distortion caused by multipath propagation
- ▮ Immunity to polarization errors
- ▮ Determination of elevation in shortwave range
- ▮ Stable response in case of non-coherent co-channel interferers
- ▮ Short minimum required signal duration
- ▮ Scanning direction finders: high scanning speed and high probability of intercept (POI)

Components of a DF system

A DF system (Fig. 5) consists of the following components:

- ▮ Antenna system
- ▮ DF converter
- ▮ Evaluation unit
- ▮ Display unit

Depending on the configuration, systems for determining the direction finder's own coordinates/orientation (GPS, compass), remote control units (LAN, WAN), antenna control units, etc., can be added.

The achievable DF speed mainly depends on the number H of receive sections, as this parameter determines the number of antenna outputs that can be measured in parallel.

To achieve maximum speed, it must be possible to generate a bearing in a single time step, i.e. from one set of samples (monopulse direction finding). For unambiguous direction finding over the total azimuth range, at least three antenna outputs are required. If there are also three receive sections, multiplexing of the measurement channel is not necessary.

Typical examples of monopulse DF antennas:

- ▮ Multimode antenna for amplitude comparison direction finders, e.g. Adcock antenna
- ▮ Interferometer and rotating-field (phase) direction finder

For high DF accuracy (e.g. 1°) and large bandwidth (e.g. 1 MHz to 30 MHz or 20 MHz to 1000 MHz), five to nine aperture samples are usually required. Since monopulse solutions would then be very complex, one fixed and two sequentially switched receive sections are frequently used.

The DF converter converts the carrier-frequency antenna signals to a fixed IF. Since this conversion must be performed with equal phase and amplitude in all receive sections, the use of a common synthesizer is indispensable. Moreover, with most multipath direction finders, the receive sections are calibrated in order to ensure equal amplitude and phase. Calibration is performed with the aid of a test generator at defined intervals and prior to the actual DF operation.

The evaluation unit determines the bearing from the amplitudes and/or phases of the IF signal.

Classic DF methods

Using directional antennas

Evaluating the receive voltage of a mechanically rotated directional antenna with reference to the direction is the simplest way of direction finding. With this method, the bearing is derived from the characteristic of the receive voltage as a function of the antenna rotation angle: When a wave arrives, the receive voltage yields the directional pattern of the antenna. The pattern position relative to the antenna rotation angle is the measured bearing [1].

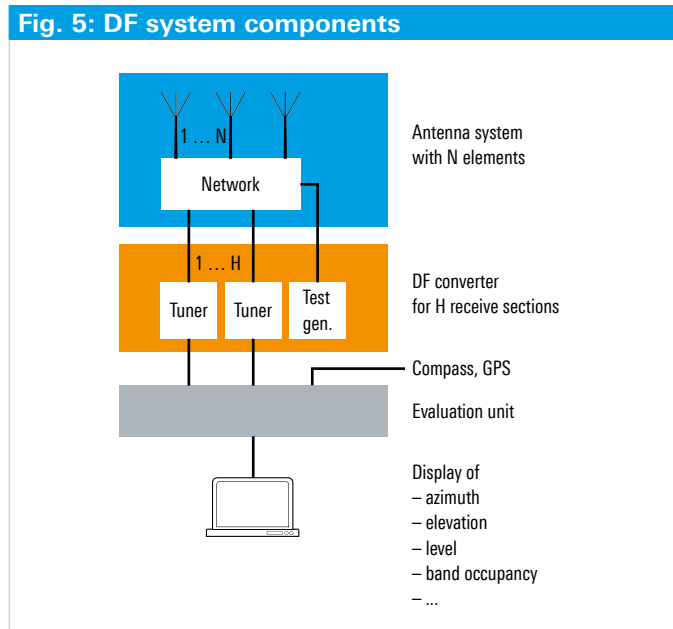

This type of direction finder is a phase direction finder since the directivity of the receive antenna is achieved by superimposing partial waves whose phase differences depend on the angle of incidence. In the simplest case, the antenna is rotated and the bearing determined by the operator. The antenna is rotated until the receiver output voltage assumes an extreme value. The antenna direction thus found is read from a scale, and the bearing is determined from it. If the directional antenna (with maximum or minimum pattern) is permanently rotated with the aid of a motor, and the receive voltage is displayed graphically as a function of the angle of rotation, a rotating direction finder is obtained (Fig. 6). Using suitable automatic evaluation of the receive voltage characteristic, e.g. by means of a maximum detector, a fully automatic direction finder is obtained.

The following benefits are common to all variations of this DF method:

- High sensitivity due to the directivity of the antenna
- Simple and inexpensive implementation (only one receiver required (single-channel principle))
- Resolution of multiwavefronts is possible (prerequisite: different angles of incidence and high-directivity antenna system)
- Same antenna can be used for direction finding and monitoring

The drawbacks of this method result from the restricted angular detection range, which is due to the directivity of the antenna, and the antenna's limited rotating speed, which is mainly due to the use of a mechanical rotator:

- Probability of intercept is reciprocal to directivity
- Method fails in case of short-duration signals, i.e. with signal dwell times that are short compared to a scanning cycle of the antenna

Despite these drawbacks, DF methods using mechanically rotated directional antennas are still in use today since achieving the described advantages with other methods involves in part considerably higher cost and effort. In the microwave range, in particular, the mechanical DF method is often the only justifiable compromise between gain, low noise and expenditure.

If, in addition to a directional pattern with a maximum in the direction of the incident wave, a directional pattern with a minimum is used, a monopulse direction finder is obtained that even with a slowly rotating or fixed antenna delivers bearings as long as waves arrive in the main receiving direction of the antenna. Fig. 7 shows a typical implementation using log-periodic dipole antennas that are connected by means of a 0/180° hybrid. This results in the directional patterns shown below.

The quotient of the difference and the sum signal yields a dimensionless, time-independent function, i.e. the DF function:

$$PF(\alpha) = \frac{V_{\Delta}(\alpha)}{V_{\Sigma}(\alpha)}$$

After forming the quotient of the two test voltages, the DF function immediately delivers the bearing α .

Fig. 6: DF using a directional antenna

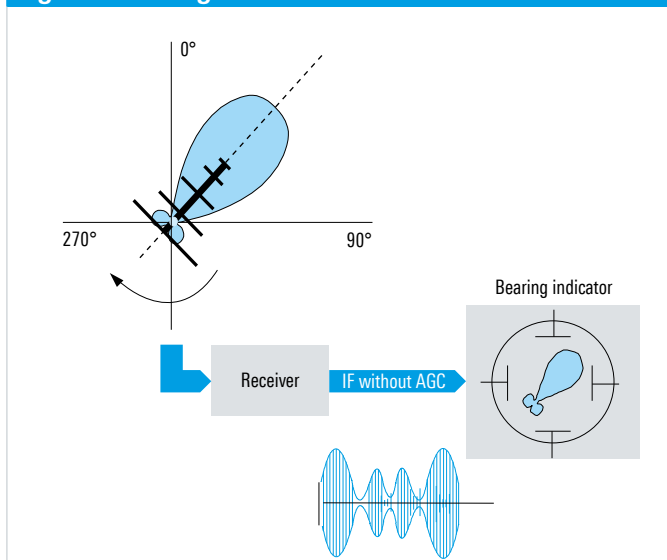
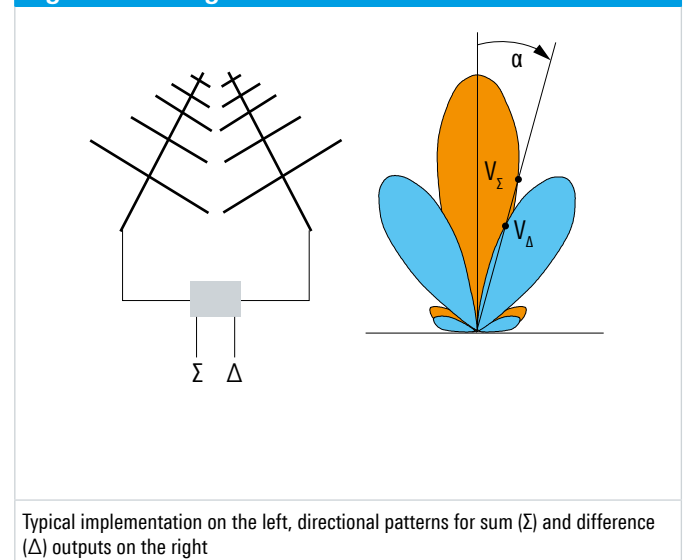

Fig. 7: DF using sum-difference method



Typical implementation on the left, directional patterns for sum (Σ) and difference (Δ) outputs on the right

Watson-Watt principle

If the amplified and filtered signals of a receiving antenna with outputs for a sine-shaped and a cosine-shaped directional pattern are applied to the x and y deflection plates of a cathode-ray tube (CRT), a line Lissajous figure is obtained in the ideal case, whose inclination $\hat{\alpha}$ corresponds to the wave angle but exhibits an ambiguity of 180°. The indicated angle is obtained from the ratio of the two signals as follows:

$$\hat{\alpha} = \arctan \frac{V_x}{V_y}$$

An unambiguous bearing indication is obtained (Fig. 8) if a blanking signal is additionally used in this DF method, which was first implemented by Watson-Watt in 1926. The blanking signal is derived from an omnidirectional receiving antenna with an unambiguous phase relationship.

If there is a phase difference δ between the two voltages V_x and V_y , which may be due to ambient interference (e.g. reflections), the displayed figure is an ellipse. The position of the main axis yields the bearing $\hat{\alpha}$, which is calculated from the two voltages by means of the equation below [9].

$$\hat{\alpha} = \text{Re} \left(\arctan \frac{V_x}{V_y} \right) = \frac{1}{2} \arctan \frac{2|V_x||V_y| \cos \delta}{|V_y|^2 - |V_x|^2}$$

The principal advantage of this method is that the bearing is indicated without delay, which means that it is capable of monopulse direction finding over the entire azimuth range.

Suitable antennas (Fig. 9) with sine-shaped or cosine-shaped directional patterns are in particular the following:

- Loop antennas (or ferrite antennas)
- Adcock antennas (monopole or dipole arrays)

Crossed-loop antennas with Watson-Watt evaluation are mainly suitable for mobile applications due to their compact size. They feature the following benefits and drawbacks:

- Benefits:
 - Extremely short signal duration is sufficient
 - Implementation is simple
 - Minimum space is required
- Drawbacks:
 - Small-aperture system ($D/\lambda < 0.2$) causing errors in case of multipath propagation
 - Large DF errors when receiving sky waves with steep elevation angles

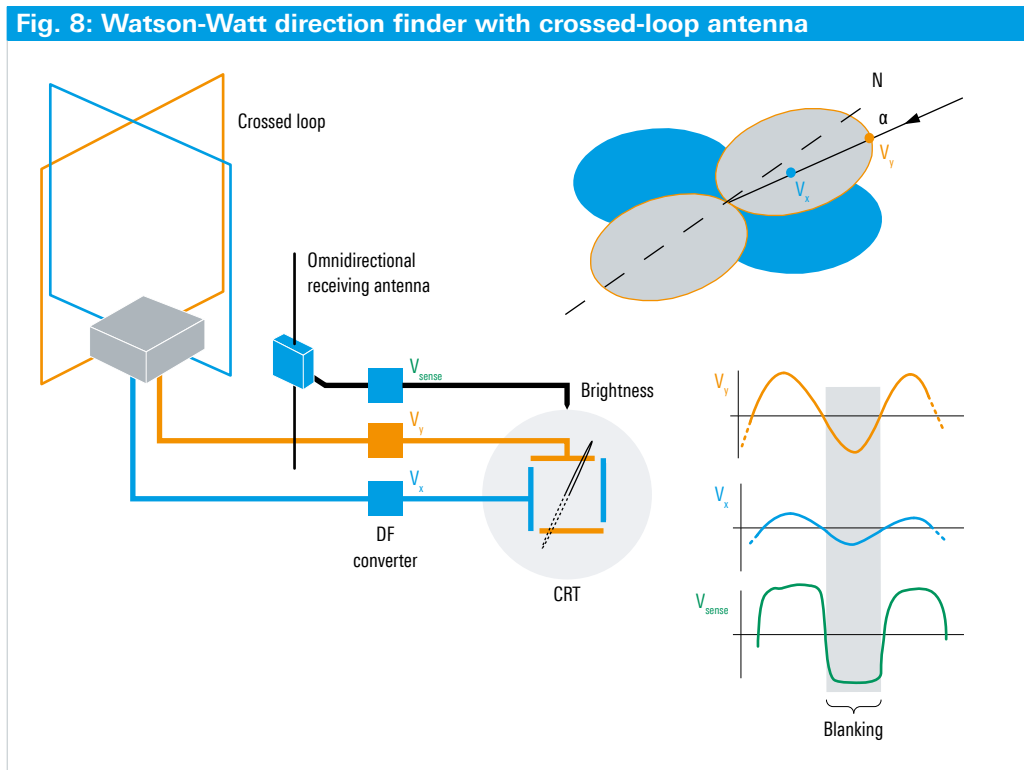

Adcock antennas feature the following advantages over crossed-loop antennas:

- Improved error tolerance for sky wave reception
- Wider apertures can be implemented to reduce errors in case of multipath reception (e.g. $D/\lambda < 1$ for 8-fold Adcock)

Modern direction finders no longer display the IF voltages of antenna signals on a CRT but digitally process the signals after converting them into a relatively wide IF band (Fig. 10).

Selection is mainly effected by means of digital filters; bearings are calculated numerically, e.g. using the last equation above, and displayed on a computer (workstation, PC) with a graphical user interface (GUI).

A number of disadvantages of analog direction finders are avoided, yielding the following effects:

- Synchronous operation of channels also on filter edges
- Simple procedure of taking into account correction values for antenna networks, cables, etc.
- No temperature drift in digital section
- Bearings available as numeric values for evaluation, especially for easy transmission to remote evaluation stations

Doppler direction finder

If an antenna element rotates on a circle with radius R, the received signal with frequency ω_0 is frequency-modulated with the rotational frequency ω_r of the antenna due to the Doppler effect. If the antenna element moves toward the radiation source, the receive frequency increases; if the antenna element moves away from the radiation source, the receive frequency decreases.

From the instantaneous amplitude

$$u(t) = a \cos(\phi(t)) = a \cos\left(\omega_0 t + \frac{2\pi R}{\lambda_0} \cos(\omega_r t - \alpha) + \varphi\right)$$

the instantaneous frequency is derived by differentiation of the phase

$$\omega(t) = \frac{d\phi(t)}{dt} = \omega_0 - \frac{2\pi R}{\lambda_0} \omega_r \sin(\omega_r t - \alpha)$$

After filtering out the DC component ω_0 , the demodulated Doppler signal is obtained as

$$S_D = \frac{2\pi R}{\lambda_0} \omega_r \sin(\omega_r t - \alpha)$$

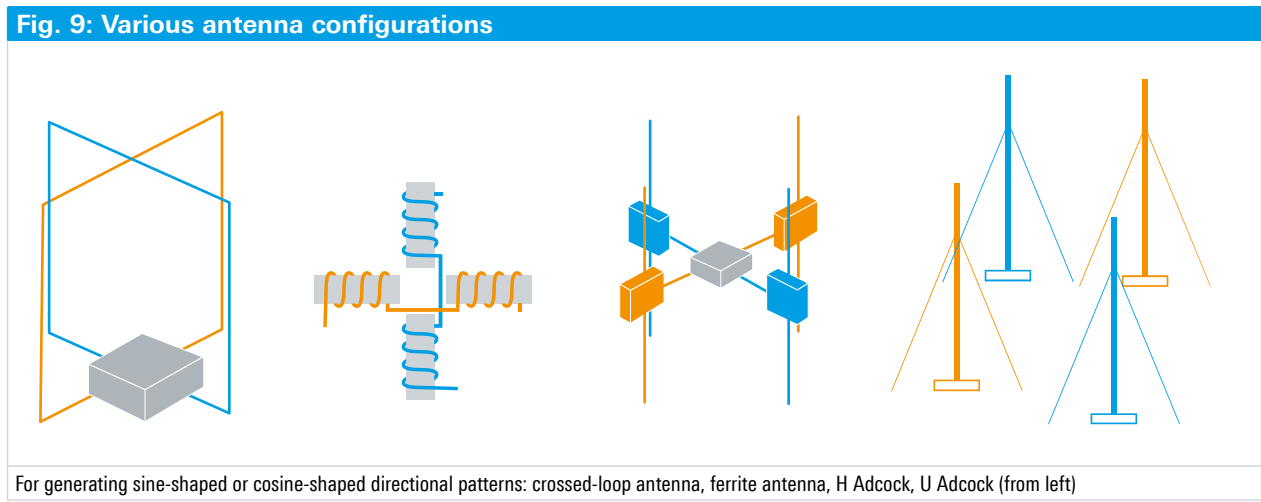
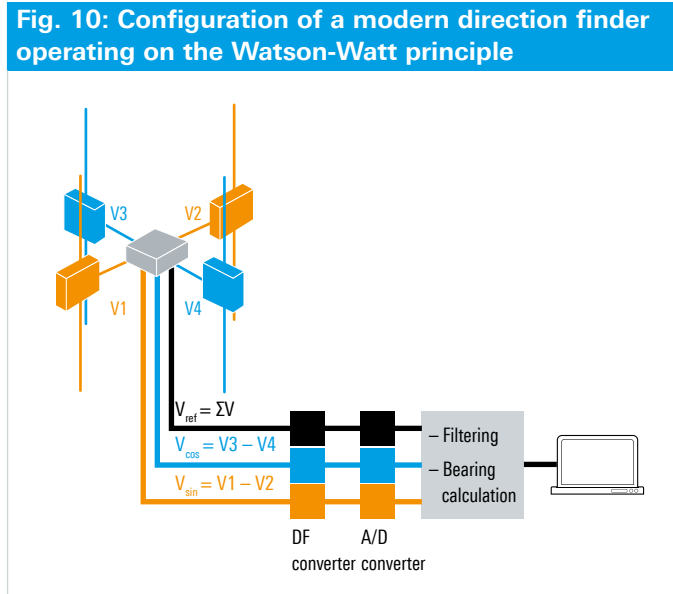

For generating sine-shaped or cosine-shaped directional patterns: crossed-loop antenna, ferrite antenna, H Adcock, U Adcock (from left)

The phase of the demodulated signal is compared with a reference voltage of equal center frequency derived from the antenna rotation

$$S_r = -\sin\omega_r t$$

which yields the bearing α [1].

Since rotating an antenna element mechanically is neither practically possible nor desirable, several elements (dipoles, monopoles, crossed loops) are arranged on a circle (Fig. 11) and electronically sampled by means of diode switches (cyclic scanning).

To obtain unambiguous DF results, the spacing between the individual antenna elements must be less than half the operating wavelength; in practice, a spacing of about one third of the minimum operating wavelength is selected.

If this rule is adhered to, Doppler DF antennas of any size are possible, i.e. wide-aperture systems with the following features can easily be implemented:

- High immunity to multipath reception
- High sensitivity

A drawback of the Doppler method is the amount of time it requires. At least one antenna scanning cycle is required in order to obtain a bearing. At a typical rotational frequency of 170 Hz in the VHF/UHF range, one cycle takes approx. 6 ms.

Interferometer

The interferometer direction finder was first used in radio astronomy [10]. The objective was to increase the resolution power and the sensitivity of the DF system by superimposing the signals of only a few antenna elements that were however spaced many wavelengths apart (Fig. 12).

The ambiguous interference pattern is weighted with the directional pattern of the antenna element, which yields an unambiguous bearing (see Fig.12, diagrams on the right).

Using the minimum of three omnidirectional receiving elements, unambiguous determination of the azimuth and elevation is possible only if the spacing a between the antennas is no greater than half the wavelength. With Φ_1, Φ_2, Φ_3 as the phases measured at the outputs of the antenna elements, the azimuth is calculated as

$$\hat{\alpha} = \arctan \frac{\Phi_2 - \Phi_1}{\Phi_3 - \Phi_1}$$

The elevation angle is obtained as

$$\hat{\varepsilon} = \arccos \frac{\sqrt{(\Phi_2 - \Phi_1)^2 + (\Phi_3 - \Phi_1)^2}}{2\pi a/\lambda}$$

In practice, the three-antenna configuration (Fig. 13) is enhanced by additional antenna elements so that the spacings between the antennas can be optimally adapted to the operating frequency range, and antenna spacings of a $> \lambda/2$ can be used to increase the accuracy of small-aperture DF systems [1]. Frequently used antenna arrangements include the isosceles right triangle and the circular array (Fig. 14).

Triangular configurations are usually restricted to frequencies below 30 MHz. At higher frequencies, circular arrays are preferred for the following reasons:

- They ensure equal radiation coupling between the antenna elements
- They ensure minimum coupling with the antenna mast
- They favor direction-independent characteristics at different positions due to the symmetry around the center point

Fig. 11: Principle of Doppler direction finder

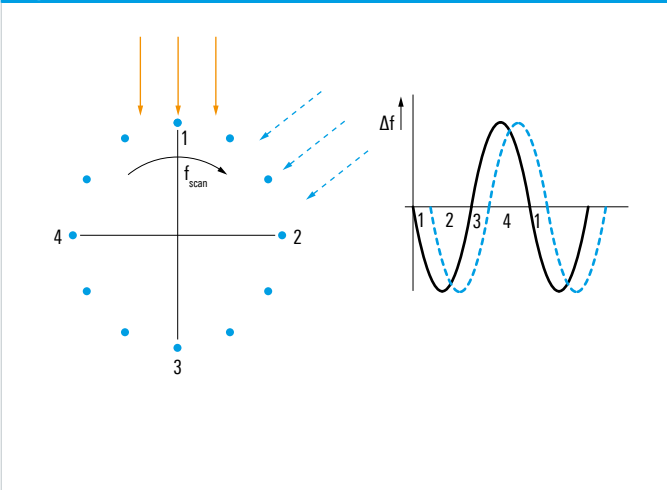
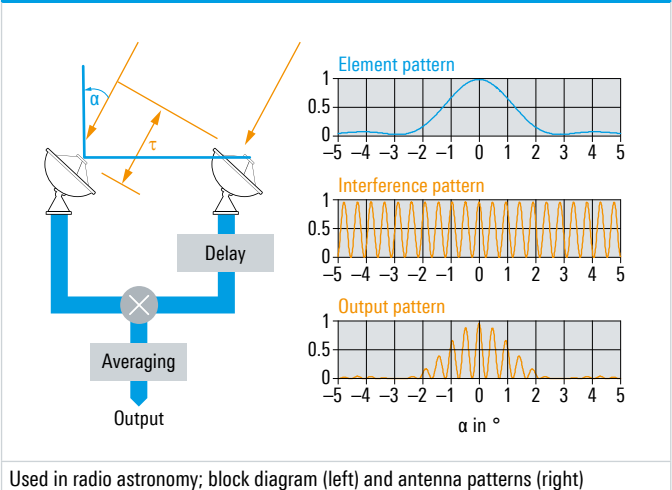

Fig. 12: Classic two-element interferometer



Used in radio astronomy; block diagram (left) and antenna patterns (right)

It is essential to avoid ambiguities, which result from the fact that unambiguous measurement of the phase is possible only in the range of $\pm 180^\circ$. As already mentioned, this condition is met in the case of the three-element (small-aperture) interferometer by limiting the spacing between the elements to half the minimum operating wavelength. With multi-element interferometers, there are the following possibilities:

- Use of "filled" antenna arrays: Phase differences between neighboring elements are always $< 180^\circ$; ambiguities are avoided
- Use of "thinned" antenna arrays: There is a phase difference of $> 180^\circ$ between at least one pair of neighboring elements. Such ambiguities in antenna subarrays are today usually eliminated by subjecting the signals from all elements simultaneously to a pattern comparison by way of correlation \triangleright correlative interferometer

The basic principle of the correlative interferometer consists in comparing the measured phase differences with the phase differences obtained for a DF antenna system of known configuration at a known wave angle. The comparison is performed by calculating the quadratic error or the correlation coefficient of the two data sets. If the comparison is made for different azimuth values of the reference

data set, the bearing is obtained from the data for which the correlation coefficient is at a maximum.

This is demonstrated by the example of a five-element antenna as shown in Fig. 15. Each column of the lower data matrix corresponds to a wave angle α and forms a reference vector. The elements of the reference vectors represent the expected phase differences between the antenna elements for that wave angle. The upper 5×1 data matrix contains the actual measured phase differences (measured vector).

To determine the unknown wave angle (direction of incidence), each column of the reference matrix is correlated with the measured vector by multiplying and adding the vectors element by element. This process results in the correlation function $K(\alpha)$, which reaches its maximum at the point of optimum coincidence of reference vector and measured vector. The angle represented by that specific reference vector is the wanted bearing.

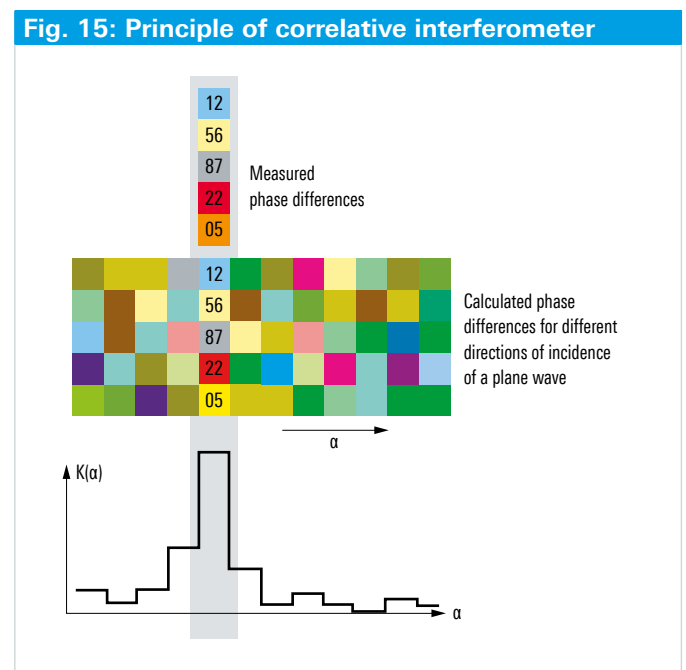
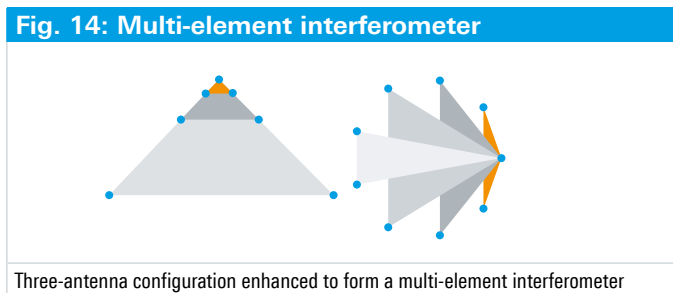
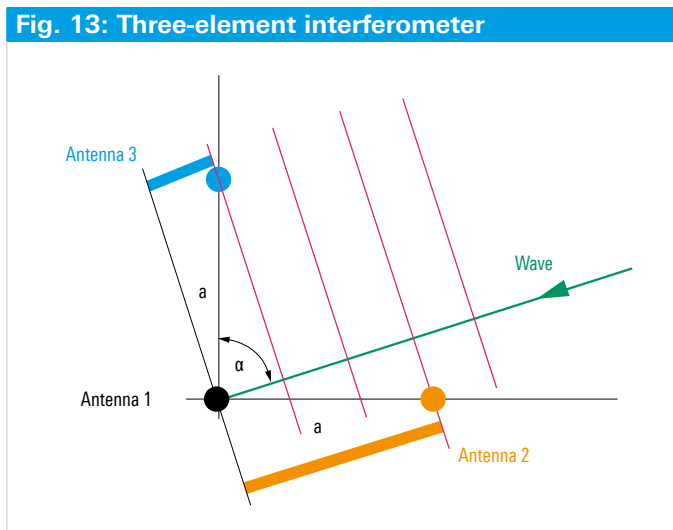

This method constitutes a special form of a beamforming algorithm [11], which will be discussed in greater detail in the following section.

Direction finding using sensor array processing

General

The development of the classic DF methods was aimed at designing antenna configurations that allowed bearings to be determined using a circuit design as simple as possible. It was important to establish a simple mathematical relationship between the antenna signals and the direction of the incident wave largely independent of frequency, polarization and environment.

With the development of digital signal processing, new approaches have become possible:

- With high-speed signal-processing chips now available, the requirement for a simple and frequency-independent relationship between the antenna signals and the bearing no longer applies. Even highly complex mathematical relationships can be evaluated in a reasonably short period of time for determining the bearing, or handled quickly and economically by means of search routines
- Numeric methods allow the separation of several waves arriving from different directions even with limited antenna apertures (high-resolution methods, super-resolution, multiwave resolution)

Basic design

Fig. 16 shows a typical hardware configuration of a DSP-based direction finder [12].

The outputs of the individual antenna elements are usually first taken to a network that contains the following, for instance:

- Test signal inputs
- Multiplexers if the number N of antenna outputs to be measured is higher than the number H of receive sections (tuners and A/D converters) in the direction finder

The signals are then converted to an intermediate frequency that is appropriate for the selected sampling rate of the A/D converters and digitized. To reduce the data volume, the data is digitally downconverted into the baseband. The complex samples $x_i(t)$ ($i = 1, 2, \text{ to } N$) of the baseband signals are filtered for the desired evaluation bandwidth and applied to the bearing calculation section.

Fig. 17 shows a typical implementation including a nine-element circular array antenna and a three-path receiver. The signals of the antenna elements are measured sequentially based on three-element subarrays.

Fig. 16: Typical configuration of a DSP-based direction finder

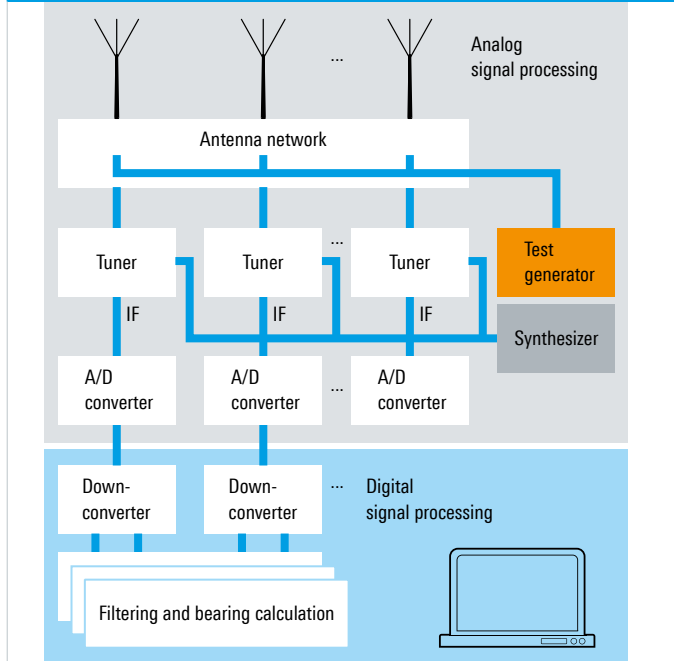

Fig. 17: DSP-based R&S®DDF06A broadband direction finder for the frequency range from 0.3 MHz to 3000 MHz and circular array antenna (R&S®ADD153SR, without cover) for the 20 MHz to 1300 MHz range.

General DF task

For an antenna array of N elements positioned in an unknown wave field, the general DF task (Fig. 18) is to estimate – from the measured data $x_1(t)$, $x_2(t)$, to $x_N(t)$ – the parameters listed below:

- Number M of waves
- Directions of incidence of the waves
- Amplitudes of the waves

Procedure

The task is performed in two steps:

- Determine the relationships between the measured data $x_1(t)$ to $x_N(t)$ and the number, directions and amplitudes of the waves involved
- Develop methods for determining the number, directions, and amplitudes of the main waves involved based on the relationships determined in the first step

Relationship between the measured data and the parameters of the incoming waves

Data model for a single wave

For the sake of simplicity, it is assumed that the emitter and the receiving antennas are located in the same plane, i.e. the elevation angle of the waves can be ignored. It is also assumed that the waves and the antenna elements are vertically polarized.

For the model discussed here, it is assumed that a signal is radiated by an emitter with a carrier frequency of f_0 (wavelength λ_0) and modulated with the function $s(t)$. The wave is considered to be plane in the far field of the emitter and to arrive at an angle α_0 (Fig. 19).

For signal bandwidths that are small in comparison with the reciprocal of the signal delay between the elements spaced at the maximum distance (narrowband approximation), the baseband signal at the output of the i -th sensor can be modeled in accordance with the following equation:

$$\begin{aligned} x_i(t) &= s(t)c_i(\alpha_0)e^{j\frac{2\pi}{\lambda_0}r_i|\cos(\alpha_0-\beta_i)} + n_i(t) \\ &= s(t)a_i(\alpha_0) + n_i(t) \end{aligned}$$

The term $s(t) = r(t)e^{jp(t)}$ describes the waveform and the amplitude of the signal in the form of the complex envelope.

The term $n_i(t)$ describes the inherent noise of the sensor channel.

The term $c_i(\alpha_0)$ describes the characteristic of the antenna element.

The term $e^{j\frac{2\pi}{\lambda_0}r_i|\cos(\alpha_0-\beta_i)}$ describes the phase displacement due to the delay between the reference point O and the position r_i of the i -th antenna element. The phase displacement solely depends on the position of the element (normalized to the wavelength λ_0) and the direction of incidence of the wave.

Fig. 18: General DF task

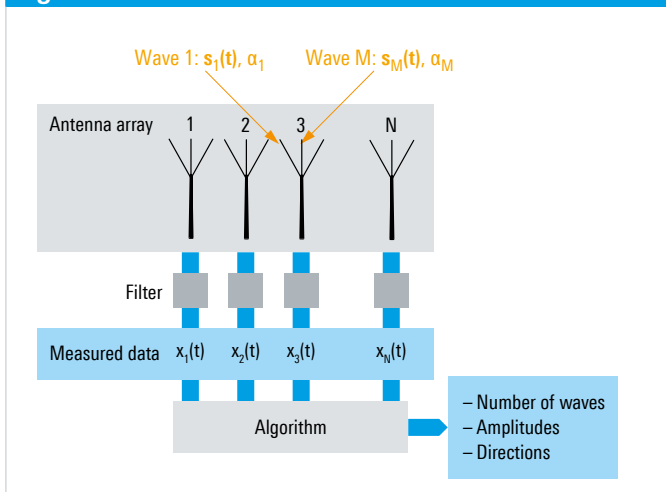
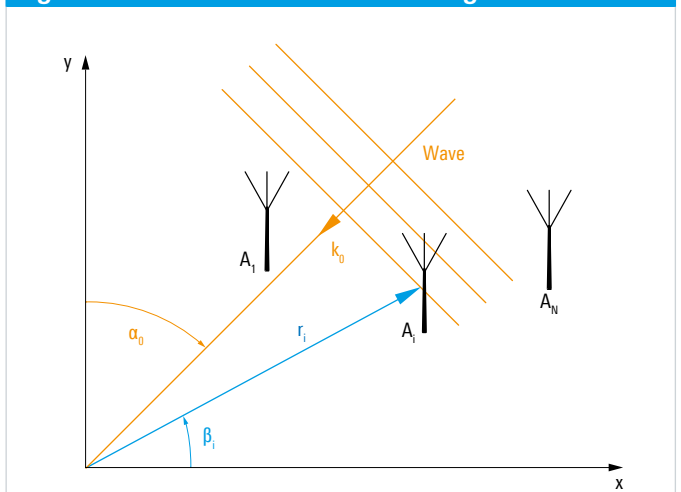

Fig. 19: Characterization of incoming wave field



The antenna- and direction-dependent quantities are then combined in the direction component:

$$a_i(\alpha_0) = c_i(\alpha_0) e^{j \frac{2\pi}{\lambda_0} |r_i| \cos(\alpha_0 - \beta_i)}$$

In the interest of simplified notation and straightforward geometrical interpretation, the signals $x_i(t)$ at the element outputs are assumed to be components of a vector $\mathbf{x}(t)$ in the observation space:

$$\mathbf{x}(t) = s(t)\mathbf{a}(\alpha_0) + \mathbf{n}(t)$$

$$\mathbf{x}(t) = \begin{pmatrix} x_1(t) \\ x_2(t) \\ \dots \\ x_N(t) \end{pmatrix}, \quad \mathbf{n}(t) = \begin{pmatrix} n_1(t) \\ n_2(t) \\ \dots \\ n_N(t) \end{pmatrix}$$

$$\mathbf{a}(\alpha_0) = \begin{pmatrix} e^{j \frac{2\pi}{\lambda_0} |r_1| \cos(\alpha_0 - \beta_1)} \\ e^{j \frac{2\pi}{\lambda_0} |r_2| \cos(\alpha_0 - \beta_2)} \\ \dots \\ e^{j \frac{2\pi}{\lambda_0} |r_N| \cos(\alpha_0 - \beta_N)} \end{pmatrix}$$

$\mathbf{a}(\alpha)$ designates a specific direction α and is referred to as direction vector. The set of all direction vectors forms the array manifold, a parameter that plays a vital role in every aspect of array processing [13].

Characterization of antenna array

If the wave angle α is continuously varied across the range of interest, the tip of the antenna vector $\mathbf{a}(\alpha)$ describes a curve in the N-dimensional space (Fig. 20). The curve is referred to as an array manifold and fully characterizes the antenna for the parameter α , except for any loss or gain factors [13].

It is obtained by measurement or by calculation.

Example: For an ideal crossed-loop antenna ($N = 2$), it is assumed that one element has a sine-shaped and the other a cosine-shaped directional pattern. The array manifold is expressed by the equation

$$\mathbf{a}(\alpha) = \begin{pmatrix} \sin \alpha \\ \cos \alpha \end{pmatrix} \text{ and describes a circle (Fig. 21).}$$

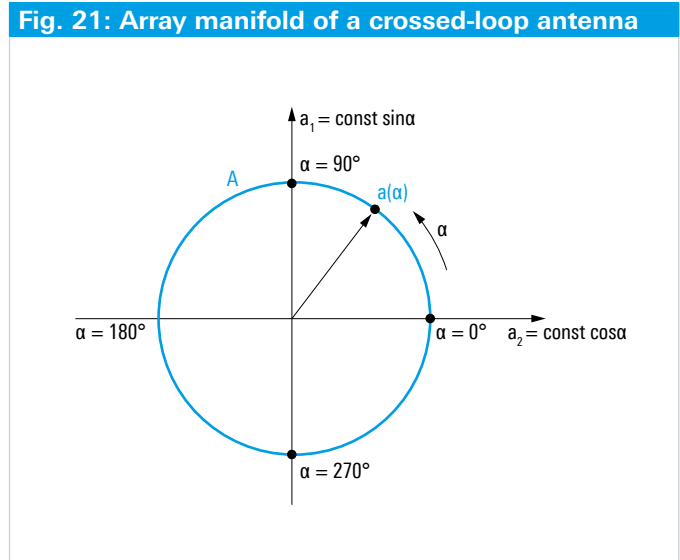
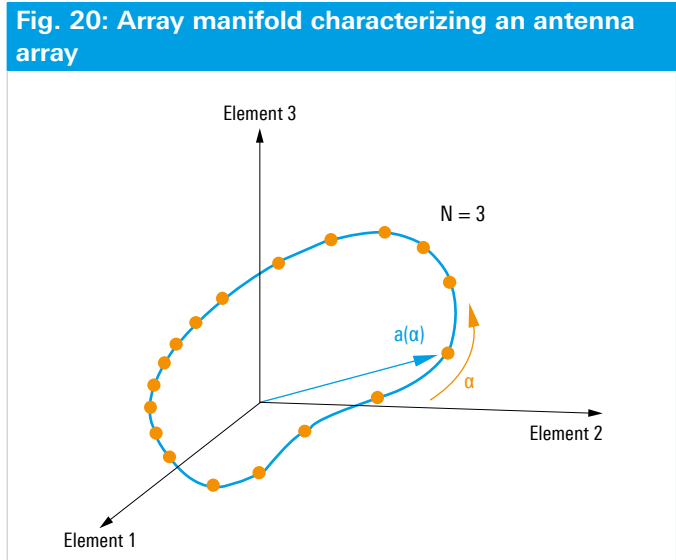

Solution for single-wave model

Assuming there is no noise, i.e. $\mathbf{n}(t) = 0$, the measured vector $\mathbf{x}(t)$ differs from the direction vector $\mathbf{a}(\alpha_0)$ only with respect to length. To solve the DF task, the direction vector has to be found that is parallel to the measured vector. The degree of parallelism can be determined from the direction cosine between the two vectors, which is proportional to the scalar product (Fig. 22).

$$\mathbf{x} \cdot \mathbf{a}(\alpha) = \mathbf{x}^H \mathbf{a}(\alpha)$$

\mathbf{x}^H is the vector whose conjugate has been taken and that has been transposed relative to \mathbf{x} .

Assuming a measured vector with noise superimposed on it, which is the case in practice, \mathbf{x} and $\mathbf{a}(\alpha_0)$ are no longer located on a straight line. The bearing can only be estimated as the best approximation between \mathbf{x} and $\mathbf{a}(\alpha_0)$:

$$\hat{\alpha}_0 = \operatorname{argmax}_{\alpha} |\mathbf{x}^H \mathbf{a}(\alpha)|$$

This approach by estimation corresponds to the beamforming method. Like in conventional antenna arrays, the element signals x_i are multiplied by complex weighting factors $w_i = a_i^*(\alpha)$ and added together (Fig. 23). This yields a sum signal which, corresponding to the resulting directional pattern, depends on the direction of incidence α_0 of the wave and the look direction α . The asterisk (*) in the term above means conjugate complex.

3

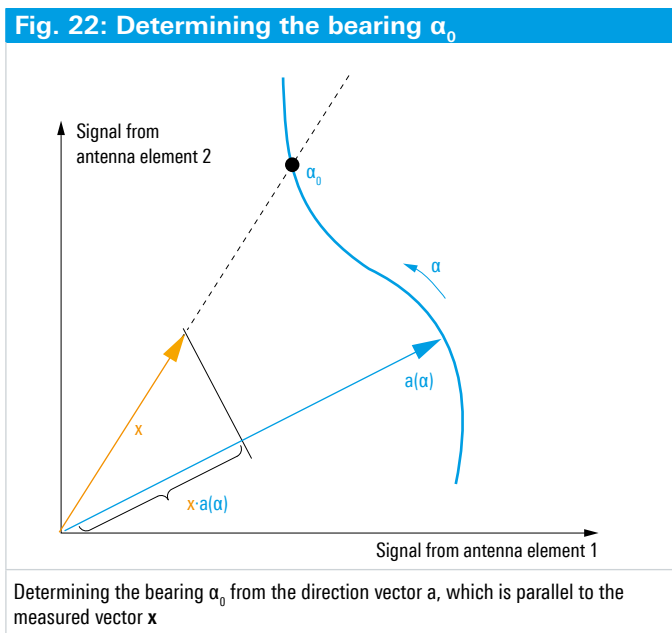

The response of the output signal y to the variation of the weighting factors w_i is used for direction finding same as with a classic rotating or goniometer direction finder. The only difference is that – with numeric generation of the antenna pattern – the DF speed is limited only by the computing power.

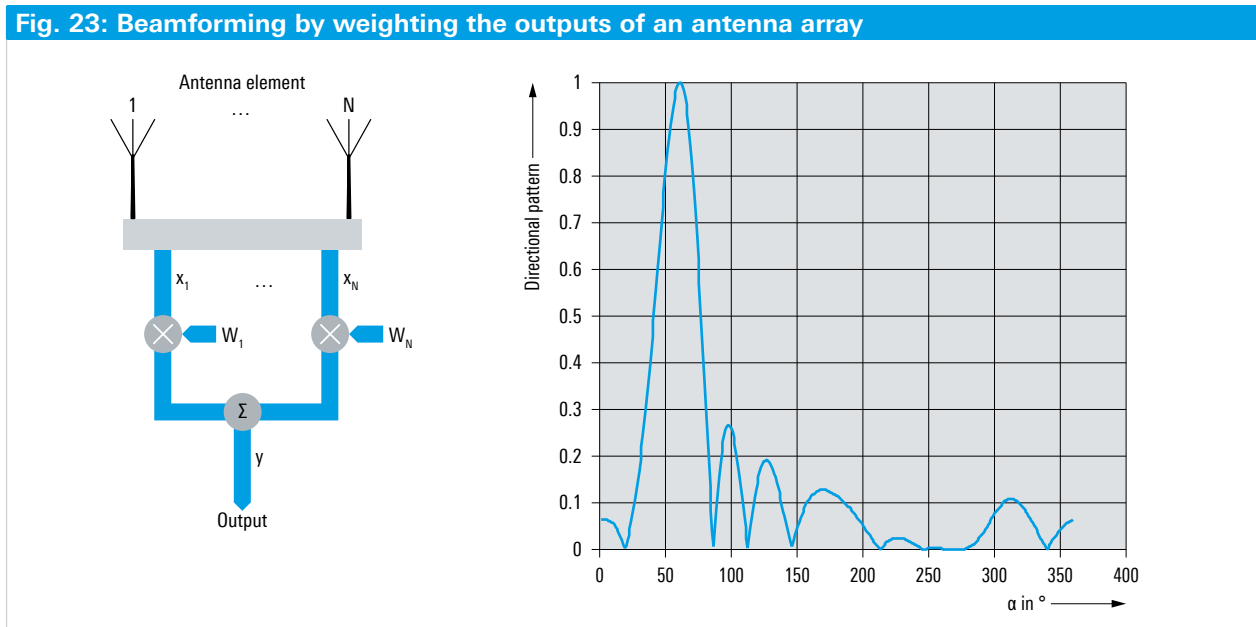

If antenna arrays with largely the same elements and an array geometry that can be described by analytical means are used, the weighting factors can in most cases directly be calculated from the array geometry. If multiport antennas are used (Fig. 24), the variation of the port voltages V_i as a function of the wave angle is as a rule determined by measurements.

Since beamforming using general multiport antennas often does not yield a distinct directivity of the (synthetic) antenna pattern, the following terms are used in this case as well:

- Correlation method
- Vector matching

Multiwave direction finding and super-resolution DF methods

If unwanted waves are received in addition to the wanted wave in the frequency channel of interest, the conventional beamforming method will lead to bearing errors as a function of the antenna geometry. There are two approaches to solve this problem:

- If the power of the unwanted wave component is lower than that of the wanted wave component, the direction finder can be dimensioned to minimize bearing errors, in particular by choosing a sufficiently wide antenna aperture (see [1], chapter on multiwave direction finding)
- If the unwanted wave component is greater than or equal to the wanted wave component, the unwanted waves must also be determined in order to eliminate them. When using conventional beamforming algorithms, this means that the secondary maxima of the DF function must also be evaluated. The limits are reached if either of the following occurs:
 - The ratio between the primary maximum and the secondary maxima of the directional pattern becomes too small
 - The angle difference between the wanted and the unwanted wave is less than the width of the main lobe

By optimizing the weighting factors, the level of the secondary maxima can be lowered, but the width of the main maximum is increased at the same time.

The super-resolution (SR) DF methods are to solve this problem.

Minimum-signal direction finders are considered the grandfathers of the SR direction finders. In the early days of direction finding, bearings of co-channel signals were taken by alternately suppressing the waves by means of a rotating loop [1]. It is worth mentioning that signals can only be separated by audiomonitoring of the modulation, i.e. that correlation with acoustic patterns is required in order to determine the loop null.

Beamforming methods

Adaptive antennas are antenna arrays with beamformers that allow the automatic spatial suppression of unwanted waves [13], [14], [15]. In communications systems, this is done in order to optimize the signal-to-noise ratio; in direction finding, the weighting applied in order to suppress signals is used to determine the directions of incidence of the incoming waves.

The weighting of the beamformer is selected such that the output power is minimized under certain secondary conditions. In the case of the Capon beamformer [16], the secondary condition for setting the weighting is defined such that the antenna gain remains constant for a given direction α_r .

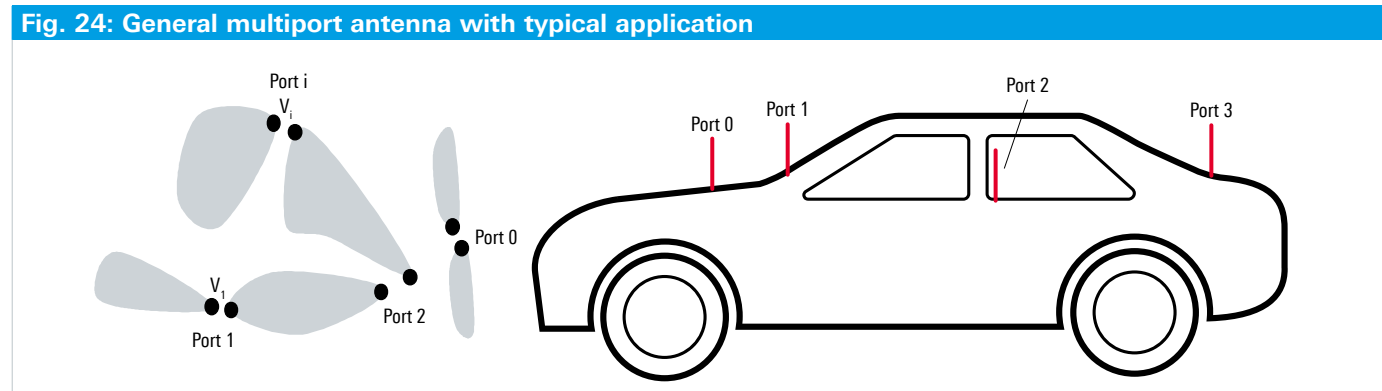

If the incoming waves are uncorrelated, the beamformer is adjusted for nulls to occur in all signal directions except for direction α_r (Fig. 25).

If the direction of an incident wave coincides with the given direction α_r , there is a distinct maximum in the output power. Fig. 26 shows an example of the angular spectrum of a Capon beamformer with a nine-element circular array ($D/\lambda = 1.4$) and five uncorrelated waves.

As with a minimum-signal direction finder, the resolution highly depends on the signal-to-noise ratio.

Fig. 27 shows the same receiving scenario with noise increased by a factor of 10. The resolution of waves arriving at angles of 5° and 10° is no longer possible.

Subspace methods

Subspace methods are intended as a means of eliminating the effect of noise. The N-dimensional space opened up by the element outputs is split up into subspaces. The common MUSIC (multiple signal classification) algorithm makes use of the fact that signals lie perpendicular to the noise subspace. If the direction vectors are projected to the noise subspace, nulls that are independent of the noise level are obtained if signals are present [13], [17]. The reciprocal value is normally used as the DF function, so that distinct peaks occur at the directions of incidence of the signals (Fig. 28 on next page).

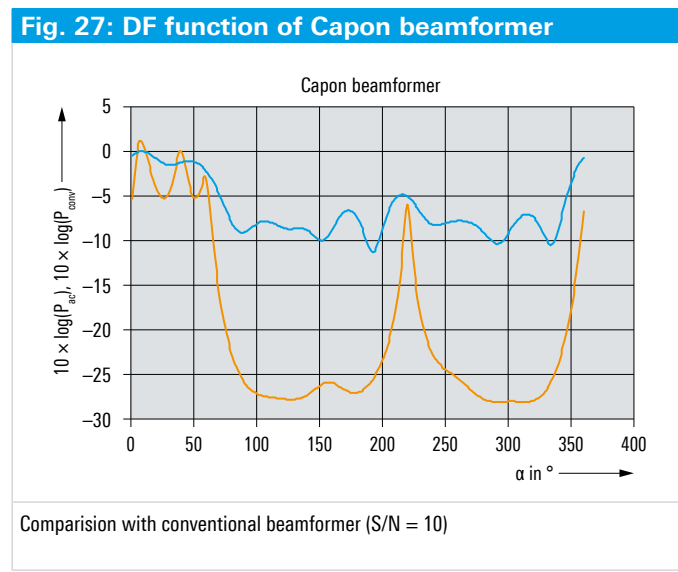
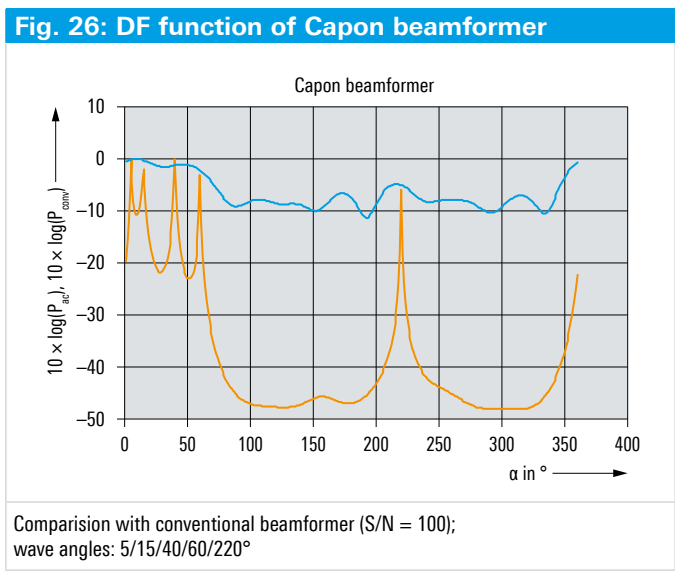
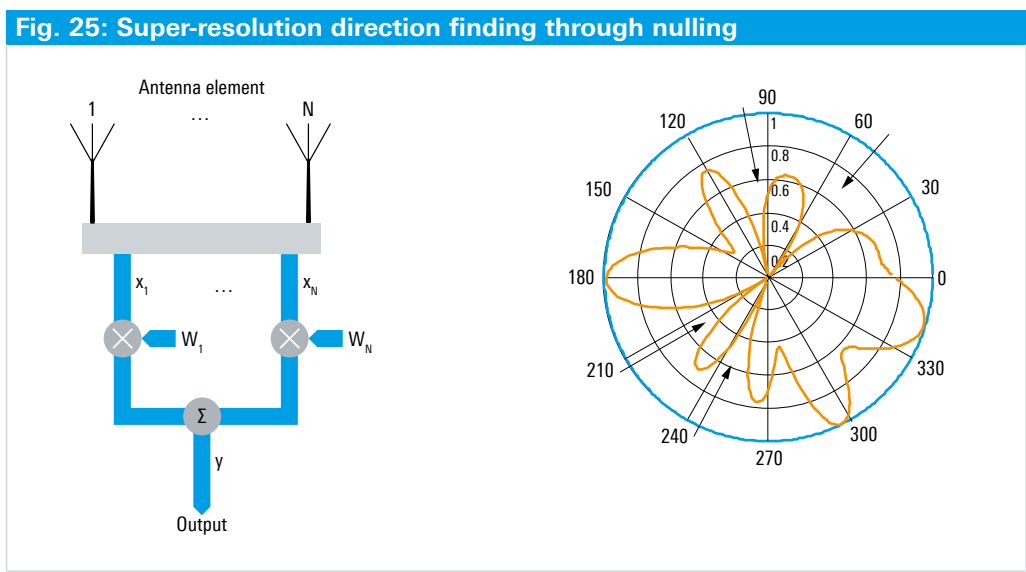

Display of bearings

Operators of direction finders rely heavily on the display of DF results, which can generally be divided into two categories:

- ▮ Results from a direction finder operating at a single frequency channel
- ▮ Results from a multichannel direction finder

Single-channel direction finders

If a bearing is to be taken of a single frequency channel, the following parameters are usually displayed:

- ▮ Bearing as a numeric value
- ▮ Azimuth as a polar diagram
- ▮ Elevation as a bargraph or a polar diagram (combined with azimuth display)
- ▮ DF quality
- ▮ Level
- ▮ Bearing histogram
- ▮ Bearings versus time (waterfall)

Fig. 29 shows a choice of possible displays.

In addition to the usual receiver settings such as frequency and bandwidth, the following parameters are set and displayed on direction finders:

- ▮ Averaging mode (If the signal level drops below the preset threshold, averaging is stopped and either continued or restarted the next time the threshold is exceeded, depending on the averaging mode.)
- ▮ Averaging time
- ▮ Output mode
 - Refresh rate of display
 - Output of results as a function of the signal threshold being exceeded

Fig. 28: DF function with MUSIC algorithm (S/N = 10)

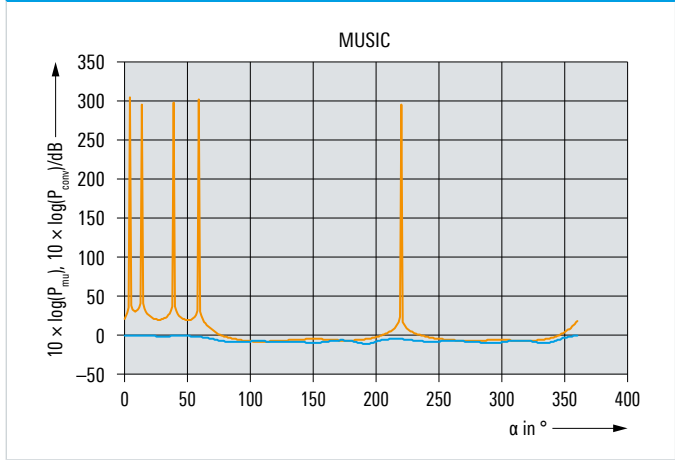
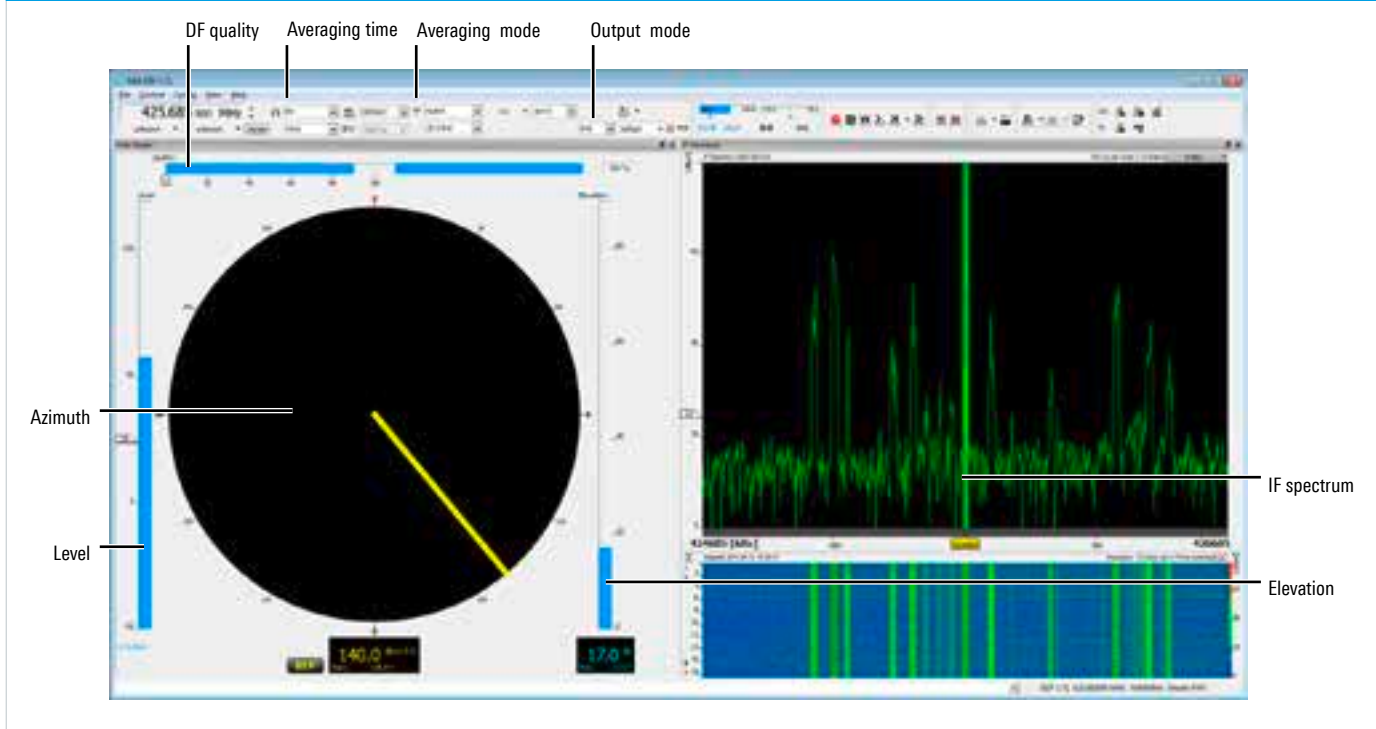

Fig. 29: Bearing display with single-channel direction finding



Multichannel direction finders

Multichannel direction finders are implemented by means of digital filter banks (FFT and polyphase filters). Depending on the configuration level, this enables quasi-parallel direction finding in a frequency range from a few 100 kHz up to a few 10 MHz. Larger frequency ranges can be covered by direction finding in the scan mode (Fig. 30).

With multichannel direction finders, it is essential that the individual events can be quickly recognized and activities taking place on different channels correctly assigned. Therefore, the following display modes are usually provided:

- Bearings versus frequency
- Bearings versus frequency and time (e.g. by displaying the bearings in different colors)
- Level versus frequency (power spectrum)
- Level versus time and frequency (e.g. by displaying the level values in different colors)
- Histograms

Fig. 30: Multichannel direction finder

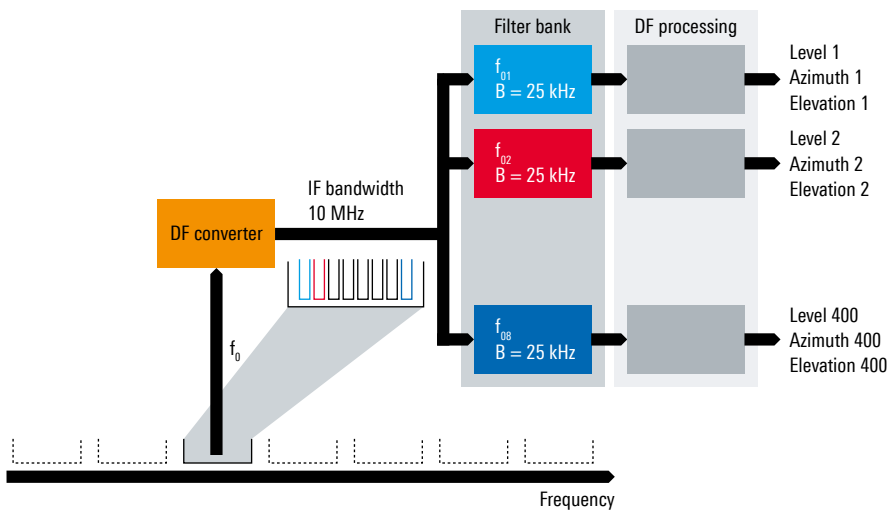
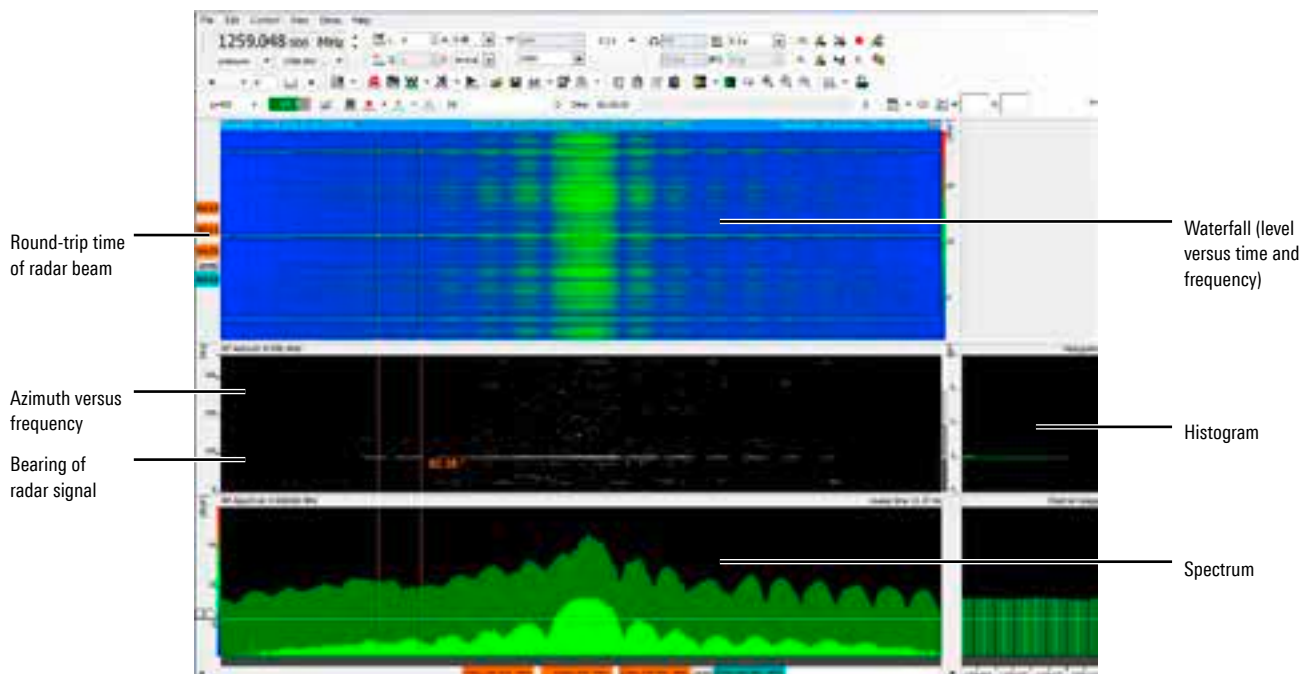

Fig. 31: Multichannel (wideband) display



Processing of bearings

Position finding

Bearings can be used in various ways to estimate the position of an emitter of interest, depending on the degree of sophistication of the DF system and the achievable accuracy. Maximum accuracy is attained if several direction finders are employed to determine the emitter position by way of triangulation [1]. If more than two bearings are used for position finding, an ambiguous result is usually obtained (Fig. 32).

The most probable position can be calculated in a variety of ways. For example, the position can be determined by minimizing the error squares or by maximum likelihood estimation.

If a moving direction finder takes several bearings of an emitter, the emitter position can be determined by a running fix (Fig. 33). The emitter may move only slightly rela-

tive to the DF platform and must be active long enough to fix its position.

Emitters operating in the shortwave range can be located by means of a single direction finder under certain conditions. The direction finder must be able to measure azimuth and elevation, and the virtual height of the reflecting ionosphere layer must be known (Fig. 34).

Emitter preclassification

Bearings are vital characteristics of a detected signal. They facilitate quick segmentation, i.e. the assignment of sub-spectra to the overall spectrum of an emitter. This makes it possible to determine the center frequency and the bandwidth of an emission, which allows its automatic transfer to a hand-off receiver for analysis. Cluster analysis of bearings makes it possible to separate the signals of emitters operating in overlapping spectra, especially those of frequency hoppers.

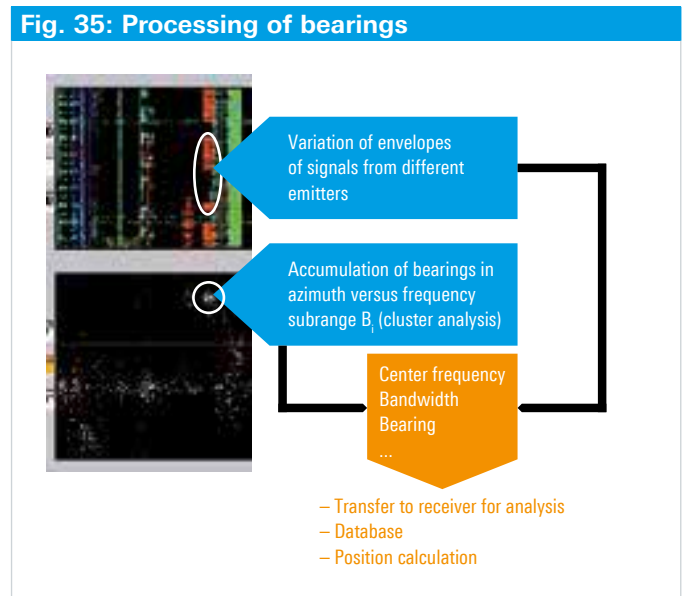
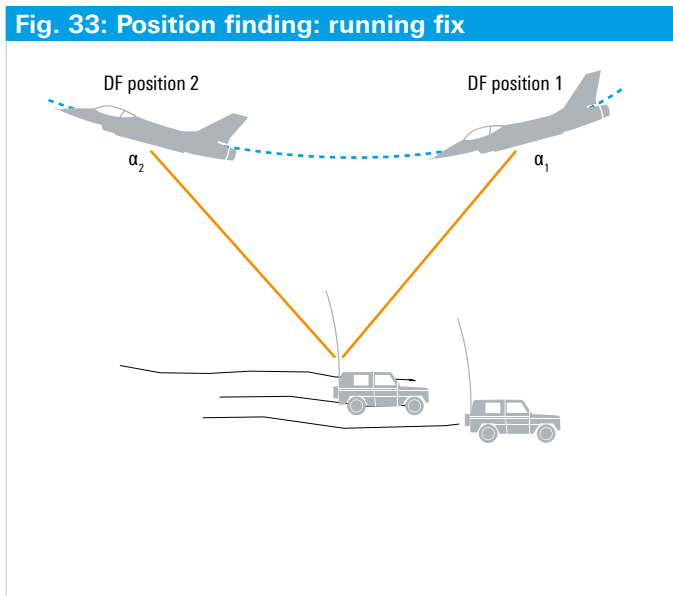
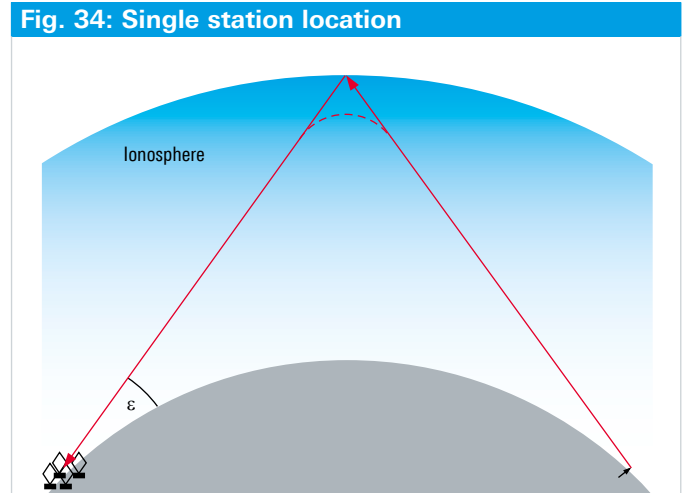
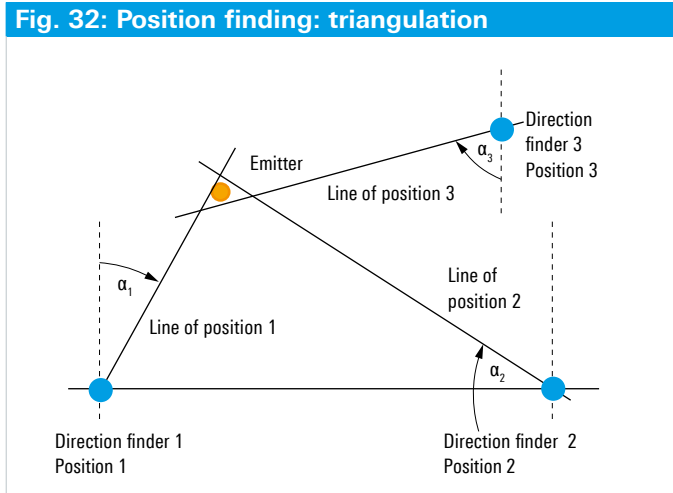

DF accuracy

DF accuracy is affected by a number of factors:

- ▮ Wave propagation is usually disturbed by obstacles
- ▮ Signals radiated by emitters
 - are modulated
 - are limited in time
 - frequently operate at unknown carrier frequencies
- ▮ The following are superimposed on the reception field:
 - noise
 - co-channel interferers
- ▮ Noise and tolerances in the DF system

Noise

In addition to intermodulation distortion, interference caused by noise has a limiting effect on the sensitivity of a DF system.

Sensitivity is understood to be the field strength at which the bearing fluctuation remains below a certain standard deviation.

Noise may occur in the following form:

- ▮ External noise (atmospheric, galactic, industrial noise)
- ▮ System-inherent noise (antenna amplifiers, DF converters, A/D converters)

The following basic considerations apply to system-inherent noise.

Uncorrelated noise in the receive sections (Fig. 36) causes statistically independent variations of the measured signals as a function of the S/N ratio. The variations become noticeable as bearing fluctuations.

The bearing fluctuation of general antenna arrays can be determined by comparing the variation of the measured vector \mathbf{x} with the corresponding variation of α on the curve $\mathbf{a}(\alpha)$. Fig. 37 shows this relationship for a two-element array. The “faster” the antenna vector “moves”, the smaller the effect of the variation of the measured vector on the variation of α [17].

The relationship between the minimum bearing fluctuation and the signal-to-noise ratio for a given antenna geometry (expressed by $\mathbf{a}(\alpha)$) is determined by the Cramer-Rao bound (CRB) [13].

For a general antenna array at whose outputs K samples are taken, the variance σ^2 of the bearing fluctuation is therefore defined by the following equation:

$$\sigma^2 \geq \sigma_{CRB}^2 = \frac{1}{2KSNR^2} \frac{1 + 2SNR \mathbf{a}^H \mathbf{a}}{\mathbf{a}^H \mathbf{a}} \left[\frac{\partial \mathbf{a}}{\partial \alpha} \left(1 - \frac{\mathbf{a} \mathbf{a}^H}{\mathbf{a}^H \mathbf{a}} \right) \frac{\partial \mathbf{a}}{\partial \alpha} \right]^{-1}$$

The equation simplifies if omnidirectional receiving elements are used and the antenna array is of conjugate symmetrical design:

$$\sigma_{CRB}^2 = \frac{1}{2KNSNR^2} (1 + NSNR) \left\| \frac{\partial \mathbf{a}}{\partial \alpha} \right\|^2.$$

For the important case of a circular array with diameter D and N omnidirectional receiving elements ($N > 2$), the following applies at a constant elevation angle ϵ :

$$\sigma_{CRB_UCA}^2 = \frac{\lambda^2}{\pi^2 K D^2 \cos^2 \epsilon} \left(\frac{1}{NSNR} + \frac{1}{N^2 SNR^2} \right).$$

Fig. 38 shows the typical effect of the antenna diameter, the wavelength and the number of elements of a circular array on the S/N ratio that is required for a specific bearing fluctuation.

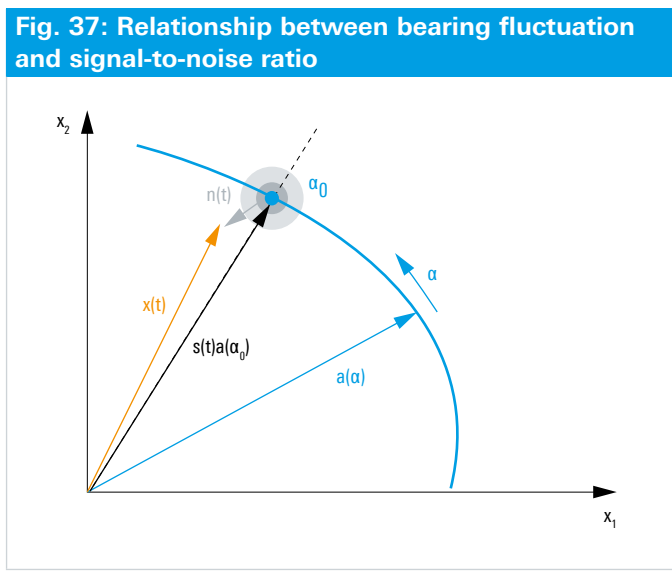
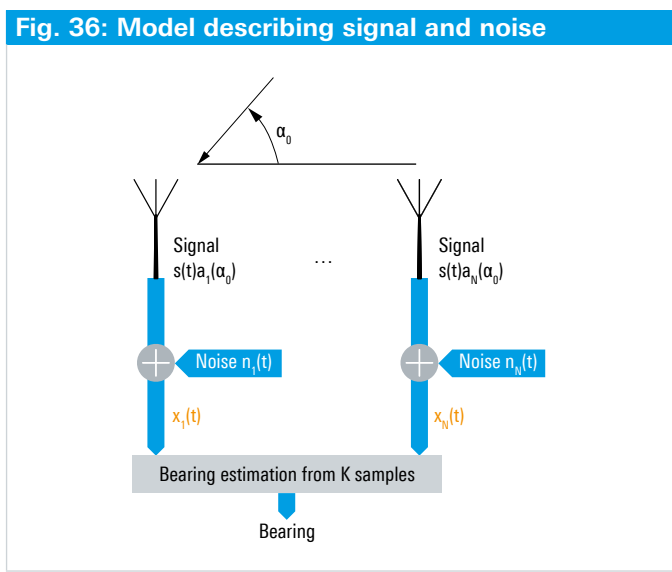

If direction finding is based solely on amplitude evaluation, as is the case with the Watson-Watt method, the Cramer-Rao bound is determined by:

$$\sigma_{\text{CRB_WW}}^2 = \frac{1}{2K} \left(\frac{1}{\text{SNR}} + \frac{1}{2\text{SNR}^2} \right)$$

The effect of the S/N ratio on the bearing fluctuation is particularly obvious in the case of a narrowband two-element interferometer. In narrowband systems, the noise voltage becomes approximately sine-shaped with slowly varying amplitude and phase so that, assuming large S/N ratios, the following applies to the phase variation [19]:

$$\sigma_{\phi}^2 = \frac{1}{2\text{SNR}}$$

Given a sufficiently long observation time, the phase variation can be reduced by way of averaging. If the data used for averaging is uncorrelated, averaging over K samples improves the phase variation as follows:

$$\sigma_{\phi\text{av}}^2 = \frac{\sigma_{\phi}^2}{K}$$

By mapping the phase variation to virtual variations of the positions of the DF antennas (Fig. 39), the bearing standard deviation is as follows:

$$\sigma \cong \frac{\lambda}{2\pi D \sqrt{\text{SNR} K}}$$

This corresponds to the equation for $\sigma_{\text{CRB_UCA}}^2$ mentioned above up to a factor of $\frac{1}{\sqrt{2}}$, if the term

$$\frac{1}{N^2 \text{SNR}^2}$$

which can be ignored for large S/N ratios, is removed and ϵ is set equal to 0.

The above relationship clearly shows how important it is that the relative antenna basis D/λ is as large as possible.

Limitation of upper operating frequency because of ambiguity

The required S/N ratio decreases as the frequency increases, because the length of the array manifold $\mathbf{a}(\alpha)$ also increases. With a constant number N of antenna elements (= dimension of the observation space), however, various sections of the curve $\mathbf{a}(\alpha)$ approach each other (Fig. 40 on next page). At the same time, the probability of measured vectors being positioned on such curve sections increases. This leads to large bearing errors [17].

The problem can be solved by increasing the number of elements N: The increase in dimension of the observation space will accommodate the extended length of the array manifold.

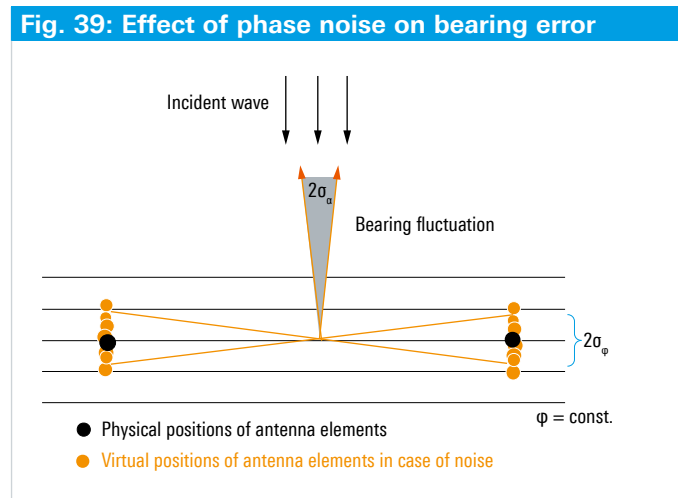
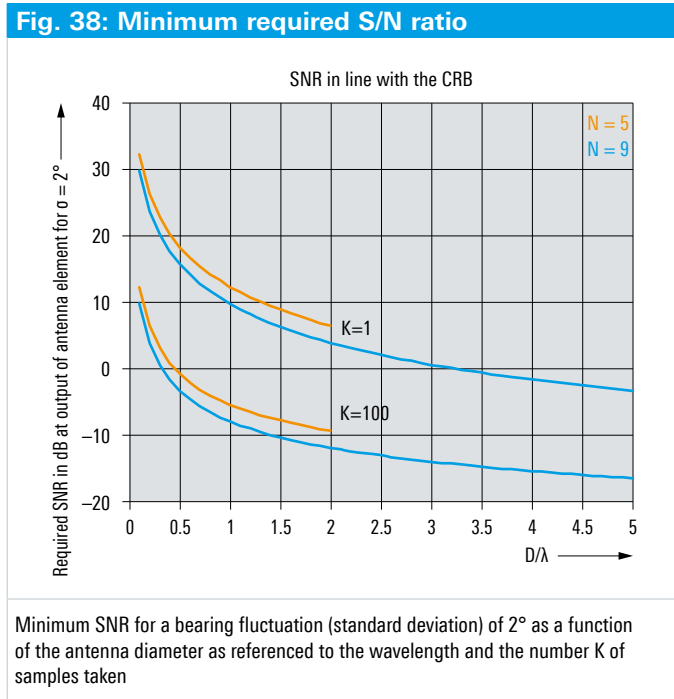

Measurement errors

Different gain and phase responses in the receive sections cause bearing errors that increase as the antenna aperture decreases relative to the wavelength. Fig. 41 shows this effect for a two-element interferometer.

Prior to the DF operation, the receive sections of most multipath direction finders are calibrated for synchronization by means of a test generator. The magnitude and phase responses are measured, and the level and phase differences are stored. In DF operation, the measured values are corrected by the stored difference values before the bearing is calculated.

As regards the frequency response of the filters, synchronization must be ensured not only in the middle of the filter passband but also at the band limits. Digital filters have the decisive advantage that they can be implemented with absolutely identical transmission characteristics.

Multiwave-related problems

As already mentioned, the simple case of a plane wave hardly ever occurs in practice. In a real environment, other waves usually have to be taken into account:

- Waves from other emitters operating on the same frequency channel ▷ incoherent interference
- Secondary waves (caused by reflection, refraction, diffraction – see Fig. 42) ▷ coherent co-channel interference (prerequisite: detours are small relative to the coherence lengths determined by bandwidth B)

In practice, a large number of waves is involved [20]. Fig. 43 shows a typical azimuth distribution of waves generated by a mobile emitter in a built-up area. The direct wave component with amplitude 1 arrives at an angle of 90°.

3

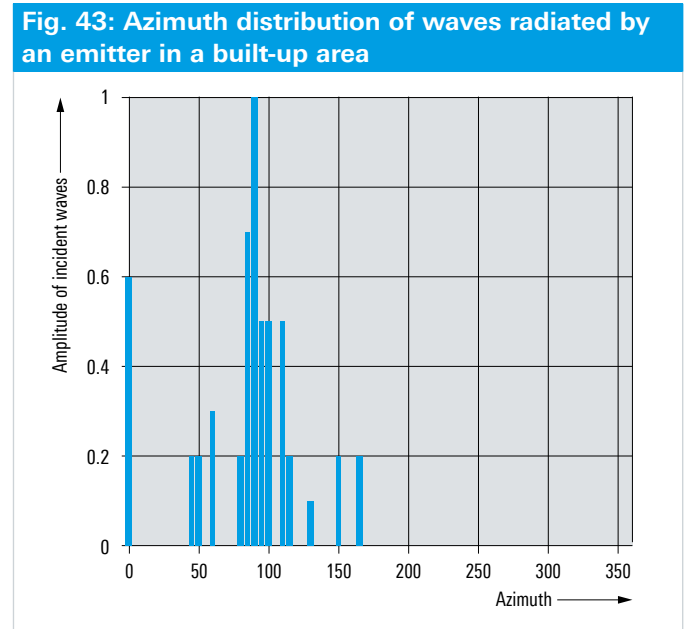
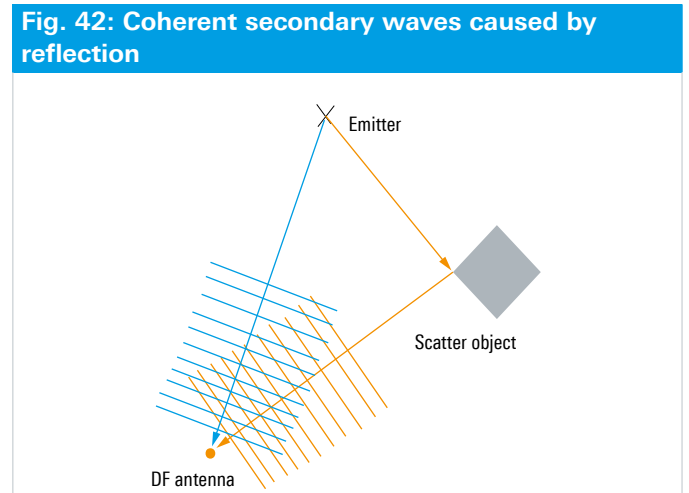
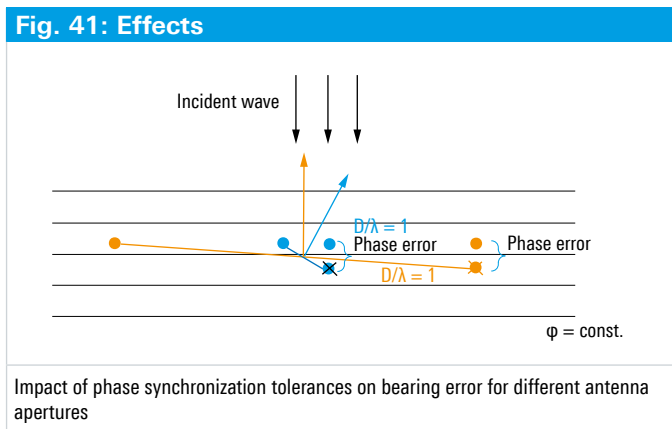
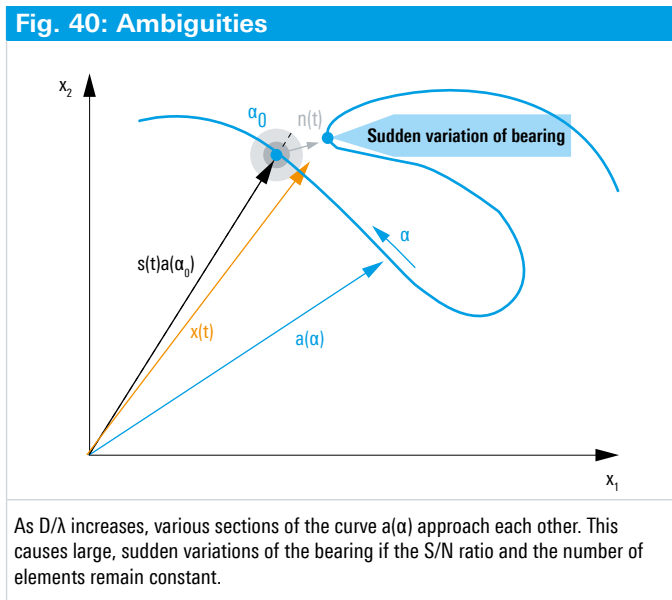

Fig. 44 shows the resulting wavefront as a contour plot for the amplitude and phase [12].

If the majority of waves arrives from the direction of the emitter, the bearing error can be sufficiently reduced by increasing the aperture of the antenna system. This effect is shown by Fig. 45 for an interferometer direction finder. The pattern of the isophase curves in Fig. 44 shows that two measures are required in order to increase the DF accuracy:

- The antenna aperture should be as wide as possible
- The number of antenna elements should be significantly higher than with interference-free reception

Fig. 46 shows the positive effect of a wide antenna aperture on the DF accuracy for a two-element interferometer. Arranging the antenna elements at a spacing that is large relative to the operating wavelength will prevent bearings from being obtained at points where the isophase curves strongly bend.

The effect of the number of antenna elements is obvious when looking at the density of the isophase curves. To avoid 180° ambiguities in areas of high density, the spacing between the antenna elements should be smaller in these areas than with interference-free reception. This requires a higher number of antenna elements.

Fig. 46 shows the effect of the antenna size and the number of antenna elements on the bearing error for two circular antennas in a two-wave field with an amplitude ratio of 0.3 of the reflected wave to the direct wave. The nine-element antenna delivers increasingly more accurate bearings up to a diameter of five wavelengths, whereas the bearings obtained with the five-element antenna become unstable already from a diameter of 1.6 wavelengths.

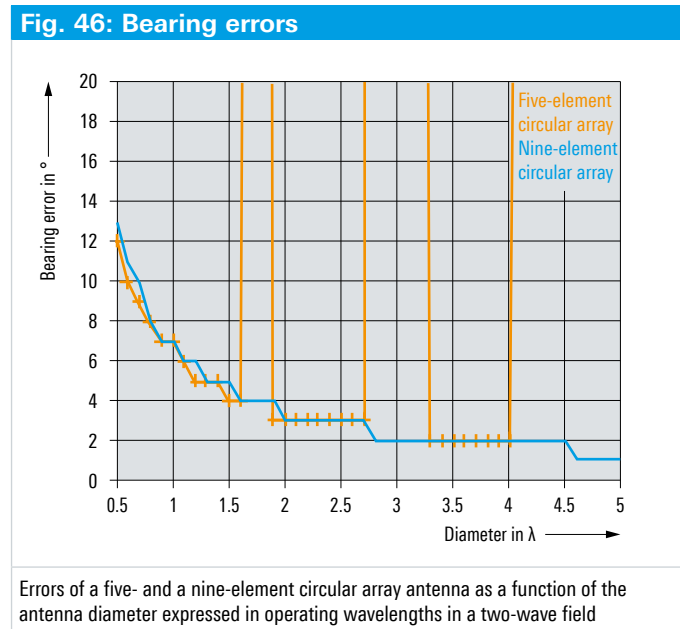
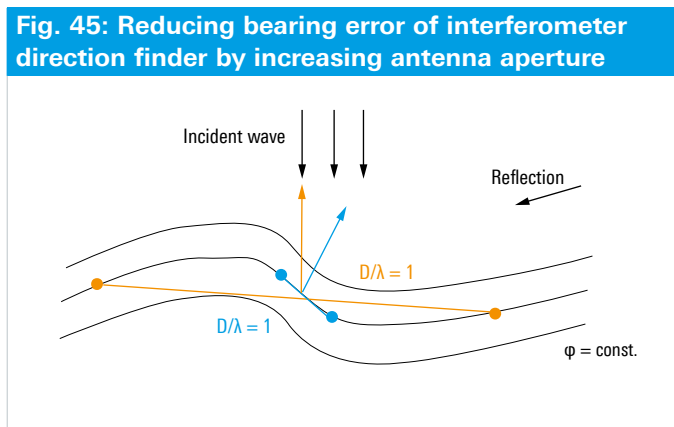
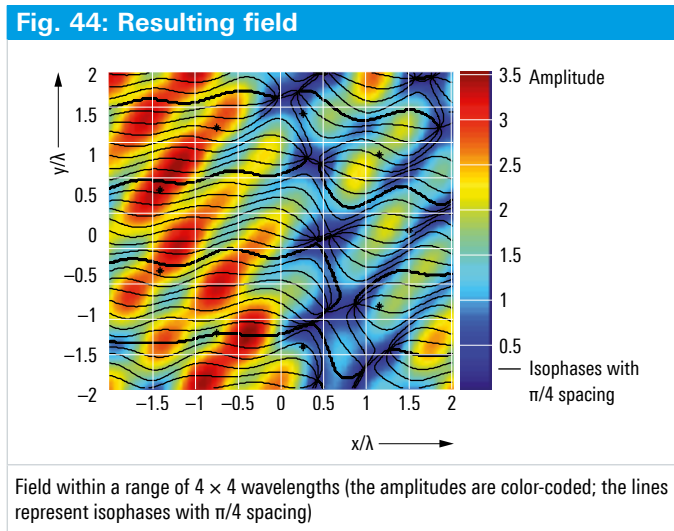

References	
Reference No.	Description
[1]	Grabau, R., Pfaff, K.: Funkpeiltechnik. Franckh'sche Verlagshandlung, Stuttgart 1989.
[2]	Godara, L. C.: Application of Antenna Arrays to Mobile Communication, Part I, Proceedings of the IEEE, Vol. 85, No. 7, July 1997. Part II, No. 8, Aug. 1997.
[3]	Eckart, G.: Über den Rahmeneffekt eines aus vertikalen Linearantennen bestehenden Adcock-Peilers. Sonderdruck 9 aus den Berichten der Bayerischen Akademie der Wissenschaften 1972.
[4]	Baur, K.: Der Wellenanalysator. Frequenz, Bd. 14, 1960, Nr. 2, S. 41-46.
[5]	Jondral, F.: Funksignalanalyse. Teubner, Stuttgart 1991.
[6]	DIN 13312 Navigation, Begriffe.
[7]	Harrington, R. F.: Time-Harmonic Electromagnetic Fields. McGraw-Hill Book, New York, 1961.
[8]	Balanis, C.A.: Antenna Theory. Harper & Row, New York, 1982.
[9]	Mönich, G.: Antennenspannungen und Peilanzeige bei Sichtpeilern nach dem Watson-Watt-Prinzip. Frequenz 35 (1981) Nr. 12.
[10]	Burke, B.F., Graham-Smith, F.: Introduction to Radio Astronomy. Cambridge University Press, Second Edition 2002.
[11]	Demmel, F.: Einsatz von Kreisgruppen zur echtzeitfähigen Richtungsschätzung im Mobilfunkkanal. ITG Fachbericht 149, VDE-Verlag 1998.
[12]	Demmel, F.: Practical Aspects of Design and Application of Direction-Finding Systems. In: Tuncer, T. E., Friedlander, B. (Ed.): Classical and Modern Direction-of-Arrival Estimation. Elsevier Inc. 2009.
[13]	Van Trees, H.L.: Optimum Array Processing. John Wiley & Sons, 2002.
[14]	Hudson, J.E.: Adaptive Array Principles. Peter Peregrinus, New York, 1981.
[15]	Griffith, J.W.R.: Adaptive Array Processing. IEEE Proc., Vol. 130, Part H, No. 1, 1983.
[16]	Capon: High-resolution frequency-wave number spectrum analysis. IEEE Proc., Vol. 57, pp. 1408-1418, 1969.
[17]	Schmidt, R.O.: A Signal Subspace Approach to Multiple Emitter Location and Spectral Estimation. Dissertation, Dep. of Electr. Eng., Stanford University, Nov. 1981.
[18]	Gething, P.J.D.: Radio Direction Finding and Superresolution. Peter Peregrinus Ltd., London, 1990.
[19]	Höring, H.C.: Zur Empfindlichkeitssteigerung automatischer Großbasis-Doppler-Peiler durch Einsatz eines Summationsverfahrens vor der Demodulation. Dissertation, TU München 1970.
[20]	Saunders, R.S.: Antennas and Propagation for Wireless Communication Systems. John Wiley & Sons, 1999.
[21]	Schlitt, H.: Systemtheorie für stochastische Prozesse. Springer Verlag, 1992.

R&S®DDF5GTS High-Speed Scanning Direction Finder

Fast, accurate direction finding

New

The R&S®DDF5GTS high-speed scanning direction finder offers outstanding realtime bandwidth and DF scan speed as well as high DF accuracy, sensitivity and immunity to reflections. Thanks to the integrated super-resolution DF method¹⁾, the direction finder is ideal for complex signal scenarios.

The R&S®DDF5GTS can be operated with virtually all R&S®ADDx multichannel DF antennas. From the wide range of R&S®ADDx antennas, the right antenna(s) can be chosen for every application. The R&S®ADDx multichannel DF antennas have a large number of antenna elements and therefore offer a very wide aperture and exceptionally high performance. All antennas come with integrated lightning protection that does not impair DF accuracy.

For fast, automatic location of frequency agile signals, multiple R&S®DDF5GTS direction finders can be combined and operated in synchronized DF scan mode in conjunction with an optional, automatic preclassifier. The R&S®DDF5GTS complies with all ITU recommendations and can be extended with an option to include ITU-compliant measurement methods. With its optional DC power supply, the R&S®DDF5GTS is ideal for mobile applications.

Key facts

- Top DF scan speed thanks to three-channel architecture and outstanding realtime bandwidth
- High DF accuracy, sensitivity and immunity to reflections
- Integrated super-resolution DF method¹⁾
- Compliance with all ITU recommendations; ITU-compliant measurements available as an option
- Easy integration into mobile platforms thanks to optional DC power supply

¹⁾ Availability on request.



Benefits and key features

- Direction finding of extremely fast frequency agile signals with high probability of intercept
 - High DF scan speed thanks to 80 MHz realtime bandwidth
 - Direction finding and location of frequency hopping transmitters with up to 2000 hops/s
 - Direction finding and location of pulses with a duration of 10 µs
- Reliable DF results even in challenging environments
 - Higher immunity to reflections due to DF antennas with a very large number of antenna elements
 - Stable bearings even with a 50 percent share of reflections
- Innovative DF antennas
 - Active/passive switchover with just a mouse click
 - Exceptionally high DF sensitivity
 - Integrated, extendible lightning protection
 - Easy replacement of DF antennas
- Precise direction finding of weak signals
 - High DF sensitivity due to large number of antenna elements
 - Adjustable coherent signal integration in wideband DF mode and DF scan mode for enhanced DF sensitivity
- Accurate and reliable location of short-duration signals
 - GPS-based synchronization of multiple R&S®DDF5GTS (time-synchronized DF scan mode)
 - Optional preclassifier for detecting LPI signals and summarizing individual results into a condensed result
- Effective measurements in line with ITU recommendations
 - Compliance with all ITU recommendations for direction finders and receivers
 - Option for ITU-compliant measurement methods
- Receive mode with integrated antenna matrix ¹⁾
 - Very fast panorama scan
 - Integrated antenna matrix for connecting up to three VHF/UHF/SHF receiving antennas and up to three HF receiving antennas (option) in addition to the DF antenna
 - Independent DDC channel
 - Selection of the antenna element with maximum signal level
- Signal analysis in parallel with direction finding ¹⁾
 - Output of I/Q data for parallel signal analysis with R&S®CA120 ¹⁾
- Special, exceptionally powerful receive path for signal measurement
 - Special, exceptionally powerful receive path
 - Improved analog architecture of the receive path
 - Especially powerful analog/digital converters
 - Considerable advantages in the case of weak signals and dense signal scenarios
- Powerful hardware developed by Rohde&Schwarz
 - In-house development and manufacture of all DF system components, including the DF antenna
 - Signal processing at maximum speed based on powerful FPGAs
 - Use of powerful Rohde&Schwarz ASICs
 - High immunity to strong signals thanks to sophisticated preselection



Ordering information		
Designation	Type	Order No
High-Speed Scanning Direction Finder, AC power supply	R&S®DDF5GTS	4073.9203.02
High-Speed Scanning Direction Finder, DC power supply	R&S®DDF5GTS	4073.9203.12
Options		
HF Frequency Range Extension	R&S®DDFGTS-HF	4074.1270.02
Synchronization	R&S®DDFGTS-TS	4074.0922.02
Internal GPS Module, with GPS antenna	R&S®DDF-IGT	4079.8009.04
ITU Measurement Software	R&S®DDFGTS-IM	4074.0822.02
Documentation of Calibration Values	R&S®DDFGTS-DCV	4074.1187.02
Preclassification	R&S®DDFGTS-CL	3025.2912.02
Enhanced Measurement Speed, requires R&S®DDFGTS-ID ²⁾	R&S®DDFGTS-EMS	4501.0604.02
EMS Identification	R&S®DDFGTS-ID	4074.1229.02
DF Error Correction	R&S®DDFGTS-COR	4074.0974.02
External accessories		
DF antennas and accessories: see R&S®ADDx multichannel DF antennas product brochure, PD 0758.1106.12		

²⁾ The R&S®DDF5GTS-EMS option is subject to export control.

R&S®DDF550

Wideband Direction Finder

Fast and precise direction finding

The fast R&S®DDF550 wideband direction finder offers outstanding realtime bandwidth and DF scan speed as well as high DF accuracy, sensitivity and immunity to reflections. The unit has compact dimensions and is optionally available as a DC-powered model, which makes it ideal for mobile applications.

The R&S®DDF550 can be operated with virtually all R&S®ADDx multichannel DF antennas. From the wide range of R&S®ADDx DF antennas, the right antenna(s) can be chosen for every application. The R&S®ADDx DF antennas have a large number of antenna elements and therefore offer a very wide aperture and exceptionally high performance. All antennas come with integrated lightning protection that does not impair DF accuracy.

For fast, automatic location of frequency agile signals, multiple R&S®DDF550 direction finders can be combined and operated in synchronized DF scan mode in conjunction with an optional, automatic preclassifier. ITU-compliant measurement methods can optionally be added to the R&S®DDF550.

Key facts

- High DF accuracy, sensitivity and immunity to reflections
- High DF scan speed due to outstanding 80 MHz realtime bandwidth (VHF/UHF/SHF)
- Easy integration into mobile platforms due to compact size and optional DC power supply
- DF antennas with integrated, extendible lightning protection causing no impairment of DF accuracy

Benefits and key features

- Direction finding of short-duration signals with high probability of intercept
 - High DF scan speed due to outstanding 80 MHz realtime bandwidth
 - Direction finding of short-duration and frequency agile signals with high probability of intercept
 - Enhanced measurement speed (option)
- Reliable DF results even in challenging environments
 - Higher immunity to reflections due to DF antennas with a very large number of antenna elements (VHF/UHF/SHF)
 - Stable bearings in VHF/UHF/SHF range even with a 50% share of reflections
- Innovative DF antennas
 - Active/passive switchover with just a mouse click
 - Exceptionally high DF sensitivity
 - Integrated, extendible lightning protection
 - Easy replacement of DF antennas
- Precise direction finding of weak signals
 - High DF sensitivity due to large number of antenna elements
 - Adjustable coherent signal integration in wideband DF and DF scan mode for enhanced DF sensitivity
- Accurate and reliable location of short-duration signals
 - GPS based synchronization of multiple R&S®DDF550 (time-synchronized DF scan mode)
 - Optional preclassifier detects LPI signals and summarizes individual results into a condensed result
- Special, exceptionally powerful receive path for signal measurement
 - Special, exceptionally powerful receive path
 - Improved analog architecture of the receive path
 - Especially powerful analog/digital converters
 - Considerable advantages in the case of weak signals and dense signal scenarios
- Powerful hardware developed by Rohde&Schwarz
 - In-house development and manufacture of all DF system components, including the DF antenna
 - Signal processing at maximum speed based on powerful FPGAs
 - Use of powerful Rohde&Schwarz ASICs
 - High immunity to strong signals thanks to sophisticated preselection



- Effective measurements in line with ITU recommendations
- The R&S®DDF550 fulfills all ITU recommendations for direction finders and receivers.
- Option for comprehensive, ITU-compliant measurement methods including, for example:
 - Frequency and frequency offset, field strength, modulation, spectrum occupancy and bandwidth
- Direction finding of signals in the frequency range up to 6 GHz
- Fast, effective radiolocation of interferers

Designation	Type	Order No.
Designation	Type	Order No.
Wideband Direction Finder, with AC power supply	R&S®DDF550	4074.2002.04
Wideband Direction Finder, with DC power supply	R&S®DDF550	4074.2002.14
Options		
Documentation of Calibration Values	R&S®DDF550-DCV	4074.1170.02
HF Frequency Range Extension (receive option)	R&S®DDF550-HF	4074.1006.02
HF Frequency Range Extension (DF option)	R&S®DDF550-HF2	4074.1429.02
Service Kit	R&S®DDF-SK	4060.0454.02
Preclassifier	R&S®DDF550-CL	3025.2829.02
Time-Synchronous Scanning	R&S®DDF550-TS	4074.0900.02
ITU Measurement Software	R&S®DDF550-IM	4074.0800.02
DF Error Correction	R&S®DDF550-COR	4074.0951.02
Enhanced Measurement Speed, requires R&S®DDF550-ID ¹⁾	R&S®DDF550-EMS	4501.0504.02
EMS Identification, required for R&S®DDF550-EMS	R&S®DDF550-ID	4074.1206.02
Internal GPS Time Synchronous	R&S®DDF550-IGT	4079.8009.05
DF system accessories		
Super-Resolution HF DF Antenna, diameter: 100 m	R&S®ADD011SR	4078.0004.02
HF DF Antenna	R&S®ADD011P	4099.2006.02
Compact LF UHF DF Antenna	R&S®ADD216	4068.3000.02
HF DF Antenna	R&S®ADD119	4053.6509.02
Super-Resolution VHF DF Antenna	R&S®ADD050SR	4071.7003.02
Super-Resolution VHF/UHF DF Antenna	R&S®ADD153SR	4071.6007.02
Dual Polarized VHF/UHF DF Antenna	R&S®ADD157	4069.4800.22
UHF DF Antenna	R&S®ADD070	4043.4003.02/ .12 ²⁾
VHF/UHF Wideband DF Antenna	R&S®ADD253	4071.4004.12
Centric Mast HF DF Antenna	R&S®ADD015	4200.7002.04/ .54/ .84 ³⁾
Super-Resolution UHF/SHF DF Antenna	R&S®ADD078SR	4098.4005.02
Extended Lightning Protection, for R&S®ADD15x and R&S®ADD253	R&S®ADD-LP	4069.6010.02
Extended Lightning Protection, for R&S®ADD050SR	R&S®ADD-LP	4069.6010.03
HF DF Antenna Cable Set	R&S®DDF1XZ	4064.6286.xx ⁴⁾
VHF/UHF DF Antenna Cable Set	R&S®DDF5XZ	4064.6728.xx ⁴⁾
UHF DF Antenna Cable Set	R&S®DDF7XZ	4064.8043.xx ⁴⁾
DF Antenna Cable Set, for R&S®ADD078SR	R&S®DDF3C-7	4098.4757.xx ⁴⁾
Antenna Interconnection Cable Set, for interconnecting R&S®ADD078SR with R&S®ADD15x	R&S®DDF3CX	4098.4763.10
Electronic Compass	R&S®GH150	4041.8501.02
GPS Navigator/GPS Receiver	R&S®GINA	4055.6906.04
Vehicle Adapter	R&S®AP502Z1	0515.1419.02
Mast Adapter	R&S®ADD150A	4041.2655.02
Tripod with Adapter	R&S®ADD1XTP	4063.4409.02
Intermediate Mast	R&S®KM051	4041.9008.02
Antenna Adapter, with cable outlet	R&S®ADD071Z	4043.7002.02
Antenna Adapter, without cable inlet/flange	R&S®ADD071Z	4043.7002.03
19" Rack Adapter	R&S®ZZA-411	1096.3283.00

¹⁾ R&S®DDF550-EMS option is export restricted.

²⁾ Model .02 for DF antenna system with R&S®ADD15x and R&S®ADD050SR.

³⁾ Last two digits of the order number designate the cable length (cable length: 8 m (EF400)/5 m (RG214)/8 m (RG214)).

⁴⁾ The DF antenna cable sets are available in various lengths, designated by the last two digits of the order number.

R&S®ADDx Multichannel DF Antennas

The R&S®ADDx DF antennas are decisive for the high efficiency of the Rohde&Schwarz multichannel direction finders because they offer unique technical innovations. The wide product range covers stationary, transportable and mobile applications. In development, the focus was on the lightning protection concept of the antennas and their immunity to harsh ambient conditions.

Due to the large number of antenna elements, the R&S®ADDx DF antennas offer high direction-finding accuracy and sensitivity, as well as outstanding immunity to reflections. The active/passive switchover allows them to flexibly adapt to the signal environment and considerably increases their immunity to strong signals (see below).



The R&S®ADDxxxSR DF antennas are ready for the super-resolution DF method, with which bearings can be taken on multiple co-channel signals and the signals can be separated.

Key facts

- High DF accuracy and sensitivity, as well as high immunity to reflections due to the large number of antenna elements
- Ready for the super-resolution DF method for taking bearings on co-channel transmitters (R&S®ADDxxxSR)
- Active/passive switchover by mouse click for adapting the antenna to the signal environment (R&S®ADD011SR/050SR/011P/253/153SR/157)
- Antenna elements with variable electrical length for automatic adaptation to the current receive frequency (R&S®ADD157/253/153SR)
- Effective, integrated lightning protection with optional extension for applications with high likelihood of lightning strikes (R&S®ADD157/253/050SR/153SR)

Benefits and key features





- Eleven efficient DF antenna models for any application
- Superior immunity to reflections
 - Stable bearings even with a 50 percent share of reflections
 - Above-average antenna base (aperture) due to the exceptionally large number of antenna elements
- Ready for the super-resolution DF method
 - Taking bearings of up to seven signals simultaneously on the same frequency
 - Additional information such as receive level and DF quality for all signals whose bearings are taken
 - Taking bearings of all users of a TDMA network on a specific frequency (e.g. TETRA)
- Exceptionally high DF sensitivity and dynamic range
 - Use of antenna elements with electrically configurable structure
 - Optimal adaptation to the individual receive frequency ranges
 - Higher sensitivity and bandwidth than with elements without frequency-dependent adaptation of the antenna element structure – with same dimensions
- Active/passive switchover by mouse click
 - Adaptation of the R&S®ADD011SR, R&S®ADD050SR, R&S®ADD011P, R&S®ADD253, R&S®ADD153SR and R&S®ADD157 DF antennas to the signal environment
 - Switchover from active to passive mode
 - Active mode for maximum DF sensitivity; passive mode for maximum intermodulation suppression



[R&S®ADD070](#), [R&S®ADD050SR](#), [R&S®ADD153SR](#) and [R&S®ADD-LP](#).

- Integrated, extendible lightning protection
 - Utmost protection against lightning strikes
 - No impairment of DF accuracy
 - No time-consuming calibration after installation of the DF antenna

- Easy replacement of DF antennas
 - No individual calibration due to detailed development and precise production
 - Replacement of a DF antenna model without renewed administration/input of calibration data

Model overview

	<p>R&S®ADD078SR UHF/SHF SR DF antenna Frequency range from 1.3 GHz to 6 GHz</p>	<ul style="list-style-type: none"> ■ Mobile and stationary DF antenna ■ Multi-element DF antenna with two circular antenna arrays arranged on top of each other; each array contains eight elements ■ DF measurements up to ITU class A DF accuracy ■ Ready for the super-resolution DF method ■ Ready for installation of an additional DF antenna on top ■ For installation on a mast by means of an R&S®ADD07XZB mast adapter or for use on an R&S®ADD1XTP tripod
	<p>R&S®ADD119 HF DF antenna Frequency range from 300 kHz to 30 MHz</p>	<ul style="list-style-type: none"> ■ Mobile DF antenna ■ Suitable for ground waves and low-angle sky waves ■ DF measurements up to ITU class A DF accuracy ■ For installation on a vehicle roof by means of an R&S®AP502Z1 vehicle adapter or for use on an R&S®ADD1XTP tripod
	<p>R&S®ADD011SR super-resolution HF DF antenna Frequency range from 300 kHz to 30 MHz</p>	<ul style="list-style-type: none"> ■ Stationary and transportable DF antenna ■ Suitable for ground waves and sky waves ■ Multi-element DF antenna with 9/18 antenna elements ■ DF measurements up to ITU class A DF accuracy ■ Available in different diameters (50 m, 100 m and 150 m) ■ Model with 18 antenna elements in two concentric DF circles for especially high DF sensitivity and accuracy ■ Measurement of elevation enabling single station location (SSL) (optional) ■ Ready for the super-resolution DF method ■ Antenna elements with active/passive switchover for adaptation to the signal environment
	<p>R&S®ADD050SR super-resolution VHF DF antenna Frequency range from 20 MHz to 450 MHz</p>	<ul style="list-style-type: none"> ■ Stationary and transportable DF antenna ■ Multi-element DF antenna with nine antenna elements ■ DF measurements up to ITU class A DF accuracy ■ Ready for the super-resolution DF method ■ Antenna elements with active/passive switchover for adaptation to the signal environment ■ Integrated, extendible lightning protection concept with lightning rod; no impact on DF accuracy ■ Optional R&S®ADD-LP lightning protection extension ■ Installation of an additional DF antenna above the R&S®ADD050SR possible (using the R&S®KM051 intermediate mast and the R&S®ADD150A mast adapter)
	<p>R&S®ADD153SR super-resolution VHF/UHF DF antenna Frequency range from 20 MHz to 1.3 GHz</p>	<ul style="list-style-type: none"> ■ Mobile and stationary DF antenna ■ Multi-element DF antenna with nine antenna elements ■ DF measurements up to ITU class A DF accuracy ■ Antenna elements with variable electrical length for optimal adaptation to the receive frequency ■ Ready for the super-resolution DF method ■ Antenna elements with active/passive switchover for adaptation to the signal environment ■ Integrated, extendible lightning protection concept with lightning rod; no impact on DF accuracy ■ Optional R&S®ADD-LP lightning protection extension ■ For installation on a mast by means of an R&S®ADD150A mast adapter, on a vehicle roof by means of an R&S®AP502Z1 vehicle adapter or for use on an R&S®ADD1XTP tripod

Model overview		
	<p>R&S®ADD157 dual polarized VHF/UHF DF antenna Frequency range from 20 MHz to 1.3 GHz (vertical polarization) or from 40 MHz to 1.3 GHz (horizontal polarization)</p>	<ul style="list-style-type: none"> ▮ Mobile and stationary DF antenna ▮ Switchable between horizontal and vertical polarization ▮ Multi-element DF antenna with nine antenna elements each for vertical and horizontal polarization ▮ DF measurements up to ITU class A DF accuracy ▮ Antenna elements with variable electrical length for optimal adaptation to the receive frequency (vertical polarization) ▮ Integrated, extendable lightning protection concept with lightning rod; no impact on DF accuracy ▮ Optional R&S®ADD-LP lightning protection extension ▮ For installation on a mast by means of an R&S®ADD150A mast adapter, on a vehicle roof by means of an R&S®AP502Z1 vehicle adapter or for use on an R&S®ADD1XTP tripod ▮ Antenna elements with active/passive switchover for adaptation to the signal environment (models .2x)
	<p>R&S®ADD015 centric mast HF DF antenna Frequency range from 1 MHz to 30 MHz</p>	<ul style="list-style-type: none"> ▮ Centric mast DF antenna ▮ Especially suitable for use on board ships ▮ Suitable for ground waves and low elevation sky waves ▮ Four dipole antennas with integrated ferrite loop antennas ▮ Variable antenna diameter can be adapted to the mast ▮ Protected against overvoltage caused by nearby lightning strikes
	<p>R&S®ADD070 UHF DF antenna Frequency range from 1.3 GHz to 3 GHz</p> <p>R&S®ADD070 mounted below an R&S®ADD153SR</p>	<ul style="list-style-type: none"> ▮ Stationary and mobile DF antenna ▮ Multi-element DF antenna with eight antenna elements ▮ DF measurements up to ITU class A DF accuracy ▮ Ready for installation below another DF antenna (model .12) ▮ Protected against overvoltage caused by nearby lightning strikes ▮ Especially stable version (model .02) available for installing the R&S®ADD050SR and another DF antenna ▮ For installation on a mast by means of an R&S®ADD071Z mast adapter or for use on an R&S®ADD1XTP tripod
	<p>R&S®ADD011P HF DF antenna Frequency range from 300 kHz to 30 MHz</p>	<ul style="list-style-type: none"> ▮ Portable DF antenna ▮ Lightweight design for easy transportation and installation ▮ Suitable for ground waves and sky waves ▮ Multi-element DF antenna with nine antenna elements ▮ DF measurements up to ITU class A DF accuracy ▮ Measurement of elevation enabling single station location (SSL) (optional) ▮ Ready for the super-resolution DF method ▮ Antenna elements with active/passive switchover for adaptation to the signal environment ▮ R&S®ADD011P-HC handling case set (optional)
	<p>R&S®ADD253 VHF/UHF broadband DF antenna Frequency range from 20 MHz to 3 GHz</p>	<ul style="list-style-type: none"> ▮ Mobile broadband DF antenna ▮ Multi-element DF antenna with nine antenna elements for the VHF/UHF range and eight antenna elements for the UHF range ▮ Antenna elements with active/passive switchover for adaptation to the signal environment ▮ Antenna elements with variable electrical length for optimal adaptation to the receive frequency (20 MHz to 1.3 GHz) ▮ Integrated, extendable lightning protection concept with lightning rod; no impact on DF accuracy ▮ Optional R&S®ADD-LP lightning protection extension ▮ For installation on a mast by means of an R&S®ADD150A mast adapter, on a vehicle roof by means of an R&S®AP502Z1 vehicle adapter or for use on an R&S®ADD1XTP tripod

Model overview

	<p>R&S®ADD216 compact LF UHF DF antenna Frequency range from 300 kHz to 3 GHz</p>	<ul style="list-style-type: none"> ▀ Mobile broadband DF antenna ▀ Highly integrated antenna system with unique DF sensitivity and accuracy ▀ Especially suitable for use on board ships ▀ Multi-element DF antenna for VHF/UHF (with eight antenna elements each) and additional reference antennas ▀ Two independent omnidirectional reception antennas for the HF and VHF/UHF ranges already integrated for connecting separate receivers ▀ Protected against overvoltage caused by nearby lightning strikes
---	---	---

Ordering information

For detailed information, see R&S®ADDx Multichannel DF Antennas, Product overview brochure, PD 0758.1106.12
 Your local Rohde & Schwarz representative will help you determine the optimum solution for your requirements.
 To find your nearest Rohde & Schwarz representative, visit www.sales.rohde-schwarz.com

R&S®DDF255 Digital Direction Finder

Accurate direction finding with measurement and analysis capabilities in a single unit

The R&S®DDF255 combines the extremely powerful R&S®ESMD wideband monitoring receiver with the accurate correlative interferometer DF method. This combination yields a high-precision wideband direction finder featuring extensive measurement and analysis functions. With its high integration density and optional DC power supply, the R&S®DDF255 is also ideal for mobile applications.

Due to the use of wide-aperture DF antennas and a very large number of antenna elements, the correlative interferometer DF method offers a high degree of accuracy and outstanding immunity to reflections at an excellent price/performance ratio.

In addition, the direction finder offers a wide scope of measurement and analysis capabilities such as the optional measurement of radio signals in line with ITU recommendations.

Key facts

- Tried and tested DF method used by 24 regulatory authorities worldwide
- High-precision DF method at an excellent price/performance ratio (patented method)
- Reliable DF results even in difficult environments (e.g. in urban areas with up to 50% reflection)
- Direction finding of signals in the frequency range up to 8.2 GHz
- Detection of extremely short emissions at unknown frequencies due to high-speed panorama scan (optional)
- Measurement methods in line with ITU recommendations (optional)
- Realtime event capture (REC) for I/Q recordings and realtime replay (optional)



Benefits and key features

- Extended applications
 - Fast direction finding and spectrum monitoring, analysis and demodulation of wideband signals
- Effective measurements in line with ITU recommendations

The R&S®DDF255 fulfills all ITU recommendations for monitoring direction finders and receivers.

 - Option for ITU-compliant measurements on signal parameters for AM, FM and PM-modulated signals (e.g. modulation index, occupied bandwidth and phase deviation)
 - Offline measurements on digitally modulated signals using the R&S®CA100IS software and suitable options (in line with ITU recommendation SM1600)
- Wideband direction finding with realtime bandwidth of up to 20 MHz
 - Parallel determination of bearings of all transmitters within the realtime bandwidth
- Fast and reliable radiolocation due to high DF accuracy
 - High-precision correlative interferometer DF method using multi-element DF antennas (VHF/UHF/SHF)
- High-resolution IF spectrum
 - All details visible in DF mode
- Direction finding up to 8.2 GHz
 - Fast, effective interference detection
- Recording and replaying of up to 80 MHz wide I/Q data
 - Never miss an event: activation of recordings with flexible realtime event capture (REC)
 - Signals as received from an antenna: all receiver functions available when replaying I/Q data
 - Detailed display: replay of I/Q data with increased time resolution
 - Realtime replay of recorded data
- Special, exceptionally powerful receive path for signal measurement
 - Special, exceptionally powerful receive path
 - Improved analog architecture of the receive path
 - Especially powerful analog/digital converters
 - Considerable advantages in the case of weak signals and dense signal scenarios
- Hardware-accelerated multichannel signal processing
 - Multichannel signal detection and analysis in a networked system
 - Parallel multichannel output of more than 100 channels
 - Multichannel digital downconversion (DDC) signal extraction from the R&S®DDF255 realtime bandwidth with R&S®DDF255DDCE and R&S®CA120FFP
 - Automatic detection of fixed frequency and burst signals with R&S®DDF255-HRP and R&S®CA120DSC
- TDOA ready with high-accuracy timestamps and GPS synchronization of frequency and time
 - Synchronization of receiver frequency and time using the R&S®DDF255-IGT internal GPS module
 - High-accuracy timestamps in I/Q baseband data stream for use in TDOA systems

Ordering information		
Designation	Type	Order No
Base unit (including accessories supplied such as power cable, operating manual)		
Digital Direction Finder, without front panel control	R&S®DDF255	4067.9240.02
Digital Direction Finder, with front panel control	R&S®DDF255	4067.9240.03
Documentation of Calibration Values	R&S®DDF255-DCV	4066.4780.03
Options		
DC Power Supply	R&S®DDF255-DC	4066.4000.03
SHF Frequency Range Extension ¹⁾	R&S®DDF255-SHF	4066.4200.03
HF Frequency Range Extension	R&S®DDF255-HF	4066.4100.03
ITU Measurement Software	R&S®DDF255-IM	4066.4400.03
Internal Recording	R&S®DDF255-IR	4079.7960.03
Map Display	R&S®DDF255-Map	4079.7977.03
Panorama Scan ²⁾	R&S®DDF255-PS	4066.4500.03
Selective Call Analysis	R&S®DDF255-SL	4066.4600.03
DF Error Correction	R&S®DDF255-COR	4066.4745.03
Multifunction Board	R&S®DDF255-ADC2	4079.7925.03
Digital Downconverter ²⁾	R&S®DDF255-DDC	4066.4545.03
Bandwidth Extension (80 MHz) ²⁾	R&S®DDF255-WB	4066.4645.03
10 Gbit Ethernet Interface (without transceiver module)	R&S®DDF-10G	4074.7604.03
Internal GPS Module and External GPS Antenna	R&S®DDF255-IGT	4079.8009.03
Record and Replay ³⁾	R&S®DDF255-RR	4079.7954.03
Options for hardware-accelerated signal processing (in combination with R&S®CA120)		
Signal Processing Board	R&S®DDF255-SP	4066.4268.03
DDC Signal Extraction ⁴⁾	R&S®DDF255DDCE	4079.7760.03
High-Resolution Panorama Spectrum ⁴⁾	R&S®DDF255-HRP	4079.7902.03
Detection of Short-Time Signals ⁴⁾	R&S®DDF255-ST	4079.7883.03
DF system accessories		
Compact VHF/UHF DF Antenna	R&S®ADD107	4090.7005.02
Compact UHF/SHF DF Antenna	R&S®ADD207	4096.0002.02
Collapsible VHF/UHF DF Antenna	R&S®ADD307	4098.2002.07
HF DF Antenna	R&S®ADD119	4053.6509.02
VHF/UHF DF Antenna	R&S®ADD196	4077.3000.12
Dual Polarized VHF/UHF DF Antenna	R&S®ADD197	4068.1450.12
VHF/UHF Wideband DF Antenna	R&S®ADD295	4070.9002.02
UHF DF Antenna	R&S®ADD071	4043.6006.02
UHF/SHF DF Antenna	R&S®ADD075	4069.6603.12

Ordering information		
Designation	Type	Order No
UHF DF Antenna	R&S®ADD175	4079.4003.02
DF Antenna Cable Set for single-channel direction finders, frequency range 0.3 MHz to 1.3 GHz	R&S®DDF1C-1	4077.6009.xx ⁵⁾
DF Antenna Cable Set for single-channel direction finders, frequency range 0.3 MHz to 3 GHz	R&S®DDF1C-5	4077.7005.xx ⁵⁾
DF Antenna Cable Set for single-channel direction finders, frequency range 0.3 MHz to 6 GHz	R&S®DDF1C-7	4077.8001.xx ⁵⁾
Interconnection Cable Set for R&S®ADD075	R&S®DDF1CX	4077.8801.10
Interconnection Cable Set for R&S®ADD071	R&S®DDF1CX	4077.8801.15
Extended Lightning Protection	R&S®ADD-LP	4069.6010.02
Mast Adapter for compact DF antennas; color: light ivory	R&S®ADD150A	4041.2655.02
Antenna Adapter for R&S®ADD071, R&S®ADD190, R&S®ADD195, with cable outlet	R&S®ADD071Z	4043.7002.02
Antenna Adapter for R&S®ADD071, R&S®ADD190, R&S®ADD195, without cable inlet/flange	R&S®ADD071Z	4043.7002.03
Tripod with adapter for R&S®ADD195, R&S®ADD153, R&S®ADD119	R&S®ADD1XTP	4063.4409.02
Mast Adapter for R&S®ADD175	R&S®ADD17XZ2	4079.5000.02
Vehicle Adapter with Magnet Mount	R&S®ADD17XZ3	4090.8801.02
Antenna Cable Set without Converter, length: 5 m, for R&S®ADD107, R&S®ADD207 and R&S®ADD175	R&S®ADD17XZ4	4090.8730.02
Wooden Tripod	R&S®ADD17XZ6	4090.8860.02
Tripod Bag for R&S®ADD17XZ6	R&S®ADD17XZ7	4096.1450.02
Mast Adapter for R&S®ADD075	R&S®ADD07XZB	4069.7300.02
Antenna Adapter for R&S®ADD075	R&S®ADD07XZT	4069.7200.02
Vehicle Adapter for portable DF antennas; color: light ivory	R&S®AP502Z1	0515.1419.02
Electronic Compass	R&S®GH150	4041.8501.02
GPS Navigator/GPS Receiver with integrated inertial navigation (with GPS antenna)	R&S®GINA	4055.6906.04
Recommended extras		
Optical Cable, for 10 Gbit, incl. two optical transceivers, length: 20 m	R&S®GX460-OCG	4094.8641.02
Copper Cable, for 10 Gbit, incl. two optical transceivers, length: 5 m	R&S®GX460-CCG	4094.8635.02
19" Rack Adapter	R&S®ZZA411	1096.3283.00

¹⁾ Upgrade must be performed in factory.

²⁾ Only one R&S®DDF255-ADC2 is required for both options.

³⁾ R&S®DDF255-ADC2 is required.

⁴⁾ One R&S®DDF255-ADC2 and one R&S®DDF255-SP are required for this option.

⁵⁾ The DF antenna cable sets are available in various lengths, designated by the last two digits of the order number.

R&S®DDF205

Digital Direction Finder

Accurate direction finding in a compact unit

The R&S®DDF205 combines the new, highly integrated R&S®EB500 monitoring receiver with the accurate correlative interferometer DF method. This unique combination performs precise radio direction finding though it is compact and has low power consumption. Featuring wideband DF antennas and the ability to be powered from a DC source, the R&S®DDF205 is also ideal for mobile applications.

Due to the use of wide-aperture DF antennas and a very large number of antenna elements, the correlative interferometer DF method offers a high degree of accuracy and outstanding immunity to reflections at an excellent price/performance ratio.

The R&S®DDF205 fulfills all ITU recommendations for direction finders and receivers and can be extended with an option to include a comprehensive range of ITU-compliant measurement methods.

Key facts

- Tried-and-tested technology used by 24 regulatory authorities worldwide
- High-precision DF method at an excellent price/performance ratio (patented method)
- Reliable DF results even in difficult environments (e.g. in urban areas with up to 50% reflection)
- Compact dimensions and low power consumption

Benefits and key features

- Extended applications
 - Fast spectrum monitoring with scan speeds of up to 12 GHz/s
 - Display and demodulation of signals with up to 20 MHz bandwidth
 - Wideband DF antennas and DC power supply capability for mobile operation
 - Polychrome display for detection and analysis of short-duration signals
- Fast and reliable radiolocation due to high DF accuracy
 - Use of high-precision correlative interferometer DF method
 - Higher immunity to reflections due to DF antennas with a very large number of antenna elements
- Innovative DF antennas
 - Active/passive switchover with just a mouse click
 - Exceptionally high DF sensitivity
 - Integrated, extendible lightning protection
 - Easy replacement of DF antennas
- Effective measurements in line with ITU recommendations:
The R&S®DDF205 fulfills all ITU recommendations for direction finders and receivers.
 - Option for comprehensive, ITU-compliant measurement methods including, for example:
 - Frequency and frequency offset, field strength, modulation, spectrum occupancy and bandwidth
 - Measurement in line with ITU-R SM.1600
- Direction finding up to 6 GHz
 - Fast, effective interference detection



Ordering information		
Designation	Type	Order No
Base unit (including accessories supplied such as power cable, operating manual)		
Digital Direction Finder, without front panel control	R&S®DDF205	4073.0006.02
Digital Direction Finder, with front panel control	R&S®DDF205	4073.0006.03
Options		
HF Frequency Range Extension	R&S®DDF205-HF	4072.8003.03
SHF Frequency Range Extension	R&S®DDF205-FE	4072.9300.03
Panorama Scan	R&S®DDF205-PS	4072.9200.03
ITU Measurement Software	R&S®DDF205-IM	4072.9100.03
Digital Downconverter	R&S®DDF205-DDC	4072.9500.03
DF Error Correction	R&S®DDF205-COR	4072.9600.03
Wideband Direction Finding	R&S®DDF205-WDF	4072.9651.03
Selective Call/Pager Decoder	R&S®DDF205-SL	4072.9800.03
Documentation of Calibration Values	R&S®DDF205-DCV	4072.8403.03
Analysis of Signal Scenarios, in line with ITU-R SM.1600 (requires R&S®GX430 signal analysis and signal processing software)	R&S®GX430IS	4071.5817.02
External accessories		
HF DF Antenna	R&S®ADD119	4053.6509.02
VHF/UHF DF Antenna	R&S®ADD196	4077.3000.02
Dual Polarized VHF/UHF DF Antenna	R&S®ADD197	4068.1450.02
Broadband VHF/UHF DF Antenna	R&S®ADD295	4070.9002.12
UHF DF Antenna	R&S®ADD175	4079.4003.02
UHF DF Antenna	R&S®ADD071	4043.6006.02
UHF/SHF DF Antenna	R&S®ADD075	4069.6603.02
DF Antenna Cable Set for single-channel direction finders, frequency range 0.3 MHz to 1.3 GHz	R&S®DDF1C-1	4077.6009.xx ¹⁾
DF Antenna Cable Set for single-channel direction finders, frequency range 0.3 MHz to 3 GHz	R&S®DDF1C-5	4077.7005.xx ¹⁾
DF Antenna Cable Set for single-channel direction finders, frequency range 0.3 MHz to 6 GHz	R&S®DDF1C-7	4077.8001.xx ¹⁾
Interconnection Cable Set for the R&S®ADD075	R&S®DDF1CX	4077.8801.10
Interconnection Cable Set for the R&S®ADD071	R&S®DDF1CX	4077.8801.15
Extended Lightning Protection	R&S®ADD-LP	4069.6010.02
Mast Adapter	R&S®ADD150A	4041.2655.02
Mast Adapter for the R&S®ADD175	R&S®ADD17XZ2	4079.5000.02
Mast Adapter for the R&S®ADD075	R&S®ADD07XZB	4069.7300.02
Antenna Adapter, with cable outlet	R&S®ADD071Z	4043.7002.02
Antenna Adapter, without cable inlet/flange	R&S®ADD071Z	4043.7002.03
Antenna Adapter for the R&S®ADD075	R&S®ADD07XZT	4069.7200.02
Tripod with Adapter	R&S®ADD1XTP	4063.4409.02
Vehicle Adapter	R&S®AP502Z1	0515.1419.02
Vehicle Adapter with Magnet Mount	R&S®ADD17XZ3	4090.8801.02
Antenna Cable Set without Converter, length: 5 m	R&S®ADD17XZ4	4090.8730.02
Wooden Tripod	R&S®ADD17XZ6	4090.8860.02
Electronic Compass	R&S®GH150	4041.8501.02
GPS Navigator/GPS Receiver	R&S®GINA	4055.6906.04
19" Rack Adapter (1 × R&S®DDF205 + 1 × blind plate)	R&S®ZZA-T02	1109.4164.00
DC Power Cable	R&S®EB500-DCC	4072.7036.00

¹⁾ The DF antenna cable sets are available in various lengths, designated by the last two digits of the order number.

R&S®DDF007 Portable Direction Finder

Full range of functions in a handheld format

New

The R&S®DDF007 portable direction finder has an integrated, fast wideband receiver that covers a very wide frequency range. The battery-operated unit relies on high-precision DF methods. The R&S®DDF007 is used in conjunction with compact DF antennas, making it ideal for all applications that call for a powerful yet handy direction finder.

The DF system consists of the R&S®DDF007 portable direction finder and a compact DF antenna (R&S®ADD107 or R&S®ADD207). The DF antennas come with an integrated GPS module, an electronic compass and an optional magnetic mount vehicle adapter. Installing the portable direction finder in a commercial vehicle takes no more than a few minutes.

The direction finder's integrated wideband receiver offers ample functionality for signal detection and display, including a panorama scan function (optional) for the fast scanning of wide frequency ranges and a fast spectrogram (waterfall) display.

The optional, integrated map display function including triangulation makes it possible to visualize DF results on a map and locate transmitters by means of a running fix.



Key facts

- Wide frequency range from 20 MHz to 6 GHz (DF mode) and 9 kHz to 7.5 GHz (receive mode)
- High-precision correlative interferometer DF method in the range above 173 MHz
- Integrated, fast wideband receiver with optional panorama scan for fast scanning of wide frequency ranges
- Compact, multi-element DF antennas with integrated GPS module and electronic compass; optional magnetic mount adapter for fast antenna installation on a vehicle roof
- Optional, integrated map display function including triangulation for transmitter location by means of a running fix
- Compact, lightweight lithium-ion battery pack for two hours of DF operation or four hours of receive operation on a single battery charge

Benefits and key features

- Wide frequency range
 - DF mode: 20 MHz to 6 GHz
 - Receive mode: 9 kHz to 7.5 GHz
- Integrated, fast wideband receiver
 - Detailed IF spectrum display at high bandwidths
 - Fast spectrum monitoring
 - Demodulation of wideband signals
 - Signal analysis in receive mode (option)
- High-precision DF method
 - Correlative interferometer DF method in the range above 173 MHz
- Integrated map display (option)
 - Integration of OpenStreetMap (OSM) digital maps
 - Triangulation-based radiolocation
- Control and system software
 - R&S®DF7-CTL control software
 - R&S®RAMON software components (options):
 - Integration of application-specific maps
- Innovative, compact DF antennas and accessories
 - Multi-element DF antennas in the range above 173 MHz
 - Integrated GPS module and electronic compass
 - Vehicle adapter with magnetic mount (option)
 - Lightweight wooden tripod (option)
- Compact, lightweight lithium-ion battery pack
 - Two hours of DF operation or four hours of receive operation (with receiving antenna) on a single battery charge

Ordering information		
Designation	Type	Order No.
Base unit		
Portable Direction Finder IF spectrum (max. 10 MHz), spectrogram (waterfall display), 6-cell lithium-ion battery pack, plug-in power supply, SD card for storing user settings, shoulder strap, R&S®DF7-CTL control software (requires R&S®DDF007-RC remote control option)	R&S®DDF007	4090.5019.02
Options		
Externally Triggered Measurements external sensor (not included) triggers a measurement in the R&S®DDF007; the sensor is connected via the AUX interface	R&S®DDF007-ETM	4090.5054.02
SHF Frequency Processing for downconverter antennas downconverter unit of the R&S®HF907DC antenna is connected to the R&S®DDF007 via a control cable; the R&S®DDF007 recalculates the downconverted signals to display them with their original frequencies up to 18 GHz and with the sidebands in their original positions, so the user does not need to convert signals subsequently (antenna and downconverter not supplied with the R&S®DDF007-FP option)	R&S®DDF007-FP	4090.5077.02
Field Strength Measurement field strength is calculated using antenna factors stored in the R&S®DDF007; the R&S®DDF007 displays the field strength directly in dB μ V/m	R&S®DDF007-FS	4090.5060.02
GPS Software Interface/Map Display for processing the data stream from an external GPS module (not included)	R&S®DDF007-GPS	4090.5083.02
Internal Recording recording of measured data in the R&S®DDF007 (64 Mbyte RAM) or on SD card, recording of audio data in WAV format (replay using Windows Media Player, for example), recording of I/Q data, spectra and spectrogram (waterfall) data, R&S®DF7-CTL for playback of recorded data on customer PC	R&S®DDF007-IR	4090.5031.02
Panorama Scan RF scan, high-speed FFT scan across user-selectable scan range, selectable spectral resolution (bin width)	R&S®DDF007-PS	4090.5025.02
Remote Control remote control of the R&S®DDF007 via LAN interface (SCPI protocol); transfer of measured data via LAN interface; transfer of demodulated I/Q data (up to 500 kHz bandwidth) via LAN interface; control of the R&S®DDF007 with R&S®DF7-CTL (for remote control, data recording and data playback on customer PC)	R&S®DDF007-RC	4090.5048.02
DF antennas and accessories		
Compact VHF/UHF DF Antenna	R&S®ADD107	4090.7005.02
Compact UHF/SHF DF Antenna	R&S®ADD207	4096.0002.02
Vehicle Adapter with Magnet Mount	R&S®ADD17XZ3	4090.8801.02
Cable Set with Converter, length: 5 m	R&S®ADD17XZ5	4090.8660.02
Wooden Tripod	R&S®ADD17XZ6	4090.8860.02
Tripod Bag, for R&S®ADD17XZ6	R&S®ADD17XZ7	4096.1450.02
DF Antenna Backpack for R&S®DDF007 portable direction finder, R&S®ADD107 or R&S®ADD207 DF antenna, R&S®ADD17XZ5 cable set with converter and R&S®ADD17XZ3 vehicle adapter with magnet mount	R&S®ADD17XZ8	4096.1580.02
Battery Pack 6-cell lithium-ion battery, charging cradle, plug-in power supply	R&S®PR100-BP	4071.9206.02
Suitcase Kit hardshell transit case for the R&S®DDF007 without DF antenna (trolley case, with headphones and telescopic antenna and extra space for accessories)	R&S®PR100-SC	4071.9258.02
Vehicle Adapter for Power Supply	R&S®HA-Z202	1309.6117.00
Carrying Holster chest strap and rainproof cover	R&S®HA-Z222	1309.6198.00
Carrying Bag soft carrying bag	R&S®HA-Z220	1309.6175.00

Ordering information		
Designation	Type	Order No.
Accessory Package 1 compatible with R&S®HA-Z222 carrying holster: consists of a sun roof for the LCD and a carrying handle for convenient carrying of the R&S®HA-Z222	R&S®PR100-AP1	3589.9458.00
GPS Receiver external GPS receiver for the R&S®PR100/R&S®DDF007	R&S®HA-Z240	1309.6700.03
Active Directional Antenna three antenna modules covering the range from 20 MHz to 7.5 GHz, grip piece housing switchable preamplifier, hardshell transit case with extra space for the R&S®PR100/R&S®DDF007 (antenna model including mechanical compass)	R&S®HE300	4067.5900.02
Active Directional Antenna three antenna modules covering the range from 20 MHz to 7.5 GHz, grip piece housing switchable preamplifier, hardshell transit case with extra space for the R&S®PR100/R&S®DDF007 (antenna model including electronic compass and integrated GPS module)	R&S®HE300	4067.5900.03
HF Option for R&S®HE300 loop antenna from 9 kHz to 20 MHz for the R&S®HE300 active directional antenna	R&S®HE300HF	4067.6806.02
SHF antenna and accessories		
SHF Directional Antenna with Downconverter	R&S®HF907DC	4070.8006.02
Cable Set	R&S®HF907DC-K1	4070.8958.02
Tripod Adapter	R&S®HF907DC-Z1	4079.3113.02
Carrying Case	R&S®HF907DC-Z2	4079.3207.02
Documentation of Calibration Values	R&S®DDF007-DCV	4090.5090.02

R&S®ADDx Single-Channel DF Antennas

The R&S®ADDx DF antennas are decisive for the high efficiency of the Rohde&Schwarz single-channel direction finders because they offer unique technical innovations. The wide product range covers stationary, transportable and mobile applications. In development, the focus was on the lightning protection concept of the antennas and their immunity to harsh ambient conditions.

Due to the large number of antenna elements, the R&S®ADDx DF antennas offer high direction-finding accuracy and sensitivity, as well as outstanding immunity to reflections. The active/passive switchover allows them to flexibly adapt to the signal environment and considerably increases their immunity to strong signals (see below).







Key facts

- High DF accuracy and sensitivity, as well as high immunity to reflections due to the large number of antenna elements
- Active/passive switchover by mouse click for adapting the R&S®ADD196/197/295 antennas to the signal environment
- Antenna elements with variable electrical length for automatic adaptation to the current receive frequency (R&S®ADD196/197/295)
- Effective, integrated lightning protection with optional extension for applications with high likelihood of lightning strikes (R&S®ADD196/197/295)

Benefits and key features



- Ten efficient DF antenna models for any application
- Superior immunity to reflections
 - Stable bearings even with a 50 percent share of reflections
 - Above-average antenna base (aperture) due to the exceptionally large number of antenna elements
- Exceptionally high DF sensitivity and dynamic range
 - Use of antenna elements with electrically configurable structure
 - Optimal adaptation to the individual receive frequency ranges
 - Higher sensitivity and bandwidth than with elements without frequency-dependent adaptation of the antenna element structure – with same dimensions
- Active/passive switchover by mouse click
 - Adaptation of the DF antenna to the signal environment
 - Switchover from active to passive mode
 - Active mode for maximum DF sensitivity
 - Passive mode for maximum intermodulation suppression
- Integrated, extendible lightning protection
 - Utmost protection against lightning strikes
 - No impairment of DF accuracy
 - No time-consuming calibration after installation of the DF antenna
- Easy replacement of DF antennas
 - No individual calibration due to detailed development and precise production
 - Replacement of a DF antenna model without renewed administration/input of calibration data

R&S®ADD107 mounted on R&S®ADD17XZ6.

Model overview		
	<p>R&S®ADD119 HF DF antenna</p>	<ul style="list-style-type: none"> ▮ Mobile and portable DF antenna for the frequency range from 300 kHz to 30 MHz ▮ Suitable for ground waves and low-angle sky waves ▮ DF measurements up to ITU class A DF accuracy ▮ For installation on a vehicle roof by means of an R&S®AP502Z1 vehicle adapter or for use on an R&S®ADD1XTP tripod
	<p>R&S®ADD196 VHF/UHF DF antenna</p>	<ul style="list-style-type: none"> ▮ Mobile and stationary DF antenna for the frequency range from 20 MHz to 1.3 GHz ▮ Multi-element DF antenna with nine elements ▮ DF measurements up to ITU class A DF accuracy ▮ Antenna elements with variable electrical length for optimal adaptation to the receive frequency ▮ Antenna elements with active/passive switchover for adaptation to the signal environment (models .1x) ▮ Integrated, extendible lightning protection with lightning rod; no impact on DF accuracy ▮ R&S®ADD-LP extended lightning protection (option) ▮ For installation on a mast by means of an R&S®ADD150A mast adapter or for use on an R&S®ADD1XTP tripod
	<p>R&S®ADD197 dual-polarized VHF/UHF DF antenna</p>	<ul style="list-style-type: none"> ▮ Mobile and stationary DF antenna for the frequency range from 20 MHz to 1.3 GHz (vertical polarization) or from 40 MHz to 1.3 GHz (horizontal polarization) ▮ Switchable between horizontal and vertical polarization ▮ Multi-element DF antenna with nine elements each for vertical and horizontal polarization ▮ DF measurements up to ITU class A DF accuracy ▮ Antenna elements with variable electrical length for optimal adaptation to the receive frequency (vertical polarization) ▮ Antenna elements with active/passive switchover for adaptation to the signal environment, for both vertical and horizontal polarization (models .1x) ▮ Integrated, extendible lightning protection with lightning rod; no impact on DF accuracy ▮ R&S®ADD-LP extended lightning protection (option) ▮ For installation on a mast by means of an R&S®ADD150A mast adapter, on a vehicle roof by means of an R&S®AP502Z1 vehicle adapter or for use on an R&S®ADD1XTP tripod
	<p>R&S®ADD295 VHF/UHF wideband DF antenna</p>	<ul style="list-style-type: none"> ▮ Mobile and stationary DF antenna for the frequency range from 20 MHz to 3 GHz ▮ Multi-element DF antenna with nine elements for the VHF/ UHF range and eight antenna elements for the UHF range ▮ Antenna elements with variable electrical length for optimal adaptation to the receive frequency (20 MHz to 1.3 GHz) ▮ Antenna elements with active/passive switchover for adaptation to the signal environment ▮ Integrated, extendible lightning protection with lightning rod; no impact on DF accuracy ▮ R&S®ADD-LP extended lightning protection (option) ▮ For installation on a mast by means of an R&S®ADD150A mast adapter, on a vehicle roof by means of an R&S®AP502Z1 vehicle adapter or for use on an R&S®ADD1XTP tripod

Model overview		
	<p>R&S®ADD175 compact UHF DF antenna for mobile radio frequency range</p>	<ul style="list-style-type: none"> ▀ Mobile and portable DF antenna for the mobile radio frequency range from 690 MHz to 2.7 GHz ▀ Compact correlative interferometer DF antenna ▀ Multi-element DF antenna with eight elements ▀ DF measurements up to ITU class A DF accuracy ▀ Electronic compass and GPS integrated ▀ Easy installation on a vehicle roof using the R&S®ADD17XZ3 vehicle adapter with magnet mount and R&S®ADD17XZ4 cable set ▀ R&S®ADD17XZ6 wooden tripod (option)
	<p>R&S®ADD071 UHF DF antenna</p>	<ul style="list-style-type: none"> ▀ Mobile and stationary DF antenna for the frequency range from 1.3 GHz to 3 GHz ▀ Multi-element DF antenna with eight elements ▀ DF measurements up to ITU class A DF accuracy ▀ Ready for installation of an additional DF antenna on top ▀ For installation on a mast by means of an R&S®ADD071Z mast adapter or for use on an R&S®ADD1XTP tripod
	<p>R&S®ADD075 UHF/SHF DF antenna</p>	<ul style="list-style-type: none"> ▀ Mobile and stationary DF antenna for the frequency range from 1.3 GHz to 8.2 GHz ▀ Multi-element DF antenna with two circular antenna arrays arranged on top of each other; each array contains eight elements ▀ DF measurements up to ITU class A DF accuracy ▀ Ready for installation of an additional DF antenna on top ▀ For installation on a mast by means of an R&S®ADD07XZB mast adapter or for use on an R&S®ADD1XTP tripod
	<p>R&S®ADD107 compact VHF/UHF DF antenna</p>	<ul style="list-style-type: none"> ▀ Mobile and portable DF antenna for the frequency range from 20 MHz to 1.3 GHz ▀ Above 173 MHz: <ul style="list-style-type: none"> ▀ Compact correlative interferometer DF antenna ▀ Multi-element DF antenna with eight antenna elements ▀ Below 173 MHz: <ul style="list-style-type: none"> ▀ Powerful Watson-Watt DF method ▀ Integrated electronic compass ▀ Integrated GPS module with GPS antenna ▀ R&S®ADD17XZ3 vehicle adapter with magnetic mount for fast antenna installation on a vehicle roof (option) ▀ R&S®ADD17XZ6 wooden tripod (option)

Model overview

	R&S®ADD207 compact UHF/SHF DF antenna	<ul style="list-style-type: none"> ■ Mobile and portable DF antenna for the frequency range from 690 MHz to 6 GHz ■ Compact correlative interferometer DF antenna ■ Two multi-element DF antennas mounted one above the other, each containing eight elements ■ Integrated electronic compass ■ Integrated GPS module with GPS antenna ■ R&S®ADD17XZ3 vehicle adapter with magnetic mount for fast antenna installation on a vehicle roof (option) ■ R&S®ADD17XZ6 wooden tripod (option)
	R&S®ADD307 collapsible VHF/UHF DF antenna	<ul style="list-style-type: none"> ■ Portable DF antenna for the frequency range from 20 MHz to 690 MHz ■ Accurate correlative interferometer DF antenna, optimized for size and weight ■ Collapsible lightweight design ■ Integrated GPS and electronic compass ■ Collapsible lightweight mast as option

Ordering information

For detailed information, see R&S®ADDx Single-Channel DF Antennas, Product overview brochure, PD 3606.8295.12

Your local Rohde&Schwarz representative will help you determine the optimum solution for your requirements.

To find your nearest Rohde&Schwarz representative, visit www.sales.rohde-schwarz.com

R&S®DDF04E

Digital Direction Finder for Traffic Control

Radio direction finding on multiple channels

The R&S®DDF04E represents the new generation of traffic control direction finders. Radio direction finding for air and maritime traffic control is performed simultaneously on multiple frequency channels using only one direction finder.

The R&S®DDF04E digital direction finder is used in traffic control systems to take the bearings of multiple aircraft or ships simultaneously using only one direction finder. The use of a wide-aperture DF antenna with nine antenna elements, in combination with the correlative interferometer DF method, provides high DF accuracy, sensitivity and outstanding immunity to reflections. The R&S®DDF04E features wideband functionality. Direction finding can therefore take place on as many as 32 channels (optional) simultaneously with the same high level of performance. The direction finder contains control software for the flexible management of the frequency channels.

Key facts

- ▮ Parallel direction finding on up to 32 channels (optional) with the same high level of DF accuracy and sensitivity on all channels
- ▮ Seamless coverage of a wide frequency range from 100 MHz to 450 MHz with only one DF antenna
- ▮ Future-ready due to simple changing of the receive frequency and number of channels via the control software, as well as due to the forthcoming 8.33 kHz channel spacing that is already integrated
- ▮ Standard PCs, monitors and network technology for control and display
- ▮ Flexible networking of direction finder, data server and display units via Ethernet
- ▮ Output of results on radar displays and in traffic management systems via an RS-232 or TCP/IP interface

Benefits and key features

- ▮ One direction finder for all frequency channels with high DF accuracy and sensitivity
 - Parallel direction finding on multiple frequency channels with only one direction finder
 - The base unit features four user-configurable frequency channels and is optionally expandable to 32 channels
 - DF accuracy and measurement speed are equally high for all frequency channels
 - The R&S®DDF04E meets the requirements of the DFS Deutsche Flugsicherung GmbH (company responsible for air traffic control in Germany) and the recommendations of the ICAO and the ITU
 - The R&S®ADD050SR DF antenna, a wide-aperture system with nine antenna elements, features a high level of DF accuracy and sensitivity and outstanding immunity to reflections
 - Excellent large-signal immunity due to sophisticated preselection and extremely linear receivers



- ▮ Wide frequency range with only one DF antenna: flexible and ready for future needs

 - Wide frequency range from 100 MHz to 450 MHz for simultaneously monitoring of all important distress frequencies
 - Coverage of the entire frequency range with only one R&S®ADD050SR wide-aperture antenna
 - R&S®ADD153SR compact DF antenna for mobile applications
 - The forthcoming 8.33 kHz channel spacing for digital aeronautical radio is already integrated
 - The frequencies of the channels being monitored can be changed via mouse click
 - The number of channels being monitored can be increased by enabling a software option (additional hardware may be required for suppressing ground transmitter signals)
- ▮ Simple networking and control

 - Networking of direction finder, data server and display units via LAN
 - Output of DF results on radar displays via RS-232 or TCP/IP interfaces
 - Standard PCs, monitors and network technology for data distribution, control and display
- ▮ Comprehensive selftest capabilities

 - Built-in test including permanent monitoring of more than 170 test points in the background and automatic generation of error messages
 - Integrated antenna radiator test to check the functionality of all DF antenna elements
 - Comprehensive R&S®DDF-SK service kit (option) for effective on-site troubleshooting

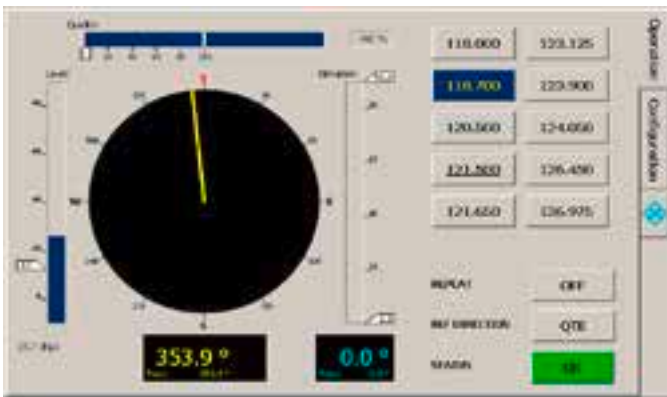

Control of R&S®DDF04E via touchpanel (option).

Ordering information		
Designation	Type	Order No
Base unit (including control software and supplied accessories such as power cable, manual, etc.)		
Digital Direction Finder for Traffic Control	R&S®DDF04E	4076.3006.02
Option (typically firmware)		
Four-Channel Expansion	R&S®DDF04E-4C	4076.3406.02
System components		
VHF/UHF DF Antenna	R&S®ADD050SR	4071.7003.02
VHF/UHF Compact DF Antenna	R&S®ADD153SR	4071.6007.02
DF Antenna Cable Set, available in different lengths	R&S®DDF5xZ	4064.6728.xx
Lightning Protection	R&S®ADD-LP	4069.6010.02
Mast Adapter for compact VHF/UHF DF antenna, color: light ivory	R&S®ADD150A	4041.2655.02
Electronic Compass	R&S®GH150	4041.8501.02
GPS Navigator/GPS Receiver with integrated inertial navigation function (with GPS antenna)	R&S®GINA	4055.6906.04
Mast for R&S®ADD153SR, hot-galvanized steel, length: 1.65 m	R&S®KM225M3	4036.5508.02
Mast Extension for R&S®ADD153SR, hot-galvanized steel, length: 1.65 m	R&S®KM225M4	4036.0758.02
Mast Guying, consisting of three guy ropes	R&S®KM225AS	4034.9706.02

R&S®DDF200M Digital Direction Finder

Radio direction finding on multiple channels

New

The R&S®DDF200M digital direction finder represents the latest generation of traffic control direction finders. Radio direction finding for maritime traffic control is performed simultaneously on multiple frequency channels using only one direction finder.

The R&S®DDF200M delivers accurate radio direction finding results in vessel traffic control applications. It measures the radio emissions from ships in the maritime VHF range on many frequency channels in parallel. Thanks to the wideband DF technology, the DF performance is equally high on all frequency channels measured. In contrast to traditional traffic control direction finders, which require one DF unit per frequency channel, only one R&S®DDF200M is used to measure all frequency channels required.

The correlative interferometer DF method is used in combination with the wide aperture R&S®ADD090 VHF DF antenna (with nine antenna elements) to provide high DF accuracy, sensitivity and immunity to reflections.

Key facts

- Parallel direction finding on up to 32 maritime channels with the same high DF accuracy and sensitivity on all channels
- Quasi-simultaneous direction finding on additional channels outside the maritime frequency range, e.g. distress channels
- Seamless coverage of a wide frequency range from 118 MHz to 250 MHz (with R&S®ADD090)
- Adaptive interference cancellation (option) in instances where VHF radiocommunications antennas are installed on the same mast as the DF antenna
- Output of results to vessel traffic management systems via a serial interface (option) or TCP/IP interface
- Serial interface compatible with R&S®DDF100M (option)



Benefits and key features

- One direction finder for all frequency channels
 - Parallel direction finding on up to 32 maritime channels with the same high DF accuracy and sensitivity on all channels
 - Quasi-simultaneous direction finding on additional channels outside the maritime frequency range, e.g. distress channels
- High DF accuracy, sensitivity and immunity to reflections
 - Correlative interferometer DF method
 - Multi-element wide aperture DF antenna
- Adaptive interference cancellation (option)
 - Suppression of interference signal caused by strong adjacent transmitters to enable direction finding
 - Installation of DF antenna and maritime radiocommunications antennas on the same mast
- Simple networking and control
 - Networking of direction finder, data server and display units via LAN
 - Output of results to vessel traffic management systems (VTMS) via TCP/IP or optional serial interface
 - Serial interface compatible with R&S®DDF100M (option)
 - Powerful R&S®DDF20M-CTL graphical user interface and control software included
- Comprehensive selftest capabilities
 - Built-in test and automatic alerts in event of error(s)
- Integrated DF antenna lightning protection
 - No impairment of DF accuracy
 - DF accuracy specified in data sheets attained even with lightning rod
 - No time-consuming calibration after DF antenna installation

Ordering information		
Designation	Type	Order No
Base unit (including supplied accessories such as power cable, operating manual)		
Digital Direction Finder	R&S®DDF200M	4073.1002.02
Options		
Serial Interface	R&S®DDF200M-SE	4073.1402.02
Documentation of Calibration Values	R&S®DDF200M-DCV	4073.1225.02
System components		
VHF DF Antenna for R&S®DDF200M	R&S®ADD090	4063.7043.02
Antenna Network for R&S®ADD090	R&S®GX090	4063.4844.02
Combiner Network	R&S®GX090C	4063.2641.02
VHF Cable Set for R&S®DDF200M system, without interference canceller	R&S®DDF91XZ	4064.8920.xx ¹⁾
VHF Cable Set for R&S®DDF200M system, with interference canceller	R&S®DDF92XZ	4064.9362.xx ¹⁾
Adapter for R&S®ADD196 for mobile application	R&S®ADD150A	4041.2655.02
Mast Extender	R&S®KM090	4067.5722.02
19" Rack Adapter	R&S®ZZA-T02	1109.4164.00

¹⁾ The DF antenna cable sets are available in various lengths, designated by the last two digits of the order number.



Chapter 4

Analyzers

The frequency spectrum is limited, but the diversity of applications in mobile, wireless and satellite communications is dramatically increasing. It poses ever-increasing challenges for civilian regulation authorities, intelligence services, security agencies, commercial communities, public and even private services. Signal monitoring and interception across wide frequency ranges with different signal scenarios is very challenging. Furthermore, comprehensive signal analysis of unknown and complex emissions demands a great deal of effort. With thousands of signals occupying the frequency spectrum, the mission is to monitor all the target signals, detect signals of interest and identify the unknowns.

With the rapidly increasing demand for signal analysis in radiomonitoring and radiolocation, there is an urgent need for enhanced signal monitoring solutions. A proficient and advanced signal monitoring solution should enable the surveillance of a spectrum segment in order to detect emissions of interest which are then recognized, classified, and further processed (recording, demodulation, decoding and analysis).

Signal surveillance: observing (i.e. targeted monitoring) the occurrence and behavior of specific signals in order to obtain situation awareness of a certain signal scenario. Surveillance systems must be capable of measuring unknown or “unfriendly” transmissions and extract the information content.

Signal interception: searching for, detecting, recording and reporting all signals of interest in a given scenario, often including content extraction by using demodulators and decoders.

Signal analysis: determining the technical signal parameters by performing automatic or manual measurements on live or recorded signals. This might also include using demodulators and decoders to resolve the content of an unknown signal.

Type	Designation	Page
	Introduction	114
New	R&S®CA100 PC-Based Signal Analysis and Signal Processing Software	124
New	R&S®CA120 Multichannel Signal Analysis Software	127
New	R&S®GX460 Digital Wideband Storage Device	130
New	R&S®GX465 Digital Wideband Storage Device	132
	R&S®GX410 R&S®AMLAB Signal Analysis Software	134
	R&S®CA250 Bitstream Analysis	136
New	R&S®TPA Technical Pulse Analysis	138

Introduction

The essence of Rohde & Schwarz signal interception and signal analysis

The need to search for signals of interest in large, densely populated frequency ranges requires automated techniques for signal detection, classification, demodulation and processing, which are becoming the key elements in the design of signal monitoring solutions.

Missions range from the detection and processing of specific signals of interest to the discovery of unknown transmissions within a dense scenario – from classification of all emissions to automated recording and processing of both known and unknown signals according to user-specific criteria.

Rohde & Schwarz signal analysis products provide all-in-one signal analysis solutions encompassing:

- ▀ Searching for, detection and classification of numerous signal types
- ▀ Analysis and characterization of unknown signal types
- ▀ Monitoring of signals that range from HF to SHF, covering a comprehensive array of modulation types and transmission systems
- ▀ Decoding of a wide range of transmission systems, including voice, text, fax, telemetry, signaling and data
- ▀ Analysis of analog and digital signals as well as LPI methods (e.g. frequency agile short-time emissions)
- ▀ Fully automatic interception and monitoring of specific signals
- ▀ Automatic profile recognition or separation of different frequency agile transmission systems and online recombination of frequency agile short-time signals to a continuous baseband signal
- ▀ Automatic classification, recording and content recovery
- ▀ Techniques for reducing the time required for detection, search and classification processes, e.g. frequency exclusion list, spectral shape detection and prioritizing
- ▀ Technical pulse analysis software offers an extensive set of detection, visualization and measurement tools for analyzing pulsed and FMCW radar signals

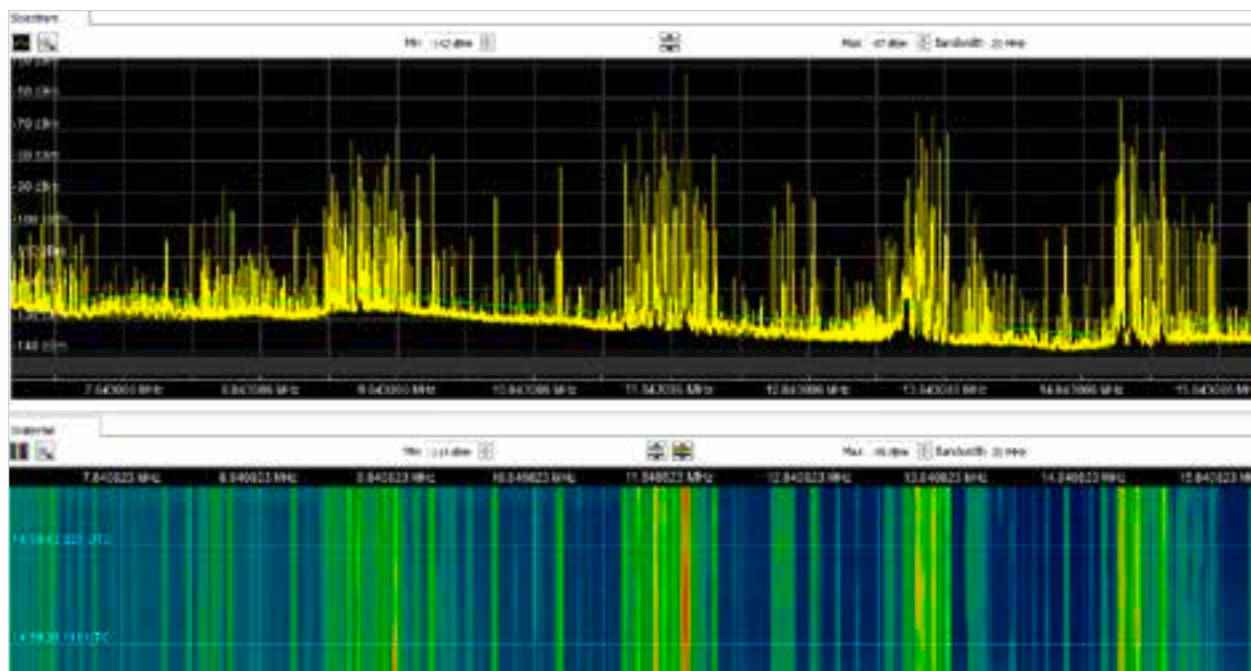

The challenges of radiomonitoring are on the rise as radio networking sweeps the globe and frequency bands are occupied with thousands of signals. The search for signals of interest in large, densely populated frequency ranges is the equivalent of looking for a needle in a haystack.

Signal processing

The complete signal processing chain is shown in the figure below. The Rohde & Schwarz signal analysis solution receives I/Q data (live or replayed), and a high-resolution spectrum is computed from this input and fed to the detector. The detector applies a detection threshold to the spectrum, which is adapted to the variable noise floor. The detected emissions can be further processed by the spectral shape detector (SDT), which features a spectral

pattern-matching detection technology. Additionally, interception processing channels with baseband classifiers (CL) can be used to automatically recognize the modulation type, the transmission system and the technical signal parameters of each detected signal. The solution provides multichannel capabilities that allow monitoring of a large number of signals simultaneously. The automatic processing (AP) functionality combines the detect, search and classify module with fully automated signal processing

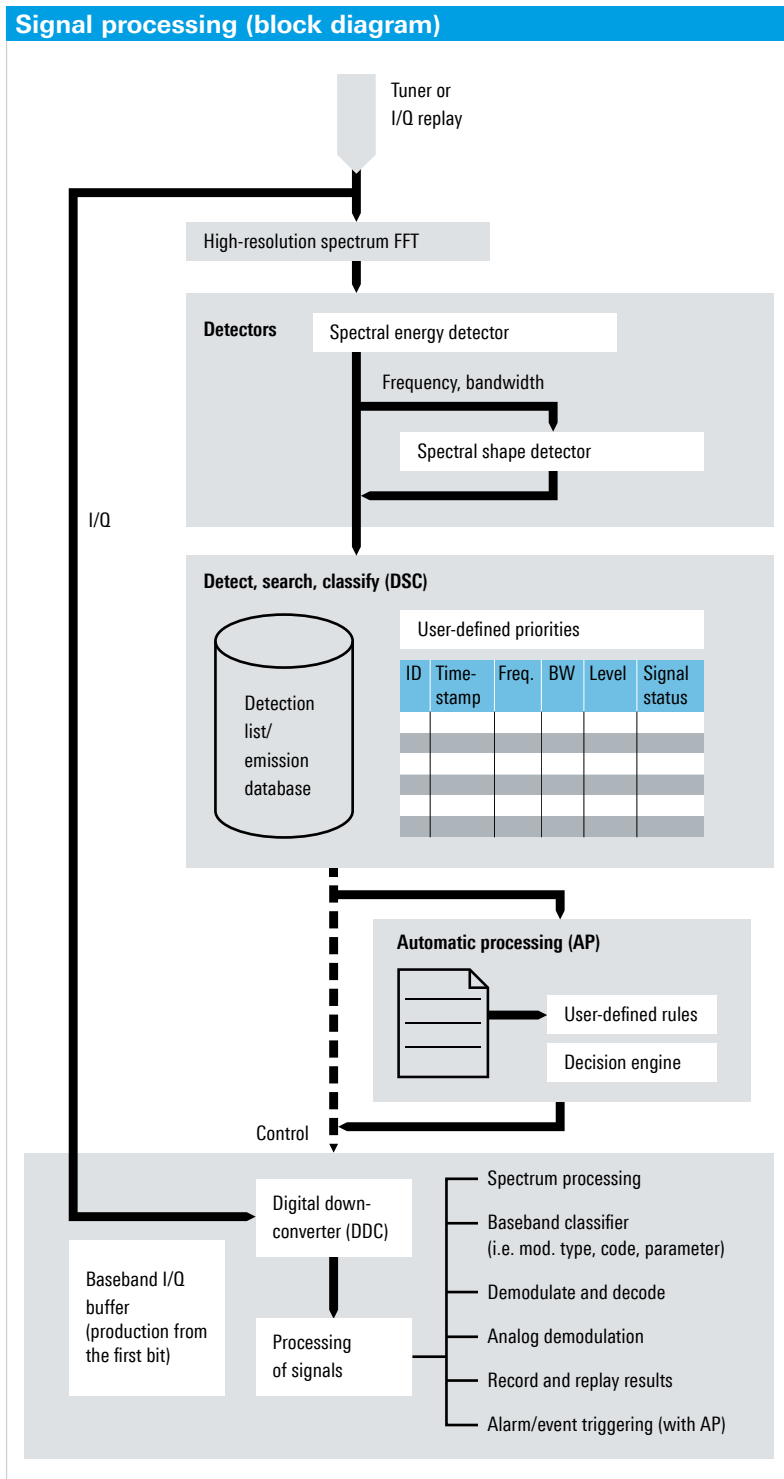

based on user-defined rules. This incorporates a variety of functions, including: spectrum processing, baseband classification, demodulation, decoding, recording and alarm/event triggering.

Spectral shape detector

Owing to its spectral matching algorithm, the spectral shape detector implements a high-speed search for known and unknown signals with a processing rate of over 1000 emissions/s. Common shapes are predefined in a generic profile (i.e. CW, AM-DSB, multichannel and FSK signals). User-defined shapes can be generated via the spectral trainer application and combined in custom profiles in order to recognize both known and unknown signals.

The decisions of the spectral matching algorithm are based on many criteria within a comprehensive decision matrix, allowing the similarities between input signals and shape profiles to be reliably assessed. This method is ideal for recognizing and extracting signals of interest, excluding unwanted signals and developing a custom library of identifiable signal types.

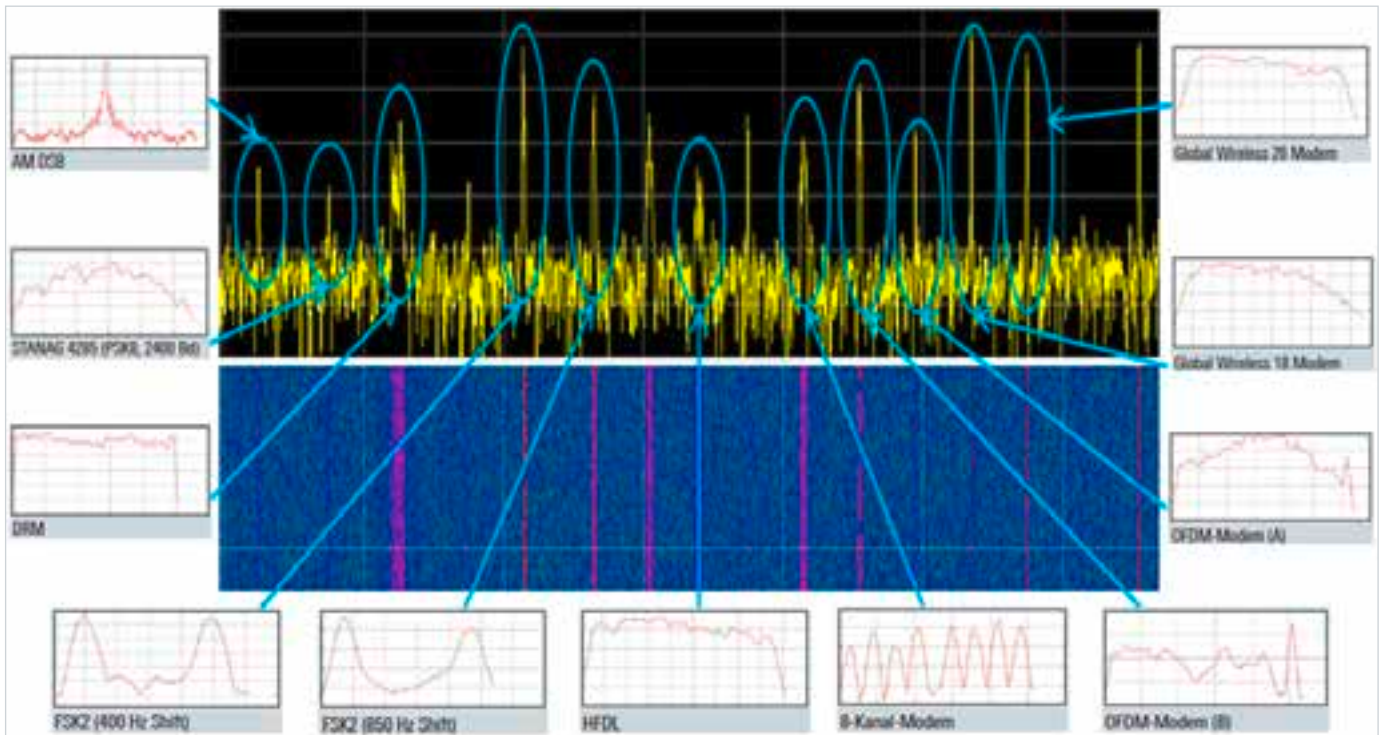

Numerous types of modern communications signals can be recognized by comparing their spectral shapes with predefined reference shapes at very high speed.

Baseband classifier

The baseband classifier is a reliable solution for determining the modulation type, measuring technical parameters and identifying the transmission system of a wide range of analog and digital signals. The baseband classifier is an essential tool for automatic search strategies, as it provides the precise results that are needed to make reliable decisions in the context of the search strategy and signal surveillances. The automatic classification algorithm performs segmentation, modulation analysis and transmission system recognition; this determines the signal's exact center frequency and bandwidth as well as relevant technical signal parameters such as symbol rate, frequency, shift, modulation types, number of OFDM channels and codes.

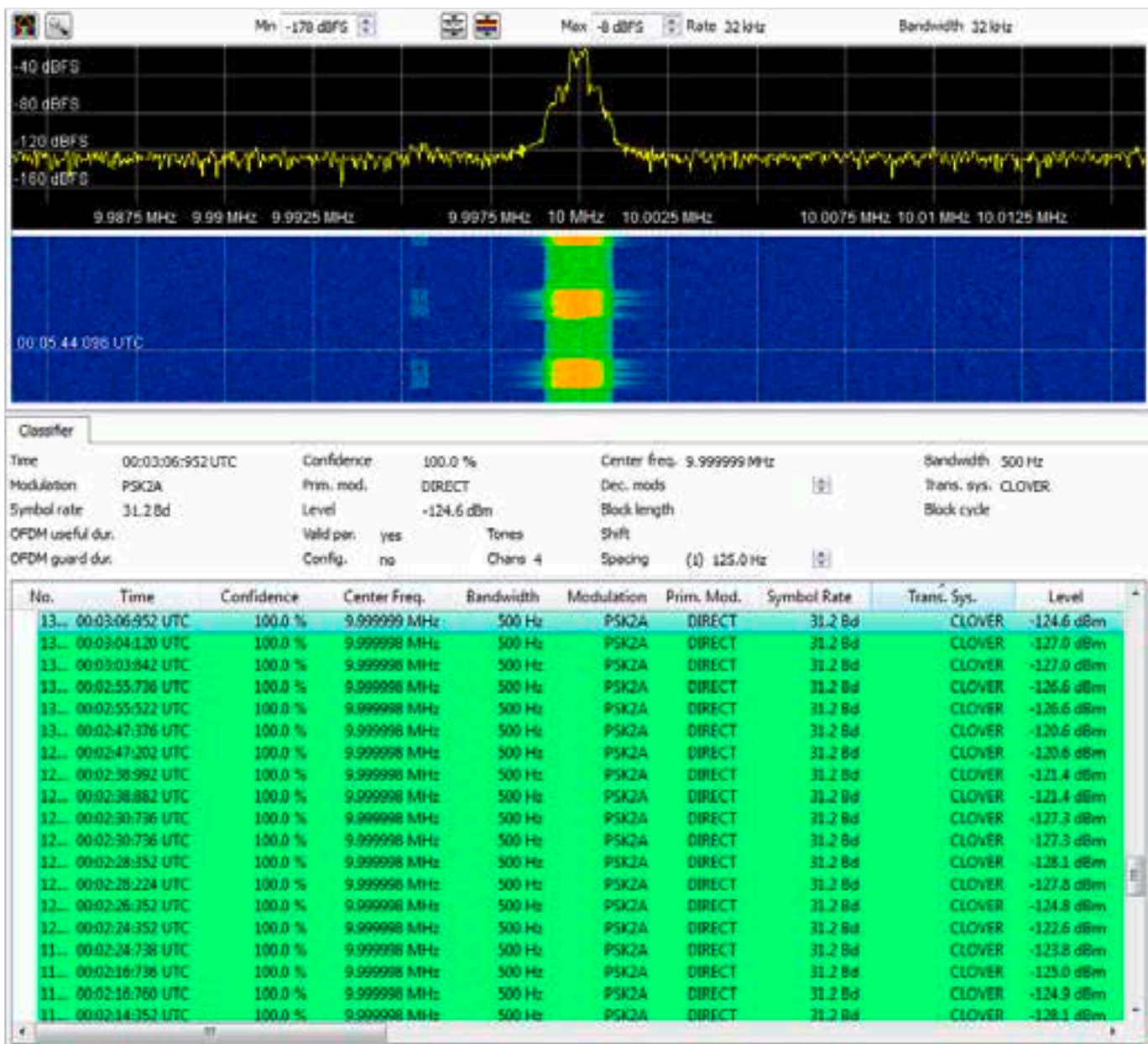

The classifier continuously measures technical signal parameters such as center frequency, bandwidth, symbol rate, modulation type and transmission system. It recognizes this signal as an HF CLOVER modem with the corresponding parameters.

Multichannel signal analysis

The typical use case in signal processing and signal analysis is to monitor a large frequency range, which covers the entire HF/VHF/UHF/SHF spectrum, as well as to continuously detect and monitor communications scenarios. Multichannel signal analysis capability that allows simultaneous monitoring of a large number of signals is essential to intercept a densely populated signal scenario and monitor all signals in the frequency ranges of interest (automatic and manual). The multichannel signal analysis solution digitally downconverts signals to simultaneously extract up to 128 HF and 32 VHF/UHF channels, with a realtime bandwidth of up to 20 MHz (HF) and 80 MHz (VHF/UHF) per receiver.

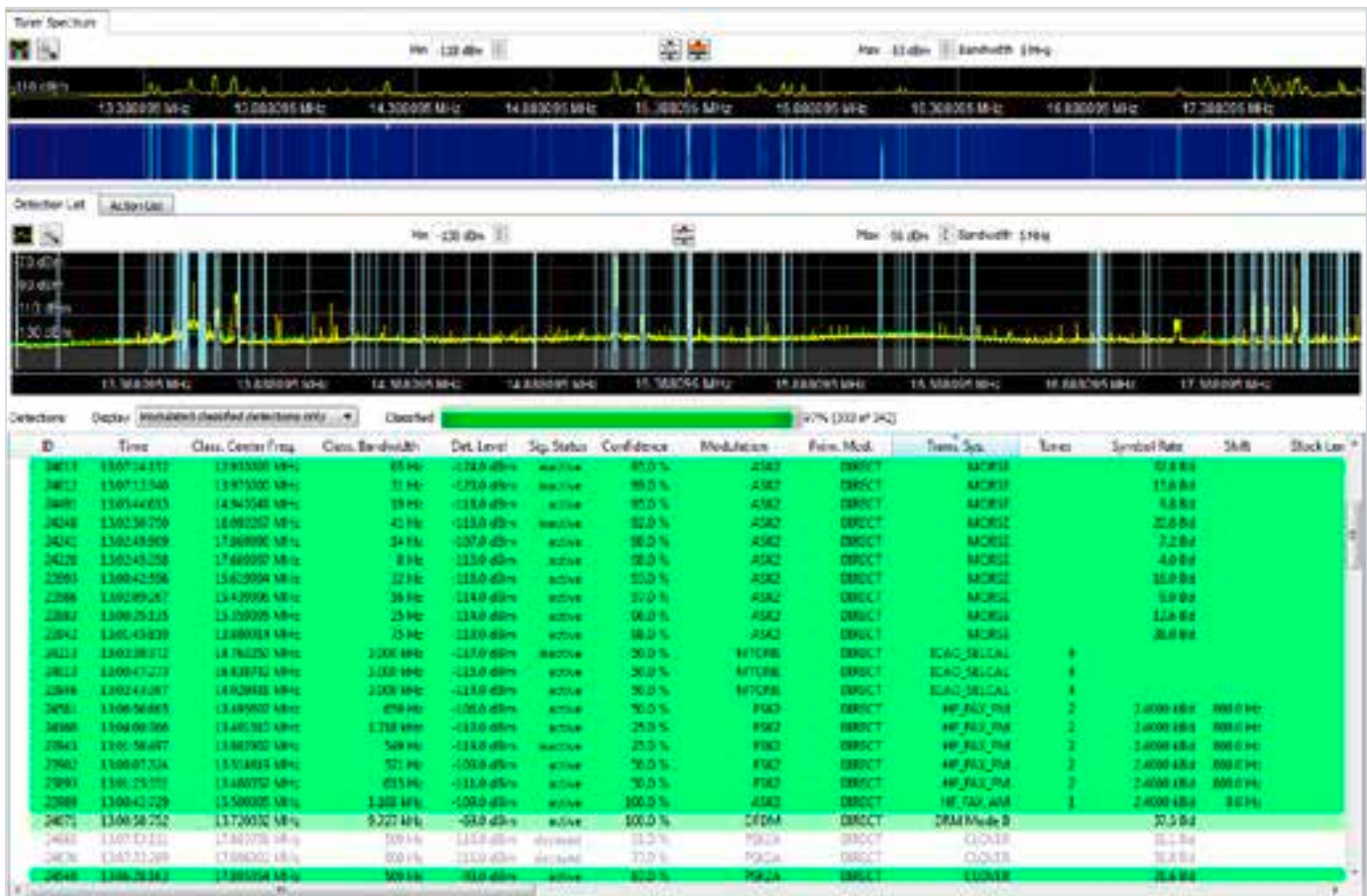

The 5 MHz wide HF signal scenario is processed with more than 100 parallel channels, classifying the technical signal parameters and the transmission system types in parallel. Multichannel signal analysis capability is essential for processing a large number of signals simultaneously in signal scenarios within large frequency ranges.

Fully automatic processing workflow

The fully automatic processing of detected signals reduces the workload of a radio monitoring operator. Mundane jobs such as waiting for a certain signal to reappear can be automated, freeing up time for other analysis tasks. Routine tasks such as monitoring a certain frequency range and recording particular known or unknown signals can also be automated. Again, this makes more time available for the operator to concentrate on more important or demanding analysis tasks.

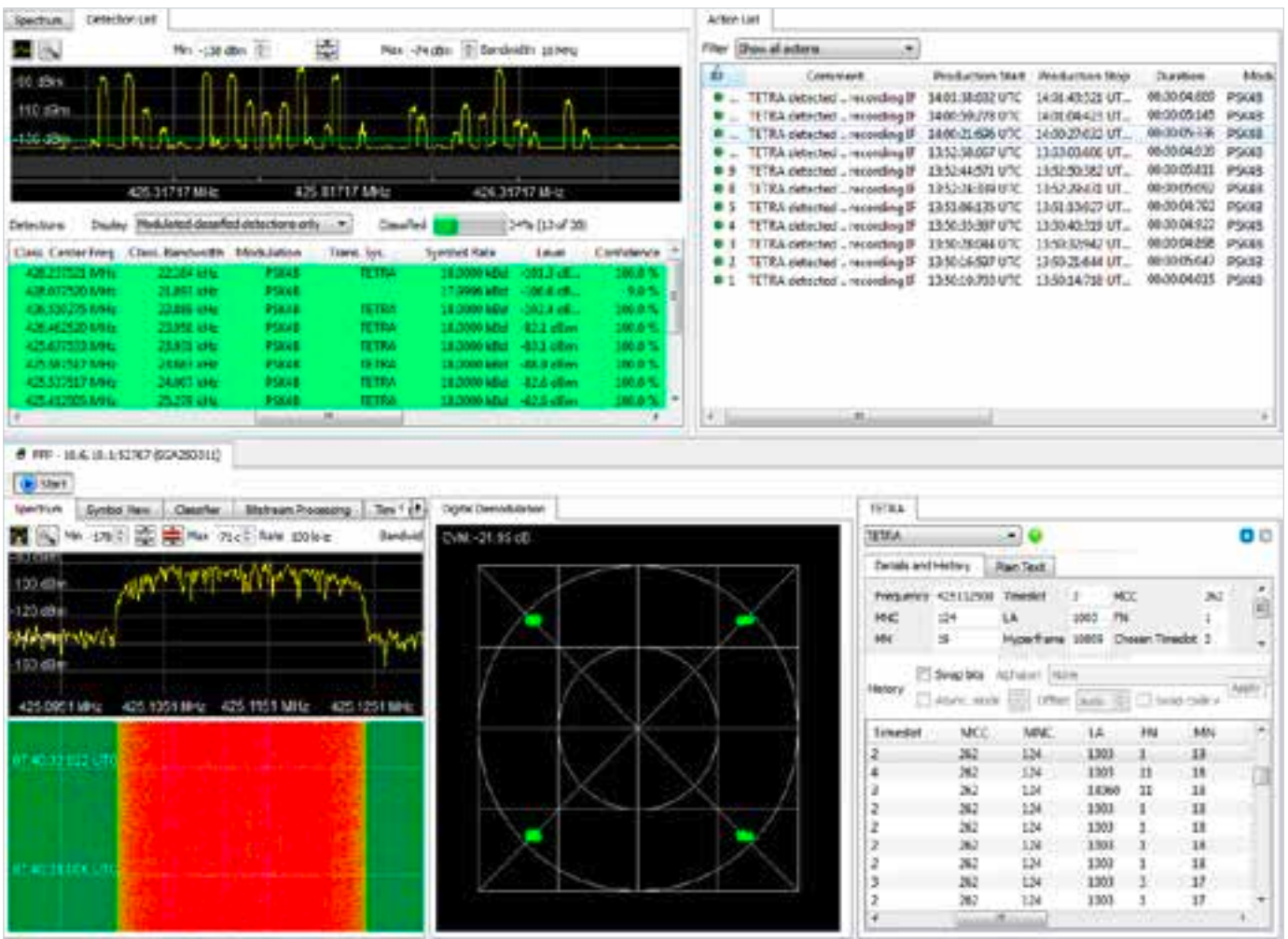

Fully automatic signal processing (e.g. content extraction, recording, notification) with user-defined rules. The action list triggered by certain information is consolidated and displayed. In this example, digital IF recording will be triggered automatically once the TETRA signal is detected. The target signal is replayed to obtain the spectrum view, digital demodulation view (constellation diagram) and decoded TETRA signal with transmission details.

Extensive transmission system library

An extensive library of transmission systems, demodulators and decoders (currently over 150 in total) enables content extraction (i.e. listening to audio, obtaining decoded texts or image files) of numerous transmission methods, including TETRA, dPMR, FACTOR III, CODAN 3012, CLOVER signals, etc.

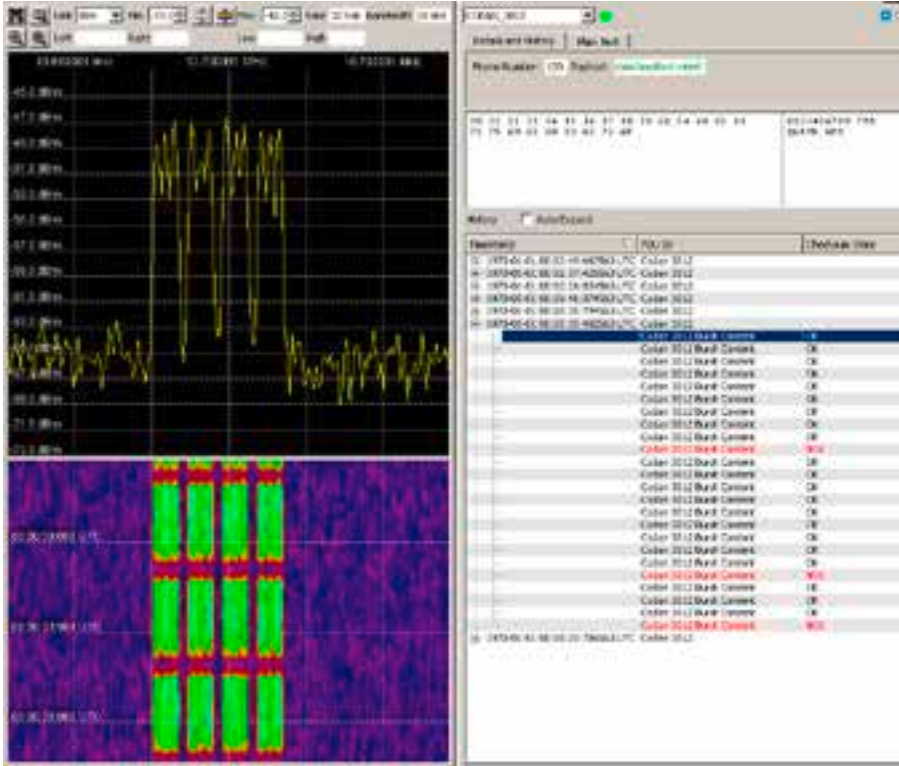

Content recovery from CODAN 3012 (above) and METEOSAT Wefax signals (below).

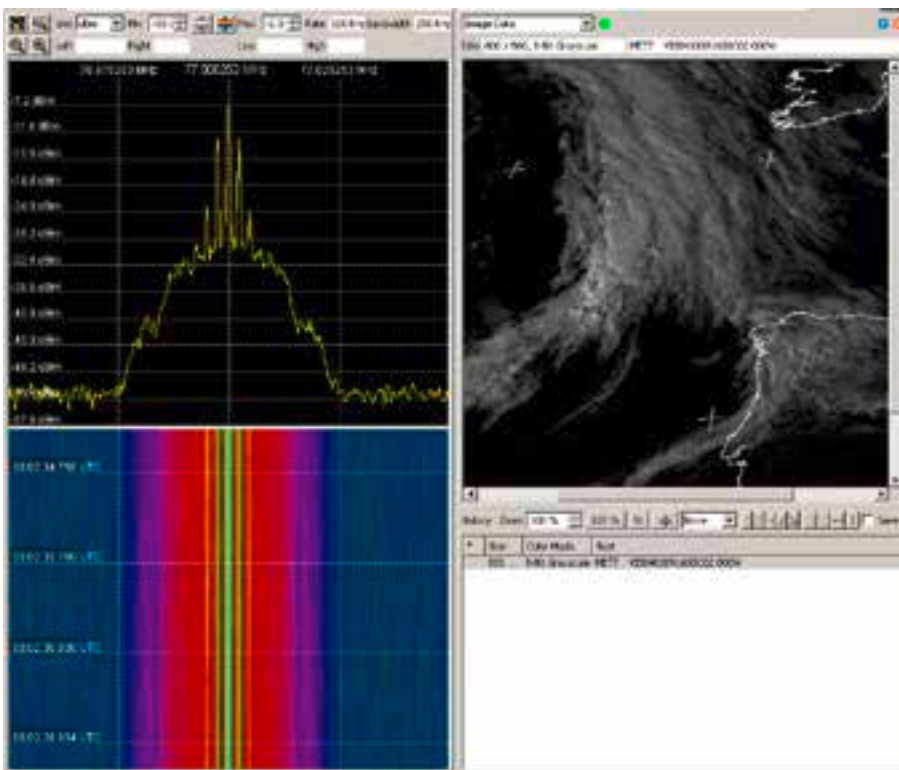

Open interfaces

To ensure flexibility, the open programming and extensibility interfaces provide the capability to integrate user-specific modules for signal processing (receiver driver for the third-party receiver, demodulator, decoder, transmission system). Plus, if users have their own GUI, the Rohde&Schwarz solution can be integrated into their platform. As a result, users can independently deploy their own expertise in solutions. The signal analysis solution has an open, documented application programming interface (API) for this purpose.

```

//! Create and send a "transmission system result" frame (text message)
int dd_send_text_data(typDDParams *ptrTypDDParams,
                    typOwnParams *ptrTypOwnParams,
                    ptypBIGTIME bigtimeTime,
                    void *voidPtrParent)
{
    char strMsgBuf[80];
    unsigned int uMsgLen, uMsgLen32Bit, uFrameSize;
    char *cDest;

    typTRANSMISSION_SYSTEM_RESULT_FRAME *ptrTextDataFrame;

    // ----- Prepare data -----
    uMsgLen = sprintf(strMsgBuf, "Configuring. Audio: %s Decimation step: %3u",
        (ptrTypDDParams->eAudioOnOff == GX_AUDIO_ON) ? "On " : "Off",
        ptrTypDDParams->uDecimation);

    // Length of the text message in bytes after 32-bit alignment
    uMsgLen32Bit = uMsgLen/pdemSIZEOF(ptypUINT);
    if(uMsgLen % pdemSIZEOF(ptypUINT))
        uMsgLen32Bit++; // there a still less than 4 chars available - you need one more 32 Bit Word

```

Open interface to integrate customer-developed signal processing modules such as demodulators, decoders and receiver drivers. The C++ interface for integrating user modules, a detailed and documented integration manual, and training packages for knowledge transfer are provided

Product portfolio

R&S® GX460/465

- is a recording/replaying device, ideal for use in signal interception systems and in combination with R&S®CA120/R&S®CA100 multichannel signal analysis and most Rohde & Schwarz receivers and direction finders:
- ▀ Sustained data transfer rate for recording baseband I/Q data with a maximum bandwidth of 80 MHz (R&S®GX465)
 - ▀ Recording of various data formats (I/Q, symbol, image, audio, FFT, etc.)
 - ▀ Various recording and replaying modes such as continuous recording
 - ▀ One-page spectrogram summary of recording
 - ▀ Multiple recordings of various data types in parallel



R&S®CA120

- is a flexible and automatic multichannel solution for detecting, classifying and processing radiocommunications signals:
- ▀ Automatic interception and monitoring of complete signal scenarios
 - ▀ High-speed signal search with the spectral shape detector
 - ▀ Powerful classifier
 - ▀ Extensive demodulators and decoders library
 - ▀ Detection of fixed frequency, burst and frequency agile short-time signals
 - ▀ Fully automatic processing of detected signals
 - ▀ Modular scalability to over 100-channel signal processing solution
 - ▀ Open interface



Recording/
replaying

Signal
analysis
applications

Signal
monitoring

Customized
modules



R&S®CA100

- is a standalone software solution for analyzing, classifying, demodulating and decoding digital and analog IF signals (up to four channels with R&S®ESMD). The software provides powerful signal analysis and signal processing functions running on a Windows PC:
- ▀ Signal acquisition and receiver control
 - ▀ Automatic search and classification of signals in a defined frequency range
 - ▀ Detection, classification, demodulation and decoding
 - ▀ Signal recording and replaying

The signal analysis workflow summarizes the necessary applications for a complete signal processing solution. It represents the comprehensive algorithms and strategies needed to successfully search for, detect, classify, process and analyze signals.

R&S®CA100IS

is an R&S®CA100 option enabling analysis of signal scenarios in line with ITU-R SM.1600:

- ▀ Measurement methods specified by the ITU-R SM.1600 recommendation
- ▀ Recognition of known or standardized methods
- ▀ Time/frequency segmentation for multisignal scenarios
- ▀ Advanced visualization
- ▀ Tools and functions for analyzing and measuring technical signal parameters such as bandwidth, symbol rate, number of tones, tone spacing, shift, modulation index, length of guard interval, number of channels, signal duration



Technical
signal
analysis

R&S®GX410

is an advanced solution for offline technical analysis of unknown or complex signal scenarios:

- ▀ Automatic and manual analysis solutions for fixed frequency, burst signals and frequency agile short-time emissions
- ▀ Hopper analysis and recombination
- ▀ Time and frequency domain signal analysis for determining technical parameters



Bitstream
analysis

R&S®CA250

is powerful software for analyzing and manipulating signals at the bitstream/symbol stream level. It can be used to analyze the characteristics of demodulated signals with unknown coding:

- ▀ Bit manipulation functions: inversion, autocorrelation, descrambling, deinterleaving, etc.
- ▀ Bitstream analysis functions: structure analysis, entropy analysis, scrambler analysis, convolutional code analysis, etc.
- ▀ Extendable alphabet decoder and support for decoder development



Knowledge transfer/training

Our motivation: to understand our users' needs and requirements, working closely together with them for knowledge transfer and training in order to provide ideal signal analysis solutions. The result of the demodulator/decoder development will be integrated back into the signal monitoring solution. We provide:

- ▀ Detailed manuals and quick start guides to help you get started
- ▀ Documented sample and base class functions for the user extensibility open interface configuration and ParamGuiStudio to create the required configuration and parameterization dialogs
- ▀ Experienced trainers



Each stage in the workflow is supported by the Rohde & Schwarz signal analysis product family. Each product is tailored to provide specific functions and applications that cover signal monitoring (online/offline), technical signal analysis, bitstream analysis and demodulator/decoder development.

R&S®CA100 PC-Based Signal Analysis and Signal Processing Software

R&S®CA100 is a standalone software solution for analysis, classification, demodulation and decoding of digital and analog IF signals. The software provides powerful signal analysis and signal processing functions and runs on a Windows PC. If connected to modern Rohde & Schwarz monitoring receivers with internal digital downconverters (DDC), e.g. R&S®ESMD, up to four signals can be processed in parallel.

R&S®CA100 provides a signal overview using a high-speed spectrum/waterfall display; it supports both the monitoring of known signals (demodulation and decoding to content level) and surveillance/search operation by automatically detecting signals of interest and performing a classification (recognition of modulation type and transmission system/code).

For complex (very dense, weak or disturbed) signal scenarios, the user can override the automatic signal processing and manually set the classifier or demodulator/decoder to the signal of interest. An additional time domain analysis function makes it possible to manually measure technical signal parameters.

The detect, search and classify application provides a fully automatic mode to monitor a frequency range, detect signals of interest, classify, demodulate, decode these signals and store the results for later processing.

Signal data (digital IF) can be recorded to the computer hard disk or external AMREC devices (e.g. R&S®GX460) and replayed for processing.

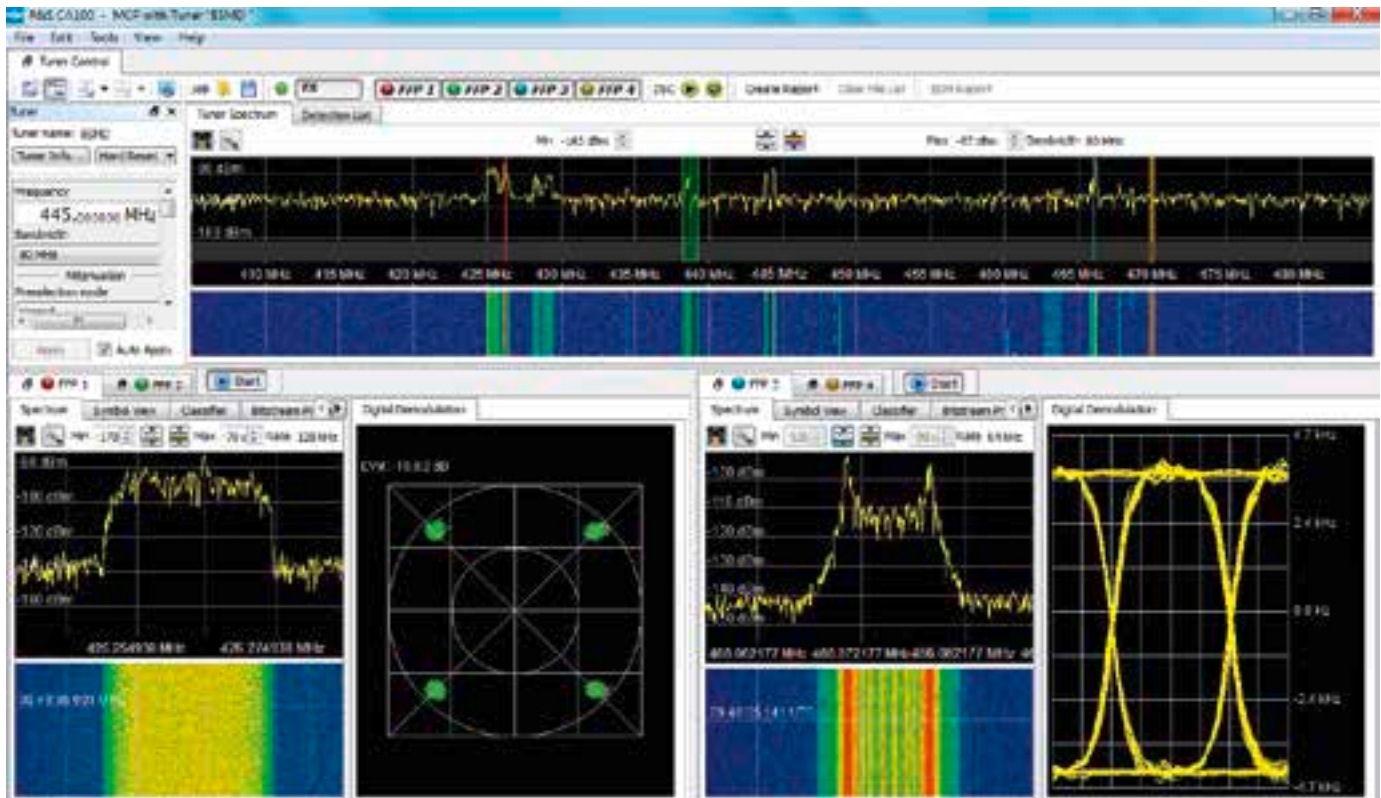

Four signals of an 80 MHz signal scenario provided by an R&S®ESMD wideband monitoring receiver are classified, demodulated and decoded in parallel.

Key facts

- Supports automatic interception and monitoring of complete signal scenarios
- Powerful classifier and extensive signal processing library with demodulators and decoders
- Configurable detection of fixed frequency and burst signals with subsequent automatic processing of detected signals (including content recovery depending on signal type)
- Modular scalability from one-channel to four-channel signal processing solution (multichannel capability available if connected to a Rohde&Schwarz monitoring receiver/digital direction finder with internal digital downconverters, e.g. R&S®ESMD/EB510/EB500/DDF255/DDF205)
- Open interface for independent extension of signal processing capabilities by the user
- Manual signal measurement in line with ITU-R SM.1600
- Signal recording and replaying to/from hard disk

Benefits and key features

- Large variety of sources for signal acquisition
 - Processing of digital IF data
 - Spectrum/waterfall representation of signal data
 - Signal recording and replaying to/from hard disk
 - Processing of multiple signals
- Quick results with automatic classification
 - Powerful R&S®AMMOS classification unit
 - Wideband classification
 - Comprehensive library of demodulators and decoders
- Demodulators and decoders for a wide range of use cases
 - Manual or automatic demodulation and decoding
 - Customer-specific decoders and demodulators
- Fast and reliable simultaneous processing of multiple signals
 - Manual parallel processing of multiple signals
 - Automatic detection of fixed frequency and burst signals for fast and dependable results
 - High performance detection of FSK2 signals
 - Detection threshold and ignoring of frequency ranges
 - Detection using a scanning receiver
- High-speed spectral shape search
 - Fast recognition of signals using spectral matching
 - Enhancement of detect, search and classify workflows using detection list filtering
 - Spectral collector and spectral detector trainer
- Reduced user workload due to automatic processing of detected signals
 - Automatic monitoring of signal scenarios
 - Fully automatic signal processing with user-defined rules via script editor
- Going into detail with manual measurements
 - Manual measurements of emission characteristics
 - Emission analysis
- Analysis of signal scenarios in line with ITU-R SM.1600
 - Technical parameters of unknown signals
 - Recognition of known or standardized methods
 - Advanced visualization
- Diverse opportunities for user-specific expansion
 - Open programming interface for integration of user-specific modules
 - Integration of a wide variety of user-programmed module types

Ordering information		
Designation	Type	Order No.
PC-Based Signal Analysis and Signal Processing Software (requires one of the following licensing options)	R&S®CA100	4102.0004.02
Licensing options		
Licensing of R&S®CA100 with USB Dongle	R&S®CA100-U	4102.0062.02
Licensing of R&S®CA100 with SD Card Dongle	R&S®CA100-S	4102.0079.02
Licensing of R&S®CA100 with Mini USB Dongle	R&S®CA100-M	4102.0085.02
Options for single-channel processing		
Processing of Digital Signals	R&S®CA100DM	4102.0091.02
Classification ¹⁾	R&S®CA100CL	4102.0104.02
Decoder Package Professional ¹⁾	R&S®CA100DEC	4102.0110.02
Decoding of PACTOR II and PACTOR III ¹⁾	R&S®CA100PIII	4102.0133.02
Decoding of CLOVER ¹⁾	R&S®CA100CV	4102.0140.02
Decoding of CODAN 3012 ¹⁾	R&S®CA100CO	4102.0156.02
Correlative Detector ¹⁾	R&S®CA100CDT	4102.0256.02
Wideband Snapshot Access ²⁾	R&S®CA100WSN	4102.0240.02
Options for multichannel processing		
Multichannel Processing	R&S®CA100MCP	4102.0179.02
Detection, Search and Classification of Fixed Frequency Signals	R&S®CA100DSC	4102.0185.02
Spectral Shape Detector ³⁾	R&S®CA100SDT	4102.0204.02
Automatic Processing of Detected Signals ³⁾	R&S®CA100AP	4102.0191.02
Options for signal analysis		
Analysis of Signal Scenarios, in line with ITU-R SM.1600	R&S®CA100IS	4102.0210.02

¹⁾ Requires R&S®CA100DM option.

²⁾ Requires R&S®CA100CL, R&S®ESMD or R&S®DDF255 with R&S®ESMD-RR/R&S®DDF255-RR option.

³⁾ Requires R&S®CA100DSC option.

Note:

Rohde&Schwarz licenses for R&S®CA100 are stored on a USB dongle, USB mini dongle or SD card. If the dongle or SD card is lost, stolen or misplaced, Rohde&Schwarz will not provide a replacement. All licenses stored on the missing device will have to be purchased again at full price. In the unlikely event that a USB dongle, USB mini dongle or SD card is corrupt or broken, it will be replaced by Rohde&Schwarz only if the defective device is returned to Rohde&Schwarz. A moderate fee will be charged for producing and sending the replacement.

All options require the R&S®CA100 base version.

R&S®CA120 Multichannel Signal Analysis Software

R&S®CA120 is a flexible and automatic multichannel solution for detecting, classifying and processing radiocommunications signals. R&S®CA120 supports a wide spectrum of applications ranging from manual signal processing and analysis of an individual signal to fully automatic recognition and processing of signals in a wideband signal scenario.

The R&S®CA120 applications run on a modular, easy-to-maintain signal processing unit architecture that is coupled with advanced Rohde&Schwarz monitoring receivers. The powerful classifier automatically determines the technical signal parameters upon request and delivers the measured parameters to the demodulator/decoder or transmission system. The content is recovered and saved for recognized signal types. Signals that are classified as unknown can be recorded digitally for more in-depth analysis.

A detect, search and classify application supports fully automatic interception and monitoring of fixed frequency and burst signals. Detected signals are measured and classified and can be automatically reported, recorded and demodulated/decoded depending on the signal type.

Multiple signals and wideband signal scenarios can be simultaneously recorded in the form of digital IF and reprocessed during subsequent replay.

Key facts

- Supports automatic interception and monitoring of complete signal scenarios
- Powerful classifier and extensive signal processing library with demodulators and decoders
- Configurable detection of fixed frequency, burst and frequency agile short-time signals with subsequent automatic processing of detected signals (including content recovery depending on signal type)
- Processing of wideband signal scenarios
 - HF: up to 20 MHz per receiver
 - VHF/UHF: up to 80 MHz per receiver
- Modular scalability from four-channel to n-channel signal processing solution (n > 100)
- Open interface for independent extension of signal processing capabilities by the user and integration into existing system solutions

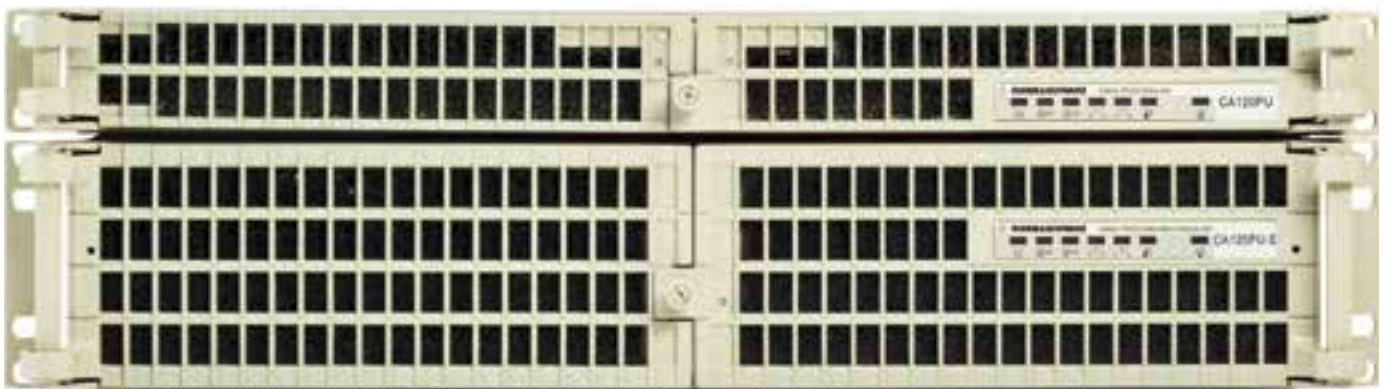

Benefits and key features

- Flexible use with signal interception and manual signal measurement
 - Processing of signals from different sources
 - Signal processing for visual presentation and audio output
 - Digital recording and replay for further use of received signals
 - Manual signal measurement for complex signal scenarios
- Automatic classification to support the user
 - Powerful classifier
 - User-specific expansion of classification capabilities
 - Wideband classification
- Extensive transmission system library
 - Manual or automatic demodulation and decoding
 - Transmission systems even for complex classes of signals
- Diverse opportunities for user-specific expansion
 - Open programming interface for integration of user-specific modules
 - Integration of a wide variety of user-programmed module types
- Fast and reliable simultaneous processing of multiple signals
 - Manual parallel processing of multiple signals, even by several users
 - Automatic detection of fixed frequency and burst signals for fast and dependable results
 - High-performance detection of FSK2 signals
 - Detection threshold and ignoring of frequency ranges
 - Detection using a scanning receiver
- Automatic analysis of frequency agile short-time signals in wideband signal scenarios
 - Detection of frequency agile short-time signals
 - Automatic profile separation
 - Online recombination of frequency agile short-time signals
- High-speed spectral shape search
 - Fast recognition of signals using spectral matching
 - Enhancement of detect, search and classify workflows using detection list filtering
 - Spectral collector and spectral detector trainer
- Reduced user workload due to automatic processing of detected signals
 - Automatic monitoring of wide frequency ranges
 - Fully automatic signal processing with user-defined rules via script editor
- Simultaneous recording or replay of multiple signals
 - Enhanced capabilities through postprocessing of recorded signals
 - Ring buffer for loss-free recording even with delayed start
 - Fast, pinpoint navigation within signal recordings
 - Systematic management of recorded signals
- Scalable architecture for optimum adaptation
 - Modular design
 - Expandable resource concept
- Hardware-accelerated multichannel signal processing
 - Multichannel digital downconversion (DDC) signal extraction from the R&S®ESMD realtime bandwidth
 - Automatic detection of fixed frequency and burst signals
- Integration into existing systems with minimal effort
 - Integration into existing systems with different interfaces
 - Advanced integration and automation in conjunction with R&S®RAMON

Ordering information			
Designation	Type	Order No.	Description
Base unit			
Multichannel Signal Analysis Software	R&S®CA120	4102.1000.02	Basic component including system services
Options for single-channel processing			
Fixed Frequency Processing	R&S®CA120FFP	4102.1069.02	Interception processing channel; IF data input from a receiver or a DDC and processing of a signal with high-resolution spectrum/waterfall, audio demodulation and manual time domain analysis
Processing of Digital Signals	R&S®CA120DM	4102.1075.02	Processing of digital signals for an R&S®CA120FFP interception processing channel; contains a library with universal demodulators
Classification	R&S®CA120CL	4102.1081.02	Automatic classification of modulation type and transmission system for an R&S®CA120FFP interception processing channel; R&S®CA120DM required
Decoder Package Professional	R&S®CA120DEC	4102.1098.02	Decoding of HF and VHF/UHF transmission systems for an R&S®CA120FFP interception processing channel; R&S®CA120DM required
Decoding of PACTOR II and PACTOR III	R&S®CA120PIII	4102.1117.02	Decoding of PACTOR II and PACTOR III signals for an R&S®CA120FFP interception processing channel; R&S®CA120DM required
Decoding of CLOVER	R&S®CA120CV	4102.1123.02	Decoding of CLOVER2 and CLOVER2000 signals for an R&S®CA120FFP interception processing channel; R&S®CA120DM required
Decoding of CODAN3012	R&S®CA120CO	4102.1130.02	Decoding of CODAN3012 signals for an R&S®CA120FFP interception processing channel; R&S®CA120DM required
Correlative Detector	R&S®CA120CDT	4102.1223.02	High-performance detection of FSK2 signals; R&S®CA120DM required
Wideband Snapshot Access	R&S®CA120WSN	4102.1217.02	Provides access to the wideband snapshot buffer of the R&S®ESMD/R&S®DDF255 for online wideband classification; R&S®CA120CL required; R&S®ESMD-RR / R&S®DDF255-RR required
Options for multichannel processing			
Multichannel Processing	R&S®CA120MCP	4102.1152.02	IF data input from a receiver; computation of data for spectrum/waterfall display and extraction of a maximum of 32 signals with DDCs; processing of extracted signals with R&S®CA120FFP interception processing channels
Detection, Search and Classification of Fixed Frequency Signals	R&S®CA120DSC	4102.1169.02	Automatic detection of fixed frequency signals; required for automatic classification using R&S®CA120CL
Spectral Shape Detector	R&S®CA120SDT	4102.1181.02	High-speed spectral shape search; R&S®CA120DSC required
Automatic Processing of Detected Signals	R&S®CA120AP	4102.1175.02	Option for R&S®CA120DSC; automatic processing (demodulation, decoding, recording) of detected signals
Detection of Short-Time Signals	R&S®CA120ST	4102.1198.02	Detection of frequency agile short-time signals; R&S®CA120MCP required
Profile Separation	R&S®CA120PS	4098.5224.02	Separation of multiple short-time emitters and matching to predefined profiles of frequency agile short-time transmission systems; R&S®CA120ST required
Online Recombination	R&S®CA120OR	4098.5218.02	Online recombination of frequency agile short-time signals for further processing (for example I/Q recording or demodulation); R&S®CA120PS required
Recording and Replay	R&S®CA120REC	4102.1200.02	Recording and replay of a frequency range with a max. bandwidth of 10 MHz
Hardware-accelerated signal processing with the R&S®ESMD			
DDC Signal Extraction	R&S®ESMD-DDCE	4079.7760.02	Digital downconversion signal extraction
High-Resolution Panorama Spectrum	R&S®ESMD-HRP	4079.7902.02	Supports detection of fixed frequency signals
Hardware-accelerated signal processing with the R&S®DDF255			
DDC Signal Extraction	R&S®DDF255-DDCE	4079.7760.03	Digital downconversion signal extraction
High-Resolution Panorama Spectrum	R&S®DDF255-HRP	4079.7902.03	Supports detection of fixed frequency signals
Hardware options			
Signal Processing Unit incl. Signal Storage	R&S®CA120PU-S	4102.1317.02	
Signal Processing Unit	R&S®CA120PU	4102.1298.02	

In addition to the R&S®CA120 multichannel signal analysis software, a complete R&S®RAMON system configuration requires additional components such as antennas, monitoring receivers, interception workstation computers, R&S®RAMON software licenses and central R&S®RAMON IT components. For more details, see the R&S®RAMON product brochure.

Note: Rohde & Schwarz licenses for R&S®CA120 are stored on a USB dongle. In the event of a dongle being lost, stolen or misplaced, Rohde & Schwarz will not provide a replacement. All licenses stored on the missing device will have to be purchased again at full price. In the unlikely event that a USB dongle is corrupt or broken, it will be replaced by Rohde & Schwarz only if the defective device is returned to Rohde & Schwarz. A moderate fee will be charged for producing and sending the replacement.

R&S®GX460

Digital Wideband Storage Device

The compact, lightweight R&S®GX460 (AMREC) is a low-power consumption device that is ideal for use in mobile signal interception systems and in combination with the R&S®AMMOS GX400 VXI-based monitoring solution, R&S®CA120 multichannel signal analysis and with most Rohde & Schwarz receivers and direction finders.

The R&S®GX460 is the ideal solution when there is insufficient time or resources for a live scenario. Recorded signals can either be replayed through a suitable receiver or direction finder, or can be exported as a file for offline analysis, e.g. with the R&S®GX410 AMLAB signal analysis software or the R&S®CA100 PC-based signal analysis and signal processing software. Recordings can be controlled, and existing recordings can be selected and replayed via R&S®RAMON.

The R&S®GX460 can be equipped with either a hard disk drive (HDD) or a solid-state drive (SSD). The storage medium is easily removed for transportation or for security reasons. Equipped with a solid-state drive, the R&S®GX460 is ideal for mobile applications. Equipped with a hard disk drive, the R&S®GX460 is ideal for stationary applications.

Key facts

- ▮ Sustained data transfer rate for recording baseband I/Q data with a maximum bandwidth of 10 MHz or 40 MHz
- ▮ Available in a non-mobile version with HDDs for stationary applications
- ▮ Available in a mobile version with SSDs for use in vehicles
- ▮ Up to 2 Tbyte of removable storage
- ▮ Recording of various data formats (symbol, image, audio, FFT, etc.)
- ▮ Various recording and replaying modes, such as continuous recording
- ▮ Spectrum overview

Benefits and key features

Ideal for mobile applications

- ▮ Easy integration into mobile solutions
- ▮ Easy-to-exchange storage medium

Compact data recorder with removable storage medium

Compact, 3 HU, ½ 19" format

The R&S®GX460 is a compact digital data recording and replaying device. Its format (3 HU, ½ 19") facilitates rackmounting together with Rohde & Schwarz compact receivers, such as the R&S®EB500 monitoring receiver. The stainless steel frame and solid-state storage medium make the R&S®GX460 suitable for operation under the extreme conditions encountered in mobile operations. The storage medium is simple to insert and remove, making it easy to exchange data between mobile and fixed stations.



Recording and replaying

Depending on the configuration and the type of receiver or direction finder used, the R&S®GX460 is able to record scenarios that can be replayed later using the receiver or direction finder. The storage capacity is only limited by the capacity of the storage medium used. A scenario can be replayed repeatedly (loop mode).

Network interface

With a 1 Gbit Ethernet interface, the R&S®GX460 can be used for recording and replaying scenarios with a bandwidth of up to 10 MHz and for controlling the device. Additionally, the R&S®GX460 can be configured with the following: 10 Gbit Ethernet (either electrical or optical), data transfer for the R&S®ESMD or R&S®DDF255; the maximum data transfer is sufficient to handle scenarios with up to 40 MHz bandwidth.

Control interface

The R&S®GX460 is controlled via the 1 Gbit Ethernet interface. Control interface commands supported by the R&S®GX460 include:

- Storage status query (free/used storage space)
- Query list of recordings
- Tagging of recordings with comments
- History function for facilitating the setting of comments for recordings in relation to time stamps
- Export and import of recordings using file transfer protocol (FTP) or via Windows (SMB) network share
- Deleting of specific recordings
- Attachment of a write-protect tag to specific recordings
- Navigation in large recordings
- Built-in test (BIT) performance of the power-up procedure and consistency check
- Query of faults log file: faults are also sent via the remote interface

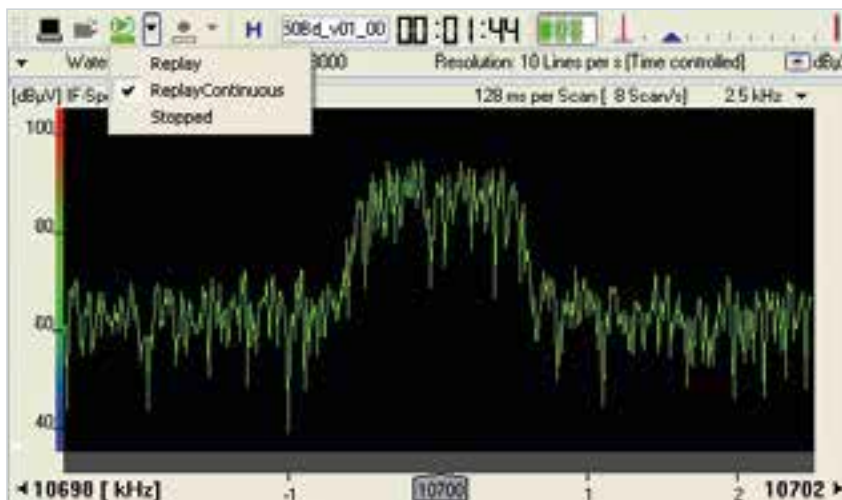

IF recording/replay control with R&S®RAMON.

Ordering information		
Designation	Type	Order No.
Base unit (delivered with accessories such as power cable, manual)		
Digital Wideband Storage Device, base unit; for recording and replaying scenarios up to 10 MHz bandwidth; RAMON AMREC manager included	R&S®GX460	1513.4600.80
Storage medium (one storage medium per device)		
Hard Disk Drive (HDD), 2 Tbyte storage capacity	R&S®GX460-HDD	4094.8106.20
High-Speed, Rugged Solid-State Drive (SSD), 1.9 Tbyte storage capacity	R&S®GX460-SSD	4094.8112.20
Interface		
Option for recording and replaying scenarios with up to 40 MHz bandwidth; one 10 Gbit network interface card with software and R&S®GX460-CCG option included	R&S®GX460-10G	4094.8306.02
Auxiliary equipment		
DC Power Supply, including power cable: 10 V to 30 V DC, 200 VA	R&S®PSDC-B200	1513.4617.02
Copper Cable, for 10 Gbit and two transceivers, length: 5 m	R&S®GX460-CCG	4094.8635.02
Optical Cable, for 10 Gbit and two optical transceivers, length: 20 m	R&S®GX460-OCG	4094.8641.02

R&S®GX465

Digital Wideband Storage Device

The R&S®GX465 (AMREC) is a recording/replaying device, ideal for use in signal interception systems and in combination with the R&S®AMMOS GX400 VXI-based monitoring solution, R&S®CA120 multichannel signal analysis and most Rohde & Schwarz receivers and direction finders.

The R&S®GX465 is the ideal solution when there is insufficient time or resources for a live scenario. Recorded signals can either be replayed or exported as a file for offline analysis, e.g. with the R&S®GX410 AMLAB signal analysis software or the R&S®CA100 PC-based signal analysis and signal processing software. Recordings can be controlled, and existing recordings can be selected and replayed via R&S®RAMON.

The R&S®GX465 is equipped with solid-state drives (SSD). The storage medium is easily removed for transportation or for security reasons.

Key facts

- Sustained data transfer rate for recording baseband I/Q data with a maximum bandwidth of 80 MHz
- Recording of various data formats (I/Q, symbol, image, audio, FFT, etc.)
- 7.6 Tbyte of removable storage
- Various recording and replaying modes such as continuous recording
- One-page spectrogram summary of recording
- Multiple recordings of various data types in parallel

Benefits and key features

Compact data recorder with removable storage medium

Compact, 2 HU, 19" format

The R&S®GX465 is a compact digital data recording and replaying device. Its format (2 HU, 19") facilitates rackmounting together with Rohde & Schwarz compact receivers, such as the R&S®ESMD wideband monitoring receiver. The storage medium is simple to insert and remove, making it easy to exchange data between mobile and fixed stations.

Recording and replaying

Depending on the configuration and the type of receiver or direction finder used, the R&S®GX465 is able to record scenarios that can be replayed later. A scenario can be replayed repeatedly (loop mode).

Network interface

With a 1 Gbit Ethernet interface, the R&S®GX465 can be used for recording and replaying scenarios with a bandwidth of up to 10 MHz and for controlling the device. Additionally, the R&S®GX465 can be used with 10 Gbit Ethernet (either electrical or optical), data transfer for the R&S®ESMD wideband monitoring receiver or the R&S®DDF255 digital direction finder. The maximum data transfer is sufficient to handle scenarios with up to 80 MHz bandwidth.



Control interface

The R&S®GX465 is controlled via the 1 Gbit Ethernet interface. Control interface commands supported by the R&S®GX465 include:

- Storage status query (free/used storage space)
- Query list of recordings
- Tagging of recordings with comments
- History function for facilitating the setting of comments for recordings in relation to timestamps
- Export and import of recordings using file transfer protocol (FTP) ¹⁾
- Deleting of specific recordings
- Attachment of a write-protect tag to specific recordings
- Navigation in large recordings
- Built-in test (BIT) during power-up procedure and consistency check

¹⁾ Supported by FTP commands.

Easy-to-exchange storage medium

The R&S®GX465 uses memory packs that can be easily exchanged to facilitate data interchange between stations (e.g. between mobile and fixed stations).

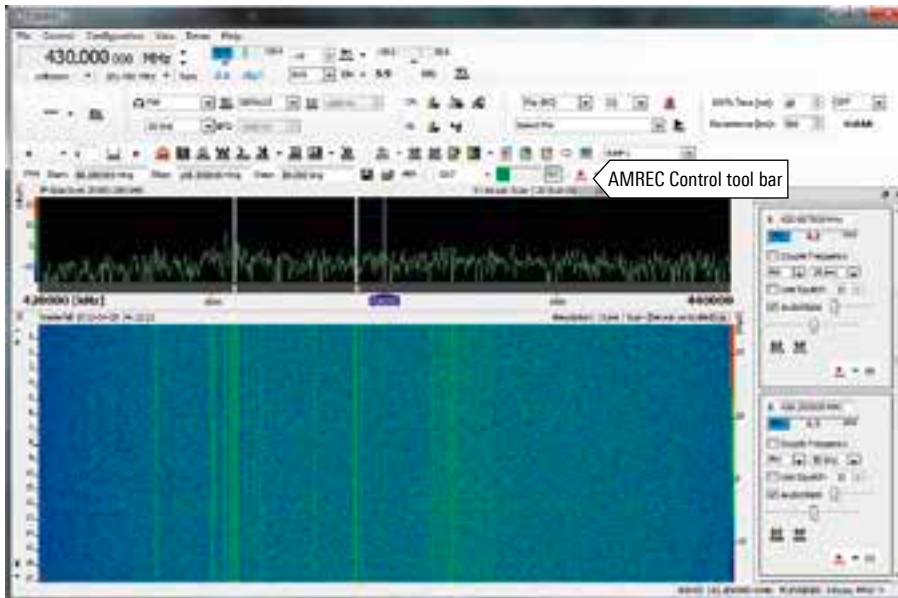

IF recording/replaying control with R&S®ESMD.

Ordering information		
Designation	Type	Order No.
Base unit (delivered with accessories such as power cable, manual)		
Digital Wideband Storage Device, for recording and replaying scenarios up to 80 MHz bandwidth with 7.6 Tbyte solid state drive (SSD); R&S®RAMON basic AMREC manager software included	R&S®GX465	4100.4002.03
Auxiliary equipment		
Copper Cable, for 10 Gbit and two transceivers, length: 5 m	R&S®GX460-CCG	4094.8635.02
Optical Cable, for 10 Gbit and two optical transceivers, length: 20 m	R&S®GX460-OCG	4094.8641.02

R&S®GX410

R&S®AMLAB Signal Analysis Software

The R&S®GX410 is a system for the technical analysis of unknown or complex signal scenarios. It provides solutions for conventional fixed-frequency emissions as well as for the investigation of burst transmissions and frequency hopping (FH) radios.

Key facts

- Digital IF (complex baseband) signal snapshot processing in connection with the R&S®GX400 sensor group, delivering a bandwidth of up to 20 MHz (HF and VHF/UHF) and unlimited bandwidth from other sources (e.g. R&S®AMREC or WAV format)
- Signal extraction from the wideband signal record using digital downconversion (DDC)
- Time and frequency domain signal analysis for determining technical parameters
- Automatic recognition of modulation parameters including bitstream classification
- Comprehensive library of demodulators and decoders
- Online recombination of frequency agile short-time emissions
- Analog IF output

Benefits and key features

- Graphical user interface for controlling all analysis functions
 - Spectrogram showing an overview of the complete signal sample
 - Time domain analysis for selected emissions
 - Case-sensitive controls for the R&S®GX410 processing steps (signal acquisition, detectors, demodulators, decoders, etc.)
 - Navigation center showing all signal samples and calculated analysis results
- Large variety of sources for signal acquisition
 - Processing of recorded digital signal data
 - Signals provided by sensors
 - Calculation of signal-adapted spectrograms
 - Selection of emissions of interest
- Automatic signal detection for fast and reliable results
 - Wideband signal sample investigation
 - Detected emissions listed in a table and highlighted in the spectrogram
- Assisting the user through automatic classification, demodulation and decoding
 - Powerful R&S®AMMOS classification unit
 - Segmentation and modulation analysis
 - Comprehensive library of demodulators and decoders
- Detailed manual modulation analysis
 - In-depth modulation analysis with measurement cursors in zoomable spectrogram
 - Using automatic and manual measurement together
- Analysis of short-time signals
 - Automatic detection algorithm
 - Identifying different kinds of emitters in a complex scenario
 - Evaluation of detected emissions for short-time signals

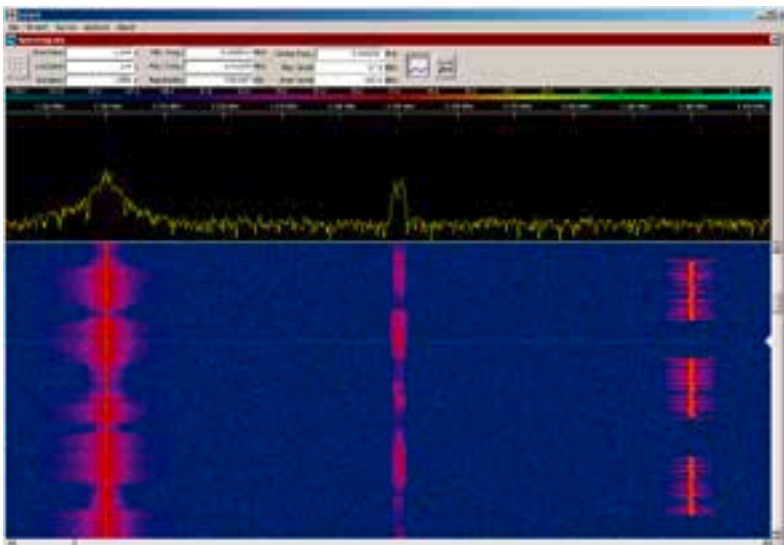

Zooming to emissions of interest.

- Online recombination of frequency agile short-time emissions
 - Realtime technical analysis using R&S®GX413OR
 - Combined input from several receivers
 - Detection and extraction of frequency agile short-time emissions
 - Separation and classification of frequency agile short-time emissions
 - Profile recognition
 - Recombination of frequency agile short-time emissions
 - Signal demodulation/decoding using the R&S®GX410 demodulator library
- Bitstream analysis (using R&S®CA250)
 - Display of bitstream in different representations
 - Large set of bitstream analysis functions
 - Powerful tool for code identification
- System integration
 - Use as standalone system
 - Use with R&S®AMMOS automatic production system
 - Optional D/A converter board



R&S®GX410 with recommended R&S®AMLAB workstation.

Ordering information		
Designation	Type	Order No.
Base units		
R&S®AMLAB Signal Analysis Software (R&S®GX410 application base software, including signal import, manual measurement of modulation parameters and analog demodulation)	R&S®GX410	4063.9681.02
R&S®AMLAB Workstation	R&S®GX410WS	4063.9869.02
Options		
Control of HF VXI Wideband Receivers (requires R&S®GX400 sensor group and R&S®GX410AR)	R&S®GX410HF	4063.0013.03
Control of VHF/UHF VXI Wideband Receivers (requires R&S®GX400 sensor group and R&S®GX410AR)	R&S®GX410VU	4063.0071.03
R&S®AMREC Control, for recording continuous IF on R&S®GX425 and import from R&S®GX425	R&S®GX410AR	4063.9930.02
D/A Converter Board and Control Software (requires R&S®GX410WS)	R&S®GX410DA	4063.9969.02
Technical and Statistical Analysis of Short-Time Signals	R&S®GX410ST	4069.4569.02
Automatic HF and VHF/UHF Modulation Analysis	R&S®GX413MA	4069.4317.02
HF and VHF/UHF System and Code Recognition (bitstream classification) (requires R&S®GX413MA)	R&S®GX413SR	4069.4498.02
HF and VHF/UHF Demodulation	R&S®GX413DM	4069.4430.02
HF and VHF/UHF Decoding (requires R&S®GX413DM)	R&S®GX413DC	4069.4552.02
Expanded Digital Civil HF Communications (requires R&S®GX413DC)	R&S®GX413DC-C	4069.4517.02
Expanded HF and VHF/UHF Decoding Capability (requires R&S®GX413DC)	R&S®GX413DC-E	4069.4575.02
Expanded CODAN3012 Decoding Capability (requires R&S®GX413DC)	R&S®GX413DC-CO	4069.4598.02
System Integration, including order management, reporting, system resources	R&S®GX410SY	4069.4630.02
Software Option for R&S®GX410, recombination of frequency agile short-time emissions, online (requires R&S®GX413RC and R&S®GX400; R&S®GX425 optional)	R&S®GX413OR	4069.4652.02
Software Option for R&S®GX410, hardware-supported recombination of frequency agile short-time emissions, offline (requires R&S®GX400 and R&S®GX425)	R&S®GX413RC	4069.4623.02

R&S®CA250 Bitstream Analysis

In the field of technical analysis of modern communications signals, the ability to analyze the characteristics of demodulated signals with unknown codings is of major importance. In addition to various symbol stream/bitstream representations, R&S®CA250 provides a large number of powerful analysis algorithms and bitstream manipulation functions.

By selectively using these tools, the user can obtain technical data from the unknown bitstream. This data provides information about the type and content of the analyzed signal. Ideally, it is possible to resolve all aspects of the unknown code, thereby allowing the user to program a specific decoder for the unknown signal (e.g. by using the R&S®GX400ID decoder development environment).

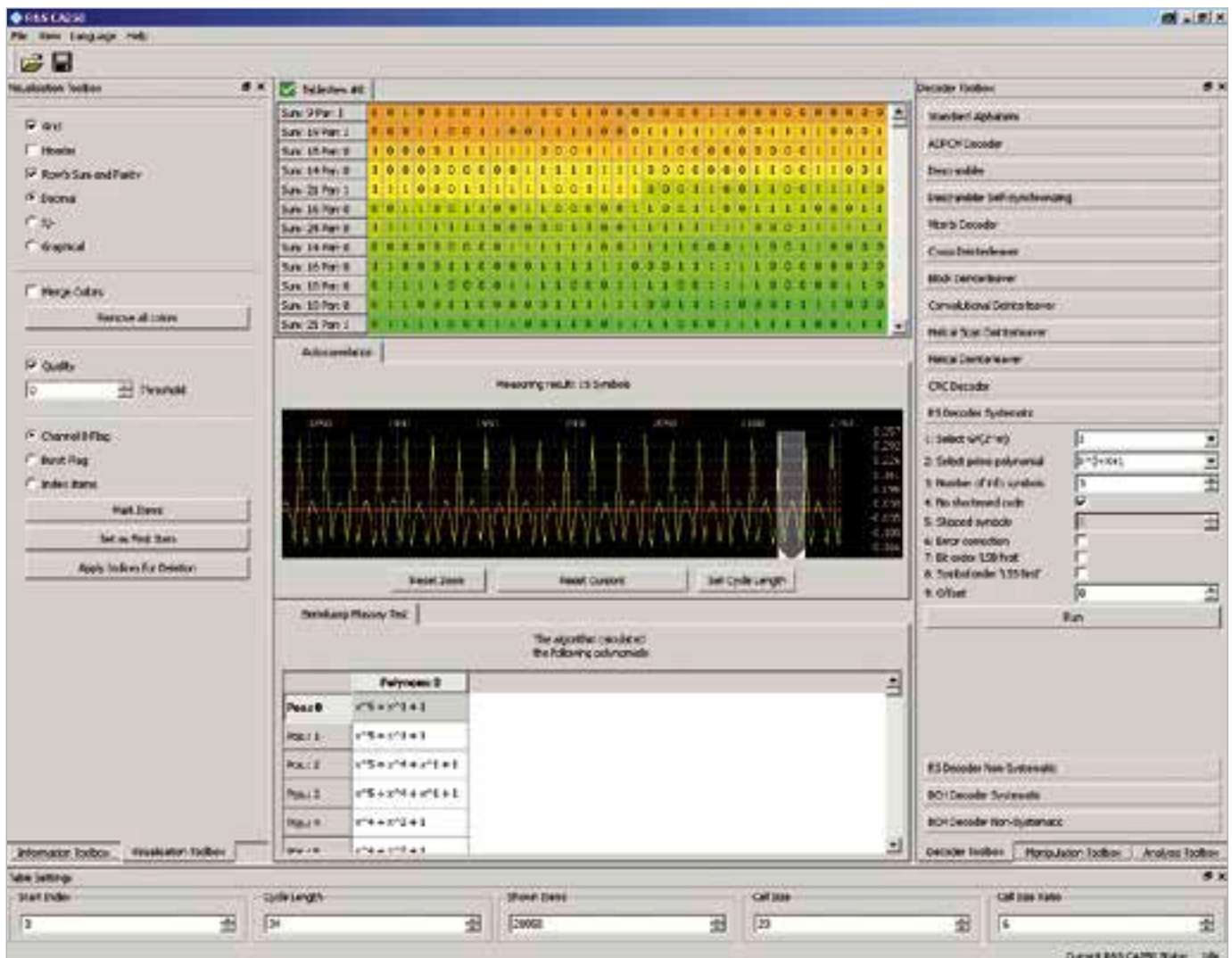

R&S®CA250 operating window.

Benefits and key features

- Versatile data import and symbol stream/bitstream representation
 - Import of various symbol stream/bitstream formats
 - Symbol-to-bit mapping and bitstream representation as 0/1 and –/X representation as well as graphical visualization
- Versatile bitstream analysis functions
 - Structure analysis
 - Statistical methods
- Advanced code analysis functions
 - Automatic recognition of channel codings (convolutional, Reed-Solomon codes, etc.)
 - Manual expert analysis tools
- Wide variety of processing functions for channel-coded bitstreams
 - Standard manipulation such as deletion, inversion, multiplexing and demultiplexing
 - Complex bitstream processing methods such as descrambling, deinterleaving
 - Processing of channel coding (convolutional, Reed-Solomon and other codes)
- Payload analysis and processing
 - Automatic detection of typical payload structures
 - Various alphabets
 - Digital voice codecs
 - Processing of compressed data
- Automation, extensibility and versatility
 - Integration of user-specific algorithms into the R&S®CA250 operation sequences
 - Programmable script control for performing automatic analysis sequences
 - Various user-configurable and extensible functions

Ordering information		
Designation	Type	Order No.
Bitstream Analysis, including bitstream representation and bitstream manipulation	R&S®CA250	4076.5009.03
Licensing option		
Licensing of R&S®CA250 with USB Dongle	R&S®CA250-U	4101.3039.02
Licensing of R&S®CA250 with SD Card Dongle	R&S®CA250-S	4101.3045.02
Licensing of R&S®CA250 with Mini USB Dongle	R&S®CA250-M	4101.3051.02
Options		
Extended Bitstream Analysis and Decoding	R&S®CA250-E	4076.5180.02
Professional Bitstream Analysis and Decoding (requires R&S®CA250-E)	R&S®CA250-P	4076.5196.02
Code Analysis (requires R&S®CA250-P)	R&S®CA250-CA	4076.5221.02
Payload Analysis	R&S®CA250-PA	4076.5215.02
Development Edition	R&S®CA250-D	4076.5238.02
Additional options		
Upgrade Package to version ≥ 04.00 (contact Rohde & Schwarz for more information) ¹⁾	R&S®CA250UP	4076.5244.02

¹⁾ Older R&S®CA250 releases with version < 04.00 have to be upgraded before all features described in this brochure can be used. To upgrade, the old USB licensing dongle has to be returned to Rohde&Schwarz and will be replaced with R&S®CA250-U, R&S®CA250-S or R&S®CA250-M.

Note:

Rohde&Schwarz licenses for R&S®CA250 are stored on a USB dongle, USB mini dongle or SD card. If the dongle or SD card is lost, stolen or misplaced, Rohde&Schwarz will not provide a replacement. All licenses stored on the missing device will have to be purchased again at full price. In the unlikely event that a USB dongle, USB mini dongle or SD card is corrupt or broken, it will be replaced by Rohde&Schwarz only if the defective device is returned to Rohde&Schwarz. A moderate fee will be charged for producing and sending the replacement.

All options require the R&S®CA250 base version.

R&S®TPA Technical Pulse Analysis

The R&S®TPA technical pulse analysis software offers an extensive set of detection, visualization and measurement tools for analyzing pulsed and FMCW¹⁾ radar signals.

R&S®TPA supports developers in verifying radar systems, collectors in preparing initial signal analyses and analysts in analyzing and describing complex signals in detail.

R&S®TPA processes continuously recorded digital I/Q data and pulse descriptor words (PDW). PDWs contain the time of arrival (TOA), center frequency, bandwidth, pulse duration, amplitude and modulation of signals detected by the sensor. When evaluating I/Q recordings, R&S®TPA can be used to detect signals and output PDWs.

¹⁾ FMCW: frequency-modulated continuous-wave.

R&S®TPA offers a time domain display as well as a spectrum and spectrogram display for analyzing time/frequency behavior. During PDW analysis, one or more PDW parameters are displayed simultaneously as a function of time, enabling the user to analyze individual pulses (intra-pulse analysis) and characteristics of the pulse sequence (interpulse analysis).

A wide variety of filters are available for deinterleaving several signals and different operating modes in a recording. The results are summarized in easy-to-read signal profiles. The analysis software can control basic functions of Rohde&Schwarz acquisition sensors and recording instruments.

Key facts

- Offline analysis of radar signals without bandwidth limitations
- Interpulse and intrapulse analysis
- Deinterleaving of complex scenarios
- Integrated basic control of acquisition sensors and recording instruments

Benefits and key features

- Modular functions
 - R&S®TPA technical pulse analysis
 - R&S®TPA-IQ digital I/Q processing
 - R&S®TPA-AIP automatic interpulse analysis
 - R&S®TPA-FA frame analysis

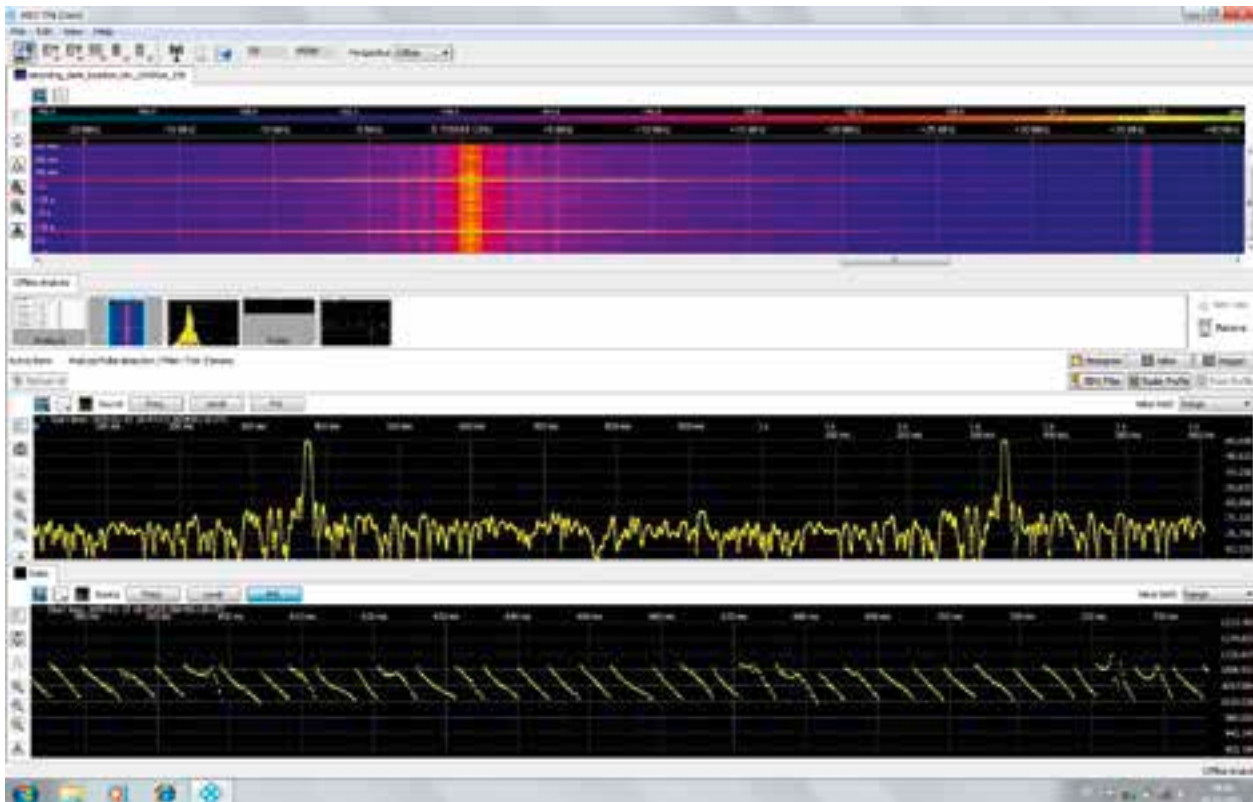

- ▮ Flexible and task-related user interface
 - Work steps in the project tree
 - Analysis views in pictograms
 - Detailed result logging
 - Control of acquisition sensors and recording instruments
- ▮ Processing of data from different sources
 - Data from Rohde&Schwarz sensors
 - Data from digital signal recordings
- ▮ Analysis in the spectrogram and time domain
 - Spectrograms with different levels of detail
 - Convenient time domain analysis
- ▮ Automatic detection of radar signals
 - Tabular display of data
- Generation of PDWs
- Generation of IQDWs
- Detection of CW and LPI radar signals
- ▮ Interpulse analysis of radar signals
 - Pulse video analysis
 - Statistical histogram analysis
 - Time raster and stagger analysis
 - Autocorrelation
 - Corridor plot
- ▮ Intrapulse analysis
 - Generation of pulse profiles
- ▮ Deinterleaving of radar signals
 - Filterable analysis table
 - Graphical generation of filters
 - Creation of radar profiles

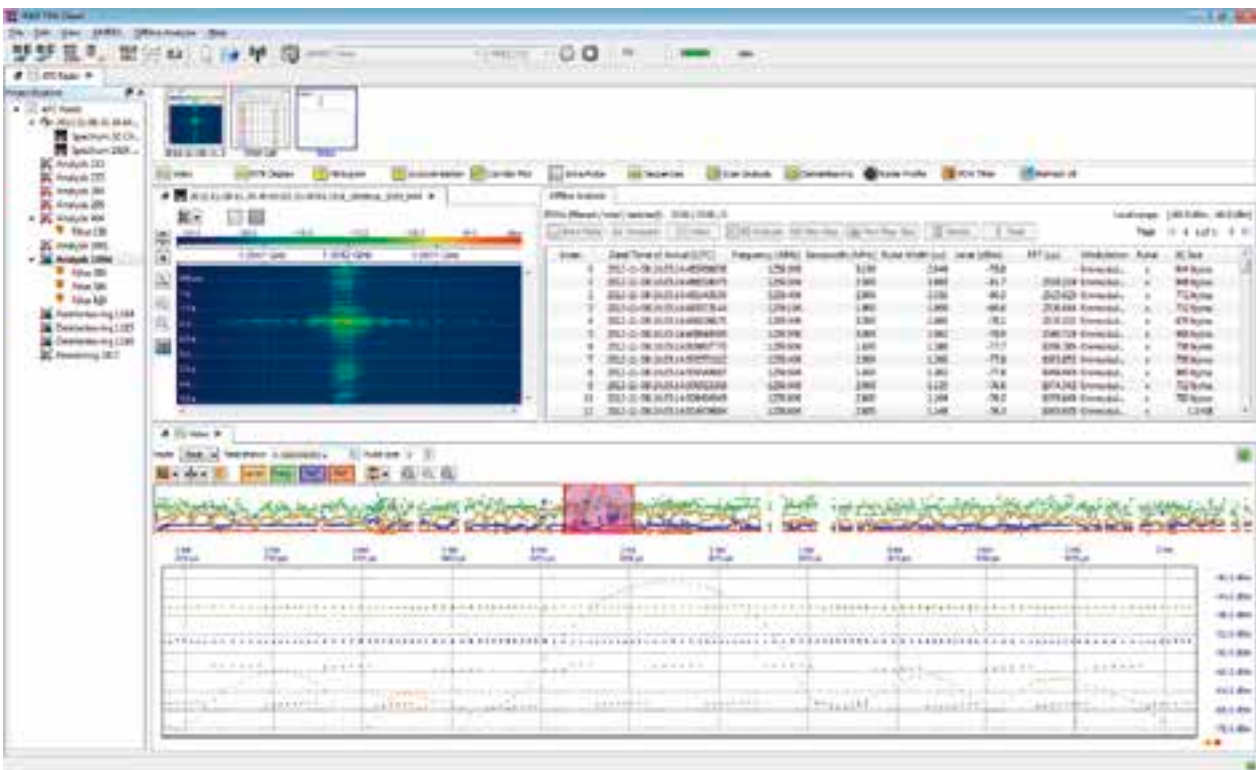

R&S®TPA GUI with project tree, RF versus time spectrogram, detected pulses list and interpulse analysis scattergram of the selected radar signal.

Ordering information		
Designation	Type	Order No.
Technical Pulse Analysis	R&S®TPA	4080.1004.02
Licensing options		
Licensing of R&S®TPA with USB Dongle	R&S®TPA-U	4080.1191.02
Licensing of R&S®TPA with SD Card Dongle	R&S®TPA-S	4080.1204.02
Licensing of R&S®TPA with Mini USB Dongle	R&S®TPA-M	4080.1210.02
Other options		
Digital I/Q Processing Provides automatic pulse detection, spectrogram calculation and manual I/Q analysis.	R&S®TPA-IQ	4080.1179.02
Automatic Interpulse Analysis Provides automatic algorithms such as sequence analysis, scan analysis and deinterleaving.	R&S®TPA-AIP	4080.1185.02
Frame Analysis Used for detailed analysis of framed signals and pulse Doppler radars. It provides additional tools such as autocorrelation display, corridor plot and extended features in the RTR display.	R&S®TPA-FA	4080.1291.02

Chapter 5

System Devices and Accessories

Modern radiomonitoring systems primarily consist of “large” equipment such as antennas, receivers or direction finders. To combine these individual components into an effective system, “little helpers” known as system devices are needed. A typical task for these devices is to always ensure that the antenna with the appropriate frequency range and polarization is switched to the receiver input.

If a measurement requires that a directional antenna be brought into a precisely defined position, system devices ensure that the antenna is aligned exactly as needed in all three degrees of freedom (azimuth, polarization and height). This is necessary, for example, when performing measurements on TV transmitters. The corresponding ITU guideline recommends that the antenna be 10 m above ground, that it has the correct polarization and that it points exactly in the direction of the transmitter.

Finding suitable sites for the monitoring and DF stations becomes increasingly difficult. Often, powerful transmitters in the vicinity impede measurements. By providing various filters, attenuators and amplifiers, devices like the R&S®FU129 antenna filter unit mitigate some of the unwanted environmental effects and improve the capability and suitability of a monitoring site.

Knowing the exact equipment position is especially important with mobile and transportable measurement systems. Such cases also call for the use of system devices that – by implementing GPS – not only provide the exact position but also supply an extremely precise reference frequency.

In the case of unattended, remote controlled stations, it is important for a control center to know the exact status of the remote station. This is achieved by using system devices that monitor a large number of different types of sensors. These sensors can signal information such as temperature, humidity, smoke emission, the opening of doors and windows, and the detection of motion. If a sensor detects that a user-defined threshold has been exceeded, an alarm is automatically and immediately sent to the control center.

Although these devices were originally developed for use in radiomonitoring systems, they can be used for other applications. In principle, any receiving antenna can be switched in the frequency range from DC to 26.5 GHz regardless of the purpose it is being used for.

Type	Designation	Page
New R&S®MSD	Modular System Device	142
R&S®GPS129	GPS Receiver	144
R&S®FU129	Antenna Filter Unit	146
R&S®RO129	Antenna Rotator	148

R&S®MSD Modular System Device

New

The R&S®MSD device combines flexible antenna switching and rotator control in one compact device.

In order to match project-specific requirements, various modules for antenna switching and/or positioning can be inserted into the two rear slots of the 19" 2 HU rackmountable case. The R&S®MSD can be operated with AC or DC power for maximum flexibility and easy integration into a mobile monitoring vehicle. Additional options, such as DC feeds and splitters, round off the functionality.

The R&S®MSD can be operated locally (via the touchscreen on the front panel) or remotely controlled (via a LAN/WAN connection).

Key facts

- Antenna switching and/or rotator control in one powerful device
- Frequency range from DC to 26.5 GHz
- Compact design (19", 2 HU)
- Variable power supply (AC or DC)

Benefits and key features

Flexible switching of up to twelve antennas

Several options are available to provide a high degree of flexibility for antenna switching, e.g. to facilitate antennas covering different frequency ranges or polarizations. The R&S®MSD is ideal for microwave monitoring. The R&S®MSD-SM8 switch module provides a single-pole six-throw (SP6T) antenna switch for the frequency range from

DC to 8 GHz and the R&S®MSD-SM26 switch module provides a SP6T antenna switch for the frequency range from DC to 26.5 GHz.

Both modules can control additional external switch units. The R&S®ZS129A2 switch unit can be controlled via the I²C bus interface. This switch unit is designed for outdoor use. When it is placed on the mast close to the antennas, the number of required RF cables can be significantly reduced. Since the switching is done on the mast, only one RF cable needs to be routed down to the equipment inside the station.

The R&S®ZS129A5 switch unit can be controlled via the open collector outputs. The R&S®ZS129A5 is a configurable indoor switch unit that can be adapted to special system requirements.

The I²C bus interface and the open collector outputs can also be used to control other external equipment, e.g. the R&S®ZS129Z1 or suitable third-party equipment with open collector control.

Monitoring equipment such as the R&S®ESMD or the R&S®EB500 receiver provides TTL outputs. When connected to the TTL inputs of the R&S®MSD, the receiver can directly initiate the R&S®MSD switching.

Any combination of the R&S®MSD-SM8 and R&S®MSD-SM26 can be integrated, with a maximum of two per device.

Additional system capabilities

Further flexibility is provided by a single-pole double-throw (SPDT) antenna switch (DC to 8 GHz). The optional splitter can be used to distribute an input signal to two outputs (DC to 8 GHz). 8 kHz to 8 GHz active antennas can be directly powered by DC feeds that supply DC voltage to an antenna input.

The SPDT antenna switch, the splitter and the DC feeds are options that can be used in conjunction with the R&S®MSD-SM8 and the R&S®MSD-SM26 switch modules. They are integrated into the switch modules so that no further module slot is occupied. Per switch module, up to two SPDT antenna switches or splitters and up to four DC feeds can be assembled.



Powerful control of up to four axis

The rotator control options can be used to control up to four axes: azimuth, elevation, polarization and antenna height.

The rotator control basic modules control up to two rotators, either one AC-powered and one DC-powered rotator or two DC-powered rotators. This constellation is typically used to control movement in the azimuth and elevation or polarization range.

The rotator control extension modules allow control of one additional AC-powered or DC-powered rotator (e.g. for elevation or polarization) and the antenna height. The height of the antenna is managed via the R&S®GB127MU mast control unit.

The rotator module can be used to directly control various rotators or to operate the R&S®RD127 rotator control unit and the R&S®FU129 filter unit. Rotators currently supported by the R&S®MSD include the Yaesu G2800 azimuth rotator, the Yaesu G550 elevation/polarization rotator, the Winter AR/AE1002, Winter AR/AE 1042 and the R&S®RO129. For these devices, the R&S®MSD-RCB option is required.

Additionally, the R&S®MSD supports the ProSisTel PST2051D-PRO azimuth rotator and the ProSisTel PST2051E polarization rotator. These devices have an

extended lower temperature range. To control them, the R&S®MSD-RCB-P option is required.

Please note that the extension module requires the basic module. The extension hardware will be integrated into the basic module so that only one module slot is occupied.

One rotator control module (either the basic module or the basic module plus integrated extension module) per device is supported.

Modular structure for easy adaptation to customer-specific requirements

The R&S®MSD has been designed to allow easy adaptation and configuration to individual tasks and requirements. The figure below shows the main components of the R&S®MSD. While mainboard, process controller and touchscreen are always integrated into the 19" 2 HU case, the two slots can be flexibly equipped with R&S®MSD options to perfectly match individual customer's requests. The customer can choose between AC or DC operation.

If requirements change during operation, it is possible to upgrade the R&S®MSD, e.g. an additional module can be inserted in an empty slot, or the basic rotator control module can be upgraded with the extension module. These modifications will be done in a Rohde&Schwarz factory.

5

Specifications	
Front panel	5" touchscreen display, standby/on switch, 1 × USB 2.0 interface
Modules	8 GHz RF switch module; 26.5 GHz RF switch module; RF switch 1-2; rotator control basic axis #1 and #2; rotator control basic, ProSisTel; rotator control extension axis #3 and mast axis #4
Operating temperature range	0°C to +50°C
AC power supply	100 V to 240 V, 50 Hz to 60 Hz, max. 4 A
DC power supply	12 V to 30 V, max. 30 A
Dimensions (W × H × D), without feet or handles	approx. 444.6 mm × 88.1 mm × 456.0 mm (17.50 in × 3.47 in × 17.95 in), 19", 2 HU
Weight	approx. 6 kg to 10 kg (13.23 lb to 22.05 lb), depends on configuration

Ordering information		
Designation	Type	Order No.
Modular System Device	R&S®MSD	3046.4008.02
Options		
Switch Module 8, SP6T switch, DC to 8 GHz	R&S®MSD-SM8	3046.4508.02
Switch Module 26, SP6T switch, DC to 26.5 GHz	R&S®MSD-SM26	3046.4608.02
SPDT Switch, DC to 8 GHz ¹⁾	R&S®MSD-SW	3046.4714.02
Splitter, DC to 8 GHz ¹⁾	R&S®MSD-SP	3046.5104.02
DC Feed, powers one external 8 kHz to 8 GHz antenna ¹⁾	R&S®MSD-DCF	3046.5004.02
Rotator Control Basic, controls 2 rotators/axes	R&S®MSD-RCB	3046.4808.02
Rotator Control Basic, controls 2 rotators/axes, for ProSisTel rotators	R&S®MSD-RCB-P	3059.1002.02
Rotator Control Extension, controls 1 rotator/axis plus one mast ²⁾	R&S®MSD-RCE	3046.4908.02
AC Power Supply	R&S®MSD-AC	3046.5204.02
DC Power Supply	R&S®MSD-DC	3046.5304.02

¹⁾ Requires R&S®MSD-SM8/26 option.

²⁾ Requires R&S®MSD-RCB option.

R&S®GPS129 GPS Receiver

GPS receiver with reference frequency generator

The R&S®GPS129 consists of a GPS receiver and a satellite-controlled clock, plus a power supply unit, all installed in a metal 19" rackmount and ready to operate. It offers high-accuracy 2.048 MHz and 10 MHz frequency outputs to increase the frequency accuracy of receivers if the receiver is provided with a frequency reference input.

The R&S®GPS129 provides the user with extremely precise time and position data.

Benefits and key features

- GPS receiver and reference frequency generator combined in a single unit
- High precision due to GPS-based operation
- Compact design: 19" rackmount of just 1 HU for integration into system racks
- Suitable for stationary, transportable and mobile applications
- Available with AC or DC power supply



Specifications		
Interfaces		ANTENNA, COM0 to 1, TIME CAPTURE/PULSE OUTPUT, 2.048 MHz, 2.048 MHz switched, 10 MHz, 10 MHz switched, POWER
General data		
Operating temperature range		0°C to +50°C
Humidity		85% relative humidity
Power supply		100 V to 240 V AC, 50 Hz to 60 Hz, 20 VA 19 V to 35 V DC, max. 2 A/20 VA
Dimensions (W × H × D)		483 mm × 44 mm × 345 mm (19.02 in × 1.73 in × 13.58 in) 19" rackmount, 1 HU
Weight		3 kg (6.61 lb)

Ordering information		
Designation	Type	Order No.
GPS Receiver (with reference frequency generator, including GPS antenna)	R&S®GPS129	
100 V to 240 V AC operation		3026.1010.02
19 V to 35 V DC operation		3026.1010.04

R&S®FU129 Antenna Filter Unit

The R&S®FU129 antenna filter unit is placed close to the receiving antennas. It comes with an antenna input selector for remote controlled switching of up to six antenna inputs to one output. Unwanted signals, such as those caused by nearby mobile radio base stations or strong sound and TV broadcast transmitters, can be reduced to levels suitable for the connected receiver by applying optional filters. Both strong useful signals and interfering signals can be suppressed.

All R&S®FU129 functions are controlled either directly by a control PC (connected to the R&S®FU129 via a LAN cable) or by the tried-and-tested R&S®GB127S antenna control unit.

Excellent documentation for both interfaces ensures that end customers and system integrators can easily integrate the R&S®FU129 into customized systems and existing projects.

All Rohde & Schwarz radiomonitoring systems that are equipped with rotators, the R&S®GB127S antenna control unit and the R&S®RD127 rotator control unit can be retrofitted with the antenna filter unit (compatible replacement for existing R&S®RD127 rotator control units).

When using the comprehensive and convenient R&S®ARGUS monitoring software, integration of the R&S®FU129 offers the opportunity to carry out extremely comprehensive and complex measurement series fully automatically. This includes selecting one of various antennas and switching the antenna paths as required, with and without filters, amplifiers, etc. The area of reception is covered by directional antennas that are turned with rotators.

The software comes standard with path correction tables to compensate for the insertion loss in defined paths. This allows R&S®ARGUS to display the correct field strength levels for all configurations.

Key facts

- 1-out-of-6 antenna input selector
- Wide frequency range from DC to 26.5 GHz
- Suitable for outdoor use very close to antennas
- Integrated rotator control (azimuth and polarization/elevation)
- Powerful options:
 - Five selectable attenuators for reducing strong signal levels
 - Three selectable amplifiers for different frequency ranges
 - Up to ten selectable filters with different characteristics
- DC power supply for active antennas



Specifications

Frequency range		DC to 26.5 GHz
Impedance		50 Ω
Insertion loss of base unit	up to 3 GHz	≤ 0.8 dB
	3 GHz to 6 GHz	≤ 1.1 dB
	6 GHz to 12 GHz	≤ 1.7 dB
	12 GHz to 26.5 GHz	≤ 3.0 dB
Input VSWR of base unit	up to 6 GHz	≤ 1.4
	6 GHz to 12 GHz	≤ 1.8
	12 GHz to 26.5 GHz	≤ 2.0
Contact switching time		≤ 15 ms
Attenuator option (DC to 26.5 GHz)	without attenuation	bypassed
	stages 2 to 6	3/6/10/20/40 dB (typ.)
Amplifier option	without amplification: DC to 26.5 GHz	bypassed
	amplifier 1: 0.5 MHz to 35 MHz	+22 dB (typ.)
	amplifier 2: 20 MHz to 3 GHz	+12 dB (typ.)
	amplifier 3: 1 GHz to 26.5 GHz	+30 dB (typ.)
Filter option	without filter: DC to 26.5 GHz	bypassed
	stages 2 to 6 (11): for frequency ranges, see filter type	attenuation depends on filter
Power supply	AC	100 V to 240 V, 50 Hz to 60 Hz
	DC	10 V to 30 V
	power consumption, depends on options installed	25 W to 40 W/25 VA to 40 VA (typ.)
	power consumption, with both rotators in operation	100 W/100 VA (typ.)
MTBF		21 500 h
Permissible temperature range	without direct sun exposure	-40°C to +55°C
Storage temperature range		-40°C to +70°C

Ordering information

Designation	Type	Order No.
Antenna Filter Unit	R&S®FU129	3040.3300.02
Options		
Attenuator Option (max. 1)	R&S®FU129-ATT	3040.3400.02
Amplifier Option (max. 1)	R&S®FU129-AMP	3040.3500.02
Filter Option, for up to five filters (max. 2 filter options can be installed)	R&S®FU129-FIL	3040.3600.02
Filters for filter option		
Lowpass Filter, DC to 80 MHz	R&S®FU129-F1	3040.3616.02
Lowpass Filter, DC to 530 MHz	R&S®FU129-F2	3040.3622.02
Lowpass Filter, DC to 3000 MHz	R&S®FU129-F3	3040.3639.02
Highpass Filter, 27.5 MHz to 800 MHz	R&S®FU129-F4	3040.3645.02
Highpass Filter, 133 MHz to 1 GHz	R&S®FU129-F5	3040.3651.02
Highpass Filter, 225 MHz to 3 GHz	R&S®FU129-F6	3040.3668.02
Highpass Filter, 910 MHz to 3 GHz	R&S®FU129-F7	3040.3674.02
Highpass Filter, 1.9 GHz to 2.7 GHz	R&S®FU129-F8	3040.3680.02
Highpass Filter, 2.3 GHz to 5.5 GHz	R&S®FU129-F9	3040.3697.02
Highpass Filter, 3.9 GHz to 9.8 GHz	R&S®FU129-F10	3040.3700.02
Highpass Filter, 6 GHz to 11.5 GHz	R&S®FU129-F11	3040.3716.02
Bandpass Filter, 0.8 GHz to 1.05 GHz	R&S®FU129-F12	3040.3722.02
Bandpass Filter, 1.73 GHz to 2.27 GHz	R&S®FU129-F13	3040.3739.02
Bandpass Filter, 2 GHz to 2.26 GHz	R&S®FU129-F14	3040.3745.02
Bandstop Filter, 88 MHz to 108 MHz	R&S®FU129-F15	3040.3751.02
Other filters and options on request.		

R&S®RO129 Antenna Rotator

The R&S®RO129 antenna rotator is used to position multiple antennas in the azimuth and elevation/polarization direction. To mount antennas on the rotator, two identical flanges are provided at both ends of the elevation/polarization axis.

The R&S®RO129 is designed as a moving rotator. The rotator housing, together with the antennas mounted along the elevation/polarization axis, rotates around a fixed mast. This design allows other, fixed antennas (e.g. DF antennas) to be installed above the rotator.

The rotator has a fixed center section, which serves as a mast adapter. The bottom flange of the mast adapter is mounted on a suitable flange at the top of an antenna mast. At the top flange of the mast adapter, another mast section can be mounted in order to install additional, fixed antennas (e.g. DF antennas) above the rotator.

All cables leading to antennas mounted above the rotator are routed through a duct inside the mast adapter.



Rear view.

Key facts

- Accurate positioning of multiple antennas in the azimuth and elevation/polarization direction
- High delivered torque for carrying heavy or multiple antennas

Benefits and key features

Flexible remote control

The R&S®RO129 antenna rotator is intended exclusively for remote control and does not incorporate any control elements. It is controlled via a watertight MIL connector on its bottom side. The rotator is fully remote controlled via a control cable, either from an R&S®GB127S antenna control unit and an R&S®RD127 rotator control unit or from an R&S®FU129 antenna filter unit.

Easy integration into (existing) monitoring systems

Due to the flexible remote control via either the R&S®GB127S or the R&S®FU129, the R&S®RO129 antenna rotator can be easily integrated into monitoring systems. The R&S®ARGUS monitoring software supports both control units. The rotatable antennas are positioned either interactively via a convenient graphical user interface or fully automatically. As a result, even complex measurement tasks can be performed easily and reliably.

The LAN interface on the R&S®FU129 also allows remote control using other, suitable software products.

The electrical and mechanical interfaces are compatible with those of the AE/AR 1049 rotator. The R&S®RO129 can therefore easily replace existing rotators.

User-definable range of rotation

The range of rotation can be defined separately for the azimuth and the elevation/polarization axis. This is particularly useful when there are obstacles within the rotation range, or when topographical conditions allow only a specific sector to be covered. Robust limit switches integrated in the antenna rotator reliably switch off the drive motors when the end of the rotation range is reached.

Moving rotator concept for use of moving and fixed antennas on a single mast

The R&S®RO129 is designed as a moving rotator, i.e. the rotator and the antennas attached to it rotate around a fixed mast. This concept's big advantage is that additional mast segments and antennas can be installed above the rotator. As the mast itself does not rotate, DF antennas, for example, can be mounted at the mast top, which is the ideal position for direction finding. The moving rotator concept therefore allows moving and fixed antennas to be used simultaneously on a single mast.

Specifications

Azimuth

Range of rotation		0° to 420°
Speed of rotation		typ. 2.2°/s (corresponds to approx. 160 s for a 360° rotation)
Maximum delivered torque		typ. 300 Nm
Repeatability		typ. ±0.2°
Maximum bending moment		15000 Nm at top flange of mast adapter
Maximum axial load		5000 N vertical load on top flange of mast adapter
Power supply for drive motors		28 V DC
Position feedback		linear potentiometer, 1 kΩ
Limit switches		integrated limit switches interrupt the power supply to the drive motors when the end position is reached in both directions of rotation

Elevation/polarization

Range of rotation		0° to 190°
Speed of rotation		typ. 9°/s (corresponds to approx. 20 s for a 180° rotation)
Maximum delivered torque		typ. 80 Nm
Repeatability		typ. ±0.2°
Maximum bending moment		2000 Nm
Maximum vertical load		500 N (cumulative load applied to both flanges)
Power supply for drive motors		28 V DC
Position feedback		linear potentiometer, 1 kΩ
Limit switches		integrated limit switches interrupt the power supply to the drive motors when the end position is reached in both directions of rotation

Interfaces

Control interface		MIL connector, 11-contact
Mast adapter, bottom	flange with 6 holes	Ø 22 mm
	pitch circle	Ø 270 mm, 6 × 60°
	flange thickness	25 mm
Mast adapter, top	flange with 6 holes	Ø 22 mm
	pitch circle	Ø 140 mm, 6 × 60°
	flange thickness	25 mm
Elevation/polarization axis	flange with 8 threaded holes	M10
	pitch circle	Ø 100 mm, 8 × 45°
	flange thickness	15 mm

General data

Operating temperature range		-30 °C to +55 °C
Storage temperature range		-40 °C to +70 °C
Relative humidity		95% cyclic test, at +25 °C/+55 °C
Degree of protection		IP 65
Power consumption		< 120 W
Dimensions	W × H × D	430 mm × 750 mm × 730 mm (16.93 in × 29.53 in × 28.74 in)
Weight		165 kg (363.76 lb)

Ordering information

Designation	Type	Order No.
Antenna Rotator (moving type)	R&S®RO129	3042.6606.02



Chapter 6

Off-the-Shelf Software and Systems

Rohde&Schwarz has decades of experience in the design and implementation of complex radiomonitoring, radiolocation and spectrum management systems:

- ▮ Scalable standalone and multi-user systems
- ▮ Stationary systems as well as semi-mobile and mobile land-based, maritime and airborne systems
- ▮ Nationwide networked systems that are remote controlled via LANs/WANs
- ▮ Radiomonitoring and spectrum management systems that support regulatory authorities in accomplishing their tasks in line with ITU recommendations
- ▮ Systems for radiomonitoring and signals intelligence that support government security tasks
- ▮ Turnkey systems including training and service from a single source

Rohde&Schwarz radiomonitoring systems are custom-configured from an extensive portfolio of off-the-shelf hardware and software components. This approach allows extremely short delivery times even for customized system solutions and an optimal cost/benefit ratio for the customer.

This chapter describes the main off-the-shelf software products and systems.

Chapter 7 describes application examples from the field of radiomonitoring and radiolocation.

Type	Designation	Page	
	R&S®ARGUS	Monitoring Software	152
	R&S®RAMON	Radiomonitoring Software	156
New	Radar Signal Collection and Analysis System		158
	R&S®MapView	Geographic Information Software	160
	R&S®PCT	Propagation Calculation Tool	164
	R&S®AllAudio	Integrated Digital Audio Software	166
	R&S®UMS170	Compact Radiomonitoring System	168
	R&S®UMS200	Radiomonitoring and Direction Finding System	172
New	R&S®UMS300	Compact Monitoring and Radiolocation System	176
New	R&S®MP007	Portable Direction Finding System	180
	CECM Systems		186
	Satellite Monitoring Systems		194

R&S®ARGUS Monitoring Software

When it comes to ITU-compliant measurements and evaluations, R&S®ARGUS has been the preferred choice for regulators from more than 100 countries for more than 25 years. R&S®ARGUS controls dedicated devices and analysis tools. The measurement modes, reflecting typical workflows, are designed to support operators in their daily work. Numerous statistics allow in-depth analysis and the creation of informative and concise reports. R&S®ARGUS 6, the latest development step, focuses on complete workflows and operability to ensure that you get the job done – faster and better than ever.

The R&S®ARGUS approach combines powerful spectrum monitoring tools with easy and efficient operation. The user interface defines new standards for monitoring software. Dialog windows, menus and control elements have been completely redesigned, following the latest findings in usability and ergonomics. Toolbars that can be flexibly positioned and displayed, favorite icons for faster access to the most important remote stations, display filters to focus only on the really important information, and tags that allow users to immediately find all data pertaining to a certain mission – these are just some of the many innovations. Every operator can adjust the user interface to match individual preferences. This not only provides a more pleasant working experience, it also improves efficiency.

Tried and tested features such as reasonable default values and the unique guided measurement modes are provided in an improved version. As a result, even less experienced operators can perform challenging tasks quickly and reliably.

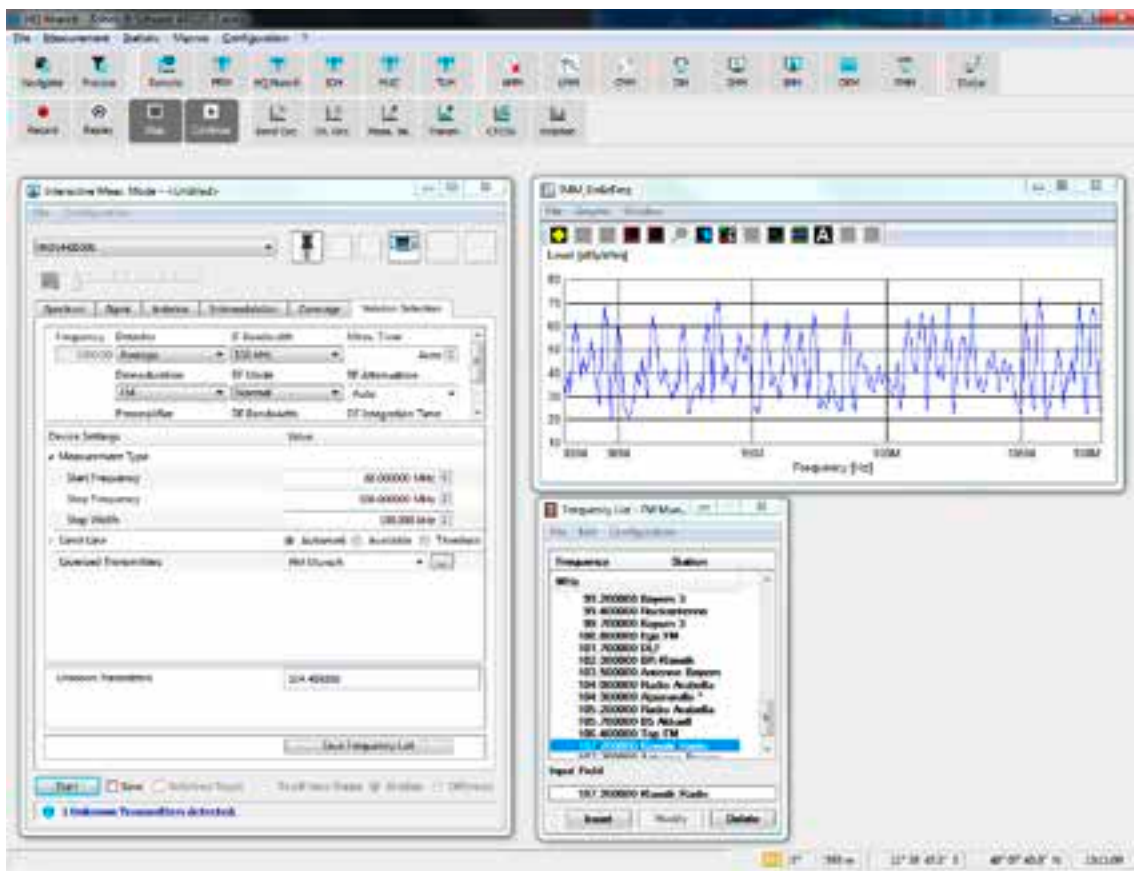

At the same time, a broad scope of monitoring and evaluation functionality is available, ranging from simple level measurements to sophisticated intermodulation analysis and vestigial sideband emission investigation, from stand-alone devices to nationwide monitoring networks, from interactive, quick response operation to fully automatic procedures.

The modular structure makes it possible to configure a system that perfectly matches customer requirements. Various open interfaces allow flexible adaptation to practically any customer demand. Any subsequent expansions are easily implemented, regardless of number of instruments, enhanced measurement capabilities or additional monitoring stations.

Throughout the last quarter of a century, R&S®ARGUS has been consistently and systematically expanded and improved, always ensuring excellent solutions for ever-changing challenges. This long and successful tradition is continuing. Thanks to a wide range of specialized equipment, the numerous open interfaces and unrivaled monitoring capabilities, R&S®ARGUS provides unique features that make it very well-suited for applications far beyond the scope of ITU-compliant monitoring.

Key facts

- Measurement and analysis in line with the ITU handbook on spectrum monitoring and ITU recommendations
- Location via angle of arrival (AoA), time difference of arrival (TDOA) and hybrid (combination of AoA and TDOA)
- First monitoring software to integrate the ITU SMS4DC spectrum management application
- Simple scalability due to modular software architecture
- Ergonomic design based on latest findings in usability combined with 25 years of market experience
- Strong focus on user support
 - Guided measurements
 - Helpful default values
 - Informative status and error messages
- Runs under Windows 7 and 8 (64 bit)
- Supports IPv6 protocol

Benefits and key features

- The right instrument for every task
- For maximum flexibility – the direct measurement mode
- Structured measurement sequences for successful monitoring
 - Interactive measurement mode (IMM)
 - Location measurement mode (LMM):
 - Location via AoA
 - Location via TDOA
 - Hybrid (AoA and TDOA) location
 - Automatic measurement mode (AMM)
- Guided measurements – for the ultimate in user support
 - Guided measurement mode for analog signals (GMM)
 - Guided measurement mode for digital signals (DM)
 - Guided measurement mode for coverage measurements (CMM)
- Detection and identification of new transmitters
 - Automatic detection of new transmitters
 - Diverse analysis capabilities for clear identification
- Efficient solutions for the digital world
 - Digital television
 - Digital radio
 - Digitally modulated signals
- Clear presentation of measurement and statistical results
 - Presentation using various specially adapted graphic types
 - Replay of recorded audio signals
 - Presentation on maps (geographic information systems)
- From comprehensive analyses to informative reports
 - Filtering of raw data
 - Analyses and evaluations in line with ITU guidelines and recommendations
 - Compilation of concise, informative reports
- The navigator – main area for all file operations
- Macros – recording and replay of entire workflows
- Open interface for integration of spectrum management applications
 - LStelcom
 - ATDI
 - ITU SMS4DC
 - Customer-specific databases and applications
- Data exchange – simple and efficient
- Flexible operating concepts
 - Local control
 - Remote control via R&S®ARGUS
 - Remote control via Internet
 - Remote control via the ORM open interface
- Remote operation made easy
 - Sophisticated client/server architecture
 - Data reduction and compression
 - Easy integration through use of standard network components
- Station information system (SIS)
- Security concept
 - Password-protected login
 - Individual assignment of access rights
 - Efficient user management
- Customer-friendly licensing concept
 - Modular structure for individual demands
 - License management server

Ordering information		
Designation	Type	Order No.
Base Module	R&S®ARGUS	3046.8603.02
Automatic Measurement Mode (AMM)	R&S®ARGUS	3046.8603.10
Location Measurement Mode (LMM-DF)	R&S®ARGUS	3046.8603.11
Location Measurement Mode (LMM-TDOA) ¹⁾	R&S®ARGUS	3046.8603.35
Location Measurement Mode (LMM-TDOAS)	R&S®ARGUS	3046.8603.38
Location Measurement Mode (TDOA-SRVL)	R&S®ARGUS	3046.8603.36
Coverage Measurement Mode (CMM)	R&S®ARGUS	3046.8603.12
Digital Measurement Mode (DM)	R&S®ARGUS	3046.8603.13
Guided Measurement Mode (GMM)	R&S®ARGUS	3046.8603.14
Interactive Measurement Mode (IMM)	R&S®ARGUS	3046.8603.15
Synchronous Measurement Mode (SYNC)	R&S®ARGUS	3046.8603.18
Evaluation Module (EVAL)	R&S®ARGUS	3046.8603.25
Difference Measurement Module (DIFF) ²⁾	R&S®ARGUS	3046.8603.26
Audio Recording & Replay (ARR)	R&S®ARGUS	3046.8603.30
Station Information System (SIS)	R&S®ARGUS	3046.8603.31
Extended System Functionality (ESF)	R&S®ARGUS	3046.8603.34
Remote Control Interface (RCI)	R&S®ARGUS	3046.8603.40
Data Exchange Interface (DEI)	R&S®ARGUS	3046.8603.41
Spectrum Management Database Interface (SMDI)	R&S®ARGUS	3046.8603.42
Order Report Module (ORM)	R&S®ARGUS	3046.8603.43
Device Control Interface (DCI Standard)	R&S®ARGUS	3046.8603.44
Device Control Interface (DCI Advanced)	R&S®ARGUS	3046.8603.45
Web Interface (WEB-05)	R&S®ARGUS	3046.8603.46
Web Interface (WEB-10)	R&S®ARGUS	3046.8603.47
Web Interface (WEB-20)	R&S®ARGUS	3046.8603.48
Web Interface (WEB-MTT)	R&S®ARGUS	3046.8603.49
Device Driver for Receiver Class (ARGUS-RX) ³⁾	R&S®ARGUS	3046.8603.50
Device Driver for Direction Finder Class (ARGUS-DF) ⁴⁾	R&S®ARGUS	3046.8603.60
Device Driver for Analyzer Class (ARGUS-ANALYZER) ⁵⁾	R&S®ARGUS	3046.8603.70
Device Driver for System Devices Class (ARGUS-SYSDEV) ⁶⁾	R&S®ARGUS	3046.8603.80
Device Driver for Legacy Devices Class (ARGUS-LD) ⁷⁾	R&S®ARGUS	3046.8603.85
Open Database Access (ODA)	R&S®ARGUS	3046.8603.90
Macro Recorder (MACRO)	R&S®ARGUS	3046.8603.92

¹⁾ The LMM-TDOA option is not to be made, used, sold or offered for sale in the USA or imported into the USA.

²⁾ Requires AMM option.

³⁾ The receiver class includes the following devices: R&S®EM100, R&S®ESMD, R&S®PR100, R&S®EB500, R&S®EB510 and RX extension of R&S®DD205 and R&S®DDF255.

⁴⁾ The direction finder class includes the following devices: R&S®DDF255, R&S®DDF205, R&S®DDF007, R&S®DDF550, R&S®DDF1xx, R&S®DDF0xAE, R&S®DDF39x and DF extensions of R&S®ESMD and R&S®EB500.

⁵⁾ The analyzer class includes the following devices: R&S®ETL, R&S®FSH3/6/18, R&S®FSIQ3/7/26, R&S®FSP3/7/13/30/40, R&S®FSQ3/8/26/40, R&S®FSV and R&S®ESU.

⁶⁾ The system devices class includes the following devices: COMPASS, GPS, MIXER, R&S®FU129, R&S®GB127M, R&S®GB127MU, R&S®GB127S, R&S®HSRG, R&S®RD127, R&S®RSU, R&S®ZS125/126/127/128/129, R&S®GX300, ePS and R&S®MSD.

⁷⁾ The legacy devices class enables temporary support of discontinued devices. List of supported devices on request.

MPEG Layer-3 audio coding technology licensed from Fraunhofer IIS and Thomson Licensing.

R&S®RAMON Radiomonitoring Software

The R&S®RAMON software modules are used as core components in advanced radiomonitoring and radiolocation systems. The R&S®RAMON software covers a broad scope of functions: It can be used to control the equipment connected to a computer, to store and analyze the data delivered by the equipment, to control and monitor the information flow in a networked system comprising multiple workstations or system sites, and to simplify routine tasks by translating them into fully automated sequences.

Systems using the R&S®RAMON software are intended for specific spectrum monitoring tasks, government authorities entrusted with public safety and security missions and for the armed forces. They are delivered as complete, turn-key systems and support a wide range of tasks, including:

- Collection of information as a basis for political decisions
- Border protection (prevention of contraband trade and illegal border crossings)
- Personal and property protection
- Location finding of interference signals
- COMINT/CESM for military missions

Systems based on R&S®RAMON include Rohde&Schwarz radiomonitoring and radiolocation equipment as well as IT components, communications systems and the modular R&S®RAMON software, which provides the interface to the user.

Rohde&Schwarz also offers special software modules developed for military use, e.g. in communications electronic countermeasures (CECM) systems. These modules are subject to export control regulations, and are described in a separate product brochure. They can be used in systems in combination with the R&S®RAMON radiomonitoring software.

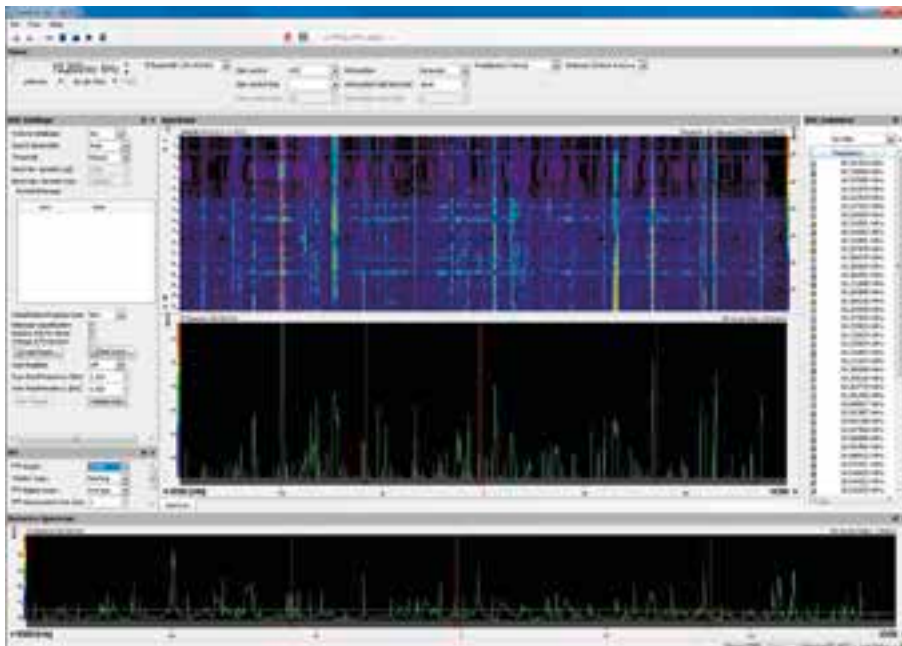

R&S®RAMON graphical user interface (GUI) of the R&S®CA120 multichannel signal analysis system: wideband tuner spectrum and list of emissions delivered by a detector for conventional radio signals.

Key facts

- Integrated radiomonitoring and radiolocation software from single-operator to nationwide distributed systems
- High probability of intercept
- Highly automated monitoring process – automatic storage of all radio activities to create a basis for information analysis
- Easy networking of radiomonitoring and radiolocation systems with R&S®RAMON software providing adaptation to a variety of communications systems and data transmission bandwidths
- R&S®RAMON systems flexibly integrate as subsystems into customer's radiomonitoring and radiolocation systems

Benefits and key features

- Full scope of functionality – all from a single source
 - Complete portfolio of hardware and software components
 - Support of complete workflows, from planning to reporting
 - Full range of services (project management, system engineering and user training)
- High probability of intercept
 - Detection of low probability of intercept (LPI) emissions
 - Storage of LPI signal characteristics and comparison with stored signal profiles to enable emission identification
- Flexibility and scalability
 - Reconfiguration, expansion and updating of existing systems to include new scenarios
 - Flexible sharing of sensor equipment
 - Remote control capability
- Remote control
 - Remote control capability via wired or wireless communications links
 - Use of simplex or full-duplex communications links
 - Adaptation to available bandwidth

- Interference hunting
 - Mobile DF system for use on commercial vehicles
 - Automatic target location in urban environments
- Propagation calculation with R&S®PCT
 - Determining the radio coverage for optimum site planning
 - Planning the communications links for subsystem networking
- Automation of radiomonitoring sequences
 - Combining radiomonitoring functions into complex, fully automated sequences
 - Time-controlled radiomonitoring tasks in unattended systems/subsystems
- Evaluation support and radio network detection
 - Automatic detection of radio traffic and radio networks
 - Display of electronic situation picture
 - Re-identification of radio networks by means of emitter database
- Workflow control
 - Defining and tracking of orders and reports
 - Clear-cut hierarchical structure
- Integration into existing systems
 - Expandable, future-oriented solutions thanks to open interfaces
- Turnkey, customized system solutions
 - System integration into almost any type of mobile platform
 - Planning, installation and putting into operation of stationary systems

Ordering information

The R&S®RAMON radiomonitoring software comprises a wide range of different modules.

Your local Rohde & Schwarz representative will help you determine the optimum solution for your requirements. To find your nearest Rohde & Schwarz representative, visit www.sales.rohde-schwarz.com.

Radar Signal Collection and Analysis System

Complete digital radar signal search, collection, measurement and analysis system

New

The radar signal collection and analysis system is an advanced search, collection, measurement and analysis system that can be used on almost any platform in any signal environment. The system focuses on operator usability and functionality. The devices and system software complement each other and contain many features that support the operator in dense signal environments. The system software controls all the devices in the collection system, contains intuitive, operator-friendly GUIs and provides database storage, search and data display.

The radar signal collection and analysis system is a fully digital, manually operated radar signal search, measurement and analysis system that uses state-of-the-art components and technology. The system contains one or more digital receivers that use a 500 MHz IF bandwidth each and produce pulse descriptor words (PDW), I/Q descriptor words (IQDW) and continuous I/Q data. The system also contains advanced radar measurement and analysis software and an integrated wideband digital recorder.

To meet the demands of collecting signals in the modern radar environment, the radar collection system is both highly sensitive and features a high probability of intercept (POI).

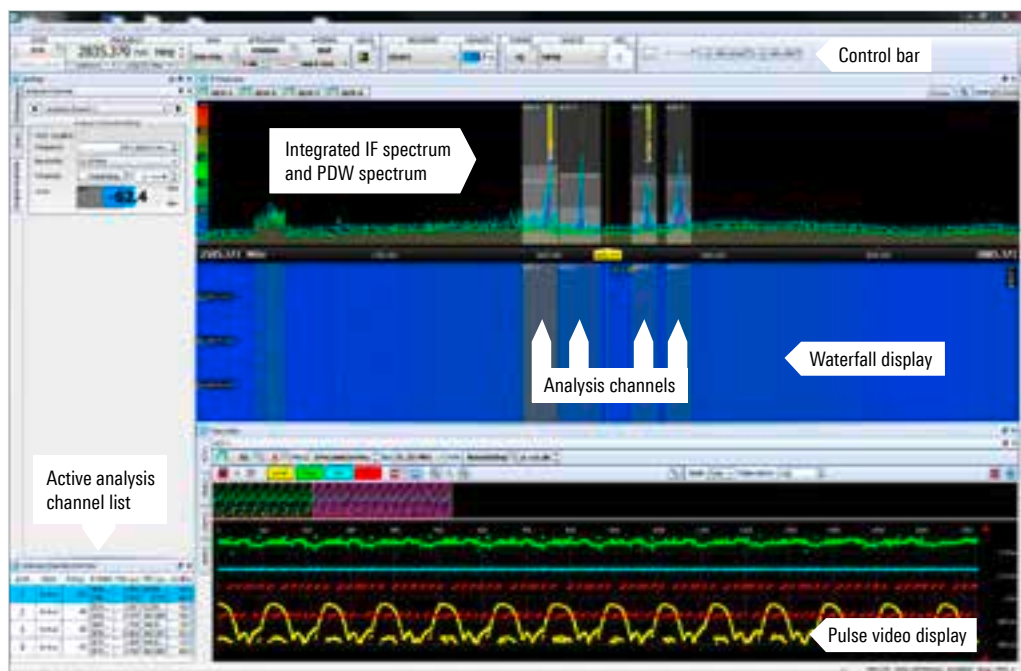

The diagram shows the R&S®WPU-CTL software. The device control GUI, with the spectrum, waterfall and pulse video display, is clearly seen. The four analysis channels have been positioned in the IF spectrum. The online PDW output from one of the analysis channels is visualized in the pulse video display.

One of the benefits of the system is that the hardware and software have been developed alongside each other and therefore complement each other perfectly, providing the operator with a fully integrated collection system that is specifically designed to handle any radar signal collection task.

The system solution is based on the many years of operational experience and technical excellence within the company. It has been developed solely to provide a modern technical solution to all the different challenges encountered during a radar signal collection mission. The features and benefits of the system have been implemented to achieve the required functionality and are not dependent on existing software or hardware solutions. The features are implemented where they provide the greatest benefit to the operator.

Key facts

- Turnkey solution for radar signal collection and analysis, ideally suited to electronic intelligence (ELINT) and radar electromagnetic spectrum applications
- Interception and analysis of modern low-power, low probability of intercept (LPI) radar signals
- High-quality lossless digital signal processing for accurate interpulse and intrapulse analysis
- Fully flexible and scalable, from single operator solutions to nationwide collection systems
- Control of remote collection sites via WAN
- Integrated workflow and data management for efficient operation

Benefits and key features

- Efficient operation in complex signal scenarios
 - Integrated radar signal collection and analysis system
 - Multichannel operation in dense signal environments
 - Efficient search, collection and analysis of modern pulsed and CW radar signals
 - Powerful radar signal analysis
 - Integrated operator radar database
- Highest data quality
 - PDWs, IQDWs and continuous I/Q data accurately visualize all radar and pulse parameters
 - Complete digital design preserves the frequency and phase characteristics of the radar signals
 - Digital I/Q recording provides lossless postprocessing and high-quality results
 - Integrated data management
- Future-ready system design
 - Fully digital collection and analysis system
 - Single operator systems to nationwide integrated systems
 - Remote control of unmanned or detached receiver sites
 - Open interfaces
- Low-risk turnkey solution
 - Tried and tested system from a single supplier
 - Integration into almost any type of platform
 - Low integration costs
 - Post-project support
 - Customer-specific integration
 - Operational and technical training

Ordering information

Any ELINT system should be optimized for the environment in which it will operate.

Your local Rohde&Schwarz representative will help you determine the optimum solution for your requirements.

To find your nearest Rohde&Schwarz representative, visit www.sales.rohde-schwarz.com

R&S®MapView Geographic Information Software

The software is used to display geographic data on digital vector and raster maps. R&S®MapView is primarily designed for radiomonitoring and radiolocation applications. The software presents online results in a fast, optimized manner.

Displaying direction finding and radiolocation results on maps is essential for the interception of radio signals and also for direction finding evaluations in radiomonitoring systems. Examples include the transmitter-site display to support DF evaluation and a cartographic display to support operational and tactical analysis. The map display in conjunction with running fixes is especially useful during mobile operations and allows fast location of the tracked target (homing). Other applications include the display of status information for all the stations in a radiomonitoring system, the visualization of database information and the display of results in coverage measurement systems.

The following functions simplify working with digital maps:

- Use of elevation data in conjunction with maps
- Fast map zooming (zoom and pan function)
- Direct selection of map objects as well as direction finding and radiolocation results
- Tooltips for fast access to information on displayed map objects
- Rapid finding of map objects by means of the tree view next to the window

R&S®MapView supports a wide variety of different map formats, projection types and geodetic grid systems so that customers can generally make use of their own digital map data in radiomonitoring and radiolocation systems from Rohde&Schwarz.

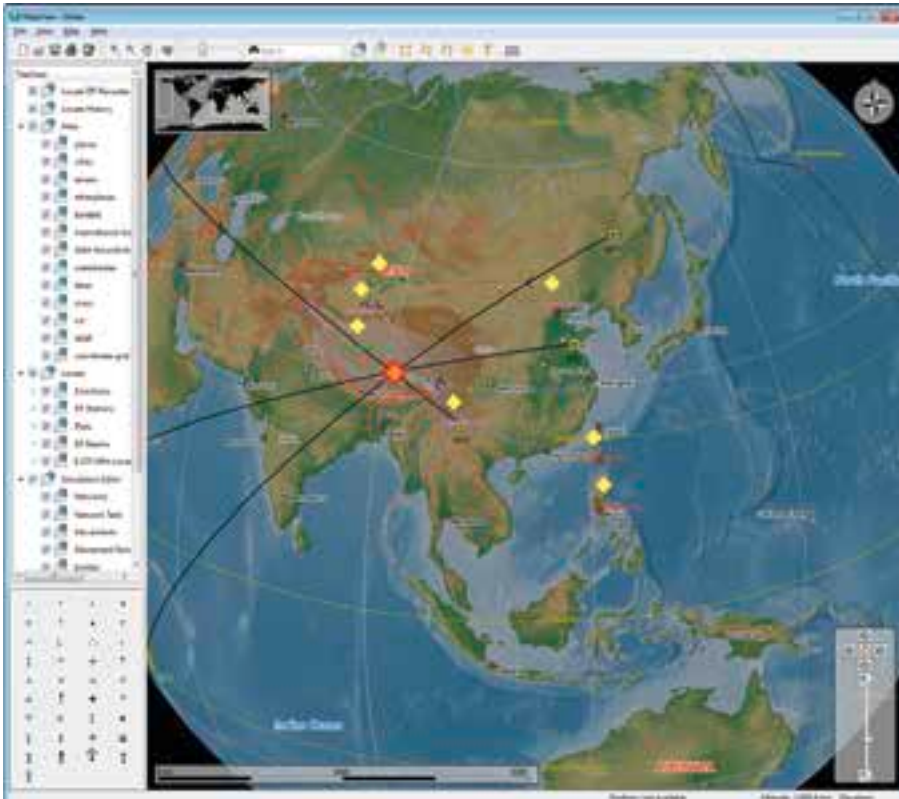

Key facts

- ▮ Use in direction finding and radiolocation systems as well as in coverage measurement systems
- ▮ Fast online display of results on digitized maps
- ▮ Offline display of results in combination with external databases
- ▮ Integrated layers for graphical situation display
- ▮ Use of digital maps in various formats
- ▮ Generation of user-specific maps

Benefits and key features

- ▮ Very wide variety of maps available
 - Free use of OpenStreetMap (OSM) and other publicly available map data
 - Use of map data from the market leaders in the field of geographic information systems
- ▮ Generation of user-specific maps
 - Georeferencing of raster images
 - Creation of map tiles in line with the TMS map tiles convention
- ▮ Integrated situation display
 - Editor for situation display
 - Saving/loading of situation layers
- ▮ System integration
 - Interfaces to the R&S®RAMON, R&S®ARGUS and SatMon applications from Rohde&Schwarz
 - Open interface for integration into customer applications

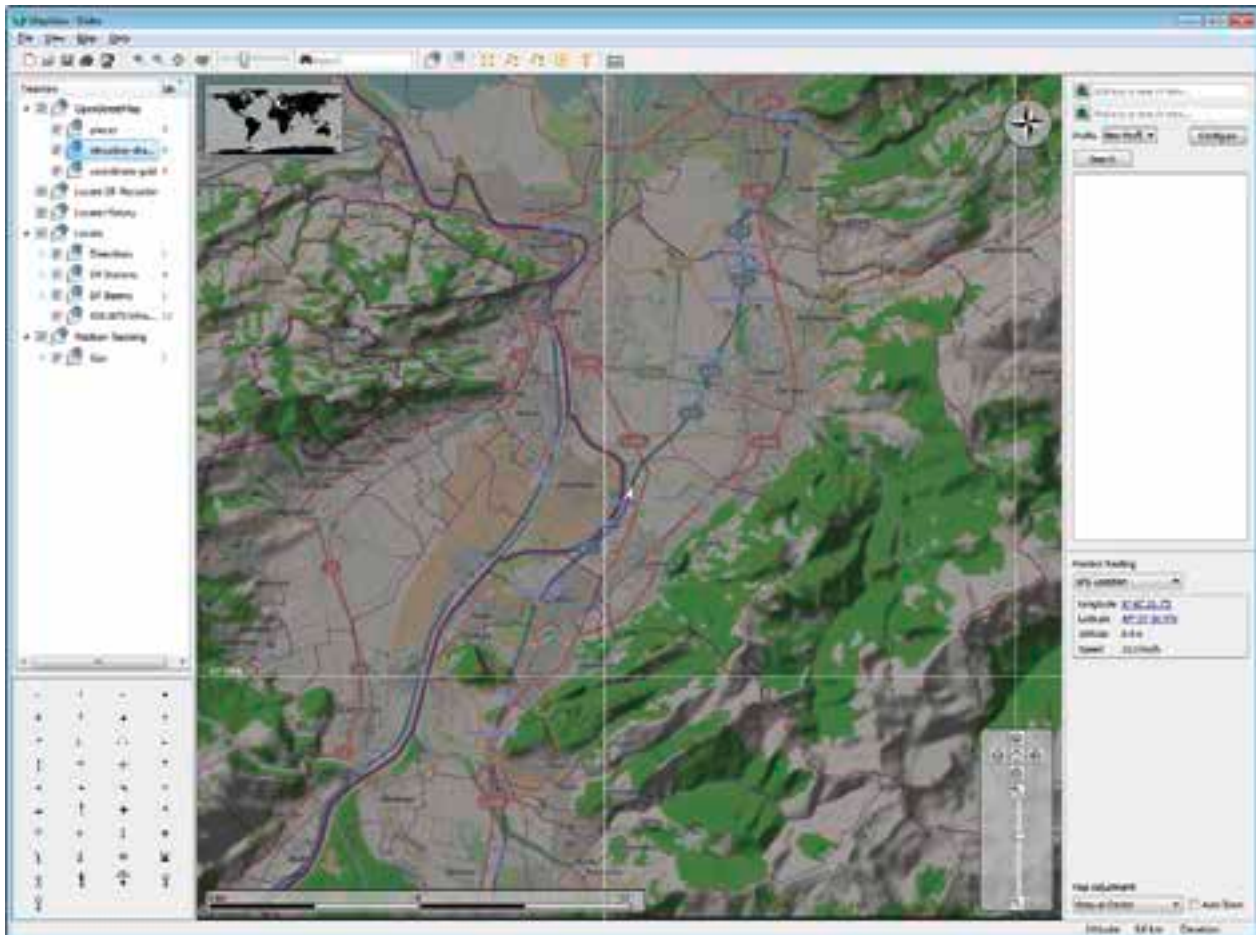

OSM map section with shading for elevation display; shading is based on SRTM elevation data.

Specifications

Based on the various options, R&S®MapView directly supports the following map formats:

ESRI shapefile	
ESRI grid	
ESRI MXD file (geoset)	(with R&S®MV-ESRI option)
ESRI ArcSDE (database)	(with R&S®MV-ESRI option)
ArcInfo binary grid	
ArcInfo coverage	
ArcInfo E00	
CADRG image layer	using R&S®GeoRefWizard (included in R&S®MapView)
ADRG image layer	using R&S®GeoRefWizard (included in R&S®MapView)
ERDAS image layer	using R&S®GeoRefWizard (included in R&S®MapView)
Intergraph/Bentley design files (DGN)	(with R&S®MV-ESRI option)
DXF	(with R&S®MV-ESRI option)
DWG	(with R&S®MV-ESRI option)
GeoTIFF	
MapInfo (shape&grid)	(with R&S®MV-MINF option)

Elevation data (3D) in the following formats can be used directly in R&S®MapView:

USGS-SRTM	
-----------	--

The following coordinate formats are currently supported:

Lat/Lon (formats: GEO-long, GEO-short, GEO-decimal)	
UTM	
MGRS	
RT90	
SWEREF99	
QTH Maidenhead	

The following map formats can be imported into R&S®MapView:

DXF	
Bitmap formats (.JPG, .BMP, .TIFF)	
Rohde&Schwarz map format (.MAP)	

The following map projections are supported by R&S®MapView:

Albers equal area conic	Mercator (1SP)
Azimuthal equidistant	Mercator (2SP)
Cassini-Soldner	Miller cylindrical
Cylindrical equal area	Mollweide
Eckert IV	New Zealand Map Grid
Eckert VI	Oblique Mercator
Equidistant conic	Oblique stereographic
Equidistant cylindrical	Orthographic
Equirectangular	Polar stereographic
Gauss-Kruger	Polyconic
Gall stereographic	Robinson
GEOS – geostationary satellite view	Rosenmund oblique Mercator
Gnomonic	Sinusoidal
Hotine oblique Mercator	Swiss oblique cylindrical
Krovak	Swiss oblique Mercator
Laborde oblique Mercator	Stereographic
Lambert azimuthal equal area	Transverse Mercator
Lambert conic conformal (1SP)	Transverse Mercator (Modified Alaska)
Lambert conic conformal (2SP)	Transverse Mercator (South Oriented)
Lambert conic conformal (2SP Belgium)	Tunisia Mining Grid
Lambert cylindrical equal area	VanDerGrinten

Ordering information		
Designation	Type	Order No.
Basic Module of R&S®MapView Geographic Information Software, contains a license for R&S®MapView, display of raster or vector maps, elevation data, situation display editor, system interface, and optimized display for DF and radiolocation results (maps not included); licensing via PC hardware (softlock)	R&S®MapView	4046.1205.02
Basic Module of R&S®MapView Geographic Information Software, contains a license for R&S®MapView, display of raster or vector maps, elevation data, situation display editor, system interface, and optimized display for DF and radiolocation results (maps not included); licensing via included dongle (hardlock)	R&S®MapView	4046.1205.03
Basic Module of R&S®MapView Geographic Information Software, contains a license for R&S®MapView, display of raster or vector maps, elevation data, situation display editor, system interface, and optimized display for DF and radiolocation results (maps not included); licensing via dongle for the R&S®RAMON or R&S®ARGUS workstation PC	R&S®MapView	4046.1205.04
Options		
R&S®MapView MapInfo Server Software, displays vector maps in MapInfo format using the MapXtreme engine	R&S®MV-MINF	4046.1434.02
R&S®MapView ESRI Server Software, displays vector and raster maps in the following formats: ESRI Mxd (GeoSet, read/write), ESRI ArcSDE (database) using the ArcGIS Engine Standard Runtime	R&S®MV-ESRI	3029.8273.02

R&S®PCT Propagation Calculation Tool

The R&S®PCT propagation calculation tool helps operators rapidly and easily plan the sites for setting up their radiomonitoring systems. In addition to selecting the best installation sites for the direction finding and monitoring sensors, the tool supports the planning of the radiocommunications links required to network these systems.

A key factor in the deployment of radiomonitoring systems is the selection of the right sites. This applies equally to stationary, mobile and transportable systems. Operators require a reliable tool for calculating the coverage of the area of interest for their radiomonitoring systems.

The R&S®PCT propagation calculation tool offers operators full support, allowing them to optimally deploy their radiomonitoring systems. In order to cover a defined area of interest, the tool relies on topographic data of the terrain (terrain profiling data) to calculate the best reception sites within a particular sector. Results are displayed on a digital map in the R&S®MapView geographic information software. Operators can thus select the best possible installation sites for their radiomonitoring systems.

The suitability of the selected installation sites is verified in a second step, which also takes into account the radiolocation errors to be expected due to the geometrical arrangement of the sites. As an option, the tool can also be used to plan the radiocommunications links required between the individual radiomonitoring systems or between unattended sensors and an attended station.

Key facts

- Rapid calculation to determine possible sites for radiomonitoring systems, taking into account the propagation conditions
- Support in radio network planning
- Easy to operate, even for less experienced users
- Support of numerous elevation data formats
- Interfaces to other Rohde&Schwarz radiomonitoring software products (R&S®RAMON, R&S®ARGUS)

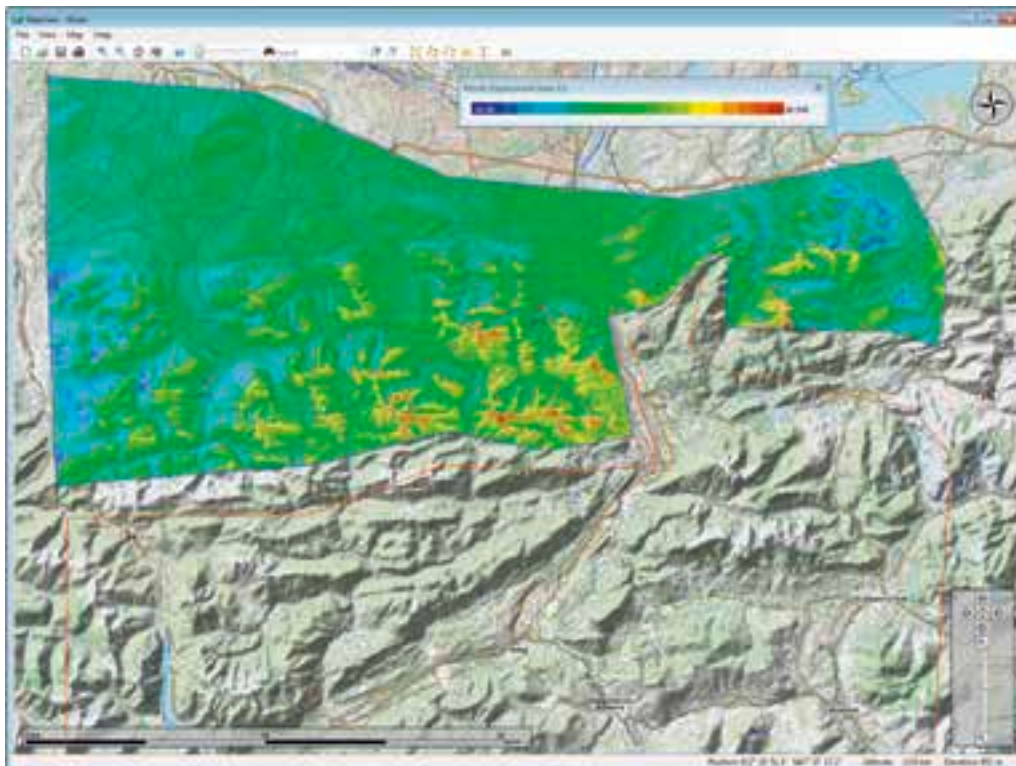

Coloring in the map in proportion to the expected coverage.

Benefits and key features

- Selection of optimum sites for radiomonitoring systems
 - Graphical support for convenient definition of area of interest
 - Easy import of known transmitters and radio networks
 - Recalculation to verify site suitability
 - Fast results when frequently changing the site of a radiomonitoring system
 - Support in planning radio networks for monitoring systems
 - Support in evaluating intercepted radio signals
- Out-of-the-box solution
 - Intuitive, menu-guided operation even for less experienced users
 - Immediate deployment with publicly available elevation data
 - Single-source solution: interfaces to other Rohde&Schwarz software products
 - Propagation models for every application

Specifications		
Integrated propagation models		
ITM (Longley Rice)		20 MHz to 20 GHz
Okumura Hata	terrain data not taken into account	150 MHz to 1.5 GHz
ITU-R P.452-13	terrain data not taken into account	700 MHz to 50 GHz
Optical line of sight		
Free space (ITU-R P.525-2 point-to-point)		
ITU-R P.1546	with R&S®PCT-ME option	30 MHz to 3 GHz
ITU-R P.526	with R&S®PCT-ME option	20 MHz to 15 GHz
ITU-R P.533	with R&S®PCT-FE option	2 MHz to 30 MHz
Interfaces		
To R&S®RAMON, radiomonitoring and radiolocation software		more information at www.rohde-schwarz.com/product/ramon
To R&S®ARGUS, radiomonitoring software for spectrum monitoring and management		more information at www.argus.rohde-schwarz.com
Elevation data formats		
DTED0/1		digital terrain elevation model
SRTM 1/3		data from shuttle radar topography mission with resolution of 1 or 3 arc seconds

Ordering information		
Designation	Type	Order No.
Propagation Calculation Tool, for radiomonitoring systems: site planning for sensor stations based on wave propagation calculation and circular error probability (CEP) ¹⁾	R&S®PCT-COV	3028.0562.02
Options		
Propagation Calculation Tool, for radiocommunications networks: planning of radiocommunications links between attended and remote sensor stations based on wave propagation calculation ²⁾	R&S®PCT-P2P	3028.0579.02
Additional Propagation Models for R&S®PCT: ITU-R P.1546, ITU-R P.526 ²⁾	R&S®PCT-ME	3028.0585.02
Radio Propagation Model for sky waves in the HF frequency range ²⁾	R&S®PCT-FE	3028.0604.02
Radio Propagation Coverage Calculation for transmission systems; planning of spatial distribution of such stations ²⁾	R&S®PCT-TX	3028.0591.02
Additional software required		
R&S®RAMON Basic Module (required for any PC running R&S®RAMON software): configuration management and licensing of R&S®RAMON software modules	R&S®RA-BASIC	3020.9490.02 (softlock) 3020.9490.04 (hardlock)
Basic Module of R&S®MapView Geographic Information Software: display of raster and vector maps, DTED, situation display editor	R&S®MapView	4046.1205.02 (softlock) 4046.1205.03 (hardlock)
Map options for R&S®MapView Geographic Information Software		
R&S®MapView MapInfo Server: display of vector maps in MapInfo format	R&S®MV-MINF	4046.1434.02
R&S®MapView ESRI Server: display of vector and raster maps in the following formats: ESRI Shape, ESRI Grid, ESRI Coverage Tables, ArcInfo World File, ADRG Image Layer, CADRG Image Layer, ERDAS Image Layer	R&S®MV-ESRI	3029.8273.02

¹⁾ Requires R&S®MapView.

²⁾ Requires R&S®PCT-COV.

R&S®AllAudio Integrated Digital Audio Software

For recording, playback, mixing and distribution of audio signals

R&S®AllAudio, with its functionality, rounds out the range of Rohde&Schwarz spectrum management and radiomonitoring systems. In such systems, R&S®AllAudio can replace analog audio switch matrices and multiplexers. The integrated audio database makes management of all recordings easy and convenient.

R&S®AllAudio processes digital audio signals from receivers and direction finders directly and without loss, and controls system-wide access to this data. The data is accessed either from the R&S®AllAudio main window or via control elements embedded in other software applications. The use of compression algorithms means less bandwidth is needed to distribute audio signals, even via wide area networks (WAN). A software-based intercom facilitates teamwork and coordination.

Key facts

- Integrated digital recording, instant playback, editing and distribution of audio signals without additional multiplexers and cabling
- Automatic search and marking of activity in audio recordings
- Integrated intercom (optional)
- Easy and convenient management of recorded audio signals in an integrated database (optional)
- Embedded controls in the Rohde&Schwarz receiver and direction finder software user interfaces
- Connection to Rohde&Schwarz system databases
- Digitization of analog audio signals with selectable quality (optional)

Benefits and key features

- Fast and easy access to current and recorded audio data
 - Easy to use:
 - Separate or embedded user interface and control elements
 - Access to recordings in integrated audio database
 - Maximum flexibility when working:
 - Simultaneous access to multiple audio channels
 - Instant playback from ring buffer or from database
 - Settable playback speed for recordings
- Integration into R&S®ARGUS and R&S®RAMON systems
 - Access and data distribution via LAN/WAN:
 - Flexible, system-wide signal distribution
 - Flexible user administration and powerful intercom functionality for work quick and effective work
- Automatic functions for enhanced efficiency
 - Automatic recording control
 - Automatic search and marking of activity in audio recordings

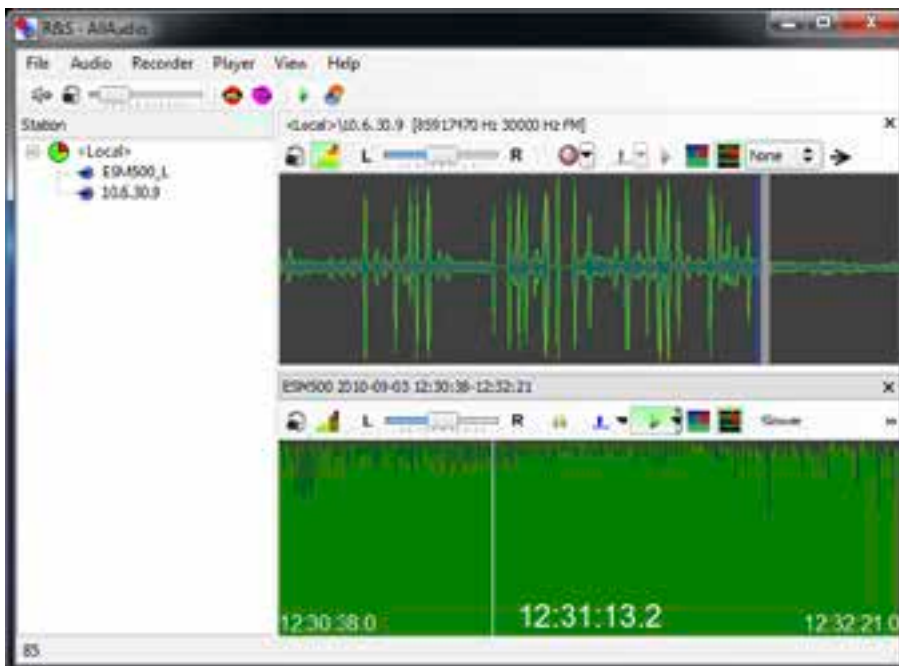

R&S®AllAudio main window.

Specifications		
Signal quality		telephone quality (8 kHz, 16 bit), radio quality (22 kHz, 16 bit) or high audio quality (44 kHz, 16 bit), R&S®AMMOS® 16k, R&S®AMMOS® 32k
Frequency range	telephone/radio/high audio quality	20 Hz to 3.5 kHz/20 Hz to 10 kHz/20 Hz to 20 kHz
Compression rates for data transmission via LAN/WAN		2-fold (ADPCM), 4-fold (GSM), 8-fold (CELP)
Analog audio input channels	2 audio channels for	<ul style="list-style-type: none"> ▮ analog audio (via sound card) ▮ digital audio from Rohde & Schwarz instruments (e.g. R&S®DDF0xA/E, R&S®EM100, R&S®ESMD) ▮ digital audio from other R&S®AFBASIC modules (TCP/IP point-to-point connection via LAN/WAN) ▮ digital audio from other R&S®AFBASIC modules (UDP/IP point-to-multipoint connection via LAN)
Analog audio output channels		2 analog channels for audio monitoring by headset or loudspeaker (left and/or right)
Audio matrix and mixer		audio input channels can be mixed or switched to the two audio monitoring outputs or to other optional output channels
Audio distribution		output and distribution to other R&S®AFBASIC modules via configurable audio channels
Time for instant playback	settable	up to 5-minute audio buffer
Interfaces		integrated interfaces to R&S®RAMON and R&S®ARGUS databases and to Rohde & Schwarz receiver and direction finder systems
Options		
R&S®AF-D8		8 additional digital audio input channels
R&S®AF-REC		audio recording and local audio database
	functions	<ul style="list-style-type: none"> ▮ digital audio recording to hard disk ▮ search and playback while recording ▮ entry of bookmarks and audio comments (via microphone) during recording or playback
	control modes	<ul style="list-style-type: none"> ▮ manually triggered recording ▮ level-triggered recording ▮ activity-triggered recording (VOX control) ▮ externally triggered recording (e.g. from R&S®RAMON systems) ▮ time-triggered recording
	management of saved audio	<ul style="list-style-type: none"> ▮ integrated local database with backup and export functions ▮ management of audio sessions that contain one or more recorded WAV files ▮ storage of time stamps, time-referenced bookmarks and receiver names
	audio server	server for controlling remote access from other R&S®AllAudio workstations (see also R&S®AF-RREC)
R&S®AF-RREC		remote access to audio database, remote controlled recording
R&S®AF-ICM		voice communications between operators in a LAN/WAN
	typical modes	<ul style="list-style-type: none"> ▮ between two users (point-to-point) ▮ within a user group (LAN: multipoint-to-multipoint; WAN: point-to-multipoint) ▮ automatic muting of audio signals during a call

Ordering information		
Designation	Type	Order No.
Basic Module of the R&S®AllAudio Integrated Digital Audio Software, licensing via softlock	R&S®AFBASIC	3022.6023.02
Basic Module of the R&S®AllAudio Integrated Digital Audio Software, licensing via dongle	R&S®AFBASIC	3022.6023.03
Basic Module of the R&S®AllAudio Integrated Digital Audio Software, licensing via dongle at R&S®RAMON/ARGUS workstations	R&S®AFBASIC	3022.6023.04
Options		
R&S®AllAudio Digital Channel Expansion	R&S®AF-D8	3022.6469.02
R&S®AllAudio Recording and Database	R&S®AF-REC	3022.6117.02
R&S®AllAudio Remote Recording and Database	R&S®AF-RREC	3022.6223.02
R&S®AllAudio Intercom	R&S®AF-ICM	3022.6317.02

R&S®UMS170 Compact Radiomonitoring System

The R&S®UMS170 combines state-of-the-art receiver technology with flexible communications capabilities and a control PC in a compact all-weather cabinet. The result is an extremely powerful and versatile radiomonitoring system that is ideally suited for outdoor use.

This system's outstanding RF characteristics make it possible to monitor wideband signals (e.g. from DVB-T transmitters) and reliably detect short-duration signals and frequency agile transmitters. High system sensitivity and an integrated preselection filter make the system ideal for deployment in difficult signaling environments. The system's minimum infrastructure requirements and highly flexible remote control capabilities make selecting an operating site easy.

Two tried-and-tested software packages – R&S®ARGUS for spectrum monitoring and R&S®RAMON for communications intelligence (COMINT) – are available for the R&S®UMS170. This software also allows quick and easy integration of the R&S®UMS170 into existing radiomonitoring systems. The use of open interfaces in the hardware and operating system makes it possible for customers and system integrators to develop their own software applications. The R&S®UMS170 is the ideal system for a very broad range of monitoring tasks.



All ports are located on the bottom of the system for weather protection. (This photo shows the system with the optional all-weather cabinet).

Key facts

- Complete radiomonitoring system in a compact, all-weather cabinet suitable for outdoor use
- Wide frequency range from 9 kHz to 7.5 GHz
- Open interfaces
- High system sensitivity

Benefits and key features

- Integrated latest-generation monitoring receiver from Rohde&Schwarz
 - Wide frequency range from 9 kHz to 7.5 GHz for monitoring signals previously not detectable by classical receivers
 - Extremely high scanning speed and digital signal processing for detecting frequency agile signals and bursts (short-duration transmissions)
 - Integrated preselection for operating the R&S®UMS170 in the vicinity of powerful transmitters
 - 10 MHz realtime bandwidth for monitoring wideband signals
 - High system sensitivity for detecting even very weak signals
- Use in different radiomonitoring applications
 - Spectrum monitoring using the optional R&S®ARGUS software
 - COMINT using the optional R&S®RAMON software
 - Customer-specific software applications made possible by the system's open interfaces
- Integrated powering and control of external components
 - Powering of active antennas via optional DC feeds
 - Control of external components, such as RF relays, via switching outputs
- Flexible operating concept
 - Remote control via LAN/WAN or mobile radio networks (GSM/UMTS)
 - Local operation, especially for system configuration and integration
 - Full access to internal control PC and receiver
- Easy selection of operating sites due to minimum infrastructure requirements
 - Compact dimensions
 - Flexible power supply concept (AC and DC, can be applied simultaneously)
 - Remote control via LAN/WAN or mobile communications networks
 - Low power consumption

Specifications		
Receiver data		
Frequency range	base unit	9 kHz to 3.5 GHz
	with R&S®UMS20-FE option	9 kHz to 7.5 GHz
Scan speed	with R&S®UMS20-PS option	up to 1.8 GHz/s
IF spectrum display range		1 kHz to 10 MHz (1/2/5/10/20/50/100/200/500 kHz, 1/2/5/10 MHz)
Display modes		normal (clear/write), average, max. hold, min. hold
Preselection		included
Demodulation		AM, FM, USB, LSB, ISB, pulse, CW, I/Q
Interfaces		
External		
DC voltage input		7-contact circular connector
AC voltage input		4-contact circular connector
LAN		10/100 Mbit Ethernet, RJ-45 female
DC voltage output		24 V DC, max. 500 mA, 5-contact circular connector with two open-drain drivers
Communications antenna		N female, 50 Ω ¹⁾
Monitoring inputs		N female, 50 Ω, 9 kHz to 7.5 GHz, 0 V DC; two inputs with internal switch (SPDT); only one input active
Internal (after opening the lockable door)		
Monitor		DVI-D female (digital, single-link)
USB		2 × USB female, type A, USB 2.0
SIM card		mini-SIM 1.8/3 V ¹⁾
General data		
Power supply		100 V to 240 V AC, 50 Hz to 60 Hz, max. 200 VA 10 V to 30 V DC, max. 125 W
Operating temperature range, without direct sunlight	base unit	-30°C to +40°C
	with all-weather cabinet ²⁾	-30°C to +50°C
Storage temperature range		-30°C to +70°C
Degree of protection	base unit	IP54
	with all-weather cabinet ²⁾	IP55
Relative humidity		95 % cyclic test, at +25°C/+40°C
Shock		in line with EN 60068-2-27, MIL-STD-810E, method 516.4, procedure 1
Vibration	sinusoidal	in line with EN 60068-2-6
	random	in line with EN 60068-2-64
Electromagnetic compatibility (EMC)		in line with EN 55022, ETSI EN 301489-1, ETSI EN 301489-22
Dimensions (W × H × D)	base unit	300 mm × 445 mm × 175 mm (11.81 in × 17.52 in × 6.89 in)
	with all-weather cabinet ²⁾	380 mm × 530 mm × 240 mm (14.96 in × 20.87 in × 9.45 in)
Weight	base unit	8 kg (17.64 lb)
	with all-weather cabinet ²⁾	12 kg (26.46 lb)

¹⁾ Requires R&S®UMS12-B14 option.

²⁾ R&S®UMS12-B1 option.

Ordering information		
Designation	Type	Order No.
Compact Radiomonitoring System The base unit includes the inner enclosure with an RF module (9 kHz to 3.5 GHz), a control PC, LAN, power supply, heating and communications.	R&S®UMS170	3046.1809.02
Accessories (included) AC and DC power cables, wall-mounting materials, CD-ROM with documentation		
Options		
Frequency Range Extension, 3.5 GHz to 7.5 GHz	R&S®UMS20-FE	3039.3616.02
Panorama Scan (RF scan, fast FFT scan with user-defined frequency intervals, adjustable spectral resolution)	R&S®UMS20-PS	3039.3622.02
R&S®ARGUS V5.4 Monitoring Software (basic package) (includes basic module, audio recording and replay, and drivers for the receiver and switch)	R&S®UMS17-SWB	3046.2005.02
Wireless Module for GSM/UMTS	R&S®UMS12-B14	3035.1090.02
Accessories		
HF Wideband Antenna, 100 kHz to 1.3 GHz	R&S®UMS12-H11	3035.1225.02
VHF/UHF Antenna, 20 MHz to 1.3 GHz	R&S®UMS12-H12	3035.1231.02
SHF Antenna, 800 MHz to 8 GHz	R&S®UMS12-H13	3035.1248.02
All-Weather Cabinet (including mast-/wall-mounting kit, lockable)	R&S®UMS12-B1	3035.1048.02
Base Mast with tripod (height: 1.7 m)	R&S®UMS12-H1	3035.1154.02
Boom for supporting two antennas or two R&S®UMS12-H31 to -H35 mounting brackets	R&S®UMS12-H2	3035.1160.02
Grounding Kit	R&S®UMS12-H3	3035.1177.02
Tool Kit	R&S®UMS12-H4	3035.1183.02
DC Feed for active antenna, 100 kHz to 3 GHz	R&S®UMS12-H6	3035.1202.02
Antenna Cable, length: 3.5 m, 2 × N male, EF400	R&S®UMS12-H21	3035.1260.02
Antenna Cable, length: 3.5 m, 1 × N male, 1 × SMA male	R&S®UMS12-H22	3035.1277.02
Antenna Cable, length: 5 m, 2 × N male, RG214	R&S®UMS12-H23	3035.1283.02
Mounting Bracket for attaching R&S®HE010 to base mast/boom	R&S®UMS12-H31	3035.1331.02
Mounting Bracket for attaching R&S®HE500 to base mast/boom	R&S®UMS12-H32	3035.1348.02
Mounting Bracket for attaching R&S®HL033 to base mast/boom	R&S®UMS12-H33	3035.1354.02
Mounting Bracket for attaching R&S®HL040 to base mast/boom	R&S®UMS12-H34	3035.1360.02
Mounting Bracket for attaching R&S®HL024A1 to base mast/boom	R&S®UMS12-H35	3035.1377.02

For details on additional monitoring antennas and cables, refer to the current Rohde&Schwarz antenna catalog (HF-VHF/UHF-SHF Antennas, printed version: PD 0758.0368.42, CD-ROM: PD 0758.0368.52).

For further R&S®ARGUS options, see R&S®ARGUS product brochure (PD 5213.9657.12).

When using the R&S®UMS170 in COMINT applications, it is also possible to use R&S®RAMON software modules. The R&S®RAMON product brochure (PD 5214.3152.12) provides an overview of available modules and their functions. Further options and accessories are available upon request.

R&S®UMS200 Radiomonitoring and Direction Finding System

The R&S®UMS200 is a complete radiomonitoring and direction finding (DF) system for the frequency range from 9 kHz to 7.5 GHz (direction finding from 20 MHz to 3 GHz). The wide operating temperature range, the flexible power supply and the compact design place minimal demands on the infrastructure. Diverse options for remote control and local operation provide a high degree of flexibility and versatility.

The base unit consists of a receiver, control PC, LAN and power supply. It can be extended by adding a second receiver, a direction finder, compass and GPS receiver. All components are accommodated in compact, weather-proof, climate-controlled housing which can be mounted on a mast or a wall.

R&S®ARGUS can also be used with the R&S®UMS200. The tried-and-tested monitoring software package allows the R&S®UMS200 to be integrated quickly and easily into existing radiomonitoring systems. The open interface enables customers and system integrators to develop their own software applications.

Key facts

- True two-channel system for simultaneous direction finding and measurement or monitoring
- High sensitivity and outstanding system performance
- Designed for outdoor use
- Minimal infrastructure requirements

Flexible operating concept

The R&S®UMS200 offers two control methods. In the basic configuration, the operating system (Windows XP Embedded) and all equipment interfaces are publicly available and documented. End customers and system integrators can develop their own software applications for customer-specific requirements. Rohde&Schwarz also provides optional monitoring software.

Flexible remote control

The R&S®UMS200 was designed as an unattended, remote controlled radiomonitoring and DF system. The system comes with a LAN interface for remote control. High data transfer rates help ensure that all measured data (i.e. measurement values, bearings, audio data, IF spectra, I/Q data) is transferred without loss to the monitoring control center, where it can be analyzed and processed.

Users have the option of controlling the R&S®UMS200 remotely via 2G/3G mobile radio networks. The system can be factory-equipped with modules for GSM/UMTS and CDMA/CDMA2000®. 2G networks (GSM, CDMA) in particular have significantly lower transmission rates. The intelligent control mechanisms in the Rohde&Schwarz monitoring software make optimum use of the network bandwidth. Compression algorithms, for example, reduce the data volume in audio signals and help ensure that the monitoring control center receives the audio data needed for analysis and identification.



Ready for local operation

The R&S®UMS200 has connections for a keyboard, mouse and monitor. After the protective plate has been removed, the R&S®UMS200 is ready for use in a fixed monitoring station or a vehicle. The changeover to local operation is fast and easy, an important prerequisite for integration in vehicles.

Standalone solution and large network

Even a single R&S®UMS200 is an extremely high-performance monitoring station, both in local operation as a standalone solution or as an unattended remote controlled station. The system's strengths become clear when it is networked with other stations: In a network with other direction finders, cross-bearing fixes and triangulation can be performed to determine the precise location of a transmitter.

To use the R&S®UMS200 in Rohde&Schwarz monitoring networks, the user only needs to update the system configuration. The R&S®UMS200 can also be integrated in other networks via its open interfaces.

Four antenna inputs

Four antenna inputs are available for all tasks, frequencies and polarizations. Depending on the configuration (number of receivers and the presence of the direction finder), various switching options are implemented.

The optional R&S®UMS12-H6 DC feed allows the use of active antennas. The antennas receive their power directly from the R&S®UMS200.

Extremely high frequency accuracy

The optional R&S®UMS20-B3 frequency reference delivers an extremely accurate time and frequency reference. The 10 MHz reference signal has an accuracy of up to 5×10^{-12} (GPS synchronized, 24 h average).

Compact design

The size of the R&S®UMS200 has been kept to an absolute minimum by systematically using modules and components instead of entire instruments. As a result, the system is so compact that it can be installed on the mast right next to the antennas. It is easy to find an installation location because a separate building or shelter is not necessary.

The modular design also minimizes power consumption, which reduces operating costs.

Flexible power supply

The system can be supplied with power both from an AC network (100 V to 240 V AC) and a DC supply (10 V to 30 V DC).

It can be simultaneously fed with AC and DC power. AC power has priority. In the case of an AC power failure, the system automatically switches over to the DC power supply – with no interruption in operation.

Prepared for all environments

The R&S®UMS200 was specifically developed for outdoor use. When the system starts up, the temperature control system integrated in the weatherproof, climate-controlled housing makes sure the operating temperature has been reached before components such as the receiver, direction finder and control PC are turned on. If necessary, the internal heater is switched on. If the internal temperature rises above the maximum operating temperature, due to continuous exposure to strong sunlight for example, the temperature control system automatically turns off components to prevent damage from overheating. They are only put back in operation when the temperature has returned to an uncritical level.

Internal fans provide constant air flow which distributes waste heat over a heat exchanger to the external walls where it is dissipated via cooling fins.

A weather protection cover (R&S®UMS20-B4) can be used to increase the operating temperature range. The cover protects the R&S®UMS200 from direct sunlight and is available as an accessory. The cover comes with integrated fans that improve the dissipation of waste heat via the cooling fins.

Specifications		
Receiver data		
Frequency range		9 kHz to 3.5 GHz, optionally up to 7.5 GHz
Scan speed		up to 1.8 GHz/s
IF spectrum display range		10 kHz to 10 MHz
Preselection		included
Demodulation		AM, FM, USB, LSB, ISB, pulse, CW, I/Q
DF data		
Frequency range		20 MHz to 3 GHz (depending on the DF antennas)
DF method		correlative interferometer
Interfaces		
RF IN 1 to 4		antenna inputs, 4 × N female, 50 Ω
AC IN		AC power supply, 4-contact circular connector
DC IN		DC power supply, 7-contact circular connector
LAN		10/100 Mbit LAN
COM ANTENNA		connector for communications antenna
GPS SENSOR		connector for external GPS receiver
COMP SUPPLY, COMP COM		connector for external compass
GPS ANTENNA		GPS antenna input for frequency reference option
REF OUT		10 MHz reference frequency for external devices
DC OUT		DC output for supplying active antennas
EXT FAN		connector for external fan
General data		
Power supply		100 V to 240 V AC, 50 Hz to 60 Hz, max. 350 VA 10 V to 30 V DC, max. 15 A
Operating temperature range	without direct sunlight	
	base unit without options	−30°C to +45°C
	maximum configuration, without external fans	−30°C to +35°C
	with weather protection cover (R&S®UMS20-B4 option)	−30°C to +50°C
Storage temperature range		−40°C to +70°C
Relative humidity		95% cyclic test, at +25°C/+40°C
Protection class		IP 65
Vibration	sinusoidal	5 Hz to 55 Hz 0.15 mm amplitude constant (1.8 g at 55 Hz) 55 Hz to 150 Hz 0.5 g constant
	random	10 Hz to 500 Hz, 1.9 g RMS
Shock		40 g shock spectrum, 11 ms interval, in line with MIL-STD-810E, method 516.4, procedure I
Dimensions	W × H × D	300 mm × 570 mm × 292 mm (11.81 in × 22.44 in × 11.50 in)
	without handles	300 mm × 480 mm × 292 mm (11.81 in × 18.90 in × 11.50 in)
Weight	maximum configuration	28 kg (61.73 lb)
	with weather protection cover (R&S®UMS20-B4 option)	33 kg

Ordering information		
Designation	Type	Order No.
Radiomonitoring and Direction Finding System (base unit includes waterproof housing with RF module (9 kHz to 3.5 GHz), control PC, power supply, heater and communications)	R&S®UMS200	3039.3000.02
Options		
Second Receiver	R&S®UMS20-B1	3039.3100.02
Direction Finder	R&S®UMS20-B2	3039.3200.02
Broadband DF Antenna with R&S®ADD150A Mast Adapter	R&S®UMS20-H11	3039.3500.02
Frequency Reference	R&S®UMS20-B3	3039.3300.02
Wireless Module for GSM/UMTS	R&S®UMS20-B11	3039.3700.02
Wireless Module for CDMA/CDMA2000®	R&S®UMS20-B13	3039.3800.02
Frequency Range Extension, 3.5 GHz to 7.5 GHz	R&S®UMS20-FE	3039.3616.02
GPS Software Interface (for data stream processing of external GPS module (not included))	R&S®UMS20-GPS	3039.3668.02
Panorama Scan (RF scan, fast FFT scan with user-defined frequency intervals, adjustable spectral resolution)	R&S®UMS20-PS	3039.3622.02
R&S®ARGUS 6 Monitoring Software (basic package) (includes basic module, audio recording and replay, drivers for one receiver and one switch; for installation on the R&S®UMS200)	R&S®UMS20-SWB	3039.3400.02
R&S®ARGUS 6 Monitoring Software (extension package) (includes drivers for one receiver, one direction finder, one GPS and one compass; for installation on the R&S®UMS200)	R&S®UMS20-SWE	3039.3416.02
External DC Feed, 100 kHz to 3 GHz	R&S®UMS12-H6	3035.1202.02
Weather Protection Cover	R&S®UMS20-B4	3039.3222.02

Additional DF antennas, monitoring antennas and cables are not included in the scope of delivery and can be ordered separately in line with project-specific requirements. The use of outdoor-suitable connectors requires special control cables for the DF antennas.

For further R&S®ARGUS options, see R&S®ARGUS product brochure (PD 5213.9657.12). If R&S®ARGUS is used for remote controlled operation, the control center must be equipped with a computer that includes the corresponding R&S®ARGUS modules.

Other options and accessories are available upon request.

R&S®UMS300 Compact Monitoring and Radiolocation System

New

The R&S®UMS300 is the first system to combine ITU-compliant monitoring, direction finding with conventional angle of arrival (AoA) and emitter location based on measuring the time difference of arrival (TDOA) in a compact outdoor solution.

The R&S®UMS300 is the latest addition to the successful R&S®UMS family of universal monitoring systems.

The high-performance receiver performs all measurement and direction finding (DF) tasks quickly and reliably. The built-in PC provides the platform for the control software while also controlling the temperature and managing the interfaces.

Since the system was designed for outdoor mast or roof installation, the site selection process is greatly simplified. Short antenna cables significantly boost the system's sensitivity, allowing even weak transmitters to be reliably measured and precisely located.

An Ethernet interface with a router is provided for remote control. Connection via the GSM/3G/4G mobile radio network is possible as an option.

Two tried and tested software packages are available for various applications: R&S®ARGUS for ITU-compliant spectrum monitoring and R&S®RAMON for radiomonitoring. The open interfaces used in the operating system and hardware allow users and system integrators to develop their own control software.

The modular design allows the system to be optimally used in various scenarios.

Key facts

- Complete monitoring and DF system in a compact weatherproof housing
- ITU-compliant monitoring
- Emitter location based on standard direction finding (AoA), TDOA and hybrid direction finding (combination of AoA and TDOA)
- Wide frequency range from 9 kHz to 6 GHz
- Open interfaces



Benefits and key features

- High-performance monitoring and DF receiver from Rohde&Schwarz
 - Wide frequency range from 9 kHz to 6 GHz (direction finding from 300 kHz to 6 GHz)
 - Extremely fast scan with up to 12 GHz/s across entire frequency range
 - IF spectrum and demodulation up to 20 MHz
 - Multichannel DDC signal extraction within realtime bandwidth
 - Integrated GPS with high-accuracy timestamp for TDOA applications
 - Fast, reliable direction finding due to high DF accuracy
 - In line with all applicable ITU requirements and recommendations
- AoA direction finding
 - Extension for conventional direction finding (optional)
 - Reliable DF results even in difficult environments (e.g. urban areas with up to 50% reflection)
 - Use of DF antennas with active/passive switchover; optimum solution for any signal scenario
- TDOA location
 - Use for emitter location within a TDOA network
 - Automated recording of I/Q data with high-accuracy timestamp
 - Use of R&S®UMS300 in any combination with other TDOA capable devices and systems from Rohde&Schwarz thanks to the company's unique technology
- Hybrid AoA/TDOA location
 - Combined benefits of AoA and TDOA
 - Flexible choice of suitable method for given application
 - Use of same hardware for both methods
 - Practically simultaneous use of DF and TDOA capabilities
- Easy site selection due to minimal infrastructure requirements
 - Installation on mast close to antennas; no additional building structure required
 - Remote control via LAN and mobile radio networks
 - Flexible power supply (AC and DC)
 - Compact design
- Use for wide range of monitoring tasks
 - Spectrum monitoring with optional R&S®ARGUS software
 - Radiomonitoring with optional R&S®RAMON software
 - Customized applications based on open interfaces and special software solutions

Specifications in brief		
Receiver data		
Frequency range	base unit	20 MHz to 3.6 GHz
	with R&S®UMS30-HF option	9 kHz to 3.6 GHz
	with R&S®UMS30-FE	20 MHz to 6 GHz
	with R&S®UMS30-HF and R&S®UMS30-FE options	9 kHz to 6 GHz
Scan speed	with R&S®UMS30-PS option	max. 12 GHz/s
Demodulation	all IF bandwidths	AM, FM, pulse, I/Q
	IF bandwidths ≤ 9 kHz	LSB, USB, CW
	IF bandwidths ≤ 1 kHz	ISB
Preselection		included
Direction finding (DF) data		
	with R&S®UMS30-DF option	
DF method	HF	Watson-Watt
	VHF/UHF/SHF	correlative interferometer
Frequency range	base unit	20 MHz to 3 GHz
	with R&S®UMS30-HF option	300 kHz to 3 GHz
	with R&S®UMS30-FE	20 MHz to 6 GHz
	with R&S®UMS30-HF and R&S®UMS30-FE options	300 kHz to 6 GHz
Interfaces		
DC voltage input		7-contact circular connector (DC IN)
LAN		10/100/1000 Mbit Ethernet, RJ-45 (female)
WAN		10/100/1000 Mbit Ethernet, RJ-45 (female)
GPS antenna		SMA female, 50 Ω
COM antenna		N female, 50 Ω
DF antenna control		MIL connector (female)
AUX		5-contact circular connector (female)
Monitoring inputs	N female, 50 Ω	up to 4 inputs, 20 MHz to 6 GHz
		optional 1 input (for future extensions)
General data		
Power supply		22 V to 26 V DC, max. 300 W
Operating temperature range	without direct sunlight	-20°C to +55°C
Storage temperature range		-30°C to +70°C
Relative humidity		95% cyclic test, +25°C/+55°C
Degree of protection		IP65
Shock		in line with EN 60068-2-27, MIL-STD-810-E method 516.4, procedure 1
Vibration	sinusoidal	in line with EN 60068-2-6
	noise	in line with EN 60068-2-64
EMC		in line with EN 55022, ETSI EN 301489-1, ETSI EN 301489-22
Dimensions	W × H × D, without wall bracket	365 mm × 765 mm × 275 mm (14.37 in × 30.12 in × 10.83 in)
Weight		30 kg (66.14 lb)

Ordering information		
Designation	Type	Order No.
Compact Monitoring and Radiolocation System ¹⁾	R&S®UMS300	3051.7701.02
Options		
Switch 1-out-of-2	R&S®UMS30-B1	3051.7801.02
Switch 1-out-of-4	R&S®UMS30-B2	3051.7818.02
Switch 1-out-of-2 (fast switching)	R&S®UMS30-B3	3051.7824.02
DC Feed, DC to 8 GHz	R&S®UMS30-B4	3051.7830.02
Wireless Module GSM/3G/4G	R&S®UMS30-B5	3051.7847.02
External AC Power Supply	R&S®UMS30-H1	3051.7799.02
DF Control Cable	R&S®UMS30-H2	3051.7782.05
R&S®ARGUS 6 Monitoring Software (basic package) ²⁾	R&S®UMS30-SWB	3052.0000.02
R&S®ARGUS 6 Monitoring Software (extension package) ³⁾	R&S®UMS30-SWE	3052.0017.02
Panorama Scan	R&S®UMS30-PS	3051.9810.02
SHF Frequency Range Extension	R&S®UMS30-FE	3051.9827.02
ITU Measurements	R&S®UMS30-IM	3051.9804.02
Selective Call Option	R&S®UMS30-SL	3051.9879.02
Digital Downconverter	R&S®UMS30-DDC	3051.9840.02
Direction Finder Upgrade Kit	R&S®UMS30-DF	3051.9833.02
Wideband Direction Finder	R&S®UMS30-WDF	3051.9862.02
DF Error Correction	R&S®UMS30-COR	3051.9856.02

¹⁾ Base unit includes waterproof housing with receiver (20 MHz to 3.6 GHz), control PC, power supply, heater and communications.

²⁾ Includes basic module, audio recording and replay (ARR) and drivers for one receiver and one switch.

³⁾ Includes driver for one direction finder.

For further R&S®ARGUS options, see R&S®ARGUS product brochure (PD 5213.9657.12).

When the R&S®UMS300 is used in COMINT applications, the R&S®RAMON software modules can be deployed. The R&S®RAMON product brochure (PD 5214.3152.12) provides an overview of available modules and their functions. Monitoring antennas and cables are not included in the scope of delivery and can be ordered separately in line with project-specific requirements.

Other options and accessories are available upon request.

The R&S®ARGUS 6 TDOA option is not to be made, used, sold or offered for sale in the USA or imported into the USA.

R&S®MP007 Portable Direction Finding System

Compact and extremely precise

New

At a glance

The R&S®MP007 direction finding system is based on the R&S®DDF007 portable direction finder upgrade kit in combination with the R&S®ADDx07 compact DF antennas. The result is a unique combination of functionality and performance in a system of this size. It can be used as a stationary or mobile DF station or as a portable manual direction finder, and can be reconfigured within minutes to meet the requirements of the current situation. The R&S®MP007 comes with a wide range of powerful software options and add-ons, making it an excellent choice for all applications that call for a compact and flexible yet powerful DF system.

Vehicle-based mobile reconnaissance systems provide unique capabilities. They allow quick deployment, feature an integrated power supply and offer operators a comfortable working environment. Despite these advantages, vehicles reach their limits when operations must be conducted in impassable areas.

However, modern signal processing technologies not only make it possible to deploy advanced, robust reconnaissance systems in vehicles, but also in equipment that a single person can carry. Soldiers can be outfitted with man-portable communications electronic support measures (CESM) systems, allowing users to conduct operations in difficult topographies and over the “last mile”, where no vehicle can gain access. Such a system passively intercepts communications signals, provides the line of bearing (LOB) and can locate the source of emissions.

The man portable CESM system described here is modular, flexible, field pack equipment that can also be operated from a vehicle or set up at a fixed site. It provides operating forces with the capabilities for intercepting, processing, locating and evaluating threat communications. Unknown signals as well as intercepted audio can be recorded for post-mission offline analysis.

Furthermore, this cost-efficient, man-portable CESM system is interoperable with other fielded reconnaissance assets. It functions either as a standalone system or as an integral part of a larger overall reconnaissance architecture.



System configuration

The heart of the R&S®MP007 portable direction finding system is the R&S®DDF007 portable direction finder. It can be supplemented with different antennas and accessories, depending on the operational requirements.

R&S®DDF007 portable direction finder

The R&S®DDF007 is a compact, lightweight portable direction finder with a wide frequency range of 20 MHz to 6 GHz for direction finding and 9 kHz to 7.5 GHz for receiving. It offers high-precision DF methods that have been tuned to match the R&S®ADDx07 direction finding antenna family.

To make it possible to efficiently search for signals, the integrated wideband receiver allows fast panorama scans across large frequency ranges. The R&S®DDF007 visualizes the results in detail within a high-resolution spectrum view on the large display. Short duration emissions can be detected in the fast spectrogram (waterfall) display through changing colors.

R&S®ADDx07 direction finding antennas

The lightweight R&S®ADD107 and R&S®ADD207 direction finding antennas allow mobile operation while standing and on the move. Together, these DF antennas cover the entire frequency range from 20 MHz to 6 GHz. They can be mounted on top of a backpack, on a vehicle's roof (by means of a magnetic mount), on a tripod or on top of a mast.

The R&S®ADD207 includes circular array antennas with eight elements each for the UHF and the SHF range. The R&S®ADD107 also houses an eight-element array plus a crossed ferrite loop antenna for the VHF range. Both antennas come with integrated GPS capabilities and an electronic compass so that the system is always able to obtain data on its position and on the antenna alignment.

The correlative interferometer principle, combined with 8-element circular antenna arrays, delivers optimum performance in terms of accuracy, sensitivity and immunity to reflections.

Both the R&S®ADD107 and the R&S®ADD207 can be mounted on top of the manpack support frame, which carries the direction finding antenna in a way that is constantly aligned with the soldier. The R&S®ADD307 is mainly used for deployed operation and offers even better DF accuracy due to a larger aperture.

Thanks to the integrated compass, the direction finder always calculates the true line of bearing (LOB).



R&S®DDF007 portable direction finder with map display.



R&S®ADD107.



R&S®ADD207 with R&S®ADD17XZ3 vehicle adapter and R&S®ADD17XZ5 cable set.



R&S®ADD307.

Backpack integration

For manpack on-the-march operation, the DF equipment is integrated into a backpack on a supporting frame. In addition to the R&S®DDF007, the backpack contains a common, central power supply that provides different power voltages to the individual components, a high-performance military battery pack and one LAN switch.

In stationary operation, the antenna height can be increased to approx. 1.80 m by means of two additional mast extensions. Also, the overall operational time of the system can be dramatically increased during stationary operation by connecting an additional solar panel.

Control software

The DF system can be controlled either via the common R&S®RAMON control GUI offering the complete control functionality or via a special web-based GUI for on-the-march operation offering basic system controls. The control PC or laptop can be connected via a wireless local area network (WLAN) link.

If a (ruggedized) laptop or similar device is available for controlling the system (e.g. in stationary or deployed operation), the standard R&S®RAMON control GUI can be used.

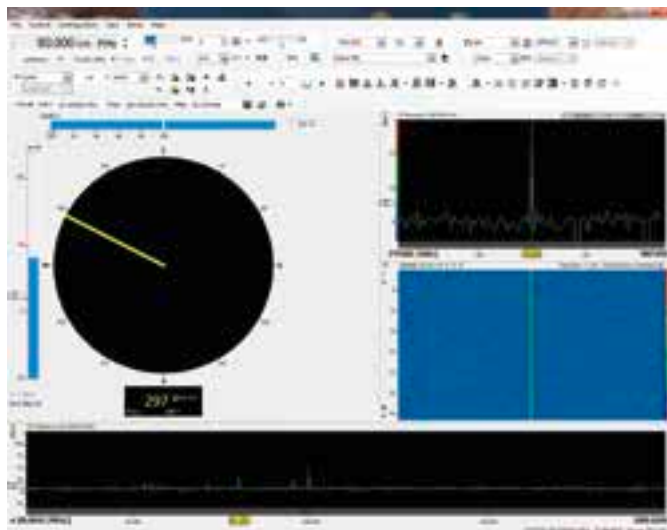

R&S®DF7-CTL control software.

R&S®MP007 components



Backpack integration of the DF equipment consisting of the R&S®ADDx07 DF antenna with mounting adapter, sealed hard shell case, supporting frame with mast extensions and control laptop/handheld PC

Inside view



Backpack integration with the R&S®DDF007, battery pack with 250 Wh, electronic power supply and charging unit and WLAN access point. For extended operation time, a solar panel can be used with system.

With this GUI, the system offers the full functionality of the R&S®DDF007 as a combined monitoring receiver and digital direction finder, e.g.

- Fast panorama scan to get an immediate overview of signal activities in the selected spectrum
- Surveillance of known – i.e. previously identified – emissions of interest by memory scan/memory search of a frequency list or a selected frequency range
- Direction finding of fixed frequency signals (automatic) or frequency hopper signals (manual)
- Location fix for detected signals by homing or via networked operation of at least two man-portable DF systems
- Demodulation of signals and audio recording

Especially when on the march, the use of a big control PC or laptop is not an option. The operator can use a small ruggedized handheld PC with a control GUI especially developed to be operated on small screens with touchpad functionality.

The small display size doesn't allow the use of standard Windows control GUIs, so Rohde&Schwarz has developed a special version of the R&S®RAMON control optimized for touchscreen operation.

The touchscreen GUI allows the operator to set up the important functions to operate the system on-the-march.

The operator can choose between DF, receiver or map view and can easily access all necessary parameters for setting up the system. In networked operation, one man-portable DF system can be defined as a master station and can trigger bearing requests to remote DFs to calculate and display an immediate location fix on the map at the master station.

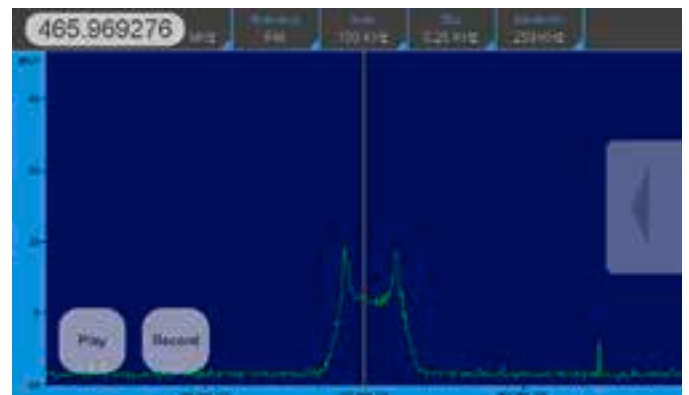

Touchscreen optimized R&S®RAMON control GUI for the man-portable DF system: map view with bearing (upper left), DF/bearing view (bottom left) and spectrum display (bottom right).

System operation

Range of operation

As a standalone system, or in combination with other reconnaissance resources, the R&S®MP007 portable DF system is able to operate in areas that other reconnaissance platforms cannot reach. It extends the coverage of mobile systems and fills in the gaps between deployed units. Also, before mobile or semi-mobile systems enter a theater, the system can gather basic data on points of interest, such as suspicious channels, for further surveillance. Thus, it can provide additional information on special signals of interest and on the overall communications scenario.

Often, when arriving in the mission area, operators know little about local communications. They start their operations by searching for signals.

Then they exploit the radio spectrum step by step, thus tapping into enemy communications.

Autonomous operation

The following typical tasks provide an overview of the system's capabilities:

- Detection of signals and identification of targets in an area of interest where no information is available in advance is performed by searching for signals across wide frequency ranges, without any particular focus on communications channels. Active channels that might have suspicious content can be stored in a frequency list
- Surveillance of the channels that were detected earlier and then put on the frequency list allows monitoring of intercepted signals. Operators can gather information about the communications behavior and the hierarchical structure of communications networks
- Monitoring with the man-portable CESM system means listening in on the demodulated analog audio signal. Gathering the signal content, if possible, provides a valuable asset
- Recording of audio signals makes it possible to collect the adversary's communications content. In the case of intercepted digital signals that cannot be demodulated and decoded online, the system can store the signal's digital intermediate frequency (IF) for post-mission analysis
- Direction finding of the emission yields important information about a target. The result is the LOB, which the system indicates relative to geographic north or relative to the antenna's alignment
- Locating can be performed by taking several LOBs, which is accomplished while moving with the man-portable CESM system tangentially toward the target. Then the system overlaps the LOBs and displays the results on the digital map
- Homing in on an emission is another way to locate an emitter. As homing operators move toward the target (emission), the system indicates the transmitter's direction, allowing operators to steer toward the emission. At the end of such a homing task, operators ultimately arrive at the emitter's position

The system can initially be used for reconnaissance in areas for which no information is available in advance. After gaining an initial overview of the channels or frequency ranges of interest within a specific area, the system can continue surveillance of these targets. Then it helps create a situation picture that becomes more and more detailed with each reconnaissance task that is performed.

Networked operation

The R&S®MP007 can work together with other R&S®MP007 or other Rohde&Schwarz DF systems in networked operation.

The needed data link between several R&S®MP007 can be realized via wireless RF links, e.g. WiMAX™, outdoor WLAN or even military combat net radio equipment.

Each station of the DF network can act as a master station, having the permission to send bearing requests to remote DF stations. The remote DFs will send their DF result (bearing) back to the master station, where the corresponding location fix with coordinates is calculated and displayed on the map.

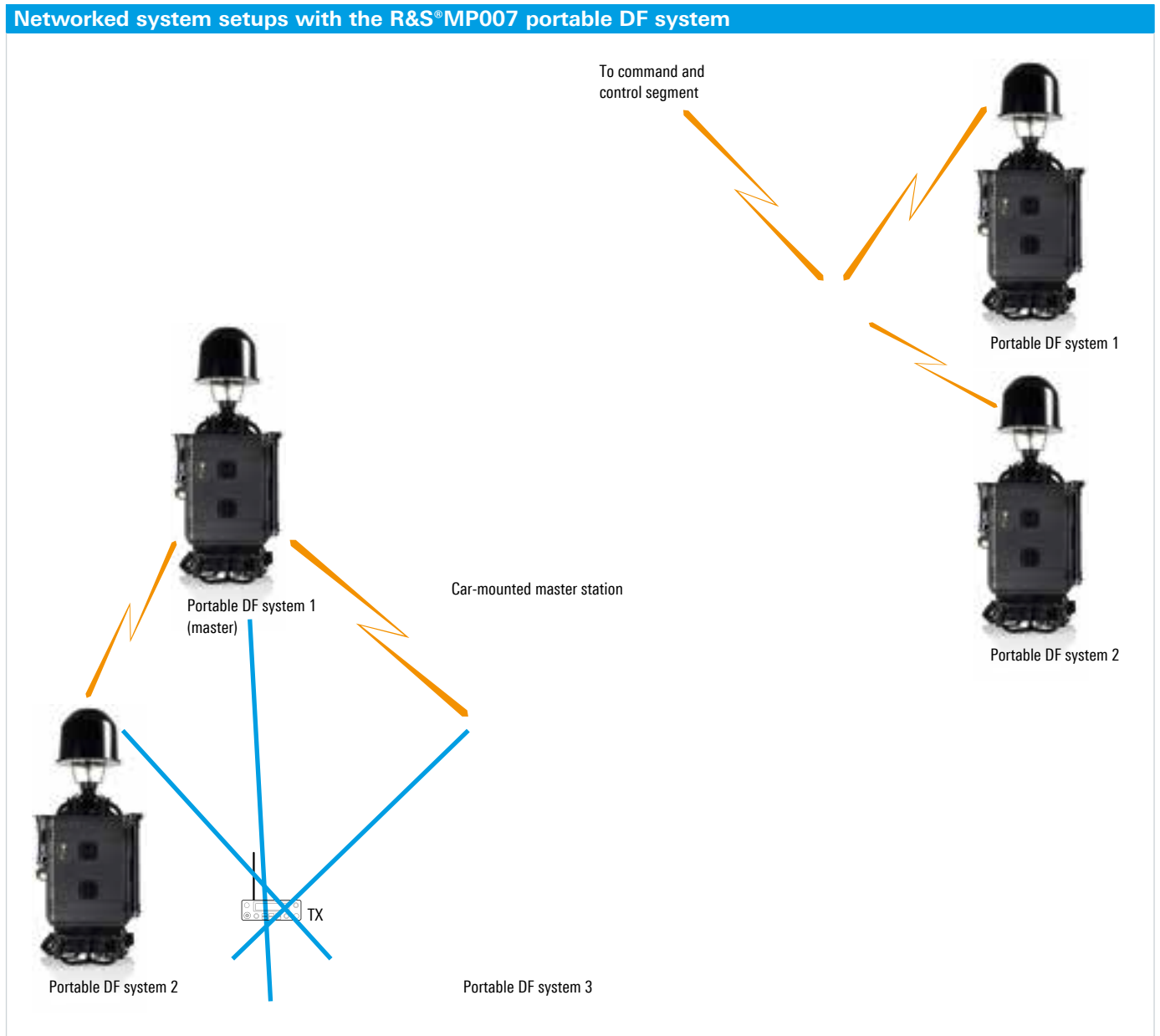

CECM Systems

The purpose of radiocommunications is to transport information from one location to another via a wireless link. The purpose of a communications jamming system is to prevent information from being received at the target location.

A communications jammer can be described as a transmitter that causes interference to radio transmissions by injecting spurious signals into a target communications system. The aim is to prevent communications among one or more participants of a radiocommunications network. For jamming to be effective, the jamming signal field strength at the receiver site must be higher than the signal field strength.

Different transmission methods exhibit differently high resistance to jamming. The capability of a transmission method to reject interference is called the jamming margin. This is the jammer-power-to-signal-power ratio at the receiver input at which signal quality degrades to an extent that renders communications ineffective.

The jamming margin is essentially determined by the process gain (ratio of unspread to spread signal power density) of a transmission method.

To calculate the path loss of the transmitter signal and the jamming signal, radio propagation models are used. A radio propagation model is an empirical mathematical formulation for characterizing radio wave propagation and associated path loss as a function of frequency, distance and other parameters. Each individual radiocommunications link encounters different path conditions in terms of terrain, environment and other phenomena. Expressing the loss for all types of radiocommunications links in a single mathematical equation is therefore an impracticable approach. Consequently, different models exist for different types of radiocommunications links and different propagation conditions. The models rely on computing the median path loss for a specific type of link under a certain probability that the assumed conditions will occur.

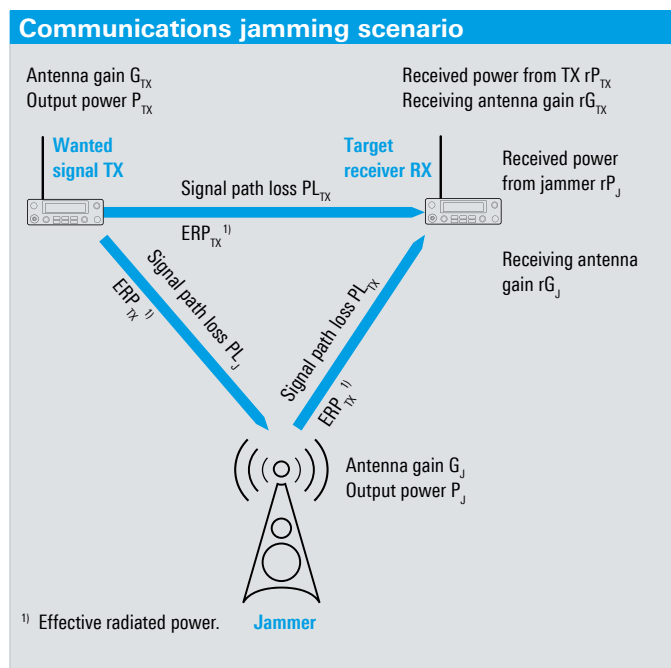

Jammer-power-to-signal-power ratio at target receiver

$$\frac{rP_J}{rP_{TX}} = ERP_J - ERP_{TX} - PL_J + PL_{TX} + rG_J - rG_{TX} \text{ (in dB)}$$

Jammer-power-to-signal-power ratio at target receiver with omnidirectional receiving antenna

$$\frac{rP_J}{rP_{TX}} = EIRP_J - EIRP_{TX} - PL_J + PL_{TX} \text{ (in dB)}$$

Requirements placed on a radio jamming system

Operational aspects

Radio jammers are easy to detect. Jamming is therefore applied as selectively and as briefly as possible. When not used for jamming, radio jammers are mostly employed as additional radiomonitoring sensors.

To prevent early detection and location of a jammer during a jamming operation, a reactive jamming mode such as look-through jamming should preferably be used. Preventive jamming, e.g. wideband or sweep jamming, should be used only in exceptional cases or where reactive jamming does not produce adequate results.

Further measures to prevent detection of a jammer include:

- Deployment of two jamming assets at different sites (coherent jamming):
Depending on their equipment, enemy forces are able to take the bearings of narrowband and even spread jamming signals and to locate the jamming transmitter. This capability can be rendered largely ineffective by deploying two jamming assets at different sites in order to carry out a jamming job. The two assets are supplied with coherent signals which they emit jointly into the target area. This makes it very difficult for the opponent to locate the jamming transmitters. This approach, however, involves significant material and operational effort
- Alternate jamming by different assets:
Different assets taking turns jamming will trick the opponent into believing that the jamming squad is changing position. While this approach involves less technical and material effort, it is dependent on a number of conditions, to enable efficient coordination of the assets involved

Jamming is most effective if it goes unnoticed by the target system. As soon as jamming is detected, the opponent will usually take measures to counteract it (electronic counter-countermeasures – ECCM). It is therefore necessary to survey each jamming operation by means of suitable radiomonitoring systems to be able to respond to target ECCM.

Basically, jamming operations are performed for three different purposes:

- Disruption or strong impairment of target radiocommunications to prevent, at least temporarily, the commanding and control of (military) units or subunits
- Screening of own radiocommunications to prevent reconnaissance by the opponent: emission of very broadband noise toward the opponent's radiomonitoring sensors (opponent's locations are known)
- Opponent deception, for example by emitting opponent's intercepted radio messages at a later time or imitating opponent's radiocommunications

To successfully jam a radiocommunications link, the following requirements must be met:

- The target network is within detection range
- Signal detection, emitter location and parameter analysis have been carried out
- Technical/operational analysis and evaluation have been carried out
- Tactical allocation of link/identification of network has been performed
- The suitability and effectiveness of a jamming operation has been ascertained (exposure of own troops)
- Jamming can be performed effectively in a technical/physical sense

Prior to carrying out a jamming operation, the (military) commander in charge must have ascertained whether the operation will be tactically (operationally) suitable and effective: When enemy forces realize that they are being jammed, they will know they have been detected. The jamming type and method employed make it possible to draw conclusions as to the depth of reconnaissance.

The integrated jamming system must also meet a number of requirements. For a land-based mobile system, for example, these requirements include:

- High mobility
- Use of armored vehicles, if necessary
- Rapid deployability
- Versatile use (jamming, screening, deception)
- Radiomonitoring ability
- Use in joint operations involving multiple jamming assets deploying coherent or alternate jamming
- Verification of jamming impact (by jammer itself or by means of external radiomonitoring system)
- EDP-supported planning and control of jamming operation
- Optimized power system (e.g. generator set, suitable cooling system)

Signal scenario and jamming modes

Broadband and partial-band noise jammers

A broadband noise jammer spreads Gaussian noise over the entire bandwidth B with a total power P_J . The power P_J is equally distributed over the bandwidth B . This results in a jamming power spectral density N_J of

$$N_J = \frac{P_J}{B}$$

A broadband noise jammer does not require any information about the target communications system except for bandwidth. It is a preventive jammer and is usually considered to provide the least sophisticated type of jamming. This jamming mode can be considered equivalent to white Gaussian noise with a spectral density equal to N_J .

A partial-band noise jammer spreads noise power P_J across a bandwidth B_J , where $B_J < B$.

Continuous wave jammer (CWJ) and multitone jammer (MTJ)

A continuous wave jammer jams a discrete frequency with its full power.

A multitone jammer jams multiple discrete frequencies (Z frequencies) simultaneously (in parallel). In this case, the total power decreases as the square of the number of the individual frequencies. The same is true for the power portions applied to the individual frequencies.

If Z frequencies of multiple continuous wave transmission links are jammed, the jamming power will be $1/Z^2$ of the maximally available (full) power. To provide effective jamming, Z must be a value between 2 and 3. Higher values will often result in insufficient jammer-power-to-signal-power ratio at the target receiver. Multitone jamming is

therefore not a viable option when it comes to jamming frequency hoppers. If all Z frequencies of a frequency hopper were to be jammed, the MTJ power available at each target (hop) frequency would hardly produce a noticeable effect. Special jamming modes are therefore required to successfully impact frequency hoppers.

Time division multiplex jamming (fast sequential jamming)

In time division multiplex mode, the full jamming power is applied to each instantaneously transmitted frequency. However, the jamming power for Z target frequencies is available only during $1/Z$ of the time. This means that Z must be a value between 4 and 7 (optionally up to 10) for jamming to be effective.

The use of time multiplex in order to jam multiple frequencies of a frequency hopper is not a viable approach. The probability of hitting one of the targeted hop frequencies by means of time-multiplexed jamming frequencies is at first approximation not higher than when trying to hit just a single hop frequency.

Schematic representation of continuous wave jammer (CWJ) and multitone jammer (MTJ)

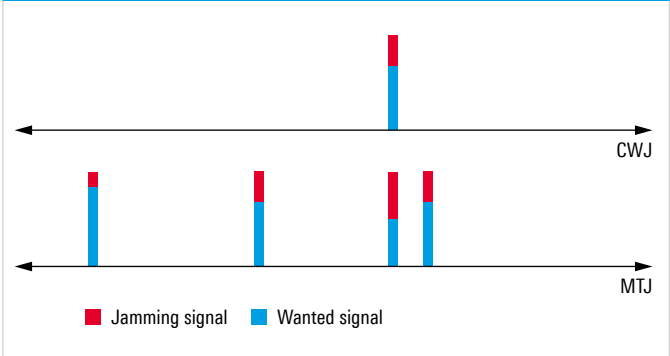

Available jamming power as a function of the number of signals jammed in parallel

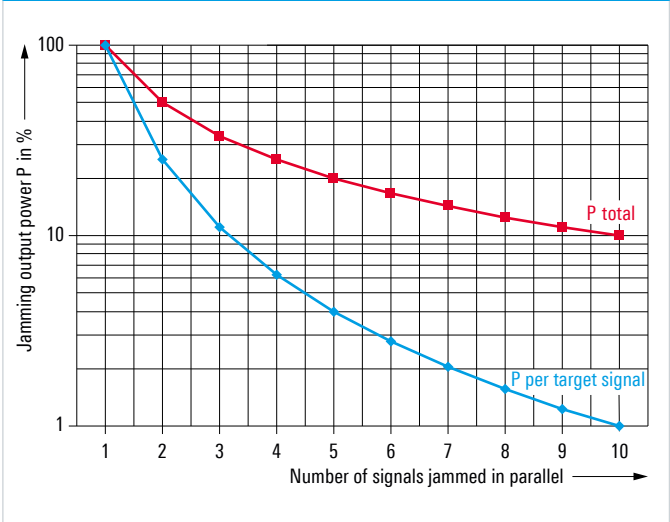

Broadband jamming signal

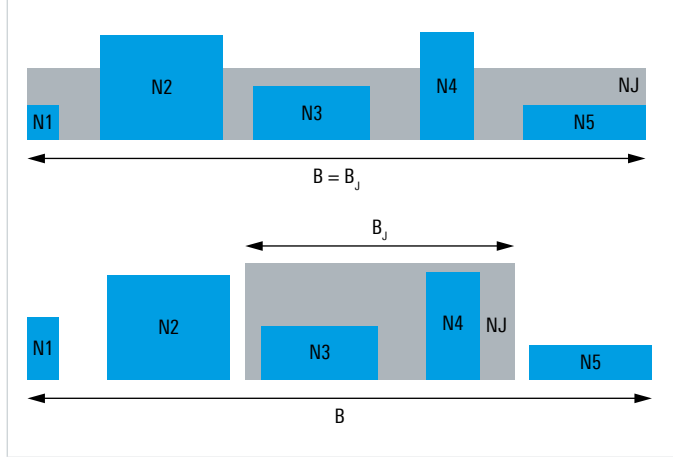

Broadband jamming signal (gray) covering the entire target frequency band (upper half). Partial-band jamming signal (gray) covering only part of the target frequency band (lower half) (wanted signals in blue).

Frequency hopping spread spectrum (FHSS) jamming

In FHSS mode, consecutive time segments of a signal are transmitted on different, predefined frequencies. These frequencies are usually arranged on a grid, and their sequence is determined by the hop code.

The duration of an individual hop is referred to as dwell time and may vary from hop to hop.

The signal is spread across a bandwidth that corresponds to the difference between the highest and the lowest hop frequency.

The signal power is spread across a wide frequency range. The instantaneous signal power density is equal to the average unspread signal power density. The average power density on each hop frequency decreases in proportion to the number of hop frequencies used.

In frequency hopping multiple access (FHMA) mode, multiple users can transmit over the same frequency range. The probability of two signals from two different transmitters colliding on the same hop frequency at the same time

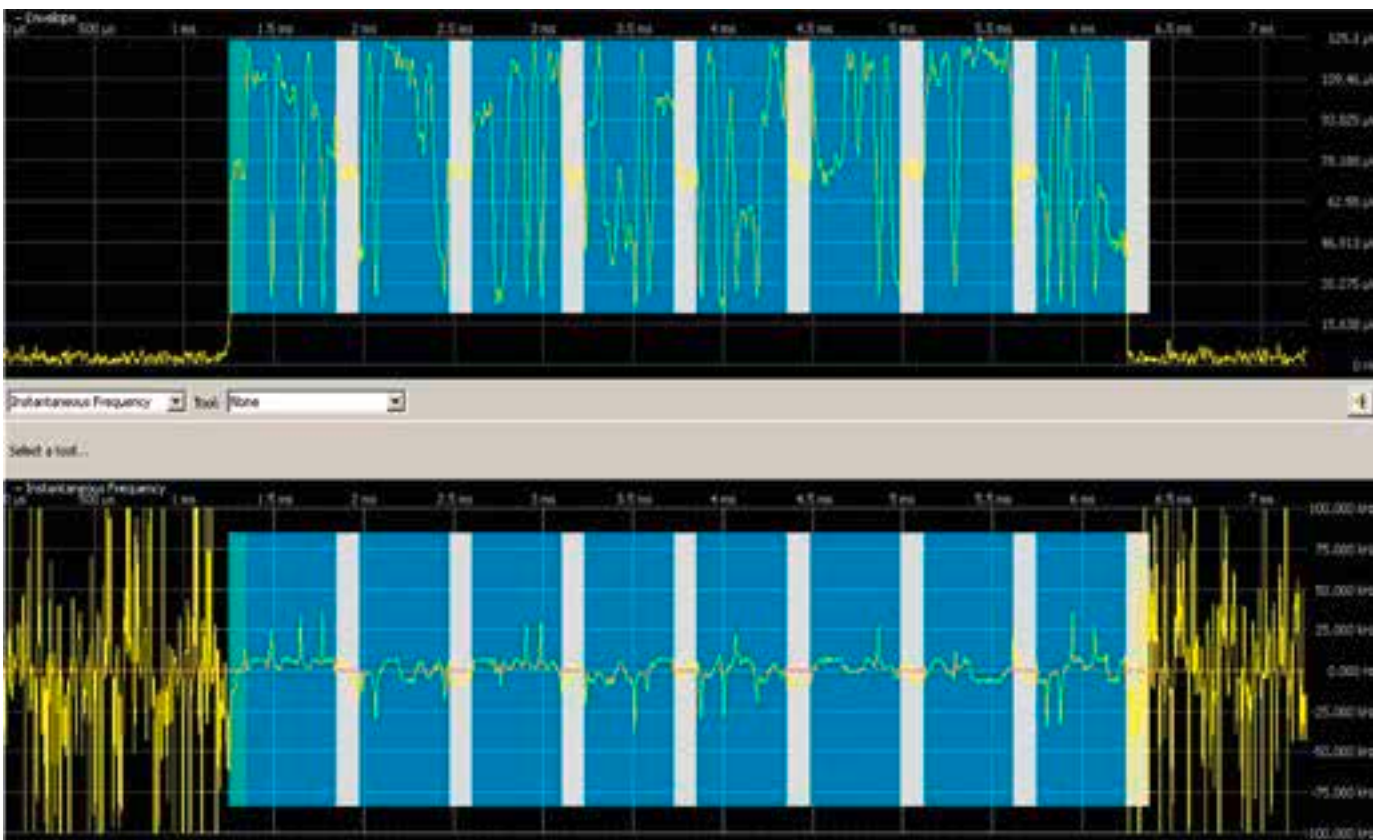
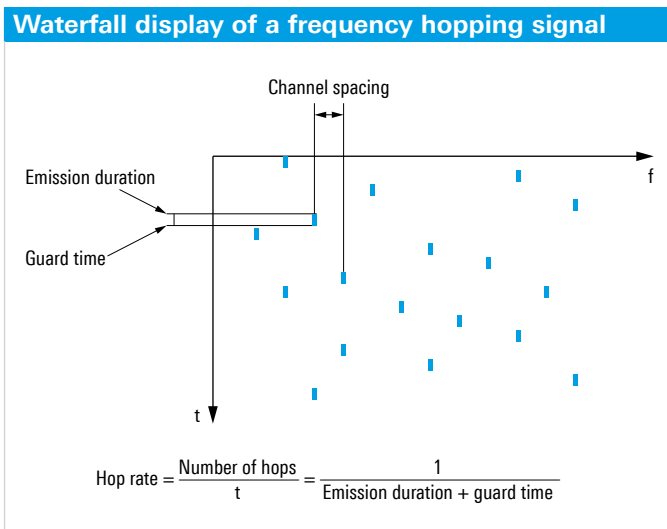

The first jamming pulse (blue) is applied to the signal after approx. 100 μs, following an extremely short detection and identification phase at the beginning of the pulse (green). During the look-through phases (white), the jamming system checks whether the target signal is still active. If this is the case, another jamming pulse is sent. This is repeated until the target pulse is terminated, and the process is continued with the next pulse on the next hop frequency.

can be minimized by using suitable codes. Networks employing such codes are referred to as orthogonal networks.

State-of-the-art FH radios use hop rates between 200 hops/s and 500 hops/s and hop sets comprising several hundred frequencies. In addition, most FH radios employ special anti-jam modes (ECCM) with highly effective forward error correction (FEC).

The major difficulty to be overcome when jamming fast frequency hoppers lies in the fact that the target signal uses only a single channel at a time, whereas the jamming system must be able to monitor all target signal channels at all times and apply a jamming signal to a detected channel at any time.

To successfully jam a frequency hopping link, the jamming system must be able to:

- Monitor the entire frequency range covered by the target signal
- Instantaneously detect and identify the individual hops of the target signal
- Immediately, i.e. within the dwell time of a detected hop, generate and emit an appropriate jamming signal

To meet these requirements, the jamming system must incorporate very wideband detectors, ultrafast excitors and TX/RX switches. Furthermore, wherever possible, a suitable COMINT/CESM system should be used prior to a jamming operation to detect, analyze and evaluate target communications and feed their technical parameters (frequency lists, bandwidths, modulation modes, etc.) to the jamming system.

Direct sequence spread spectrum (DSSS) jamming

In DSSS mode, the signal to be transmitted is convoluted with a spreading code. The code rate is significantly higher than that of the signal data rate. The bits of the spreading code are referred to as chips, and its rate is referred to as chip rate. The spread signal essentially has the same spectral characteristics as the spreading code, which is the reason for the designation “direct sequence spread spectrum”.

The signal power is evenly spread across a wide frequency range and is continuously present. This means that both the average and the instantaneous signal power density are reduced by the spreading factor.

A special form of this transmission mode is code division multiple access (CDMA). This is a code multiplex method that allows multiple users to communicate over the same frequency range at the same time. Interference between users is minimized through the use of codes that are orthogonal relative to one another.

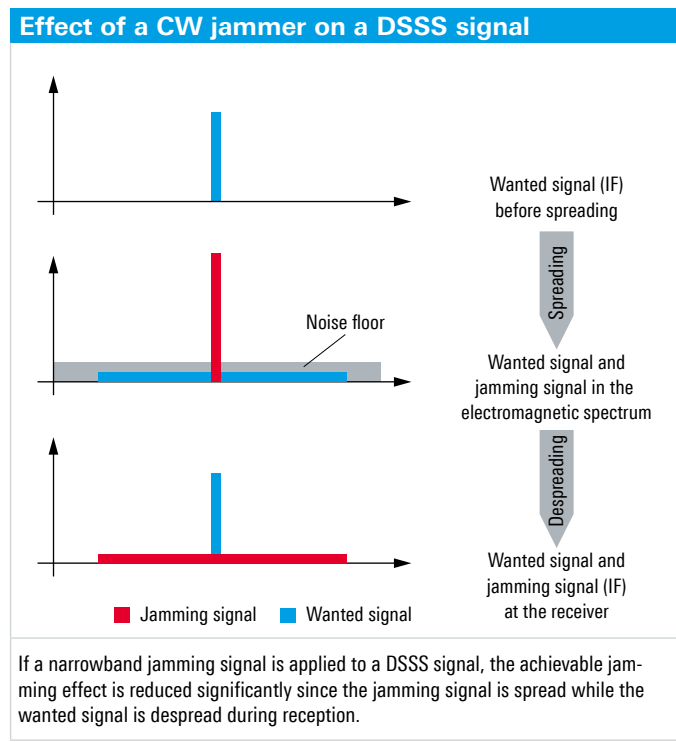

DSSS enhances jamming resistance

As the information signal is despread, other signals in the RX frequency band that do not precisely match the required code will be spread. This applies, for example, to jamming signals.

In this process, the power of such signals is spread across a wide frequency band. As a consequence, only the power portion falling into the now narrowband information signal will be able to impact the information signal. The increased jamming resistance offered by DSSS systems relies on this effect (see figure below).

In the case of DSSS receivers with poorly designed input stages, low-power jamming carriers can cause intermodulation, which may considerably impair reception.

DSSS communications “hide” in the noise floor, which makes them difficult to detect. Targeted jamming is therefore hardly possible. DSSS links, however, employ a power control mechanism in order to keep transmit power as low as possible. A jamming transmitter may deceive a DSSS receiver into believing that the noise floor is higher than it actually is and thus make it emerge from the noise floor.

DSSS signals are most effectively jammed by using a broadband jammer.

Jamming efficiency

To effectively jam analog and digital radiocommunications, the following minimum values should be reached after error correction in the receiver (based on empirical data):

- ▮ Voice (analog)
 - Syllable intelligibility < 20%
 - Word intelligibility < 50%
- ▮ Data (including digitized voice)
 - Bit error rate > 10^{-1}

This applies to all transmission methods.

The jamming margin required in each case depends on the transmission method used, the jamming power, the antenna gain and the distance between the jammer and the target.

Components of an R&S®Viper jamming system

An R&S®Viper jamming system usually includes the following components:

- ▮ Transmit/receive antenna system
- ▮ Transmit/receive power switch
- ▮ Power amplifier including dummy load and cooling system
- ▮ Antenna signal distributor
- ▮ Signal control unit
- ▮ Wideband signal generator
- ▮ Receiver unit including wideband detector and exciter
- ▮ Workstation with control software
- ▮ Communications link to command and control center

A number of these components, for example the power amplifier and the antennas, are system-specific and are therefore tailored to meet the requirements at hand. Factors that impose limitations include, for example, the carrier platform and the available power supply.

The antenna signal distributor connects the appropriate antenna to the receiver unit. The receiver unit with the wideband detector and exciter provides the functionality required for monitoring and detecting emissions in a selected frequency range and generates the baseband signal for the signal control unit.

From the baseband signal, the signal control unit generates the required RF jamming signals and applies them to the power amplifier. The amplifier contains switch-selected filter banks that reduce the harmonics generated during amplification.

The RF power amplifier usually provides very high output powers, which call for a compact and efficient cooling system. Either air or liquid cooling is used, liquid cooling being the choice in space-limited conditions.

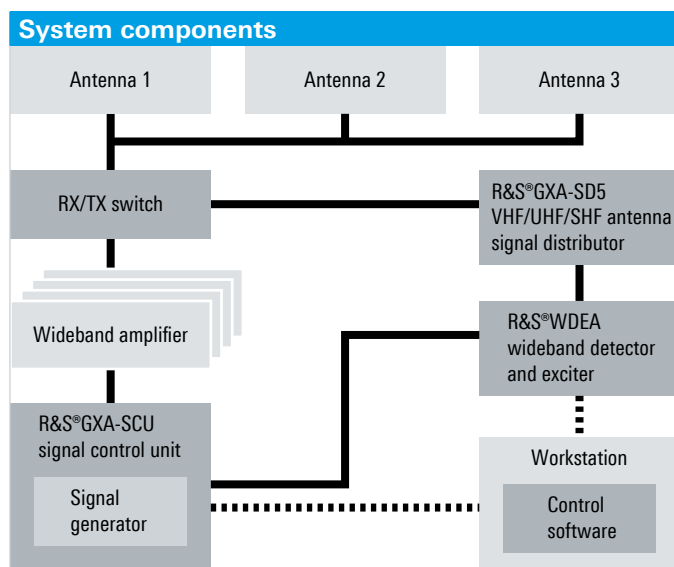

Setup and parameterization of the system, jamming mode selection and system activation take place on the workstation by means of the control software. The workstation can be located directly within the system, for example in a protected vehicle, or at a remote command and control center from which the system is controlled via LAN, WAN, WLAN, WiMAX™ or another type of data link using combat net radios (CNR). All audio signals that have been intercepted and stored can be used to generate AM or FM signals to be emitted in deception mode.

Rohde&Schwarz has supplied radiomonitoring solutions for 25 years. The knowledge and experience thus gained are reflected in its R&S®Viper systems. The entire hardware and software, including all interfaces through to system integration into land-, air- or sea-based carrier platforms, come from the same source.

With its modular design and excellent reception characteristics, the R&S®Viper is ideal for effectively jamming even highly secure communications links. The system can be tailored to meet specific requirements, for example in terms of frequency range, transmit power, scope of functions and antenna system. The system can operate autonomously, or work closely together with an R&S®RAMON based radiomonitoring system from which it receives the required jamming parameters. The radiomonitoring system and the jamming system are perfectly matched to one another for maximum efficiency and flexibility.

The system's wide realtime bandwidth and high scan rates up to 70 GHz/s ensure reliable detection even of fast, frequency agile signals and state-of-the-art hoppers with high hop rates. Unlike conventional jammers, the R&S®Viper achieves this by using a combined wideband detector and exciter (R&S®WDEA). All signal processing tasks such as spectrum calculation, signal detection and jamming signal generation are performed using powerful signal processors and field programmable gate arrays (FPGA) inside the R&S®WDEA. Using a fast Fourier transform (FFT), up to 3200 channels are analyzed at 80 MHz realtime bandwidth with a channel spacing of 25 kHz. With 12.5 kHz channel spacing, as many as 6400 channels can be analyzed at the same realtime bandwidth. 6.25 kHz resolution yields a maximum of 12800 detection channels.

The results delivered by the detector are immediately processed in the exciter of the R&S®WDEA, yielding excellent short response times – a vital prerequisite for selectively jamming fast, frequency agile signals. The wideband detector and exciter perform the following steps:

- Detecting and analyzing a frequency hopping signal within the duration of one hop and across the entire frequency range of interest
- Deciding whether the detected signal should be jammed
- Generating the jamming signal



R&S®Viper radio jamming system for the VHF/UHF/SHF range

To effectively jam state-of-the-art frequency hoppers, all of the above steps must take place in less than 300 μ s. The R&S®Viper radio jamming system is an ideal choice, since the integrated R&S®WDEA wideband detector and exciter detects up to 2000 hops/s over the entire realtime bandwidth, tracks the hopping signal, and applies individually modulated jamming signals to up to 16 target signals. To jam individual hoppers in a multihopper scenario, the system must be able to distinguish between networks. The emitter parameters required for separating networks with different channel spacing are obtained from a radiomonitoring/radiolocation system.

The R&S®WDEA generates digital I/Q signals over the entire realtime bandwidth, including up to 16 jamming signals. The jamming signals can be modulated in various ways, taking into account the fact that many, in particular military, waveforms are to some extent resistant to white noise jamming. For maximum jamming impact, the jamming signals' modulation parameters can be adapted to the signals to be jammed. The wideband digital I/Q baseband signal is immediately converted to the analog transmit frequency and amplified by power amplifiers.

R&S®WDEA wideband detector, exciter and analyzer



- ▀ Realtime bandwidth 20 MHz or 80 MHz
- ▀ Realtime detection of a large number of fast, frequency agile signals
- ▀ Realtime identification of signals of interest, even in densely occupied scenarios
- ▀ Realtime generation of wideband digital I/Q baseband signal, including one or more jamming signals
- ▀ Supply of TX/RX switchover control signals to R&S®GXA-SCU signal control unit (R&S®Viper system response time: approx. 250 μ s)

Satellite monitoring systems

SatCom applications

People can communicate via telephone or data channels virtually everywhere around the world. Communications are based on various bearer services, depending on the topology, the political situation or the level of industrialization and infrastructure in large areas. Local and domestic calls are usually handled via the public switched telephone network (PSTN). International calls are routed around half the globe via deep-sea cables. However, terrestrial networks can neither be installed everywhere, nor is this economically feasible. In scarcely populated hilly or vast landscapes (e.g. the Himalayas, deserts, maritime areas, the polar regions) with only sporadic or little telephone and data traffic, communications via satellite-based radio links are a highly cost-effective and flexible alternative to terrestrial networks. In natural or man-made catastrophic-like situations with destroyed terrestrial infrastructures, satellite-based communications systems often provide the only means of communicating over long distances. In regions with a destroyed infrastructure, communications are mainly restricted to densely populated areas and border areas [1].

Services and organizations entrusted with safeguarding the internal and external security of their country require suitable systems to detect and monitor satellite-based voice and data channels. A demand for such systems exists not only in regions with high satellite communications density. A communications satellite in a geostationary orbit is capable of illuminating more than one third of the earth's surface, and its signals can be accessed everywhere in the illuminated area (footprint) by means of appropriate systems.

Satellite telephones and data terminals are highly flexible, as they rely on the use of GPS information, spot beam technology and satellites with onboard processing (OBP) capability.

Historical development, trends

As early as October 1945, Arthur C. Clarke mentioned, in an article published in *Wireless World*, the possibility of using extraterrestrial relays. However, the idea was not put into practice until almost two decades later when in July 1963 SYNCOM-2, the first geostationary communications satellite, was successfully put into orbit, enabling the professional use of satellite communications (SatCom) [2]. During the 1980s, many SatCom satellites were launched and put into operation, allowing a large number of terrestrial radio relay links or relay systems to be assigned to geostationary satellites. Communications intelligence organizations at that time began to intercept satellite communications using large parabolic antennas.

Since the 1980s, great progress has been made in the field of mobile SatCom via geostationary satellites. Analog transmission was replaced by digital transmission after a few years. The use of increasingly sophisticated signaling protocols, voice codecs and forward error correction (FEC) has steadily improved voice quality, reliability and volume in mobile SatCom. This development has also been significantly promoted by the continuously increasing satellite performance in terms of transmitted power and radio spot-beaming in conjunction with frequency reuse and onboard processing (OBP). The International Maritime Satellite (INMARSAT) organization, for example, has long been a SatCom operator. In the last few years, its global satellite network has fully changed to the fourth generation, and first satellites of the fifth generation have been used commercially for some months. Thuraya, another satellite operator, was founded at the turn of the millennium and has since experienced high growth rates.

With the rise of powerful fiber-optic networks, growth rates have slightly decreased as regards multichannel links. Nevertheless, the demand for satellite communications based on very small aperture terminals (VSATs) linked to major switching centers is increasing (see above). In addition to tried-and-tested standards such as Intelsat Business Service (IBS) and Satellite Multiservice (SMS), which are continuously being improved, new standards, codecs and FEC methods (e.g. MPEG, various voice codecs, turbo codes) increase the capacity and performance of satellite-based transmission links.

Due to the highly flexible communications capacities, users rely on satellite communications even in regions with excellent terrestrial infrastructure. One possible reason for using a SatCom link is to avoid national switching centers that may be monitored, an approach that is referred to as bypassing. Detecting bypass communications of interest may be part of the activities of services and organizations (see SatCom applications).

There is a growing demand for communications because technologies continually improve and communications costs decrease. At the same time, user requirements, e.g. the need for wider transmission bandwidths, increase. The globalization of markets also boosts the volume of communications.

Along with the technological progress, the monitoring of IP-based communications, especially voice over IP (VoIP), has developed into a promising field of activities for services and organizations. Broadband IP-based satellite data links are highly flexible and can handle a large number of subscribers, protocols and services (voice, fax, data). The mobile satellite services offer packet-switched data links with always-on capability, which means that subscribers only pay for the data volume transmitted. For interception, new approaches to processing are required.

Because of the high data volume, intercept systems must be equipped with adequate filters and tools to provide analysts of services and organizations only with the contents that are relevant to a specific mission. Scaling and designing an intercept and analysis system to deliver the desired contents constitutes a major challenge.

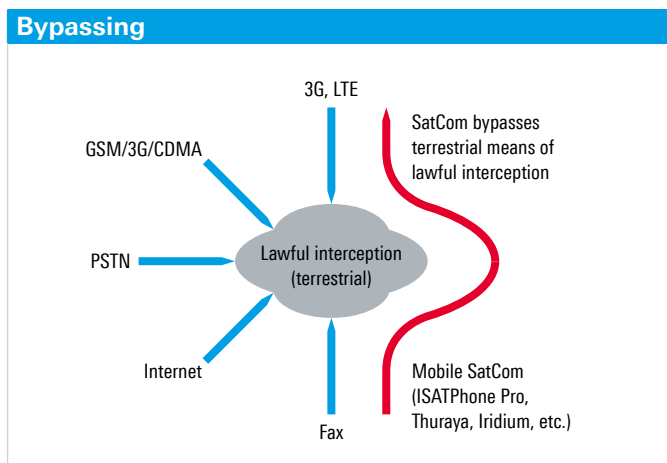

9.5 m C-band antenna installed at Munich site.

Terrestrial and satellite-based technologies are merging. Digital signaling procedures tend to operate more and more independently of the transmission channel, and tried-and-tested communications systems serve as models for new mobile SatCom systems. For example, to a large extent the GMR standard used by Thuraya (GMR-1), ISAT/ACeS (GMR-2) and ISATPhone Pro (GMR-2+) corresponds to the widely used and successful GSM standard. Up to now, VSAT satellite communications systems involved a wide variety of proprietary methods and protocols, but standardization is also on its way in this field (use of the DVB-S2 standard).

Satellite orbit

Most SatCom satellites move in a geostationary orbit. A satellite in geostationary orbit rotates in the plane of the earth's equator synchronously with the earth, i.e. with the same period as the earth's rotation (24 hours), at a height of approx. 36000 kilometers above the earth. Geostationary satellites appear to be stationary to observers on earth. Satellites moving in an inclined geosynchronous orbit rotate in a plane that is inclined relative to the equatorial plane. During a 24-hour period, inclined geosynchronous satellites perform an elevation movement that, viewed from the earth, describes an elongated figure eight with a smaller or larger angle of inclination, depending on the observer's location. To receive signals from inclined geosynchronous satellites, e.g. in the C or Ku band, by means of antennas with large diameters, tracking dish antennas are required. The antenna must be capable of tracking the satellite through its figure eight or the satellite will move outside the antenna's optimum capture range. The larger the antenna diameter, the higher the antenna directivity at a specific frequency. With small dishes and at relatively low frequencies, e.g. in the L band, the 3 dB beamwidth is larger than the satellite's angle of inclination, which eliminates the need for tracking. Another characteristic feature of geosynchronous satellites is the constant signal level they provide to earth stations, which is due to their fixed position above their footprints. Geosynchronous satellites are further characterized by a high free-space loss of approx. 180 dB. The use of high-performance satellites and transmission methods as well as flexible spotbeaming has made it possible to steadily decrease the size of user equipment, in particular in mobile SatCom. SatCom systems relying on a large number of low-earth-orbit (LEO) satellites have higher operating costs. Under certain conditions, LEO systems (e.g. Iridium) outdo the geosynchronous (GEO) systems. LEO systems enable, in particular, telephony in polar regions.

Frequency bands

The L, C, Ka and Ku bands are currently the most widely used SatCom frequency bands. The table and figure include uplink and downlink frequency values for a number of bands. Technical literature specifies slightly varying values for the band limits, see [1] and [2].

Interception principle

During telephone calls via satellite in full-duplex mode, voice information is transmitted in both directions simultaneously. To capture duplex traffic at the radio interface, it would appear appropriate to pick up the uplink and downlink signals of a mobile earth station (MES) by means of suitable antenna systems. However, this type of interception is difficult, especially with passive radiomonitoring of MES (e.g. Thuraya or INMARSAT telephones). Geographic conditions, low MES transmit powers, and possibly the use of directional transmit antennas, allow reliable reception of uplink traffic only within close range of the MES (several hundred meters to several kilometers).

Reliable coverage of larger areas can be achieved by monitoring two downlink paths (e.g. in the L and the C band or the C and the Ku band) using appropriate antenna systems and frequency downconversion and distribution (see figure). Under certain conditions, small (semi-)mobile systems for the direct interception of uplink and downlink

Typical frequencies			
Frequency band	Downlink	Uplink	User group
VHF/UHF	< 1 GHz	< 1 GHz	Military
L band	1.53 GHz to 2.7 GHz		Mobile
C band	3.7 GHz to 4.2 GHz	5.925 GHz to 6.425 GHz	TV, telecommunications
X band	7.25 GHz to 7.75 GHz	7.9 GHz to 8.4 GHz	Military
Ku band (Europe)			
FSS service	10.7 GHz to 11.7 GHz	12.75 GHz to 13.25 GHz, 13.75 GHz to 14.5 GHz	TV, telecommunications
BSS service	11.7 GHz to 12.5 GHz	17.3 GHz to 18.1 GHz	
MSS service	12.5 GHz to 12.75 GHz	12.75 GHz to 13.25 GHz, 13.25 GHz to 14.5 GHz	
Ka band	17.7 GHz to 21.2 GHz, 22.5 GHz to 23 GHz	27 GHz to 31 GHz	Telecommunications

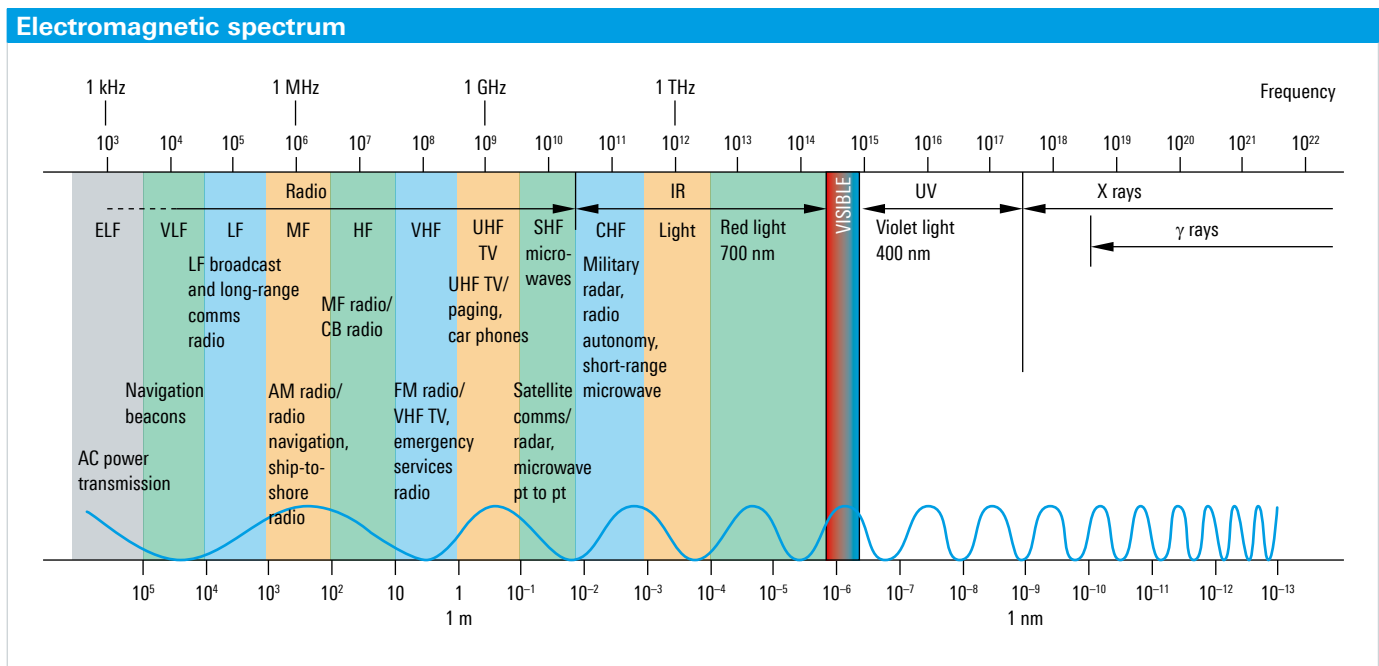

traffic in the vicinity of the MES may be a viable alternative (see figure, dashed line). Stationary, wide-area intercept systems retrieve MES uplink contents from the downlinks of the respective gateway stations, which considerably increases their performance and efficiency compared with (semi-)mobile systems. The advantages offered by stationary intercept systems include interception from a safe distance (up to a few thousand kilometers), a developed infrastructure, sufficient staff and reliable communications links to other organizations. Semi-mobile systems can operate independently of the central station and can be dispatched to areas of interest with little logistic effort. (Semi-)mobile systems have the advantage of gathering source information as well as unique identification characteristics of subscribers. Based on such characteristics, a strategic stationary system can perform large-area monitoring of subscribers.

Specific, mission-relevant information is extracted by means of SatMon production systems from Rohde&Schwarz. If the technical parameters of a satellite communications link are not known, they are first determined by means of an analysis system.

Analysis system

Analysis systems (see screenshot on next page) can detect and record completely unknown satellite carriers, take snapshots of such carriers and evaluate their contents. Recording includes the determination of technical parameters such as frequency, bandwidth, symbol rate, modulation and forward error correction (FEC). Analysis is completed with carrier identification based on the carrier contents. Technical analysis covers all transmission parameters a subscriber would have to set on a satellite modem in order to correctly receive a desired carrier, including the technical parameters of the satellite. Based on this information, a production process can be started. Although an analysis system should be capable of continuously recording contents, this is not its actual task. Using the information gathered in a satellite and carrier database, the operator decides whether a carrier is relevant to a specific mission. If a carrier is mission-relevant, a production system should continuously record it and evaluate its contents; if a carrier is not mission-relevant, it should nevertheless be monitored.

Production system

To extract information from Thuraya, ISAT/ACeS, ISATPhone Pro or Iridium links or carriers using time division multiplex, production systems are required. The underlying technical standards are known. Production is aimed at recording a maximum of transmitted messages in order to extract mission-relevant information. Only configuration is performed manually whereas data processing is fully automatic – from the receiving antenna to the recording of contents in a database. As a result, operators can concentrate on evaluating mission-relevant information. Not only audible and legible SatCom contents are of interest, the technical parameters of a transmission link may also provide useful information. Technical information that may first appear insignificant often reveals interesting correlations.

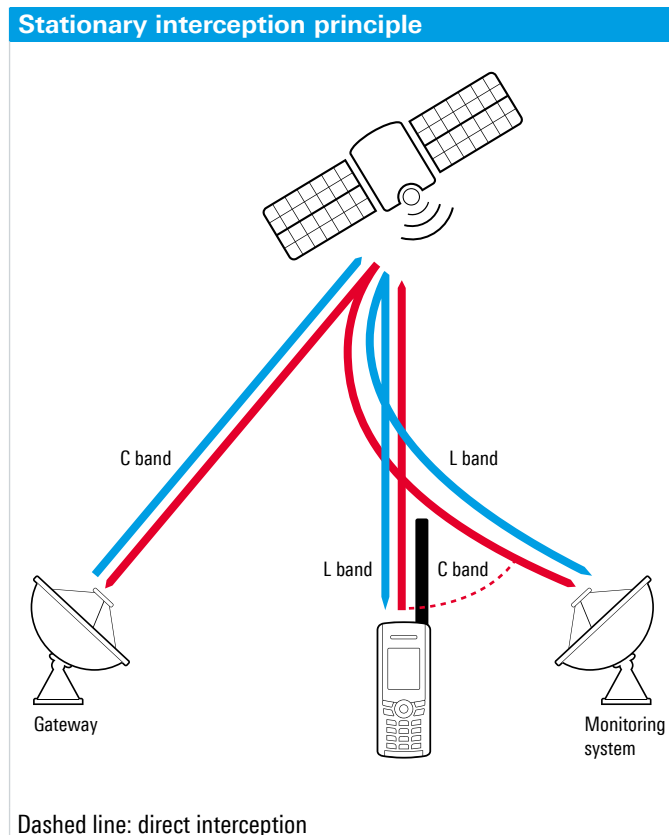

Production systems evaluate the contents of one or several SatCom systems in four stages (see figure):

■ **Tasking:**

In view of the large number of communications channels that may be active at any time, suitably devised search and selection criteria are needed to cover mission-relevant information based on limited material and human resources. In addition to general intercept tasks, there are usually long-term and short-term intercept missions. This means that requirements continually change with respect to the target regions to be covered, the subscribers to be monitored during defined periods of time and the reporting procedures. Reporting will not function properly unless customers deliver a correct definition of the tasks to be handled by the intercept systems and consistently redefine their tasks as information requirements change. The challenge is to translate the task definitions (delivered by the customer) into priority-controlled search or carrier lists (for the intercept system) in order to gain the desired information.

■ **Processing:**

A single recorded communications event – e.g. a telephone call – is referred to as a session. Intercepted and recorded sessions, including audible or legible contents and technical parameters (session-related information, SRI), will in most cases have to be preprocessed before being routed on to the next higher stage (content analysis). For example, contents may have to be translated into another language. Processing also includes the conditioning, masking, summarizing and categorizing of contents. An issue of special importance is content-based detection and identification of unknown subscribers and correlations. The analysis environment therefore contains suitable tools for (semi-)automatic detection and identification.

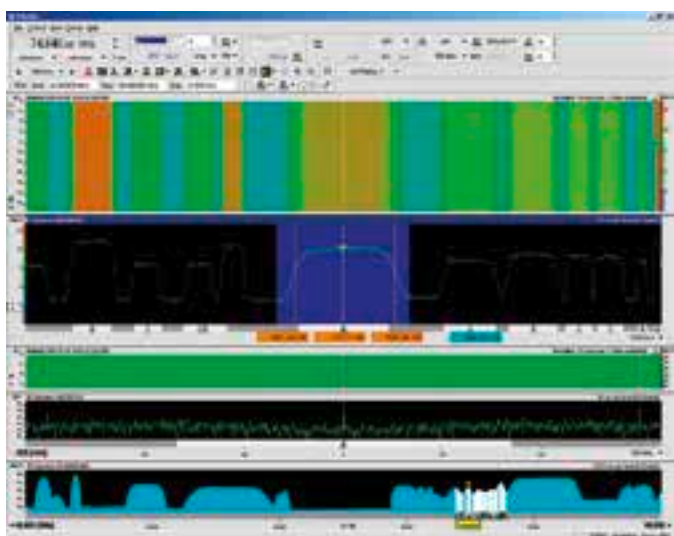
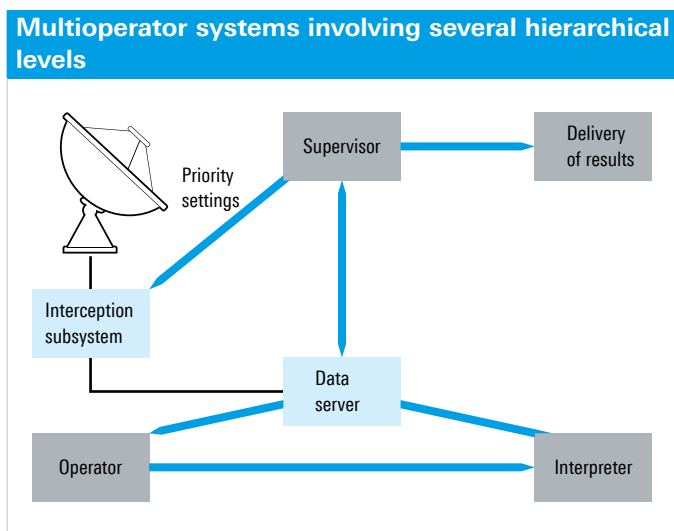

Rohde & Schwarz analysis system, semiautomatic interception of satellite carriers.

- **Analysis:**
 Processed sessions derived directly from the intercept system usually require interpretation. Analysts compile a sequence of sessions, for example, in order to form an overall picture. Analysis is a multistage process implemented in different ways by different organizations. During analysis, sessions from different sources (services and organizations or intercept systems) are compiled. The activities of a specific subscriber via different communications systems are combined. The Rohde&Schwarz evaluation environment comprises tools for content processing as well as tools for the first stage of content analysis. Contents captured and recorded by ISAT/ACeS, Thuraya, ISATPhone Pro, Iridium other (satellite) monitoring systems as well as communications intelligence (COMINT) are collected in a database.
- **Reporting:**
 Reporting includes the fast transport of recorded and processed contents. Recorded sessions undergo processing and the first stage of content analysis and are then routed to the customer as a message. Reports may be redirected to subsequent customer systems via specific interfaces that are continuously expanded. Before a message is passed on to a subsequent customer system, it is normally checked by the supervisor as to its relevance for a specific mission. A message may be rejected or returned to its author for revision, including an appropriate comment. SatMon production systems and the Evaluation Center from Rohde&Schwarz are efficient tools for implementing the above four stages for the interception of Thuraya, ISAT/ACeS, ISATPhone Pro, Iridium and/or TDM signals. The Rohde&Schwarz Evaluation Center uses individually assigned user rights to help operators perform their missions.

SatMon systems from Rohde & Schwarz

Rohde&Schwarz focuses on satellite communications systems with satellites traveling in a geostationary or inclined geosynchronous orbit, as well as low orbital satellite constellations like Iridium. Rohde&Schwarz systems cover mobile satellite communications, parts of VSAT communications and time division multiplex (TDM) transmissions. The R&S®GSA system family is divided into functional areas: VSAT satellite monitoring (R&S®GSA VSAT), Thuraya monitoring (R&S®GSA6xx), ISAT/ACeS/ISATPhone Pro monitoring (R&S®GSA7xx), Iridium monitoring (R&S®GSA8xx) and INMARSAT III monitoring (R&S®GSA9xx). The contents recorded with R&S®GSA systems can be conveniently analyzed with the R&S®Evaluation Center software. Should you require any further details, just call our Sales Department. On request, you will also be given a live demonstration of our satellite monitoring systems at our Munich headquarters.

SRI

Session-related information (SRI) includes all information that belongs to recorded voice, SMS, fax and data contents. An SRI data record is usually generated for each session (data, telephone or fax communications). Filters and selection tools can extract specific information from the contents of these records (e.g. activities that took place at specific times, with specific identifications – IDs, call numbers, addresses – using specific protocols, standards and services). SRI data records can also include information and setting parameters relevant to the test system, such as modem modes, IDs of known exchanges and bit error ratios. SRI provides recorded session contents with an identity, which allows them to be efficiently processed in databases (see figure).

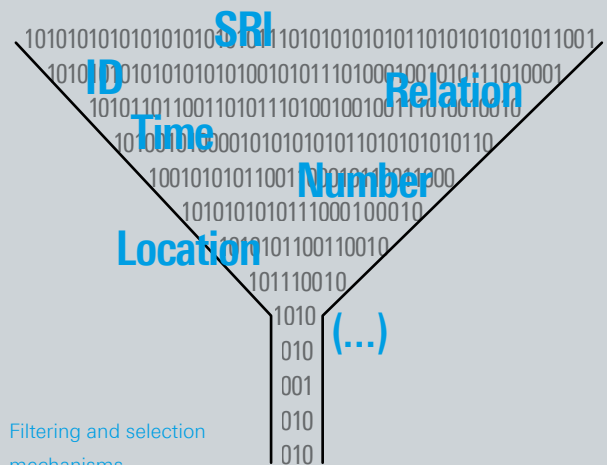

References	
Reference No.	Description
[1]	Dodel, H: Satellitenkommunikation, Anwendungen Verfahren Wirtschaftlichkeit. Hüthig Verlag Heidelberg 1999.
[2]	International Telecommunication Union: Handbook on Satellite Communication. Third Edition, ITU 2002.



Chapter 7

System Applications

Rohde&Schwarz consistently uses the devices and software components presented in the previous chapters to configure and supply turnkey radiomonitoring systems.

The system solutions cover a wide range of applications for regulatory authorities, public safety and national security.

This chapter describes exemplary systems.

Designation	Page
Nationwide Radiomonitoring Network for Regulatory Authorities	202
Nationwide COMINT Systems	208
Mobile EW Systems for CESM and CECM	214
New R&S® MobileLocator System Software	218
Camouflaged Mobile Surveillance Systems	222
New Hybrid radiolocation using conventional AoA direction finding and TDOA	226

Nationwide Radiomonitoring Network for Regulatory Authorities

Wireless communications are crucial for a successful, modern society. Today, TV and radio, mobile phones and WLAN are as common as the radio equipment used by police forces, rescue services, taxi drivers and airline pilots to communicate with headquarters or air traffic control.

To meet these diverse requirements as optimally as possible, considerable effort and expense must go into coordination, cooperation and monitoring. The part of the electromagnetic spectrum that is available for this type of communications is limited, and the frequency ranges of particular economic interest are densely occupied.

Since electromagnetic waves do not stop at national borders, coordination across countries is mandatory. The International Telecommunication Union (ITU, suborganization of the United Nations) plays a special role, because experts from all member states define general rules and guidelines for the optimum use of the spectrum at an international level. These ITU recommendations are adopted by the individual states and implemented in national laws and regulations.

Based on these specifications, the national regulatory authorities ensure that the frequency requirements are met to the largest possible extent and that mutual interferences are excluded as far as possible. To achieve this goal, the authorities make use of spectrum management and spectrum monitoring.

Spectrum management essentially involves the planning, coordination and licensing of transmitters and the related administrative activities.

Spectrum monitoring refers to the associated measurement tasks for ensuring compliance with the frequency allocation, for eliminating interference as quickly as possible and for providing real data for future planning. All this is also based on the ITU recommendations.

Spectrum management defines how the world should be, whereas spectrum monitoring knows how the world really is. Therefore, it is indispensable that spectrum management and spectrum monitoring work closely together and exchange data and information.

Typical tasks

Central radiomonitoring tasks include, for example, monitoring whether transmitters operate in compliance with their license conditions, detecting and locating illegal transmitters, measuring occupancy and coverage, and eliminating interference.

Monitoring of transmitters

When licenses are issued, technical parameters are defined that must be complied with during operation. These parameters include, for example, the deviation from the assigned transmit frequency and maximum power and bandwidth. A classic spectrum monitoring task is to regularly measure that these license conditions are met. To be able to compare the measured values with the license conditions, the associated spectrum management data must of course be available to spectrum monitoring. Typically, this involves a database query in which the monitoring operator defines filter criteria for the license database that deliver exactly the data records needed for the measurement task at hand.

A similar database query generates a list of all frequencies that have already been assigned to a transmitter. If this list is compared with the measured spectrum, the operator can see at a glance any unlicensed emissions and the frequencies they use. These frequencies can then be analyzed in detail to determine whether they originate from illegal transmitters or from interference or intermodulation.

It is essential for both applications that the information from the license database be up to date. Otherwise, false alarms can occur because, for example, a suspected pirate transmitter has meanwhile received a license. Professional monitoring systems have various mechanisms to ensure that the measurement stations are automatically updated when a change is made in the license database.

The search for illegal emissions and the comparison of license parameters and transmit parameters are often performed automatically. The operator defines the frequency ranges to be monitored and the associated limits. If a limit is exceeded, the operator can precisely determine which action the system has to take. For example, if transmission activity is detected on a free frequency, the monitoring system can use direction finders to determine the exact transmitter location, record the audio signal and make additional measurements that help identify the unknown transmitter.

Another advantage of the automated workflows is that they are ideal for long-term measurements and unattended stations. The operator merely defines the measurement jobs at the beginning. While the measure-

ments are running, operators can accomplish other tasks that require more interaction. The system performs routine tasks automatically. Operators can focus on complex and sophisticated work.

Occupancy measurements

During occupancy measurements, the relevant frequency ranges are monitored over an extended period of time. This is followed by an analysis to calculate how often a specific frequency was occupied, i.e. used for transmission. Additional evaluations determine the time of day of the transmission and how long the individual transmissions and the pauses between them were. This information can be used to check whether license conditions are met and whether and when this frequency can be assigned to an additional user (see screenshots).

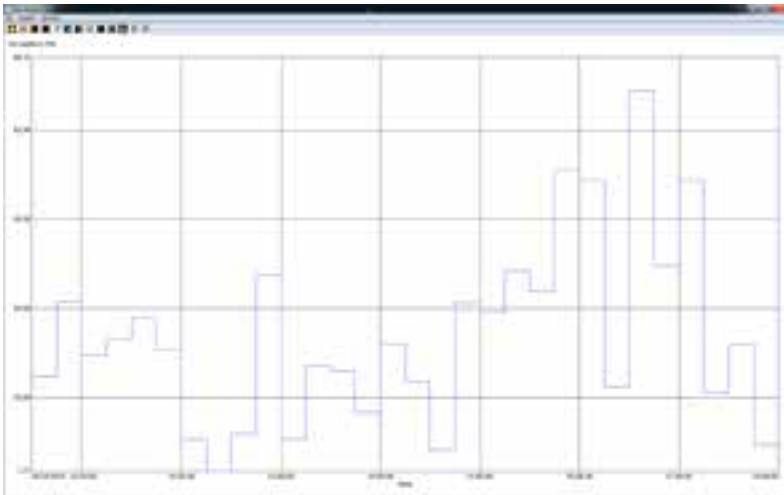

Example of an occupancy analysis. This frequency was occupied only approx. 20% of the time.

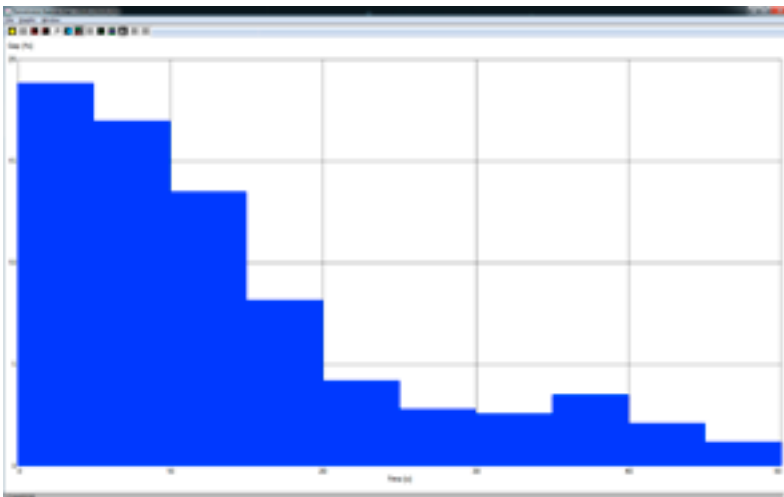

Most pauses between the transmission activities were short; approx. 50% were shorter than 15 s. Consequently, this frequency cannot be assigned to another transmitter.

Coverage measurements

Coverage measurements are another typical task. Appropriately equipped monitoring vehicles travel along specific routes and measure parameters such as levels or the bit error ratio of digital signals at different frequencies. In this way, it is possible to find out in which area a specific transmitter can be received. The comparison of the measured values with the results of the calculations from transmitter planning delivers valuable information about the quality of the model calculations and helps improve the models and the planning. Coverage measurements also show whether a transmitter actually provides the coverage specified in the license. The licenses often stipulate specific coverage levels to prevent wireless communications providers from focusing solely on lucrative large cities and to ensure adequate coverage of less densely populated areas.

The coverage measurement results are displayed on electronic maps. The measurement values are color-coded so that the operator can see at a glance where a transmitter can be received or where problems may occur. This makes it easy to optimize coverage.

Elimination of interference

A task with growing significance is the handling of interference. Over the last few years, the number of transmitters literally exploded (e.g. increasing number of mobile phones and wireless Internet accesses via WLAN or Wi-Fi). In addition, wireless communications are used in more and more areas. Every transmitter is both a potential source of interference and a potential interference victim. For this reason, regulatory authorities have to deal with an ever increasing number of trouble reports.

In contrast to automated license monitoring, the detection, localization and elimination of interference require a lot of interaction. Interference signals often have completely different characteristics than the neighboring transmitters: They are relatively weak and difficult to locate. In many cases, it is important to rapidly eliminate interferences, e.g. when distress frequencies or important air traffic radiocommunications are affected. This is a very responsible task whose successful solution mainly depends on the experience and knowledge of the operating staff.

Handling large-scale events and natural disasters

Large-scale events are particularly challenging for regulatory authorities because they temporarily involve a major, additional demand for communications and frequencies. This includes large sporting events such as the Olympics and world championships, or state visits, as well as natural disasters such as earthquakes, volcanic eruptions and flooding. The dates for state visits and sporting events are known far in advance so that sufficient time is available for planning and coordinating the required capacities. The largest problem is the enormous need for additional frequencies. During the Olympics, the number of additionally transmitting devices and the frequencies they require is between 10 000 and 15 000. The monitoring capacities must be dimensioned accordingly.

Natural disasters, in contrast, occur with no advance notice. Rescue services from throughout the country or even from abroad are brought to the disaster area within the shortest possible time and must be able to wirelessly communicate with one another and with the command center. The main difficulty for spectrum monitoring in such a scenario is not the extremely high number of additionally required frequencies but the fact that advance planning is hardly possible. Instead, the on-site transmitters must be coordinated under intense pressure. The destruction of important infrastructure facilities often complicates the situation even further.

In such situations, vehicles and compact systems offer clear advantages. They are highly flexible, easy to deploy and require only a minimal infrastructure.

Monitoring stations

The tasks described require the right equipment and systems as well as answers to where and how to deploy the equipment. Basically, a distinction is made between fixed stations, mobile systems, compact systems and portable systems.

Fixed stations

Fixed stations provide enough space to accommodate all monitoring equipment and to integrate sufficient workstations and even special gear. Infrastructures such as power and broadband communications are available. Frequently, there is also a workshop where small repairs or individual developments can be carried out. Fixed stations are therefore ideal for long-term measurements. When high antenna masts (up to 100 m) are used, a very large area can be monitored.

The disadvantage of fixed stations is that they are not mobile. Consequently, transmitters that are too weak or too far away cannot be detected.

Mobile systems

Mobile systems offer high flexibility and mobility. Vehicles can be driven to new sites quickly and easily, and putting them into operation takes only a few minutes.

This mobility is mandatory in the case of high frequencies. In the microwave range, most emissions have a very high directional characteristic. If the antenna is located outside the main or side lobe, it is virtually impossible to measure the transmitters.

Another field of application for vehicles is radiolocation using only one direction finder that takes running fixes. The first step is to determine the direction to a transmitter. Next, the vehicle drives to a second suitable site to perform another measurement. By combining the two bearings obtained, the transmitter can be located (offline). If necessary, additional measurements can be performed at other sites to increase radiolocation accuracy.

Coverage measurements and radiolocation in the homing mode (radiolocation with only one mobile direction finder that moves toward the transmitter) are also possible during the drive.

Compared with fixed stations, mobile systems have several limitations. The space for personnel and measuring equipment as well as for power supply and communications facilities is limited. Even with the most extended, the antennas are only approx. 10 m above the ground, which means relatively small coverage.

Compact systems

Compact systems ideally complement fixed stations and monitoring vehicles. Receivers, direction finders and a control PC including communications equipment are integrated into a small housing suitable for outdoor use. Since these systems are fully automatic and standalone, they can perform all routine tasks. They are controlled from the central control station via (wireless) communications. Compact systems are therefore perfect for closing the gaps that vehicles and fixed stations leave behind, or for covering areas for which a fixed station is not suitable (e.g. border regions or thinly populated areas).

Portable systems

In specific instances, the monitoring equipment must be used within a building. In this case, portable receivers and antennas are needed. Typical applications are the search for defective instruments, illegal transmitters or electronic bugs.

Latest-generation portable receivers can store the measured data on an internal hard disk. In the office, the data is then read out and processed using suitable monitoring software.

Nationwide radiomonitoring networks

Nationwide radiomonitoring networks consist of a combination of fixed stations, vehicles and compact systems. All stations can be remote controlled from a monitoring center. The measurements are performed directly as needed, or automatic workflows can be defined. The measurement results can be transferred from the remote stations to the monitoring center where they are then available for in-depth analysis. The monitoring center is normally linked directly to the spectrum management database, which ensures that all relevant information is exchanged.

Depending on the size of the country and the complexity of the network, there are also regional control stations (see figure on next page).

Especially in the case of large radiomonitoring networks, management and the operative control station must always have an overview of the current status and the availability of the individual resources. Station information systems (SIS) show the positions of all radiomonitoring systems and their current status on an electronic map. This status information includes the accessibility via the communications network, the availability and capacity utilization of the measuring equipment as well as various environmental parameters such as temperature, humidity and power supply in the unattended stations. The map display can also be used for remote control. A click on the station symbol automatically sets up a connection (see figure on next page).

In order for remote operation and data transfer to function efficiently, a suitable communications link is indispensable. Fixed stations and compact systems are typically supplied via a cable connection or a microwave broadband link. By contrast, communications in mobile systems are exclusively wireless. The output data rate of the measuring instruments in mobile systems is often far above the available network bandwidth. In such a case, professional monitoring control software must ensure that the data is reduced and compressed as needed so that the communications link can be optimally used.

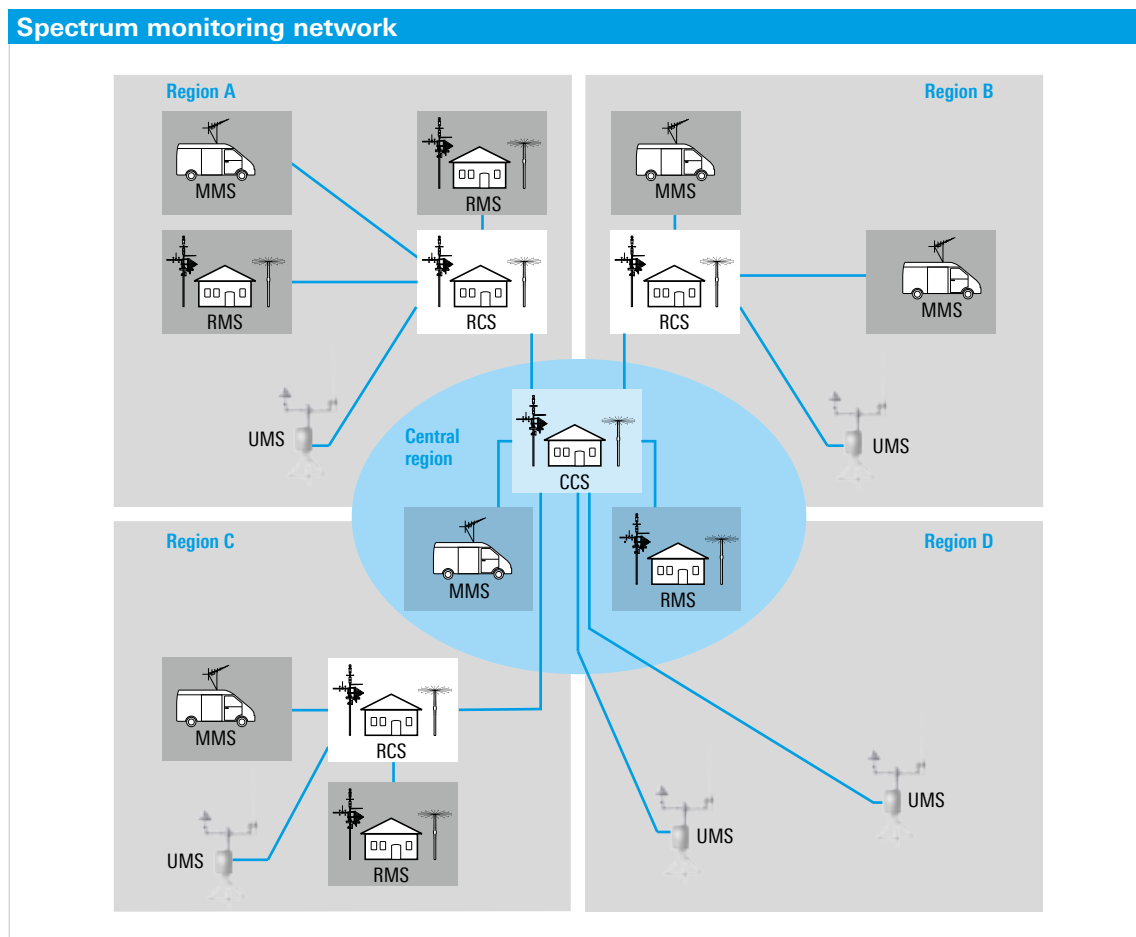

Typical structure of a nationwide radiomonitoring network with a central control station (CCS), regional control stations (RCS), fixed monitoring stations (RMS), mobile monitoring stations (MMS) and universal compact systems (UMS).

The selection of the site is of particular significance, especially for fixed stations. An optimum compromise must be found between various, contradictory requirements. On the one hand, the fixed station must be centrally located to cover as many transmitters as possible in important regions. On the other hand, strong signals in the direct vicinity can easily cause intermodulation. A remedy for this problem are filter units that activate filters depending on the signal scenario and the measurement task and only let through the useful signal of interest. These filter units have also proved to be helpful when new transmitters are successively put into operation near a fixed station, where a previously good site would suddenly be only conditionally suitable. Fixed stations are often erected on mountains. This increases their range, but involves problems regarding infrastructure, e.g. power supply or access for the operating personnel.

The requirements for DF stations are particularly stringent. Nearby obstacles can easily cause reflections and reduce DF accuracy. The ITU has also published recommendations for choosing the site of monitoring and DF stations.

The same general conditions are also applicable to vehicles and compact systems. However, these can be relocated significantly faster and more easily if the current site is no longer suitable.

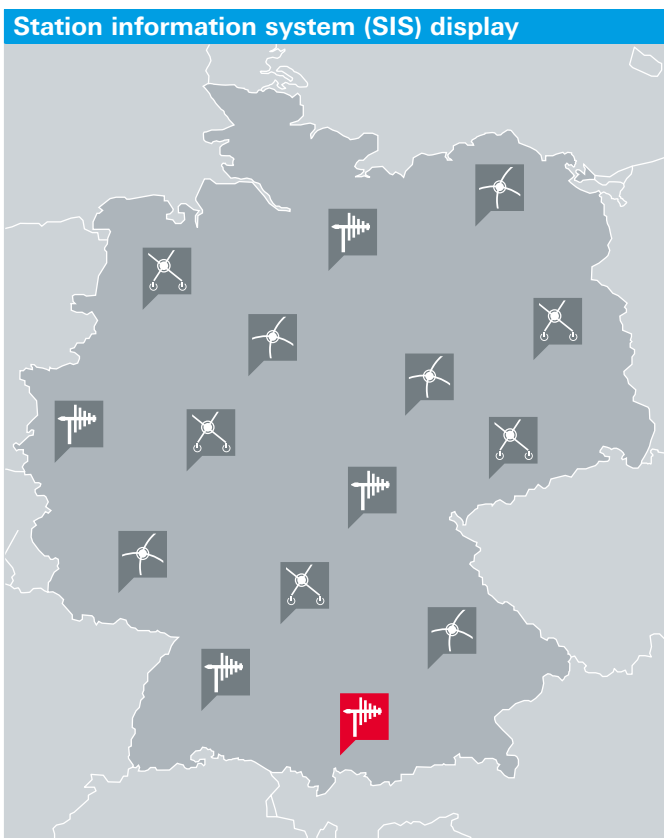

An example map showing a number of monitoring stations, their capability (indicated by different symbols) and their current status (indicated by different colors).

Nationwide COMINT Systems

Tasks

A nationwide COMINT system is an example of a strategic COMINT system. The term “nationwide” in this context designates a large geographic area that includes, for example, a large part of a country's national border and part of the neighboring countries or of an international maritime strip.

A nationwide COMINT system serves the following purposes:

- Gathering intelligence to assess the (military) situation of other countries as well as one's own security situation
- Provision of basic reference data for the efficient operation of strategic and tactical COMINT/CESM systems
- Protection of one's own border to prevent illegal border crossings and contraband trade
- Monitoring of coastal strips and the adjacent areas of international waters

Requirements

In addition to the general requirements placed on a radiomonitoring system, a nationwide COMINT system has to fulfill a number of additional requirements, the most important of which are described below.

Remote control of sensor equipment

Due to the specific conditions of shortwave propagation, HF antennas and radio receivers can often be installed at a central location within the system – if possible, close to the central monitoring station. HF direction finders, however, should be located as far apart from one another as possible. Radio receivers and direction finders operating in the VHF/UHF and SHF ranges should also be set up at the maximum possible distance relative to one another. VHF/UHF and SHF radio receivers and direction finders are usually located close to the area of interest and operated by remote control.

Remote monitoring of COMINT stations

COMINT stations installed at remote locations are remote monitored. This involves the continuous health monitoring (CHM) of the radiomonitoring equipment, the PCs, the air-conditioning systems, the power supplies and the communications links. Monitoring covers electrical parameters, the status of the system's hardware and software modules, and ambient parameters.

Automation of routine monitoring tasks

A typical automation task is to monitor known, regularly recurring radio traffic for its repeated occurrence. This requires the continuous monitoring of specific, known frequencies, whose content is decoded and stored (production). Another automation task is to monitor the radio traffic volume in specific frequency ranges in order to detect any significant deviations from the normal volume.

Workflow control and intelligent resource management

Monitoring a large geographic area calls for an appropriate number of sensor stations and system operators. The operators organize and run the system, and control and monitor the information flow between the individual system sites and workstations. This also includes the management and allocation of available system resources, i.e. hardware (radiomonitoring equipment) and software components.

Interfaces to evaluation center

A COMINT system is usually not operated as an isolated system but forms part of a larger, integrated intelligence system. Consequently, it provides only part of the puzzle that makes up the overall situation picture. The information gathered by the COMINT system is forwarded to an intelligence center, which post-evaluates it and correlates and combines it with information from other sources. As a result of this data fusion process, basic reference data is obtained. This data is fed back into the COMINT system, where it helps to increase monitoring efficiency. This process requires suitable interfaces for data exchange as well as methods for updating the data/reference database within the system.



Mast with DF and monitoring antennas and a DF receiver accommodated in an all-weather cabinet on the upper platform.

Implementation

The block diagram below shows a nationwide COMINT system for border control operating in the HF/VHF/UHF range. Rohde&Schwarz has already implemented a number of systems of this type.

Sensors

Sensor stations for VHF/UHF and SHF monitoring are distributed along the border. They consist of air-conditioned shelters and high masts, since the detection range essentially depends on the antenna height. For mast heights of 100 m to 150 m, the sensor equipment can also be installed in air-conditioned cabinets on the mast platform to avoid system sensitivity being degraded by the use of long RF cables.

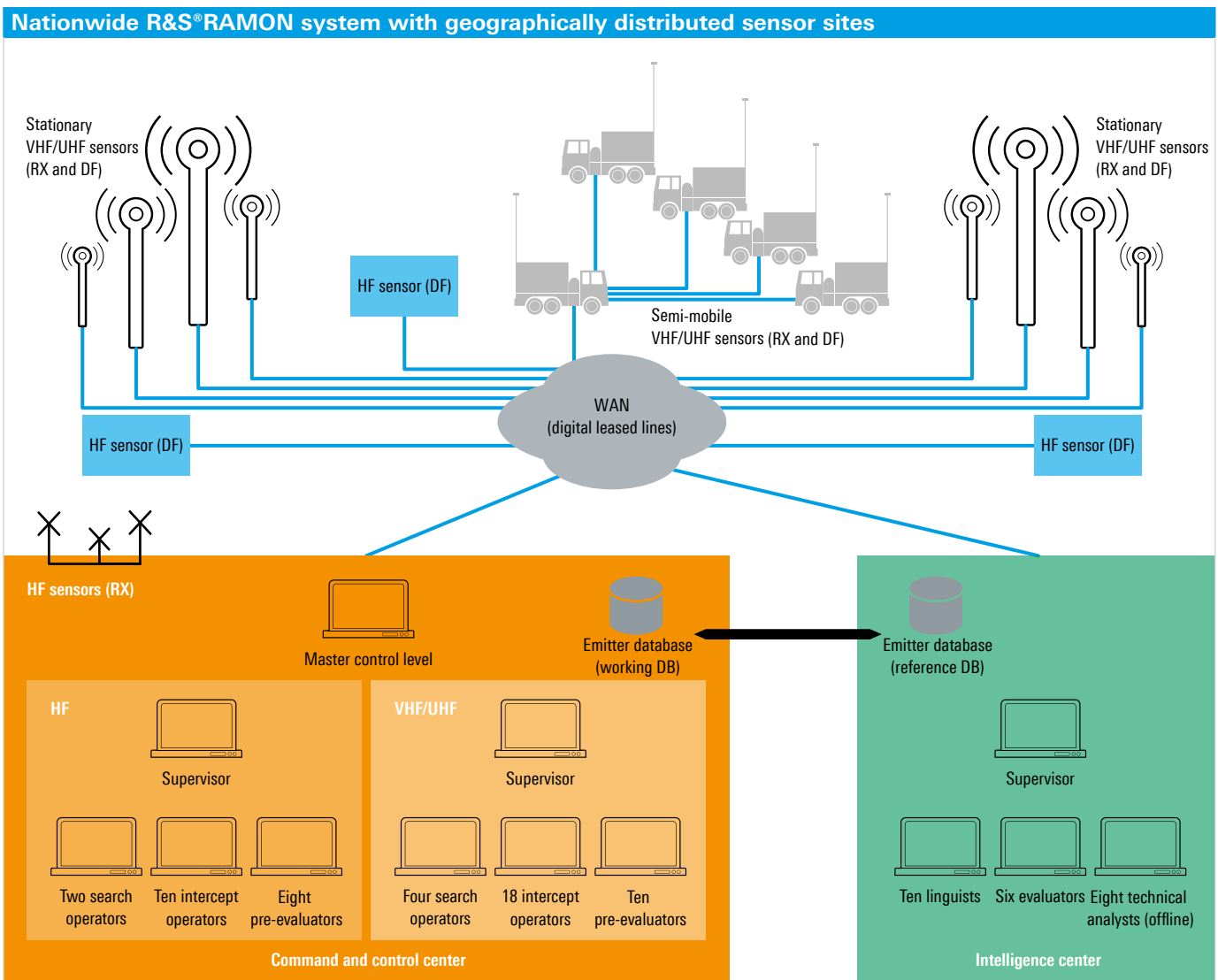

A wide-area network (WAN) is necessary in order to remotely control the sensor equipment from a central monitoring station. The required WAN bandwidth depends on the number and types of radio receivers/direction finders used in the sensor stations and the operating mode. For example, if only result data (measured values and test parameters) are transmitted, a low bandwidth (from a few 10 kbit/s up to several 100 kbit/s) can be sufficient. This is the case, for example, when detection algorithms are used that segment broadband signal spectra, detect radio signals and output only the measured (and possibly filtered) signal parameters for transmission. R&S®RAMON systems offer such algorithms.

In contrast, if RF spectra with high time resolution are to be transmitted, very broadband data links in the range of a few Mbit/s are required. Such data is transmitted in order to visualize signal spectra for operators who manually work with radio receivers/radio direction finders. R&S®RAMON also offers data compression algorithms for this type of information.

Semi-mobile or mobile sensor stations can also be deployed to provide enhanced flexibility during intensified COMINT operations and to enable signal detection in shadowed areas that cannot be covered by stationary sensors. These sensor stations can be implemented, for example, as shelters that accommodate the radiomonitoring and radiolocation equipment as well as the antenna masts.



Shelter housing a semi-mobile R&S®RAMON radiomonitoring station with the mast folded down for transport on a truck.

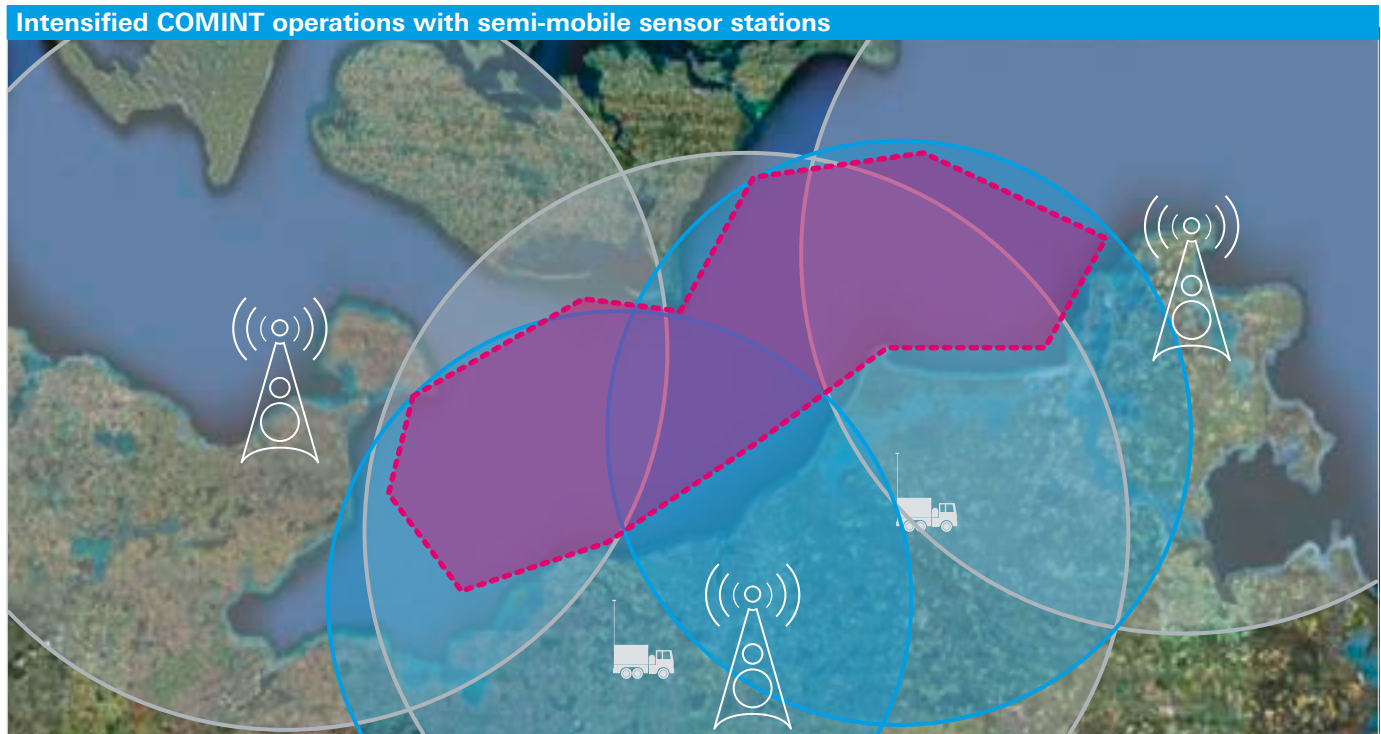

Gray circles: intercept range of the stationary stations; blue circles: intercept range of the semi-mobile stations. The primary area of interest for the current intercept operations – the red area – is within range of at least three sensor stations.

The sensor equipment is connected to the central WAN via a directional radio link (which may include one or more semi-mobile relay stations). The WAN is usually wire-based (using digital leased lines, for example).

If necessary, one or more of these shelters are transferred to the area of interest and, after startup, connected to the central monitoring station via the WAN. They can now be remotely controlled like the stationary sensors.

Workflow control/teaming

At the central monitoring station, numerous operators with different roles work together. The operators are organized in teams, for example to handle different frequency ranges or geographic areas, and are assigned different roles such as supervisor, search operator, intercept operator or evaluator.

Using the R&S®RAMON software, the supervisor can combine operators into teams and allocate hardware and software resources as necessary for the tasks to be performed. The individual teams will then have exclusive access to radio receivers, direction finders and analysis equipment depending on the task assigned. The supervisor can reorganize the teams for each job.

From radiomonitoring...

The R&S®RAMON software optimally supports search and intercept operators. The radio direction finders assigned for a specific task (order) are operated in synchronous scan mode. The DF data gained is stored in ring buffers. Using wideband receivers as well as fully automatic detection and classification algorithms, the frequency bands are scanned for new, unknown signals as well as for specific, known emissions. From the stored DF data, location data is computed and assigned to detected emissions fully automatically. Operators can focus on the displayed results, which may be represented graphically or in tabular form. In addition, narrowband handoff receivers are available that operators can use to check signals of interest in manual operation. These can be software digital downconversion (DDC) receivers that are connected to the digital IF output of the wideband receiver and offer analog demodulators or digital demodulators/decoders.

The R&S®RAMON software automatically analyzes all radio traffic detected on the monitored frequencies as well as the communications patterns of all monitored radio stations. As a result, radio traffic and radio networks are automatically identified.

The monitoring results are reported by the operators at defined intervals using task-specific forms. The subsequent operator or unit to be addressed can either be selected manually or is automatically determined by the team configuration.

7



Map display on an operator's monitor. Different symbols are used to designate different transmitter categories.



COMINT situation picture with automatically detected radio networks. The picture shows identified and unidentified radio sites marked with different tactical symbols.

...and communications analysis...

Monitoring results are first analyzed by pre-evaluators who use the raw data stored in the session database. Several pre-evaluators are required (see block diagram on page 209) to handle the high data volume resulting from the largely automated monitoring process. The pre-evaluators check the monitoring results for consistency and completeness. They identify, and where necessary correct, any erroneous decisions made by the automatic detection algorithms. Plus, they compact results. In this process, they are supported by the R&S®Presentation Suite software, which visualizes the detected radio traffic and networks (see map display on previous page).

A large COMINT system as outlined here is linked to an intelligence center. This center receives the pre-evaluated results for post-evaluation. The evaluators at the intelligence center are assigned different tasks, including technical analysis, content and traffic analysis and tactical analysis. The intelligence center generates the basic reference data that is subsequently fed back to the COMINT system to make monitoring more effective.

...to the COMINT situation picture

The result of communications analysis is presented as a COMINT situation picture.

The situation picture provided by the COMINT system is used for data fusion with information from other sources. This data fusion process yields an overall situation picture which serves to inform the specific country's military and political leaders on a daily basis. Another likewise important result of data fusion is the generation of new basic reference data which is fed back into the COMINT system through an update of the reference database. The basic reference data is important for search and intercept operators as well as for evaluators in the COMINT system.

Automation of COMINT processes with R&S®RAMON task planner

Since well-trained COMINT staff is a scarce resource, COMINT systems require functionality enabling the time-controlled and largely automated performance of monitoring tasks. Operators can then focus on the tasks that require direct interaction (see ...and communications analysis... on this page). In some cases, automated operation offers higher monitoring reliability than purely manual operation. This functionality is also important during night shifts with reduced staffing.

The R&S®RAMON task planner enables automated operation based on predefined tasks. Tasks in this context are automated sequences of radiomonitoring operations covering the detection, location and classification of radio signals. A time sequence control function automatically starts

and stops task execution in accordance with predefined schedules. Depending on the signals detected, results can be handled in different ways. Either, they can be stored for subsequent analysis by an operator (for example on the day after a night shift). Or, an alarm can be generated (acoustic alarm or alarm message) if a specific signal is detected or if a known signal does not occur at the usual time.

All measured parameters are stored to the R&S®RAMON database from where they can be retrieved by evaluators for analysis.

Remote monitoring and remote maintenance

A complex COMINT system as described here comprises a large number of system components such as sensors, system devices, PCs/servers, software applications, databases, infrastructure and network components. Failure of one of these components can quickly lead to severe problems affecting the entire system. Monitoring the operating status of all key system components is therefore essential to ensure the proper functioning of the system. This is all the more important in a nationwide COMINT system, which comprises multiple, geographically distributed sites.

Monitoring is performed by the R&S®RAMON continuous health monitoring (R&S®RA-CHM) software. The main function of the R&S®RA-CHM software is to monitor system parameters by measuring them and comparing them with threshold values predefined by the operator. If a value exceeds or falls below a threshold value, the user receives a notification on the GUI or the Windows system tray. In case of an error message, the operator is immediately transferred to the dedicated device/management interface, permitting quick and in-depth error analysis and troubleshooting.

The figure below presents an overview of the continuous monitoring functionality provided by the R&S®RA-CHM software. Typical functions include:

- Output of a warning message if a defined temperature is exceeded in an unattended shelter, or if a defined filling level of a server's hard disk is attained; generation of an alarm upon failure of a device, a data link, or a door contact in an unattended shelter
- Wide range of analysis tools making it possible, for example, to visualize measured values in time sequence charts or to perform targeted database searches in order to help the system administrator carry out maintenance work and detect frequent errors

Single-source solutions

The above explanations have shown the numerous requirements placed on the functionality of a nationwide COMINT system. These requirements go far beyond the required sensor equipment and direct (manual) system operation. Rohde&Schwarz has already implemented a number of nationwide systems of this type. The Rohde&Schwarz product portfolio covers the core components of a COMINT system as well as the more peripheral – but equally important – functions such as remote monitoring. Since all functions are integrated in the R&S®RAMON system software, all operators can work with an intuitive user interface regardless of their role in the system. Rohde & Schwarz is therefore a competent partner in the design, implementation, startup and long-term maintenance of large turnkey systems.

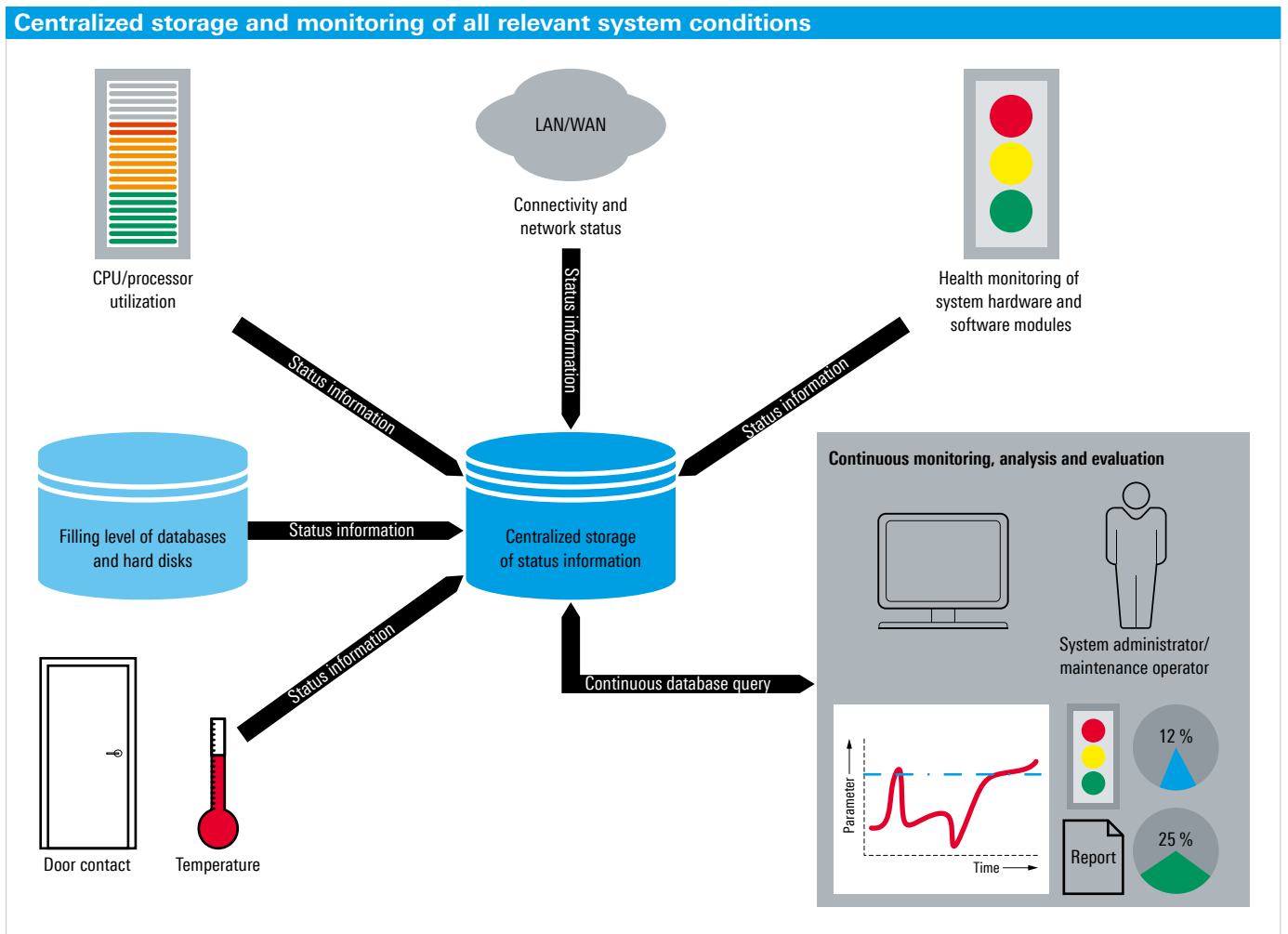

Mobile EW Systems for CESM and CECM

Mobile electronic warfare systems (EW systems) are deployed to complement stationary radiomonitoring systems. Mobile EW systems cover target areas that cannot be monitored by stationary systems. Owing to their mobility, they offer the intelligence consumer a flexible source of information. For example, they are extremely well suited for mobile police border control tasks or military out-of-area operations and make a significant contribution toward protecting deployed forces on site.

Deployment spectrum and tasks

Modern EW systems for tactical applications, for example as part of UN peacekeeping or peacemaking missions, are deployed for the following tasks:

- ▮ Identifying electronic threats
- ▮ Rapid intelligence gathering and generation of comprehensive field situation display
- ▮ Early warning and protection of own forces
- ▮ Situation reporting
- ▮ Target identification, correlation with reference data, and threat assessment
- ▮ Obtaining basic reference data for planning electronic support measures (ESM) and electronic countermeasures (ECM)
- ▮ Use of ECM for disruption and deception of adversary communications links

Mobile EW systems can be used on a variety of carrier platforms (land-based, naval or airborne), each of which places specific requirements on such a system. In general, a mobile EW system has to comply with a host of requirements:

- ▮ Integration into highly mobile platforms
- ▮ Autonomous deployment of the individual subsystems
- ▮ Networking capability of multiple systems, for example to build a radiolocation network
- ▮ Connection to a command and control center or evaluation center
- ▮ Range-independent communications with remote stations in the mission country and at home for data exchange

COTS components – flexibly combined

Commercial off-the-shelf (COTS) hardware and software components from Rohde&Schwarz help to implement radiomonitoring systems for different operation scenarios and platforms at short notice. In the following, the deployment of mobile EW systems on the various types of platforms is discussed.

Land-based EW systems

The example shown in the photo on next page is an integrated, highly mobile interception and direction finding system that includes communications electronic countermeasures (CECM). The system is designed to operate even on the move.

Mobile CESM system integrated into an armored vehicle.



It provides the following functions:

- Directional and non-directional search for radio emissions
- Taking the bearings of enemy radio emissions in the HF and VHF/UHF frequency range
- Emitter location using a running fix
- Identification of radiocommunications networks
- Display of interception results on a digital map
- Monitoring of electromagnetic spectrum
- Recording of channel and frequency occupancy as well as of demodulated audio signals
- Re-identification of known radio emissions
- Carrying out communications electronic countermeasures
- Creation of mission report

A mobile EW system usually consists of multiple individual vehicles, each of which handles specific functions. In addition to the vehicles performing radiomonitoring tasks, one or more command and control vehicles are usually

provided. A mobile EW system may include a CECM component. Because of their high mobility, the individual vehicles communicate with one another primarily via secure, wideband wireless networks such as WAN or SatCom, with backup links being established in the event of a failure of the main link.

The command and control vehicle is responsible for mission planning, i.e. it selects suitable sites for the various vehicles, creates detailed tasks/monitoring jobs and assigns them to the individual radiomonitoring teams and jamming squads. Furthermore, it analyzes and evaluates the monitoring results and the reports returned by the monitoring and jamming teams. The command and control center also reports to the (military) intelligence consumer.

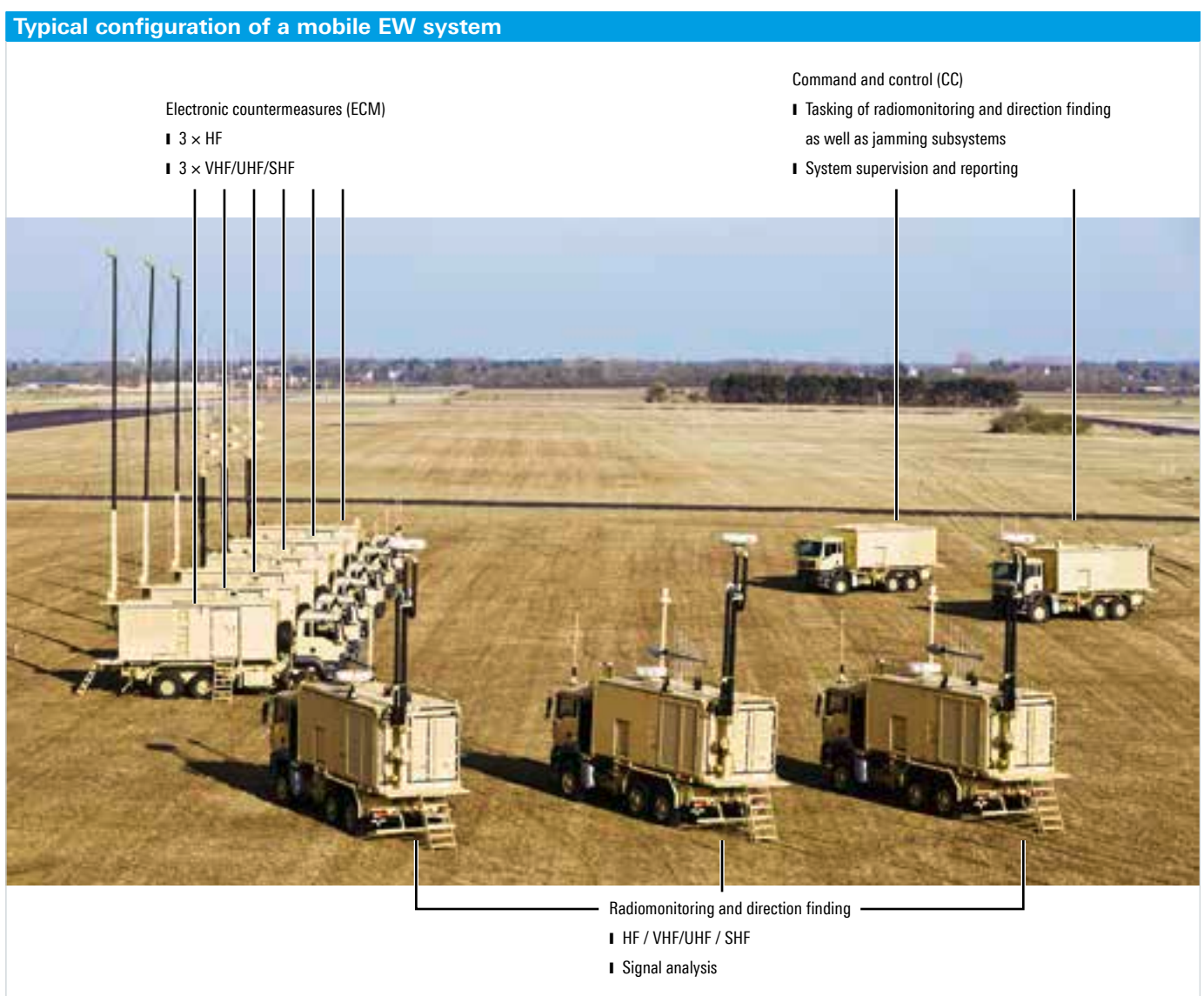

Naval CISM systems

Rohde&Schwarz communications electronic support measures (CESM) systems for naval platforms detect, monitor, analyze and locate sources of radio emissions. They cover a frequency range from 50 kHz to 3 GHz. The systems comprise a highly compact combined DF and monitoring antenna that replaces conventional DF antennas, which are large and protruding. This eliminates problems caused by shadowing and interference between antennas as occur with conventional systems.

CESM systems from Rohde&Schwarz cover a wide range of applications. They detect, demodulate and decode analog and digital modulation modes and transmission methods employed in both the civil and military sector. They include fast scanning and monitoring direction finders and wideband receivers, which makes them ideal for detecting short-duration and low probability of intercept (LPI) signals such as bursts, hoppers and GSM signals.

The CESM systems for naval platforms contain an emitter database that relies on technical parameters to categorize and identify detected signals. Signals and their emitters are automatically tracked. This greatly reduces the risk of losing detected signals.

The Rohde&Schwarz CESM system for use in submarines is modular in design. It consists of COTS products plus an R&S®ADD215 DF and monitoring antenna, which was developed specifically for use in submarines, and special system cabinets designed for the specific application and platform (see photos below). The conditions on board a submarine place exceptionally demanding requirements on the integrated devices.



Components of the Rohde&Schwarz CESM system for use in submarines (not to scale).

The Rohde&Schwarz CESM system for submarines has passed the tests and certifications specified by the EN and MIL standards – for shock and vibration as well as for EMC, magnetic stability, reduced operating noise and watertightness.

Airborne CISM systems

Airborne CESM systems enable long-range VHF/UHF reconnaissance that can be deployed particularly effectively against ground transmitters. An R&S®CA120 and R&S®DDF550 based airborne CESM system, for example, makes it possible to search for and intercept tactical and strategic VHF/UHF communications.

An airborne CESM system's main tasks include:

- Providing an overview of the communications signal scenario and any changes
- Interception of radio emissions in the spectrum and area of interest
- Emitter location using a running fix
- Basic communications intelligence tasks and information gathering based on signals from military and civil sources
- Generation of communications order of battle (COB), tactical support for generating surface/air/maritime situation picture

An airborne CESM system can provide tactical (short-term relevant) intelligence about the communications signal environment to help assess the electronic order of battle (EOB) as well as strategic (long-term relevant) intelligence that is then made available for use as basic reference data.

An airborne CESM system from Rohde&Schwarz typically consists of a fast digital scanning direction finder, a modular wideband and narrowband monitoring/interception system including IF recording, and software for system operation and data pre-evaluation.

Such a CESM system provides the following main functions:

- Interception of voice and data communications (analog and digital fixed-frequency signals)
- Interception of LPI signals such as frequency hoppers, bursts and chirps
- Technical analysis of narrowband and wideband signals
- Direction finding and location of emitters
- Online dehopping of frequency hoppers

The airborne CESHM system comprises workstations for operators with the following roles:

- Supervisor
- Wideband search/DF operator
- Narrowband intercept operator
- Tactical evaluator and technical analyst

The number of workstations that can be implemented in an aircraft depends on the available space, i.e. the type of aircraft.

The airborne CESHM system is supported by a ground control segment as well as analysts and evaluators who perform offline, post-mission evaluation. The interception results gained by the airborne CESHM system, including operational reports, IF and audio recordings, are transferred to the ground control segment via a WAN and/or exchangeable hard disks.

The operators there analyze in greater detail the data collected during the mission. Via a wideband data link, data can also be exchanged between the airborne CESHM systems and the ground control segment during an ongoing mission.

Summary

The EW systems from Rohde&Schwarz offer a wide range of applications for use on a variety of platforms. Due to their high mobility and versatile communications capabilities, they support the prompt reconnaissance of radio scenarios, both autonomously or within a network. Since they can be connected to a command and control/evaluation center, they easily integrate into network-centric warfare (C4ISR) systems.



R&S®MobileLocator System Software

Advanced interference hunting and emitter location

R&S®MobileLocator makes it possible for the first time to detect and automatically locate a transmitter from a moving DF vehicle. Within minutes, the compact DF system based on the R&S®DDF007 portable direction finder can turn a commercial vehicle into a DF platform for the frequency range from 20 MHz to 6 GHz. In combination with other Rohde&Schwarz direction finders, R&S®MobileLocator can also be used in dedicated DF vehicles and helicopters.

Faulty, poorly shielded or incorrectly configured electronic devices can unintentionally emit electromagnetic waves and interfere with or even disrupt existing radio services. Sources of such interference are frequently located in urban areas. This makes precise direction finding extremely difficult due to multipath propagation that results from radio waves being reflected and diffracted by surrounding buildings and other objects. Unless the operator has many years of experience in finding radio interference sources, having capabilities that quickly and automatically lead to the target is highly desirable.

Broad scope of application

R&S®MobileLocator was developed for automatic location of fixed frequency signals in urban areas. The signal does not have to be continuously active as long as a sufficient number of signal bearings are taken. R&S®MobileLocator is not designed to locate push-to-talk (PTT) networks or frequency agile signals.

New



Key facts

- Fast, easy installation in commercial vehicles
- Optimized for interference hunting in urban areas (multipath propagation)
- Automatic location of the transmitter's position
- Generation of an interference search report with all relevant information
- Straightforward and easy-to-use user interface

Benefits and key features

- Easy to transport, easy to set up
 - Simple system configuration
 - Support for laptops and tablets
 - Fast setup in commercial vehicles
- Comprehensive, optimized system software
 - Complete system software package
 - Optimized web-based user interface for touchscreen operations
 - Wide variety of expansion options
- Straightforward interference search and signal monitoring
 - Panorama scan for quick overview of all signal activity
 - Signal demodulation and audio recording
 - Spectrum display in realtime bandwidth for detailed signal monitoring
- Automated interference hunting
 - Typical interference signals
 - Automatic collection and evaluation of DF results
 - Homing in on a transmitter
 - Report generation with all relevant information

Multipath propagation

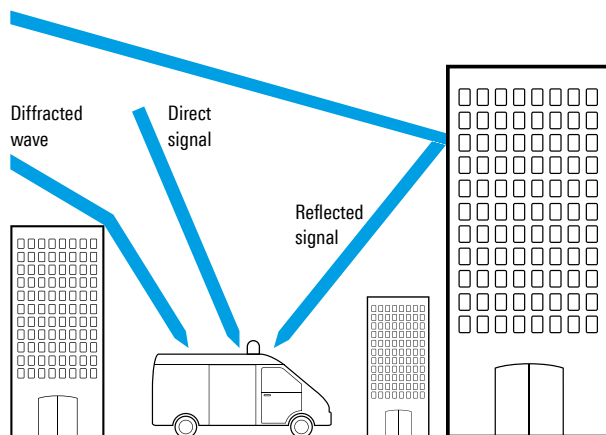

Due to multipath propagation in urban areas, the vehicle receives the radio signal of interest from multiple directions.



Commercial vehicle with installed R&S®MobileLocator ready for use. The operator controls the system via a laptop or tablet.

Simple system configuration

Automatic direction finding with R&S®MobileLocator requires a Rohde&Schwarz direction finder with DF antenna. For a small, mobile system, the R&S®DDF007 with the following options is recommended:

- R&S®DDF007-RC (remote control)
- R&S®DDF007-GPS (GPS position)
- R&S®DDF007-PS (panorama scan)

The R&S®ADD107 and the R&S®ADD207 are the DF antennas of choice for this direction finder. Necessary accessories include the R&S®ADD17XZ3 vehicle adapter with magnetic mount and the R&S®ADD17XZ5 cable set with converter.

R&S®MobileLocator can be used with all Rohde&Schwarz direction finders. The web-based GUI instead of R&S®MapView is available for the R&S®DDF007, R&S®DDF205 and R&S®DDF255 direction finders.

The R&S®MobileLocator software is installed on a laptop or powerful tablet and connected to the direction finder via a LAN cable.



R&S®MobileLocator control software on a laptop or tablet. Display of the current position with vehicle heading, DF spectrum and level versus time, together with the heat map for interference hunting.

R&S®DDF007 direction finder, R&S®ADDx07 antenna and laptop with installed R&S®MobileLocator software



Specifications in brief

Direction finder		
R&S®DDF007 ¹⁾	with R&S®DDF007-RC, R&S®DDF007-GPS options	20 MHz to 6 GHz (DF)
R&S®PR100; with R&S®PR100-DF option	with R&S®PR100-RC, R&S®PR100-GPS options	20 MHz to 6 GHz (DF)
DF mode		
Frequency range ²⁾	with R&S®ADD107	20 MHz to 1.3 GHz
	with R&S®ADD207	690 MHz to 6 GHz
DF method	20 MHz to 173 MHz	Watson-Watt
	173 MHz to 6 GHz	correlative interferometer
Bearing accuracy	with R&S®ADD107 (20 MHz to 1.3 GHz)	typ. 3° RMS
	with R&S®ADD107 (300 MHz to 1.3 GHz)	typ. 1° RMS
	with R&S®ADD207 (690 MHz to 6 GHz)	typ. 1° RMS
Receive mode		
Frequency range	with separate receiving antenna	9 kHz to 7.5 GHz
Scan speed	with R&S®DDF007-PS or R&S®PR100-PS option	up to 2 GHz/s
IF spectrum display range	selectable	up to 10 MHz
Demodulation bandwidth	selectable	up to 500 kHz
General data		
Operating time per lithium-ion battery pack	DF mode	up to 4 h
Weight	R&S®DDF007 with battery	approx. 3.5 kg
	R&S®ADD107, R&S®ADD207	approx. 6 kg
Operating temperature range		0 °C to +50 °C
Storage temperature range		-20 °C to +60 °C
Power supply	AC, with external power supply unit, DC	100 V to 240 V AC, 50/60 Hz, 1 A 20 V to 30 V DC, 4 A 24 V DC (nom.)

¹⁾ R&S®MobileLocator with the web-based GUI can be used with the R&S®DDF205 and R&S®DDF255 direction finders. All other Rohde&Schwarz direction finders are supported with R&S®MapView instead of the web-based GUI.

²⁾ Any other Rohde&Schwarz DF antenna supported by the selected direction finder can also be used. If the DF antenna does not have an integrated GPS module, a separate GPS module is required.

Ordering information

Designation	Type	Order No.
Base unit		
R&S®MobileLocator system software ¹⁾ consisting of: <ul style="list-style-type: none"> ■ R&S®RA-BASIC basic RAMON module with WIBU hardlock ■ R&S®DDF007-CTL control software ■ R&S®RA-LOC radiolocation module ■ R&S®RA-MLWEB MobileLocator web-based GUI 	R&S®RA-MOBLOC	3029.8815.02
Web GUI for R&S®MobileLocator Web-based user interface for easy control of R&S®MobileLocator as an extension to the existing R&S®RAMON software package	R&S®RA-MLWEB	3029.8821.02

¹⁾ Hardware not included. Laptop or tablet, direction finder, DF antenna and accessories must be ordered separately.

Camouflaged Mobile Surveillance Systems

The camouflaged mobile surveillance system provides extensive communications intelligence capabilities for clandestine and covert surveillance operations. It allows governmental agencies and law enforcement authorities to implement effective reconnaissance without any parties knowing who is sponsoring or carrying out the operation.

The system presented here covers the VHF/UHF range. However it is a scalable solution that can be expanded to other frequency ranges. It can be merged with optical sensors with other systems for exploiting the electromagnetic spectrum. It can also be embedded in an intelligence network, together with other mobile surveillance systems, to exchange data such as orders, reports with interception results and target profiles with headquarters. The camouflaged mobile surveillance system is integrated in a suitable panel van equipped with a standard roof plus an additional high roof of composite material. The layout has proven successful in field use.

The camouflaged mobile surveillance system can be used for patrol, homing, surveillance, reconnaissance and other missions. The system can initially be used in areas where no pre-information is available. After gaining first, rough overview of channels or frequency ranges of interest at certain locations, the surveillance of these targets can continue. Using the system in this way provides a situation picture that gradually becomes more and more detailed.

Surveillance system (not visible from outside)

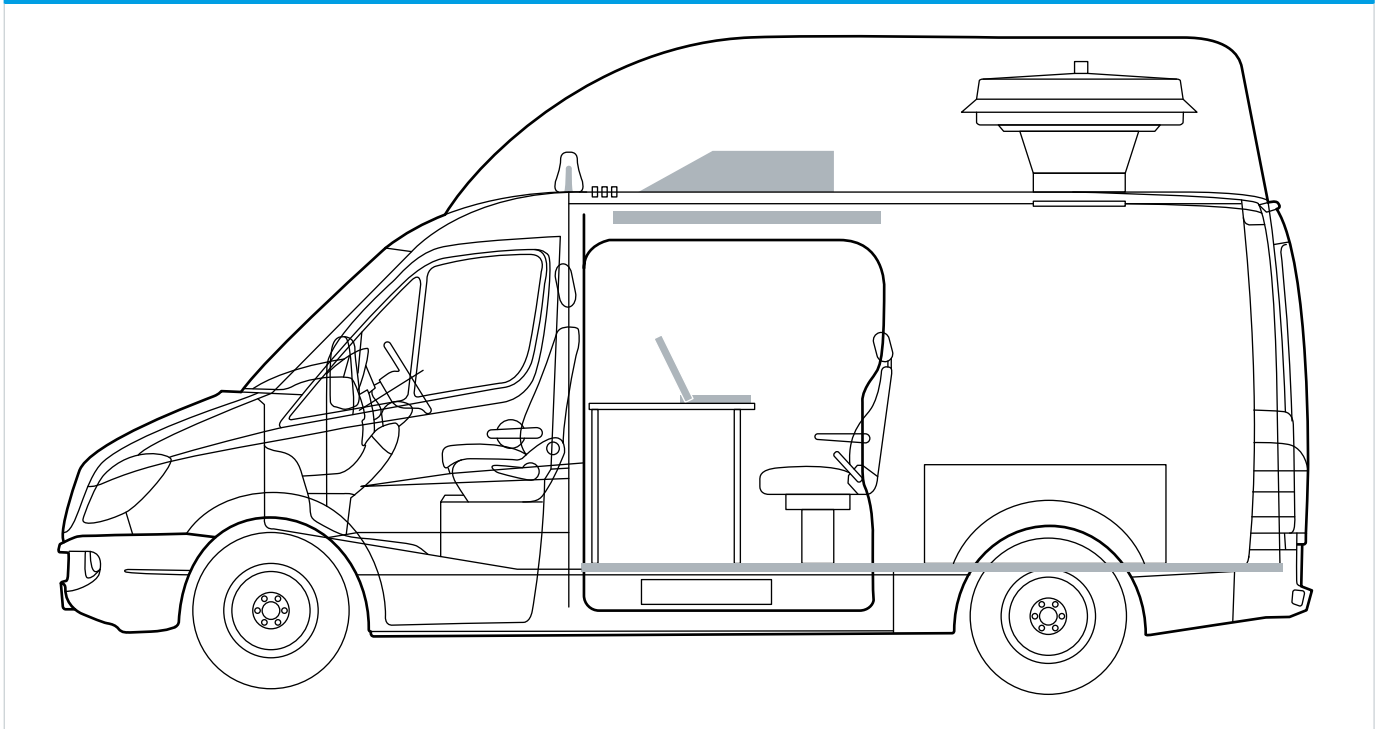

The camouflaged mobile surveillance system consists of powerful elements:

- One R&S®ADD253 VHF/UHF direction finding antenna for the frequency range from 20 MHz to 3 GHz positioned on the metal roof underneath the vehicle's glass-fiber high roof
- One R&S®HE500 VHF/UHF monitoring antenna positioned on the metal roof underneath the vehicle's glass-fiber high roof; for interception of VHF/UHF communications in the frequency range from 20 MHz to 3000 MHz
- One R&S®DDF550 wideband direction finder covering the frequency range from 20 MHz to 6 GHz with 80 MHz realtime bandwidth in the VHF/UHF/SHF range
- One R&S®EB500 monitoring receiver with up to 20 MHz realtime bandwidth for search and monitoring in the VHF/UHF range

The system also contains IT equipment, including R&S®RAMON control and database software, R&S®CA100 PC-based signal analysis and signal processing software, a 19" rack, cabling, a set of system accessories (such as GPS receiver) and a suitable vehicle with a special power supply system, glass-fiber high roof, etc.

Search operation

In order to obtain an overview and for a first reconnaissance, a scan of the spectrum of interest is performed to show all active emitters. To run a search, operators use the R&S®EB500 monitoring receiver in panorama scan mode. This mode allows a very fast scan, preventing short emissions from going unnoticed.

The display shows the online spectrum and its history as a waterfall diagram, providing color-coded information about the frequency, the duration of occasionally occurring signals and the level. By double-clicking on a peak in the spectrum display, operators can change to the fixed frequency mode and listen in on the signal.

Alternatively, if the direction of the sought target(s) is known, a frequency scan of a dedicated frequency range and/or azimuth sector is carried out as an initial reconnaissance task. For this, operators use the R&S®DDF550 wideband direction finder. Besides the spectrum and waterfall diagrams, the system also displays "azimuth over frequency", which is a presentation of all emissions of a frequency range and their direction relative to the vehicle. The waterfall colors indicate the emission's direction, allowing easy identification of push-to-talk (PTT) communications.

Channels and frequency ranges that are not of interest can be suppressed. The direction finder also allows operators to blank azimuth sectors in order to concentrate exclusively on the area of interest. To handle the system capacities properly, single channels can be easily handed over from the receiver to the direction finder or vice versa. Suspicious channels can be put on the frequency list for further surveillance.

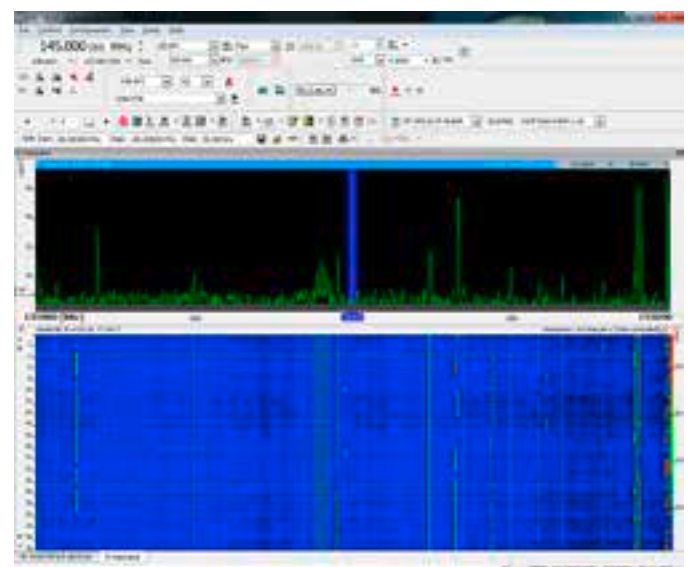
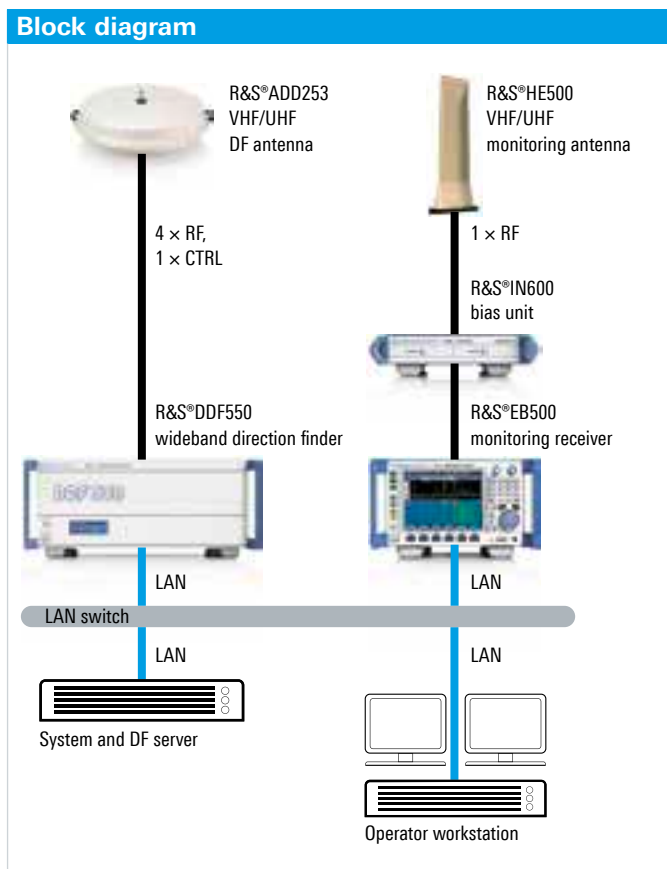

Spectrum overview with waterfall diagram.

Alternatively, operators can use the automatic signal detection of the R&S®CA100 signal analysis software. In this mode, the software detects and classifies signals at once. Such routine automatic system functions enhance the system capabilities tremendously.

Radiomonitoring

When a suspicious transmitter is active, operators can listen in on analog audio signals or demodulate and decode digital signals. Audio signals are processed digitally from the receiver or direction finder to the system controller. From the controller, operators can listen in on both channels – the receiver and the direction finder. He can repeat the missed sequence of a content of interest since the system stores the last minute in a ring buffer. The audio file can be stored on the hard disk, where it is administered by the audio database. Conventional transcription directly in a digital report is also possible.

In the case of digital signals, operators might recognize the type of digital modulation or waveform in the IF spectrum or demodulated audio. If not, the automatic classification function may succeed. Then the R&S®CA100 signal analysis software recognizes the signal's modulation and code type. This procedure can be performed automatically, and production of the content starts immediately.

Alternatively, the R&S®CA100 signal analysis software interactively provides technical analysis. Operators control the receiver settings and the demodulation and decoding parameters directly from the graphical user interface. The system visualizes the results in definable presentations for efficient technical analysis.

In the case of a very uncommon signal that the system does not classify in time, operators can record the IF signal for later offline analysis. Both, the recording and the offline analysis are integrated in the system, ensuring that no signal is lost.

Radio surveillance

Surveillance of known – previously detected – channels that are of interest can be performed in different ways. Operators can create jobs with the R&S®RAMON control software that the system processes automatically. These jobs can trigger alarms and actions, such as automatic recording or direction finding of an emission. Alternatively the monitoring receiver or the digital direction finder can run in the memory scan mode. When a signal above the defined threshold comes up on one channel, the system can immediately start demodulating the signal.

Operators can save the content of the audio signal through transcription or digital recording. If the direction finder is used for the surveillance task, the azimuth of the signal is also indicated on a polar diagram and in a digital map. This mode is highly efficient for surveillance of a number of occasionally occurring signals, allowing automatic operation eliminating routine operator tasks.

Homing and geolocation

The mobile system's homing and locating functionalities allow direction finding of single channels. For homing, the system informs operators and/or the driver of the transmitter's direction relative to the vehicle, usually on a polar diagram. The driver can steer the vehicle toward the emission, always knowing the direction but not the distance to the emission.

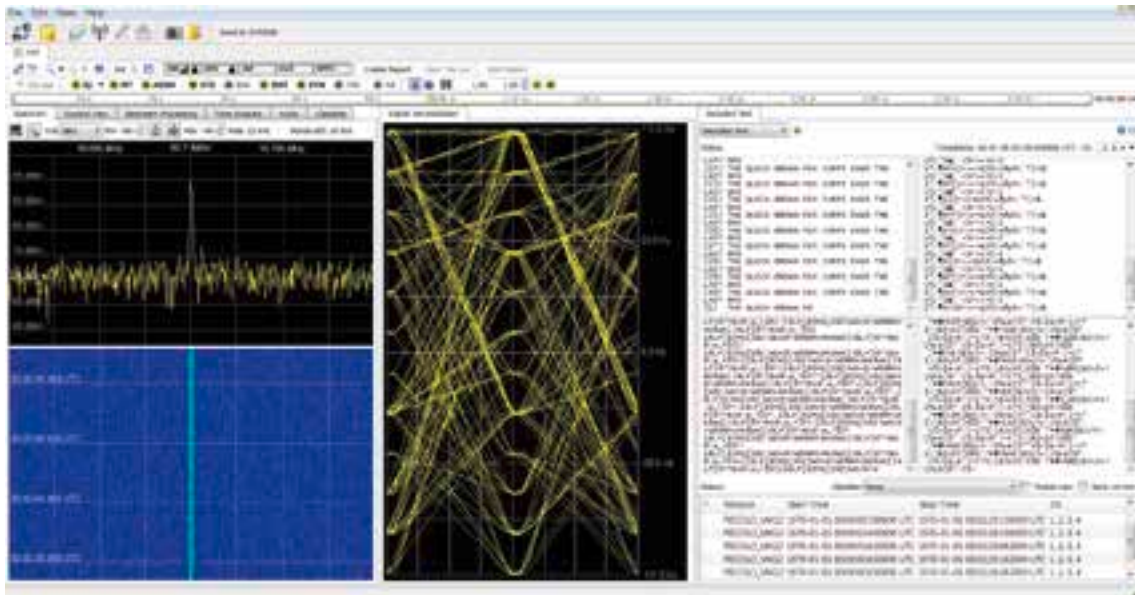

Automatic recognition of the signal type, demodulation and decoding.

Signals that are reflected by several objects cause distorted wavefronts and do not authentically indicate the bearing of the target. For this reason, the direction finder measures how homogeneously the wavefront reaches the direction finding antenna. This value is called signal quality and indicates the reliability of the bearing.

When homing, the mobile system might unexpectedly be too close to the target even in covert operation. The measured level fluctuation can give an indication of the distance, but homing cannot replace actual locating. A target can be located using triangulation, either in a network of two or more mobile systems or in tangential motion toward the target, by taking several bearings of the emission and overlapping them.

Operators also work with the digital map, displaying the vehicle's position and bearings. The system takes these measurements of angles referenced to the vehicle's positions and geographic north. It can record these bearing and allow operators to superimpose them for geolocating the signal source. This allows the emitter to be located without coming too close to the target.

Reporting

During the mission, operators can complete reports by entering comments or transcriptions; the system adds the device settings automatically. Different attachments – such as location results, screenshots of the digital map, recordings of audio, spectrum scan and bearing recordings – can easily be added.

Finally the report is closed and stored in the report database for post-mission evaluation. Database queries allow efficient retrieval in order to find repeated objects (locations, channels used, etc.) in previous missions. Operators can export the reports for evaluation at headquarters or another site where a second report database is installed. Alternatively, operators can connect a printer and print the report conventionally; the (digital) attachments can be stored on a portable storage device.

System services

Rohde & Schwarz has extensive experience in managing the integration of mobile surveillance systems and provides comprehensive services for system integration and system lifecycle. Internal company standards ensure thorough quality management and an efficient organizational structure, and project teams with many years of experience in COMINT technologies provide a strong basis for the success of the project.

Rohde & Schwarz also provides training programs for efficient operation of the camouflaged mobile surveillance system. Lifecycle support includes software updates and hardware upgrades, e.g. for expanding the frequency range and enhancing the system functions, as well as further training and maintenance services, including the provision of spare parts for long-term successful operation of the camouflaged mobile surveillance system.

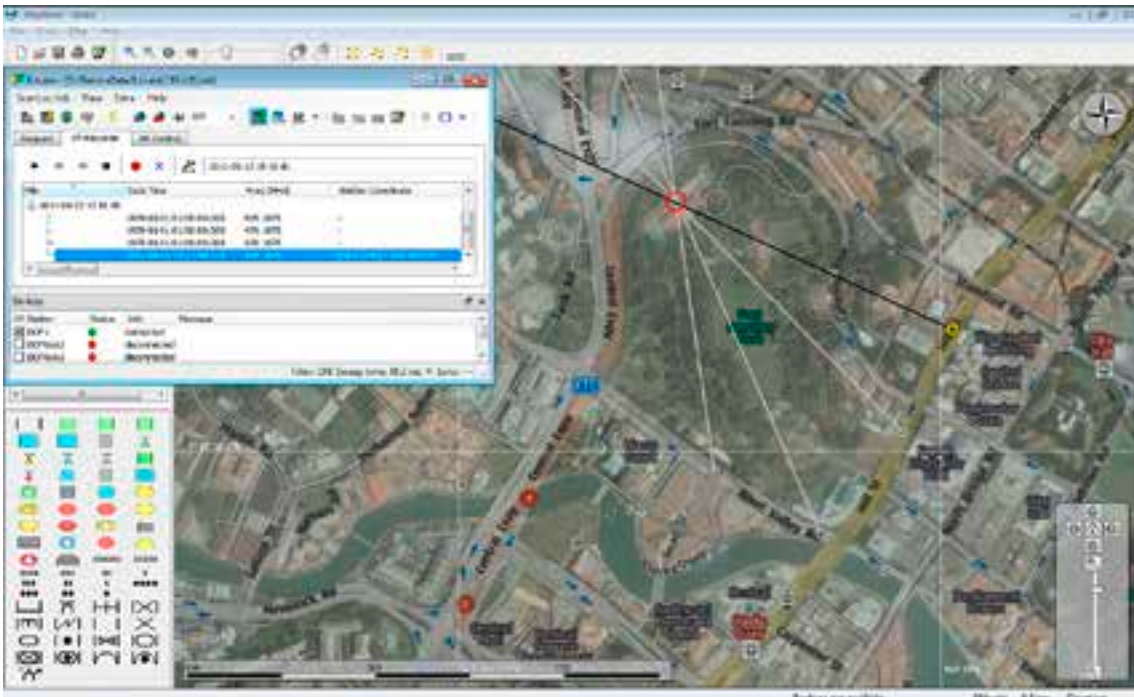

Geolocating an emitter while taking bearings on the move.

Hybrid radiolocation using conventional AoA direction finding and TDOA

New

Locating transmitters is a fundamental task for spectrum monitoring and COMINT systems. This is especially important in case of illegal and unlicensed transmitters or when e.g. defective devices cause interference in other radio services. Furthermore, the precise location of a transmitter is essential for its identification and the creation of a communications order of battle. Until now, direction finders have typically been used. New solutions based on the time-difference-of-arrival (TDOA) principle are an excellent supplement to classical direction finding systems.

TDOA – the concept

Emitter location based on time difference of arrival (TDOA) must meet the same requirements as tried and tested direction finding based on conventional angle of arrival (AoA). A sufficient number of receivers must be positioned around the transmitter to be located. Its signals, which are propagating at a constant speed, reach the receivers at slightly different times because the receivers are normally located at different distances from the point of emission. The coordinates of the transmitter, i.e. its location, can be calculated from these relative time differences.

Mathematical correlation methods are used to calculate the relative time difference of signals arriving at two receivers. This value and the geographic coordinates of the receivers provide the basis for calculating all possible transmitter positions. Transferred to a map, they would lie on a hyperbola. The calculation is then repeated for a second and, where appropriate, multiple receiver pairs. The point at which the hyperbolas intersect is the origin of the signal, i.e. the transmitter site. This intersection principle is also used for radiolocation by means of direction finders, but with the main difference that relevant transmitter sites do not lie on a hyperbola but on a straight line.

TDOA location: Three hyperbolas are calculated on the basis of the relative time difference of signals arriving at three receivers. The point at which the three hyperbolas intersect is the transmitter position.

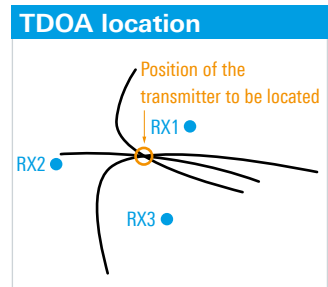

The compact outdoor R&S®UMS300 monitoring and radiolocation system for ITU-compliant monitoring, direction finding and emitter location based on TDOA.

This means that a TDOA radiolocation system must consist of at least three receivers providing three hyperbolas (RX1 – RX2, RX1 – RX3, RX2 – RX3, see figure on the left). More receivers increase accuracy. There is, however, an upper limit for receivers above which calculation time increases drastically without any significant improvement in accuracy. And there are clear parallels to radiolocation by means of direction finders, too. At least two direction finders are required; a third one increases accuracy, while five or more direction finders do not significantly improve results.

Since electromagnetic waves propagate at the speed of light, system accuracy in the nanosecond range is vital in order to calculate the time differences of arrival. This is why GPS receivers are used. They provide accurate timestamps, which are inserted into the baseband (I/Q) data, and the I/Q data is then used for correlation (see figure below). To ensure that calculations provide sensible, unambiguous results, the signals must contain a minimum of information. This is one of the reasons why TDOA is less suitable for unmodulated carrier or CW signals.

The advantages of the TDOA method are particularly revealed in densely built-up urban environments. Typical drawbacks such as reflections and multipath propagation, which create immense challenges for direction finders, are reduced by suitable TDOA algorithms. Complex signal scenarios are frequently prevalent in urban environments. These environments harbor a colorful mix consisting of many emissions; weak transmitters are frequently placed directly adjacent to strong ones, making exacting demands on the linearity, sensitivity and dynamic range of the receivers.

Hybrid TDOA/AoA location – the best of both worlds

Either a TDOA system or an AoA DF system may yield the best results, depending on the signal scenarios and local circumstances. Ideally, both methods should be available at the same time in order to combine their advantages. The new hybrid radiolocation systems from Rohde&Schwarz are ideal for meeting the requirements of both methods and offer a wide range of components for TDOA-based location: the R&S®ESMD, R&S®EB500 and R&S®EM100 monitoring receivers, the R&S®DDF255 and R&S®DDF205 direction finders, as well as the R&S®UMS300 compact monitoring and radiolocation system (see photo on the left) and the R&S®UMS175 compact monitoring system. To make these devices TDOA-capable, users simply have to connect a suitable GPS receiver (IGT option) and load the latest firmware. Existing devices can be easily retrofitted.

Using a sophisticated method, the Rohde&Schwarz devices calculate the signal delay between antenna input and signal processing and correct the timestamp inserted into the baseband data. This boosts time and location accuracy. In addition, this innovative concept, which is unique on the market, allows users to combine all Rohde&Schwarz devices that support TDOA in any arbitrary configuration to perform emitter location.

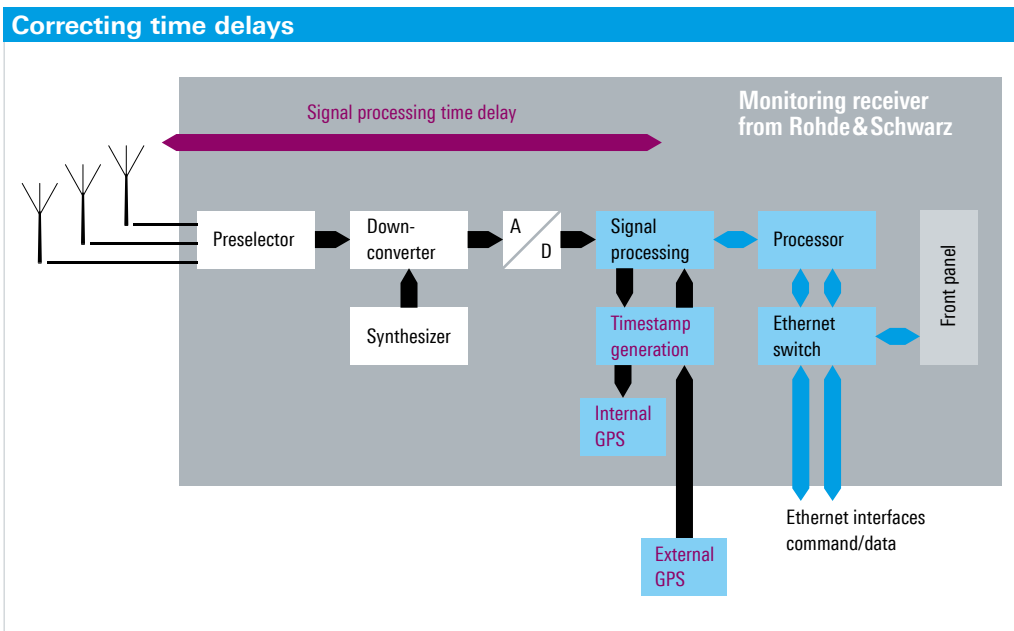

Rohde & Schwarz devices measure the time delay between antenna input and signal processing. This substantially boosts location accuracy.

ITU conform measurements are controlled by the R&S®ARGUS monitoring software. Successful on the market for more than 25 years, this software has become the world spectrum monitoring standard for regulators and similar organizations. TDOA location can be seamlessly integrated into the numerous measurement and analysis functions offered by this software. The first step in a conventional workflow is to scan a specific frequency band. All transmitters that are found are compared with a reference list that is typically imported from a license database. Active transmitters that are not in the reference list, e.g. unlicensed, are analyzed in greater detail, identified and located. So far, radiolocation has primarily been carried out by means of direction finders. Now, users have a choice between the TDOA method and a combination of TDOA and AoA. They can also perform measurements automatically or interactively.

The R&S®MapView geographic information software is used to select the relevant sensors and display the direction finding and radiolocation results on electronic maps. The software offers a wide range of maps in various formats (free and commercial) and displays the positions of known or licensed transmitters in addition to radiolocation results (see screenshots).

Advantages of the Rohde & Schwarz solution

Implementing optional TDOA functionality in the latest generation of receivers and direction finders from Rohde & Schwarz has the following key advantages:

High-quality devices ensure higher location accuracy

High-quality, ITU-compliant devices are a must for successful TDOA location, especially when it comes to signal scenarios in large cities. High sensitivity and a wide dynamic range make it possible to accurately measure even weak signals in close vicinity to strong transmitters.

The accuracy of a TDOA location increases with extended signal bandwidth and a better signal-to-noise ratio (S/N). The narrower the signal, the less accurate its location. The high sensitivity of the Rohde & Schwarz receivers creates a higher S/N ratio and provides more accurate radiolocation results. In many cases, it is the high sensitivity which makes radiolocation possible at all. The high sensitivity also compensates for bandwidth-related inaccuracy, i.e. high-quality devices locate narrowband signals with higher accuracy.

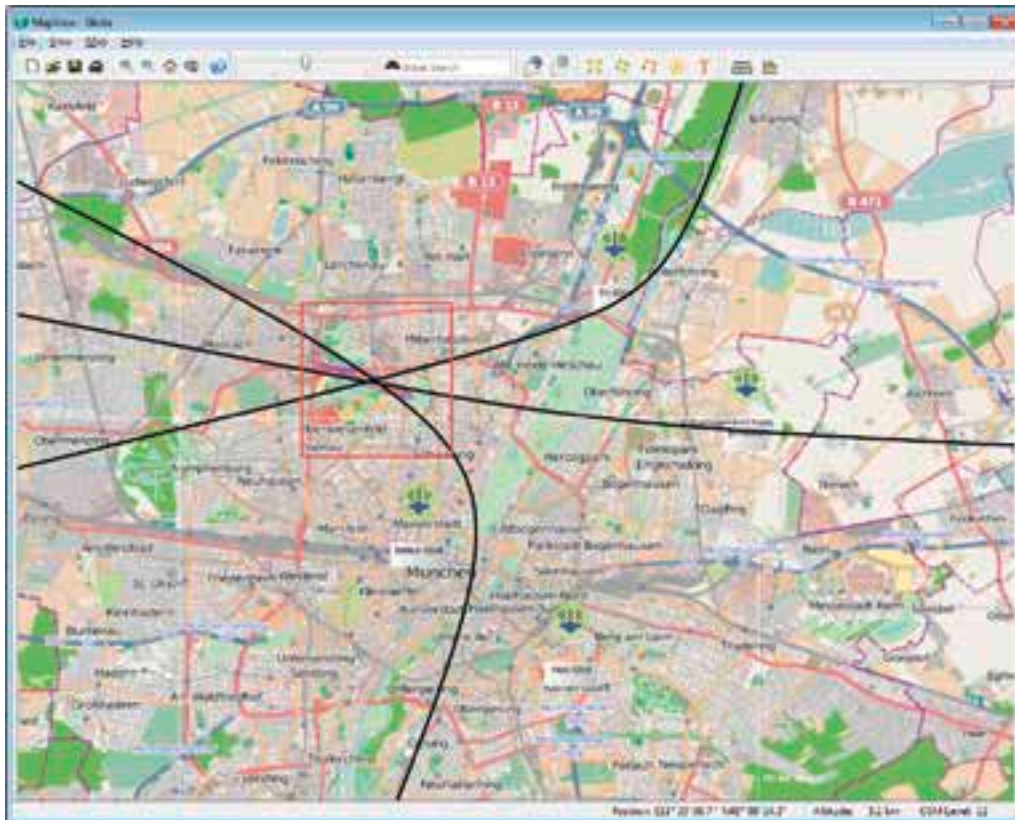

Display of TDOA results as hyperbolas and heatmap.

Flexible combination of TDOA and AoA

Users can select between the TDOA method, AoA and the hybrid solution depending on the situation and always have the best method at their fingertips.

In times when no radiolocation tasks have to be performed, systems can be used for other demanding measurements

Emitter location is an important task, but experience shows that it requires only a minor portion of the time. Pure TDOA sensors are largely useless for the rest of the time. Devices and systems from Rohde&Schwarz with optional TDOA capability, by contrast, can be used around the clock for a wide range of additional monitoring tasks. All these TDOA-capable devices and systems can be configured in any combination, enabling users to select the optimum device for their main task.

Including TDOA functionality in existing hardware obviates the need to find new sites

It is more and more difficult to find suitable sites for additional monitoring stations. Since existing stations can be easily enhanced, there is no need to spend time and effort in finding sites and in providing the necessary infrastructure such as electricity or connection to network and communications equipment.

Summary

The basic concept of TDOA location is not new. Transmit signals with ever expanding bandwidth, compact, high-performance receivers, global coverage of highly accurate time and position information based on GPS, as well as an ever faster communications infrastructure are good reasons for believing that TDOA will now become a technological and economic success. With its large range of TDOA-capable devices and systems, Rohde&Schwarz offers scalable solutions for a wide variety of tasks. In particular, the combination of TDOA with direction finding based on conventional AoA offers the optimum solution for almost any application. This enables all transmitters to be located rapidly and reliably at any time.

Hybrid radiolocation using hyperbolas and line of bearing.

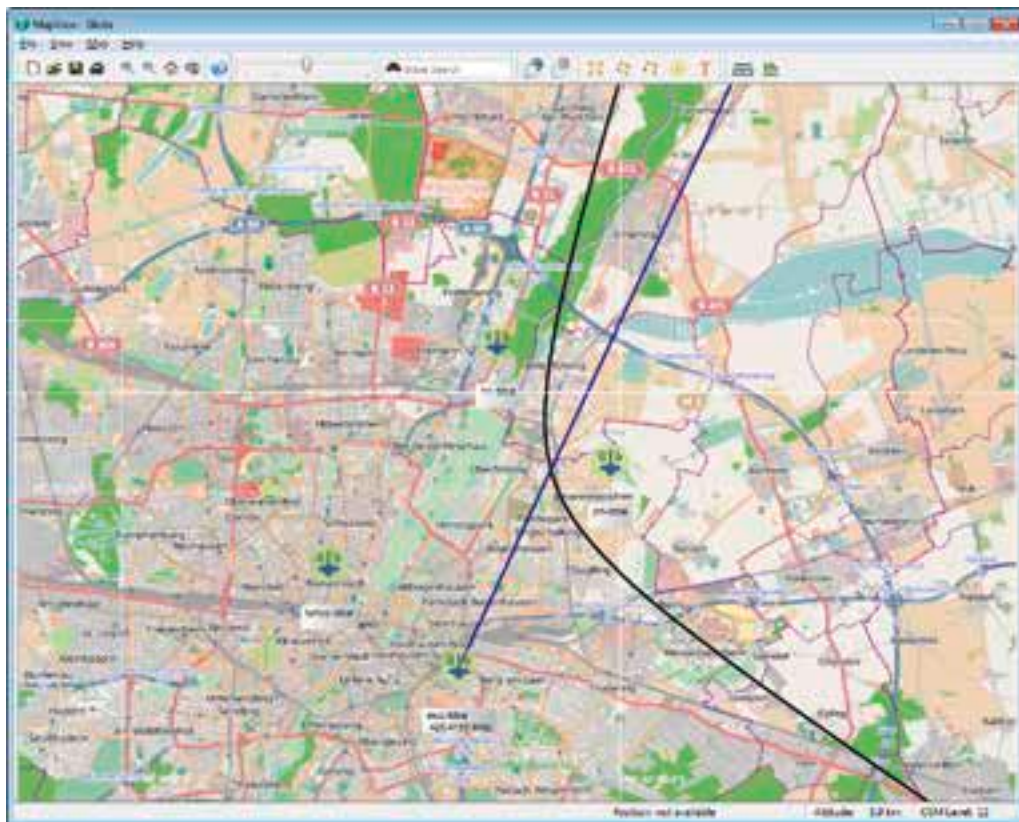



Chapter 8

Appendix



8

Description	Page
Service that adds value	232
Index by type	236

Service that adds value

Dear Customers,

I am often asked what has made Rohde & Schwarz so successful over so many decades and enabled the company to drive technological progress in its fields of business. One aspect is the passion with which we work every day in our development labs to push the limits of what is physically feasible. Another is our desire to create only products that meet customer expectations in terms of technology, functionality and quality.

Our service philosophy is another key factor to our success. For us it goes without saying that we offer our customers the best possible support in all phases of the product lifecycle. We therefore provide a wide variety of customized service offerings, which we plan in dialog with our customers and our specialists as early as the product development phase. This lets us identify and cater to individual needs early on, in order to minimize costs while maximizing availability and autonomy.

Our comprehensive and continually growing range of services is designed to ensure that you are satisfied with every aspect of our products. I am convinced that this commitment, implemented by our worldwide network of dedicated, expert service personnel, is one of the major factors behind the success of our company.

Sincerely yours,
Christian Leicher (President and COO)

Investment protection, tailor-made

Rohde & Schwarz offers full-range service at your command. You can mix and match our services according to your technical and budgetary requirements.

R&S® Extended Warranty

The R&S® Extended Warranty offers cost control while giving you full service from the start. If there is a problem, you are insured against extra service costs. For a fraction of the purchase price, you can rest easy for years with the security afforded by manufacturer service.

- ▮ Low, predictable costs
- ▮ Safe and dependable
- ▮ Transparent and flexible

To make sure you get the full benefit of the functionality and precision of your instruments for the longest possible time, we offer a range of services that are tailored to your specific needs. Choose extended warranty for complete protection in case of repair, or the attractive extended warranty with calibration coverage package for additional regular calibration of your instrument. Both are available with terms of one to four years.

Warranty extension:

- ▮ Repair in case of malfunction
- ▮ R&S® Manufacturer Calibration if necessary during repair
- ▮ Firmware updates
- ▮ Preventive maintenance and reliability modifications

Warranty extension with calibration coverage additionally covers:

- ▮ Planned calibrations in line with Rohde & Schwarz guidelines and ISO/IEC 17025
- ▮ Calibration as needed during technical upgrades



Rohde & Schwarz calibration services

Our various calibration products enable us to tailor our services to your individual needs. Whether you choose our Rohde & Schwarz manufacturer calibration or a Rohde & Schwarz accredited calibration – you will always receive a service package that is more complete and comprehensive than what a pure service provider can provide. We offer attractive contract solutions for all our products. Our sales and service representatives will be happy to help you determine the right solution for your requirements.

Rohde & Schwarz accredited calibration

Rohde & Schwarz accredited calibrations ensure compliance with international standards and calibration data traceability. Many standards require accredited calibrations as proof of competence. Our accredited service centers not only measure accredited parameters, they also verify all product characteristics. A Rohde & Schwarz accredited calibration is as comprehensive and in-depth as a Rohde & Schwarz manufacturer calibration and provides additional accreditation documentation.

Rohde & Schwarz manufacturer calibration

A Rohde & Schwarz manufacturer calibration ensures you a comprehensive range of services. As the manufacturer, we take care of all required adjustments, software updates and hardware modifications. We document each calibration with a certificate that contains both the incoming and outgoing status of your instrument. This enables you to evaluate your instrument's past performance

and draw conclusions about future performance. Like all Rohde & Schwarz calibrations, the Rohde & Schwarz manufacturer calibration is based on national and international standards.

Multivendor performance calibration

We also service other manufacturers' instruments. As an equipment manufacturer, we know the relevant parameters for a definitive calibration. That is what makes us a competent partner for calibrating other manufacturers' instruments. During multivendor performance calibration, all required manufacturer-specified instrument parameters are measured. You receive a calibration certificate and documentation of measurement results. These services are also available as accredited services.

Depot calibration

Take advantage of all the benefits of our fast and efficient depot service. With Rohde & Schwarz depot calibration, your instrument is returned after just a few days. Express depot calibration takes just one day plus shipping time. We will be happy to take care of the logistics for you – just ask.

On-site calibration

Would you like to reduce your downtime even more? We can come to you with our mobile calibration system – no need for time-consuming packing and shipping. Our sales and service representatives will be happy to sit down with you and tailor a calibration concept to your needs.

	Rohde & Schwarz accredited calibration	Rohde & Schwarz manufacturer calibration	Multivendor performance calibration
ISO 17025 accredited	•		◦
ISO 9001 certified	•	•	•
Calibrated in line with ISO 17025	•	•	•
Traceability to national/international standards	•	•	•
Virus and malware scan for Rohde & Schwarz products	•	•	•
Incoming results	•	•	•
Comprehensive measurement in line with manufacturer specifications	•	•	•
Firmware update	•	•	
Required adjustments	•	•	
Preventive maintenance/performance modifications	•	•	
Outgoing results (after repair or adjustment)	•	•	
Calibration certificate	•	•	•
R&S®Online Service Management	•	•	•
Service report	•	•	•
Cleaning	•	•	•
Electrical safety test	•	•	•

◦ Optionally accredited.

Rohde&Schwarz standard price repair

If a Rohde&Schwarz product ever does need to be repaired, smooth handling is required: without hassle, without losing time and without any unpleasant surprises regarding costs. That's why Rohde&Schwarz offers its customers a standard price repair option: an intelligent comprehensive solution featuring guaranteed all-inclusive fixed prices, little handling effort and efficient procedures.

Scope of the Rohde&Schwarz standard price repair:

- Repair of the equipment
- Full calibration in line with ISO 17025, including documentation of the test results¹⁾
- 12-month service warranty on the entire equipment²⁾
- Latest firmware and hardware updates³⁾

With the standard price repair, you are always on the safe side:

- Defined fixed price
- Smooth handling
- Minimum effort
- Reliable repair by the manufacturer
- Updates and calibration included
- Extensive service warranty

¹⁾ For equipment requiring calibration.

²⁾ Applies to the repaired component if the system consists of several components, e.g. amplifier modules. Please see our General Conditions of Delivery and Service for more warranty information.

³⁾ Such modifications, e.g. precautionary component replacement, are performed as part of the continuous product improvement process and do not change the specifications or other product characteristics.

R&S®Service Level Agreement

We lay the groundwork for top performance in your core business – that's our primary focus at Rohde&Schwarz. That's why we back up our high-quality, long-lasting products with our service level agreement, providing you with exceptionally reliable service that helps you control your costs.

Benefits at a glance

- Ensured support and response times
 - Planned expenditures
 - Reliable operation
 - Repair services
- Maximum system availability

Tailored to your needs: the service packages

Every operator has unique system requirements. Especially when you demand the highest level of reliability from your systems, an R&S®Service Level Agreement pays off.

You determine which services you wish to use. Three service levels are available: Basic, Advanced and Premium.

They encompass services such as the following:

- 24/7 problem reporting: access to online ticketing system
- Technical phone support during business hours
- 24/7 emergency technical support
- Maintenance releases (software updates)
- Remote error analysis
- Remote system updates
- Overview of your requests
- Access to feature request system
- Repair services
- Local spare parts pool
- On-site support
- Regular maintenance of your Rohde&Schwarz system

R&S®Obsolescence Management

R&S®Obsolescence Management ensures optimal support when it comes to the long-term availability and operational readiness of your systems and products. Enjoy the comfort of no longer having to worry about risks and hidden costs over the full lifetime of your systems and products.

- ▮ Customized and flexible solution strategies
- ▮ Predictable costs for future product modifications
- ▮ Forward-looking identification of potential hidden cost
- ▮ High operational availability of systems and products



R&S®Online Service Management

R&S®Online Service Management provides you with a clear overview and helps you save time by simplifying the management of instrument data, service cases and test equipment. You also benefit from numerous service management functions. A clear user interface makes operation intuitive.

Advantages

- ▮ **Secure:** R&S®Online Service Management gives you secure access to all service-related data, 24/7. Just log on to the password-protected area at my.rohde-schwarz.com/service to conveniently manage your service requests and calibration schedule, wherever you are
- ▮ **Comprehensive:** To make sure that you have more time for your core business, we put all your instrument data together in one place for an easy overview. It shows you all the documentation and configuration data for your instruments, as well as the status of repairs and calibrations. At a glance, you can track service cases, make new requests and see active and inactive warranties
- ▮ **Efficient:** A good management system should make even complex things easier. The R&S®Online Service Management helps you organize your service cases, making previous, current and scheduled calibrations easy to enter and manage. The easy operation and clear navigation save you time as well as unnecessary paperwork

Functions and operation

- ▮ **Equipment:** Manage your equipment – see at a glance whether an instrument was recently calibrated or needs to be in the near future
- ▮ **Service requests:** Place service requests, track the status of orders or review past services. You can also download calibration and service reports
- ▮ **Contracts and more:** Keep your contracts in view and store your personal data – user, division, contact information and much more

Index by type

Type	Designation	Page
A		
R&S®ADD011P	HF DF Antenna	92
R&S®ADD011SR	Super-Resolution HF DF Antenna	91
R&S®ADD015	Centric-Mast HF DF Antenna	92
R&S®ADD050SR	Super-Resolution VHF DF Antenna	91
R&S®ADD070	UHF DF Antenna	92
R&S®ADD071	UHF DF Antenna	106
R&S®ADD075	UHF/SHF DF Antenna	106
R&S®ADD078SR	UHF/SHF SR DF Antenna	91
R&S®ADD107	Compact VHF/UHF DF Antenna	106
R&S®ADD119	HF DF Antenna	91
R&S®ADD153SR	Super-Resolution VHF/UHF DF Antenna	91
R&S®ADD157	Dual Polarized VHF/UHF DF Antenna	92
R&S®ADD175	Compact UHF DF Antenna for mobile radio frequency range	106
R&S®ADD196	VHF/UHF DF Antenna	105
R&S®ADD197	Dual-Polarized VHF/UHF DF Antenna	105
R&S®ADD207	Ccompact UHF/SHF DF Antenna	107
R&S®ADD216	Compact LF UHF DF Antenna	93
R&S®ADD253	VHF/UHF Broadband DF Antenna	92
R&S®ADD295	VHF/UHF Wideband DF Antenna	105
R&S®ADD307	Collapsible VHF/UHF DF Antenna	107
R&S®AllAudio	Integrated Digital Audio Software	166
R&S®ARGUS	Monitoring Software	152
C		
New R&S®CA100	PC-Based Signal Analysis and Signal Processing Software	124
New R&S®CA120	Multichannel Signal Analysis Software	127
R&S®CA250	Bitstream Analysis	136
D		
R&S®DDF04E	Digital Direction Finder for Traffic Control	108
New R&S®DDF007	Portable Direction Finder	100
New R&S®DDF200M	Digital Direction Finder	110
R&S®DDF205	Digital Direction Finde	98
R&S®DDF255	Digital Direction Finder	94
R&S®DDF5GTS	High-Speed Scanning Direction Finder	86
R&S®DDF550	Wideband Direction Finder	88
E		
R&S®EB500	Monitoring Receiver	36
New R&S®EB510	HF Monitoring Receiver	40
R&S®EFW	Flywheel	58
R&S®EM100/R&S®EM100EXT	Digital Compact Receiver	44
R&S®ESMD	Wideband Monitoring Receiver	32
F		
R&S®FU129	Antenna Filter Unit	146

Type	Designation	Page	
G			
	R&S®GPS129	GPS Receiver	144
	R&S®GX410	R&S®AMLAB Signal Analysis Software	134
New	R&S®GX460	Digital Wideband Storage Device	130
New	R&S®GX465	Digital Wideband Storage Device	132
H			
	R&S®HE300	Active Directional Antenna	52
New	R&S®HL300	Handheld Log-Periodic Antenna	54
	R&S®HF907DC	SHF Directional Antenna with Downconverter	56
M			
	R&S®MapView	Geographic Information Software	160
	R&S®MobileLocator	System Software	218
New	R&S®MP007	Portable Direction Finding System	180
New	R&S®MSD	Modular System Device	142
P			
	R&S®PCT	Propagation Calculation Tool	164
	R&S®PR100	Portable Receiver	48
R			
	R&S®RAMON	Radiomonitoring Software	156
	R&S®RO129	Antenna Rotator	148
T			
New	R&S®TPA	Technical Pulse Analysis	138
U			
	R&S®UMS170	Compact Radiomonitoring System	168
	R&S®UMS200	Radiomonitoring and Direction Finding System	172
New	R&S®UMS300	Compact Monitoring and Radiolocation System	176

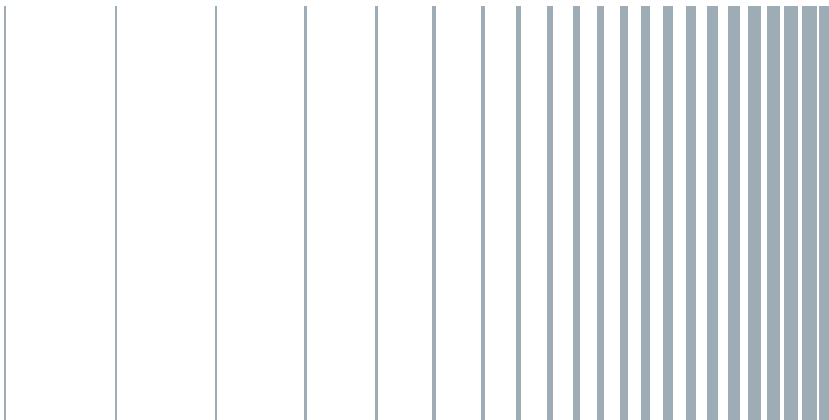

R&S® is a registered trademark of
Rohde & Schwarz GmbH & Co. KG
Trade names are trademarks of the owners
Printed in Germany (sk)
PD 5213.7219.42 | Version 06.00 | October 2015
Subject to change

© 2010 - 2015
Rohde & Schwarz GmbH & Co. KG
81671 Munich, Germany



5213721942