



# Product Catalogue 2017

Multi Band, Multi Polarized,  
Flat Panel & OMNI

Any Size, Any Frequency, Any Gain Ratio

MOBILE INDOOR  
LTE MIMO OMNI WI-FI  
WLAN  
OUTDOOR

01	138 MHz – 960 MHz	Subscriber - Single Pol	Sector - Dual Pol
		Subscriber - Dual Slant	DAS - Single Pol
		Sector - Single Pol	DAS - Dual Pol
02	1395 MHz – 2700 MHz	Subscriber - Single Pol	Sector - Dual Pol
		Subscriber - Dual Slant	Sector - Triple Pol
		Subscriber - Triple Pol	Sector - Quad Pol
		Subscriber - Quad Pol	DAS - Single Pol
		Sector - Single Pol	GPS
03	3.2 GHz – 4.1 GHz	Subscriber - Single Pol	Sector – Dual Pol
		Subscriber - Dual Pol	DAS - Single Pol
		Sector- Single Pol	DAS - Dual Pol
04	4.4 GHz – 5.1 GHz 4.9 GHz – 6.1 GHz 5.4 GHz – 6.5 GHz	Subscriber - Single Pol	Sector -Dual Pol
		Subscriber - Dual Pol	Sector - Double Dual Slant
		Subscriber - Triple Pol	Sector - Triple Pol
		Subscriber - Quad Pol	Sector - Quad Pol
		Subscriber - 5 Pol	DAS - Single Pol
Sector - Single Pol	DAS - Dual Pol		
05	6 GHz – 8 GHz	Subscriber - Dual Pol	
		Sector - Dual Pol	
06	10 GHz 0and Up	Subscriber - Dual Pol	
		Sector - Single Pol	
07	OMNI		
08	Indoor / DAS		
09	Mobile		
10	Parabolic		
11	RF Products		
12	Accessories		

# 138 MHz – 960 MHz

Subscriber - Single Pol  
 Subscriber - Dual Slant  
 Sector - Single Pol  
 Sector - Dual Pol  
 DAS - Single Pol  
 DAS - Dual Pol

Part Number	Description	Frequency band	Gain	Polarization	Dimension	Antenna type	Page
<b>MA-WA640-6</b>	490-860 MHz Subscriber	490-860 MHz	6 dBi	Linear, Vertical or Horizontal	500 x 345 x 140 mm	Subscriber Single Pol	01-1
<b>MA-WA79-UX</b>	700 MHz Upper Band Subscriber	746-806 MHz	8.5 dBi (min.)	Linear, Vertical or Horizontal	305 x 305 x 25 mm	Subscriber Single Pol	01-2
<b>MA-IS91-T2</b>	915 MHz Subscriber	902-928 MHz	10.5 dBi (min.)	Linear Vertical or Horizontal	305 x 305 x 25 mm	Subscriber Single Pol	01-3
<b>MA-IS91-T3</b>	915 MHz Small Size Subscriber	902-928 MHz	8 dBi (min.)	Linear, Vertical or Horizontal	230 x 214 x 31 mm	Subscriber Single Pol	01-4
<b>MA-IS91-R1</b>	915 MHz Subscriber	902-928 MHz	10 dBi (typ.)	RHCP	305 x 305 x 25 mm	Subscriber Single Pol	01-5
<b>MA-WA820-DP8</b>	Dual-Pol Directional	698-960 MHz	8 dBi	Vertical & Horizontal	310 x 310 x 126 mm	Subscriber Dual Pol	01-6
<b>MA-WA6960-DS7</b>	Multi Band Dual Slant Directional	698-960 MHz 1700-2700 MHz 5150-6000 MHz	7.5 dBi 6-7 dBi 6 dBi	Dual Slant $\pm 45^\circ$	300 x 300 x 99 mm	Subscriber Dual Slant	01-7
<b>MA-IS91-DS10</b>	900 MHz Dual Slant Subscriber	902-928 MHz	10.5 $\pm$ 0.5 dBi	Dual Slant $\pm 45^\circ$	370 x 370 x 40 mm	Subscriber Dual Slant	01-8
<b>MA-IS43-B2</b>	433 MHz Panel	433 $\pm$ 2 MHz	4 dBi (min.)	Linear, Vertical	225 x 215 x 29 mm	Sector Single Pol	01-9
<b>MA-WD866-BD7</b>	Bidirectional sector, 2 x 75°	865-867 MHz	7 dBi	Linear, Horizontal	615 x 105 x 130 mm	Sector Single Pol	01-10
<b>MA-WC90-5X</b>	Base Station, 60°	902-928 MHz	14.5 dBi (min.)	Linear, Vertical	1200 x 330 x 105 mm	Sector Single Pol	01-11
<b>MA-WD90-6X</b>	Base Station, 90°	902-928 MHz	13 dBi (min.)	Linear, Vertical	1200 x 330 x 105 mm	Sector Single Pol	01-12
<b>MA-WE90-7X</b>	Base Station, 120°	902-928 MHz	11.5 dBi (min.)	Linear, Vertical	1200 x 330 x 105 mm	Sector Single Pol	01-13
<b>MA-WC91-5H</b>	Horizontally Polarized Sector, 60°	902-928 MHz	14 dBi (min.)	Linear, Horizontal	1200 x 330 x 105 mm	Sector Single Pol	01-14
<b>MA-WD91-6H</b>	Horizontally Polarized Sector, 90°	902-928 MHz	12 dBi (min.)	Linear, Horizontal	1200 x 330 x 105 mm	Sector Single Pol	01-15
<b>MA-WE91-7H</b>	Horizontally Polarized Sector, 120°	902-928 MHz	11 dBi (min.)	Linear, Horizontal	1200 x 330 x 105 mm	Sector Single Pol	01-16
<b>MA-WA82220-DBDP14</b>	Dual Band Dual Polarization	698-960 MHz 1.7-2.7 GHz	12 dBi 16 dBi	Dual Pole V & H	800 x 600 x 110 mm	Sector Dual Pol	01-17
<b>MA-WA6927-DBDP8</b>	Directional Dual Band / Dual Polarized Ant.	698-960 MHz 1700-2100 MHz 2100-2700 MHz	8 dBi 7 dBi 10 dBi	Vertical & Horizontal	310 x 310 x 126 mm	Sector Dual Pol	01-18
<b>MA-WC7927-DS12T</b>	Multi/Wide-Band Dual Slant Directional for Stadium Coverage	790 – 960 MHz 1.71 – 2.69 GHz	9.5 – 12 dBi	Dual Slant $\pm 45^\circ$	811 x 611 x 197 mm	Sector Dual Slant	01-19

MARS Antennas & RF Systems proprietary information

MARS reserves the right to make technical changes or modifications to any of its products and specifications without prior notice and without implementing such changes to prior supplied products. Product images are representative and indicative only. Warranty terms and general conditions of sale are applicable on any purchase of any product, available on MARS website.

3 Hamanor st. Holon 5886103, P.O.Box 1852 Holon 5811801, Israel

Tel: +972-3-5599661 • Fax: +972-3-5599677 • e-mail: mars@marsant.co.il • web: www.mars-antennas.com

Part Number	Description	Frequency band	Gain	Polarization	Dimension	Antenna type	Page
<b>MA-WC90-DS13</b>	Dual Slant Base Station Sector, 65°	850-960 MHz	13 dBi	Dual Slant ±45°	960 x 330 x 120 mm	Sector Dual Slant	01-20
<b>MA-WD90-DS12</b>	Dual Slant Base Station Sector, 90°	850-960 MHz	12 dBi	Dual Slant ±45°	960 x 330 x 120 mm	Sector Dual Slant	01-21
<b>MA-WO-UWB</b>	Ultra Wide Band OMNI Directional	138-174 MHz 380-450 MHz 450-512 MHz 512-698 MHz 698-746 MHz 746-806 MHz 806-960 MHz 1200-2700 MHz 3300-3800 MHz 4100-6000 MHz	3 dBi 4 dBi 5 dBi 5.5 dBi 6 dBi 7 dBi 7 dBi 8 dBi 10 dBi 11 dBi	Linear, Vertical	540 x 40 Dia mm	DAS Single Pol	<b>07-1</b>
<b>MA-CQ26-1X</b>	380 MHz -6 GHz Multi Band Omni	380-806 MHz 806-960 MHz 1395-1432 MHz 1710-2170 MHz 2300-2500 MHz 3300-3700 MHz 4900-6000 MHz	1 (2*) dBi 4 dBi 5 dBi 5 dBi 5 dBi 5 dBi 6 dBi	Linear, Vertical	Base Dia. - 275 Height - 187 mm	DAS Single Pol	<b>07-2</b>
<b>MA-CQ27-1X</b>	380 MHz -6 GHz Multi Band Omni	380-806 MHz 806-960 MHz 1395-1432 MHz 1710-2170 MHz 2300-2700 MHz 3300-3700 MHz 4900-6000 MHz	1 (2*) dBi 4 dBi 5 dBi 5 dBi 6 dBi 6 dBi 6 dBi	Linear, Vertical	Base Dia. - 275 Height - 187 mm	DAS Single Pol	<b>07-3</b>
<b>MA-CQ29-1X</b>	380 MHz -6 GHz Multi Band Omni	380-806 MHz 806-960 MHz 1700-2500 MHz 2500-2700 MHz 3300-3700 MHz 4900-6000 MHz	1 (2*) dBi 4 dBi 5 dBi 5 dBi 6 dBi 6 dBi	Linear, Vertical	Base Dia. - 275 Height - 187 mm	DAS Single Pol	<b>07-4</b>
<b>MA-WA43-1X</b>	In-Building Panel	425-445 MHz	4 dBi	Linear, Vertical	225 x 215 x 29 mm	DAS Single Pol	01-22
<b>MA-WA46-1X</b>	In-Building Panel	450-470 MHz	4 dBi	Linear, Vertical	231 x 215 x 29 mm	DAS Single Pol	01-23
<b>MA-WOLTE-3X</b>	<b>LTE, GSM, UMTS, WLAN, Wi-Fi</b> Multi Band Omni	698-806 MHz 806-960 MHz 1710-2170 MHz 2300-2700 MHz 3300-3800 MHz 4900-6500 MHz	2 dBi 2 dBi 3-4 dBi 5 dBi 4 dBi 6 dBi	Linear, Vertical	Base Dia. - 205 Height - 89 mm	DAS Single Pol	<b>07-6</b>
<b>MA-WOLTE-3M1</b>	<b>698-6500 MHz Multi Band Tri-Ports Omni</b>	<b>Port 1 &amp; 2</b> 698-960 MHz 1710-2170 MHz 2.3-2.7 GHz. 3.3-3.8 GHz 4.9- 6.5 GHz <b>Port 3</b> 1710-2170 MHz 2.3-2.7 GHz 3.3-3.8 GHz 4.9- 6.5 GHz	2 dBi 3-4 dBi 5 dBi 4 dBi 6 dBi 3 dBi 3 dBi 4 dBi 6 dBi	Linear, Vertical	Antenna dimension (D,H): 220 x 95 mm  Base dimension (L,W,H): 369 x 270 x 30 mm	DAS Single Pol	<b>07-7</b>
<b>MA-CLTE-14</b>	<b>LTE, GSM, UMTS, WLAN, Wi-Fi</b> Multi Band Panel	698-806 MHz 806-960 MHz 1710-2170 MHz 2200-2700 MHz	5 dBi 6 dBi 6.5 dBi 5 dBi	Mixed, Vertical and Horizontal	231 x 215 x 37.5 mm	DAS Single Pol	01-24

MARS Antennas & RF Systems proprietary information

MARS reserves the right to make technical changes or modifications to any of its products and specifications without prior notice and without implementing such changes to prior supplied products. Product images are representative and indicative only. Warranty terms and general conditions of sale are applicable on any purchase of any product, available on MARS website.

3 Hamanor st. Holon 5886103, P.O.Box 1852 Holon 5811801, Israel

Tel: +972-3-5599661 • Fax: +972-3-5599677 • e-mail: mars@marsant.co.il • web: www.mars-antennas.com

Part Number	Description	Frequency band	Gain	Polarization	Dimension	Antenna type	Page
<b>MA-CR26-2X</b>	Multi Band Omni	806-960 MHz 1710-2170 MHz 2300-2700 MHz 3400-3700 MHz 4900-6000 MHz	2 dBi 3-4 dBi 5 dBi 5 dBi 5-6 dBi	Linear, Vertical	Base Dia. - 205 Height - 89 mm	DAS Single Pol	<b>07-12</b>
<b>MA-CM36-15</b>	Multi Band Omni	806-960 MHz 1710-2170 MHz 2300-2700 MHz	2 dBi 3-4 dBi 5 dBi	Linear, Vertical	Base Dia. - 205 Height - 89 mm	DAS Single Pol	<b>07-13</b>
<b>MA-CL67-15</b>	<b>GSM, UMTS, WLAN</b> Multi Band Panel	806-960 MHz 1710-2170 MHz 2200-2700 MHz	8.5 dBi 7.5-10 dBi 5-6.5 dBi	Linear, Vertical	231 x 215 x 37.5 mm	DAS Single Pol	01-25
<b>MA-CN14-11</b>	Multi Band 140°	806-960 MHz 1710-2170 MHz	5 dBi	Linear, Vertical	175 x 35 x 125 mm	DAS Single Pol	01-26
<b>MA-WO850-5</b>	Omni-Directional	830-870 MHz	5 dBi	Linear, Vertical	Base Dia. - 40 Height - 700 mm	DAS Single Pol	<b>07-14</b>
<b>MA-CC60-60</b>	Dual Beam GSM	870-960 MHz 2.4-2.5 GHz	3.5 dBi 4.5 dBi	Linear, Vertical	184 x 100 x 125 mm	DAS Single Pol	01-27
<b>MA-WOLTE-DP1</b>	<b>698-6500 MHz Multi Band Dual Polarized Omni</b>	<u>Vertical</u> 698-960 MHz 1710-2170 MHz 2.3-2.7 GHz 3.3-3.8 GHz 4.9- 6.5 GHz <u>Horizontal</u> 2.3-2.7 GHz 4.9- 5.875 GHz	4 dBi 5 dBi 5.5 dBi 7 dBi 7.5 dBi 5 dBi 5 dBi	Linear, Vertical	Base Diameter 275 mm  Height 190 mm	DAS Dual Pol	<b>07-8</b>
<b>MA-WOLTE-DP2</b>	698-6500 MHz Multi Band Tri-Ports Omni	<u>Port 1</u> 1.7-2.7 GHz <u>Port 2</u> 4.4-6.6 GHz <u>Port 3</u> 698-960 MHz 1.7-2.3 GHz 2.3-2.7 GHz. 3.3-3.8 GHz 4.5- 6.6 GHz	5 dBi 6 dBi 4 dBi 3-4 dBi 5.5 dBi 4 dBi 6 dBi	Linear, Horizontal  Linear, Horizontal  Linear, Vertical	Antenna dimension (D,H): 220 x 95 mm  (Stand out from the ceiling)	DAS Dual Pol	<b>07-9</b>
<b>MA-WO8622-DB2</b>	Dual Pole OMNI Directional	790-960 MHz 1695-2700 MHz	2 dBi 2.5-5.8 dBi	Linear, Vertical	192 x 30 Dia mm	DAS Dual Pol	<b>07-11</b>

MARS Antennas & RF Systems proprietary information

MARS reserves the right to make technical changes or modifications to any of its products and specifications without prior notice and without implementing such changes to prior supplied products. Product images are representative and indicative only. Warranty terms and general conditions of sale are applicable on any purchase of any product, available on MARS website.

3 Hamanor st. Holon 5886103, P.O.Box 1852 Holon 5811801, Israel

Tel: +972-3-5599661 • Fax: +972-3-5599677 • e-mail: mars@marsant.co.il • web: www.mars-antennas.com

## MA-WA640-6

### 490-860 MHz Subscriber Antenna

MARS Broadband Panel Antenna covers LTE 700 & 800 MHz to support public safety and first responder.

The antenna can be easily used either for Indoor or Outdoor Applications and features different mounting options.

Additional Features:

- Excellent and stable performance.
- UV protected antenna radome.
- Suitable for both Indoor and Outdoor installations.
- DC grounded.



### Specifications

#### Electrical

Frequency range	490-860 MHz
Gain typ.	6 dBi
VSWR	2 : 1 typ (2.5 : 1 max)
Polarization	Linear, Vertical or Horizontal
3dB Beam-Width, H-Plane, typ.	90°
3dB Beam-Width, E-Plane, typ.	45°
Front to Back Ratio, typ.	-15 dB
Input power, max.	50 Watt
Input Impedance	50 Ohm
Lightning Protection	DC Grounded

#### Mechanical

Dimensions (HxWxD)	500 x 345 x 140 mm
Connector	N-Type, Female
Weight	1.5 Kg
Mounting	See Ordering Options
Radome	UV Protected Plastic
Back Plane	Aluminum protected through chemical passivation.

#### Environmental

Operating Temperature Range	-40°C to +65°C
Vibration	According to IEC 60721-3-4
Wind Load	200 Km/h (Survival)
Flammability	UL94
Water Proofing	IP65
Humidity	ETS 300 019-1-4, EN 302 085 (Annex A.1.1)
Salt Fog	According to IEC 68-2-11

### Ordering Options

MA-WA640-6	Antenna Suited for MNT-22
MA-WA640-6B	Antenna with MNT-22 mount

MARS Antennas & RF Systems proprietary information

MARS reserves the right to make technical changes or modifications to any of its products and specifications without prior notice and without implementing such changes to prior supplied products. Product images are representative and indicative only. Warranty terms and general conditions of sale are applicable on any purchase of any product, available on MARS website.

3 Hamanor st. Holon 5886103, P.O.Box 1852 Holon 5811801, Israel

Tel: +972-3-5599661 • Fax: +972-3-5599677 • e-mail: mars@marsant.co.il • web: www.mars-antennas.com

## MA-WA79-UX

### 700 MHz Upper Band Subscriber Antenna

MARS 700 MHz - Upper Band Antenna provides solutions for new services such as LTE, mobile broadband, mobile video and WiMAX, as well as Public Safety applications.

Additional Features:

- Excellent performance.
- Aesthetic and unobtrusive.
- Thin radome and easy mounting.



### Specifications

#### Electrical

Frequency range	746-806 MHz
GAIN, min.	8.5 dBi
VSWR, max.	1.5 : 1
Polarization	Linear, Horizontal or Vertical
3 dB Beam-Width, H-Plane, typ.	60°
3 dB Beam-Width, E-Plane, typ.	60°
Side Lobes, min.	-30 dB
Cross Polarization, min.	-15 dB
Front to Back Ratio, min.	-20 dB
Input power, max.	10 Watt
Input Impedance	50 Ohm
Lightning Protection	DC Grounded

#### Mechanical

Dimensions (HxWxD)	305 x 305 x 25 mm (12" x 12" x 1")
Weight	1.3 kg.
Connector	N-Type
Back Plane	Aluminum; protected through chemical passivation
Radome	UV Protected Polycarbonate
Mount	See Ordering Options

#### Environmental

Operating Temperature Range	-40°C to +65°C
Vibration	According to IEC 60721-3-4
Wind Load	200 km/h (survival)
Flammability	UL94
Water Proofing	IP-65
Humidity	ETS 300 019-1-4, EN 302 085 (annex A.1.1)
Salt Fog	According to IEC 68-2-11
Ice and Snow	25mm radial (survival)

### Ordering Options

MA-WA79-UX PM	Antenna with integral Pole Mount includes stainless steel brackets
MA-WA79-UX MNT	Antenna Suited for MNT-22 (optional wall/pole adjustable mount)
MA-WA79-UX MNTB	Antenna with MNT-22 mount

Patterns are available on our website

MARS Antennas & RF Systems proprietary information

MARS reserves the right to make technical changes or modifications to any of its products and specifications without prior notice and without implementing such changes to prior supplied products. Product images are representative and indicative only. Warranty terms and general conditions of sale are applicable on any purchase of any product, available on MARS website.

3 Hamanor st. Holon 5886103, P.O.Box 1852 Holon 5811801, Israel

Tel: +972-3-5599661 • Fax: +972-3-5599677 • e-mail: mars@marsant.co.il • web: www.mars-antennas.com

## MA-IS91-T2

### 915 MHz Subscriber Antenna

MARS 915 MHz Antenna is designed for Point-to-Multipoint systems using the ISM 915 MHz band.

Additional features:

- High efficiency.
- Superb co-sitting performance due to high crosspol rejection.
- Unobtrusive, blends easily with the environment.
- Optionally available with Pole Mount or MNT-22 (pole/wall, azimuth and elevation adjustable mount).



### Specifications

#### Electrical

Frequency range	902-928 MHz
GAIN, min.	10.5 dBi
VSWR, max.	1.5 : 1
Polarization	Linear, Vertical (Horizontal with MNT-22 Option)
3 dB Beam-Width, H-Plane, typ.	55°
3 dB Beam-Width, E-Plane, typ.	60°
Side Lobes, min.	-20 dB
Cross Polarization, min.	-17 dB
Front to Back Ratio, min.	-27 dB
Input power, max	10 Watt
Input Impedance	50 Ohm
Lightning Protection	DC Grounded

#### Mechanical

Dimensions (HxWxD)	305 x 305 x 25 mm (12" x 12" x 1")
Weight	1.3 kg.
Connector	N-Type, Female
Back Plane	Aluminum; protected through chemical passivation
Radome	UV Protected Polycarbonate
Mount	See Ordering Options

#### Environmental

Operating Temperature Range	-40°C to +65°C
Vibration	According to IEC 60721-3-4
Wind Load	200 km/h (survival)
Flammability	UL94
Water Proofing	IP-67
Humidity	ETS 300 019-1-4, EN 302 085 (annex A.1.1)
Salt Fog	According to IEC 68-2-11
Ice and Snow	25mm radial (survival)

### Ordering Options

MA-IS91-T2 PM	Antenna with integral Pole Mount includes stainless steel brackets
MA-IS91-T2 MNT	Antenna Suited for MNT-22 (optional wall/pole adjustable mount)
MA-IS91-T2 MNTB	Antenna with MNT-22 mount
MA-IS91-T2C (*)	Antenna Suited for MNT-22 (optional wall/pole adjustable mount)
MA-IS91-T2CB (*)	Antenna with MNT-22 mount

(\*) Approved by MOTOROLA for CANOPY 915 MHz System

Patterns are available on our website

MARS Antennas & RF Systems proprietary information

MARS reserves the right to make technical changes or modifications to any of its products and specifications without prior notice and without implementing such changes to prior supplied products. Product images are representative and indicative only. Warranty terms and general conditions of sale are applicable on any purchase of any product, available on MARS website.

3 Hamanor st. Holon 5886103, P.O.Box 1852 Holon 5811801, Israel

Tel: +972-3-5599661 • Fax: +972-3-5599677 • e-mail: mars@marsant.co.il • web: www.mars-antennas.com



## MA-IS91-T3

### 915 MHz Subscriber Antenna

MARS 915 MHz small size panel antenna provides for coverage of the ISM 915 band under FCC part 15.

Additional Features:

- High gain/size ratio.
- Small and unobtrusive.
- New aesthetic and durable radome.
- Suitable for indoor and outdoor applications.



### Specifications

#### Electrical

Frequency range	902-928 MHz
GAIN, min.	8 dBi
VSWR, max.	1.5 : 1
Polarization	Linear, Vertical (Horizontal with MNT-22 Option)
3 dB Beam-Width, H-Plane, typ.	70°
3 dB Beam-Width, E-Plane, typ.	65°
Cross Polarization, min.	-17 dB
Front to Back Ratio, min.	-16 dB
Input power, max.	10 Watt
Input Impedance	50 Ohm
Lightning Protection	DC Grounded

#### Mechanical

Dimensions (HxWxD)	230 x 214 x 31 mm ( 9.1" x 8.4" x 1.2")
Weight	520 gr.
Connector	N-Type, Female ( at the back plane)
Back Plane	Aluminum; protected through chemical passivation
Radome	UV Protected Polycarbonate
Mount	See Ordering Options

#### Environmental

Operating Temperature Range	-40°C to +65°C
Vibration	According to IEC 60721-3-4
Wind Load	200 km/h (survival)
Flammability	UL94
Water Proofing	IP-65
Humidity	ETS 300 019-1-4, EN 302 085 (annex A.1.1)
Salt Fog	According to IEC 68-2-11
Ice and Snow	25mm radial (survival)

### Ordering Options

MA-IS91-T3 PM	Antenna with integral Pole Mount includes stainless steel brackets
MA-IS91-T3 MNT	Antenna Suited for MNT-22 (optional wall/pole adjustable mount)
MA-IS91-T3 MNTB	Antenna with MNT-22 mount

Patterns are available on our website

MARS Antennas & RF Systems proprietary information

MARS reserves the right to make technical changes or modifications to any of its products and specifications without prior notice and without implementing such changes to prior supplied products. Product images are representative and indicative only. Warranty terms and general conditions of sale are applicable on any purchase of any product, available on MARS website.

3 Hamanor st. Holon 5886103, P.O.Box 1852 Holon 5811801, Israel

Tel: +972-3-5599661 • Fax: +972-3-5599677 • e-mail: mars@marsant.co.il • web: www.mars-antennas.com

## MA-IS91-R1

### 915 MHz RFID Reader Antenna

MARS 915 MHz Antenna is designed for Point-to-Multipoint systems using the ISM 915 MHz band.

Additional features:

- High efficiency.
- Superb co-siting performance due to low SSL and high F/B rejection.
- Unobtrusive, blends easily with the environment.
- Optionally available with Pole Mount or MNT-22 (pole/wall, azimuth and elevation adjustable mount).



### Specifications

#### Electrical

Frequency range	902-928 MHz
GAIN, typ.	10 dBi
VSWR, max.	1.5 : 1
Polarization	RHCP
3 dB Beam-Width, Horizontal, typ.	75°
3 dB Beam-Width, Vertical, typ.	55°
Front to Back Ratio, typ.	-20 dB
Input power, max.	10 Watt
Input Impedance	50 Ohm
Lightning Protection	DC Grounded

#### Mechanical

Dimensions (HxWxD)	305 x 305 x 25 mm (12" x 12" x 1")
Weight	1.2 kg.
Connector	N-Type, Female
Back Plane	Aluminum; protected through chemical passivation
Radome	UV Protected Polycarbonate
Mount	See Ordering Options

#### Environmental

Operating Temperature Range	-40°C to +65°C
Vibration	According to IEC 60721-3-4
Wind Load	200 km/h (survival)
Flammability	UL94
Water Proofing	IP-67
Humidity	ETS 300 019-1-4, EN 302 085 (annex A.1.1)
Salt Fog	According to IEC 68-2-11
Ice and Snow	25mm radial (survival)

### Ordering Options

MA-IS91-R1 PM	Antenna with integral Pole Mount includes stainless steel brackets
MA-IS91-R1 MNT	Antenna Suited for MNT-22 (optional wall/pole adjustable mount)
MA-IS91-R1 MNTB	Antenna with MNT-22 mount

Patterns are available on our website

MARS Antennas & RF Systems proprietary information

MARS reserves the right to make technical changes or modifications to any of its products and specifications without prior notice and without implementing such changes to prior supplied products. Product images are representative and indicative only. Warranty terms and general conditions of sale are applicable on any purchase of any product, available on MARS website.

3 Hamanor st. Holon 5886103, P.O.Box 1852 Holon 5811801, Israel

Tel: +972-3-5599661 • Fax: +972-3-5599677 • e-mail: mars@marsant.co.il • web: www.mars-antennas.com

## MA-WA820-DP8

### 698 – 960 MHz Dual-Pol Directional Antenna

MARS Dual Polarized Directional Antenna covers LTE bands 5, 6, 8, 12-14, 17-20, 26-29 & 44, GSM 900 and more.

The antenna is aesthetic and has an obtrusive profile that blends easily with any environment.

The antenna is easy-installed and is highly recommended as an outstanding logistic solution for Outdoor installations as well as In-Building Installations.



## Specifications

### Electrical

Frequency range	698 – 960 MHz
Gain, typ.	8 dBi
VSWR	typ. 1.5 : 1 max. 2.0 : 1
Polarization	Dual Pol Vertical & Horizontal
3dB Beam-Width, Azimuth, typ.	65°
3dB Beam-Width, Elevation, typ.	65°
Port to Port Isolation, min.	-25 dB
Front to Back Ratio, min	-15 dB
PIM, typ.	-140 dBc
Input power, max.	50 Watt
Impedance	50 Ohm

### Mechanical

Dimensions (HxWxD)	310 x 310 x 126 mm (12.2" x 12.2" x 4.96")
Connector	2 x N-type Female
Weight	~1.3 kg
Mounting	See Ordering Options
Radome	UV Protected Plastic
Back Plane	Aluminum protected through chemical passivation.

### Environmental

Operating Temperature Range	-55°C to +65°C
Vibration	According to IEC 60721-3-4
Wind Load	200 Km/h (Survival)
Flammability	UL94
Water Proofing	IP-67
Humidity	ETS 300 019-1-4, EN 302 085 (Annex A.1.1)
Salt Fog	According to IEC 68-2-11

## Ordering Options

MA-WA820-DP8	Antenna 2 x N-Type Female connectors Suited for MNT-22 mount
MA-WA820-DP8B	Antenna 2 x N-Type Female connectors with MNT-22 mount

MARS Antennas & RF Systems proprietary information

MARS reserves the right to make technical changes or modifications to any of its products and specifications without prior notice and without implementing such changes to prior supplied products. Product images are representative and indicative only. Warranty terms and general conditions of sale are applicable on any purchase of any product, available on MARS website.

3 Hamanor st. Holon 5886103, P.O.Box 1852 Holon 5811801, Israel

Tel: +972-3-5599661 • Fax: +972-3-5599677 • e-mail: mars@marsant.co.il • web: www.mars-antennas.com

## MA-WA6960-DS7

### 698 – 960 MHz & 1700 – 2700 MHz & 5150-6000 MHz Multi Band Dual Slant Directional Antenna

MARS Multiband Dual Slant Antenna MA-WA6960-DS7 covers all the bands for 2G, 2.5G, 3G cellular and LTE, as well as ISM, Wi-Fi, WLAN, Bluetooth, GSM 900 and GSM 1900.

MARS MA-WA6960-DS7 is compact size and features unobtrusive aesthetic profile that blends easily with any environment.

The antenna is easy-installed and highly recommended as an outstanding logistic solution for Outdoor as well as In-Building Installations.



## Specifications

### Electrical

Frequency range	698 – 960 MHz	1700 – 2700 MHz	5.15-6.0 MHz
Gain, typ.	7.5 dBi	6 - 7 dBi	6 dBi
VSWR	typ.	1.5 : 1	1.5 : 1
	max.	2.8 : 1	2.2 : 1
Polarization	Dual Slant ± 45°		
Port to Port Isolation, min.	-25 dB	-40 dB	-50 dB
3dB Beam-Width, Azimuth, typ.	70°	80° -120°	40°
3dB Beam-Width, Elevation, typ.	70°	80° -120°	40°
Front to Back Ratio, min	-15 dB		
PIM, typ.	-150 dBc		
Input power, max.	50 Watt		
Impedance	50 Ohm		
Lightning Protection	DC Grounded		

### Mechanical

Dimensions (HxWxD)	300 x 300 x 99 mm (12.2" x 12.2" x 4.96" )
Connector	2 x N-type Female
Weight	900 gr.
Mounting	See Ordering Options
Radome	UV Protected Plastic
Back Plane	Aluminum protected through chemical passivation.

### Environmental

Operating Temperature Range	-55°C to +65°C
Vibration	According to IEC 60721-3-4
Wind Load	200 Km/h (Survival)
Flammability	UL94
Water Proofing	IP-67
Humidity	ETS 300 019-1-4, EN 302 085 (Annex A.1.1)
Salt Fog	According to IEC 68-2-11

## Ordering Options

MA-WA6960-DS7	Antenna Suited for MNT-22
MA-WA6960-DS7B	Antenna with MNT-22 mount

MARS Antennas & RF Systems proprietary information

MARS reserves the right to make technical changes or modifications to any of its products and specifications without prior notice and without implementing such changes to prior supplied products. Product images are representative and indicative only. Warranty terms and general conditions of sale are applicable on any purchase of any product, available on MARS website.

3 Hamanor st. Holon 5886103, P.O.Box 1852 Holon 5811801, Israel

Tel: +972-3-5599661 • Fax: +972-3-5599677 • e-mail: mars@marsant.co.il • web: www.mars-antennas.com

## MA-IS91-DS10

### 902-928 MHz Subscriber Antenna

MARS 915 MHz Antenna is designed for Point-to-Multipoint systems using the ISM 915 MHz band.

Additional features:

- High efficiency.
- Superb co-siting performance due to high cross pol rejection.
- Unobtrusive, blends easily with the environment.
- Optionally available with Pole Mount or MNT-22 (pole/wall, azimuth and elevation adjustable mount).



## Specifications

<i>Electrical</i>	
Frequency range	902-928 MHz
Gain	10.5 ± 0.5 dBi
VSWR, max.	1.7: 1
Polarization	Dual Slant ±45°
3dB Beam-Width, H-Plane, typ.	46°
3dB Beam-Width, E-Plane, typ.	46°
Side Lobes, min.	-16 dB
Port to Port Isolation, typ.	-30 dB
Front to Back Ratio, min.	-16 dB
Input power, max.	20 Watt
Input Impedance	50 Ohm
Lightning Protection	DC Grounded
<i>Mechanical</i>	
Dimensions (HxWxD)	370 x 370 x 40 mm ( 14.5" x 14.5" x 1.6")
Connector	2 x N-Type
Weight	2 kg.
Mounting	MNT-22
Radome	UV Protected Polycarbonate
Back Plane	Aluminum protected through chemical passivation.
<i>Environmental</i>	
Operating Temperature Range	-55°C to +65°C
Vibration	According to IEC 60721-3-4
Wind Load	200 Km/h (Survival)
Flammability	UL94
Water Proofing	IP-67
Humidity	ETS 300 019-1-4, EN 302 085 (Annex A.1.1)
Salt Fog	According to IEC 68-2-11

## Ordering Options

MA-IS91-DS10	Antenna Suited for MNT-22
MA-IS91-DS10B	Antenna with MNT-22 mount

MARS Antennas & RF Systems proprietary information

MARS reserves the right to make technical changes or modifications to any of its products and specifications without prior notice and without implementing such changes to prior supplied products. Product images are representative and indicative only. Warranty terms and general conditions of sale are applicable on any purchase of any product, available on MARS website.

3 Hamanor st. Holon 5886103, P.O.Box 1852 Holon 5811801, Israel

Tel: +972-3-5599661 • Fax: +972-3-5599677 • e-mail: mars@marsant.co.il • web: www.mars-antennas.com

## MA-IS43-B2

### 433 MHz Base Station Panel Antenna

MARS 433 MHz Panel Antenna provides a cost effective solution for Point-to-Multipoint Systems based on the ISM 433 MHz.

Additional Features:

- Suited for new RFID technology applications.
- Excellent and stable performance.
- Small and aesthetic profile.
- UV protected antenna radome.
- Suitable for both indoor and outdoor installations.
- DC grounded.
- Wall mount.



### Specifications

#### Electrical

Frequency range	433±2 MHz
GAIN, min.	4 dBi
VSWR, max.	1.5 : 1
Polarization	Linear, Vertical
3 dB Beam-Width, H-Plane, typ.	95°
3 dB Beam-Width, E-Plane, typ.	100°
Side Lobes, min.	No Side Lobes
Cross Polarization, min.	No Cross Polarization
Front to Back Ratio, min.	No Front to Back Ratio
Input power, max.	25 Watt
Input Impedance	50 Ohm
Lightning Protection	DC Grounded

#### Mechanical

Dimensions (HxWxD)	231 x 215 x 31 mm (9.1" x 8.5" x 1.2")
Weight	840 gr.
Connector	N-Type, Female
Back Plane	Aluminum protected through chemical passivation
Radome	UV Protected Polycarbonate
Mount	Indoor Usage (Outdoor Version Available on Request)

#### Environmental

Operating Temperature Range	-40°C to +65°C
Vibration	According to IEC 60721-3-4
Wind Load	200 km/h (survival)
Flammability	UL94
Water Proofing	IP-65
Humidity	ETS 300 019-1-4, EN 302 085 (annex A.1.1)
Salt Fog	According to IEC 68-2-11
Ice and Snow	25mm radial (survival)

### Ordering Options

MA-IS43-B2	N-Type Connector Version
MA-IS43-B21	N-Type + Cable RG58, ~25cm

Patterns are available on our website

MARS Antennas & RF Systems proprietary information

MARS reserves the right to make technical changes or modifications to any of its products and specifications without prior notice and without implementing such changes to prior supplied products. Product images are representative and indicative only. Warranty terms and general conditions of sale are applicable on any purchase of any product, available on MARS website.

3 Hamanor st. Holon 5886103, P.O.Box 1852 Holon 5811801, Israel

Tel: +972-3-5599661 • Fax: +972-3-5599677 • e-mail: mars@marsant.co.il • web: www.mars-antennas.com

## MA-WD866-BD7

### 865-867 MHz Bidirectional sector Antenna

MARS Bidirectional Antenna is ideal for deployment in tunnels, Highways or long building corridors. It features small and unobtrusive profile that blends easily with any environment.

Applicable Applications:

- Tunnel coverage.
- Indoor cell extender.
- Highways Application



## Specifications

### Electrical

Frequency range	865-867 MHz
Gain	7 dBi
3 dB Beam-Width, Azimuth, typ.	2 x 75°
3 dB Beam-Width, Elevation, typ.	30°
VSWR, max.	1.5 :1
Angle between 2 beams	180°
Polarization	Linear, Horizontal
Input power, max	10 Watt
Input Impedance	50 Ohm

### Mechanical

Dimensions (HxWxD)	615 x 105 x 130 mm.
Weight	1 kg.
Connector	N-Type Female
Back Plane	Aluminum, Conversion Coated
Radome	ABS, UV Protected
Mount	See Ordering Options

### Environmental

Operating Temperature Range	-30°C to +70°C
Vibration	According to IEC 60721-3-4
Wind Load	200 Km/h (Survival)
Flammability	UL94
Water Proofing	IP-65
Humidity	ETS 300 019-1-4, EN 302 085 (annex A.1.1)
Salt Fog	According to IEC 68-2-11

## Ordering Options

MA-WD866-BD7B	Antenna with MNT-22 mount
---------------	---------------------------

MARS Antennas & RF Systems proprietary information

MARS reserves the right to make technical changes or modifications to any of its products and specifications without prior notice and without implementing such changes to prior supplied products. Product images are representative and indicative only. Warranty terms and general conditions of sale are applicable on any purchase of any product, available on MARS website.

3 Hamanor st. Holon 5886103, P.O.Box 1852 Holon 5811801, Israel

Tel: +972-3-5599661 • Fax: +972-3-5599677 • e-mail: mars@marsant.co.il • web: www.mars-antennas.com

## MA-WC90-5X

### 915 MHz Base Station Antenna, 60°

MARS 915 MHz Base Station Antenna provides a robust and efficient solution for the Point-to-Multipoint systems based on the ISM 915 MHz band.

Additional Features:

- 60° azimuthally coverage.
- Suitable for harsh environment installations.
- DC grounded.
- Easy mounting allowing obtaining required down tilt degree with the optional MNT-25 mount.



### Specifications

#### Electrical

Frequency range	902-928 MHz
GAIN, min.	14.5 dBi
VSWR, max.	1.7 : 1
Polarization	Vertical
3 dB Beam-Width, Horizontal Plane, typ.	60°
3 dB Beam-Width, Elevation Plane, typ.	15°
Side Lobes, min.	-14 dB
Cross Polarization, min.	-23 dB
Front to Back Ratio, min.	-23 dB
Input power, max	50 Watt
Input Impedance	50 Ohm
Lightning Protection	DC Grounded

#### Mechanical

Dimensions (HxWxD)	1200 x 330 x 105 mm (47.2" x 13" x 4.1")
Weight	4.5 kg.
Connector	N-Type, Female
Back Plane	Aluminum; protected through chemical passivation
Radome	UV Protected Plastic
Mount	See ordering options

#### Environmental

Operating Temperature Range	-40°C to +65°C
Vibration	According to IEC 60721-3-4
Wind Load	200 km/h (survival)
Flammability	UL94
Water Proofing	IP-65
Humidity	ETS 300 019-1-4, EN 302 085 (annex A.1.1)
Salt Fog	According to IEC 68-2-11
Ice and Snow	25mm radial (survival)

### Ordering Options

MA-WC90-5X	Antenna Suited for MNT-25 (optional tilt mount)
MA-WC90-5XB	Antenna with MNT-25 mount

Patterns are available on our website

MARS Antennas & RF Systems proprietary information

MARS reserves the right to make technical changes or modifications to any of its products and specifications without prior notice and without implementing such changes to prior supplied products. Product images are representative and indicative only. Warranty terms and general conditions of sale are applicable on any purchase of any product, available on MARS website.

3 Hamanor st. Holon 5886103, P.O.Box 1852 Holon 5811801, Israel

Tel: +972-3-5599661 • Fax: +972-3-5599677 • e-mail: mars@marsant.co.il • web: www.mars-antennas.com



## MA-WD90-6X

### 915 MHz Base Station Antenna, 90°

MARS 915 MHz Base Station Antenna provides a robust and efficient solution for the Point-to-Multi-point systems based on the ISM 915 MHz band.

Additional Features:

- 90° azimuthal coverage.
- Suitable for harsh environment installations.
- DC grounded.
- Easy mounting allowing obtaining required down tilt degree with the optional MNT-25 mount.



### Specifications

#### Electrical

Frequency range	902-928 MHz
GAIN, min.	13 dBi
VSWR, max.	1.7 : 1
Polarization	Linear, Vertical
3 dB Beam-Width, Horizontal Plane, typ.	90°
3 dB Beam-Width, Elevation Plane, typ.	15°
Side Lobes, min.	-11 dB
Cross Polarization, min.	-13 dB
Front to Back Ratio, min.	-23 dB
Input power, max.	50 Watt
Input Impedance	50 Ohm
Lightning Protection	DC Grounded

#### Mechanical

Dimensions (HxWxD)	1200 x 330 x 105 mm (47.2" x 13" x 4.1")
Weight	4.5 kg.
Connector	N-Type, Female
Back Plane	Aluminum; protected through chemical passivation
Radome	UV Protected Plastic
Mount	See ordering options

#### Environmental

Operating Temperature Range	-40°C to +65°C
Vibration	According to IEC 60721-3-4
Wind Load	200 km/h (survival)
Flammability	UL94
Water Proofing	IP-65
Humidity	ETS 300 019-1-4, EN 302 085 (annex A.1.1)
Salt Fog	According to IEC 68-2-11
Ice and Snow	25mm radial (survival)

### Ordering Options

MA-WD90-6X	Antenna Suited for MNT-25 (optional tilt mount)
MA-WD90-6XB	Antenna with MNT-25 mount

Patterns are available on our website

MARS Antennas & RF Systems proprietary information

MARS reserves the right to make technical changes or modifications to any of its products and specifications without prior notice and without implementing such changes to prior supplied products. Product images are representative and indicative only. Warranty terms and general conditions of sale are applicable on any purchase of any product, available on MARS website.

3 Hamanor st. Holon 5886103, P.O.Box 1852 Holon 5811801, Israel

Tel: +972-3-5599661 • Fax: +972-3-5599677 • e-mail: mars@marsant.co.il • web: www.mars-antennas.com

## MA-WE90-7X

### 915 MHz Base Station Antenna, 120°

MARS 915 MHz Base Station Antenna provides a robust and efficient solution for the Point-to-Multipoint systems based on the ISM 915 MHz band.

Additional Features:

- 120° azimuthal coverage.
- Suitable for harsh environment installations.
- DC grounded.
- Easy mounting allows to obtain required down tilt degree with the optional MNT-25 mount.



### Specifications

#### Electrical

Frequency range	902-928 MHz
GAIN, min.	11.5 dBi
VSWR, max.	1.7 : 1
Polarization	Linear, Vertical
3 dB Beam-Width, Horizontal Plane, typ.	120°
3 dB Beam-Width, Elevation Plane, typ.	15°
Side Lobes, min.	-11 dB
Cross Polarization, min.	-15 dB
Front to Back Ratio, min.	-18 dB
Input power, max.	50 Watt
Input Impedance	50 Ohm
Lightning Protection	DC Grounded

#### Mechanical

Dimensions (HxWxD)	1208 x 328 x 183 mm (47.56" x 12.91" x 7.20")
Weight	4.5 kg.
Connector	N-Type, Female
Back Plane	Aluminum; protected through chemical passivation
Radome	UV Protected, Plastic
Mount	See ordering options

#### Environmental

Operating Temperature Range	-40°C to +65°C
Vibration	According to IEC 60721-3-4
Wind Load	200 km/h (survival)
Flammability	UL94
Water Proofing	IP-65
Humidity	ETS 300 019-1-4, EN 302 085 (annex A.1.1)
Salt Fog	According to IEC 68-2-11
Ice and Snow	25mm radial (survival)

### Ordering Options

MA-WE90-7X	Antenna Suited for MNT-25 (optional tilt mount)
MA-WE90-7XB	Antenna with MNT-25 mount

Patterns are available on our website

MARS Antennas & RF Systems proprietary information

MARS reserves the right to make technical changes or modifications to any of its products and specifications without prior notice and without implementing such changes to prior supplied products. Product images are representative and indicative only. Warranty terms and general conditions of sale are applicable on any purchase of any product, available on MARS website.

3 Hamanor st. Holon 5886103, P.O.Box 1852 Holon 5811801, Israel

Tel: +972-3-5599661 • Fax: +972-3-5599677 • e-mail: mars@marsant.co.il • web: www.mars-antennas.com

## MA-WC91-5H

### 915 MHz Horizontally Polarized Sector Antenna, 60°

MARS 60° Horizontally Polarized Sector Antenna provides a robust and efficient solution for Point-to-Multi-Point applications using 915 MHz band, in spectrally crowded areas in this band.

Antenna Features:

- Stable and reliable performance for high interference environments.
- Features horizontal polarization with 14 dBi of gain.
- Light-weight and durable construction.
- Suitable for harsh environment installations.
- DC grounded.
- Easy mounting allowing obtaining required down tilt degree with the optional MNT-25 mount.



### Specifications

#### Electrical

Frequency range	902-928 MHz
GAIN, min.	14 dBi
VSWR, max.	1.7 : 1
Polarization	Horizontal
3 dB Beam-Width, Horizontal Plane, typ.	60°
3 dB Beam-Width, Elevation Plane, typ.	15°
Input power, max.	10 Watt
Input Impedance	50 Ohm
Lightning Protection	DC Grounded

#### Mechanical

Dimensions (HxWxD)	1200 x 330 x 105 mm (47.2" x 13" x 4.1")
Weight	4 kg.
Connector	N-Type, Female
Back Plane	Aluminum protected through chemical passivation
Radome	UV Protected Plastic
Mount	MNT-25

#### Environmental

Operating Temperature Range	-40°C to +70°C
Vibration	According to IEC 60721-3-4
Wind Load	200 km/h (survival)
Flammability	UL94
Water Proofing	IP-65
Humidity	ETS 300 019-1-4, EN 302 085 (annex A.1.1)
Salt Fog	According to IEC 68-2-11
Ice and Snow	25mm radial (survival)

### Ordering Options

MA-WC91-5H	Antenna Suited for MNT-25 (optional tilt mount)
MA-WC91-5HB	Antenna with MNT-25 mount

Patterns are available on our website

MARS Antennas & RF Systems proprietary information

MARS reserves the right to make technical changes or modifications to any of its products and specifications without prior notice and without implementing such changes to prior supplied products. Product images are representative and indicative only. Warranty terms and general conditions of sale are applicable on any purchase of any product, available on MARS website.

3 Hamanor st. Holon 5886103, P.O.Box 1852 Holon 5811801, Israel

Tel: +972-3-5599661 • Fax: +972-3-5599677 • e-mail: mars@marsant.co.il • web: www.mars-antennas.com

## MA-WD91-6H

### 915 MHz Horizontally Polarized Sector Antenna, 90°

MARS 90° Horizontally Polarized Sector Antenna provides a robust and efficient solution for Point-to-Multi-Point applications using 915 MHz band, in spectrally crowded areas in this band.

Antenna Features:

- Stable and reliable performance for high interference environments.
- Features horizontal polarization with 12 dBi of gain.
- Light-weight and durable construction.
- Suitable for harsh environment installations.
- DC grounded.
- Easy mounting allowing obtaining required down tilt degree with the optional MNT-25 mount.



## Specifications

### Electrical

Frequency range	902-928 MHz
GAIN, min.	12 dBi
VSWR, max.	1.7 : 1
Polarization	Linear, Horizontal
3 dB Beam-Width, Horizontal Plane, typ.	90°
3 dB Beam-Width, Elevation Plane, typ.	15°
Input power, max.	10 Watt
Input Impedance	50 Ohm
Lightning Protection	DC Grounded

### Mechanical

Dimensions (HxWxD)	1200 x 330 x 105 mm (47.2" x 13" x 4.1")
Weight	4 kg.
Connector	N-Type, Female
Back Plane	Aluminum; protected through chemical passivation
Radome	UV Protected Plastic
Mount	See ordering options

### Environmental

Operating Temperature Range	-40°C to +70°C
Vibration	According to IEC 60721-3-4
Wind Load	200 km/h (survival)
Flammability	UL94
Water Proofing	IP-65
Humidity	ETS 300 019-1-4, EN 302 085 (annex A.1.1)
Salt Fog	According to IEC 68-2-11
Ice and Snow	25mm radial (survival)

## Ordering Options

MA-WD91-6H	Antenna Suited for MNT-25 (optional tilt mount)
MA-WD91-6HB	Antenna with MNT-25 mount

Patterns are available on our website

MARS Antennas & RF Systems proprietary information

MARS reserves the right to make technical changes or modifications to any of its products and specifications without prior notice and without implementing such changes to prior supplied products. Product images are representative and indicative only. Warranty terms and general conditions of sale are applicable on any purchase of any product, available on MARS website.

3 Hamanor st. Holon 5886103, P.O.Box 1852 Holon 5811801, Israel

Tel: +972-3-5599661 • Fax: +972-3-5599677 • e-mail: mars@marsant.co.il • web: www.mars-antennas.com

## MA-WE91-7H

### 915 MHz Horizontally Polarized Sector Antenna, 120°

MARS 120° Horizontally Polarized Sector Antenna provides a robust and efficient solution for Point-to-Multi-Point applications using 915 MHz band, in spectrally crowded areas in this band.

Antenna Features:

- Stable and reliable performance for high interference environments.
- Features horizontal polarization with 11 dBi of gain.
- Light-weight and durable construction.
- Suitable for harsh environment installations.
- DC grounded.
- Easy mounting allowing obtain required down tilt degree with the optional MNT-25 mount.



### Specifications

#### Electrical

Frequency range	902-928 MHz
GAIN, min.	11 dBi
VSWR, max.	1.7 : 1
Polarization	Linear, Horizontal
3 dB Beam-Width, Horizontal Plane, typ.	120°
3 dB Beam-Width, Elevation Plane, typ.	15°
Input power, max.	10 Watt
Input Impedance	50 Ohm
Lightning Protection	DC Grounded

#### Mechanical

Dimensions (HxWxD)	1200 x 330 x 105 mm (47.2" x 13" x 4.1")
Weight	4.5 kg.
Connector	N-Type, Female
Back Plane	Aluminum protected through chemical passivation
Radome	UV Protected Plastic
Mount	See ordering options

#### Environmental

Operating Temperature Range	-40°C to +70°C
Vibration	According to IEC 60721-3-4
Wind Load	200 km/h (survival)
Flammability	UL94
Water Proofing	IP-65
Humidity	ETS 300 019-1-4, EN 302 085 (annex A.1.1)
Salt Fog	According to IEC 68-2-11
Ice and Snow	25mm radial (survival)

### Ordering Options

MA-WE91-7H	Antenna Suited for MNT-25 (optional tilt mount)
MA-WE91-7HB	Antenna with MNT-25 mount

Patterns are available on our website

MARS Antennas & RF Systems proprietary information

MARS reserves the right to make technical changes or modifications to any of its products and specifications without prior notice and without implementing such changes to prior supplied products. Product images are representative and indicative only. Warranty terms and general conditions of sale are applicable on any purchase of any product, available on MARS website.

3 Hamanor st. Holon 5886103, P.O.Box 1852 Holon 5811801, Israel

Tel: +972-3-5599661 • Fax: +972-3-5599677 • e-mail: mars@marsant.co.il • web: www.mars-antennas.com

## MA-WA82220-DBDP14

### 698-960 MHz & 1700-2700 MHz Stadium Dual Band & Dual Pol Directional Antenna

MARS new DUAL BAND and DUAL POL antenna specially **designed for arenas and stadiums** that have to supply high capacity and reliable wireless data.

MARS MA-WA82220-DBDP14 provides solutions for services such as LTE, Cellular (2G, 2.5G and 3G), Wi-Fi and WiMAX applications.

The antenna is PIM certified, thus making it suitable for all multi-carrier systems.

#### Additional Features:

- Efficient and stable performance with 12-13 dBi of gain.
- UV protected radome suitable for harsh environment installations
- Durable construction
- Easy mounting allowing Az/EI adjustment
- Aesthetic design
- Weatherized and durable
- Wind survival rating of 200 km/h



### Specially designed for Stadiums

#### Specifications

##### Electrical

Frequency range		698-960 MHz	1700-2700 MHz
Gain, typ.	V-pol H-pol	12 dBi 13 dBi	13 dBi 13 dBi
VSWR, max.		2.0 : 1	
Polarization	Dual Pol	Vertical & Horizontal	
Port to Port Isolation, min.		-22 dB	-37 dB
3dB Beam-Width, Azimuth, typ.		35°	35°
3dB Beam-Width, Elevation, typ.		35°	35°
Front to Back Ratio, min.		-22 dB	
PIM, 3 <sup>rd</sup> order, 2X20W		-150 dBc	
Input power, max.		50 Watt	
Impedance		50 Ohm	

##### Mechanical

Dimensions (HxWxD)	800 x 600 x 110 mm
Connector	2 x N-type Female
Weight	6 Kg.
Mounting	See Ordering Options
Radome	UV Protected Plastic
Back Plane	Aluminum protected through chemical passivation.

##### Environmental

Operating Temperature Range	-55°C to +65°C
Vibration	According to IEC 60721-3-4
Wind Load	200 Km/h (Survival)
Flammability	UL94
Water Proofing	IP-67
Humidity	ETS 300 019-1-4, EN 302 085 (Annex A.1.1)
Salt Fog	According to IEC 68-2-11

#### Ordering Options

MA-WA82220-DBDP14	Antenna 2 x N-type Female connectors Suited for MNT-25 mount
MA-WA82220-DBDP14B	Antenna 2 x N-type Female connectors with MNT-25 mount

MARS Antennas & RF Systems proprietary information

MARS reserves the right to make technical changes or modifications to any of its products and specifications without prior notice and without implementing such changes to prior supplied products. Product images are representative and indicative only. Warranty terms and general conditions of sale are applicable on any purchase of any product, available on MARS website.

3 Hamanor st. Holon 5886103, P.O.Box 1852 Holon 5811801, Israel

Tel: +972-3-5599661 • Fax: +972-3-5599677 • e-mail: mars@marsant.co.il • web: www.mars-antennas.com

## MA-WA6927-DBDP8

### 698 – 960 MHz & 1700 – 2700 MHz Dual Band & Dual Pol Directional Antenna

MARS Dual band & Dual Polarized Antenna covers all the bands for LTE, 3G, 2.5G and 2G cellular, as well as ISM, WLAN, Bluetooth, GSM 900 and GSM 1900.

The antenna is aesthetic small and has unobtrusive profile that blends easily with any environment.

The antenna is easy-installed and is highly recommended as an outstanding logistic solution for Outdoor installations as well as In-Building Installations.



## Specifications

### Electrical

Frequency range	698 – 960 MHz	1700 – 2700 MHz
Gain, typ.	8 dBi	9 dBi
VSWR	typ.	2.0 : 1
	max.	2.5 : 1
Polarization	Dual Pol	Vertical & Horizontal
Port to Port Isolation, min.	-23 dB	
3dB Beam-Width, Azimuth, typ.	65°	65°
3dB Beam-Width, Elevation, typ.	65°	65°
Front to Back Ratio, min	-15 dB	
PIM, typ.	-140 dBc	
Input power, max.	50 Watt	
Impedance	50 Ohm	
Lightning Protection	DC Grounded	

### Mechanical

Dimensions (HxWxD)	310 x 310 x 126 mm (12.2" x 12.2" x 4.96" )
Connector	2 x N-type Female
Weight	~1.3 kg
Mounting	See Ordering Options
Radome	UV Protected Plastic
Back Plane	Aluminum protected through chemical passivation.

### Environmental

Operating Temperature Range	-55°C to +65°C
Vibration	According to IEC 60721-3-4
Wind Load	200 Km/h (Survival)
Flammability	UL94
Water Proofing	IP-67
Humidity	ETS 300 019-1-4, EN 302 085 (Annex A.1.1)
Salt Fog	According to IEC 68-2-11

## Ordering Options

MA-WA6927-DBDP8	Antenna 2 x N-Type Female connectors Suited for MNT-22
MA-WA6927-DBDP8B	Antenna 2 x N-Type Female connectors with MNT-22 mount

MARS Antennas & RF Systems proprietary information

MARS reserves the right to make technical changes or modifications to any of its products and specifications without prior notice and without implementing such changes to prior supplied products. Product images are representative and indicative only. Warranty terms and general conditions of sale are applicable on any purchase of any product, available on MARS website.

3 Hamanor st. Holon 5886103, P.O.Box 1852 Holon 5811801, Israel

Tel: +972-3-5599661 • Fax: +972-3-5599677 • e-mail: mars@marsant.co.il • web: www.mars-antennas.com

## MA-WC7927-DS12T

790 – 960 MHz & 1710 – 2690 MHz

### Multi/Wide-Band Dual Slant Directional Antenna for Stadium Coverage

MARS DUAL BAND and DUAL Slant antenna specially **designed for arenas and stadiums** that have to supply high capacity and reliable wireless data.

The antenna is PIM certified, thus making it suitable for all multi-carrier systems providing solutions for services such as LTE, Cellular (2G, 2.5G and 3G), Wi-Fi and WiMAX applications

Additional Features:

- Efficient and stable performance with 9.5-12 dBi of gain.
- UV protected radome suitable for harsh environment installations
- Durable construction
- Easy mounting allowing Az/EI adjustment
- Aesthetic design
- Weatherized and durable
- Wind survival rating of 200 km/h



## Specifications

### Electrical

Frequency range	790 – 960 MHz & 1710 – 2690 MHz	
Gain	9.5 – 12 dBi	
VSWR, max.	1.7 : 1	
Polarization	Dual Slant	
EI. Downtilt Range	±45°	
Port to Port Isolation, min.	Intra-Band	-26 dB
	Inter-Band	-50 dB
Side Lobes, min.	-20 dB	
Cross-polar Discrimination at 0°, min.	-20 dB	
3dB Beam-Width, Azimuth	45° – 55°	
3dB Beam-Width, Elevation	45° – 55°	
Front to Back Ratio	35 – 41 dB	
PIM 3rd order (2 x 43 dBm carrier), min.	-150 dBc	
Input power, min.	100 Watt	
Impedance	50 Ohm	

### Mechanical

Dimensions (HxWxD)	811 x 611 x 197 mm	
Connector	2 x 7-16 DIM Female	
Weight.	10 kg	
Mounting	See Ordering Options	
Radome	UV Protected Plastic	
Back Plane	Aluminum protected through chemical passivation.	

### Environmental

Operating Temperature Range	-40°C to +65°C	
Vibration	According to IEC 60721-3-4	
Wind Load	200 Km/h (Survival)	
Flammability	UL94	
Water Proofing	IP-67	
Humidity	ETS 300 019-1-4, EN 302 085 (Annex A.1.1)	
Salt Fog	According to IEC 68-2-11	

## Ordering Options

MA-WC7927-DS12T	Antenna Suited for MNT-25 (optional tilt mount)
MA-WC7927-DS12TB	Antenna with MNT-25 mount

MARS Antennas & RF Systems proprietary information

MARS reserves the right to make technical changes or modifications to any of its products and specifications without prior notice and without implementing such changes to prior supplied products. Product images are representative and indicative only. Warranty terms and general conditions of sale are applicable on any purchase of any product, available on MARS website.

3 Hamanor st. Holon 5886103, P.O.Box 1852 Holon 5811801, Israel

Tel: +972-3-5599661 • Fax: +972-3-5599677 • e-mail: mars@marsant.co.il • web: www.mars-antennas.com



## MA-WC90-DS13

### 850-960 MHz Dual Slant Base Station Sector Antenna, 65°

MARS 915 MHz Dual Slant Base Station Sector Antenna provides a robust and efficient solution for the Point-to-Multipoint systems based on the ISM 915 MHz band.

Additional Features:

- 65° azimuthally coverage.
- Suitable for harsh environment installations.
- DC grounded.



### Specifications

#### Electrical

Frequency range	850-960 MHz
GAIN, typ.	13 dBi
VSWR, max.	1.7 : 1
Polarization	Dual Slant ±45°
3 dB Beam-Width, Azimuth Plane, typ.	65°
3 dB Beam-Width, Elevation Plane, typ.	19°
Side Lobes, typ.	-12 dB
Cross Polarization, typ.	-15 dB
Port to Port Isolation, min.	-24 dB
Front to Back Ratio, typ.	-26 dB
Input power, max	20 Watt
Input Impedance	50 Ohm
Lightning Protection	DC Grounded

#### Mechanical

Dimensions (HxWxD)	960 x 330 x 120 mm
Weight	4 kg.
Connector	2 X N-Type
Back Plane	Aluminum; protected through chemical passivation
Radome	UV Protected Plastic
Mount	See Ordering Options

#### Environmental

Operating Temperature Range	-40°C to +65°C
Vibration	According to IEC 60721-3-4
Wind Load	200 km/h (survival)
Flammability	UL94
Water Proofing	IP-65
Humidity	ETS 300 019-1-4, EN 302 085 (annex A.1.1)
Salt Fog	According to IEC 68-2-11
Ice and Snow	25mm radial (survival)

### Ordering Options

MA-WC90-DS13	Antenna Suited for MNT-25 (optional tilt mount)
MA-WC90-DS13B	Antenna with MNT-25 mount

MARS Antennas & RF Systems proprietary information

MARS reserves the right to make technical changes or modifications to any of its products and specifications without prior notice and without implementing such changes to prior supplied products. Product images are representative and indicative only. Warranty terms and general conditions of sale are applicable on any purchase of any product, available on MARS website.

3 Hamanor st. Holon 5886103, P.O.Box 1852 Holon 5811801, Israel

Tel: +972-3-5599661 • Fax: +972-3-5599677 • e-mail: mars@marsant.co.il • web: www.mars-antennas.com

## MA-WD90-DS12

### 850-960 MHz Dual Slant Base Station Sector Antenna, 90°

MARS 915 MHz Dual Slant Base Station Sector Antenna provides a robust and efficient solution for the Point-to-Multipoint systems based on the ISM 915 MHz band.

Additional Features:

- 90° azimuthally coverage.
- Suitable for harsh environment installations.
- DC grounded



### Specifications

<b>Electrical</b>	
Frequency range	850-960 MHz
GAIN, typ.	12 dBi
VSWR, max.	1.7 : 1
Polarization	Dual Slant
	± 45°
3 dB Beam-Width, Azimuth Plane, typ.	90°
3 dB Beam-Width, Elevation Plane, typ.	19°
Side Lobes, typ.	-12 dB
Cross Polarization, typ.	-15 dB
Port to Port Isolation, min.	-24 dB
Front to Back Ratio, typ.	-26 dB
Input power, max	20 Watt
Input Impedance	50 Ohm
Lightning Protection	DC Grounded
<b>Mechanical</b>	
Dimensions (HxWxD)	960 x 330 x 120 mm
Weight	4 kg
Connector	2 X N-Type
Back Plane	Aluminum; protected through chemical passivation
Radome	UV Protected Plastic
Mount	See Ordering Options
<b>Environmental</b>	
Operating Temperature Range	-40°C to +65°C
Vibration	According to IEC 60721-3-4
Wind Load	200 km/h (survival)
Flammability	UL94
Water Proofing	IP-65
Humidity	ETS 300 019-1-4, EN 302 085 (annex A.1.1)
Salt Fog	According to IEC 68-2-11
Ice and Snow	25mm radial (survival)

### Ordering Options

MA-WD90-DS12	Antenna Suited for MNT-25 (optional tilt mount)
MA-WD90-DS12B	Antenna with MNT-25 mount

MARS Antennas & RF Systems proprietary information

MARS reserves the right to make technical changes or modifications to any of its products and specifications without prior notice and without implementing such changes to prior supplied products. Product images are representative and indicative only. Warranty terms and general conditions of sale are applicable on any purchase of any product, available on MARS website.

3 Hamanor st. Holon 5886103, P.O.Box 1852 Holon 5811801, Israel

Tel: +972-3-5599661 • Fax: +972-3-5599677 • e-mail: mars@marsant.co.il • web: www.mars-antennas.com

## MA-WA43-1X

### 425-445 MHz In Building Panel Antenna

MARS 425-445 MHz Panel Antenna provides a cost effective solution for In Building PMR applications.

Additional Features:

- Excellent and stable performance
- Small and aesthetic profile
- UV protected antenna radome
- Suitable for both indoor and outdoor installations
- DC grounded
- Wall mount



### Specifications

#### Electrical

Frequency range	425-445 MHz
GAIN, typ.	4 dBi
VSWR, max.	1.7 : 1
Polarization	Linear, Vertical
3 dB Beam-Width, H-Plane, typ.	100°
3 dB Beam-Width, E-Plane, typ.	110°
Input power, max	20 Watt
Input Impedance	50 Ohm

#### Mechanical

Dimensions (HxWxD)	231 x 215 x 31 mm (8.9" x 8.5" x 1.1")
Weight	840 gr.
Connector	N-Type, (F)/ Pigtail ending in N-Type (F)
Back Plane	Aluminum protected through chemical passivation
Radome	UV Protected Plastic
Mount	Wall-Indoor Usage (Outdoor Version Available on Request)

#### Environmental

Operating Temperature Range	-40°C to +65°C
Vibration	According to IEC 60721-3-4
Wind Load	N/A
Flammability	UL94
Water Proofing	IP-65
Humidity	ETS 300 019-1-4, EN 302 085 (annex A.1.1)
Salt Fog	According to IEC 68-2-11
Ice and Snow	25mm radial (survival)

### Ordering Options

MA-WA43-1X	N-Type Connector Version
MA-WA43-1XC	N-Type + Cable RG58, ~25cm

MARS Antennas & RF Systems proprietary information

MARS reserves the right to make technical changes or modifications to any of its products and specifications without prior notice and without implementing such changes to prior supplied products. Product images are representative and indicative only. Warranty terms and general conditions of sale are applicable on any purchase of any product, available on MARS website.

3 Hamanor st. Holon 5886103, P.O.Box 1852 Holon 5811801, Israel

Tel: +972-3-5599661 • Fax: +972-3-5599677 • e-mail: mars@marsant.co.il • web: www.mars-antennas.com

## MA-WA46-1X

### 450-470 MHz In Building Panel Antenna

MARS 450 - 470 MHz Panel Antenna provides a cost effective solution for In Building PMR applications.

Additional Features:

- Excellent and stable performance
- Small and aesthetic profile
- UV protected antenna radome
- Suitable for both indoor and outdoor installations
- DC grounded
- Wall mount



### Specifications

#### Electrical

Frequency range	450-470 MHz
GAIN, typ.	4 dBi
VSWR,	typ 1.5:1, max 1.7 : 1
Polarization	Linear, Vertical
3 dB Beam-Width, H-Plane, typ.	100°
3 dB Beam-Width, E-Plane, typ.	110°
Input power, max	20 Watt
Input Impedance	50 Ohm

#### Mechanical

Dimensions (HxWxD)	231 x 215 x 31 mm (8.9" x 8.5" x 1.1")
Weight	840 gr.
Connector	See Ordering Options
Back Plane	Aluminum protected through chemical passivation
Radome	UV Protected Plastic
Mount	Wall mount

#### Environmental

Operating Temperature Range	-40°C to +75°C
Vibration	According to IEC 60721-3-4
Wind Load	N/A
Flammability	UL94
Water Proofing	IP-65, (IP67 for Outdoor version)
Humidity	ETS 300 019-1-4, EN 302 085 (annex A.1.1)
Salt Fog	According to IEC 68-2-11
Ice and Snow	25mm radial (survival)

### Ordering Options

MA-WA46-1X	Antenna with N-Type Female Connector
MA-WA46-1XC	Antenna with N-Type Female + Cable RG58, ~25cm
MA-WA46-1XS	Antenna Outdoor with SMA Female Connector

MARS Antennas & RF Systems proprietary information

MARS reserves the right to make technical changes or modifications to any of its products and specifications without prior notice and without implementing such changes to prior supplied products. Product images are representative and indicative only. Warranty terms and general conditions of sale are applicable on any purchase of any product, available on MARS website.

3 Hamanor st. Holon 5886103, P.O.Box 1852 Holon 5811801, Israel

Tel: +972-3-5599661 • Fax: +972-3-5599677 • e-mail: mars@marsant.co.il • web: www.mars-antennas.com

## MA-CLTE-14

### Multi Band Panel Antenna

Up-To-Date Multi Band Panel Antenna covers all the bands for LTE 700 MHz, cellular bands, as well as ISM, WLAN, GSM1800, UMTS and Bluetooth.

The antenna is aesthetic, small and has unobtrusive profile that blends easily with any environment.

The antenna can be easily used either for Indoor or Outdoor Applications and features different mounting options.



### Specifications

#### Electrical

Standard	LTE 700	SMR,AMPC, CDMA,TDMA GSM 900	GSM 1800, UMTS	Bluetooth, ISM, WLAN
Frequency range	698-806 MHz	806-960 MHz	1710-2170 MHz	2.2-2.7 GHz
GAIN, typ.	5 ± 1dBi	6 ± 1dBi	6.5 ± 1dBi	5 ± 1 dBi
VSWR, max.	2 : 1	2 : 1	1.7 : 1	1.7 : 1
3 dB Beam-Width, H-Plane, typ.	130°	140°	80°	55°
3 dB Beam-Width, E-Plane, typ.	70°	60°	45°	30°
Polarization	Linear, Vertical			
Input power, max.	10 Watt			
Input Impedance	50 Ohm			

#### Mechanical

Dimensions (HxWxD)	231 x 215 x 37.5 mm (9.1" × 8.5" × 1.5")
Weight	500 gr.
Connector	N-Type, Female at bottom (can be installed also upside down)
Back Plane	UV Protected Plastic (metal reinforced from the inside)
Radome	UV Protected Polycarbonate
Mount	See Ordering Options

#### Environmental

Operating Temperature Range	-40°C to +65°C
Vibration	According to IEC 60721-3-4
Wind Load	200 km/h (survival)
Flammability	UL94
Water Proofing	IP-65
Humidity	ETS 300 019-1-4, EN 302 085 (annex A.1.1)
Salt Fog	According to IEC 68-2-11
Ice and Snow	25mm radial (survival)

### Ordering Options

Application	Wall Mountable	Az/EI Adjustable MNT-22 Mount
Indoor / Outdoor	MA-CLTE-14	MA-CLTE-14B
Indoor / Outdoor + DC Return	MA-CLTE-14T	MA-CLTE-14TB

MARS Antennas & RF Systems proprietary information

MARS reserves the right to make technical changes or modifications to any of its products and specifications without prior notice and without implementing such changes to prior supplied products. Product images are representative and indicative only. Warranty terms and general conditions of sale are applicable on any purchase of any product, available on MARS website.

3 Hamanor st. Holon 5886103, P.O.Box 1852 Holon 5811801, Israel

Tel: +972-3-5599661 • Fax: +972-3-5599677 • e-mail: mars@marsant.co.il • web: www.mars-antennas.com

## MA-CL67-15

### Multi Band Panel Antenna

Up-To-Date Multi Band Panel Antenna covers all the bands for 2G, 2.5G and 3G cellular, as well as ISM, WLAN and Bluetooth.

The antenna is aesthetic, small and has unobtrusive profile that blends easily with any environment.

The antenna can be easily used either for Indoor or Outdoor Applications and features different mounting options.

Antenna is designed to include DC Return Option which is available on request.



### Specifications

#### Electrical

Standard	SMR, AMPS, CDMA, TDMA, GSM 900	PCS, DECT, GSM 1900, UMTS	Bluetooth, ISM, WLAN
Frequency range	806-960 MHz	1.71-2.17 GHz	2.2-2.7 GHz
GAIN, typ.	8.5 dBi	7.5-10 dBi	5-6.5 dBi
VSWR, max.	2 : 1	1.7 : 1	1.9 : 1 @ 2.2-2.5 GHz 2.1 : 1 @ 2.5-2.7 GHz
3 dB Beam-Width, H-Plane, typ.	75°	60°	50°
3 dB Beam-Width, E-Plane, typ.	65°	45°	25°
Polarization	Linear, Vertical		
Input power, max.	50 Watt		
Input Impedance	50 Ohm		

#### Mechanical

Dimensions (HxWxD)	231 x 215 x 37.5 mm (9.1" x 8.5" x 1.5")
Weight	500 gr.
Connector	N-Type, Female at bottom (can be installed also upside down)
Back Plane	UV Protected Plastic (metal reinforced from the inside)
Radome	UV Protected Polycarbonate
Mount	See Ordering Options

#### Environmental

Operating Temperature Range	-40°C to +65°C
Vibration	According to IEC 60721-3-4
Wind Load	200 km/h (survival)
Flammability	UL94
Water Proofing	IP-65
Humidity	ETS 300 019-1-4, EN 302 085 (annex A.1.1)
Salt Fog	According to IEC 68-2-11
Ice and Snow	25 mm radial (survival)

### Ordering Options

Application	Wall Mountable	Az/EI Adjustable MNT-22 Mount
Without DC Return	MA-CL67-15	MA-CL67-15B
With DC Return	MA-CL67-15T	MA-CL67-15TB

Patterns are available on our website

MARS Antennas & RF Systems proprietary information

MARS reserves the right to make technical changes or modifications to any of its products and specifications without prior notice and without implementing such changes to prior supplied products. Product images are representative and indicative only. Warranty terms and general conditions of sale are applicable on any purchase of any product, available on MARS website.

3 Hamanor st. Holon 5886103, P.O.Box 1852 Holon 5811801, Israel

Tel: +972-3-5599661 • Fax: +972-3-5599677 • e-mail: mars@marsant.co.il • web: www.mars-antennas.com

## MA-CN14-11

### Multi Band 140° Antenna

MARS Multi Band 140° Antenna covers all the bands for 2G, 2.5G and 3G cellular.

The antenna is aesthetic, small and has unobtrusive profile.



### Specifications

#### Electrical

Standard	SMR, AMPS, CDMA, TDMA, GSM 900	PCS, DECT, GSM 1900, UMTS
Frequency range	806-960 MHz	1.71-2.17 GHz
GAIN, typ.	5 dBi	
VSWR, max.	2 : 1	
3 dB Beam-Width, H-Plane, typ.	130°	140-150°
3 dB Beam-Width, E-Plane, typ.	70°	85°
Polarization	Linear, Vertical	
Input power, max.	50 Watt	
Input Impedance	50 Ohm	

#### Mechanical

Dimensions - Base Plate (HxW)	185 x 105 mm (7.3" x 4.1")
Dimensions - Radome (HxWxD)	175 x 35 x 125 mm (6.9" x 1.4" x 4.9")
Weight	260 gr.
Connector	Pig Tail with N-Type, Female
Back Plane	Aluminum; protected through chemical passivation
Radome	UV Protected Plastic

#### Environmental

Operating Temperature Range	-40°C to +65°C
Vibration	According to IEC 60721-3-4
Flammability	UL94
Humidity	ETS 300 019-1-4, EN 302 085 (annex A.1.1)

### Ordering Options

MA-CN14-11	Antenna Indoor
MA-CN14-11R	Antenna Outdoor

Patterns are available on our website

MARS Antennas & RF Systems proprietary information

MARS reserves the right to make technical changes or modifications to any of its products and specifications without prior notice and without implementing such changes to prior supplied products. Product images are representative and indicative only. Warranty terms and general conditions of sale are applicable on any purchase of any product, available on MARS website.

3 Hamanor st. Holon 5886103, P.O.Box 1852 Holon 5811801, Israel

Tel: +972-3-5599661 • Fax: +972-3-5599677 • e-mail: mars@marsant.co.il • web: www.mars-antennas.com

**MA-CC60-60**  
**Dual Beam GSM Wi-Fi Antenna**

MARS Dual Beam GSM Antenna is ideal for deployment in tunnels or long building corridors ceiling. It features small and unobtrusive profile that blends easily with any environment.

Applicable Applications:

- Tunnel coverage.
- Indoor cell extender.



**Specifications**

**Electrical**

Frequency range	870-960 MHz	2.4-2.5 GHz
GAIN, min.	3.5 dBi	4.5 dBi
3 dB Beam-Width, H-Plane, typ.	2 x 90°	2 x 85°
3 dB Beam-Width, E-Plane, typ.	66°	60°
VSWR, max.	1.8 :1	
Polarization	Linear, Vertical	
Input power, max	50 Watt	
Input Impedance	50 Ohm	

**Mechanical**

Dimensions (HxWxD)	184 x 100 x 125 mm.
Weight	240 gr.
Connector	N-Type Female/Side Pigtail Optional
Back Plane	Aluminum, Conversion Coated
Radome	ABS, UV Protected
Mount	Ceiling Mountable

**Environmental**

Operating Temperature Range	-10°C to +65°C
Vibration	According to IEC 60721-3-4
Wind Load	Survival: Indoor use.
Flammability	UL94
Water Proofing	IP-65
Humidity	ETS 300 019-1-4, EN 302 085 (annex A.1.1)
Salt Fog	According to IEC 68-2-11
Ice and Snow	25mm Radial

MARS Antennas & RF Systems proprietary information

MARS reserves the right to make technical changes or modifications to any of its products and specifications without prior notice and without implementing such changes to prior supplied products. Product images are representative and indicative only. Warranty terms and general conditions of sale are applicable on any purchase of any product, available on MARS website.

3 Hamanor st. Holon 5886103, P.O.Box 1852 Holon 5811801, Israel

Tel: +972-3-5599661 • Fax: +972-3-5599677 • e-mail: mars@marsant.co.il • web: www.mars-antennas.com



# 1150 MHz – 2700 MHz

Subscriber - Single Pol  
 Subscriber - Dual Slant  
 Subscriber - Triple Pol  
 Subscriber - Quad Pol  
 Sector - Single Pol  
 Sector - Dual Pol  
 Sector - Double Dual Slant  
 Sector - Triple Pol  
 Sector - Quad Pol  
 DAS - Single Pol  
 GPS

Part Number	Description	Frequency band	Gain	Polarization	Dimension	Antenna type	Page
<b>MA-WA12-9</b>	1150-1375 MHz Directional Antenna	1150-1375 MHz	9 dBi	Linear, Vertical or Horizontal	175 x 96 Dia mm	Subscriber Single Pol	02-1
<b>MA-WA14-1X</b>	1425-1525 MHz Directional	1425-1525 MHz	13.5 dBi (min.)	Linear, Vertical	305 x 305 x 25 mm	Subscriber Single Pol	02-2
<b>MA-WA18-1X</b>	1.8 GHz Directional	1.71-1.88 GHz	14 dBi (min.)	Linear, Vertical	305 x 305 x 27 mm	Subscriber Single Pol	02-3
<b>MA-WA19-4X</b>	1.9 GHz Directional	1.85-1.99 GHz	15 dBi (min.)	Linear, Vertical	305 x 305 x 25 mm	Subscriber Single Pol	02-4
<b>MA-WA24-2X</b>	Subscriber, High Gain	2.3-2.7 GHz	18 dBi (typ.)	Linear, Vertical or Horizontal	305 x 305 x 15 mm	Subscriber Single Pol	02-5
<b>MA-WA25-20</b>	Subscriber, High Gain	2.3-2.7 GHz	20 dBi (typ.)	Linear, Vertical or Horizontal	370 x 370 x 40 mm	Subscriber Single Pol	02-6
<b>MA-WA24-12</b>	Small Size Subscriber	2.4-2.7 GHz	12 dBi (min.)	Linear, Vertical	155 x 155 x 28 mm	Subscriber Single Pol	02-7
<b>MA-WS2455-1X</b>	Dual Band Subscriber, High Gain	2.4-2.5 GHz 4.9-5.875 GHz	18 dBi 12 dBi (typ.)	Linear, Vertical or Horizontal	305 x 305 x 25 mm	Subscriber Single Pol	02-8
<b>MA-WA82220-DBDP14</b>	Dual Band Dual Polarization	698-960 MHz 1.7-2.7 GHz	12 dBi 16 dBi	Dual Pole V & H	800 x 600 x 110 mm	Subscriber Dual Pol	<b>01-17</b>
<b>MA-WA6927-DBDP8</b>	Directional Dual Band / Dual Polarized	698-960 MHz 1700-2100 MHz 2100-2700 MHz	8 dBi 7 dBi 10 dBi	Vertical & Horizontal	310 x 310 x 126 mm	Subscriber Dual Pol	<b>01-18</b>
<b>MA-WA6960-DS7</b>	Multi Band Dual Slant Directional	698-960 MHz 1700-2700 MHz 5150-6000 MHz	7.5 dBi 6-7 dBi 6 dBi	Dual Slant $\pm 45^\circ$	300 x 300 x 99 mm	Subscriber Dual Slant	<b>01-7</b>
<b>MA-WA22-DP8</b>	Dual Polarized / Dual Slant Subscriber	1.7-2.7 GHz	8 dBi (typ.)	Dual Pole V & H Dual Slant $\pm 45^\circ$	112 x 112 x 33.5 mm	Subscriber Dual Pol	02-9
<b>MA-WA22-DP14</b>	Dual Polarization	1.7-2.2 GHz 2.2-2.7 GHz	13 dBi 14 dBi	Linear, V & H	430 x 240 x 48 mm	Subscriber Dual Pol	02-10
<b>MA-WA18-DP12</b>	Dual Polarized / Dual Slant Subscriber	1.75-1.85 GHz	14 dBi (typ.)	Dual Pol V&H Dual Slant $\pm 45^\circ$	305 x 305 x 15 mm	Subscriber Dual Pol	02-11
<b>MA-WA18-DP18</b>	Dual Polarized / Dual Slant Subscriber	1.75-1.85 GHz	17 dBi (typ.)	Dual Pol V&H Dual Slant $\pm 45^\circ$	370 x 370 x 40 mm	Subscriber Dual Pol	02-12
<b>MA-WA25-DP9</b>	Dual Polarized / Dual Slant Subscriber	2.3-2.7 GHz	8 $\pm 1$ dBi	Dual Pol V&H Dual Slant $\pm 45^\circ$	112 x 112 x 33.5 mm	Subscriber Dual Pol	02-13
<b>MA-WA25-DP14</b>	Dual Polarized / Dual Slant Subscriber	2.3-2.7 GHz	14 dBi (typ.)	Dual Pole V & H Dual Slant $\pm 45^\circ$	200 x 200 x 33 mm	Subscriber Dual Pol	02-14

MARS Antennas & RF Systems proprietary information

MARS reserves the right to make technical changes or modifications to any of its products and specifications without prior notice and without implementing such changes to prior supplied products. Product images are representative and indicative only. Warranty terms and general conditions of sale are applicable on any purchase of any product, available on MARS website.

3 Hamanor st. Holon 5886103, P.O.Box 1852 Holon 5811801, Israel

Tel: +972-3-5599661 • Fax: +972-3-5599677 • e-mail: mars@marsant.co.il • web: www.mars-antennas.com

Part Number	Description	Frequency band	Gain	Polarization	Dimension	Antenna type	Page
MA-WA25-DP17	Dual Polarized / Dual Slant Subscriber	2.3-2.7 GHz	17.5 dBi (typ.)	Dual Pole V & H Dual Slant $\pm 45^\circ$	305 x 305 x 40 mm	Subscriber Dual Pol	02-15
MA-WA25-DP19	Dual Polarized / Dual Slant Subscriber	2.3-2.7 GHz	19 $\pm$ 1 dBi (typ.)	Dual Pole V & H Dual Slant $\pm 45^\circ$	370 x 370 x 40 mm	Subscriber Dual Pol	02-16
MA-WA25-DP23	Dual Polarized / Dual Slant Subscriber	2.3-2.7 GHz	23 $\pm$ 1 dBi (typ.)	Dual Pole V & H Dual Slant $\pm 45^\circ$	600 x 600 x 30 mm	Subscriber Dual Pol	02-17
MA-WA24-TPMIMO	Triple Polarization MIMO Subscriber	2.3-2.7 GHz	Vertical 15 $\pm$ 1 dBi Dual Slant 12 $\pm$ 1 dBi	Dual Slant $\pm 45^\circ$ & Vertical	305 x 305 x 15 mm	Subscriber Triple Pol	02-18
MA-WA2455-QPMIMO	Dual Band Quad Polarization	2.3-2.7 GHz 5.15-5.875 GHz	12 dBi 16 dBi	Dual Slant $\pm 45^\circ$ Dual Pol V&H	305 x 305 x 15 mm	Subscriber QUAD Pol	02-19
MA-WA25-QP4MIMO14	Quad Polarization 4X4 Subscriber	2.3-2.7 GHz	4 x 13.5 dBi	Dual Slant $\pm 45^\circ$ Dual Pol V&H	370 x 370 x 40 mm	Subscriber QUAD Pol	02-20
MA-WC24-14	Base Station, 60°	2.3-2.7 GHz	14 dBi	Linear, Vertical	380 x 150 x 80 mm	Sector Single Pol	02-21
MA-WD24-13	Base Station, 90°	2.3-2.7 GHz	13 dBi	Linear, Vertical	380 x 75 x 80 mm	Sector Single Pol	02-22
MA-WE24-11	Base Station, 120°	2.3-2.7 GHz	11.5 dBi	Linear, Vertical	380 x 75 x 80 mm	Sector Single Pol	02-23
MA-WC24-17	Base Station, 60°	2.3-2.7 GHz	17 dBi	Linear, Vertical	800 x 120 x 65 mm	Sector Single Pol	02-24
MA-WD24-15	Base Station, 90°	2.3-2.7 GHz	15.5 dBi	Linear, Vertical	800 x 120 x 65 mm	Sector Single Pol	02-25
MA-WE24-14	Base Station, 120°	2.3-2.7 GHz	14 dBi	Linear, Vertical	800 x 120 x 65 mm	Sector Single Pol	02-26
MA-DBO2458-6	Dual Band Omni	2.3-2.7 GHz 4.9-6 GHz	4-5 dBi / 7 dBi	Linear, Vertical	210 x 28.5 Dia. mm	Sector Single Pol	<b>07-22</b>
MA-WD24-13MIMO	MIMO Base Station, 90°	2.3-2.7 GHz	3 x 13 dBi	Linear, Vertical	400 x 308 x 80 mm	Sector Single Pol	02-27
MA-WE24-14MIMO	MIMO Base Station, 120°	2.3-2.7 GHz	4 X 14 dBi	Linear, Vertical	812 x 470 x 70 mm	Sector Single Pol	02-28
MA-DBO-3H	Dual Band MIMO Omni	2.3-2.7 GHz 4.9-6.1 GHz	3 X 2.5 dBi 3 X 3.5 dBi	Linear, Vertical	200 x 200 x 33 mm	Sector Single Pol	<b>07-23</b>
MA-DBO-3MIMO	Dual Band MIMO Omni	2.3-2.7 GHz 4.9-6 GHz	3 X 4 dBi 3 X 7 dBi	Linear, Vertical	205 x 330 mm	Sector Single Pol	<b>07-24</b>
MA-WC2458-6	Dual Band 60°	2.4-2.5 GHz 5.15-5.875 GHz	6 dBi	Linear Vertical or Horizontal	112 x 112 x 33.5 mm	Sector Single Pol	02-29
MA-WC2458-10	Dual Band 60°	2.4-2.5 GHz 5.15-5.875 GHz	9.5 dBi 10.5 dBi	Linear Vertical or Horizontal	112 x 112 x 33.5 mm	Sector Single Pol	02-30
MA-WC7927-DS12T	Multi/Wide-Band Dual Slant Directional for Stadium Coverage	790 – 960 MHz 1.71 – 2.69 GHz	9.5 – 12 dBi	Dual Slant $\pm 45^\circ$	811 x 611 x 197 mm	Sector Dual Slant	<b>01-19</b>
MA-WE2458-MIMO4-5	Dual Band Sector, 120°	2.3-2.7 GHz 4.9-6.1 GHz	4 X 5 dBi	2 x Dual Slant $\pm 45^\circ$	200 x 200 x 33 mm	Sector Dual Slant	02-31
MA-WC25-DP14	Dual Polarized Base Station 60°	2.3-2.7 GHz	14 dBi	Dual, Vertical & Horizontal	370 x 370 x 40 mm	Sector Dual Pol	02-32
MA-WD25-DP13	Dual Polarized Base Station 90°	2.3-2.7 GHz	12.5 dBi	Dual, Vertical & Horizontal	370 x 370 x 40 mm	Sector Dual Pol	02-33
MA-WC25-DS16	Dual Slant Base Station 65°	2.3-2.7 GHz	2 x 16 dBi	Dual Slant $\pm 45^\circ$	800 x 225 x 67 mm	Sector Dual Pol	02-34

MARS Antennas & RF Systems proprietary information

MARS reserves the right to make technical changes or modifications to any of its products and specifications without prior notice and without implementing such changes to prior supplied products. Product images are representative and indicative only. Warranty terms and general conditions of sale are applicable on any purchase of any product, available on MARS website.

3 Hamanor st. Holon 5886103, P.O.Box 1852 Holon 5811801, Israel

Tel: +972-3-5599661 • Fax: +972-3-5599677 • e-mail: mars@marsant.co.il • web: www.mars-antennas.com

Part Number	Description	Frequency band	Gain	Polarization	Dimension	Antenna type	Page
MA-WD25-DS15	Dual Slant Base Station 90°	2.3-2.7 GHz	2 x 15 dBi	Dual Slant ±45°	800 x 225 x 67 mm	Sector Dual Pol	02-35
MA-WC25-DS18	Dual Slant Base Station 60°	2.3-2.7 GHz	17 dBi	Dual Slant ±45°	1200 x 200 x 70 mm	Sector Dual Pol	02-36
MA-WD25-MIMO3	Dual Polarization Array 90°	2.3-2.7 GHz	6 X 14 dBi	Dual Slant ± 45°	800 x 600 x 40 mm	Sector Dual Pol	02-37
MA-WC2458-MIMO4-8	Dual Band Sector 60°	2.4-2.5 GHz 5.15-5.875 GHz	4 X 6 dBi	Dual Slant ±45° & ±135°	200 x 200 x 33 mm	Sector Double dual slant	02-38
MA-WC2458-2H	Dual Band , Dual Slant Sector, 60°	2.4-2.5 GHz 5.15-5.875 GHz	2 X 7.5 dBi	Dual Slant ±45°	200 x 200 x 33 mm	Sector Dual Slant	02-39
MA-WD2455-DBDP17	Dual Band , Dual Pol Base Station 90°	2.4-2.5 GHz 5.1-5.9 GHz	15 dBi 17 dBi	Vertical & Horizontal	812 X 330 X 70 mm	Sector Dual Pol	02-40
MA-WE2458-2H	Dual Slant Base Station 120°	2.4-2.5 GHz 4.9-5.875 GHz	5 dBi	Dual Slant ±45°	200 x 200 x 33 mm	Sector Dual Slant	02-41
MA-WC25-2DS17	2 x Dual Slant Base Station, 65°	2.3-2.7 GHz	4 x 17 dBi	2 x Dual Pol ±45°	812 X 470 X 70 mm	Sector Double Dual Slant	02-42
MA-WE2458-3H	Triple Polarization MIMO Dual Band Sector 120°	2.3-2.7 GHz 4.9-6.1 GHz	3 X 5 dBi	Dual Slant ± 45° & Vertical	200 x 200 x 33 mm	Sector Triple Pol	02-43
MA-WC2458-3H	Triple Polarization MIMO Dual Band Sector 60°	2.4-2.5 GHz 5.15-5.875 GHz	3 X 7.5 dBi	Dual Slant ± 45° & Vertical	200 x 200 x 33 mm	Sector Triple Pol	02-44
MA-WC2458-QP6	Dual Band Quad pole Sector 60°	2.4-2.5 GHz 5.15-5.875 GHz	4 X 6 dBi	Dual Slant ±45° & V & H	200 x 200 x 33 mm	Sector QUAD Pol	02-45
MA-WO-UWB	Ultra Wide Band OMNI Directional	138-174 MHz 380-450 MHz 450-512 MHz 512-698 MHz 698-746 MHz 746-806 MHz 806-960 MHz 1200-2700 MHz 3300-3800 MHz 4100-6000 MHz	3 dBi 4 dBi 5 dBi 5.5 dBi 6 dBi 7 dBi 7 dBi 8 dBi 10 dBi 11 dBi	Linear, Vertical	540 x 40 Dia mm	DAS Single Pol	07-1
MA-CQ26-1X	380 MHz -6 GHz Multi Band Omni	380-806 MHz 806-960 MHz 1395-1432 MHz 1710-2170 MHz 2300-2500 MHz 3300-3700 MHz 4900-6000 MHz	1 (2*) dBi 4 dBi 5 dBi 5 dBi 5 dBi 5 dBi 6 dBi	Linear, Vertical	Base Dia. - 275 Height - 187 mm	DAS Single Pol	07-2
MA-CQ27-1X	380 MHz -6 GHz Multi Band Omni	380-806 MHz 806-960 MHz 1395-1432 MHz 1710-2170 MHz 2300-2700 MHz 3300-3700 MHz 4900-6000 MHz	1 (2*) dBi 4 dBi 5 dBi 5 dBi 6 dBi 6 dBi 6 dBi	Linear, Vertical	Base Dia. - 275 Height - 187 mm	DAS Single Pol	07-3
MA-CQ29-1X	380 MHz -6 GHz Multi Band Omni	380-806 MHz 806-960 MHz 1700-2500 MHz 2500-2700 MHz 3300-3700 MHz 4900-6000 MHz	1 (2*) dBi 4 dBi 5 dBi 5 dBi 6 dBi 6 dBi	Linear, Vertical	Base Dia. - 275 Height - 187 mm	DAS Single Pol	07-4
MA-WOLTE-3X	LTE, GSM, UMTS, WLAN, Wi-Fi Multi Band Omni	698-806 MHz 806-960 MHz 1710-2170 MHz 2300-2700 MHz 3300-3800 MHz 4900-6500 MHz	2 dBi 2 dBi 3-4 dBi 5 dBi 4 dBi 6 dBi	Linear, Vertical	Base Dia. - 205 Height - 89 mm	DAS Single Pol	07-6

MARS Antennas & RF Systems proprietary information

MARS reserves the right to make technical changes or modifications to any of its products and specifications without prior notice and without implementing such changes to prior supplied products. Product images are representative and indicative only. Warranty terms and general conditions of sale are applicable on any purchase of any product, available on MARS website.

3 Hamanor st. Holon 5886103, P.O.Box 1852 Holon 5811801, Israel

Tel: +972-3-5599661 • Fax: +972-3-5599677 • e-mail: mars@marsant.co.il • web: www.mars-antennas.com

Part Number	Description	Frequency band	Gain	Polarization	Dimension	Antenna type	Page
MA-WOLTE-3M1	698-6500 MHz Multi Band Tri-Ports Omni	<b>Port 1 &amp; 2</b> 698-960 MHz 1710-2170 MHz 2.3-2.7 GHz. 3.3-3.8 GHz 4.9- 6.5 GHz <b>Port 3</b> 1710-2170 MHz 2.3-2.7 GHz 3.3-3.8 GHz 4.9- 6.5 GHz	2 dBi 3-4 dBi 5 dBi 4 dBi 6 dBi 3 dBi 3 dBi 4 dBi 6 dBi	Linear, Vertical	Antenna dimension (D,H): 220 x 95 mm  Base dimension (L,W,H): 369 x 270 x 30 mm	DAS Single Pol	07-7
MA-WOLTE-DP1	698-6500 MHz Multi Band Dual Polarized Omni	<b>Vertical</b> 698-960 MHz 1710-2170 MHz 2.3-2.7 GHz 3.3-3.8 GHz 4.9- 6.5 GHz <b>Horizontal</b> 2.3-2.7 GHz 4.9- 5.875 GHz	4 dBi 5 dBi 5.5 dBi 7 dBi 7.5 dBi 5 dBi 5 dBi	Linear, Vertical	Base Diameter 275 mm  Height 190 mm	DAS Single Pol	07-8
MA-CLTE-14	LTE, GSM, UMTS, WLAN, Wi-Fi Multi Band Panel	698-806 MHz 806-960 MHz 1710-2170 MHz 2200-2700 MHz	5 dBi 6 dBi 6.5 dBi 5 dBi	Mixed, Vertical and Horizontal	231 x 215 x 37.5 mm	DAS Single Pol	01-24
MA-WOLTE-DP2	698-6500 MHz Multi Band Tri-Ports Omni	<b>Port 1</b> 1.7-2.7 GHz <b>Port 2</b> 4.4-6.6 GHz <b>Port 3</b> 698-960 MHz 1.7-2.3 GHz 2.3-2.7 GHz. 3.3-3.8 GHz 4.5- 6.6 GHz	5 dBi 6 dBi 4 dBi 3-4 dBi 5.5 dBi 4 dBi 6 dBi	Linear, Horizontal  Linear, Horizontal  Linear, Vertical	Antenna dimension (D,H): 220 x 95 mm  (Stand out from the ceiling)	DAS Single Pol	07-9
MA-CR26-2X	Multi Band Omni	806-960 MHz 1710-2170 MHz 2300-2700 MHz 3400-3700 MHz 4900-6000 MHz	2 dBi 3-4 dBi 5 dBi 5 dBi 5-6 dBi	Linear, Vertical	Base Dia. - 205 Height - 89 mm	DAS Single Pol	07-12
MA-CM36-15	Multi Band Omni	806-960 MHz 1710-2170 MHz 2300-2700 MHz	2 dBi 3-4 dBi 5 dBi	Linear, Vertical	Base Dia. - 205 Height - 89 mm	DAS Single Pol	07-13
MA-CL67-15	GSM, UMTS, WLAN Multi Band Panel	806-960 MHz 1710-2170 MHz 2200-2700 MHz	8.5 dBi 7.5-10 dBi 5-6.5 dBi	Linear, Vertical	231 x 215 x 37.5 mm	DAS Single Pol	01-25
MA-CN14-11	Multi Band 140°	806-960 MHz 1710-2170 MHz	5 dBi	Linear, Vertical	175 x 35 x 125 mm	DAS Single Pol	01-26
MA-CC60-60	Dual Beam GSM	870-960 MHz 2.4-2.5 GHz	3.5 dBi 4.5 dBi	Linear, Vertical	184 x 100 x 125 mm	DAS Single Pol	01-27
MA-EG15-XX	GPS AVL Active	1575±1.24 MHz	27 dBi	Circular, RHCP	40 x 45 x 15 mm	GPS	02-46
MA-AGP15-5	Active GPS	1575.42±2 MHz	+5 dBic zenith	Right Hand Circular	170 x 100 mm	GPS	02-47
MA-PGP15-5	Passive GPS	1575.42±2 MHz	5 dBic	Right Hand Circular	170 x 100 mm	GPS	02-48

MARS Antennas & RF Systems proprietary information

MARS reserves the right to make technical changes or modifications to any of its products and specifications without prior notice and without implementing such changes to prior supplied products. Product images are representative and indicative only. Warranty terms and general conditions of sale are applicable on any purchase of any product, available on MARS website.

3 Hamanor st. Holon 5886103, P.O.Box 1852 Holon 5811801, Israel

Tel: +972-3-5599661 • Fax: +972-3-5599677 • e-mail: mars@marsant.co.il • web: www.mars-antennas.com

## MA-WA12-9

### 1150-1375 MHz Directional Antenna

MARS directional antenna with 65° sector antenna features:

- Efficient and stable performance with 9dBi of gain.
- Compact size.
- Optional azimuth & elevation adjustable mount.
- Durable construction and light weight.
- Allowing polarization selection at the time of installation



### Specifications

#### Electrical

Frequency range	1150-1375 MHz
GAIN, typ.	9 dBi
VSWR, max.	1.7: 1
Polarization	Linear, Vertical or Horizontal
Pattern	Directional
3dB Beam Width H-plane, typ.	65°
3dB Beam Width E-plane, typ.	65°
Maximum Input Power	10W
Input Impedance	50 Ohm

#### Mechanical

Dimensions (Dia x H)	175 x 96 mm
Weight	400gr.
Connector	N-type Female
Radome	Plastic UV Protected
Mount	See Ordering Options

#### Environmental

Operating Temperature Range	-40°C to +65°C
Vibration	According to IEC 60721-3-4
Flammability	UL94
Humidity	ETS 300 019-1-4, EN 302 085 (annex A.1.1)

### Ordering Options

MA-WA12-9	Antenna Suited for MNT-23
MA-WA12-9B	Antenna with MNT-23 mount

MARS Antennas & RF Systems proprietary information

MARS reserves the right to make technical changes or modifications to any of its products and specifications without prior notice and without implementing such changes to prior supplied products. Product images are representative and indicative only. Warranty terms and general conditions of sale are applicable on any purchase of any product, available on MARS website.

3 Hamanor st. Holon 5886103, P.O.Box 1852 Holon 5811801, Israel

Tel: +972-3-5599661 • Fax: +972-3-5599677 • e-mail: mars@marsant.co.il • web: www.mars-antennas.com

## MA-WA14-1X

### 1425-1525 MHz Broadband Directional Antenna

MARS 1425-1525 MHz Antenna provides a cost effective and reliable solution for Fixed Wireless Data & Telephony Services and any other application in this band.

This panel antenna replaces Yagis previously used for the same purpose.

Additional Features:

- Durable construction and light weight.
- Optionally available with Pole Mount or MNT-22 (pole/wall, azimuth and elevation adjustable mount).
- DC Grounded.



### Specifications

#### **Electrical**

Frequency range	1425-1525 MHz
GAIN, min.	13.5 dBi
VSWR, max.	1.5 : 1
Polarization	Linear, Vertical
3 dB Beam-Width, H-Plane, typ.	31°
3 dB Beam-Width, E-Plane, typ.	31°
Side Lobes, min.	-13 dB
Cross Polarization, min.	-20 dB
Front to Back Ratio, min.	-20 dB
Input power, max.	30 Watt
Input Impedance	50 Ohm
Lightning Protection	DC Grounded

#### **Mechanical**

Dimensions (HxWxD)	305 x 305 x 25 mm (12" x 12" x 1")
Weight	1.2 kg.
Connector	N-Type, Female
Back Plane	Aluminum; protected through chemical passivation
Radome	UV Protected Polycarbonate
Mount	See Ordering Options

#### **Environmental**

Operating Temperature Range	-40°C to +65°C
Vibration	According to IEC 60721-3-4
Wind Load	200 km/h (survival)
Flammability	UL94
Water Proofing	IP-65
Humidity	ETS 300 019-1-4, EN 302 085 (annex A.1.1)
Salt Fog	According to IEC 68-2-11
Ice and Snow	25mm radial

### Ordering Options

MA-WA14-1X PM	Antenna with integral Pole Mount includes stainless steel brackets
MA-WA14-1X MNT	Antenna Suited for MNT-22 (optional wall/pole adjustable mount)
MA-WA14-1X MNTB	Antenna with MNT-22 mount

Patterns are available on our website

MARS Antennas & RF Systems proprietary information

MARS reserves the right to make technical changes or modifications to any of its products and specifications without prior notice and without implementing such changes to prior supplied products. Product images are representative and indicative only. Warranty terms and general conditions of sale are applicable on any purchase of any product, available on MARS website.

3 Hamanor st. Holon 5886103, P.O.Box 1852 Holon 5811801, Israel

Tel: +972-3-5599661 • Fax: +972-3-5599677 • e-mail: mars@marsant.co.il • web: www.mars-antennas.com

## MA-WA18-1X

### 1.8 GHz Directional Antenna

MARS 1.8 GHz Antenna is a flat panel that provides directional coverage of the GSM 1800 band. This panel antenna replaces Yagis previously used for same purpose.

Additional Features:

- Effective co-siting performance.
- Excellent size/gain ratio.
- Weatherized and robust.
- Suitable for heavy duty outdoor applications.



### Specifications

#### Electrical

Frequency range	1.71-1.88GHz
GAIN, min.	14 dBi
VSWR, max.	1.5 : 1
Polarization	Linear, Vertical
3 dB Beam-Width, H-Plane, typ.	30°
3 dB Beam-Width, E-Plane, typ.	30°
Side Lobes, min.	-12 dB
Cross Polarization, min.	-15 dB
Front to Back Ratio, min.	-20 dB
Input power, max.	50 Watt
Input Impedance	50 Ohm
Lightning Protection	DC Grounded

#### Mechanical

Dimensions (HxWxD)	305 x 305 x 25 mm (12" x 12" x 1")
Weight	1.2 kg.
Connector	N-Type, Female
Back Plane	Aluminum; protected through chemical passivation
Radome	UV Protected Polycarbonate
Mount	See ordering Options

#### Environmental

Operating Temperature Range	-40°C to +65°C
Vibration	According to IEC 60721-34
Wind Load	200 km/h (survival)
Flammability	UL94
Water Proofing	IP-67
Humidity	ETS 300 019-1-4, EN 302 085 (annex A.1.1)
Salt Fog	According to IEC 68-2-11
Ice and Snow	25mm radial (survival)

### Ordering Options

MA-WA18-1XPM	Antenna with integral Pole Mount includes stainless steel brackets
MA-WA18-1XMNT	Antenna Suited for MNT-22 (optional wall/pole adjustable mount)
MA-WA18-1XMNTB	Antenna with MNT-22 mount

Patterns are available on our website

MARS Antennas & RF Systems proprietary information

MARS reserves the right to make technical changes or modifications to any of its products and specifications without prior notice and without implementing such changes to prior supplied products. Product images are representative and indicative only. Warranty terms and general conditions of sale are applicable on any purchase of any product, available on MARS website.

3 Hamanor st. Holon 5886103, P.O.Box 1852 Holon 5811801, Israel

Tel: +972-3-5599661 • Fax: +972-3-5599677 • e-mail: mars@marsant.co.il • web: www.mars-antennas.com

## MA-WA19-4X

### 1.9 GHz Subscriber Antenna

MARS 1.9 GHz Antenna is designed for coverage of the 1.9 PCS band.

Additional Features:

- Effective co-siting performance.
- Excellent size/gain ratio.
- Weatherized and robust.
- Suitable for heavy duty outdoor applications.
- Optionally available with Pole Mount or MNT-2 (pole/wall, azimuth and elevation adjustable mount)



### Specifications

#### Electrical

Frequency range	1.85-1.99 GHz
GAIN, min.	15 dBi
VSWR, max.	1.5 : 1
Polarization	Linear, Vertical
3 dB Beam-Width, H-Plane, typ.	24°
3 dB Beam-Width, E-Plane, typ.	24°
Side Lobes, min.	-9 dB
Cross Polarization, min.	-18 dB
Front to Back Ratio, min.	-18 dB
Input power, max.	50 Watt
Input Impedance	50 Ohm
Lightning Protection	DC Grounded

#### Mechanical

Dimensions (HxWxD)	305 x 305 x 25 mm (12" x 12" x 1")
Weight	1.3 kg.
Connector	N-Type, Female
Back Plane	Aluminum; protected through chemical passivation
Radome	UV Protected Polycarbonate
Mount	See Ordering Options

#### Environmental

Operating Temperature Range	-40°C to +65°C
Vibration	According to IEC 60721-3-4
Wind Load	200 km/h (survival)
Flammability	UL94
Water Proofing	IP-67
Humidity	ETS 300 019-1-4, EN 302 085 (annex A.1.1)
Salt Fog	According to IEC 68-2-11
Ice and Snow	25mm radial (survival)

### Ordering Options

MA-WA19-4X PM	Antenna with integral Pole Mount includes stainless steel brackets
MA-WA19-4X MNT	Antenna Suited for MNT-22 (optional wall/pole adjustable mount)
MA-WA19-4X MNTB	Antenna with MNT-22 mount

Patterns are available on our website

MARS Antennas & RF Systems proprietary information

MARS reserves the right to make technical changes or modifications to any of its products and specifications without prior notice and without implementing such changes to prior supplied products. Product images are representative and indicative only. Warranty terms and general conditions of sale are applicable on any purchase of any product, available on MARS website.

3 Hamanor st. Holon 5886103, P.O.Box 1852 Holon 5811801, Israel

Tel: +972-3-5599661 • Fax: +972-3-5599677 • e-mail: mars@marsant.co.il • web: www.mars-antennas.com



## MA-WA24-2X

### 2.3-2.7 GHz Subscriber Antenna

MARS 2.4 GHz Antenna is a wide band antenna designed for LTE, Wi-Fi, LAN, MMDS, WLL and WiMAX applications.

Additional Features:

- Exceptionally efficient performance.
- High gain/size ratio.
- Aesthetic design.
- Weatherized and durable.

The antenna with the enclosure (small or large) solution is Waterproof and Weatherproof with provisions for Azimuth/Elevation Adjustable mount. This solution enables WISP/Integrator to design his own low cost, weatherized subscriber unit, saving high costs of special antenna-radio integration.



### Specifications

#### Electrical

Frequency range	2.3-2.7 GHz
GAIN, typ.	2.3-2.4 @ 17 dBi    2.4-2.7 @ 18 dBi
VSWR, max.	1.5 : 1
Polarization	Linear, Vertical (Horizontal with MNT-22 Option)
3 dB Beam-Width, H-Plane, typ.	21°
3 dB Beam-Width, E-Plane, typ.	20°
Side Lobes, min.	-16 dB
Cross Polarization, min.	-26 dB
Front to Back Ratio, min.	-26 dB
Input power, max.	30 Watt
Input Impedance	50 Ohm
Lightning Protection	DC Grounded

#### Mechanical

Dimensions (HxWxD)	305 x 305 x 15 mm (12" x 12" x 0.6")
Weight	1 kg (without Enclosure)
Connector (without enclosure)	N-Type, Female
Connector (with enclosure)	SMA Female / Pig Tail with MCX, Female (*)
Back Plane	Aluminum; protected through chemical passivation
Radome	UV Protected Polycarbonate
Enclosure - Small	171 x 167 x 68 mm. (External dimension)
Enclosure - Large	287 x 287 x 68 mm. (External dimension)
Mount	See ordering options

#### Environmental

Operating Temperature Range	-40°C to +65°C
Vibration	According to IEC 60721-3-4
Wind Load	200 km/h (survival)
Flammability	UL94
Water Proofing	IP-67
Humidity	ETS 300 019-1-4, EN 302 085 (annex A.1.1)
Salt Fog	According to IEC 68-2-11
Ice and Snow	25mm Radial

#### Standard Compliance

ETSI EN 302 085 V1.2.3 – TS1, TS2, TS3

### Ordering Options

MA-WA24-2X PM	Antenna with integral Pole Mount includes stainless steel brackets
MA-WA24-2X MNT	Antenna Suited for MNT-22 (optional wall/pole adjustable mount)
MA-WA24-2X MNTB	Antenna with MNT-22 mount
MA-WA24-2XSMESY / MA-WA24-2XMCESY	Antenna with small enclosure, SMA/pig tail Connector and MNT-22
MA-WA24-2XSMESZ / MA-WA24-2XMCESZ	Antenna with small enclosure, SMA/pig tail Connector with PEMs and MNT-22
MA-WA24-2XSMELY / MA-WA24-2XMCELY	Antenna with large enclosure, SMA/pig tail Connector and MNT-22
MA-WA24-2XSMELZ / MA-WA24-2XMCELZ	Antenna with large enclosure, SMA/pig tail Connector with PEMs and MNT-22

(\*) Can be customized with different connector configuration

Patterns are available on our website

MARS Antennas & RF Systems proprietary information

MARS reserves the right to make technical changes or modifications to any of its products and specifications without prior notice and without implementing such changes to prior supplied products. Product images are representative and indicative only. Warranty terms and general conditions of sale are applicable on any purchase of any product, available on MARS website.

3 Hamanor st. Holon 5886103, P.O.Box 1852 Holon 5811801, Israel

Tel: +972-3-5599661 • Fax: +972-3-5599677 • e-mail: mars@marsant.co.il • web: www.mars-antennas.com

## MA-WA25-20

### 2.3-2.7 GHz High Gain Subscriber Antenna

MARS 2.4 GHz Antenna is a wide band antenna designed for LTE, Wi-Fi, LAN, MMDS, WLL and WiMAX applications.

Additional Features:

- Exceptionally efficient performance.
- High gain/size ratio.
- Aesthetic design.
- Weatherized and durable.



### Specifications

#### Electrical

Frequency range	2.3-2.7 GHz
GAIN, typ.	2.3-2.5 @ 19 dBi 2.5-2.7 @ 20 dBi
VSWR, max.	1.8 : 1
Polarization	Linear, Vertical or Horizontal
3 dB Beam-Width, H-Plane, typ.	17°
3 dB Beam-Width, E-Plane, typ.	17°
Side Lobes, min.	-13 dB
Cross Polarization, min.	-20 dB
Front to Back Ratio, min.	-35 dB
Input power, max.	50 Watt
Input Impedance	50 Ohm
Lightning Protection	DC Grounded

#### Mechanical

Dimensions (HxWxD)	370 x 370 x 40 mm (14.5" x 14.5" x 1.6")
Weight	2 kg.
Connector	N-Type, Female
Back Plane	Aluminum protected through chemical passivation
Radome	UV Protected, Polycarbonate
Mount	See ordering options

#### Environmental

Operating Temperature Range	-40°C to +65°C
Vibration	According to IEC 60721-3-4
Wind Load	200 km/h (survival)
Flammability	UL94
Water Proofing	IP-65
Humidity	ETS 300 019-1-4, EN 302 085 (annex A.1.1)
Salt Fog	According to IEC 68-2-11
Ice and Snow	25mm radial (survival)

### Ordering Options

MA-WA25-20	Antenna Suited for MNT-22 (optional wall/pole adjustable mount)
MA- WA25-20B	Antenna with MNT-22 mount

Patterns are available on our website

MARS Antennas & RF Systems proprietary information

MARS reserves the right to make technical changes or modifications to any of its products and specifications without prior notice and without implementing such changes to prior supplied products. Product images are representative and indicative only. Warranty terms and general conditions of sale are applicable on any purchase of any product, available on MARS website.

3 Hamanor st. Holon 5886103, P.O.Box 1852 Holon 5811801, Israel

Tel: +972-3-5599661 • Fax: +972-3-5599677 • e-mail: mars@marsant.co.il • web: www.mars-antennas.com

## MA-WA24-12

### 2.4-2.7 GHz Small Size Subscriber Antenna

MARS 2.4 GHz Antenna is a wide band antenna designed for LTE, Wi-Fi, LAN, MMDS, WLL and WiMAX applications.

Additional Features:

- Exceptionally efficient performance.
- High gain/size ratio.
- Aesthetic design.
- Weatherized and durable.



### Specifications

#### Electrical

Frequency range	2.4-2.7 GHz
GAIN, typ.	12 dBi
VSWR, max.	1.7 : 1
Polarization	Linear, Vertical or Horizontal (See Ordering Options)
3 dB Beam-Width, H-Plane, typ.	40°
3 dB Beam-Width, E-Plane, typ.	40°
Side Lobes, min.	-13 dB
Cross Polarization, min.	-15 dB
Front to Back Ratio, min.	-16 dB
Input power, max.	10 Watt
Input Impedance	50 Ohm
Lightning Protection	DC Grounded

#### Mechanical

Dimensions (HxWxD)	155 x 155 x 28 mm (6.1" x 6.1" x 1.1")
Weight	250 gr.
Connector	See Ordering Options
Back Plane	Aluminum; protected through chemical passivation
Radome	UV Protected Polycarbonate
Mount	See ordering options

#### Environmental

Operating Temperature Range	-40°C to +65°C
Vibration	According to IEC 60721-3-4
Flammability	UL94
Water Proofing	IP-67
Humidity	ETS 300 019-1-4, EN 302 085 (annex A.1.1)

### Ordering Options

MA-WA24-12	Antenna with SMA Female Connector suited for MNT-4L or MNT-4U
MA-WA24-12BL	Antenna with SMA Female Connector and MNT-4L mount
MA-WA24-12BU	Antenna with SMA Female Connector and MNT-4U mount
MA-WA24-12NTF	Antenna with N-Type, Female Connector Suited for MNT-23 (optional wall/pole adjustable mount)
MA-WA24-12NTFB	Antenna with N-Type, Female Connector and MNT-23 mount
MA-WA24-12NTF & MNT-23H1	Antenna with N-Type, Female Connector and MNT-23H1 for horizontal polarization

Patterns are available on our website

MARS Antennas & RF Systems proprietary information

MARS reserves the right to make technical changes or modifications to any of its products and specifications without prior notice and without implementing such changes to prior supplied products. Product images are representative and indicative only. Warranty terms and general conditions of sale are applicable on any purchase of any product, available on MARS website.

3 Hamanor st. Holon 5886103, P.O.Box 1852 Holon 5811801, Israel

Tel: +972-3-5599661 • Fax: +972-3-5599677 • e-mail: mars@marsant.co.il • web: www.mars-antennas.com

## MA-WS2455-1X

### 2.4-2.5 GHz & 4.9-5.875 GHz Dual Band Antenna

MARS Dual Band antenna provides coverage of 2.4 to 2.5. GHz & 4.9 to 5.875 GHz in a single antenna radome.

Additional Features:

- Simultaneous coverage of 802.11 a,b,g, WiMAX & 4.9 GHz Public Safety Bands.
- High gain/size ratio.
- Light weight and durable construction.
- UV protected radome made of polycarbonate suitable for harsh weather installations.
- Easy mounting allowing Az/EI adjustment.



### Specifications

#### Electrical

Frequency range	2.4-2.5 GHz & 4.9-5.875 GHz
GAIN, typ.	2.4-2.5 GHz @ 12 dBi 4.9-5.875 GHz @ 18 dBi
VSWR, max.	1.7 : 1
Polarization	Linear Vertical
3 dB Beam-Width, H-Plane, typ.	2.4-2.5 GHz @ 30° 4.9-5.875 GHz @ 12°
3 dB Beam-Width, E-Plane, typ.	2.4-2.5 GHz @ 60° 4.9-5.875 GHz @ 18°
Side Lobes, max.	-10 dB
Cross Polarization, max.	-12 dB
Front to Back Ratio, min.	ETSI TS3, TS4, TS5
Input power, max.	50 Watt
Input Impedance	50 Ohm

#### Mechanical

Dimensions (HxWxD)	305 x 305 x 25 mm (12" x 12" x 1")
Connector	2 x N-Type, Female
Weight	1.5 kg.
Back Plane	Aluminum; protected through chemical passivation
Radome	UV Protected Polycarbonate
Mounting	See ordering options

#### Environmental

Operating Temperature Range	-40°C to +70°C
Vibration	According to IEC 60721-3-4
Wind Load	200 km/h (survival)
Flammability	UL94
Water Proofing	IP-67
Humidity	ETS 300 019-1-4, EN 302 085 (annex A.1.1)
Salt Fog	According to IEC 68 -2-11
Ice and Snow	25 mm radial (survival)

### Ordering Options

MA-WS2455-1X	Antenna Suited for MNT-22 (optional wall/pole adjustable mount)
MA-WS2455-1XB	Antenna with MNT-22 mount

Patterns are available on our website

MARS Antennas & RF Systems proprietary information

MARS reserves the right to make technical changes or modifications to any of its products and specifications without prior notice and without implementing such changes to prior supplied products. Product images are representative and indicative only. Warranty terms and general conditions of sale are applicable on any purchase of any product, available on MARS website.

3 Hamanor st. Holon 5886103, P.O.Box 1852 Holon 5811801, Israel

Tel: +972-3-5599661 • Fax: +972-3-5599677 • e-mail: mars@marsant.co.il • web: www.mars-antennas.com

## MA-WA22-DP8

### 1.7-2.7 GHz Dual Polarization Antenna

MARS 1.7-2.7 GHz Dual Polarized Antenna is a wide band antenna designed for LTE Wi-Fi, LAN, MMDS, WLL and WiMAX applications.

Additional Features:

- Exceptionally efficient performance.
- High gain/size ratio.
- Aesthetic design.
- Weatherized and durable.



## Specifications

### Electrical

Frequency range	1.7-2.7 GHz
Gain, typ.	8 dBi
VSWR	2.0: 1 max. 1.7: 1 typ.
Polarization	Dual Pole Dual Slant (opt.) Linear, Vertical & Horizontal ±45° (diamond shape)
3dB Beam-Width, H-Plane, typ.	75°
3dB Beam-Width, E-Plane, typ.	60°
Cross Polarization, typ.	-20 dB
Front to Back Ratio, min.	-15 dB
Port to Port Isolation, min.	-27 dB
Input power, max.	50 Watt
Input Impedance	50 Ohm
Lightning Protection	DC Grounded

### Mechanical

Dimensions (HxWxD)	112 x 112 x 33.5 mm (4.41" x 4.41" x 1.32")
Connector	2 x SMA Right Angle ,Female
Weight	147 gr.
Mounting	See Ordering Options
Radome	UV Protected Polycarbonate
Back Plane	Aluminum protected through chemical passivation.

### Environmental

Operating Temperature Range	-55°C to +65°C
Vibration	According to IEC 60721-3-4
Wind Load	200 Km/h (Survival)
Flammability	UL94
Water Proofing	IP-67
Humidity	ETS 300 019-1-4, EN 302 085 (Annex A.1.1)
Salt Fog	According to IEC 68-2-11

## Ordering Options

MA-WA22-DP8	Antenna 2 x Right Angle SMA ,Female connectors Suited for MNT-4L or 4LU mount
MA-WA22-DP8B	Antenna 2 x Right Angle SMA ,Female connectors with MNT-4L or 4LU mount

Patterns are available on our website

MARS Antennas & RF Systems proprietary information

MARS reserves the right to make technical changes or modifications to any of its products and specifications without prior notice and without implementing such changes to prior supplied products. Product images are representative and indicative only. Warranty terms and general conditions of sale are applicable on any purchase of any product, available on MARS website.

3 Hamanor st. Holon 5886103, P.O.Box 1852 Holon 5811801, Israel

Tel: +972-3-5599661 • Fax: +972-3-5599677 • e-mail: mars@marsant.co.il • web: www.mars-antennas.com

## MA-WA22-DP41

### 1.7-2.7 GHz Stadium Dual Polarization Antenna

MARS 1.7-2.7 GHz Dual Polarized wide band antenna specially designed for arenas and stadiums that have to supply high capacity and reliable wireless data.

The MA-WA22-DP14 antenna designed for LTE, Wi-Fi, LAN, MMDS, WLL and WiMAX applications.

Additional Features:

- Exceptionally efficient performance.
- High gain/size ratio.
- Aesthetic design.
- Weatherized and durable.
- Wind survival rating of 200 km/h



### Specially designed for Stadiums

## Specifications

### Electrical

Frequency range	1.7-2.2 GHz	2.2-2.7 GHz
Gain, typ.	13 dBi	14 dBi
VSWR, max.	2.0 : 1	1.7 : 1
Polarization	Dual Pole Linear, Vertical & Horizontal	
3dB Beam-Width, H-Plane, typ.	33°	
3dB Beam-Width, E-Plane, typ.	33°	
Cross Polarization, typ.	-20 dB	
Front to Back Ratio, min.	-20 dB	
Port to Port Isolation, min.	-30 dB	-40 dB
Input power, max.	50 Watt	
Input Impedance	50 Ohm	
Lightning Protection	DC Grounded	

### Mechanical

Dimensions (HxWxD)	430 x 240 x 48 mm (16.93" x 9.45" x 1.89")
Connector	2 x N-type, Female
Weight	2.5 kg.
Mounting	See Ordering Options
Radome	UV Protected Polycarbonate
Back Plane	Aluminum protected through chemical passivation.

### Environmental

Operating Temperature Range	-40°C to +65°C
Vibration	According to IEC 60721-3-4
Wind Load	200 Km/h (Survival)
Flammability	UL94
Water Proofing	IP-65
Humidity	ETS 300 019-1-4, EN 302 085 (Annex A.1.1)
Salt Fog	According to IEC 68-2-11

## Ordering Options

MA-WA22-DP14	Antenna 2 x N-type, Female connectors Suited for MNT-22 mount
MA-WA22-DP14B	Antenna 2 x N-type, Female connectors with MNT-22 mount

MARS Antennas & RF Systems proprietary information

MARS reserves the right to make technical changes or modifications to any of its products and specifications without prior notice and without implementing such changes to prior supplied products. Product images are representative and indicative only. Warranty terms and general conditions of sale are applicable on any purchase of any product, available on MARS website.

3 Hamanor st. Holon 5886103, P.O.Box 1852 Holon 5811801, Israel

Tel: +972-3-5599661 • Fax: +972-3-5599677 • e-mail: mars@marsant.co.il • web: www.mars-antennas.com

## MA-WA18-DP12

### 1750-1850 MHz Dual Polarization/ Dual Slant Subscriber Antenna

#### Additional Features:

- Dual slant if mounted diagonally.
- Efficient and stable performance.
- High gain/size ratio.
- Light weight and durable construction.
- UV protected radome made of polycarbonate suitable for harsh weather installations.
- Easy mounting allowing Az/EI adjustment and 45deg. turn installation.



## Specifications

### Electrical

Frequency range	1.75-1.85 GHz
GAIN, typ.	14 dBi
VSWR, max.	1.7 : 1
Polarization	Dual Pole Linear, Vertical & Horizontal
	Dual Slant (opt.) ±45°
3 dB Beam-Width, H-Plane, typ.	30°
3 dB Beam-Width, E-Plane, typ.	30°
Side Lobes, min.	-12 dB
Cross Polarization, min.	-15 dB
Port to Port Isolation, typ.	-25 dB
Front to Back Ratio, min.	-20 dB
Input power, max.	10 Watt
Input Impedance	50 Ohm
Lightning Protection	DC Grounded

### Mechanical

Dimensions (HxWxD)	305 x 305 x 15 mm (12" x 12" x 0.6")
Connector	2 x N-Type Female
Weight	1.3 kg.
Back Plane	Aluminum; protected through chemical passivation
Radome	UV Protected Polycarbonate
Mounting	See ordering options

### Environmental

Operating Temperature Range	-40°C to +65°C
Vibration	According to IEC 60721-3-4
Wind Load	200 km/h (Survival)
Flammability	UL94
Water Proofing	IP-67
Humidity	ETS 300 019-1-4, EN 302 085 (Annex A.1.1)
Salt Fog	According to IEC 68-2-11

## Ordering Options

MA-WA18-DP12	Antenna Suited for MNT-22 (optional wall/pole adjustable mount)
MA-WA18-DP12B	Antenna with MNT-22 mount

Patterns are available on our website

MARS Antennas & RF Systems proprietary information

MARS reserves the right to make technical changes or modifications to any of its products and specifications without prior notice and without implementing such changes to prior supplied products. Product images are representative and indicative only. Warranty terms and general conditions of sale are applicable on any purchase of any product, available on MARS website.

3 Hamanor st. Holon 5886103, P.O.Box 1852 Holon 5811801, Israel

Tel: +972-3-5599661 • Fax: +972-3-5599677 • e-mail: mars@marsant.co.il • web: www.mars-antennas.com

## MA-WA18-DP18

### 1750-1850 MHz Dual Polarization/ Dual Slant Subscriber Antenna

#### Additional Features:

- Dual slant if mounted diagonally.
- Efficient and stable performance.
- High gain/size ratio.
- Light weight and durable construction.
- UV protected radome made of polycarbonate suitable for harsh weather installations.
- Easy mounting allowing Az/EI adjustment and 45deg. turn installation.



## Specifications

### Electrical

Frequency range	1.75-1.85 GHz
GAIN, typ.	17 dBi
VSWR, max.	1.7 : 1
Polarization	Dual Pole, Vertical & Horizontal
3 dB Beam-Width, H-Plane, typ.	23°
3 dB Beam-Width, E-Plane, typ.	23°
Side Lobes, min.	-12 dB
Cross Polarization, min.	-15 dB
Port to Port Isolation, typ.	-25 dB
Front to Back Ratio, min.	-20 dB
Input power, max.	10 Watt
Input Impedance	50 Ohm
Lightning Protection	DC Grounded

### Mechanical

Dimensions (HxWxD)	370 x 370 x 40 mm (14.6" x 14.6" x 1.5")
Connector	2 x N-Type Female
Weight	2.1 kg.
Back Plane	Aluminum; protected through chemical passivation
Radome	UV Protected Polycarbonate
Mounting	See ordering options

### Environmental

Operating Temperature Range	-40°C to +65°C
Vibration	According to IEC 60721-3-4
Wind Load	200 km/h (Survival)
Flammability	UL94
Water Proofing	IP-67
Humidity	ETS 300 019-1-4, EN 302 085 (Annex A.1.1)
Salt Fog	According to IEC 68-2-11

## Ordering Options

MA-WA18-DP18	Antenna Suited for MNT-22 (optional wall/pole adjustable mount)
MA-WA18-DP18B	Antenna with MNT-22 mount

Patterns are available on our website

MARS Antennas & RF Systems proprietary information

MARS reserves the right to make technical changes or modifications to any of its products and specifications without prior notice and without implementing such changes to prior supplied products. Product images are representative and indicative only. Warranty terms and general conditions of sale are applicable on any purchase of any product, available on MARS website.

3 Hamanor st. Holon 5886103, P.O.Box 1852 Holon 5811801, Israel

Tel: +972-3-5599661 • Fax: +972-3-5599677 • e-mail: mars@marsant.co.il • web: www.mars-antennas.com



## MA-WA25-DP9

### 2.3-2.7 GHz Dual Polarization Antenna

MARS 2.5 GHz Dual Polarized Antenna is a wide band antenna designed for LTE, Wi-Fi, LAN, MMDS, WLL and WiMAX applications.

Additional Features:

- Exceptionally efficient performance.
- High gain/size ratio.
- Aesthetic design.
- Weatherized and durable.



## Specifications

### Electrical

Frequency range	2.3-2.7 GHz
GAIN	8±1 dBi
VSWR, max.	1.7 : 1
Polarization	Dual Pole Dual Slant (opt.)
	Linear, Vertical & Horizontal ±45° (diamond shape)
3dB Beam-Width, H-Plane, typ.	60°
3dB Beam-Width, E-Plane, typ.	60°
Side Lobes, min.	-15dB
Front to Back Ratio, min.	-15dB
Input power, max.	50 Watt
Input Impedance	50 Ohm

### Mechanical

Dimensions (HxWxD)	112 x 112 x 33.5 mm (4.41" x 4.41" x 1.32")
Connector	2 x Right Angle SMA ,Female
Weight	147 gr.
Mounting	See Ordering Options
Radome	UV Protected Polycarbonate
Back Plane	Aluminum protected through chemical passivation.

### Environmental

Operating Temperature Range	-55°C to +65°C
Vibration	According to IEC 60721-3-4
Wind Load	200 Km/h (Survival)
Flammability	UL94
Water Proofing	IP-67
Humidity	ETS 300 019-1-4, EN 302 085 (Annex A.1.1)
Salt Fog	According to IEC 68-2-11

## Ordering Options

MA-WA25-DP9	Antenna 2 x Right Angle SMA ,Female connectors Suited for MNT-4LU mount
MA-WA25-DP9B	Antenna 2 x Right Angle SMA ,Female connectors with MNT-4LU mount

Patterns are available on our website

MARS Antennas & RF Systems proprietary information

MARS reserves the right to make technical changes or modifications to any of its products and specifications without prior notice and without implementing such changes to prior supplied products. Product images are representative and indicative only. Warranty terms and general conditions of sale are applicable on any purchase of any product, available on MARS website.

3 Hamanor st. Holon 5886103, P.O.Box 1852 Holon 5811801, Israel

Tel: +972-3-5599661 • Fax: +972-3-5599677 • e-mail: mars@marsant.co.il • web: www.mars-antennas.com

## MA-WA25-DP14

### 2.3-2.7 GHz Dual Polarization/ Dual Slant Subscriber Antenna

MARS 2.3-2.7 GHz Dual Polarized Antenna designed to provide full coverage for the 2.5 GHz frequency band.

Additional Features:

- Dual slant if mounted diagonally.
- Efficient and stable performance.
- High gain/size ratio.
- Light weight and durable construction.
- UV protected radome made of polycarbonate suitable for harsh weather installations.
- Easy mounting allowing Az/EI adjustment and 45deg. turn installation.



### Specifications

#### Electrical

Frequency range	2.3-2.7 GHz
GAIN, typ.	14 dBi
VSWR, max.	1.7 : 1
Polarization	Dual Pole Dual Slant (opt.)
	Linear, Vertical & Horizontal ±45° (diamond shape)
3 dB Beam-Width, H-Plane, typ.	33°
3 dB Beam-Width, E-Plane, typ.	33°
Side Lobes	ETSI DN4
Cross Polarization	ETSI DN4
Port to Port Isolation, typ.	-25 dB
Front to Back Ratio	ETSI DN4
Input power, max.	10 Watt
Input Impedance	50 Ohm

#### Mechanical

Dimensions (HxWxD)	200 x 200 x 33 mm (7.9" x 7.9" x 1.25")
Connector	See ordering options
Weight	400 gr.
Back Plane	Aluminum; protected through chemical passivation
Radome	UV Protected Polycarbonate
Mounting	See ordering options

#### Environmental

Operating Temperature Range	-55°C to +65°C
Vibration	According to IEC 60721-3-4
Wind Load	200 km/h (Survival)
Flammability	UL94
Water Proofing	IP-67
Humidity	ETS 300 019-1-4, EN 302 085 (Annex A.1.1)
Salt Fog	According to IEC 68-2-11

### Ordering Options

MA-WA25-DP14	Antenna 2 x N-Type Female connectors Suited for MNT-23 mount
MA-WA25-DP14B	Antenna 2 x N-Type Female connectors with MNT-23 mount
MA-WA25-DP14SMES	Antenna 2 x SMA RA Female connectors, enclosure with MNT-22 mount

Patterns are available on our website

MARS Antennas & RF Systems proprietary information

MARS reserves the right to make technical changes or modifications to any of its products and specifications without prior notice and without implementing such changes to prior supplied products. Product images are representative and indicative only. Warranty terms and general conditions of sale are applicable on any purchase of any product, available on MARS website.

3 Hamanor st. Holon 5886103, P.O.Box 1852 Holon 5811801, Israel

Tel: +972-3-5599661 • Fax: +972-3-5599677 • e-mail: mars@marsant.co.il • web: www.mars-antennas.com

## MA-WA25-DP17

### 2.3-2.7 GHz Dual Polarization/Dual Slant Subscriber Antenna

MARS 2.5 GHz Dual Polarized Antenna is a wide band antenna designed for LTE, Wi-Fi, LAN, MMDS, WLL and WiMAX applications.

Additional Features:

- Exceptionally efficient performance.
- High gain/size ratio.
- Aesthetic design.
- Weatherized and durable.



## Specifications

### Electrical

Frequency range	2.3-2.7 GHz
GAIN, typ.	17.5 ± 1 dBi
VSWR, max.	1.7 : 1
Polarization	Dual Pole Dual Slant (opt.)
	Linear, Vertical & Horizontal ±45° (diamond shape)
3dB Beam-Width, H-Plane, typ.	21°
3dB Beam-Width, E-Plane, typ.	21°
Side Lobes, typ.	-12 dB
Cross Polarization, typ.	-20 dB
Front to Back Ratio, min.	-35 dB
Port to Port Isolation, min.	-23 dB
Input power, max.	50 Watt
Input Impedance	50 Ohm
Lightning Protection	DC Grounded

### Mechanical

Dimensions (HxWxD)	305 x 305 x 25 mm (12" x 12" x 1.2")
Connector (without enclosure)	2 x N-Type, Female
Connector (with enclosure)	2 x SMA
Weight	1300 gr.
Mounting	See ordering options
Radome	UV Protected Polycarbonate
Enclosure - Small	171 x 167 x 68 mm. (External dimension)
Back Plane	Aluminum protected through chemical passivation.

### Environmental

Operating Temperature Range	-55°C to +65°C
Vibration	According to IEC 60721-3-4
Wind Load	200 Km/h (Survival)
Flammability	UL94
Water Proofing	IP-67
Humidity	ETS 300 019-1-4, EN 302 085 (Annex A.1.1)
Salt Fog	According to IEC 68-2-11

## Ordering Options

MA-WA25-DP17	Antenna 2 x N-Type Female connectors Suited for MNT-22 mount
MA-WA25-DP17B	Antenna 2 x N-Type Female connectors with MNT-22 mount
MA-WA25-DP17SMES	Antenna 2 x SMA Female connectors, enclosure small with MNT-22 mount

Patterns are available on our website

MARS Antennas & RF Systems proprietary information

MARS reserves the right to make technical changes or modifications to any of its products and specifications without prior notice and without implementing such changes to prior supplied products. Product images are representative and indicative only. Warranty terms and general conditions of sale are applicable on any purchase of any product, available on MARS website.

3 Hamanor st. Holon 5886103, P.O.Box 1852 Holon 5811801, Israel

Tel: +972-3-5599661 • Fax: +972-3-5599677 • e-mail: mars@marsant.co.il • web: www.mars-antennas.com

## MA-WA25-DP19

### 2.3-2.7 GHz Dual Polarized/ Dual Slant Antenna

MARS 2.5 GHz Dual Polarized Antenna is a wide band antenna designed for LTE, Wi-Fi, LAN, MMDS, WLL and WiMAX applications.

Additional Features:

- Dual slant if mounted diagonally.
- Exceptionally efficient performance.
- High gain/size ratio.
- Aesthetic design.
- Weatherized and durable.
- Mount allows 45deg. turn installation.



### Specifications

#### Electrical

Frequency range	2.3-2.7 GHz
GAIN, typ.	19 ± 1 dBi
VSWR, max.	1.7 : 1
Polarization	Dual Pole Dual Slant (opt.)
	Linear, Vertical & Horizontal ±45°
3 dB Beam-Width, H-Plane, typ.	17°
3 dB Beam-Width, E-Plane, typ.	17°
Side Lobes, min.	-12 dB
Cross Polarization, min.	-19 dB
Port to Port Isolation, typ.	-25 dB
Front to Back Ratio, min.	-30 dB
Input power, max.	10 Watt
Input Impedance	50 Ohm
Lightning Protection	DC Grounded

#### Mechanical

Dimensions (HxWxD)	370 x 370 x 40 mm (14.5" x 14.5" x 1.6")
Weight	2 kg.
Connector	2 x N-Type Female
Back Plane	Aluminum; protected through chemical passivation
Radome	UV Protected, Polycarbonate
Mount	See ordering options

#### Environmental

Operating Temperature Range	-40°C to +65°C
Vibration	According to IEC 60721-3-4
Wind Load	200 km/h (Survival)
Flammability	UL94
Water Proofing	IP-67
Humidity	ETS 300 019-1-4, EN 302 085 (Annex A.1.1)
Salt Fog	According to IEC 68-2-11

### Ordering Options

MA-WA25-DP19	Antenna Suited for MNT-22 (optional wall/pole adjustable mount)
MA-WA25-DP19B	Antenna with MNT-22 mount
MA-WA25-DP19SMELZ	Antenna with large enclosure, 2 X SMA Connectors with PEMs and MNT-22

Patterns are available on our website

MARS Antennas & RF Systems proprietary information

MARS reserves the right to make technical changes or modifications to any of its products and specifications without prior notice and without implementing such changes to prior supplied products. Product images are representative and indicative only. Warranty terms and general conditions of sale are applicable on any purchase of any product, available on MARS website.

3 Hamanor st. Holon 5886103, P.O.Box 1852 Holon 5811801, Israel

Tel: +972-3-5599661 • Fax: +972-3-5599677 • e-mail: mars@marsant.co.il • web: www.mars-antennas.com

## MA-WA25-DP23

### 2.3-2.7 GHz Dual Polarization/Dual Slant Subscriber Antenna

MARS 2.5 GHz Dual Polarized Antenna is a wide band antenna designed for LTE, Wi-Fi, LAN, MMDS, WLL and WiMAX applications.

Additional Features:

- Exceptionally efficient performance.
- High gain/size ratio.
- Aesthetic design.
- Weatherized and durable.



## Specifications

### Electrical

Frequency range	2.3-2.7 GHz
GAIN, typ.	23 ± 1 dBi
VSWR, max.	1.7 : 1
Polarization	Dual Pole Dual Slant (opt.)
	Linear, Vertical & Horizontal ±45° (diamond shape)
3dB Beam-Width, H-Plane, typ.	10°
3dB Beam-Width, E-Plane, typ.	10°
Side Lobes, min.	-12dB
Cross Polarization, min.	-25dB
Front to Back Ratio, min.	-35dB
Port to Port Isolation, min.	-30dB
Input power, max.	50 Watt
Input Impedance	50 Ohm
Lightning Protection	DC Grounded

### Mechanical

Dimensions (HxWxD)	600 x 600 x 30 mm (23.5" x 23.5" x 1.2")
Connector	2 x N-Type ,Female
Weight	4.7kg.
Mounting	See ordering options
Radome	UV Protected Polycarbonate
Back Plane	Aluminum protected through chemical passivation.

### Environmental

Operating Temperature Range	-55°C to +65°C
Vibration	According to IEC 60721-3-4
Wind Load	200 Km/h (Survival)
Flammability	UL94
Water Proofing	IP-67
Humidity	ETS 300 019-1-4, EN 302 085 (Annex A.1.1)
Salt Fog	According to IEC 68-2-11

## Ordering Options

MA-WA25-DP23	Antenna 2 x N-Type Female connectors Suited for MNT-60A mount
MA-WA25-DP23B	Antenna 2 x N-Type Female connectors with MNT-60A mount

Patterns are available on our website

MARS Antennas & RF Systems proprietary information

MARS reserves the right to make technical changes or modifications to any of its products and specifications without prior notice and without implementing such changes to prior supplied products. Product images are representative and indicative only. Warranty terms and general conditions of sale are applicable on any purchase of any product, available on MARS website.

3 Hamanor st. Holon 5886103, P.O.Box 1852 Holon 5811801, Israel

Tel: +972-3-5599661 • Fax: +972-3-5599677 • e-mail: mars@marsant.co.il • web: www.mars-antennas.com

## MA-WA24-TPMIMO

### 2.3-2.7 GHz Triple Polarization MIMO Subscriber Antenna

MARS Triple Polarization antenna provides coverage of 2.3-2.7 GHz frequency band in a single antenna radome.

Additional Features:

- Specially designed for MIMO applications.
- Light weight and durable construction.
- UV protected radome made of polycarbonate.
- Can be customized with customer defined back plane and different connector configurations.



## Specifications

### Electrical

Frequency range	2.3-2.7 GHz
GAIN	Vertical Pol. 15 ± 1 dBi
	Dual Slant Pol. 12 ± 1dBi
VSWR, max.	1.7 : 1
Polarization	Dual Slant ±45° and Vertical
3 dB Beam-Width-Azimuth, typ.	Dual Slant: 38°; V- Pol 37°
3 dB Beam-Width-Elevation, typ.	Dual Slant: 38°; V- Pol 21°
Side Lobes, min.	-12 dB
Front to Back Ratio, min.	-30 dB
Input power, max.	10 Watt
Input Impedance	50 Ohm
Lightning Protection	DC Grounded

### Mechanical

Dimensions (HxWxD)	305 x 305 x 15 mm (12" x 12" x 0.6")
Connector	3 x N-Type Female
Weight	1.5 Kg.
Mounting	See ordering options
Radome	UV Protected Polycarbonate
Back Plane	Aluminum protected through chemical passivation

### Environmental

Operating Temperature Range	-40°C to +65°C
Vibration	According to IEC 60721-3-4
Wind Load	200 Km/h (Survival)
Flammability	UL94
Water Proofing	IP-67
Humidity	ETS 300 019-1-4, EN 302 085 (Annex A.1.1)
Salt Fog	According to IEC 68-2-11

## Ordering Options

MA-WA24-TPMIMO	Antenna Suited for MNT-22 (optional wall/pole adjustable mount)
MA-WA24-TPMIMOB	Antenna with MNT-22 mount

Patterns are available on our website

MARS Antennas & RF Systems proprietary information

MARS reserves the right to make technical changes or modifications to any of its products and specifications without prior notice and without implementing such changes to prior supplied products. Product images are representative and indicative only. Warranty terms and general conditions of sale are applicable on any purchase of any product, available on MARS website.

3 Hamanor st. Holon 5886103, P.O.Box 1852 Holon 5811801, Israel

Tel: +972-3-5599661 • Fax: +972-3-5599677 • e-mail: mars@marsant.co.il • web: www.mars-antennas.com

## MA-WA2455-QPMIMO

### 5.15 - 5.875 GHz & 2.3 - 2.7 GHz Quad Polarizations MIMO

MARS Quad Polarization antenna provides coverage of 2.3-2.7 GHz frequency

Band and 5.15-5.875 GHz frequency band in a single antenna radome.

Additional Features:

- Specially designed for MIMO applications
- Light weight and durable construction.
- UV Protected radome made of Polycarbonate.



Can be customized per customer requirements

### 802.11 ac standard applications approved

#### Specifications

##### Electrical

Frequency range	2.3 - 2.7 GHz & 5.15-5.875 GHz
GAIN, typ.	Vertical & Horizontal Pol 16 dBi @ 5.15 - 5.875 GHz Dual Slant Pol. $\pm 45^\circ$ 12 dBi @ 2.3 - 2.7 GHz
VSWR, max.	1.7 : 1
Polarization	Quad Pole Vertical, Horizontal@5.15-5.875 GHz & Dual Slant@ 2.3 - 2.7 GHz
3 dB Beam-Width, Azimuth, typ.	Dual Slant: $38^\circ$ ; V & H Pol @ $20^\circ$
3 dB Beam-Width, Elevation, typ.	Dual Slant: $38^\circ$ ; V & H Pol @ $20^\circ$
Side Lobes, min.	-12 dB
Front to Back Ratio, min.	-30 dB
Isolation Between Bands	-30 dB
Input power, max	10 Watt
Input Impedance	50 Ohm
Lightning Protection	DC Grounded

##### Mechanical

Dimensions (HxWxD)	305 x 305 x 15 mm.
Connector	4 x N-Type
Weight	1.5 Kg.
Mounting	See Ordering Options
Radome	UV Protected Polycarbonate
Back Plane	Aluminum protected through chemical passivation.

##### Environmental

Operating Temperature Range	-40°C to +65°C
Vibration	According to IEC 60721-3-4
Wind Load	200 Km/h (Survival)
Flammability	UL94
Water Proofing	IP-67
Humidity	ETS 300 019-1-4, EN 302 085 (Annex A.1.1)
Salt Fog	According to IEC 68-2-11

#### Ordering Options

MA- WA2455-QPMIMO	Antenna 4 x N-Type connectors Suited for MNT-22 mount
MA- WA2455-QPMIMOB	Antenna 4 x N-Type connectors with MNT-22 mount

MARS Antennas & RF Systems proprietary information

MARS reserves the right to make technical changes or modifications to any of its products and specifications without prior notice and without implementing such changes to prior supplied products. Product images are representative and indicative only. Warranty terms and general conditions of sale are applicable on any purchase of any product, available on MARS website.

3 Hamanor st. Holon 5886103, P.O.Box 1852 Holon 5811801, Israel

Tel: +972-3-5599661 • Fax: +972-3-5599677 • e-mail: mars@marsant.co.il • web: www.mars-antennas.com

## MA-WA25-QP4MIMO14

### 2.3-2.7 GHz Quad Polarization 4X4 MIMO Subscriber Antenna

MARS Quad Polarization antenna provides coverage of 2.3-2.7 GHz frequency Band.

Additional Features:

- Specially designed for MIMO applications
- Light weight and durable construction.
- UV Protected radome made of Polycarbonate.



### Specifications

#### Electrical

Frequency range	2.3-2.7 GHz
GAIN, typ.	4 x 13.5 dBi
VSWR, max.	1.7 : 1
Polarizations	Dual Pole V&H and Dual Slant $\pm 45^\circ$
3 dB Beam-Width, H-Plane, typ.	33°
3 dB Beam-Width, E-Plane, typ.	33°
Side Lobes, typ.	-12 dB
Cross Polarization, typ.	-20 dB
Front to Back Ratio, typ.	-30 dB
Port to Port Isolation, typ.	-25 dB
Input power, max.	10 Watt
Input Impedance	50 Ohm
Lightning Protection	DC Grounded

#### Mechanical

Dimensions (HxWxD)	370 x 370 x 40 mm (14.5" x14.5" x1.6")
Weight	2 kg
Connector	4 x N-Type, Female
Back Plane	Aluminum protected through chemical passivation
Radome	UV Protected, Polycarbonate
Mount	See Ordering Options

#### Environmental

Operating Temperature Range	-40°C to +65°C
Vibration	According to IEC 60721-3-4
Wind Load	200 km/h (survival)
Flammability	UL94
Water Proofing	IP-67
Humidity	ETS 300 019-1-4, EN 302 085 (annex A.1.1)
Salt Fog	According to IEC 68-2-11

### Ordering Options

MA-WA25-QP4MIMO14	Antenna Suited for MNT-22
MA-WA25-QP4MIMO14B	Antenna with MNT-22 mount

MARS Antennas & RF Systems proprietary information

MARS reserves the right to make technical changes or modifications to any of its products and specifications without prior notice and without implementing such changes to prior supplied products. Product images are representative and indicative only. Warranty terms and general conditions of sale are applicable on any purchase of any product, available on MARS website.

3 Hamanor st. Holon 5886103, P.O.Box 1852 Holon 5811801, Israel

Tel: +972-3-5599661 • Fax: +972-3-5599677 • e-mail: mars@marsant.co.il • web: www.mars-antennas.com



## MA-WC24-14

### 2.3-2.7 GHz Base Station Antenna, 60°

MARS 60° Base Station Antenna with 14 dBi of gain is light-weight yet has a robust and durable construction.

Antenna Features:

- Quick and easy installation.
- Small, aesthetic and unobtrusive radome.
- Easily adapted to any RF connector
- Easy mounting allows obtaining required down tilt degree.

Applications:

- Point-to-Multi-Point Systems.
- WLL applications.
- MMDS.
- ISM applications.



## Specifications

### Electrical

Frequency range	2.3-2.7 GHz
GAIN, min.	14 dBi
VSWR, max.	1.7 : 1
Polarization	Linear, Vertical
3 dB Beam-Width, H-Plane, typ.	60°
3 dB Beam-Width, E-Plane, typ.	14°
Side Lobes, min.	-12 dB
Cross Polarization, min.	-22 dB
Front to Back Ratio, min.	-22 dB
Input power, max.	50 Watt
Input Impedance	50 Ohm
Lightning Protection	DC Grounded

### Mechanical

Dimensions (HxWxD)	380 x 150 x 80 mm (15" x 5.9" x 3.1" - including side wings)
Weight	0.5 kg.
Connector	N-Type, Female
Back Plane	Aluminum protected through chemical passivation
Radome	UV Protected, Plastic
Mount	See ordering options

### Environmental

Operating Temperature Range	-40°C to +65°C
Vibration	According to IEC 60721-3-4
Wind Load	200 km/h (survival)
Flammability	UL94
Water Proofing	IP-65
Humidity	ETS 300 019-1-4, EN 302 085 (annex A.1.1)
Salt Fog	According to IEC 68-2-11
Ice and Snow	25mm radial (survival)

## Ordering Options

MA-WC24-14	Antenna Suited for MNT-22 (optional wall/pole adjustable mount)
MA-WC24-14B	Antenna with MNT-22 mount

Patterns are available on our website

MARS Antennas & RF Systems proprietary information

MARS reserves the right to make technical changes or modifications to any of its products and specifications without prior notice and without implementing such changes to prior supplied products. Product images are representative and indicative only. Warranty terms and general conditions of sale are applicable on any purchase of any product, available on MARS website.

3 Hamanor st. Holon 5886103, P.O.Box 1852 Holon 5811801, Israel

Tel: +972-3-5599661 • Fax: +972-3-5599677 • e-mail: mars@marsant.co.il • web: www.mars-antennas.com

**MA-WD24-13**

**2.3-2.7 GHz Base Station Antenna, 90°**

MARS 90° Base Station Antenna has a lightweight and durable construction.

Additional Features:

- Compact Size.
- Quick and easy installation.
- Adjustable Tilt (with optional mount MNT-22).

Applications:

- Point-to-Multi-Point Applications.
- WLL Applications.
- MMDS.
- ISM Applications.



**Specifications**

**Electrical**

Frequency range	2.3-2.7 GHz
GAIN, min.	13 dBi
VSWR, max.	1.7 : 1
Polarization	Linear, Vertical
3 dB Beam-Width, H-Plane, typ.	90°
3 dB Beam-Width, E-Plane, typ.	15°
Side Lobes, min.	-12 dB
Cross Polarization, min.	-22 dB
Front to Back Ratio, min.	-20 dB
Input power, max.	50 Watt
Input Impedance	50 Ohm
Lightning Protection	DC Grounded

**Mechanical**

Dimensions (HxWxD)	380 x 75 x 80 mm (15" x 3" x 3.1")
Weight	0.5 kg.
Connector	N-Type, Female
Back Plane	Aluminum protected through chemical passivation
Radome	UV Protected, Plastic
Mount	See ordering options

**Environmental**

Operating Temperature Range	-40°C to +65°C
Vibration	According to IEC 60721-3-4
Wind Load	200 km/h (survival)
Flammability	UL94
Water Proofing	IP-65
Humidity	ETS 300 019-1-4, EN 302 085 (annex A.1.1)
Salt Fog	According to IEC 68-2-11
Ice and Snow	25mm radial (survival)

**Ordering Options**

MA-WD24-13	Antenna Suited for MNT-22 (optional wall/pole adjustable mount)
MA-WD24-13B	Antenna with MNT-22 mount

Patterns are available on our website

MARS Antennas & RF Systems proprietary information

MARS reserves the right to make technical changes or modifications to any of its products and specifications without prior notice and without implementing such changes to prior supplied products. Product images are representative and indicative only. Warranty terms and general conditions of sale are applicable on any purchase of any product, available on MARS website.

3 Hamanor st. Holon 5886103, P.O.Box 1852 Holon 5811801, Israel

Tel: +972-3-5599661 • Fax: +972-3-5599677 • e-mail: mars@marsant.co.il • web: www.mars-antennas.com

## MA-WE24-11

### 2.3-2.7 GHz Base Station Antenna, 120°

MARS 120° Base Station Antenna has a lightweight and durable construction.

Additional Features:

- Compact Size.
- Quick and easy installation.
- Adjustable Tilt (with optional mount MNT-22).

Applications:

- Point-to-Multi-Point Applications.
- WLL Applications.
- MMDS.
- ISM Applications.



## Specifications

### Electrical

Frequency range	2.3-2.7 GHz
GAIN, typ.	11.5 dBi
VSWR, max.	1.7 : 1
Polarization	Linear, Vertical
3 dB Beam-Width, H-Plane, typ.	120°
3 dB Beam-Width, E-Plane, typ.	15°
Side Lobes, min.	-12 dB
Cross Polarization, min.	-22 dB
Front to Back Ratio, min.	-17 dB
Input power, max.	50 Watt
Input Impedance	50 Ohm
Lightning Protection	DC Grounded

### Mechanical

Dimensions (HxWxD)	380 x 75 x 80 mm (15" x 3" x 3.1")
Weight	0.5 kg.
Connector	N-Type, Female
Back Plane	Aluminum protected through chemical passivation
Radome	UV Protected, Plastic
Mount	See ordering options

### Environmental

Operating Temperature Range	-40°C to +65°C
Vibration	According to IEC 60721-3-4
Wind Load	200 km/h (survival)
Flammability	UL94
Water Proofing	IP-65
Humidity	ETS 300 019-1-4, EN 302 085 (annex A.1.1)
Salt Fog	According to IEC 68-2-11
Ice and Snow	25mm radial (survival)

## Ordering Options

MA-WE24-11	Antenna Suited for MNT-22 (optional wall/pole adjustable mount)
MA-WE24-11B	Antenna with MNT-22 mount

Patterns are available on our website

MARS Antennas & RF Systems proprietary information

MARS reserves the right to make technical changes or modifications to any of its products and specifications without prior notice and without implementing such changes to prior supplied products. Product images are representative and indicative only. Warranty terms and general conditions of sale are applicable on any purchase of any product, available on MARS website.

3 Hamanor st. Holon 5886103, P.O.Box 1852 Holon 5811801, Israel

Tel: +972-3-5599661 • Fax: +972-3-5599677 • e-mail: mars@marsant.co.il • web: www.mars-antennas.com

## MA-WC24-17

### 2.3-2.7 GHz Base Station Antenna, 60°

MARS 60° Base Station Antenna with 17 dBi of gain is light-weight yet has a robust and durable construction.

Antenna Features:

- Quick and easy installation.
- Small, aesthetic and unobtrusive radome.
- Easily adapted to any RF connector.
- Easy mounting allowing obtaining required down tilt degree.

Applicable Applications:

- Point-to-Multi-Point Systems.
- WLL applications.
- MMDS.
- ISM applications.



### Specifications

#### Electrical

Frequency range	2.3-2.7 GHz
GAIN, typ.	17 dBi
VSWR, max.	1.7 : 1
Polarization	Linear, Vertical
3 dB Beam-Width, H-Plane, typ.	60°
3 dB Beam-Width, E-Plane, typ.	8°
Side Lobes, min.	-13 dB
Cross Polarization, min.	-20 dB
Front to Back Ratio, min.	-24 dB
Input power, max.	50 Watt
Input Impedance	50 Ohm
Lightning Protection	DC Grounded

#### Mechanical

Dimensions (HxWxD)	800 x 120 x 65 mm (31.5" x 4.7" x 2.6")
Weight	1.2 kg.
Connector	N-Type, Female
Back Plane	Aluminum protected through chemical passivation
Radome	UV Protected, Plastic
Mount	See ordering options

#### Environmental

Operating Temperature Range	-40°C to +65°C
Vibration	According to IEC 60721-3-4
Wind Load	200 km/h (survival)
Flammability	UL94
Water Proofing	IP-65
Humidity	ETS 300 019-1-4, EN 302 085 (annex A.1.1)
Salt Fog	According to IEC 68-2-11
Ice and Snow	25mm radial (survival)

#### Standard Compliance

ETSI EN 301 525 v1.1.1

### Ordering Options

MA-WC24-17	Antenna Suited for MNT-5A (optional wall/pole adjustable mount)
MA-WC24-17B	Antenna with MNT-5A mount

Patterns are available on our website

MARS Antennas & RF Systems proprietary information

MARS reserves the right to make technical changes or modifications to any of its products and specifications without prior notice and without implementing such changes to prior supplied products. Product images are representative and indicative only. Warranty terms and general conditions of sale are applicable on any purchase of any product, available on MARS website.

3 Hamanor st. Holon 5886103, P.O.Box 1852 Holon 5811801, Israel

Tel: +972-3-5599661 • Fax: +972-3-5599677 • e-mail: mars@marsant.co.il • web: www.mars-antennas.com

## MA-WD24-15

### 2.3-2.7 GHz Base Station Antenna, 90°

MARS 90° Base Station Antenna with 15.5 dBi of gain is light-weight yet has a robust and durable construction.

Antenna Features:

- Quick and easy installation.
- Small, aesthetic and unobtrusive radome.
- Easily adapted to any RF connector.
- Easy mounting allowing obtaining required down tilt degree.

Applicable Applications:

- Point-to-Multi-Point Systems.
- WLL applications.
- MMDS.
- ISM applications.



### Specifications

#### Electrical

Frequency range	2.3-2.7 GHz
GAIN, typ.	15.5 dBi
VSWR, max.	1.7 : 1
Polarization	Linear, Vertical
3 dB Beam-Width, H-Plane, typ.	90°
3 dB Beam-Width, E-Plane, typ.	8°
Side Lobes, min.	-13 dB
Cross Polarization, min.	-20 dB
Front to Back Ratio, min.	-24 dB
Input power, max.	50 Watt
Input Impedance	50 Ohm
Lightning Protection	DC Grounded

#### Mechanical

Dimensions (HxWxD)	800 x 120 x 65 mm (31.5" x 4.7" x 2.6")
Weight	1.2 kg.
Connector	N-Type, Female
Back Plane	Aluminum protected through chemical passivation
Radome	UV Protected, Plastic
Mount	MNT-5A

#### Environmental

Operating Temperature Range	-40°C to +65°C
Vibration	According to IEC 60721-3-4
Wind Load	200 km/h (survival)
Flammability	UL94
Water Proofing	IP-65
Humidity	ETS 300 019-1-4, EN 302 085 (annex A.1.1)
Salt Fog	According to IEC 68-2-11
Ice and Snow	25mm radial (survival)

#### Standard Compliance

ETSI EN 301 525 v1.1.1

### Ordering Options

MA-WD24-15	Antenna Suited for MNT-5A (optional wall/pole adjustable mount)
MA-WD24-15B	Antenna with MNT-5A mount

Patterns are available on our website

MARS Antennas & RF Systems proprietary information

MARS reserves the right to make technical changes or modifications to any of its products and specifications without prior notice and without implementing such changes to prior supplied products. Product images are representative and indicative only. Warranty terms and general conditions of sale are applicable on any purchase of any product, available on MARS website.

3 Hamanor st. Holon 5886103, P.O.Box 1852 Holon 5811801, Israel

Tel: +972-3-5599661 • Fax: +972-3-5599677 • e-mail: mars@marsant.co.il • web: www.mars-antennas.com

## MA-WE24-14

### 2.3-2.7 GHz Base Station Antenna, 120°

MARS 120° Base Station Antenna with 14.5 dBi of gain is light-weight yet has a robust and durable construction. Available also for heavy duty.

Antenna Features:

- Quick and easy installation.
- Small, aesthetic and unobtrusive radome.
- Easily adapted to any RF connector.
- Easy mounting allowing obtaining required down tilt degree.

Applicable Applications:

- Point-to-Multi-Point Systems
- For WLL applications
- MMDS
- ISM applications



### Specifications

#### Electrical

Frequency range	2.3-2.7 GHz
GAIN, typ.	14.5 dBi
VSWR, max.	1.7 : 1
Polarization	Linear, Vertical
3 dB Beam-Width, H-Plane, typ.	120°
3 dB Beam-Width, E-Plane, typ.	8°
Side Lobes, min.	-13 dB
Cross Polarization, min.	-20 dB
Front to Back Ratio, min.	-24 dB
Input power, max.	50 Watt
Input Impedance	50 Ohm
Lightning Protection	DC Grounded

#### Mechanical

Dimensions (HxWxD)	800 x 120 x 65 mm (31.5" x 4.7" x 2.6")
Weight	1.2 kg.
Connector	N-Type, Female
Back Plane	Aluminum protected through chemical passivation
Radome	UV Protected, Plastic
Mount	See ordering options

#### Environmental

Operating Temperature Range	-40°C to +65°C
Vibration	According to IEC 60721-3-4
Wind Load	200 km/h (survival)
Flammability	UL94
Water Proofing	IP-65
Humidity	ETS 300 019-1-4, EN 302 085 (annex A.1.1)
Salt Fog	According to IEC 68-2-11
Ice and Snow	25mm radial (survival)

#### Standard Compliance

ETSI EN 301 525 v1.1.1

### Ordering Options

MA-WE24-14	Antenna suited for MNT-5A (optional mount)
MA-WE24-14B	Antenna with MNT-5A mount
MA-WE24-14SB	Antenna heavy duty with MNT-5A mount

Patterns are available on our website

MARS Antennas & RF Systems proprietary information

MARS reserves the right to make technical changes or modifications to any of its products and specifications without prior notice and without implementing such changes to prior supplied products. Product images are representative and indicative only. Warranty terms and general conditions of sale are applicable on any purchase of any product, available on MARS website.

3 Hamanor st. Holon 5886103, P.O.Box 1852 Holon 5811801, Israel

Tel: +972-3-5599661 • Fax: +972-3-5599677 • e-mail: mars@marsant.co.il • web: www.mars-antennas.com

## MA-WD24-13MIMO

### 2.3-2.7 GHz MIMO Base Station Antenna, 90°

#### Antenna Features:

- Quick and easy installation.
- Aesthetic and unobtrusive radome.
- Easy mounting allows obtaining required down tilt degree.

#### Applicable Applications:

- Point-to-Multi-Point Systems.
- WLL applications.
- MMDS.
- ISM applications.



## Specifications

### Electrical

Frequency range	2.3-2.7 GHz
GAIN, typ.	3 x 13 dBi
VSWR, max.	1.7 : 1
Polarization	Linear, Vertical
3 dB Beam-Width, H-Plane, typ.	90°
3 dB Beam-Width, E-Plane, typ.	15°
Side Lobes, min.	-12 dB
Cross Polarization, min.	-20 dB
Front to Back Ratio, min.	-24 dB
Input power, max.	50 Watt
Input Impedance	50 Ohm
Lightning Protection	DC Grounded

### Mechanical

Dimensions (HxWxD)	400 x 308 x 80 mm (15" x 8.9" x 3.1")
Weight	2 kg.
Connector	3 x N-Type, Female
Back Plane	Aluminum protected through chemical passivation
Radome	UV Protected, Plastic
Mount	See ordering options

### Environmental

Operating Temperature Range	-40°C to +65°C
Vibration	According to IEC 60721-3-4
Wind Load	200 km/h (survival)
Flammability	UL94
Water Proofing	IP-65
Humidity	ETS 300 019-1-4, EN 302 085 (annex A.1.1)
Salt Fog	According to IEC 68-2-11
Ice and Snow	25mm radial (survival)

## Ordering Options

MA-WD24-13MIMO	Antenna Suited for MNT-22 (optional tilt mount)
MA-WD24-13MIMOB	Antenna with MNT-22 mount

Patterns are available on our website

MARS Antennas & RF Systems proprietary information

MARS reserves the right to make technical changes or modifications to any of its products and specifications without prior notice and without implementing such changes to prior supplied products. Product images are representative and indicative only. Warranty terms and general conditions of sale are applicable on any purchase of any product, available on MARS website.

3 Hamanor st. Holon 5886103, P.O.Box 1852 Holon 5811801, Israel

Tel: +972-3-5599661 • Fax: +972-3-5599677 • e-mail: mars@marsant.co.il • web: www.mars-antennas.com

## MA-WE24-14MIMO

### 2.3-2.7 GHz MIMO Base Station Antenna, 120°

#### Antenna Features:

- Quick and easy installation.
- Aesthetic and unobtrusive radome.
- Easy mounting allowing obtaining required down tilt degree.

#### Applicable Applications:

- Point-to-Multi-Point Systems.
- WLL applications.
- MMDS.
- ISM applications.



## Specifications

### Electrical

Frequency range	2.3-2.7 GHz
GAIN, typ.	4 x 14 dBi
VSWR, max.	1.7 : 1
Polarization	Linear, Vertical
3 dB Beam-Width, H-Plane, typ.	120°
3 dB Beam-Width, E-Plane, typ.	8°
Side Lobes, min.	-13 dB
Cross Polarization, min.	-20 dB
Front to Back Ratio, min.	-24 dB
Input power, max.	10 Watt
Input Impedance	50 Ohm
Lightning Protection	DC Grounded

### Mechanical

Dimensions (HxWxD)	812 x 470 x 70 mm (32" x 18.5" x 2.8")
Weight	5 kg.
Connector	4 x N-Type, Female
Back Plane	Aluminum protected through chemical passivation
Radome	UV Protected, Plastic
Mount	See ordering options

### Environmental

Operating Temperature Range	-40°C to +65°C
Vibration	According to IEC 60721-3-4
Wind Load	200 km/h (survival)
Flammability	UL94
Water Proofing	IP-65
Humidity	ETS 300 019-1-4, EN 302 085 (annex A.1.1)
Salt Fog	According to IEC 68-2-11
Ice and Snow	25mm radial (survival)

## Ordering Options

MA-WE24-14MIMO	Antenna Suited for MNT-25 (optional mount)
MA-WE24-14MIMOB	Antenna with MNT-25 mount

Patterns are available on our website

MARS Antennas & RF Systems proprietary information

MARS reserves the right to make technical changes or modifications to any of its products and specifications without prior notice and without implementing such changes to prior supplied products. Product images are representative and indicative only. Warranty terms and general conditions of sale are applicable on any purchase of any product, available on MARS website.

3 Hamanor st. Holon 5886103, P.O.Box 1852 Holon 5811801, Israel

Tel: +972-3-5599661 • Fax: +972-3-5599677 • e-mail: mars@marsant.co.il • web: www.mars-antennas.com



## MA-WC2458-6

### 2.4-2.5 & 5.15-5.875 GHz Dual Band Antenna 60°

Mars Dual Band Wi-Fi Small Factor High Gain Antenna

- Perfect for Wi-Fi Hot Spots
- Exceptionally efficient performance
- High Gain /Size Ratio
- Aesthetic design
- Weatherized and durable



## Specifications

### Electrical

Frequency range	2.4-2.5 & 5.15-5.875 GHz
Gain, typ.	7dBi@2.4-2.5 GHz & 8dBi@5.15-5.875 GHz
VSWR, max.	2 : 1
Polarization	Linear Vertical or Horizontal
3dB Beam-Width, H-Plane, typ.	60°@2.4-2.5 GHz; 70°@5.15-5.875 GHz
3dB Beam-Width, E-Plane, typ.	60°@2.4-2.5 GHz ; 50°@5.15-5.875 GHz
Front to Back Ratio, min.	-30 dB
Input power, max.	50 Watt
Input Impedance	50 Ohm

### Mechanical

Dimensions (HxWxD)	112 x 112 x 33.5 mm (4.41" x 4.41" x 1.32")
Connector	75 cm Pigtail with Right Angle RPSMA Male
Weight	150 gr.
Mounting	See Ordering Options
Radome	UV Protected Polycarbonate
Back Plane	Aluminum protected through chemical passivation.

### Environmental

Operating Temperature Range	-40°C to +65°C
Vibration	According to IEC 60721-3-4
Wind Load	200 Km/h (Survival)
Flammability	UL94
Water Proofing	IP-67
Humidity	ETS 300 019-1-4, EN 302 085 (Annex A.1.1)
Salt Fog	According to IEC 68-2-11

## Ordering Options

MA-WC2458-6	Suited for MNT-4LU Mount
MA-WC2458-6B	Antenna with MNT-4LU Mount

MARS Antennas & RF Systems proprietary information

MARS reserves the right to make technical changes or modifications to any of its products and specifications without prior notice and without implementing such changes to prior supplied products. Product images are representative and indicative only. Warranty terms and general conditions of sale are applicable on any purchase of any product, available on MARS website.

3 Hamanor st. Holon 5886103, P.O.Box 1852 Holon 5811801, Israel

Tel: +972-3-5599661 • Fax: +972-3-5599677 • e-mail: mars@marsant.co.il • web: www.mars-antennas.com

## MA-WC2458-10

### 2.4-2.5 & 5.15-5.875 GHz Dual Band Antenna 60°

Mars Dual Band Wi-Fi Small Factor High Gain Antenna

- Perfect for Wi-Fi Hotspots
- Exceptionally efficient performance
- High Gain /Size Ratio
- Aesthetic design
- Weatherized and durable



## Specifications

### Electrical

Frequency range	2.4-2.5 & 5.15-5.875 GHz
Gain, range	10dBi @ 2.4-2.5 GHz ; 11dBi @ 5.15-5.875 GHz
VSWR, max.	2 : 1
Polarization	Linear Vertical or Horizontal
3dB Beam-Width, H-Plane, typ.	60°
3dB Beam-Width, E-Plane, typ.	60°@ 2.4-2.5 GHz ; 40°@5.15-5.875 GHz
Front to Back Ratio, min.	-30 dB
Input power, max.	50 Watt
Input Impedance	50 Ohm

### Mechanical

Dimensions (HxWxD)	112 x 112 x 33.5 mm (4.41" x 4.41" x 1.32")
Connector	2 x N-Type ,Female
Weight	147 gr.
Mounting	See Ordering Options
Radome	UV Protected Polycarbonate
Back Plane	Aluminum protected through chemical passivation.

### Environmental

Operating Temperature Range	-40°C to +65°C
Vibration	According to IEC 60721-3-4
Wind Load	200 Km/h (Survival)
Flammability	UL94
Water Proofing	IP-67
Humidity	ETS 300 019-1-4,EN 302 085 (Annex A.1.1)
Salt Fog	According to IEC 68-2-11

## Ordering Options

MA-WC2458-10	Suited for MNT-4LU mount
MA-WC2458-10B	With MNT-4LU mount

MARS Antennas & RF Systems proprietary information

MARS reserves the right to make technical changes or modifications to any of its products and specifications without prior notice and without implementing such changes to prior supplied products. Product images are representative and indicative only. Warranty terms and general conditions of sale are applicable on any purchase of any product, available on MARS website.

3 Hamanor st. Holon 5886103, P.O.Box 1852 Holon 5811801, Israel

Tel: +972-3-5599661 • Fax: +972-3-5599677 • e-mail: mars@marsant.co.il • web: www.mars-antennas.com

## MA-WE2458-MIMO4-5

### 2.3-2.7 GHz & 4.9-6.1 GHz Dual Band MIMO Applications Sector Antenna, 120°

MARS Dual Band Sector antenna provides coverage of 2.3 to 2.7 GHz & 4.9 to 6.1 GHz in a single antenna radome.

Additional Features:

- Simultaneous coverage of 802.11 a, b, g, e, n, WiMAX & 4.9 GHz Public Safety Bands.
- Light weight and durable construction.
- UV protected radome made of plastic.

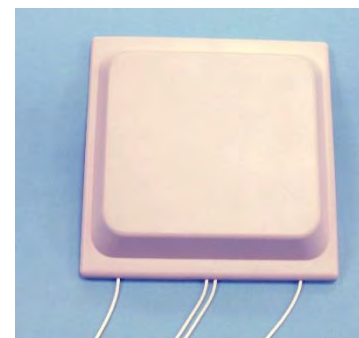

## Specifications

### Electrical

Frequency range	2.3-2.7 GHz & 4.9-6.1 GHz
Peak Gain, typ.	4 x 5 dBi
VSWR, max.	2 : 1 (typ. 1.5 : 1)
Polarization	Double dual Slant $\pm 45^\circ$
3 dB Beam-Width, H-Plane, typ.	120°
3 dB Beam-Width, E-Plane, typ.	70°
Input power, max.	20 Watt
Input Impedance	50 Ohm

### Mechanical

Dimensions (W x L x H)	200 x 200 x 33 mm (7.9" x 7.9" x 1.25")
Connector	See Ordering Options
Weight	260 gr.
Back Plane	Aluminum; protected through chemical passivation
Radome	UV Protected Polycarbonate
Mount	See Ordering Options

### Environmental

Operating Temperature Range	-40°C to +70°C
Vibration	According to IEC 60721-3-4
Flammability	UL94
Humidity	ETS 300 019-1-4, EN 302 085 (annex A.1.1)

## Ordering Options

MA-WE2458-MIMO4-5	Antenna 4 x 75cm Pigtail RG 316 with right angle RPSMA Male with provision for Az/EI adjustable for MNT-22 mount
MA-WE2458-MIMO4-5B	Antenna 4 x 75cm Pigtail RG 316 with right angle RPSMA Male with MNT-22 mount
MA-WE2458-MIMO4-5W	Antenna 4 x 75cm Pigtail RG 316 with right angle RPSMA Male, wall mountable
MA-WE2458-MIMO4-5N	Antenna 4 x 75cm Pigtail RG 316 with N-Type Male with provision for Az/EI adjustable for MNT-22 mount
MA-WE2458-MIMO4-5NB	Antenna 4 x 75cm Pigtail RG 316 with N-Type Male with MNT-22 mount

MARS Antennas & RF Systems proprietary information

MARS reserves the right to make technical changes or modifications to any of its products and specifications without prior notice and without implementing such changes to prior supplied products. Product images are representative and indicative only. Warranty terms and general conditions of sale are applicable on any purchase of any product, available on MARS website.

3 Hamanor st. Holon 5886103, P.O.Box 1852 Holon 5811801, Israel

Tel: +972-3-5599661 • Fax: +972-3-5599677 • e-mail: mars@marsant.co.il • web: www.mars-antennas.com

## MA-WC25-DP14

### 2.3-2.7 GHz Dual Polarized Base Station Antenna, 60°

MARS 60° Base Station Antenna with 14 dBi of gain is light-weight yet has a robust and durable construction.

Antenna Features:

- Quick and easy installation.
- Small, aesthetic and unobtrusive radome.
- Easily adapted to any RF connector.
- Easy mounting allows obtaining required down tilt degree.

Applications:

- Point-to-Multi-Point Systems.
- WLL applications.
- MMDS.
- ISM applications.



## Specifications

### Electrical

Frequency range	2.3-2.7 GHz
GAIN, typ.	14 dBi
VSWR, max.	1.7 : 1
Polarization, Dual Pole	Linear, Vertical & Horizontal
3 dB Beam-Width, Az-Plane, typ.	60°
3 dB Beam-Width, El-Plane, typ.	16°
Side Lobes, min.	-12 dB
Cross Polarization, min.	-15 dB
Port to Port Isolation, min.	-35 dB
Front to Back Ratio, min.	-25 dB
Input power, max.	10 Watt
Input Impedance	50 Ohm
Lightning Protection	DC Grounded

### Mechanical

Dimensions (HxWxD)	370 x 370 x 40 mm (14.5" x 14.5" x 1.6")
Connector	2 x N-Type, Female
Weight	1.8 Kg.
Back Plane	Aluminum; protected through chemical passivation
Radome	UV Protected Polycarbonate
Mounting	See ordering options

### Environmental

Operating Temperature Range	-55°C to +65°C
Vibration	According to IEC 60721-3-4
Wind Load	200 Km/h (Survival)
Flammability	UL94
Water Proofing	IP-67
Humidity	ETS 300 019-1-4, EN 302 085 (Annex A.1.1)
Salt Fog	According to IEC 68-2-11

## Ordering Options

MA-WC25-DP14	Antenna Suited for MNT-22 (optional wall/pole adjustable mount)
MA-WC25-DP14B	Antenna with MNT-22 mount

MARS Antennas & RF Systems proprietary information

MARS reserves the right to make technical changes or modifications to any of its products and specifications without prior notice and without implementing such changes to prior supplied products. Product images are representative and indicative only. Warranty terms and general conditions of sale are applicable on any purchase of any product, available on MARS website.

3 Hamanor st. Holon 5886103, P.O.Box 1852 Holon 5811801, Israel

Tel: +972-3-5599661 • Fax: +972-3-5599677 • e-mail: mars@marsant.co.il • web: www.mars-antennas.com

## MA-WD25-DP13

### 2.3-2.7 GHz Dual Polarized Base Station Antenna, 90°

MARS 90° Base Station Antenna with 12.5 dBi of gain is light-weight yet has a robust and durable construction.

Antenna Features:

- Quick and easy installation.
- Small, aesthetic and unobtrusive radome.
- Easily adapted to any RF connector.
- Easy mounting allows obtaining required down tilt degree.

Applications:

- Point-to-Multi-Point Systems.
- WLL applications.
- MMDS.
- ISM applications.



## Specifications

### Electrical

Frequency range	2.3-2.7 GHz
GAIN, typ.	12.5 dBi
VSWR, max.	1.7 : 1
Polarization, Dual Pole	Linear, Vertical & Horizontal
3 dB Beam-Width, Az-Plane, typ.	90°
3 dB Beam-Width, El-Plane, typ.	17°
Side Lobes, min.	-12 dB
Cross Polarization, min.	-15 dB
Port to Port Isolation, min.	-35 dB
Front to Back Ratio, min.	-20 dB
Input power, max.	10 Watt
Input Impedance	50 Ohm
Lightning Protection	DC Grounded

### Mechanical

Dimensions (HxWxD)	370 x 370 x 40 mm (14.5" x 14.5" x 1.6")
Connector	2 x N-Type, Female
Weight	2 Kg.
Back Plane	Aluminum; protected through chemical passivation
Radome	UV Protected Polycarbonate
Mounting	See ordering options

### Environmental

Operating Temperature Range	-55°C to +65°C
Vibration	According to IEC 60721-3-4
Wind Load	200 Km/h (Survival)
Flammability	UL94
Water Proofing	IP-67
Humidity	ETS 300 019-1-4, EN 302 085 (Annex A.1.1)
Salt Fog	According to IEC 68-2-11

## Ordering Options

MA-WD25-DP13	Antenna Suited for MNT-22 (optional wall/pole adjustable mount)
MA-WD25-DP13B	Antenna with MNT-22 mount

MARS Antennas & RF Systems proprietary information

MARS reserves the right to make technical changes or modifications to any of its products and specifications without prior notice and without implementing such changes to prior supplied products. Product images are representative and indicative only. Warranty terms and general conditions of sale are applicable on any purchase of any product, available on MARS website.

3 Hamanor st. Holon 5886103, P.O.Box 1852 Holon 5811801, Israel

Tel: +972-3-5599661 • Fax: +972-3-5599677 • e-mail: mars@marsant.co.il • web: www.mars-antennas.com

## MA-WC25-DS16

### 2.2-2.2 GHz Dual Slant Base Station Antenna, 65°

MARS Dual Slant  $\pm 45$  degrees 65° sector antenna features:

- Efficient and stable performance with 2 X16 dBi of gain.
- Full 2.3-2.7 GHz band coverage.
- High Isolation ratio.
- Compact size.
- Optional Azimuth & Elevation Adjustable mount.

UV protected radome suitable for harsh environment installations.

Can be customized per customer requirements



## Specifications

### Electrical

Frequency range	2.3-2.7 GHz
GAIN, typ.	2 x 16dBi
VSWR, max.	1.7 : 1
Polarization	Dual Slant $\pm 45^\circ$
4 dB Beam-Width, Azimuth, typ.	65°
3 dB Beam-Width, Elevation, typ.	9°
Side Lobe level ( Elevation),typ.	-12 dB
Port to Port Isolation, typ.	-20 dB
Front to Back Ratio, min.	-30 dB
Input power, max.	20 Watt
Input Impedance	50 Ohm
Lightning Protection	DC Grounded

### Mechanical

Dimensions (HxWxD)	800 x 225 x 67 mm (31.3" x 8.8" x 2.6")
Weight	2.5 kg.
Connector	2 x N-Type, Female
Back Plane	Aluminum; protected through chemical passivation
Radome	UV Protected, Plastic
Mount	See Ordering Options

### Environmental

Operating Temperature Range	-55°C to +65°C
Vibration	According to IEC 60721-3-4
Wind Load	200 km/h (survival)
Flammability	UL94
Water Proofing	IP-65
Humidity	ETS 300 019-1-4, EN 302 085 (annex A.1.1)
Salt Fog	According to IEC 68-2-11
Ice and Snow	25mm radial (survival)

## Ordering Options

MA-WC25-DS16	Antenna 2 x N-Type Female connectors Suited for MNT-5A mount
MA-WC25-DS16B	Antenna 2 x N-Type Female connectors with MNT-5A mount

MARS Antennas & RF Systems proprietary information

MARS reserves the right to make technical changes or modifications to any of its products and specifications without prior notice and without implementing such changes to prior supplied products. Product images are representative and indicative only. Warranty terms and general conditions of sale are applicable on any purchase of any product, available on MARS website.

3 Hamanor st. Holon 5886103, P.O.Box 1852 Holon 5811801, Israel

Tel: +972-3-5599661 • Fax: +972-3-5599677 • e-mail: mars@marsant.co.il • web: www.mars-antennas.com

## MA-WD25-DS15

### 2.2-2.2 GHz Dual Slant Base Station Antenna, 90°

MARS Dual Slant  $\pm 45$  degrees 90° sector antenna features:

- Efficient and stable performance with 2X15 dBi of gain.
- Full 2.3-2.7 GHz band coverage.
- High Isolation ratio.
- Compact size.
- Optional Azimuth & Elevation Adjustable mount.

UV protected radome suitable for harsh environment installations.

Can be customized per customer requirements



## Specifications

### Electrical

Frequency range	2.3-2.7 GHz
GAIN, typ.	2 x 15dBi
VSWR, max.	1.7 : 1
Polarization	Dual Slant $\pm 45^\circ$
4 dB Beam-Width, Azimuth, typ.	90°
3 dB Beam-Width, Elevation, typ.	9°
Side Lobe level ( Elevation),typ.	-12 dB
Port to Port Isolation, typ.	-20 dB
Front to Back Ratio, min.	-30 dB
Input power, max.	20 Watt
Input Impedance	50 Ohm
Lightning Protection	DC Grounded

### Mechanical

Dimensions (HxWxD)	800 x 225 x 67 mm (31.3" x 8.8" x 2.6")
Weight	2.5 kg.
Connector	2 x N-Type, Female
Back Plane	Aluminum; protected through chemical passivation
Radome	UV Protected, Plastic
Mount	See Ordering Options

### Environmental

Operating Temperature Range	-55°C to +65°C
Vibration	According to IEC 60721-3-4
Wind Load	200 km/h (survival)
Flammability	UL94
Water Proofing	IP-65
Humidity	ETS 300 019-1-4, EN 302 085 (annex A.1.1)
Salt Fog	According to IEC 68-2-11
Ice and Snow	25mm radial (survival)

## Ordering Options

MA-WD25-DS15	Antenna 2 x N-Type Female connectors Suited for MNT-5A mount
MA-WD25-DS15B	Antenna 2 x N-Type Female connectors with MNT-5A mount

MARS Antennas & RF Systems proprietary information

MARS reserves the right to make technical changes or modifications to any of its products and specifications without prior notice and without implementing such changes to prior supplied products. Product images are representative and indicative only. Warranty terms and general conditions of sale are applicable on any purchase of any product, available on MARS website.

3 Hamanor st. Holon 5886103, P.O.Box 1852 Holon 5811801, Israel

Tel: +972-3-5599661 • Fax: +972-3-5599677 • e-mail: mars@marsant.co.il • web: www.mars-antennas.com

## MA-WC25-DS18

### 2.2-2.2 GHz Dual Slant Base Station Antenna, 60°

MARS Dual Slant  $\pm 45$  degrees 60° sector antenna features:

- Efficient and stable performance with 17.5 dBi of gain.
- Full 2.3-2.7 GHz band coverage.
- High Isolation ratio.
- Compact size.
- Optional Azimuth & Elevation Adjustable mount.
- UV protected radome suitable for harsh environment installations.



## Specifications

### Electrical

Frequency range	2.3-2.7 GHz
GAIN, typ.	17.5 dBi
VSWR, max.	1.7 : 1
Polarization	Dual Slant $\pm 45^\circ$
3 dB Beam-Width, H-Plane, typ.	60°
3 dB Beam-Width, E-Plane, typ.	6°
Side Lobes, min.	-18 dB
Port to Port Isolation	-25 dB (min.), -30 dB (typ.)
Front to Back Ratio, min.	-30 dB
Input power, max.	100 Watt Peak (5% duty cycle)
Input Impedance	50 Ohm
Lightning Protection	DC Grounded

### Mechanical

Dimensions (HxWxD)	1200 x 200 x 70 mm (47.2" x 7.9" x 2.8")
Weight	5 kg.
Connector	2 x N-Type, Female
Back Plane	Aluminum; protected through chemical passivation
Radome	UV Protected, Plastic
Mount	See ordering options

### Environmental

Operating Temperature Range	-55°C to +65°C
Vibration	According to IEC 60721-3-4
Wind Load	200 km/h (survival)
Flammability	UL94
Water Proofing	IP-65
Humidity	ETS 300 019-1-4, EN 302 085 (annex A.1.1)
Salt Fog	According to IEC 68-2-11
Ice and Snow	25mm radial (survival)

## Ordering Options

MA-WC25-DS18	Antenna Suited for MNT-25 (optional tilt mount)
MA-WC25-DS18B	Antenna with MNT-25 mount

Patterns are available on our website

MARS Antennas & RF Systems proprietary information

MARS reserves the right to make technical changes or modifications to any of its products and specifications without prior notice and without implementing such changes to prior supplied products. Product images are representative and indicative only. Warranty terms and general conditions of sale are applicable on any purchase of any product, available on MARS website.

3 Hamanor st. Holon 5886103, P.O.Box 1852 Holon 5811801, Israel

Tel: +972-3-5599661 • Fax: +972-3-5599677 • e-mail: mars@marsant.co.il • web: www.mars-antennas.com



## MA-WD25-MIMO3

### 2.3-2.7 GHz, 14dBi Dual Polarized Antenna Array, 90°

**Antenna Features:**

- 3 columns dual slant antenna arrays.
- Total 6 outputs.
- Quick and easy installation.
- Aesthetic and unobtrusive radome.
- Easy mounting allows obtain required down tilt degree.

**Applicable Applications:**

- Point-to-Multi-Point Systems.
- WLL applications.
- MMDS.
- ISM applications.



## Specifications

### Electrical

Frequency range	2.3-2.7 GHz
GAIN, min.	6 x 14 dBi
VSWR, max.	1.8 : 1
Polarization	Dual Slant ±45°
3 dB Beam-Width, H-Plane, typ.	90°
3 dB Beam-Width, E-Plane, typ.	9°
Side Lobes, min. Elevation Plane	-12 dB
Side Lobes, min. Azimuth Plane	-20 dB
Cross Polarization Discrimination, typ.	-20 dB
Port to Port Isolation, min.	20 dB
Front to Back Ratio, min.	30 dB
Array Element Spacing	196 mm (1.5λ on 2.3 GHz)
Input power, max.	5 Watts average, 50 Watts peak
Input Impedance	50 Ohm
Lightning Protection	DC Grounded

### Mechanical

Dimensions (HxWxD)	800 x 600 x 40 mm (31.5" x 23.6" x 1.6")
Weight	6.5 kg.
Connector	6 x N-Type, Female
Back Plane	Aluminum protected through chemical passivation
Radome	UV Protected, Plastic
Mount	See ordering options

### Environmental

Operating Temperature Range	-40°C to +65°C
Vibration	According to IEC 60721-3-4
Wind Load	200 km/h (survival)
Flammability	UL94
Water Proofing	IP-65
Humidity	ETS 300 019-1-4, EN 302 085 (annex A.1.1)
Salt Fog	According to IEC 68-2-11
Ice and Snow	25mm radial (survival)

## Ordering Options

MA-WD25-MIMO3	Antenna Suited for MNT-25 (optional tilt mount)
MA-WD25-MIMO3B	Antenna with MNT-25 mount

Patterns are available on our website

Mars Antennas & RF Systems proprietary information  
 MARS reserves the right to make technical changes or modifications to any of its products and specifications without prior notice and without implementing such changes to prior supplied products. Product images are representative and indicative only. Warranty terms and general conditions of sale are applicable on any purchase of any product, available on MARS website.

3 Hamanor st. Holon 58861, P.O.Box 5 AZOR 58008, Israel  
 Tel: +972-3-5599661 • Fax: +972-3-5599677 • e-mail: mars@marsant.co.il • web: www.mars-antennas.com

## MA-WC2458-MIMO4-8

### 2.4-2.5 GHz & 5.15-5.875 GHz Dual Band MIMO Applications Sector Antenna 60°

MARS Dual Band Sector antenna provides coverage of 2.4 to 2.5 GHz & 5.15 to 5.875 GHz in a single antenna radome.

Additional Features:

- Wide coverage.
- Total 4 outputs.
- Simultaneous coverage of LTE, 802.11 a, b, g, e, n, WiMAX.
- Point-to-Multi Point, ISM and WLL applications.
- Lightweight and durable construction.
- Quick and easy installation.
- UV protected radome made of polycarbonate.

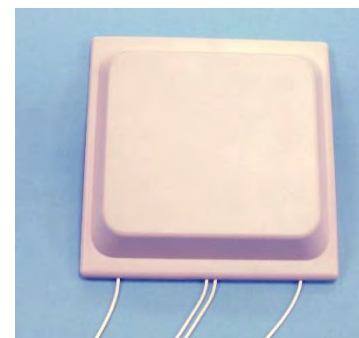

## Specifications

### Electrical

Frequency range	2.4-2.5 GHz & 5.15-5.875 GHz
Peak Gain, typ.	4 x 6 dBi
VSWR, max.	2 : 1
Polarization	Double dual Slant $\pm 45^\circ$
3 dB Beam-Width, H-Plane, typ.	60°
3 dB Beam-Width, E-Plane, typ.	60°
Port to Port Isolation, typ.	-25dB
Front to Back, min.	-25dB
Input power, max.	20 Watt
Input Impedance	50 Ohm

### Mechanical

Dimensions (W x L x H)	200 x 200 x 33 mm (7.9" x 7.9" x 1.25")
Connector	See Ordering Options
Weight	260 gr.
Back Plane	Aluminum; protected through chemical passivation
Radome	UV Protected Polycarbonate
Mount	See Ordering Options

### Environmental

Operating Temperature Range	-40°C to +70°C
Vibration	According to IEC 60721-3-4
Flammability	UL94
Water Proofing	IP-67
Humidity	ETS 300 019-1-4, EN 302 085 (annex A.1.1)
Wind Load	220 km/h

## Ordering Options

MA-WC2458-MIMO4-8	Antenna 4 x75cm Pigtail RG 316 with right angle RPSMA Male with provision for Az/EI adjustable for MNT-22 mount
MA-WC2458-MIMO4-8B	Antenna 4 x75cm Pigtail RG 316 with right angle RPSMA Male with MNT-22 mount
MA-WC2458-MIMO4-8W	Antenna 4 x75cm Pigtail RG 316 with right angle RPSMA Male, wall mountable
MA-WC2458-MIMO4-8N	Antenna 4 x 75cm Pigtail RG 316 with N-Type Male with provision for Az/EI adjustable for MNT-22 mount
MA-WC2458-MIMO4-8NB	Antenna 4 x 75cm Pigtail RG 316 with N-Type Male with MNT-22 mount

MARS Antennas & RF Systems proprietary information

MARS reserves the right to make technical changes or modifications to any of its products and specifications without prior notice and without implementing such changes to prior supplied products. Product images are representative and indicative only. Warranty terms and general conditions of sale are applicable on any purchase of any product, available on MARS website.

3 Hamanor st. Holon 5886103, P.O.Box 1852 Holon 5811801, Israel

Tel: +972-3-5599661 • Fax: +972-3-5599677 • e-mail: mars@marsant.co.il • web: www.mars-antennas.com

## MA-WC2458-2H

### 2.4-2.5 GHz & 5.15-5.875 GHz Dual Band Small Sector Antenna, 60°

MARS Dual Band Sector antenna provides coverage of 2.4 to 2.5 GHz & 5.15 to 5.875 GHz in a single antenna radome.

Additional Features:

- Wide coverage.
- Light weight and durable construction.
- UV protected radome made of polycarbonate.



## Specifications

### Electrical

Frequency range	2.4-2.5 GHz & 5.15-5.875 GHz
GAIN, typ.	2 x 7.5 dBi
VSWR, max.	1.8 : 1
Polarization	Dual Slant ±45°
3 dB Beam-Width, H-Plane, typ.	70° @ 2.4-2.5 GHz; 65° @ 5.15-5.875 GHz
3 dB Beam-Width, E-Plane, typ.	65° @ 2.4-2.5 GHz; 60° @ 5.15-5.875 GHz
Input power, max.	20 Watt
Input Impedance	50 Ohm

### Mechanical

Dimensions (W x L x H)	200 x 200 x 33 mm (7.9" x 7.9" x 1.25")
Connector	See ordering options
Weight	400 gr.
Back Plane	Aluminum; protected through chemical passivation
Radome	UV Protected Polycarbonate
Water Proofing	IP-67
Mount	See ordering options

### Environmental

Operating Temperature Range	-40°C to +70°C
Vibration	According to IEC 60721-3-4
Flammability	UL94
Humidity	ETS 300 019-1-4, EN 302 085 (annex A.1.1)

## Ordering Options

MA-WC2458-2H	Antenna 2 x Coaxial Cable RG 316 with RPSMA Male, wall mountable
MA-WC2458-2H2	Antenna 2 x Coaxial Cable RG 316 with N-Type Male with provision for Az/EI adjustable for MNT-22 mount
MA-WC2458-2H2B	Antenna 2 x Coaxial Cable RG 316 with N-Type Male with MNT-22 mount

Patterns are available on our website

MARS Antennas & RF Systems proprietary information

MARS reserves the right to make technical changes or modifications to any of its products and specifications without prior notice and without implementing such changes to prior supplied products. Product images are representative and indicative only. Warranty terms and general conditions of sale are applicable on any purchase of any product, available on MARS website.

3 Hamanor st. Holon 5886103, P.O.Box 1852 Holon 5811801, Israel

Tel: +972-3-5599661 • Fax: +972-3-5599677 • e-mail: mars@marsant.co.il • web: www.mars-antennas.com

## MA-WD2455-DBDP17

### 2.4-2.5 GHz & 5.1-5.9 GHz, 4X4 Dual Band, Dual Polarization Base Station Antenna 90°

MARS MA-WD2455-DBDP17 is a 4X4 (MIMO) high gain antenna with Dual band, Dual polarization antenna provides coverage of 2.4-2.5 GHz frequency band and 5.1-5.9 GHz frequency band in a single antenna radome.

Additional Features:

- Designed to meet WAVE2, 802.11ac & more.
- Easy mounting allowing Az/EI adjustment.



## Specifications

### Electrical

Frequency range	2.4-2.5 GHz	5.1-5.9 GHz
GAIN, typ.	15 dBi	17 dBi
VSWR, max.	<2 : 1	
Polarization	Vertical & Horizontal	
3 dB Beam-Width, H-Plane, typ.	90°	90°
3 dB Beam-Width, E-Plane, typ.	8°	8°
Side Lobes, typ.	-12 dB	
Front to Back Ratio, typ.	-30 dB	
Port to Port Isolation, typ.	-27 dB	
Input power, max	50 Watt	
Input Impedance	50 Ohm	
Lightning Protection	DC Grounded	

### Mechanical

Dimensions (HxWxD)	812 X 330 X 70 mm (TBD)
Weight	3 Kg.
Connector	4 x N-Type, Female
Back Plane	Aluminum protected through chemical passivation
Radome	UV Protected Plastic
Mount	MNT-25

### Environmental

Operating Temperature Range	-40°C to +65°C
Vibration	According to IEC 60721-3-4
Wind Load	200 km/h (survival)
Flammability	UL94
Water Proofing	IP-65
Humidity	ETS 300 019-1-4, EN 302 085 (annex A.1.1)
Salt Fog	According to IEC 68-2-11

MARS Antennas & RF Systems proprietary information

MARS reserves the right to make technical changes or modifications to any of its products and specifications without prior notice and without implementing such changes to prior supplied products. Product images are representative and indicative only. Warranty terms and general conditions of sale are applicable on any purchase of any product, available on MARS website.

3 Hamanor st. Holon 5886103, P.O.Box 1852 Holon 5811801, Israel

Tel: +972-3-5599661 • Fax: +972-3-5599677 • e-mail: mars@marsant.co.il • web: www.mars-antennas.com

## MA-WE2458-2H

### 2.3-2.7 GHz & 4.9-6.1 GHz Dual Band MIMO Applications Sector Antenna, 120°

MARS Dual Band Sector antenna provides coverage of 2.3 to 2.7 GHz & 4.9 to 6.1 GHz in a single antenna radome.

Additional Features:

- Simultaneous coverage of LTE, 802.11 a, b, g, e, n, WiMAX & 4.9 GHz Public Safety Bands.
- Light weight and durable construction.
- UV protected radome made of plastic.

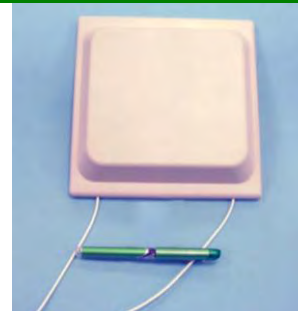

## Specifications

### Electrical

Frequency range	2.3-2.7 GHz & 4.9-6.1 GHz
GAIN, typ.	2 x 5 dBi
VSWR, max.	2 : 1 (typ. 1.5 : 1)
Polarization	Dual Slant $\pm 45^\circ$
3 dB Beam-Width, H-Plane, typ.	120°
3 dB Beam-Width, E-Plane, typ.	70°
Input power, max.	20 Watt
Input Impedance	50 Ohm

### Mechanical

Dimensions (W x L x H)	200 x 200 x 33 mm (7.9" x 7.9" x 1.25")
Connector	See ordering options
Weight	400 gr.
Back Plane	Aluminum; protected through chemical passivation
Radome	UV Protected Polycarbonate
Water Proofing	IP-67
Mount	See Ordering Options

### Environmental

Operating Temperature Range	-40°C to +70°C
Vibration	According to IEC 60721-3-4
Flammability	UL94
Humidity	ETS 300 019-1-4, EN 302 085 (annex A.1.1)

## Ordering Options

MA-WE2458-2H	Antenna 2 x Coaxial Cable RG 316 with RPSMA, wall mountable
MA-WE2458-2H2	Antenna 2 x Coaxial Cable RG 316 with N-Type male with provision for Az/EI adjustable for MNT-22 mount
MA-WE2458-2H2B	Antenna 2 x Coaxial Cable RG 316 with N-Type male with MNT-22 mount

Patterns are available on our website

MARS Antennas & RF Systems proprietary information

MARS reserves the right to make technical changes or modifications to any of its products and specifications without prior notice and without implementing such changes to prior supplied products. Product images are representative and indicative only. Warranty terms and general conditions of sale are applicable on any purchase of any product, available on MARS website.

3 Hamanor st. Holon 5886103, P.O.Box 1852 Holon 5811801, Israel

Tel: +972-3-5599661 • Fax: +972-3-5599677 • e-mail: mars@marsant.co.il • web: www.mars-antennas.com

## MA-WC25-2DS17

### 2.3-2.7 GHz 2 x Dual Slant Base Station Antenna, 65°

MARS MA-WC25-2DS17 is a DOUBLE Dual Slant (4X4) Base Station Antenna 65°

MA-WC25-2DS17 features:

- Efficient and stable performance with 17dBi of gain.
- Full 2.3-2.7 GHz band coverage.
- UV protected radome suitable for harsh environment installations.



## Specifications

### Electrical

Frequency range	2.3-2.7 GHz
GAIN, typ.	4 x 17 dBi
VSWR, max.	1.7 : 1
Polarization	2 x Dual Polarized ±45°
3 dB Beam-Width, H-Plane, typ.	65°
3 dB Beam-Width, E-Plane, typ.	8°
Side Lobes, typ.	-12 dB
Port to Port Isolation, min.	-27 dB
Front to Back Ratio, typ.	-30 dB
Input power, max.	50 Watt
Input Impedance	50 Ohm
Lightning Protection	DC Grounded

### Mechanical

Dimensions (HxWxD)	812 X 470 X 70 mm (31.9" X 18.5" X 2.7")
Weight	5 kg.
Connector	4 x N-Type, Female
Back Plane	Aluminum protected through chemical passivation
Radome	UV Protected Plastic
Mount	MNT-25

### Environmental

Operating Temperature Range	-40°C to +65°C
Vibration	According to IEC 60721-3-4
Wind Load	200 km/h (survival)
Flammability	UL94
Water Proofing	IP-65
Humidity	ETS 300 019-1-4, EN 302 085 (annex A.1.1)
Salt Fog	According to IEC 68-2-11
Ice and Snow	25mm radial (survival)

MARS Antennas & RF Systems proprietary information

MARS reserves the right to make technical changes or modifications to any of its products and specifications without prior notice and without implementing such changes to prior supplied products. Product images are representative and indicative only. Warranty terms and general conditions of sale are applicable on any purchase of any product, available on MARS website.

3 Hamanor st. Holon 5886103, P.O.Box 1852 Holon 5811801, Israel

Tel: +972-3-5599661 • Fax: +972-3-5599677 • e-mail: mars@marsant.co.il • web: www.mars-antennas.com

## MA-WE2458-3H

### 2.3-2.7 GHz & 4.9-6.1 GHz Dual Band MIMO Applications Sector Antenna, 120°

MARS Dual Band Sector antenna provides coverage of 2.3 to 2.7 GHz & 4.9 to 6.1 GHz in a single antenna radome.

Additional Features:

- Simultaneous coverage of LTE, 802.11 a, b, g, e, n, WiMAX & 4.9 GHz Public Safety Bands.
- Light weight and durable construction.
- UV protected radome made of polycarbonate.

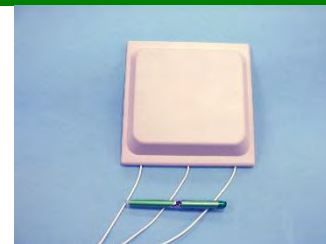

## Specifications

### Electrical

Frequency range	2.3-2.7 GHz & 4.9-6.1 GHz
GAIN, typ.	3 x 5 dBi
VSWR, max.	2 : 1 (typ. 1.5 : 1)
Polarization	Vertical & 2 Dual Slant ±45°
3 dB Beam-Width, H-Plane, typ.	120°
3 dB Beam-Width, E-Plane, typ.	70°
Input power, max.	20 Watt
Input Impedance	50 Ohm

### Mechanical

Dimensions (W x L x H)	200 x 200 x 33 mm (7.9" x 7.9" x 1.25")
Connector	See ordering options
Weight	400 gr.
Back Plane	Aluminum; protected through chemical passivation
Radome	UV Protected Polycarbonate
Mount	See Ordering Options

### Environmental

Operating Temperature Range	-40°C to +70°C
Vibration	According to IEC 60721-3-4
Flammability	UL94
Water Proofing	IP-67
Humidity	ETS 300 019-1-4, EN 302 085 (annex A.1.1)

## Ordering Options

MA-WE2458-3H	Antenna 3 x Coaxial Cable RG 316 with RPSMA, wall mountable
MA-WE2458-3H2	Antenna 3 x Coaxial Cable RG 316 with N-Type male with provision for Az/EI adjustable for MNT-22 mount
MA-WE2458-3H2B	Antenna 3 x Coaxial Cable RG 316 with N-Type male with MNT-22 mount

Patterns are available on our website

MARS Antennas & RF Systems proprietary information

MARS reserves the right to make technical changes or modifications to any of its products and specifications without prior notice and without implementing such changes to prior supplied products. Product images are representative and indicative only. Warranty terms and general conditions of sale are applicable on any purchase of any product, available on MARS website.

3 Hamanor st. Holon 5886103, P.O.Box 1852 Holon 5811801, Israel

Tel: +972-3-5599661 • Fax: +972-3-5599677 • e-mail: mars@marsant.co.il • web: www.mars-antennas.com

## MA-WC2458-3H

### 2.4-2.5 GHz & 5.15-5.875 GHz Dual Band Small Sector Antenna, 60°

MARS Dual Band Sector antenna provides coverage of 2.4 to 2.5 GHz & 5.15 to 5.875 GHz in a single antenna radome.

Additional Features:

- Wide coverage.
- Light weight and durable construction.
- UV protected radome made of polycarbonate.



## Specifications

### Electrical

Frequency range	2.4-2.5 GHz & 5.15-5.875 GHz
GAIN, typ.	3 x 7.5 dBi
VSWR, max.	1.8 : 1
Polarization	Linear Vertical & Dual Slant ±45°
3 dB Beam-Width, H-Plane, typ.	70° @ 2.4-2.5 GHz; 65° @ 5.15-5.875 GHz
3 dB Beam-Width, E-Plane, typ.	65° @ 2.4-2.5 GHz; 60° @ 5.15-5.875 GHz
Input power, max.	20 Watt
Input Impedance	50 Ohm

### Mechanical

Dimensions (W x L x H)	200 x 200 x 33 mm (7.9" x 7.9" x 1.25")
Connector	See ordering options
Weight	400 gr.
Back Plane	Aluminum; protected through chemical passivation
Radome	UV Protected Polycarbonate
Mount	See ordering options

### Environmental

Operating Temperature Range	-40°C to +70°C
Vibration	According to IEC 60721-3-4
Flammability	UL94
Water Proofing	IP-67
Humidity	ETS 300 019-1-4, EN 302 085 (annex A.1.1)

## Ordering Options

MA-WC2458-3H	Antenna 3 x Coaxial Cable RG 316 with RPSMA Male, wall mountable
MA-WC2458-3H2	Antenna 3 x Coaxial Cable RG 316 with N-Type Male with provision for Az/EI adjustable for MNT-22 mount
MA-WC2458-3H2B	Antenna 3 x Coaxial Cable RG 316 with N-Type Male with MNT-22 mount

Patterns are available on our website

MARS Antennas & RF Systems proprietary information

MARS reserves the right to make technical changes or modifications to any of its products and specifications without prior notice and without implementing such changes to prior supplied products. Product images are representative and indicative only. Warranty terms and general conditions of sale are applicable on any purchase of any product, available on MARS website.

3 Hamanor st. Holon 5886103, P.O.Box 1852 Holon 5811801, Israel

Tel: +972-3-5599661 • Fax: +972-3-5599677 • e-mail: mars@marsant.co.il • web: www.mars-antennas.com



## MA-WC2458-QP6

### 2.4-2.5 GHz & 5.15-5.875 GHz Dual Band Quad pole Sector Antenna 60°

MARS Dual Band Sector antenna provides coverage of 2.4 to 2.5 GHz & 5.15 to 5.875 GHz in a single antenna radome.

Additional Features:

- Wide coverage.
- Total 4 outputs.
- Simultaneous coverage of LTE, 802.11 a, b, g, e, n, WiMAX.
- Point-to-Multi Point, ISM and WLL applications.
- Lightweight and durable construction.
- Quick and easy installation.
- UV protected radome made of polycarbonate.

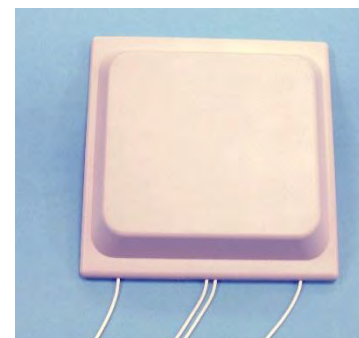

## Specifications

### Electrical

Frequency range	2.4-2.5 GHz & 5.15-5.875 GHz
Peak Gain, typ.	4 x 6 dBi
VSWR, max.	2 : 1
Polarization	Dual Slant $\pm 45^\circ$ & Vertical & Horizontal
3 dB Beam-Width, H-Plane, typ.	60°
3 dB Beam-Width, E-Plane, typ.	60°
Port to Port Isolation, typ.	-25 dB @ 2.4 GHz; -30dB @ 5.5 GHz
Front to Back, min.	-25dB
Input power, max.	20 Watt
Input Impedance	50 Ohm

### Mechanical

Dimensions (W x L x H)	200 x 200 x 33 mm (7.9" x 7.9" x 1.25")
Connector	See Ordering Options
Weight	260 gr.
Back Plane	Aluminum; protected through chemical passivation
Radome	UV Protected Polycarbonate
Mount	See Ordering Options

### Environmental

Operating Temperature Range	-40°C to +70°C
Vibration	According to IEC 60721-3-4
Flammability	UL94
Water Proofing	IP-67
Humidity	ETS 300 019-1-4, EN 302 085 (annex A.1.1)
Wind Load	220 km/h

## Ordering Options

MA-WC2458-QP6	Antenna 4 x 75cm Pigtail RG 316 with right angle RPSMA Male with provision for Az/EI adjustable for MNT-22 mount
MA-WC2458-QP6B	Antenna 4 x 75cm Pigtail RG 316 with right angle RPSMA Male with MNT-22 mount
MA-WC2458-QP6W	Antenna 4 x 75cm Pigtail RG 316 with right angle RPSMA Male, wall mountable
MA-WC2458-QP6N	Antenna 4 x 75cm Pigtail RG 316 with N-Type Male with provision for Az/EI adjustable for MNT-22 mount
MA-WC2458-QP6NB	Antenna 4 x 75cm Pigtail RG 316 with N-Type Male with MNT-22 mount

MARS Antennas & RF Systems proprietary information

MARS reserves the right to make technical changes or modifications to any of its products and specifications without prior notice and without implementing such changes to prior supplied products. Product images are representative and indicative only. Warranty terms and general conditions of sale are applicable on any purchase of any product, available on MARS website.

3 Hamanor st. Holon 5886103, P.O.Box 1852 Holon 5811801, Israel

Tel: +972-3-5599661 • Fax: +972-3-5599677 • e-mail: mars@marsant.co.il • web: www.mars-antennas.com

## MA-EG15-XX

### GPS AVL Active Antenna

MARS GPS Active Antenna is exceptionally small sized and offers extremely wide coverage at low angles.

Additional Features:

- Reliable and stable performance.
- Dashboard or under dashboard mounting.
- Cable length with SMA connector option.
- Resists unfriendly environments.
- Built-in low noise amplifier.

Application:

- AVL, Automatic vehicular and asset location systems.
- GPS, time and location systems.

Cost effective solution for high volume deployment.



### Specifications

#### Electrical

Frequency range	1575±1.24 MHz
GAIN, min.	27 dBi
Axial Ratio	3 dB
VSWR, max.	2 : 1
Polarization	Circular, RHCP
3 dB Beam-Width, H-Plane, typ.	Omni Directional
3 dB Beam-Width, E-Plane, typ.	150°
Noise Figure (Amp)	1.6 dB
Input power, max	30 mA / 3 V
Intercept Point	+10 dBm
Input Impedance	50 Ohm

#### Mechanical

Dimensions (HxWxD)	40 x 45 x 15 mm (1.6" x 1.8" x 0.6")
Weight	60 gr.
Connector	SMB, Female on a 1.8m RG 174 Cable / SMA, Female( optional)
Radome	ABS

#### Environmental

Operating Temperature Range	-30°C to +60°C
Storage Temperature Range	-40°C to +70°C

### Ordering Options

Mount Type	Replace X with
Magnetic	M
Glue	G
Fixed Mount	F
SMA, Female	A

Patterns are available on our website

MARS Antennas & RF Systems proprietary information

MARS reserves the right to make technical changes or modifications to any of its products and specifications without prior notice and without implementing such changes to prior supplied products. Product images are representative and indicative only. Warranty terms and general conditions of sale are applicable on any purchase of any product, available on MARS website.

3 Hamanor st. Holon 5886103, P.O.Box 1852 Holon 5811801, Israel

Tel: +972-3-5599661 • Fax: +972-3-5599677 • e-mail: mars@marsant.co.il • web: www.mars-antennas.com

## MA-AGP15-5

### Active GPS Antenna

MARS Active GPS Antenna features stable and efficient performance. Antenna is small and has an aesthetic design. Custom designs are available upon request.

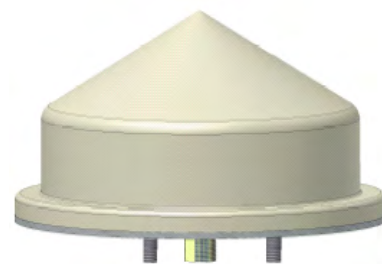

### Specifications

#### Electrical

Frequency range	1575.42±2 MHz
1 dB points Bandwidth, typ.	15 MHz
Gain Characteristics of Antenna Element	+5.0 dBic minimum at zenith -10 dBic minimum at 0° elevation
VSWR, typ.	2 : 1 @ 1575.42
Polarization	Right Hand Circular
3 dB Beam-Width, H-Plane, typ.	360°
3 dB Beam-Width, E-Plane, typ.	±40°
Filtering, typ.	40 dB @ ± 50 MHz
LNA Gain, typ.	25 dB
Noise Figure, typ.	< 1.4 dB
Output Impedance	50 Ohm
Power Supply through RF Cable, typ.	5±0.25 VDC ; 21 mA @ 5 VDC

#### Mechanical

Dimensions (ØxH)	170 X 100 mm
Weight	500 gr.
Connector	N-Type Female
Mount	MNT-22
Radome	UV Protected Polycarbonate

#### Environmental

Operating Temperature	-40°C to +85°C
Dynamics	Vibration: ETSI EN 300-19-2-4
Humidity	ETSI EN 300-19-2-4
Water Proofing	IP-67
Immersion Test	EN 60529-IP67
UV Radiation	ASTM G-154-4
Immunity to electrostatic discharge	ETSI IEC 61000-4-2
Conducted immunity to voltage surges	ETSI IEC 61000-4-5

MARS Antennas & RF Systems proprietary information

MARS reserves the right to make technical changes or modifications to any of its products and specifications without prior notice and without implementing such changes to prior supplied products. Product images are representative and indicative only. Warranty terms and general conditions of sale are applicable on any purchase of any product, available on MARS website.

3 Hamanor st. Holon 5886103, P.O.Box 1852 Holon 5811801, Israel

Tel: +972-3-5599661 • Fax: +972-3-5599677 • e-mail: mars@marsant.co.il • web: www.mars-antennas.com

## MA-PGP15-5

### Passive GPS Antenna

MARS passive GPS Antenna features stable and efficient performance with 5 dBic of gain. Antenna is small and has an aesthetic design. Custom designs are available upon request.

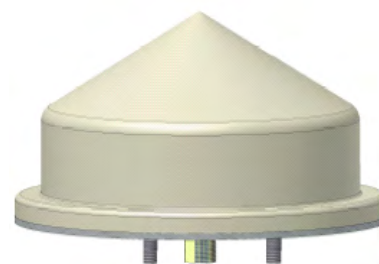

### Specifications

#### **Electrical**

Frequency range	1575.42±2 MHz
GAIN, min.	5 dBic
Gain Characteristics of Antenna Element	-10 dBic minimum at 0° elevation
Axial Ratio	4 dB
VSWR, typ.	1.5 : 1
Polarization	Right Hand Circular
3 dB Beam-Width, Azimuth, typ.	360°
3 dB Beam-Width, Elevation, typ.	±40°
Impedance	50 Ohm

#### **Mechanical**

Dimensions (ØxH)	170 x 100mm (6.7" x 3.9")
Weight	500 gr.
Connector	N-Type Female
Mount	MNT-22
Radome	UV Protected Polycarbonate

#### **Environmental**

Operating Temperature	-40°C to +85°C
Dynamics	Vibration: ETSI EN 300-19-2-4
Humidity	ETSI EN 300-19-2-4
Water Proofing	IP-67
Immersion Test	EN 60529-IP67
UV Radiation	ASTM G-154-4
Immunity to electrostatic discharge	ETSI IEC 61000-4-2
Conducted immunity to voltage surges	ETSI IEC 61000-4-5

MARS Antennas & RF Systems proprietary information

MARS reserves the right to make technical changes or modifications to any of its products and specifications without prior notice and without implementing such changes to prior supplied products. Product images are representative and indicative only. Warranty terms and general conditions of sale are applicable on any purchase of any product, available on MARS website.

3 Hamanor st. Holon 5886103, P.O.Box 1852 Holon 5811801, Israel

Tel: +972-3-5599661 • Fax: +972-3-5599677 • e-mail: mars@marsant.co.il • web: www.mars-antennas.com

## 3.2 GHz – 4.1 GHz

Subscriber - Single Pol  
 Subscriber - Dual Pol  
 Sector- Single Pol  
 Sector – Dual Pol  
 Sector - Double Dual Slant  
 DAS - Single Pol  
 DAS - Dual Pol

Part Number	Description	Frequency band	Gain	Polarization	Dimension	Antenna type	Page
MA-WA35-12	3.5GHz Small Size Subscriber	3.3-3.8 GHz	12 dBi	Linear, Vertical or Horizontal	155 x 155 x 28 mm	Subscriber Single Pol	03-1
MA-WA35-2X-D	Subscriber for WiMAX Applications	3.3-3.8 GHz	18 dBi (min.)	Linear, Vertical	305 x 305 x 15 mm (Diamond shape)	Subscriber Single Pol	03-2
MA-WA36-19	3.5 GHz Subscriber	3.3-3.8 GHz	19 dBi	Linear, Vertical	305 x 305 x 15 mm	Subscriber Single Pol	03-3
MA-WA36-26	3.5 GHz Subscriber	3.3-3.8 GHz	26 dBi	Linear, Vertical	600 x 600 x 30 mm	Subscriber Single Pol	03-4
MA-WA36-DP11	Dual Pol / Dual Slant Subscriber	3.3-4.01 GHz	11 dBi	Dual Pole V & H Dual Slant $\pm 45^\circ$	112 x 112 x 33.5 mm	Subscriber Dual Pol	03-5
MA-WA36-DP14	Dual Pol / Dual Slant Subscriber	3.3-3.8 GHz	14 dBi	Dual Pole V & H Dual Slant $\pm 45^\circ$	200 x 200 x 33 mm	Subscriber Dual Pol	03-6
MA-WA36-DP19	Dual Pol / Dual Slant Subscriber	3.3-4.1 GHz	19.5 dBi	Dual Pole V & H Dual Slant $\pm 45^\circ$	305 x 305 x 25 mm	Subscriber Dual Pol	03-7
MA-WA36-DP21	Dual Pol / Dual Slant Subscriber	3.3-3.8 GHz	22 dBi	Dual Pole V & H Dual Slant $\pm 45^\circ$	370 x 370 x 40 mm	Subscriber Dual Pol	03-8
MA-WA36-DP25	Dual Pol / Dual Slant Subscriber	3.3-3.8 GHz	25 dBi	Dual Pole V & H Dual Slant $\pm 45^\circ$	600 x 600 x 22 mm	Subscriber Dual Pol	03-9
MA-WC36-17	Base Station, 70°	3.3-3.8 GHz	16.5 dBi	Linear, Vertical	573 x 95 x 53 mm	Sector Single Pol	03-10
MA-WD36-16	Base Station, 90°	3.3-3.8 GHz	15.5 dBi	Linear, Vertical	573 x 95 x 53 mm	Sector Single Pol	03-11
MA-WE36-15	Base Station, 120°	3.3-3.8 GHz	14.5 dBi	Linear, Vertical	573 x 95 x 53 mm	Sector Single Pol	03-12
MA-WC35-DS17	Dual Slant WiMAX Base Station, 65°	3.3-3.8 GHz	16.5 dBi (typ.)	Dual Slant $\pm 45^\circ$	600 x 225 x 40 mm	Sector Dual Slant	03-13
MA-WD35-DS15	Dual Slant WiMAX Base Station, 90°	3.3-3.8 GHz	15 dBi (typ.)	Dual Slant $\pm 45^\circ$	600 x 225 x 40 mm	Sector Dual Slant	03-14
MA-WC36-DP15	Dual Polarization Base Station, 60°	3.3-4.01 GHz	15 dBi	Linear, Vertical & Horizontal	370 x 370 x 40 mm	Sector Dual Pol	03-15
MA-WC36-2H15	2 x Horizontal Polarization Base Station, 60°	3.3-4.01 GHz	15 dBi	2 x Horizontal	370 x 370 x 40 mm	Sector Dual Pol	03-16
MA-WC36-2V15	2 x Vertical Polarization Base Station, 60°	3.3-4.01 GHz	15 dBi	2 x Vertical	370 x 370 x 40 mm	Sector Dual Pol	03-17
MA-WD36-DP14N	Dual Polarization Base Station, 90°	3.3-4.01 GHz	14 dBi (typ.)	Dual, Vertical & Horizontal	370 x 370 x 40 mm	Sector Dual Pol	03-18
MA-WC35-2DS17	2 x Dual Slant Base Station Antenna, 65°	3.2-4.1 GHz	4 x 17 dBi	2 x Dual Polarized $\pm 45^\circ$	573 X 360 X 60 mm	Sector Dual Slant	03-19
MA-WD36-MIMO3	Dual Polarization Array 90°	3.3-3.8 GHz	6 x 15 dBi	Dual Slant $\pm 45^\circ$	800 x 600 x 40 mm	Sector Double Dual Slant	03-20
MA-WO-UWB	Ultra Wide Band OMNI Directional	138-174 MHz 380-450 MHz 450-512 MHz 512-698 MHz 698-746 MHz 746-806 MHz 806-960 MHz 1200-2700 MHz 3300-3800 MHz 4100-6000 MHz	3 dBi 4 dBi 5 dBi 5.5 dBi 6 dBi 7 dBi 7 dBi 8 dBi 10 dBi 11 dBi	Linear, Vertical	540 x 40 Dia mm	DAS Single Pol	07-1

MARS Antennas & RF Systems proprietary information

MARS reserves the right to make technical changes or modifications to any of its products and specifications without prior notice and without implementing such changes to prior supplied products. Product images are representative and indicative only. Warranty terms and general conditions of sale are applicable on any purchase of any product, available on MARS website.

3 Hamanor st. Holon 5886103, P.O.Box 1852 Holon 5811801, Israel

Tel: +972-3-5599661 • Fax: +972-3-5599677 • e-mail: mars@marsant.co.il • web: www.mars-antennas.com

Part Number	Description	Frequency band	Gain	Polarization	Dimension	Antenna type	Page
MA-CQ26-1X	380 MHz -6 GHz Multi Band Omni	380-806 MHz 806-960 MHz 1395-1432 MHz 1710-2170 MHz 2300-2500 MHz 3300-3700 MHz 4900-6000 MHz	1 (2*) dBi 4 dBi 5 dBi 5 dBi 5 dBi 5 dBi 6 dBi	Linear, Vertical	Base Dia. - 275 Height - 187 mm	DAS Single Pol	07-2
MA-CQ27-1X	380 MHz -6 GHz Multi Band Omni	380-806 MHz 806-960 MHz 1395-1432 MHz 1710-2170 MHz 2300-2700 MHz 3300-3700 MHz 4900-6000 MHz	1 (2*) dBi 4 dBi 5 dBi 5 dBi 6 dBi 6 dBi 6 dBi	Linear, Vertical	Base Dia. - 275 Height - 187 mm	DAS Single Pol	07-3
MA-CQ29-1X	380 MHz -6 GHz Multi Band Omni	380-806 MHz 806-960 MHz 1700-2500 MHz 2500-2700 MHz 3300-3700 MHz 4900-6000 MHz	1 (2*) dBi 4 dBi 5 dBi 5 dBi 6 dBi 6 dBi	Linear, Vertical	Base Dia. - 275 Height - 187 mm	DAS Single Pol	07-4
MA-WOLTE-3X	LTE, GSM, UMTS, WLAN, Wi-Fi Multi Band Omni	698-806 MHz 806-960 MHz 1710-2170 MHz 2300-2700 MHz 3300-3800 MHz 4900-6500 MHz	2 dBi 2 dBi 3-4 dBi 5 dBi 4 dBi 6 dBi	Linear, Vertical	Base Dia. - 205 Height - 89 mm	DAS Single Pol	07-6
MA-WOLTE-3M1	698-6500 MHz Multi Band Tri-Ports Omni	<a href="#">Port 1 &amp; 2</a> 698-960 MHz 1710-2170 MHz 2.3-2.7 GHz. 3.3-3.8 GHz 4.9- 6.5 GHz <a href="#">Port 3</a> 1710-2170 MHz 2.3-2.7 GHz 3.3-3.8 GHz 4.9- 6.5 GHz	2 dBi 3-4 dBi 5 dBi 4 dBi 6 dBi 3 dBi 3 dBi 4 dBi 6 dBi	Linear, Vertical	Antenna dimension (D,H): 220 x 95 mm  Base dimension (L,W,H): 369 x 270 x 30 mm	DAS Single Pol	07-7
MA-CR26-2X	Multi Band Omni	806-960 MHz 1710-2170 MHz 2300-2700 MHz 3400-3700 MHz 4900-6000 MHz	2 dBi 3-4 dBi 5 dBi 5 dBi 5-6 dBi	Linear, Vertical	Base Dia. - 205 Height - 89 mm	DAS Single Pol	07-12
MA-WOLTE-DP1	698-6500 MHz Multi Band Dual Polarized Omni	<b>Vertical</b> 698-960 MHz 1710-2170 MHz 2.3-2.7 GHz 3.3-3.8 GHz 4.9- 6.5 GHz <b>Horizontal</b> 2.3-2.7 GHz 4.9- 5.875 GHz	4 dBi 5 dBi 5.5 dBi 7 dBi 7.5 dBi 5 dBi 5 dBi	Linear, Vertical	Base Diameter 275 mm  Height 190 mm	DAS Dual Pol	07-8
MA-WOLTE-DP2	698-6500 MHz Multi Band Tri-Ports Omni	<b>Port 1</b> 1.7-2.7 GHz <b>Port 2</b> 4.4-6.6 GHz <b>Port 3</b> 698-960 MHz 1.7-2.3 GHz 2.3-2.7 GHz. 3.3-3.8 GHz 4.5- 6.6 GHz	5 dBi 6 dBi 4 dBi 3-4 dBi 5.5 dBi 4 dBi 6 dBi	Linear, Horizontal  Linear, Horizontal  Linear, Vertical	Antenna dimension (D,H): 220 x 95 mm  (Stand out from the ceiling)	DAS Dual Pol	07-9
MA-WO36-DP10	Dual Pole Omni Directional	3.3-3.8 GHz	Vertical – 9 dBi  Horizontal – 10 dBi	Dual Pole, Vertical & Horizontal	485 x 85 Dia mm	DAS Dual Pol	07-20

MARS Antennas & RF Systems proprietary information

MARS reserves the right to make technical changes or modifications to any of its products and specifications without prior notice and without implementing such changes to prior supplied products. Product images are representative and indicative only. Warranty terms and general conditions of sale are applicable on any purchase of any product, available on MARS website.

3 Hamanor st. Holon 5886103, P.O.Box 1852 Holon 5811801, Israel

Tel: +972-3-5599661 • Fax: +972-3-5599677 • e-mail: mars@marsant.co.il • web: www.mars-antennas.com

## MA-WA35-12

### 3.5 GHz Subscriber Antenna

MARS Small Size Antenna covering the licensed band of 3.5 GHz is designed for LTE, WiFi, WLL and WiMAX applications.

Additional Features:

- High gain/size ratio.
- Small and unobtrusive profile.
- Suitable for both indoor and outdoor applications.



### Specifications

#### Electrical

Frequency range	3.3-3.8 GHz
GAIN, typ.	12 dBi
VSWR, max.	1.5 : 1
Polarization	Linear, Vertical or Horizontal (See Ordering Options)
3 dB Beam-Width, H-Plane, typ.	35°
3 dB Beam-Width, E-Plane, typ.	30°
Side Lobes, min.	-11 dB
Cross Polarization, min.	-15 dB
Front to Back Ratio, min.	-20 dB
Input power, max.	10 Watt
Input Impedance	50 Ohm
Lightning Protection	DC Grounded

#### Mechanical

Dimensions (HxWxD)	155 x 155 x 28 mm (6.1" x 6.1" x 1.1")
Weight	250 gr.
Connector	SMA, Female (At the Bottom of the Antenna)
Back Plane	Aluminum; protected through chemical passivation
Radome	UV Protected Polycarbonate
Mount	See Ordering Options

#### Environmental

Operating Temperature Range	-40°C to +65°C
Vibration	According to IEC 60721-3-4
Flammability	UL94
Water Proofing	IP-67
Humidity	ETS 300 019-1-4, EN 302 085 (annex A.1.1)

#### Standard Compliance

ETSI EN 302 085 V1.2.3 – TS1

### Ordering Options

MA-WA35-12	Antenna with SMA Female Connector suited for MNT-4L, MNT-4U or MNT-4G
MA-WA35-12B	Antenna with SMA Female Connector and mount
MA-WA35-12N	Antenna with SMA, Female Connector Suited for MNT-23 (optional wall/pole adjustable mount)
MA-WA35-12NB	Antenna with SMA, Female Connector and mount MNT-23
MA-WA35-12N & MNT-23H	Antenna with SMA Female Connector and MNT-23H for horizontal polarization

Patterns are available on our website

MARS Antennas & RF Systems proprietary information

MARS reserves the right to make technical changes or modifications to any of its products and specifications without prior notice and without implementing such changes to prior supplied products. Product images are representative and indicative only. Warranty terms and general conditions of sale are applicable on any purchase of any product, available on MARS website.

3 Hamanor st. Holon 5886103, P.O.Box 1852 Holon 5811801, Israel

Tel: +972-3-5599661 • Fax: +972-3-5599677 • e-mail: mars@marsant.co.il • web: www.mars-antennas.com

## MA-WA35-2X-D

### 3.3-3.8 GHz Subscriber Antenna for LTE & WiMAX Applications

MARS High Gain Diamond shaped Antenna, covering from 3.3 GHz to 3.8 GHz, is specially designed for LTE & WiMAX applications.

Additional Features:

- Diamond shape for very low side lobes level.
- Meets and exceeds ETSI TS2 standards.
- Ruggedized for harsh outdoor condition.
- Customized back plane and different connector configurations.
- Aesthetic and unobtrusive profile.



### Specifications

#### Electrical

Frequency range	3.3-3.8 GHz
GAIN, min.	18 dBi
VSWR, max.	1.5 : 1
Polarization	Linear, Vertical (Horizontal with MNT-2 Option)
3 dB Beam-Width, H-Plane, typ.	18°
3 dB Beam-Width, E-Plane, typ.	14°
Side Lobes, min.	-17 dB
Cross Polarization, min.	-17 dB
Front to Back Ratio, min.	-30 dB
Input power, max.	30 Watt
Input Impedance	50 Ohm
Lightning Protection	DC Grounded

#### Mechanical

Dimensions (HxWxD)	305 x 305 x 15 mm (12" x 12" x 0.6")
Weight	840 gr.
Connector	N-Type, Female / Coaxial Cable RD 316 with MCX Connector
Back Plane	Aluminum; protected through chemical passivation
Radome	UV Protected Polycarbonate
Mount	See Ordering Options

#### Environmental

Operating Temperature Range	-40°C to +65°C
Vibration	According to IEC 60721-3-4
Wind Load	200 km/h (survival)
Flammability	UL94
Water Proofing	IP-67
Humidity	ETS 300 019-1-4, EN 302 085 (annex A.1.1)
Salt Fog	According to IEC 68-2-11
Ice and Snow	25mm radial (survival)

#### Standard Compliance

ETSI EN 302 085 V1.2.3 – TS1, TS2

### Ordering Options

MA-WA35-2XD PM	Antenna with integral Pole Mount includes stainless steel brackets
MA-WA35-2XD MNT	Antenna Suited for MNT-22 (optional wall/pole adjustable mount)
MA-WA35-2XD MNTB	Antenna with MNT-22 mount

Patterns are available on our website

MARS Antennas & RF Systems proprietary information

MARS reserves the right to make technical changes or modifications to any of its products and specifications without prior notice and without implementing such changes to prior supplied products. Product images are representative and indicative only. Warranty terms and general conditions of sale are applicable on any purchase of any product, available on MARS website.

3 Hamanor st. Holon 5886103, P.O.Box 1852 Holon 5811801, Israel

Tel: +972-3-5599661 • Fax: +972-3-5599677 • e-mail: mars@marsant.co.il • web: www.mars-antennas.com



## MA-WA36-19

### 3.3-3.8 GHz Subscriber Antenna

MARS 3.5 GHz Antenna suited for the licensed 3.5GHz band is specially designed for LTE & WiMAX applications.

Additional Features:

- Aesthetic and unobtrusive profile.
- Suitable for both indoor and outdoor applications.
- Can be customized with customer defined back plane and different connector configurations.



### Specifications

#### Electrical

Frequency range	3.3-3.8 GHz
GAIN, min.	3.3-3.7 @ 19 dBi 3.7-3.8 @ 18 dBi
VSWR, max.	1.5 : 1
Polarization	Linear, Vertical
3 dB Beam-Width, H-Plane, typ.	16°
3 dB Beam-Width, E-Plane, typ.	16°
Cross Polarization, max	ETSI EN 302 085 v1.2.3 TS2 Range 1
Front to Back Ratio, max.	ETSI EN 302 085 v1.2.3 TS2 Range 1
Side Lobes, min.	ETSI EN 302 085 v1.2.3 TS2 Range 1
Input power, max.	10 Watt
Input Impedance	50 Ohm
Lightning Protection	DC Grounded

#### Mechanical

Dimensions (HxWxD)	305 x 305 x 15 mm (12" x 12" x 0.6")
Weight	840 gr.
Connector	N-Type, Female
Back Plane	Aluminum; protected through chemical passivation
Radome	UV Protected Polycarbonate
Mount	See ordering options

#### Environmental

Operating Temperature Range	-40°C to +65°C
Vibration	According to IEC 60721-3-4
Wind Load	200 km/h (survival)
Flammability	UL94
Water Proofing	IP-65
Humidity	ETS 300 019-1-4, EN 302 085 (annex A.1.1)
Salt Fog	According to IEC 68-2-11
Ice and Snow	25mm radial (survival)

#### Standard Compliance

ETSI EN 302 085 v1.2.3 TS2 Range 1

### Ordering Options

MA-WA36-19	Antenna Suited for MNT-22 (optional wall/pole adjustable mount)
MA-WA36-19B	Antenna with MNT-22 mount

Patterns are available on our website

MARS Antennas & RF Systems proprietary information

MARS reserves the right to make technical changes or modifications to any of its products and specifications without prior notice and without implementing such changes to prior supplied products. Product images are representative and indicative only. Warranty terms and general conditions of sale are applicable on any purchase of any product, available on MARS website.

3 Hamanor st. Holon 5886103, P.O.Box 1852 Holon 5811801, Israel

Tel: +972-3-5599661 • Fax: +972-3-5599677 • e-mail: mars@marsant.co.il • web: www.mars-antennas.com

## MA-WA36-26

### 3.3-3.8 GHz High Gain Subscriber Antenna

MARS Broadband 3.5 GHz High Gain Antenna is designed to provide full coverage for the 3.5 GHz frequency band.

Additional Features:

- Efficient and stable performance.
- Exceptionally high gain/size ratio.
- Durable construction.
- UV protected radome made of polycarbonate suitable for harsh weather installations.



## Specifications

### Electrical

Frequency range	3.3-3.8 GHz
GAIN	26 dBi
VSWR, max.	1.7 : 1
Polarization	Linear Vertical
3 dB Beam-Width, H-Plane, typ.	7.5°
3 dB Beam-Width, E-Plane, typ.	7.5°
Side Lobes, min.	-13 dB
Cross Polarization, min.	-25 dB
Front to Back Ratio, min.	-40 dB
Input power, max.	10 Watt
Input Impedance	50 Ohm
Lightning Protection	DC Grounded

### Mechanical

Dimensions (HxWxD)	600 x 600 x 30 mm (23.5" x 23.5" x 1.2")
Weight	4.5 kg.
Connector	N-Type Female
Back Plane	Aluminum; protected through chemical passivation
Radome	UV Protected, Polycarbonate
Mount	See ordering options

### Environmental

Operating Temperature Range	-40°C to +65°C
Vibration	According to IEC 60721-3-4
Wind Load	200 km/h (Survival)
Flammability	UL94
Water Proofing	IP-67
Humidity	ETS 300 019-1-4, EN 302 085 (Annex A.1.1)
Salt Fog	According to IEC 68-2-11

## Ordering Options

MA-WA36-26	Antenna Suited for MNT-60A (optional wall/pole adjustable mount)
MA-WA36-26B	Antenna with MNT-60A mount

Patterns are available on our website

MARS Antennas & RF Systems proprietary information

MARS reserves the right to make technical changes or modifications to any of its products and specifications without prior notice and without implementing such changes to prior supplied products. Product images are representative and indicative only. Warranty terms and general conditions of sale are applicable on any purchase of any product, available on MARS website.

3 Hamanor st. Holon 5886103, P.O.Box 1852 Holon 5811801, Israel

Tel: +972-3-5599661 • Fax: +972-3-5599677 • e-mail: mars@marsant.co.il • web: www.mars-antennas.com

## MA-WA36-DP11

### 3.3-4.01 GHz Dual Polarization Antenna

MARS 3.6 GHz Dual Polarized Antenna is a wide band antenna designed for LTE, Wi-Fi, LAN, MMDS, WLL and WiMAX applications.

Additional Features:

- Exceptionally efficient performance.
- High gain/size ratio.
- Aesthetic design.
- Weatherized and durable.



## Specifications

### Electrical

Frequency range	3.3-4.01 GHz
Gain, typ.	11 dBi
VSWR, max.	1.7 : 1
Polarization	Dual Pole
	Linear, Vertical & Horizontal (Diamond shape)
3dB Beam-Width, Azimuth, typ.	60°
3dB Beam-Width, Elevation, typ.	40°
Port to Port Isolation, min	-25 dB
Side Lobes, min.	-10 dB
Front to Back Ratio, min.	-17.5 dB
Input power, max.	50 Watt
Input Impedance	50 Ohm

### Mechanical

Dimensions (HxWxD)	112 x 112 x 33.5 mm (4.41" x 4.41" x 1.32")
Connector	2 x Right Angle SMA, Female
Weight	147 gr.
Mounting	See Ordering Options
Radome	UV Protected Polycarbonate
Back Plane	Aluminum protected through chemical passivation.

### Environmental

Operating Temperature Range	-55°C to +65°C
Vibration	According to IEC 60721-3-4
Wind Load	200 Km/h (Survival)
Flammability	UL94
Water Proofing	IP-67
Humidity	ETS 300 019-1-4, EN 302 085 (Annex A.1.1)
Salt Fog	According to IEC 68-2-11

## Ordering Options

MA-WA36-DP11	Antenna 2 x Right Angle SMA ,Female connectors Suited for MNT-4LU mount
MA-WA36-DP11B	Antenna 2 x Right Angle SMA ,Female connectors with MNT-4LU mount

Patterns are available on our website

MARS Antennas & RF Systems proprietary information

MARS reserves the right to make technical changes or modifications to any of its products and specifications without prior notice and without implementing such changes to prior supplied products. Product images are representative and indicative only. Warranty terms and general conditions of sale are applicable on any purchase of any product, available on MARS website.

3 Hamanor st. Holon 5886103, P.O.Box 1852 Holon 5811801, Israel

Tel: +972-3-5599661 • Fax: +972-3-5599677 • e-mail: mars@marsant.co.il • web: www.mars-antennas.com

## MA-WA36-DP14

### 3.3-4.01 GHz Dual Polarization/ Dual Slant Subscriber Antenna

MARS Broadband Dual Polarized Subscriber Antenna provides a cost effective solution for LTE & WiMAX applications.

Additional Features:

- Dual slant if mounted diagonally.
- Stable performance with 14 dBi of gain.
- Compact size allowing easy blending with any environment.
- Mount allowing quick and easy 45deg. turn installation.
- UV protected radome suitable for harsh environment installations.



## Specifications

### Electrical

Frequency range	3.3-4.01 GHz
GAIN, typ.	14 ± 0.5 dBi
VSWR, max.	1.7 : 1
Polarization	Dual Pole Dual Slant (opt.)
	Linear, Vertical & Horizontal ±45° (Diamond Shape)
3 dB Beam-Width, H-Plane, typ.	32°
3 dB Beam-Width, E-Plane, typ.	28°
Side Lobes.	-10 dB
Cross Polarization, min.	-16 dB
Port to Port Isolation, min.	-30 dB
Front to Back Ratio.	-25 dB
Input power, max.	10 Watt
Input Impedance	50 Ohm

### Mechanical

Dimensions (W x L x H)	200 x 200 x 33 mm (7.9" x 7.9" x 1.25")
Connector	See ordering options
Weight	400 gr.
Back Plane	Aluminum; protected through chemical passivation
Radome	UV Protected Polycarbonate
Mounting	See ordering options

### Environmental

Operating Temperature Range	-55°C to +65°C
Vibration	According to IEC 60721-3-4
Flammability	UL94
Water Proofing	IP-67
Humidity	ETS 300 019-1-4, EN 302 085 (Annex A.1.1)
Salt Fog	According to IEC 68-2-11

## Ordering Options

MA-WA36-DP14	Antenna 2 x N-Type Female connectors Suited for MNT-23 mount
MA-WA36-DP14B	Antenna 2 x N-Type Female connectors with MNT-23 mount
MA-WA36-DP14SMES	Antenna 2 x SMA RA Female connectors, enclosure with MNT-22 mount

Patterns are available on our website

MARS Antennas & RF Systems proprietary information

MARS reserves the right to make technical changes or modifications to any of its products and specifications without prior notice and without implementing such changes to prior supplied products. Product images are representative and indicative only. Warranty terms and general conditions of sale are applicable on any purchase of any product, available on MARS website.

3 Hamanor st. Holon 5886103, P.O.Box 1852 Holon 5811801, Israel

Tel: +972-3-5599661 • Fax: +972-3-5599677 • e-mail: mars@marsant.co.il • web: www.mars-antennas.com

## MA-WA36-DP91

### 3.3-4.01 GHz Dual Polarization/ Dual Slant Subscriber Antenna

MARS Broadband Dual Polarized Subscriber Antenna provides a cost effective solution for LTE & WiMAX applications.

Additional Features:

- Dual slant if mounted diagonally.
- Stable performance with 19.5 dBi of gain.
- Compact size allowing easy blending with any environment.
- Mount suitable for quick and easy 45deg. turn installation.
- UV protected radome suitable for harsh environment installations.



## Specifications

### Electrical

Frequency range	3.3-4.01 GHz
GAIN, typ.	19.5 ± 0.5 dBi
VSWR, max.	1.7 : 1
Polarization	Dual Pole Dual Slant (opt.)
	Linear, Vertical & Horizontal ±45°
3 dB Beam-Width, H-Plane, typ.	17°
3 dB Beam-Width, E-Plane, typ.	17°
Cross Polarization, min.	-23 dB
Front to Back Ratio, min.	-35 dB
Side Lobes, min.	-12 dB @ 3.3-3.8 GHz -11 dB @ 3.8-4.01 GHz
Port to Port Isolation, min.	-30 dB
Input power, max.	50 Watt
Input Impedance	50 Ohm
Lightning Protection	DC Grounded

### Mechanical

Dimensions (HxWxD)	305 x 305 x 25 mm (12" x 12" x 1")
Weight	1.3 kg.
Connector	2 x N-Type, Female
Back Plane	Aluminum; protected through chemical passivation
Radome	UV Protected Polycarbonate
Mount	See ordering options

### Environmental

Operating Temperature Range	-55°C to +65°C
Vibration	According to IEC 60721-3-4
Wind Load	200 km/h (survival)
Flammability	UL94
Water Proofing	IP-67
Humidity	ETS 300 019-1-4, EN 302 085 (annex A.1.1)
Salt Fog	According to IEC 68-2-11
Ice and Snow	25mm radial (survival)

### Standard Compliance

ESTI TS3

## Ordering Options

MA-WA36-DP19	Antenna with 2xN-Type, Female Connector Suited for MNT-22
MA-WA36-DP19B	Antenna with 2xN-Type, Female Connector and MNT-22 mount

Patterns are available on our website

MARS Antennas & RF Systems proprietary information

MARS reserves the right to make technical changes or modifications to any of its products and specifications without prior notice and without implementing such changes to prior supplied products. Product images are representative and indicative only. Warranty terms and general conditions of sale are applicable on any purchase of any product, available on MARS website.

3 Hamanor st. Holon 5886103, P.O.Box 1852 Holon 5811801, Israel

Tel: +972-3-5599661 • Fax: +972-3-5599677 • e-mail: mars@marsant.co.il • web: www.mars-antennas.com

## MA-WA36-DP21

### 3.3-3.8 GHz Dual Polarization/ Dual Slant Subscriber Antenna

MARS Broadband Dual Polarized Subscriber Antenna provides a cost effective solution for LTE & WiMAX applications.

Additional Features:

- Dual slant if mounted diagonally.
- Stable performance with 22 dBi of gain.
- Compact size allowing easy blending with any environment.
- Mount allowing quick and easy 45deg. turn installation.
- UV protected radome suitable for harsh environment installations.



### Specifications

#### Electrical

Frequency range	3.3-3.8 GHz
GAIN: H-Port & V-Port	22 dBi
VSWR, max.	1.7 : 1
Polarization Dual Pole Dual Slant (opt.)	Linear, Vertical & Horizontal ±45°
3 dB Beam-Width, H-Plane, typ.	12°
3 dB Beam-Width, E-Plane, typ.	12°
Cross Polarization, max	ETSI TS3
Front to Back Ratio, max.	ETSI TS3
Side Lobes, min.	ETSI TS3
Port to Port Isolation, typ.	-35 dB
Input power, max.	10 Watt
Input Impedance	50 Ohm
Lightning Protection	DC Grounded

#### Mechanical

Dimensions (HxWxD)	370 x 370 x 40 mm (14.5" x 14.5" x 1.6")
Weight	2.1 kg.
Connector	See ordering options
Back Plane	Aluminum; protected through chemical passivation
Radome	UV Protected Polycarbonate
Mount	See ordering options

#### Environmental

Operating Temperature Range	-55°C to +65°C
Vibration	According to IEC 60721-3-4
Wind Load	200 km/h (survival)
Flammability	UL94
Water Proofing	IP-67
Humidity	ETS 300 019-1-4, EN 302 085 (annex A.1.1)
Salt Fog	According to IEC 68-2-11

### Ordering Options

MA-WA36-DP21	Antenna with 2xSMA, Female Connector Suited for MNT-22
MA-WA36-DP21B	Antenna with 2xSMA, Female Connector and MNT-22 mount
MA-WA36-DP21N	Antenna with 2xN-Type, Female Connector suited for MNT-22
MA-WA36-DP21NB	Antenna with 2xN-Type, Female Connector and MNT-22 mount

Patterns are available on our website

MARS Antennas & RF Systems proprietary information

MARS reserves the right to make technical changes or modifications to any of its products and specifications without prior notice and without implementing such changes to prior supplied products. Product images are representative and indicative only. Warranty terms and general conditions of sale are applicable on any purchase of any product, available on MARS website.

3 Hamanor st. Holon 5886103, P.O.Box 1852 Holon 5811801, Israel

Tel: +972-3-5599661 • Fax: +972-3-5599677 • e-mail: mars@marsant.co.il • web: www.mars-antennas.com

## MA-WA36-DP25

### 3.3-3.8 GHz High Gain Dual Polarized/ Dual Slant Antenna

MARS 3.5GHz High Gain Antenna is designed to provide full coverage for the 3.5 GHz frequency band.

Additional Features:

- Efficient and stable performance
- High gain/size ratio
- Durable construction
- UV protected radome made of polycarbonate allowing harsh weather installations



## Specifications

### Electrical

Frequency range	3.3-3.8 GHz
GAIN, typ.	25 ± 1 dBi
VSWR, max.	1.7 : 1
Polarization	Dual Pole Dual Slant (opt.)
	Linear, Vertical & Horizontal ±45°
3 dB Beam-Width, H-Plane, typ.	8°
3 dB Beam-Width, E-Plane, typ.	8°
Side Lobes, min.	ETSI TS3
Cross Polarization, min.	ETSI TS3
Front to Back Ratio, min.	ETSI TS3
Input power, max.	10 Watt
Input Impedance	50 Ohm
Lightning Protection	DC Grounded

### Mechanical

Dimensions (HxWxD)	600 x 600 x 22 mm (23.5" x 23.5" x 0.86")
Weight	4.7 kg.
Connector	2 x N-Type Female
Back Plane	Aluminum; protected through chemical passivation
Radome	UV Protected, Polycarbonate
Mount	See ordering options

### Environmental

Operating Temperature Range	-40°C to +65°C
Vibration	According to IEC 60721-3-4
Wind Load	200 km/h (Survival)
Flammability	UL94
Water Proofing	IP-67
Humidity	ETS 300 019-1-4, EN 302 085 (Annex A.1.1)
Salt Fog	According to IEC 68-2-11

## Ordering Options

MA-WA36-DP25	Antenna Suited for MNT-60A (optional wall/pole adjustable mount)
MA-WA36-DP25B	Antenna with MNT-60A mount

Patterns are available on our website

MARS Antennas & RF Systems proprietary information

MARS reserves the right to make technical changes or modifications to any of its products and specifications without prior notice and without implementing such changes to prior supplied products. Product images are representative and indicative only. Warranty terms and general conditions of sale are applicable on any purchase of any product, available on MARS website.

3 Hamanor st. Holon 5886103, P.O.Box 1852 Holon 5811801, Israel

Tel: +972-3-5599661 • Fax: +972-3-5599677 • e-mail: mars@marsant.co.il • web: www.mars-antennas.com

## MA-WC36-17

### 3.3-3.8 GHz Sector Antenna for LTE & WiMAX Applications, 70°

MARS 70° Base Station Antenna is light-weight yet has a robust and durable construction.

Additional Features:

- Specially designed for LTE & WiMAX applications.
- Quick and easy installation.
- Easy mounting allowing obtaining required down tilt.
- Suitable for harsh environment installations.
- DC grounded.

Applications:

- Licensed band applications.
- Point-to-Multi Point Applications.
- WLL applications.



## Specifications

### Electrical

Frequency range	3.3-3.8 GHz
GAIN, typ.	16.5 dBi
VSWR, max.	1.7 : 1
Polarization	Linear, Vertical
3 dB Beam-Width, H-Plane, typ.	70°
3 dB Beam-Width, E-Plane, typ.	9°
Side Lobes, min.	ETSI EN 302 085 V1.2.3-CS1
Cross Polarization, min.	ETSI EN 302 085 V1.2.3-CS1
Front to Back Ratio, min.	ETSI EN 302 085 V1.2.3-CS1
Input power, max	50 Watt
Input Impedance	50 Ohm
Lightning Protection	DC Grounded

### Mechanical

Dimensions (HxWxD)	573 x 95 x 53 mm (22.6" x 3.7" x 2.1")
Weight	700 gr.
Connector	N-Type, Female
Back Plane	Aluminum; protected through chemical passivation
Radome	UV Protected Polycarbonate
Mount	See ordering options

### Environmental

Operating Temperature Range	-40°C to +65°C
Vibration	According to IEC 60721-3-4
Wind Load	200 km/h (survival)
Flammability	UL94
Water Proofing	IP-67
Humidity	ETS 300 019-1-4, EN 302 085 (annex A.1.1)
Salt Fog	According to IEC 68-2-11
Ice and Snow	25mm radial (survival)

### Standard Compliance

ETSI EN 302 085 V1.2.3 – CS1

## Ordering Options

MA-WC36-17	Antenna Suited for MNT-22 (optional wall/pole adjustable mount)
MA-WC36-17B	Antenna with MNT-22 mount

Patterns are available on our website

MARS Antennas & RF Systems proprietary information

MARS reserves the right to make technical changes or modifications to any of its products and specifications without prior notice and without implementing such changes to prior supplied products. Product images are representative and indicative only. Warranty terms and general conditions of sale are applicable on any purchase of any product, available on MARS website.

3 Hamanor st. Holon 5886103, P.O.Box 1852 Holon 5811801, Israel

Tel: +972-3-5599661 • Fax: +972-3-5599677 • e-mail: mars@marsant.co.il • web: www.mars-antennas.com



## MA-WD36-16

### 3.3-3.8 GHz Sector Antenna for WiMAX Applications, 90°

MARS 90° Base Station Antenna is light-weight with a robust and durable construction.

Additional Features:

- Specially designed for WiMAX applications.
- Quick and easy installation.
- Easy mounting allowing obtaining required down tilt.
- Suitable for harsh environment installations.
- DC grounded.

Applications:

- WiMAX – licensed band applications.
- Point-to-Multi Point Applications.
- WLL applications.



## Specifications

### Electrical

Frequency range	3.3-3.8 GHz
GAIN, typ.	15.5 dBi
VSWR, max.	1.7 : 1
Polarization	Linear, Vertical
3 dB Beam-Width, H-Plane, typ.	90°
3 dB Beam-Width, E-Plane, typ.	9°
Side Lobes, min.	ETSI EN 302 085 V1.2.3-CS1
Cross Polarization, min.	ETSI EN 302 085 V1.2.3-CS1
Front to Back Ratio, min.	ETSI EN 302 085 V1.2.3-CS1
Input power, max.	50 Watt
Input Impedance	50 Ohm
Lightning Protection	DC Grounded

### Mechanical

Dimensions (HxWxD)	573 x 95 x 53 mm (22.6" x 3.7" x 2.1")
Weight	700 gr.
Connector	N-Type, Female
Back Plane	Aluminum; protected through chemical passivation
Radome	UV Protected Polycarbonate
Mount	See ordering options

### Environmental

Operating Temperature Range	-40°C to +65°C
Vibration	According to IEC 60721-3-4
Wind Load	200 km/h (survival)
Flammability	UL94
Water Proofing	IP-67
Humidity	ETS 300 019-1-4, EN 302 085 (annex A.1.1)
Salt Fog	According to IEC 68-2-11
Ice and Snow	25mm radial (survival)

### Standard Compliance

ETSI EN 302 085 V1.2.3 – CS1

## Ordering Options

MA-WD36-16	Antenna Suited for MNT-22 (optional wall/pole adjustable mount)
MA-WD36-16B	Antenna with MNT-22 mount

Patterns are available on our website

MARS Antennas & RF Systems proprietary information

MARS reserves the right to make technical changes or modifications to any of its products and specifications without prior notice and without implementing such changes to prior supplied products. Product images are representative and indicative only. Warranty terms and general conditions of sale are applicable on any purchase of any product, available on MARS website.

3 Hamanor st. Holon 5886103, P.O.Box 1852 Holon 5811801, Israel

Tel: +972-3-5599661 • Fax: +972-3-5599677 • e-mail: mars@marsant.co.il • web: www.mars-antennas.com

## MA-WE36-15

### 3.3-3.8 GHz Sector Antenna for LTE & WiMAX Applications, 120°

MARS 120° Base Station Antenna is light-weight yet has a robust and durable construction.

Additional Features:

- Specially designed for LTE & WiMAX applications.
- Quick and easy installation.
- Easy mounting allowing obtaining required down tilt.
- Suitable for harsh environment installations.
- DC grounded.

Applications:

- Licensed band applications.
- Point-to-Multi Point Applications.
- WLL applications.



## Specifications

### Electrical

Frequency range	3.3-3.8 GHz
GAIN, typ.	14.5 dBi
VSWR, max.	1.7 : 1
Polarization	Linear, Vertical
3 dB Beam-Width, H-Plane, typ.	120°
3 dB Beam-Width, E-Plane, typ.	9°
Side Lobes, min.	ETSI EN 302 085 V1.2.3-CS1
Cross Polarization, min.	ETSI EN 302 085 V1.2.3-CS1
Front to Back Ratio, min.	ETSI EN 302 085 V1.2.3-CS1
Input power, max.	50 Watt
Input Impedance	50 Ohm
Lightning Protection	DC Grounded

### Mechanical

Dimensions (HxWxD)	573 x 95 x 53 mm (22.6" x 3.7" x 2.1")
Weight	700 gr.
Connector	N-Type, Female
Back Plane	Aluminum; protected through chemical passivation
Radome	UV Protected Polycarbonate
Mount	See ordering options

### Environmental

Operating Temperature Range	-40°C to +65°C
Vibration	According to IEC 60721-3-4
Wind Load	200 km/h (survival)
Flammability	UL94
Water Proofing	IP-67
Humidity	ETS 300 019-1-4, EN 302 085 (annex A.1.1)
Salt Fog	According to IEC 68-2-11
Ice and Snow	25mm radial (survival)

### Standard Compliance

ETSI EN 302 085 V1.2.3 – CS1

## Ordering Options

MA-WE36-15	Antenna Suited for MNT-22 (optional wall/pole adjustable mount)
MA-WE36-15B	Antenna with MNT-22 mount

Patterns are available on our website

MARS Antennas & RF Systems proprietary information

MARS reserves the right to make technical changes or modifications to any of its products and specifications without prior notice and without implementing such changes to prior supplied products. Product images are representative and indicative only. Warranty terms and general conditions of sale are applicable on any purchase of any product, available on MARS website.

3 Hamanor st. Holon 5886103, P.O.Box 1852 Holon 5811801, Israel

Tel: +972-3-5599661 • Fax: +972-3-5599677 • e-mail: mars@marsant.co.il • web: www.mars-antennas.com

## MA-WC35-DS17

### 3.3-3.8 GHz Dual Slant LTE & WiMAX Base Station Antenna, 65°

MARS Dual Slant Base Station Antenna is light-weight yet has a robust and durable construction.

Additional Features:

- Specially designed for LTE & WiMAX applications.
- Quick and easy installation.
- Easy mounting allowing obtaining required down tilt.
- Suitable for harsh environment installations.
- DC grounded.

Applications:

- Licensed band applications.
- Point-to-Multi Point Applications.
- WLL applications.



## Specifications

### Electrical

Frequency range	3.3-3.8 GHz
GAIN, typ.	16.5 dBi
VSWR, max.	1.7 : 1
Polarization	Dual Polarized ±45°
3 dB Beam-Width, H-Plane, typ.	65°
3 dB Beam-Width, E-Plane, typ.	8°
Down tilt, E-Plane	2°
Front to Back Ratio.	-25 dB
Port to Port Isolation	-30 dB
Input power, max	50 Watt
Input Impedance	50 Ohm
Lightning Protection	DC Grounded

### Mechanical

Dimensions (HxWxD)	600 x 225 x 40 mm (23.6" x 8.9" x 1.6")
Weight	1.8 kg.
Connector	2 x N-Type, Female (bottom)
Back Plane	Aluminum protected through chemical passivation
Radome	UV Protected Plastic
Mount	See ordering options

### Environmental

Operating Temperature Range	-40°C to +65°C
Vibration	According to IEC 60721-3-4
Wind Load	200 km/h (survival)
Flammability	UL94
Water Proofing	IP-65
Humidity	ETS 300 019-1-4, EN 302 085 (annex A.1.1)
Salt Fog	According to IEC 68-2-11
Ice and Snow	25mm radial (survival)

### Standard Compliance

ETSI EN 302 085 V1.2.3 – CS1

## Ordering Options

MA-WC35-DS17	Antenna Suited for MNT-22 (optional wall/pole adjustable mount)
MA-WC35-DS17B	Antenna with MNT-22 mount

Patterns are available on our website

MARS Antennas & RF Systems proprietary information

MARS reserves the right to make technical changes or modifications to any of its products and specifications without prior notice and without implementing such changes to prior supplied products. Product images are representative and indicative only. Warranty terms and general conditions of sale are applicable on any purchase of any product, available on MARS website.

3 Hamanor st. Holon 5886103, P.O.Box 1852 Holon 5811801, Israel

Tel: +972-3-5599661 • Fax: +972-3-5599677 • e-mail: mars@marsant.co.il • web: www.mars-antennas.com

## MA-WD35-DS15

### 3.3-3.8 GHz Dual Slant WiMAX Base Station Antenna, 90°

MARS Dual Slant Base Station Antenna is light-weight yet has a robust and durable construction.

Additional Features:

- Specially designed for WiMAX applications.
- Quick and easy installation.
- Easy mounting allowing obtaining required down tilt.
- Suitable for harsh environment installations.
- DC grounded.

Applications:

- WiMAX – licensed band applications.
- Point-to-Multi Point Applications.
- WLL applications.



### Specifications

#### Electrical

Frequency range	3.3-3.8 GHz
GAIN, typ.	15 dBi
VSWR, max.	1.7 : 1
Polarization	Dual Polarized $\pm 45^\circ$
3 dB Beam-Width, H-Plane, typ.	90°
3 dB Beam-Width, E-Plane, typ.	8°
Down tilt, E-Plane	2°
Front to Back Ratio.	-20 dB
Port to Port Isolation	-30 dB
Input power, max.	50 Watt
Input Impedance	50 Ohm
Lightning Protection	DC Grounded

#### Mechanical

Dimensions (HxWxD)	600 x 225 x 40 mm (23.6" x 8.9" x 1.6")
Weight	1.8 kg.
Connector	2 x N-Type, Female (bottom)
Back Plane	Aluminum protected through chemical passivation
Radome	UV Protected Plastic
Mount	See ordering options

#### Environmental

Operating Temperature Range	-40°C to +65°C
Vibration	According to IEC 60721-3-4
Wind Load	200 km/h (survival)
Flammability	UL94
Water Proofing	IP-65
Humidity	ETS 300 019-1-4, EN 302 085 (annex A.1.1)
Salt Fog	According to IEC 68-2-11
Ice and Snow	25mm radial (survival)

#### Standard Compliance

ETSI EN 302 085 V1.2.3 – CS1

### Ordering Options

MA-WD35-DS15	Antenna Suited for MNT-22 (optional wall/pole adjustable mount)
MA-WD35-DS15B	Antenna with MNT-22 mount

Patterns are available on our website

MARS Antennas & RF Systems proprietary information

MARS reserves the right to make technical changes or modifications to any of its products and specifications without prior notice and without implementing such changes to prior supplied products. Product images are representative and indicative only. Warranty terms and general conditions of sale are applicable on any purchase of any product, available on MARS website.

3 Hamanor st. Holon 5886103, P.O.Box 1852 Holon 5811801, Israel

Tel: +972-3-5599661 • Fax: +972-3-5599677 • e-mail: mars@marsant.co.il • web: www.mars-antennas.com

## MA-WC36-DP15

### 3.3-4.01 GHz Dual Polarization Base Station Antenna, 60°

MARS 60° Broadband Dual Polarized Sector Antenna provides a cost effective solution for LTE & WiMAX applications.

Additional Features:

- Stable performance with 15dBi of gain.
- Compact size allowing for easy blending with any environment.
- Tilt mount allowing quick and easy installation.
- UV protected radome suitable for harsh environment installations.



## Specifications

### Electrical

Frequency range	3.3-4.01 GHz
GAIN, typ.	15 dBi
VSWR, max.	1.7 : 1
Polarization	Linear, Vertical & Horizontal
3 dB Beam-Width, Az-Plane, typ.	60°
3 dB Beam-Width, El-Plane, typ.	12°
Side Lobes, typ.	-12 dB
Cross Polarization, min.	-15 dB
Port to Port Isolation, min.	-30 dB
Front to Back Ratio, min.	-35 dB
Input power, max.	10 Watt
Input Impedance	50 Ohm
Lightning Protection	DC Grounded

### Mechanical

Dimensions (HxWxD)	370 x 370 x 40 mm (14.5" x14.5" x1.6")
Connector	2 x N-Type, Female
Weight	2 Kg.
Back Plane	Aluminum; protected through chemical passivation
Radome	UV Protected Polycarbonate
Mounting	See Ordering Options

### Environmental

Operating Temperature Range	-55°C to +65°C
Vibration	According to IEC 60721-3-4
Wind Load	200 Km/h (Survival)
Flammability	UL94
Water Proofing	IP-65
Humidity	ETS 300 019-1-4,EN 302 085 (Annex A.1.1)
Salt Fog	According to IEC 68-2-11
Ice and Snow	25mm radial (survival)

## Ordering Options

MA-WC36-DP15	Antenna Suited for MNT-22 (optional wall/pole adjustable mount)
MA-WC36-DP15B	Antenna with MNT-22 mount

MARS Antennas & RF Systems proprietary information

MARS reserves the right to make technical changes or modifications to any of its products and specifications without prior notice and without implementing such changes to prior supplied products. Product images are representative and indicative only. Warranty terms and general conditions of sale are applicable on any purchase of any product, available on MARS website.

3 Hamanor st. Holon 5886103, P.O.Box 1852 Holon 5811801, Israel

Tel: +972-3-5599661 • Fax: +972-3-5599677 • e-mail: mars@marsant.co.il • web: www.mars-antennas.com

## MA-WC36-2H15

### 3.3-4.01 GHz 2 x Horizontal Polarization Base Station Antenna, 60°

MARS 60° Broadband Dual Horizontal Sector Antenna provides a cost effective solution for LTE & WiMAX applications.

Additional Features:

- Stable performance with 15dBi of gain.
- Compact size allowing for easy blending with any environment.
- Tilt mount allowing quick and easy installation.
- UV protected radome suitable for harsh environment installations.



## Specifications

### Electrical

Frequency range	3.3-4.01 GHz
GAIN, typ.	15 dBi
VSWR, max.	1.7 : 1
Polarization	2 x Horizontal
3 dB Beam-Width, Az-Plane, typ.	60°
3 dB Beam-Width, El-Plane, typ.	12°
Side Lobes, typ.	-12 dB
Cross Polarization, min.	-15 dB
Port to Port Isolation, min.	-30 dB
Front to Back Ratio, min.	-35 dB
Input power, max.	10 Watt
Input Impedance	50 Ohm
Lightning Protection	DC Grounded

### Mechanical

Dimensions (HxWxD)	370 x 370 x 40 mm (14.5" x14.5" x1.6")
Connector	2 x N-Type, Female
Weight	2 Kg.
Back Plane	Aluminum; protected through chemical passivation
Radome	UV Protected Polycarbonate
Mounting	See Ordering Options

### Environmental

Operating Temperature Range	-55°C to +65°C
Vibration	According to IEC 60721-3-4
Wind Load	200 Km/h (Survival)
Flammability	UL94
Water Proofing	IP-65
Humidity	ETS 300 019-1-4, EN 302 085 (Annex A.1.1)
Salt Fog	According to IEC 68-2-11
Ice and Snow	25mm radial (survival)

## Ordering Options

MA-WC36-2H15	Antenna Suited for MNT-22 (optional wall/pole adjustable mount)
MA-WC36-2H15B	Antenna with MNT-22 mount

MARS Antennas & RF Systems proprietary information

MARS reserves the right to make technical changes or modifications to any of its products and specifications without prior notice and without implementing such changes to prior supplied products. Product images are representative and indicative only. Warranty terms and general conditions of sale are applicable on any purchase of any product, available on MARS website.

3 Hamanor st. Holon 5886103, P.O.Box 1852 Holon 5811801, Israel

Tel: +972-3-5599661 • Fax: +972-3-5599677 • e-mail: mars@marsant.co.il • web: www.mars-antennas.com

## MA-WC36-2V15

### 3.3-4.01 GHz 2 x Vertical Polarization Base Station Antenna, 60°

MARS 60° Broadband Dual Vertical Sector Antenna provides a cost effective solution for LTE & WiMAX applications.

Additional Features:

- Stable performance with 15dBi of gain.
- Compact size allowing for easy blending with any environment.
- Tilt mount allowing quick and easy installation.
- UV protected radome suitable for harsh environment installations.



## Specifications

### Electrical

Frequency range	3.3-4.01 GHz
GAIN, typ.	15 dBi
VSWR, max.	1.7 : 1
Polarization	2 x Vertical
3 dB Beam-Width, Az-Plane, typ.	60°
3 dB Beam-Width, El-Plane, typ.	12°
Side Lobes, typ.	-12 dB
Cross Polarization, min.	-15 dB
Port to Port Isolation, min.	-30 dB
Front to Back Ratio, min.	-35 dB
Input power, max.	10 Watt
Input Impedance	50 Ohm
Lightning Protection	DC Grounded

### Mechanical

Dimensions (HxWxD)	370 x 370 x 40 mm (14.5" x14.5" x1.6")
Connector	2 x N-Type, Female
Weight	2 Kg.
Back Plane	Aluminum; protected through chemical passivation
Radome	UV Protected Polycarbonate
Mounting	See Ordering Options

### Environmental

Operating Temperature Range	-55°C to +65°C
Vibration	According to IEC 60721-3-4
Wind Load	200 Km/h (Survival)
Flammability	UL94
Water Proofing	IP-65
Humidity	ETS 300 019-1-4,EN 302 085 (Annex A.1.1)
Salt Fog	According to IEC 68-2-11
Ice and Snow	25mm radial (survival)

## Ordering Options

MA-WC36-2V15	Antenna Suited for MNT-22 (optional wall/pole adjustable mount)
MA-WC36-2V15B	Antenna with MNT-22 mount

MARS Antennas & RF Systems proprietary information

MARS reserves the right to make technical changes or modifications to any of its products and specifications without prior notice and without implementing such changes to prior supplied products. Product images are representative and indicative only. Warranty terms and general conditions of sale are applicable on any purchase of any product, available on MARS website.

3 Hamanor st. Holon 5886103, P.O.Box 1852 Holon 5811801, Israel

Tel: +972-3-5599661 • Fax: +972-3-5599677 • e-mail: mars@marsant.co.il • web: www.mars-antennas.com

## MA-WD36-DP14N

### 3.3-4.01 GHz Dual Polarized Base Station Antenna, 90°

MARS 90° Broadband Dual Polarized Sector Antenna provides a cost effective solution for LTE & WiMAX applications.

Additional Features:

- Stable performance with 14 dBi of gain.
- Compact size allowing for easy blending with any environment.
- Tilt mount allowing quick and easy installation.
- UV protected radome suitable for harsh environment installations.



## Specifications

### Electrical

Frequency range	3.3-4.01 GHz
GAIN, typ.	14 dBi
VSWR, max.	1.7 : 1
Polarization	Dual, Vertical & Horizontal
3 dB Beam-Width, Azimuth, typ.	90°
3 dB Beam-Width, Elevation, typ.	12°
Side Lobes, min.	-12 dB
Front to Back Ratio, min.	-30 dB
Cross Polarization, min.	-15 dB
Port to Port Isolation, typ.	-30 dB
Input power, max.	10 Watt
Input Impedance	50 Ohm
Lightning Protection	DC Grounded

### Mechanical

Dimensions (HxWxD)	370 x 370 x 40 mm (14.5" x 14.5" x 1.6")
Weight	2 Kg.
Connector	2 x N-Type, Female
Back Plane	Aluminum protected through chemical passivation
Radome	UV Protected Polycarbonate
Mount	See ordering options

### Environmental

Operating Temperature Range	-55°C to +65°C
Vibration	According to IEC 60721-3-4
Wind Load	200 km/h (survival)
Flammability	UL94
Water Proofing	IP-67
Humidity	ETS 300 019-1-4, EN 302 085 (annex A.1.1)
Salt Fog	According to IEC 68-2-11
Ice and Snow	25mm radial (survival)

## Ordering Options

MA-WD36-DP14N	Antenna Suited for MNT-22 (optional wall/pole adjustable mount)
MA-WD36-DP14NB	Antenna with MNT-22 mount

MARS Antennas & RF Systems proprietary information

MARS reserves the right to make technical changes or modifications to any of its products and specifications without prior notice and without implementing such changes to prior supplied products. Product images are representative and indicative only. Warranty terms and general conditions of sale are applicable on any purchase of any product, available on MARS website.

3 Hamanor st. Holon 5886103, P.O.Box 1852 Holon 5811801, Israel

Tel: +972-3-5599661 • Fax: +972-3-5599677 • e-mail: mars@marsant.co.il • web: www.mars-antennas.com



## MA-WC35-2DS17

### 3.2 - 4.1 GHz 2 x Dual Slant Base Station Antenna, 65°

MARS wideband sector antenna provides coverage of 3.2-4.1 GHz with double dual slant ( $\pm 45^\circ$ ) in a single antenna radome.

Additional Features:

- Wide coverage.
- Total 4 outputs.



## Specifications

### Electrical

Frequency range	3.2-4.1 GHz
GAIN, typ.	4 x 17 dBi
VSWR, max.	<2: 1
Polarization	2 x Dual Polarized $\pm 45^\circ$
3 dB Beam-Width, H-Plane, typ.	65°
3 dB Beam-Width, E-Plane, typ.	8°
Side Lobes, typ.	-12 dB
Front to Back Ratio.	-30 dB
Port to Port Isolation, typ.	-30 dB
Input power, max	50 Watt
Input Impedance	50 Ohm
Lightning Protection	DC Grounded

### Mechanical

Dimensions (HxWxD)	573 X 360 X 60 mm (22.6" X 14.2" X 2.4")
Weight	1.86 kg.
Connector	4 x N-Type, Female
Back Plane	Aluminum protected through chemical passivation
Radome	UV Protected Plastic
Mount	MNT-60

### Environmental

Operating Temperature Range	-40°C to +65°C
Vibration	According to IEC 60721-3-4
Wind Load	200 km/h (survival)
Flammability	UL94
Water Proofing	IP-65
Humidity	ETS 300 019-1-4, EN 302 085 (annex A.1.1)
Salt Fog	According to IEC 68-2-11
Ice and Snow	25mm radial (survival)

## Ordering Options

MA-WC35-2DS17	Antenna Suited for MNT-60A (optional wall/pole adjustable mount)
MA-WC35-2DS17B	Antenna with MNT-60A mount

MARS Antennas & RF Systems proprietary information

MARS reserves the right to make technical changes or modifications to any of its products and specifications without prior notice and without implementing such changes to prior supplied products. Product images are representative and indicative only. Warranty terms and general conditions of sale are applicable on any purchase of any product, available on MARS website.

3 Hamanor st. Holon 5886103, P.O.Box 1852 Holon 5811801, Israel

Tel: +972-3-5599661 • Fax: +972-3-5599677 • e-mail: mars@marsant.co.il • web: www.mars-antennas.com

## MA-WD36-MIMO3

### 3.3-3.8 GHz, 15dBi Dual Polarized Antenna Array, 90°

#### Antenna Features:

- 3 columns dual slant antenna arrays.
- Total 6 outputs.
- Quick and easy installation.
- Easy mounting allows obtain required down tilt.
- Suitable for harsh environment installations.
- DC grounded.

#### Applications:

- Licensed band applications.
- Point-to-Multi Point Applications.
- WLL applications.



## Specifications

### Electrical

Frequency range	3.3-3.8 GHz
GAIN, min.	6 x 15 dBi
VSWR, max.	1.8 : 1
Polarization	Dual Slant ±45°
3 dB Beam-Width, H-Plane, typ.	90°
3 dB Beam-Width, E-Plane, typ.	8°
Side Lobes, min. Elevation Plane	-12 dB
Azimuth Plane	-20 dB
Cross Polarization Discrimination, typ.	-20 dB
Port to Port Isolation, min.	20 dB
Front to Back Ratio, min.	30 dB
Array Element Spacing	136 mm (1.5λ on 3.3 GHz)
Input power, max.	5 Watts average, 50 Watts peak
Input Impedance	50 Ohm
Lightning Protection	DC Grounded

### Mechanical

Dimensions (HxWxD)	800 x 600 x 40 mm (31.5" x 23.6" x 1.6")
Weight	6.5 kg.
Connector	6 x N-Type, Female
Back Plane	Aluminum protected through chemical passivation
Radome	UV Protected, Plastic
Mount	See ordering options

### Environmental

Operating Temperature Range	-40°C to +65°C
Vibration	According to IEC 60721-3-4
Wind Load	200 km/h (survival)
Flammability	UL94
Water Proofing	IP-65
Humidity	ETS 300 019-1-4, EN 302 085 (annex A.1.1)
Salt Fog	According to IEC 68-2-11
Ice and Snow	25mm radial (survival)

## Ordering Options

MA-WD36-MIMO3	Antenna Suited for MNT-25 (optional tilt mount)
MA-WD36-MIMO3B	Antenna with MNT-25 mount

Patterns are available on our website

MARS Antennas & RF Systems proprietary information

MARS reserves the right to make technical changes or modifications to any of its products and specifications without prior notice and without implementing such changes to prior supplied products. Product images are representative and indicative only. Warranty terms and general conditions of sale are applicable on any purchase of any product, available on MARS website.

3 Hamanor st. Holon 5886103, P.O.Box 1852 Holon 5811801, Israel

Tel: +972-3-5599661 • Fax: +972-3-5599677 • e-mail: mars@marsant.co.il • web: www.mars-antennas.com

# 4.4 GHz – 5.1 GHz

# 4.9 GHz – 6.1 GHz

# 5.4 GHz – 6.5 GHz

Subscriber - Single Pol  
 Subscriber - Dual Pol  
 Subscriber - Triple Pol  
 Subscriber - Quad Pol  
 Subscriber - 5 Pol  
 Sector - Single Pol  
 Sector -Dual Pol  
 Sector - Double Dual Slant  
 Sector - Triple Pol  
 Sector - Quad Pol  
 DAS - Single Pol  
 DAS - Dual Pol

Part Number	Description	Frequency band	Gain	Polarization	Dimension	Antenna type	Page
<b>MA-WA48-23</b>	High Gain, 4.8 GHz Subscriber	4.4-5.1 GHz	23 dBi	Linear, Vertical	370 x 370 x 40 mm	Subscriber Single Pol	04-1
<b>MA-WA47-20</b>	4.5 GHz Subscriber	4.4-5.1 GHz	20 dBi	Linear, Vertical	305 x 305 x 15 mm	Subscriber Single Pol	04-2
<b>MA-WS2455-1X</b>	Dual Band Subscriber, High Gain	2.4-2.5 GHz 4.9-5.875 GHz	18 dBi 12 dBi (typ.)	Linear, Vertical or Horizontal	305 x 305 x 25 mm	Subscriber Single Pol	<b>02-8</b>
<b>MA-WA57-3HG1</b>	Small Size Subscriber, High Gain	4.9-6.5 GHz	19 dBi (min.)	Linear, Vertical	155 x 155 x 28 mm	Subscriber Single Pol	04-3
<b>MA-WA58-1X</b>	Broadband Subscriber	4.9-5.875 GHz	23 dBi (typ.)	Linear, Vertical	305 x 305 x 15 mm (Diamond Shape)	Subscriber Single Pol	04-4
<b>MA-WA58-1XMMES</b>	Integrated Antenna & Enclosure Solution	4.9-5.875 GHz	23 dBi (typ.)	Linear, Vertical	305 x 305 x 15 mm (Diamond Shape)	Subscriber Single Pol	04-5
<b>MA-WA55-27</b>	5 GHz Broadband Subscriber	4.9-6.1 GHz	26 dBi (typ.)	Linear, Vertical or Horizontal	370 x 370 x 40 mm	Subscriber Single Pol	04-6
<b>MA-WA55-30</b>	High Gain Subscriber	4.9-6.1 GHz	30 dBi (typ.)	Linear, Vertical	600 x 600 x 30 mm	Subscriber Single Pol	04-7
<b>MA-WA62-30</b>	4.9-6.5 GHz High Gain Subscriber	4.9-6.5 GHz	30 dBi (Typ.)	Linear, Vertical	600 x 600 x 30 mm	Subscriber Single Pol	04-8
<b>MA-WA61-25</b>	6 GHz Broadband Subscriber	5.4-6.5 GHz	25 dBi	Linear, Vertical	305 x 305 x 15 mm	Subscriber Single Pol	04-9
<b>MA-WA48-DP23</b>	Dual Polarized / Dual Slant Subscriber	4.4-5.1 GHz	23 dBi	Dual Pole V & H Dual Slant $\pm 45^\circ$	370 x 370 x 40 mm	Subscriber Dual Pol	04-10
<b>MA-WA52-DP24</b>	Dual Polarized / Dual Slant Subscriber	4.4-6.1 GHz	24 $\pm$ 1 dBi	Linear, Vertical & Horizontal	112 x 112 x 33.5 mm	Subscriber Dual Pol	04-11
<b>MA-WA56-DP13</b>	Dual Polarized / Dual Slant Subscriber	4.9-6.1 GHz	V-Pol: 13.5 dBi H-Pol: 14.5 dBi	Dual Pole V & H Dual Slant $\pm 45^\circ$	112 x 112 x 33.5 mm	Subscriber Dual Pol	04-12

MARS Antennas & RF Systems proprietary information

MARS reserves the right to make technical changes or modifications to any of its products and specifications without prior notice and without implementing such changes to prior supplied products. Product images are representative and indicative only. Warranty terms and general conditions of sale are applicable on any purchase of any product, available on MARS website.

3 Hamanor st. Holon 5886103, P.O.Box 1852 Holon 5811801, Israel

Tel: +972-3-5599661 • Fax: +972-3-5599677 • e-mail: mars@marsant.co.il • web: www.mars-antennas.com

Part Number	Description	Frequency band	Gain	Polarization	Dimension	Antenna type	Page
MA-WA56-DP19	Dual Polarized / Dual Slant Subscriber	4.9-6.1 GHz	19 ± 1 dBi	Dual Pole V & H Dual Slant ±45°	200 x 200 x 33 mm	Subscriber Dual Pol	04-13
MA-WA56-DP20	Dual Polarized / Dual Slant Subscriber	4.9-5.875 GHz	21 ± 1 dBi	Dual Pole V & H Dual Slant ±45°	305 x 305 x 15 mm	Subscriber Dual Pol	04-14
MA-WA56-DP23	Dual Polarized / Dual Slant Subscriber	4.9-6.1 GHz	23 ± 1 dBi	Dual Pole V & H Dual Slant ±45°	305 x 305 x 15 mm	Subscriber Dual Pol	04-15
MA-WA56-DP25N	Dual Polarized / Dual Slant Subscriber	4.9-5.875 GHz	V-Pol:24.5 ±1 H-Pol:23.5 ±1	Dual Pole V & H Dual Slant ±45°	370x 370 x 40 mm	Subscriber Dual Pol	04-16
MA-WA56-DP28N	High Gain, Dual Polarized / Dual Slant Subscriber	4.9-6.425 GHz	V-Pol:29±0.5 H-Pol:28.5±0.5	Dual Pole V & H Dual Slant ±45°	600 x 600 x 22 mm	Subscriber Dual Pol	04-17
MA-WABSA55-DP15	Beam Steering Active Antenna, Azimuth Scan	5.0-6.0 GHz	<u>Beam forming</u> Rx: 32 dBi Tx: 40 dBi <u>Broadcast</u> Rx: 33 dBi Tx: 34 dBi	Vertical & Horizontal	370x370x60 mm	Subscriber Dual Pol	04-18
MA-PBSA56-DP21	Passive Antenna For Beam Steering, Azimuth Scan	5.0-6.0 GHz	<u>Individual Column</u> 16 dBi  <u>Array 4 Columns</u> 21 dBi	Vertical & Horizontal	370x 370 x 40 mm	Subscriber Dual Pol	04-19
MA-TBA56-DP18	Passive Antenna For Beam Steering, Azimuth Scan	5.0-6.0 GHz	18 dBi	Vertical & Horizontal	400 x 300 x 50 mm	Subscriber Dual Pol	04-20
MA-WA6960-DS7	Multi Band Dual Slant Directional	698-960 MHz 1700-2700 MHz 5150-6000 MHz	7.5 dBi 6-7 dBi 6 dBi	Dual Slant ±45°	300 x 300 x 99 mm	Subscriber Dual Slant	<b>01-7</b>
MA-WA62-DP30	High Gain, Dual Polarized/Dual Slant	5.4-6.5 GHz	29 ± 1 dBi	Dual Pole V & H Dual Slant ±45°	600 x 600 x 30 mm	Subscriber Dual Pol	04-21
MA-WA62-DP24	Dual Polarized / Dual Slant Subscriber	5.4-6.42 GHz	24 dBi	Dual Pole V & H Dual Slant ±45°	305 x 305 x 15 mm	Subscriber Dual Pol	04-22
MA-WA62-DP19	Dual Polarized / Dual Slant Subscriber	5.7-6.425 GHz	19 ± 1 dBi	Dual Pole V & H Dual Slant ±45°	200 x 200 x 33 mm	Subscriber Dual Pol	04-23
MA-WA55-TPMIMO	<b>Triple Polarization MIMO</b> Subscriber	5.125-6.1 GHz	<u>Ver. Pol</u> 19 dBi <u>Dual Slant pol.</u> 17.5 dBi	Dual Slant ± 45° & Vertical	305 x 305 x 15 mm	Subscriber Triple Pol	04-24
MA-WA55-4QP13	Quad Polarization	4.9-6.1 GHz	4x13 dBi	Vertical, Horizontal & Dual Slant (±45°)	200 x 200 x 33 mm	Subscriber QUAD Pol	04-25
MA-WA55-QP4MIMO	Quad Polarization	5.1-5.9 GHz	4 x 16 dBi	Vertical, Horizontal & Dual Slant (±45°)	305 x 305 x 15 mm	Subscriber QUAD Pol	04-26

MARS Antennas & RF Systems proprietary information

MARS reserves the right to make technical changes or modifications to any of its products and specifications without prior notice and without implementing such changes to prior supplied products. Product images are representative and indicative only. Warranty terms and general conditions of sale are applicable on any purchase of any product, available on MARS website.

3 Hamanor st. Holon 5886103, P.O.Box 1852 Holon 5811801, Israel

Tel: +972-3-5599661 • Fax: +972-3-5599677 • e-mail: mars@marsant.co.il • web: www.mars-antennas.com

Part Number	Description	Frequency band	Gain	Polarization	Dimension	Antenna type	Page
<b>MA-WA57-QP4MIMO19</b>	Quad Polarization	4.9-5.15 GHz 5.15-6.425 GHz	4x18 dBi 4x19 dBi	Vertical, Horizontal & Dual Slant (±45°)	370 x 370 x 40 mm	Subscriber QUAD Pol	04-27
<b>MA-WA2455-QPMIMO</b>	Dual Band Quad Polarization	2.3-2.7 GHz 5.15-5.875 GHz	12 dBi 16 dBi	Dual Slant ±45° Dual Pole V & H	305 x 305 x 15 mm	Subscriber QUAD Pol	<b>02-19</b>
<b>MA-WA56-MIMO5-14</b>	5 Polarization	5.1-5.9 GHz	5x13.5 dBi	Linear, Vertical & Dual Slant (±45°)	305 x 305 x 15 mm	Subscriber 5 Pol	04-28
<b>MA-DBO2458-6</b>	Dual Band Omni	2.3-2.7 GHz 4.9-6 GHz	4-5 dBi / 7 dBi	Linear, Vertical	210 x 28.5 Dia. mm	Sector Single Pol	<b>07-22</b>
<b>MA-DBO-3H</b>	<b>Dual Band</b> MIMO Omni	2.3-2.7 GHz 4.9-6.1 GHz	3 X 2.5 dBi 3 X 3.5 dBi	Linear, Vertical	200 x 200 x 33 mm	Sector Single Pol	<b>07-23</b>
<b>MA-DBO-3MIMO</b>	<b>Dual Band</b> MIMO Omni	2.3-2.7 GHz 4.9-6 GHz	3 X 4 dBi 3 X 7 dBi	Linear, Vertical	205 x 330 mm	Sector Single Pol	<b>07-24</b>
<b>MA-WD55-16MIMO</b>	MIMO Base Station, 90°	4.9-6.1 GHz	3 x 16 dBi	Linear, Vertical	400 x 300 x 50 mm	Sector Single Pol	04-29
<b>MA-WE55-15MIMO</b>	MIMO Base Station, 120°	4.9-6.1 GHz	3 x 15 dBi	Linear, Vertical	400 x 300 x 50 mm	Sector Single Pol	04-30
<b>MA-WC55-17</b>	Base Station,60°	4.9-6.1 GHz	17 dBi (typ.)	Linear, Vertical	573 x 95 x 53 mm	Sector Single Pol	04-31
<b>MA-WD55-16</b>	Base Station,90°	4.9-6.1 GHz	16 dBi (typ.)	Linear, Vertical	573 x 95 x 53 mm	Sector Single Pol	04-32
<b>MA-WE55-15</b>	Base Station,120°	4.9-6.1 GHz	15 dBi (typ.)	Linear, Vertical	573 x 95 x 53 mm	Sector Single Pol	04-33
<b>MA-WB55-20</b>	Base Station 30°	4.9-6.1 GHz	20 dBi (typ.)	Linear, Vertical	573 x 120 x 115 mm	Sector Single Pol	04-34
<b>MA-WC55-18H</b>	5.5 GHz Horizontal Polarization Base Station, 65°	4.9-6.1 GHz	18 dBi (typ.)	Linear, Horizontal	573 x 95 x 53 mm	Sector Single Pol	04-35
<b>MA-WD55-17H</b>	Base Station, 90°	4.9-6.1 GHz	17 dBi (typ.)	Linear, Horizontal	573 x 95 x 53 mm	Sector Single Pol	04-36
<b>MA-WC2458-6</b>	Dual Band 60°	2.4-2.5 GHz 5.15-5.875 GHz	6 dBi	Linear Vertical or Horizontal	112 x 112 x 33.5 mm	Sector Single Pol	<b>02-29</b>
<b>MA-WC2458-10</b>	Dual Band 60°	2.4-2.5 GHz 5.15-5.875 GHz	9.5 dBi 10.5 dBi	Linear Vertical or Horizontal	112 x 112 x 33.5 mm	Sector Single Pol	<b>02-30</b>
<b>MA-WC62-17</b>	Base Station,60°	5.7-6.5 GHz	17 dBi	Linear, Vertical	573 x 95 x 53 mm	Sector Single Pol	04-37
<b>MA-WD62-16</b>	Base Station,90°	5.7-6.5 GHz	16 dBi	Linear, Vertical	573 x 95 x 53 mm	Sector Single Pol	04-38
<b>MA-WE62-15</b>	Base Station,120°	5.7-6.5 GHz	15 dBi	Linear, Vertical	573 x 95 x 53 mm	Sector Single Pol	04-39
<b>MA-WE2458-MIMO4-5</b>	Dual Band Sector, 120°	2.3-2.7 GHz 4.9-6.1 GHz	4 X 5 dBi	2 x Dual Slant ±45°	200 x 200 x 33 mm	Sector Dual Slant	<b>02-31</b>
<b>MA-WC2458-2H</b>	Dual Band , Dual Slant Small Sector, 60°	2.4-2.5 GHz 5.15-5.875 GHz	2 X 7.5 dBi	Dual Slant ±45°	200 x 200 x 33 mm	Sector Dual Pol	<b>02-39</b>
<b>MA-WD2455-DBDP17</b>	Dual Band , Dual Polarization Base Station 90°	2.4-2.5 GHz 5.1-5.9 GHz	15 dBi 17 dBi	Vertical & Horizontal	812 X 330 X 70 mm	Sector Dual Pol	<b>02-40</b>
<b>MA-WE2458-2H</b>	Dual Slant Base Station 120°	2.4-2.5 GHz 4.9-5.875 GHz	5 dBi	Dual Slant ±45°	200 x 200 x 33 mm	Sector Dual Slant	<b>02-41</b>
<b>MA-WC55-DS17</b>	Dual Slant Base Station, 60°	4.9-6.1 GHz	17 dBi (typ.)	Dual Slant ±45°	370 x 370 x 40 mm	Sector Dual Slant	04-40

MARS Antennas & RF Systems proprietary information

MARS reserves the right to make technical changes or modifications to any of its products and specifications without prior notice and without implementing such changes to prior supplied products. Product images are representative and indicative only. Warranty terms and general conditions of sale are applicable on any purchase of any product, available on MARS website.

3 Hamanor st. Holon 5886103, P.O.Box 1852 Holon 5811801, Israel

Tel: +972-3-5599661 • Fax: +972-3-5599677 • e-mail: mars@marsant.co.il • web: www.mars-antennas.com

Part Number	Description	Frequency band	Gain	Polarization	Dimension	Antenna type	Page
MA-WD55-DS16	Dual Slant Base Station, 90°	4.9-6.1 GHz	16 dBi (typ.)	Dual Slant ±45°	370 x 370 x 40 mm	Sector Dual Slant	04-41
MA-WC56-DP17	Dual Polarized Base Station, 60°	4.9-6.1 GHz	H Pol. 17dBi V Pol. 18dBi	Dual, Vertical & Horizontal	370 x 370 x 40 mm	Sector Dual Pol	04-42
MA-WD56-DP16	Dual Polarized Base Station, 90°	4.9-6.1 GHz	16 dBi	Dual, Vertical & Horizontal	370 x 370 x 40 mm	Sector Dual Pol	04-43
MA-WD56-DP13	Dual Polarized Base Station, 90°	5.15-5.875 GHz	13 dBi	Dual, Vertical & Horizontal	200 x 200 x 33 mm	Sector Dual Pol	04-44
MA-WE56-DP12	Dual Polarized Base Station, 120°	5.15-5.875 GHz	12 dBi	Dual, Vertical & Horizontal	200 x 200 x 33 mm	Sector Dual Pol	04-45
MA-WE56-DP15	Dual Polarized Base Station, 120°	5.15-5.875 GHz	14.5 dBi	Dual, Vertical & Horizontal	370 x 370 x 40 mm	Sector Dual Pol	04-46
MA-WC62-DP17	Dual Polarized Base Station, 60°	5.7-6.425 GHz	17 dBi	Linear, Vertical	370 x 370 x 40 mm	Sector Dual Pol	04-47
MA-WD62-DP16	Dual Polarized Base Station, 90°	5.7-6.425 GHz	16 dBi	Dual, Vertical & Horizontal	370 x 370 x 40 mm	Sector Dual Pol	04-48
MA-WD62-DS16	Dual Slant Base Station, 90°	5.7-6.425 GHz	15.5 dBi	Dual Slant ±45°	370 x 370 x 40 mm	Sector Dual Slant	04-49
MA-WC54-2DS17	Double Dual Slant Base Station Antenna, 65°	4.9-6.1 GHz	4 x 17 ± 0.5dBi	Double Linear ±45°	370 x 370 x 40 mm	Sector Double Dual slant	04-50
MA-WC2458-MIMO4-8	Dual Band Sector 60°	2.4-2.5 GHz 5.15-5.875 GHz	4 X 6 dBi	Dual Slant ±45° & Dual Slant ±135°	200 x 200 x 33 mm	Sector Double Dual slant	02-38
MA-WE2458-3H	Triple Polarization MIMO, Dual Band Sector 120°	2.3-2.7 GHz 4.9-6.1 GHz	3 X 5 dBi	Dual Slant ± 45° & Vertical	200 x 200 x 33 mm	Sector Triple Pol	02-43
MA-WD56-DSV16	Triple Polarization MIMO, Sector, 90°	4.9-6.1 GHz	3 X 16 dBi	Dual Slant ± 45° & Vertical	370 x 370 x 40 mm	Sector Triple Pol	04-51
MA-WC2458-3H	Triple Polarization MIMO, Dual Band Sector 60°	2.4-2.5 GHz 5.15-5.875 GHz	3 X 7.5 dBi	Dual Slant ± 45° & Vertical	200 x 200 x 33 mm	Sector Triple Pol	02-44
MA-WC2458-QP6	Dual Band Quad pole Sector, 60°	2.4-2.5 GHz 5.15-5.875 GHz	4 X 6 dBi	Dual Slant ±45° & Vertical & Horizontal	200 x 200 x 33 mm	Sector QUAD Pol	02-45
MA-WO-UWB	Ultra Wide Band OMNI Directional	138-174 MHz 380-450 MHz 450-512 MHz 512-698 MHz 698-746 MHz 746-806 MHz 806-960 MHz 1200-2700 MHz 3300-3800 MHz 4100-6000 MHz	3 dBi 4 dBi 5 dBi 5.5 dBi 6 dBi 7 dBi 7 dBi 8 dBi 10 dBi 11 dBi	Linear, Vertical	540 x 40 Dia mm	DAS Single Pol	07-1
MA-CQ26-1X	380 MHz -6 GHz Multi Band Omni	380-806 MHz 806-960 MHz 1395-1432 MHz 1710-2170 MHz 2300-2500 MHz 3300-3700 MHz 4900-6000 MHz	1 (2*) dBi 4 dBi 5 dBi 5 dBi 5 dBi 5 dBi 6 dBi	Linear, Vertical	Base Dia. - 275 Height – 187 mm	DAS Single Pol	07-2
MA-CQ27-1X	380 MHz -6 GHz Multi Band Omni	380-806 MHz 806-960 MHz 1395-1432 MHz 1710-2170 MHz 2300-2700 MHz 3300-3700 MHz 4900-6000 MHz	1 (2*) dBi 4 dBi 5 dBi 5 dBi 6 dBi 6 dBi 6 dBi	Linear, Vertical	Base Dia. - 275 Height - 187 mm	DAS Single Pol	07-3

MARS Antennas & RF Systems proprietary information

MARS reserves the right to make technical changes or modifications to any of its products and specifications without prior notice and without implementing such changes to prior supplied products. Product images are representative and indicative only. Warranty terms and general conditions of sale are applicable on any purchase of any product, available on MARS website.

3 Hamanor st. Holon 5886103, P.O.Box 1852 Holon 5811801, Israel

Tel: +972-3-5599661 • Fax: +972-3-5599677 • e-mail: mars@marsant.co.il • web: www.mars-antennas.com

Part Number	Description	Frequency band	Gain	Polarization	Dimension	Antenna type	Page
MA-CQ29-1X	380 MHz -6 GHz Multi Band Omni	380-806 MHz 806-960 MHz 1700-2500 MHz 2500-2700 MHz 3300-3700 MHz 4900-6000 MHz	1 (2*) dBi 4 dBi 5 dBi 5 dBi 6 dBi 6 dBi	Linear, Vertical	Base Dia. - 275 Height - 187 mm	DAS Single Pol	07-4
MA-WOLTE-3X	LTE, GSM, UMTS, WLAN, Wi-Fi Multi Band Omni	698-806 MHz 806-960 MHz 1710-2170 MHz 2300-2700 MHz 3300-3800 MHz 4900-6500 MHz	2 dBi 2 dBi 3-4 dBi 5 dBi 4 dBi 6 dBi	Linear, Vertical	Base Dia. - 205 Height - 89 mm	DAS Single Pol	07-6
MA-WOLTE-3M1	698-6500 MHz Multi Band Tri-Ports Omni	<b>Port 1 &amp; 2</b> 698-960 MHz 1710-2170 MHz 2.3-2.7 GHz. 3.3-3.8 GHz 4.9- 6.5 GHz <b>Port 3</b> 1710-2170 MHz 2.3-2.7 GHz 3.3-3.8 GHz 4.9- 6.5 GHz	2 dBi 3-4 dBi 5 dBi 4 dBi 6 dBi 3 dBi 3 dBi 4 dBi 6 dBi	Linear, Vertical	Antenna dimension (D,H): 220 x 95 mm  Base dimension (L,W,H): 369 x 270 x 30 mm	DAS Single Pol	07-7
MA-CR26-2X	Multi Band Omni	806-960 MHz 1710-2170 MHz 2300-2700 MHz 3400-3700 MHz 4900-6000 MHz	2 dBi 3-4 dBi 5 dBi 5 dBi 5-6 dBi	Linear, Vertical	Base Dia. - 205 Height - 89 mm	DAS Single Pol	07-12
MA-WOLTE-DP1	698-6500 MHz Multi Band Dual Polarized Omni	<b>Vertical</b> 698-960 MHz 1710-2170 MHz 2.3-2.7 GHz 3.3-3.8 GHz 4.9- 6.5 GHz <b>Horizontal</b> 2.3-2.7 GHz 4.9- 5.875 GHz	4 dBi 5 dBi 5.5 dBi 7 dBi 7.5 dBi 5 dBi 5 dBi	Linear, Vertical	Base Diameter 275 mm  Height 190 mm	DAS Dual Pol	07-8
MA-WOLTE-DP2	698-6500 MHz Multi Band Tri-Ports Omni	<b>Port 1</b> 1.7-2.7 GHz <b>Port 2</b> 4.4-6.6 GHz <b>Port 3</b> 698-960 MHz 1.7-2.3 GHz 2.3-2.7 GHz. 3.3-3.8 GHz 4.5- 6.6 GHz	5 dBi 6 dBi 4 dBi 3-4 dBi 5.5 dBi 4 dBi 6 dBi	Linear, Horizontal  Linear, Horizontal  Linear, Vertical	Antenna dimension (D,H): 220 x 95 mm  (Stand out from the ceiling)	DAS Dual Pol	07-9

MARS Antennas & RF Systems proprietary information

MARS reserves the right to make technical changes or modifications to any of its products and specifications without prior notice and without implementing such changes to prior supplied products. Product images are representative and indicative only. Warranty terms and general conditions of sale are applicable on any purchase of any product, available on MARS website.

3 Hamanor st. Holon 5886103, P.O.Box 1852 Holon 5811801, Israel

Tel: +972-3-5599661 • Fax: +972-3-5599677 • e-mail: mars@marsant.co.il • web: www.mars-antennas.com

## MA-WA48-23

### 4.4-5.1 GHz High Gain Vertical or Horizontal Polarized Antenna

#### Antenna Features:

- Efficient and stable performance.
- High gain/size ratio.
- Light weight and durable construction.
- UV protected radome made of polycarbonate suitable for harsh weather installations.



## Specifications

### Electrical

Frequency range	4.4-5.1 GHz
Gain	23 dBi
VSWR, max.	1.7 : 1
Polarization	Linear, Vertical or Horizontal
3 dB Beam-Width, H-Plane, typ.	10°
3 dB Beam-Width, E-Plane, typ.	10°
Side Lobes, min.	-12 dB
Cross Polarization, min.	-20 dB
Front to Back Ratio, min.	-35 dB
Port to Port Isolation, typ	-35 dB
Input power, max	10 Watt
Input Impedance	50 Ohm
Lightning Protection	DC Grounded

### Mechanical

Dimensions (HxWxD)	370 x 370 x 40 mm
Connector	N-Type Female
Weight	1.8 Kg
Mounting	See ordering options
Radome	UV Protected, Polycarbonate
Back Plane	Aluminum protected through chemical passivation

### Environmental

Operating Temperature Range	-40°C to +65°C
Vibration	According to IEC 60721-3-4
Wind Load	200 Km/h (Survival)
Flammability	UL94
Water Proofing	IP-67
Humidity	ETS 300 019-1-4, EN 302 085 (Annex A.1.1)
Salt Fog	According to IEC 68-2-11

### Standard Compliance

ETSI EN 302085 V1.2.3-TS3

## Ordering Options

MA-WA48-23	Antenna Suited for MNT-22 (optional wall/pole adjustable mount)
MA-WA48-23B	Antenna with MNT-22 mount

Patterns are available on our website

MARS Antennas & RF Systems proprietary information

MARS reserves the right to make technical changes or modifications to any of its products and specifications without prior notice and without implementing such changes to prior supplied products. Product images are representative and indicative only. Warranty terms and general conditions of sale are applicable on any purchase of any product, available on MARS website.

3 Hamanor st. Holon 5886103, P.O.Box 1852 Holon 5811801, Israel

Tel: +972-3-5599661 • Fax: +972-3-5599677 • e-mail: mars@marsant.co.il • web: www.mars-antennas.com



## MA-WA47-20

### 4.4-5 GHz Broadband Subscriber Antenna

MARS 4.5 GHz Broadband High Gain Antenna covers 4.4-5 GHz spectrum

Additional Features:

- Exceptionally high gain of 20 dBi over the entire frequency band.
- Light weight and durable construction.
- DC grounded for lightning protection to meet local electrical building codes.
- Antenna has a customized version with an optional enclosure for the customer's OEM radio/CPE.



### Specifications

#### Electrical

Frequency range	4.4-5 GHz
GAIN	20 dBi
VSWR, max.	1.7 : 1
Polarization	Linear, Vertical
3 dB Beam-Width, H-Plane, typ.	11°
3 dB Beam-Width, E-Plane, typ.	14°
Side Lobes, typ.	-12 dB
Front to Back Ratio, min.	-35 dB
Cross Polarization, min.	-18 dB
Input power, max	30 Watt
Input Impedance	50 Ohm
Lightning Protection	DC Grounded

#### Mechanical

Dimensions (HxWxD)	305 x 305 x 15 mm (12" x 12" x 0.6") – Diamond Shape
Weight	840 gr.
Connector	N-Type, Female
Back Plane	Aluminum; protected through chemical passivation
Radome	UV Protected Polycarbonate
Mount	See ordering options

#### Environmental

Operating Temperature Range	-40°C to +65°C
Vibration	According to IEC 60721-3-4
Wind Load	200 km/h (survival)
Flammability	UL94
Water Proofing	IP-67
Humidity	ETS 300 019-1-4, EN 302 085 (annex A.1.1)
Salt Fog	According to IEC 68-2-11
Ice and Snow	25mm radial (survival)

### Ordering Options

MA-WA47-20	Antenna Suited for MNT-22 (optional wall/pole adjustable mount)
MA-WA47-20B	Antenna with MNT-22 mount

Patterns are available on our website

MARS Antennas & RF Systems proprietary information

MARS reserves the right to make technical changes or modifications to any of its products and specifications without prior notice and without implementing such changes to prior supplied products. Product images are representative and indicative only. Warranty terms and general conditions of sale are applicable on any purchase of any product, available on MARS website.

3 Hamanor st. Holon 5886103, P.O.Box 1852 Holon 5811801, Israel

Tel: +972-3-5599661 • Fax: +972-3-5599677 • e-mail: mars@marsant.co.il • web: www.mars-antennas.com

## MA-WA57-3HG1

### 4.9-6.5 GHz Small Size Subscriber Antenna, High Gain

MARS Small Size High Gain Antenna covers the full 5 GHz spectrum band including its unlicensed part.

Additional Features:

- Exceptionally high gain/size ratio.
- Small and unobtrusive profile.
- Suitable for both indoor and outdoor applications.



## Specifications

### Electrical

Frequency range	4.9-6.5 GHz
GAIN, typ.	4.9-5.15 @ 18 dBi 5.15-6.5 @ 19 dBi
VSWR, max.	1.7 : 1
Polarization	Linear, Vertical or Horizontal (See Ordering Options)
3 dB Beam-Width, H-Plane, typ.	19.5°
3 dB Beam-Width, E-Plane, typ.	19.5°
Cross Polarization, max	ETSI EN 302 085 v1.2.3 TS2 Range 1
Front to Back Ratio, max.	ETSI EN 302 085 v1.2.3 TS2 Range 1
Side Lobes, min.	ETSI EN 302 085 v1.2.3 TS2 Range 1
Input power, max.	50 Watt
Input Impedance	50 Ohm
Lightning Protection	DC Grounded

### Mechanical

Dimensions (HxWxD)	155 x 155 x 28 mm (6.1" x 6.1" x 1.1")
Weight	250 gr.
Connector	See Ordering Options
Back Plane	Aluminum protected through chemical passivation
Radome	UV Protected Polycarbonate
Mount	See Ordering Options

### Environmental

Operating Temperature Range	-40°C to +65°C
Vibration	According to IEC 60721-3-4
Wind Load	200 km/h (survival)
Flammability	UL94
Water Proofing	IP-67
Humidity	ETS 300 019-1-4, EN 302 085 (annex A.1.1)
Salt Fog	According to IEC 68-2-11
Ice and Snow	25mm radial (survival)

## Ordering Options

MA-WA57-3HG1	Antenna with N-Type, Female Connector Suited for MNT-23 (optional wall/pole adjustable mount)
MA-WA57-3HG1B	Antenna with N-Type, Female Connector and MNT-23 mount
MA-WA57-3HG1 & MNT-23H	Antenna with N-Type, Female Connector and MNT-23H for horizontal polarization
MA-WA57-3HGS1	Antenna with SMA Female Connector suited for MNT-22
MA-WA57-3HGS1B	Antenna with SMA Female Connector and MNT-22 mount

Patterns are available on our website

MARS Antennas & RF Systems proprietary information

MARS reserves the right to make technical changes or modifications to any of its products and specifications without prior notice and without implementing such changes to prior supplied products. Product images are representative and indicative only. Warranty terms and general conditions of sale are applicable on any purchase of any product, available on MARS website.

3 Hamanor st. Holon 5886103, P.O.Box 1852 Holon 5811801, Israel

Tel: +972-3-5599661 • Fax: +972-3-5599677 • e-mail: mars@marsant.co.il • web: www.mars-antennas.com

## MA-WA58-1X

### 5 GHz Broadband Subscriber Antenna

MARS 5 GHz Broadband High Gain Antenna covers the full 5 GHz spectrum, from lower to higher UNII band, including its unlicensed part.

Additional Features:

- Exceptionally high gain of 23 dBi over the entire frequency band.
- Diamond shape provides the highest range of ETSI standards, up to TS5.
- Light weight and durable construction.
- DC grounded for lightning protection to meet local electrical building codes.

The MARS 5GHz Antenna & Enclosure Solution comprises of Waterproof 5 GHz Broadband Antenna and Weatherproof Enclosure with provisions for Az/EI Mounting device. This solution enables WISP/Integrator to design his own low cost, weatherized subscriber unit, saving high costs of special antenna-radio integration.



### Specifications

#### Electrical

Frequency range	4.9-5.875 GHz	
GAIN, typ.	23 dBi @ 5.15-5.875	21 dBi @ 4.9-5.15
VSWR, max.	1.5 : 1 @ 5.15-5.875	1.9 : 1 @ 4.9-5.15
Polarization	Linear, Vertical	
3 dB Beam-Width, H-Plane, typ.	10.5°	
3 dB Beam-Width, E-Plane, typ.	10.5°	
Side Lobes, min.	-23 dB	
Cross Polarization, min.	-24 dB	
Front to Back Ratio, min.	-30 dB	
Input power, max.	30 Watt	
Input Impedance	50 Ohm	
Lightning Protection	DC Grounded	

#### Mechanical

Dimensions (HxWxD)	305 x 305 x 15 mm (12" x 12" x 0.6")
Weight	840 gr.
Connector (without enclosure)	N-Type, Female
Connector (with enclosure)	SMA Female
Back Plane	Aluminum; protected through chemical passivation
Radome	UV Protected Polycarbonate
Enclosure - Small	171 x 167 x 68 mm. (External dimension)
Enclosure - Large	287 x 287 x 68 mm. (External dimension)
Mount	See Ordering Options

#### Environmental

Operating Temperature Range	-40°C to +65°C
Vibration	According to IEC 60721-3-4
Wind Load	200 km/h (survival)
Flammability	UL94
Water Proofing	IP-67
Humidity	ETS 300 019-1-4, EN 302 085 (annex A.1.1)
Salt Fog	According to IEC 68-2-11
Ice and Snow	25mm radial (survival)

#### Standard Compliance

94-51 5 GHz ETSI EN 302 085 V1.2.3 - TS1, TS2, TS3
5.15-5.875 GHz ETSI EN 302 085 V1.2.3 - TS1, TS2, TS3, TS4, TS5

### Ordering Options

MA-WA58-1X PM	Antenna with N-Type Female connector with integral Pole Mount includes stainless steel brackets
MA-WA58-1X MNT	Antenna with N-Type Female connector Suited for MNT-22 (optional wall/pole adjustable mount)
MA-WA58-1XMNTB	Antenna with N-Type Female connector with MNT-22 mount
MA-WA58-1XSMESY	Antenna with small enclosure, SMA Connector and MNT-22
MA-WA58-1XSMESZ	Antenna with small enclosure, SMA Connector with PEMs and MNT-22
MA-WA58-1XSMELY	Antenna with large enclosure, SMA Connector and MNT-22
MA-WA58-1XSMELZ	Antenna with large enclosure, SMA Connector with PEMs and MNT-22

Patterns are available on our website

MARS Antennas & RF Systems proprietary information

MARS reserves the right to make technical changes or modifications to any of its products and specifications without prior notice and without implementing such changes to prior supplied products. Product images are representative and indicative only. Warranty terms and general conditions of sale are applicable on any purchase of any product, available on MARS website.

3 Hamanor st. Holon 5886103, P.O.Box 1852 Holon 5811801, Israel

Tel: +972-3-5599661 • Fax: +972-3-5599677 • e-mail: mars@marsant.co.il • web: www.mars-antennas.com

## MA-WA58-1XMMES/EL

### 5 GHz Broadband Antenna & Enclosure

MARS 5GHz Antenna & Enclosure Solution comprises of:

- Waterproof 5 GHz Broadband Antenna.
- Weatherproof Enclosure with provisions for Az/EI Mounting device.
- Azimuth/Elevation Adjustable Mount MNT-22.

This solution enables WISP/Integrator to design his own low cost, weatherized subscriber unit, saving high costs of special antenna-radio integration.



### Specifications

#### Electrical

Frequency range	4.9-5.875 GHz
GAIN, typ.	23 dBi @ 5.15-5.875 21 dBi @ 4.9-5.15
VSWR, max.	1.5 : 1 @ 5.15-5.875 1.9 : 1 @ 4.9-5.15
Polarization	Linear, Vertical
3 dB Beam-Width, H-Plane, typ.	10.5°
3 dB Beam-Width, E-Plane, typ.	10.5°
Side Lobes, min.	-23 dB
Cross Polarization, min.	-24 dB
Front to Back Ratio, min.	-30 dB
Input power, max.	30 Watt
Input Impedance	50 Ohm
Lightning Protection	DC Grounded

#### Mechanical

Dimensions (HxWxD)	305 x 305 x 15 mm (Diamond Shape, 12" x 12" x 0.6")
Weight	840 gr. (1.5 kg with Enclosure)
Connector	MMCX with RD316 Coaxial Cable/UFL (Other connector types available on request)
Back Plane	Aluminum; protected through chemical passivation
Radome	UV Protected Polycarbonate
Enclosure	171 x 167 x 68 mm. (External dimension)
Mount	See ordering options

#### Environmental

Operating Temperature Range	-40°C to +65°C
Vibration	According to IEC 60721-3-4
Wind Load	200 km/h (survival)
Flammability	UL94
Water Proofing	IP-67
Humidity	ETS 300 019-1-4, EN 302 085 (annex A.1.1)
Salt Fog	According to IEC 68-2-11
Ice and Snow	25 mm radial (survival)

#### Standard Compliance

91451.5 GHz ETSI EN 302 085 V1.2.3 – TS1, TS2, TS3
5.15-5.875 GHz ETSI EN 302 085 V1.2.3 – TS1, TS2, TS3, TS4, TS5

### Ordering Options

MA-WA58-1XMMES	Antenna with small enclosure MK-ES20/21 and MNT-22 mount
MA-WA58-1XMMEL	Antenna with large enclosure MK-EL30/31 and MNT-22 mount

Patterns are available on our website

MARS Antennas & RF Systems proprietary information

MARS reserves the right to make technical changes or modifications to any of its products and specifications without prior notice and without implementing such changes to prior supplied products. Product images are representative and indicative only. Warranty terms and general conditions of sale are applicable on any purchase of any product, available on MARS website.

3 Hamanor st. Holon 5886103, P.O.Box 1852 Holon 5811801, Israel

Tel: +972-3-5599661 • Fax: +972-3-5599677 • e-mail: mars@marsant.co.il • web: www.mars-antennas.com

## MA-WA55-27

### 4.9-6.1 GHz Subscriber Antenna

MARS Broadband Antenna designed to provide high gain coverage of the UNII frequency band.

Additional Features:

- Efficient and stable performance.
- Aesthetic and unobtrusive.
- Thin UV protected radome suitable for harsh weather installations.
- Easy mounting allowing Az/EI adjustment.



### Specifications

#### Electrical

Frequency range	4.9-6.1 GHz
GAIN. typ	26 dBi
VSWR, max.	4.9-5.875 @ 1.7 : 1 5.875-6.1 @ 2 : 1
Polarization	Linear, Vertical or Horizontal
3 dB Beam-Width, H-Plane, typ.	7.5°
3 dB Beam-Width, E-Plane, typ.	7.5°
Side Lobes, min.	ETSI TS3, TS4, TS5
Cross Polarization, min.	ETSI TS3, TS4, TS5
Front to Back Ratio, min.	ETSI TS3, TS4, TS5
Input power, max.	50 Watt
Input Impedance	50 Ohm
Lightning Protection	DC Grounded

#### Mechanical

Dimensions (HxWxD)	370 x 370 x 40 mm (14.5" x 14.5" x 1.6")
Weight	1.6 kg.
Connector	N-Type Female
Back Plane	Aluminum; protected through chemical passivation
Radome	UV Protected Polycarbonate
Mount	See ordering options

#### Environmental

Operating Temperature Range	-40°C to +65°C
Vibration	According to IEC 60721-3-4
Wind Load	200 km/h (Survival)
Flammability	UL94
Water Proofing	IP-67
Humidity	ETS 300 019-1-4, EN 302 085 (Annex A.1.1)
Salt Fog	According to IEC 68-2-11

### Ordering Options

MA-WA55-27	Antenna Suited for MNT-22 (optional wall/pole adjustable mount)
MA-WA55-27B	Antenna with MNT-22 mount

Patterns are available on our website

MARS Antennas & RF Systems proprietary information

MARS reserves the right to make technical changes or modifications to any of its products and specifications without prior notice and without implementing such changes to prior supplied products. Product images are representative and indicative only. Warranty terms and general conditions of sale are applicable on any purchase of any product, available on MARS website.

3 Hamanor st. Holon 5886103, P.O.Box 1852 Holon 5811801, Israel

Tel: +972-3-5599661 • Fax: +972-3-5599677 • e-mail: mars@marsant.co.il • web: www.mars-antennas.com

## MA-WA55-30

### 4.9-6.1 GHz High Gain Subscriber Antenna

MARS Broadband High Gain Antenna covers the full 5GHz spectrum, from lower to higher UNII band, including its unlicensed part.

Additional Features:

- Exceptionally high gain over the entire frequency band.
- UV protected radome suitable for harsh weather installations.
- Highest range of ETSI standards - TS3, TS4, TS5.
- Easy mounting allowing Az/EI adjustment.



### Specifications

#### Electrical

Frequency range	4.9-6.1 GHz	
GAIN. typ.	4.9-5.15 & 5.875-6.1 @ 29 dBi	5.15-5.875 @ 30 dBi
VSWR, max.	1.7 : 1 @ 4.9-5.875	1.9 : 1 @ 5.875-6.1
Polarization	Linear, Vertical or Horizontal	
3 dB Beam-Width, H-Plane, typ.	5°	
3 dB Beam-Width, E-Plane, typ.	5°	
Side Lobes, min.	ETSI TS3, TS4, TS5	
Cross Polarization, min.	ETSI TS3, TS4, TS5	
Front to Back Ratio, min.	ETSI TS3, TS4, TS5	
Input power, max.	50 Watt	
Input Impedance	50 Ohm	
Lightning Protection	DC Grounded	

#### Mechanical

Dimensions (HxWxD)	600 x 600 x 30 mm (23.5" x 23.5" x 1.2")
Weight	4.5 kg.
Connector	N-Type Female
Back Plane	Aluminum ; protected through chemical passivation
Radome	UV Protected Polycarbonate
Mount	See ordering options

#### Environmental

Operating Temperature Range	-40°C to +65°C
Vibration	According to IEC 60721-3-4
Wind Load	200 km/h (Survival)
Flammability	UL94
Water Proofing	IP-67
Humidity	ETS 300 019-1-4, EN 302 085 (Annex A.1.1)
Salt Fog	According to IEC 68-2-11

### Ordering Options

MA-WA55-30	Antenna Suited for MNT-60A (optional wall/pole adjustable mount)
MA-WA55-30B	Antenna with MNT-60A mount

Patterns are available on our website

MARS Antennas & RF Systems proprietary information

MARS reserves the right to make technical changes or modifications to any of its products and specifications without prior notice and without implementing such changes to prior supplied products. Product images are representative and indicative only. Warranty terms and general conditions of sale are applicable on any purchase of any product, available on MARS website.

3 Hamanor st. Holon 5886103, P.O.Box 1852 Holon 5811801, Israel

Tel: +972-3-5599661 • Fax: +972-3-5599677 • e-mail: mars@marsant.co.il • web: www.mars-antennas.com

## MA-WA62-30

### 4.9-6.5 GHz High Gain Subscriber Antenna

MARS High Gain Broadband Antenna covers the **full** 5GHz and 6GHz spectrum.

#### Antenna Features:

- Exceptionally high gain over the entire frequency band.
- Efficient and stable performance.
- High gain.
- Durable construction.
- UV protected radome made of polycarbonate.



## Specifications

### Electrical

Frequency range	4.9-6.5 GHz		
GAIN, typ.	4.9-5.15 GHz 28.5 dBi	5.15-5.875 GHz 29 dBi	5.875-6.5 GHz 30 dBi
VSWR, max.	1.8 : 1 @ 4.9-5.3 GHz 1.7 : 1 @ 5.3-6.5 GHz		
Polarization	Linear ,Vertical		
3 dB Beam-Width, H-Plane, typ.	4.5°		
3 dB Beam-Width, E-Plane, typ.	4.5°		
Side Lobes, min.	-12 dB		
Cross Polarization, typ.	-29 dB		
Front to Back Ratio, min.	-40 dB		
Input power, max.	10 Watt		
Input Impedance	50 Ohm		
Lightning Protection	DC Grounded		

### Mechanical

Dimensions (HxWxD)	600 x 600 x 30 mm (23.5" x 23.5" x 1.2")
Weight	4.5 kg
Connector	N-Type, Female
Back Plane	Aluminum protected through chemical passivation
Radome	UV Protected, Polycarbonate
Mount	See ordering options

### Environmental

Operating Temperature Range	-40°C to +65°C
Vibration	According to IEC 60721-3-4
Wind Load	200 km/h (survival)
Flammability	UL94
Water Proofing	IP-67
Humidity	ETS 300 019-1-4, EN 302 085 (annex A.1.1)
Salt Fog	According to IEC 68-2-11

## Ordering Options

MA-WA62-30	Antenna Suited for MNT-60A (optional wall/pole adjustable mount)
MA-WA62-30B	Antenna with MNT-60A mount

MARS Antennas & RF Systems proprietary information

MARS reserves the right to make technical changes or modifications to any of its products and specifications without prior notice and without implementing such changes to prior supplied products. Product images are representative and indicative only. Warranty terms and general conditions of sale are applicable on any purchase of any product, available on MARS website.

3 Hamanor st. Holon 5886103, P.O.Box 1852 Holon 5811801, Israel

Tel: +972-3-5599661 • Fax: +972-3-5599677 • e-mail: mars@marsant.co.il • web: www.mars-antennas.com

## MA-WA61-25

### 6 GHz Broadband Subscriber Antenna

MARS 6 GHz Broadband High Gain Antenna covers newly approved 5.4-6.5 GHz band.

Additional Features:

- Exceptionally high gain.
- Light weight and durable construction.
- DC grounded for lightning protection.
- Easy mounting allowing Az/EI adjustment.
- UV protected radome suitable for harsh environment installations.



### Specifications

#### Electrical

Frequency range	5.4-6.5 GHz
GAIN, typ.	25 dBi
VSWR, max.	2 : 1 @ 5.4-5.7 GHz 1.7 :1 @ 5.7-6.5 GHz
Polarization	Linear, Vertical or Horizontal
3 dB Beam-Width, H-Plane, typ.	9°
3 dB Beam-Width, E-Plane, typ.	9°
Side Lobes, min.	-12 dB
Front to Back Ratio, min.	-30 dB
Cross Polarization, min.	-20 dB
Input power, max.	10 Watt
Input Impedance	50 Ohm
Lightning Protection	DC Grounded

#### Mechanical

Dimensions (HxWxD)	305 x 305 x 15 mm (12" x 12" x 0.6")
Weight	840 gr.
Connector (without enclosure)	N-Type, Female
Connector (with enclosure)	SMA Female Right Angle
Back Plane	Aluminum; protected through chemical passivation
Radome	UV Protected Polycarbonate
Enclosure - Small	171 x 167 x 68 mm. (External dimension)
Mount	See ordering options

#### Environmental

Operating Temperature Range	-40°C to +65°C
Vibration	According to IEC 60721-3-4
Wind Load	200 km/h (survival)
Flammability	UL94
Water Proofing	IP-67
Humidity	ETS 300 019-1-4, EN 302 085 (annex A.1.1)
Salt Fog	According to IEC 68-2-11
Ice and Snow	25mm radial (survival)

#### Standard Compliance

ETSI EN 302 085 V1.2.3 – TS1

### Ordering Options

MA-WA61-25	Antenna with N-Type connector suited for MNT-22 (optional wall/pole adjustable mount)
MA-WA61-25B	Antenna with N-Type connector with MNT-22 mount
MA-WA61-25SMES	Antenna with small enclosure, SMA RA Connector and MNT-22

Patterns are available on our website

MARS Antennas & RF Systems proprietary information

MARS reserves the right to make technical changes or modifications to any of its products and specifications without prior notice and without implementing such changes to prior supplied products. Product images are representative and indicative only. Warranty terms and general conditions of sale are applicable on any purchase of any product, available on MARS website.

3 Hamanor st. Holon 5886103, P.O.Box 1852 Holon 5811801, Israel

Tel: +972-3-5599661 • Fax: +972-3-5599677 • e-mail: mars@marsant.co.il • web: www.mars-antennas.com



## MA-WA48-DP23

### 4.4-5.1 GHz Dual Polarization/Dual Slant Subscriber Antenna

#### Antenna Features:

- Dual slant if mounted diagonally.
- Efficient and stable performance.
- High gain/size ratio.
- Light weight and durable construction.
- UV protected radome made of polycarbonate suitable for harsh weather installations.
- Easy mounting allowing Az/EI adjustment and 45deg. turn installation.



## Specifications

### Electrical

Frequency range	4.4-5.1 GHz
GAIN	23 ± 1 dBi
VSWR, max.	1.7 : 1
Polarization	Linear, Vertical & Horizontal
3 dB Beam-Width, H-Plane, typ.	9°
3 dB Beam-Width, E-Plane, typ.	9°
Side Lobes, min.	-12 dB
Cross Polarization, min.	-20 dB
Port to Port Isolation, typ.	-35 dB
Front to Back Ratio, min.	-35 dB
Input power, max.	10 Watt
Input Impedance	50 Ohm
Lightning Protection	DC Grounded

### Mechanical

Dimensions (HxWxD)	370 x 370 x 40 mm (14.5" x 14.5" x 1.6")
Weight	2.1 kg.
Connector	2 x N-Type Female
Back Plane	Aluminum protected through chemical passivation
Radome	UV Protected, Polycarbonate
Mount	See ordering options

### Environmental

Operating Temperature Range	-40°C to +65°C
Vibration	According to IEC 60721-3-4
Wind Load	200 km/h (survival)
Flammability	UL94
Water Proofing	IP-67
Humidity	ETS 300 019-1-4, EN 302 085 (annex A.1.1)
Salt Fog	According to IEC 68-2-11

## Ordering Options

MA-WA48-DP23	Antenna Suited for MNT-22 (optional wall/pole adjustable mount)
MA-WA48-DP23B	Antenna with MNT-22 mount

Patterns are available on our website

MARS Antennas & RF Systems proprietary information

MARS reserves the right to make technical changes or modifications to any of its products and specifications without prior notice and without implementing such changes to prior supplied products. Product images are representative and indicative only. Warranty terms and general conditions of sale are applicable on any purchase of any product, available on MARS website.

3 Hamanor st. Holon 5886103, P.O.Box 1852 Holon 5811801, Israel

Tel: +972-3-5599661 • Fax: +972-3-5599677 • e-mail: mars@marsant.co.il • web: www.mars-antennas.com

## MA-WA52-DP24

### 4.4 – 6.1 GHz Dual Polarization/Dual Slant Subscriber Antenna

MARS 5 GHz Dual Polarized Antenna designed to provide full coverage for the 5 GHz frequency band.

Additional Features:

- Dual slant if mounted diagonally.
- Efficient and stable performance.
- High gain/size ratio.
- Lightweight and durable construction.
- UV protected radome made of polycarbonate suitable for harsh weather installations.

MARS 5 GHz Dual Polarized Antenna & Enclosure Solution comprises of waterproof 5 GHz Dual Polarized Antenna and weatherproof enclosure with provisions for Az/EI Mounting device.

This solution enables WISP/Integrator to design his own low cost, weatherized subscriber unit, saving high costs of special antenna-radio integration.



## Specifications

<b>Electrical</b>		
Frequency range		4.4 – 6.1 GHz
Gain		24 ± 1 dBi
VSWR	typ. max.	1.7: 1 2.0: 1
Polarization	Dual pole	Linear, Vertical & Horizontal
3dB Beam-Width, H-Plane, typ.		8°
3dB Beam-Width, E-Plane, typ.		8°
Side Lobes,	typ. min.	-12 dB -10 dB
Cross Polarization, typ.		-23 dB
Front to Back Ratio, min.		-35 dB
Port to Port Isolation,	typ. min.	-30 dB -28 dB
Input power, max.		10 Watt
Input Impedance		50 Ohm
Lightning Protection		DC Grounded
<b>Mechanical</b>		
Dimensions (HxWxD)		370 x 370 x 40 mm ( 14.5"x 14.5"x1.6")
Connector		2 x N-type Female
Weight		1.8 kg.
Mounting		See Ordering Options
Radome		UV Protected Polycarbonate
Back Plane		Aluminum protected through chemical passivation.
<b>Environmental</b>		
Operating Temperature Range		-55°C to +65°C
Vibration		According to IEC 60721-3-4
Wind Load		200 Km/h (Survival)
Flammability		UL94
Water Proofing		IP-67
Humidity		ETS 300 019-1-4, EN 302 085 (Annex A.1.1)
Salt Fog		According to IEC 68-2-11

## Ordering Options

MA-WA52-DP24	Antenna 2 x N-Type Female connectors Suited for MNT-22 mount
MA-WA52-DP24B	Antenna 2 x N-Type Female connectors with MNT-22 mount

MARS Antennas & RF Systems proprietary information

MARS reserves the right to make technical changes or modifications to any of its products and specifications without prior notice and without implementing such changes to prior supplied products. Product images are representative and indicative only. Warranty terms and general conditions of sale are applicable on any purchase of any product, available on MARS website.

3 Hamanor st. Holon 5886103, P.O.Box 1852 Holon 5811801, Israel

Tel: +972-3-5599661 • Fax: +972-3-5599677 • e-mail: mars@marsant.co.il • web: www.mars-antennas.com

## MA-WA56-DP13

### 4.9-6.1 GHz Dual Polarization/Dual Slant Subscriber Antenna

MARS 5 GHz Dual Polarized Antenna designed to provide full coverage for the 5 GHz frequency band.

Additional Features:

- Dual slant if mounted diagonally.
- Efficient and stable performance.
- High gain/size ratio.
- Light weight and durable construction.
- UV protected radome made of polycarbonate suitable for harsh weather installations.
- Easy mounting allowing Az/EI adjustment and 45deg. turn installation.



## Specifications

### Electrical

Frequency range		4.9-6.1 GHz
GAIN, typ.	H-pol	14.5 dBi
	V-pol	13.5 dBi
VSWR, max.		1.7 : 1
Polarization	Dual Pole Dual Slant (opt.)	Linear, Vertical & Horizontal ±45° (diamond shape)
3dB Beam-Width, H-Plane, typ.		35°
3dB Beam-Width, E-Plane, typ.		35°
Side Lobes, min.		-10 dB
Cross Polarization, typ.		-15 dB
Front to Back Ratio, min.		-20 dB
Port to Port Isolation, min.		-24 dB
Input power, max.		50 Watt
Input Impedance		50 Ohm
Lightning Protection		DC Grounded

### Mechanical

Dimensions (HxWxD)	112 x 112 x 33.5 mm (4.41" x 4.41" x 1.32")
Connector	2 x Right Angle SMA ,Female
Weight	147 gr.
Mounting	See Ordering Options
Radome	UV Protected Polycarbonate
Back Plane	Aluminum protected through chemical passivation.

### Environmental

Operating Temperature Range	-55°C to +65°C
Vibration	According to IEC 60721-3-4
Wind Load	200 Km/h (Survival)
Flammability	UL94
Water Proofing	IP-67
Humidity	ETS 300 019-1-4, EN 302 085 (Annex A.1.1)
Salt Fog	According to IEC 68-2-11

## Ordering Options

MA-WA56-DP13	Antenna 2 x Right Angle SMA ,Female connectors Suited for MNT-4LU mount
MA-WA56-DP13B	Antenna 2 x Right Angle SMA ,Female connectors with MNT-4LU mount

Patterns are available on our website

MARS Antennas & RF Systems proprietary information

MARS reserves the right to make technical changes or modifications to any of its products and specifications without prior notice and without implementing such changes to prior supplied products. Product images are representative and indicative only. Warranty terms and general conditions of sale are applicable on any purchase of any product, available on MARS website.

3 Hamanor st. Holon 5886103, P.O.Box 1852 Holon 5811801, Israel

Tel: +972-3-5599661 • Fax: +972-3-5599677 • e-mail: mars@marsant.co.il • web: www.mars-antennas.com

## MA-WA56-DP19

### 4.9-6.1 GHz Dual Polarization/Dual Slant Subscriber Antenna

MARS 5 GHz Dual Polarized Antenna designed to provide full coverage for the 5 GHz frequency band.

Additional Features:

- Dual slant if mounted diagonally.
- Efficient and stable performance.
- High gain/size ratio.
- Light weight and durable construction.
- UV protected radome made of polycarbonate allowing for harsh weather installations.
- Easy mounting allowing for Az/EI adjustment and 45deg. turn installation.



### Specifications

#### Electrical

Frequency range	4.9-5.875 GHz	5.875-6.1 GHz
GAIN	19 ± 1 dBi	19 ± 1 dBi
VSWR, max.	1.7 : 1	2 : 1
Polarization	Linear, Vertical & Horizontal	
Dual Pole	±45°	
Dual Slant (opt.)		
3 dB Beam-Width, H-Plane, typ.	16°	
3 dB Beam-Width, E-Plane, typ.	16°	
Side Lobes, min.	ETSI TS2	
Cross Polarization	-20 dB	
Port to Port Isolation	-30 dB	
Front to Back Ratio, min.	ETSI TS2	
Input power, max.	10 Watt	
Input Impedance	50 Ohm	
Lightning Protection	DC Grounded	

#### Mechanical

Dimensions (HxWxD)	200 x 200 x 33 mm (7.9" x 7.9" x 1.25")
Connector	See ordering options
Weight	400 gr.
Back Plane	Aluminum; protected through chemical passivation
Radome	UV Protected Polycarbonate
Enclosure - Small	171 x 167 x 68 mm. (External dimension)
Mounting	See ordering options

#### Environmental

Operating Temperature Range	-55°C to +65°C
Vibration	According to IEC 60721-3-4
Wind Load	200 km/h (Survival)
Flammability	UL94
Water Proofing	IP-67
Humidity	ETS 300 019-1-4, EN 302 085 (Annex A.1.1)
Salt Fog	According to IEC 68-2-11

### Ordering Options

MA-WA56-DP19	Antenna 2 x N-Type Female connectors Suited for MNT-23 mount
MA-WA56-DP19B	Antenna 2 x N-Type Female connectors with MNT-23 mount
MA-WA56-DP19SMES	Antenna 2 x SMA RA Female connectors, enclosure with MNT-22 mount
MA-WA56-DP19SMESZ	Antenna 2 x SMA RA Female connectors, enclosure with PEMs and MNT-22 mount

Patterns are available on our website

MARS Antennas & RF Systems proprietary information

MARS reserves the right to make technical changes or modifications to any of its products and specifications without prior notice and without implementing such changes to prior supplied products. Product images are representative and indicative only. Warranty terms and general conditions of sale are applicable on any purchase of any product, available on MARS website.

3 Hamanor st. Holon 5886103, P.O.Box 1852 Holon 5811801, Israel

Tel: +972-3-5599661 • Fax: +972-3-5599677 • e-mail: mars@marsant.co.il • web: www.mars-antennas.com

## MA-WA56-DP20

### 4.9-5.875 GHz Dual Polarization/Dual Slant Subscriber Antenna

MARS 5 GHz Dual Polarized Antenna designed to provide full coverage for the 5 GHz frequency band.

Additional Features:

- Dual slant if mounted diagonally.
- Efficient and stable performance.
- High gain/size ratio.
- Light weight and durable construction.
- UV protected radome made of polycarbonate suitable for harsh weather installations.
- Easy mounting allowing Az/EI adjustment and 45deg. turn installation.



## Specifications

### Electrical

Frequency range	4.9-5.875 GHz
GAIN	21 ± 1 dBi
VSWR, max.	1.7 : 1
Polarization	Dual Pole Dual Slant (opt.)
	Linear, Vertical & Horizontal ±45°
3 dB Beam-Width, H-Plane, typ.	12°
3 dB Beam-Width, E-Plane, typ.	12°
Side Lobes, min.	ETSI TS3
Cross Polarization, min.	-18 dB
Port to Port Isolation, typ.	-30 dB
Front to Back Ratio, min.	ETSI TS3
Input power, max.	10 Watt
Input Impedance	50 Ohm
Lightning Protection	DC Grounded

### Mechanical

Dimensions (HxWxD)	305 x 305 x 15 mm (12" x 12" x 0.6")
Connector (without enclosure)	2 x N-Type Female
Connector (with enclosure)	2 x SMA Female
Weight	900 gr.
Back Plane	Aluminum; protected through chemical passivation
Radome	UV Protected Polycarbonate
Enclosure - Large	287 x 287 x 68 mm. (External dimension)
Mounting	See ordering options

### Environmental

Operating Temperature Range	-55°C to +65°C
Vibration	According to IEC 60721-3-4
Wind Load	200 Km/h (Survival)
Flammability	UL94
Water Proofing	IP-67
Humidity	ETS 300 019-1-4, EN 302 085 (Annex A.1.1)
Salt Fog	According to IEC 68-2-11

## Ordering Options

MA-WA56-DP20	Antenna with 2xN-Type Female suited for MNT-22 (optional wall/pole adjustable mount)
MA-WA56-DP20B	Antenna with 2xN-Type Female with MNT-22 mount
MA-WA56-DP20SMELZ	Antenna with large enclosure, 2 x SMA Female Connector and MNT-22

Patterns are available on our website

MARS Antennas & RF Systems proprietary information

MARS reserves the right to make technical changes or modifications to any of its products and specifications without prior notice and without implementing such changes to prior supplied products. Product images are representative and indicative only. Warranty terms and general conditions of sale are applicable on any purchase of any product, available on MARS website.

3 Hamanor st. Holon 5886103, P.O.Box 1852 Holon 5811801, Israel

Tel: +972-3-5599661 • Fax: +972-3-5599677 • e-mail: mars@marsant.co.il • web: www.mars-antennas.com

## MA-WA56-DP23

### 4.9-6.1 GHz Dual Polarization/Dual Slant Subscriber Antenna

MARS 5 GHz Dual Polarized Antenna designed to provide full coverage for the 5 GHz frequency band.

Additional Features:

- Dual slant if mounted diagonally.
- Efficient and stable performance.
- High gain/size ratio.
- Light weight and durable construction.
- UV protected radome made of polycarbonate suitable for harsh weather installations.
- Easy mounting allowing Az/EI adjustment and 45deg. turn installation.



## Specifications

### Electrical

Frequency range	4.9-6.1 GHz
GAIN	23 ± 1 dBi
VSWR, max.	1.7 : 1
Polarization	Dual Pole Dual Slant (opt.)
	Linear, Vertical & Horizontal ±45° (diamond shape)
3dB Beam-Width, H-Plane, typ.	10°
3dB Beam-Width, E-Plane, typ.	10°
Side Lobes, min.	ETSI TS3
Cross Polarization, typ.	-20 dB
Front to Back Ratio, min.	ETSI TS3
Port to Port Isolation, typ.	-30 dB
Input power, max.	10 Watt
Input Impedance	50 Ohm
Lightning Protection	DC Grounded

### Mechanical

Dimensions (HxWxD)	305 x 305 x 15 mm (12" x 12" x 1.6")
Connector (without enclosure)	2 x N-Type, Female
Connector (with enclosure)	2 x SMA RA Female
Weight	900 gr.
Mounting	See ordering options
Radome	UV Protected Polycarbonate
Enclosure - Large	287 x 287 x 68 mm. (External dimension)
Back Plane	Aluminum protected through chemical passivation

### Environmental

Operating Temperature Range	-55°C to +65°C
Vibration	According to IEC 60721-3-4
Wind Load	200 Km/h (Survival)
Flammability	UL94
Water Proofing	IP-67
Humidity	ETS 300 019-1-4, EN 302 085 (Annex A.1.1)
Salt Fog	According to IEC 68-2-11

## Ordering Options

MA-WA56-DP23	Antenna Suited for MNT-22 (optional wall/pole adjustable mount)
MA-WA56-DP23B	Antenna with MNT-22 mount
MA-WA56-DP23SMELZ	Antenna with large enclosure, 2 X SMA Connectors with PEMs and MNT-22

Patterns are available on our website

MARS Antennas & RF Systems proprietary information

MARS reserves the right to make technical changes or modifications to any of its products and specifications without prior notice and without implementing such changes to prior supplied products. Product images are representative and indicative only. Warranty terms and general conditions of sale are applicable on any purchase of any product, available on MARS website.

3 Hamanor st. Holon 5886103, P.O.Box 1852 Holon 5811801, Israel

Tel: +972-3-5599661 • Fax: +972-3-5599677 • e-mail: mars@marsant.co.il • web: www.mars-antennas.com

## MA-WA56-DP25N

### 4.9-5.875 GHz Dual Polarized/ Dual Slant Antenna

MARS 5 GHz Dual Polarized Antenna designed to provide full coverage for the 5 GHz frequency band.

Additional Features:

- Dual slant if mounted diagonally.
- Efficient and stable performance.
- High gain/size ratio.
- Light weight and durable construction.
- UV protected radome made of polycarbonate suitable for harsh weather installations.

MARS 5 GHz Dual Polarized Antenna & Enclosure Solution comprises of waterproof 5 GHz Dual Polarized Antenna and weatherproof enclosure with provisions for Az/EI Mounting device. This solution enables WISP/Integrator to design his own low cost, weatherized subscriber unit, saving high costs of special antenna-radio integration.



### Specifications

#### Electrical

Frequency range		4.9-5.875 GHz
GAIN	V-Pol	23.5 ± 1 dBi
	H-Pol	24.5 ± 1dBi
VSWR, max.		1.7 : 1
Polarization	Dual Pole	Linear, Vertical & Horizontal
	Dual Slant (opt.)	±45°
3 dB Beam-Width, H-Plane, typ.		7°-9°
3 dB Beam-Width, E-Plane, typ.		7°-9°
Side Lobes, min.		ETSI TS3, TS4, TS5
Cross Polarization, typ.		-25 dB
Port to Port Isolation, typ.		-30 dB
Front to Back Ratio, min.		ETSI TS3, TS4, TS5
Input power, max.		5 Watt
Input Impedance		50 Ohm
Lightning Protection		DC Grounded

#### Mechanical

Dimensions (HxWxD)		370 x 370 x 40 mm (14.5" x 14.5" x 1.6")
Connector (without enclosure)		2 x N-Type, Female
Connector (with enclosure)		2 x SMA Female
Weight		1.8 kg.
Back Plane		Aluminum; protected through chemical passivation
Radome		UV Protected Polycarbonate
Enclosure dimensions (external)		287 x 287 x 68 mm.
Enclosure dimensions (internal)		260 x 260 x 45 mm (10.2" x 10.2" x 1.8")
Enclosure internal plate dimensions		245 x 245 mm, height of PCB (from Base for RF to backplane) - 55 mm
Mounting		See ordering options

#### Environmental

Operating Temperature Range		-40°C to +65°C
Vibration		According to IEC 60721-3-4
Wind Load		200 Km/h (Survival)
Flammability		UL94
Water Proofing		IP-67
Humidity		ETS 300 019-1-4, EN 302 085 (Annex A.1.1)
Salt Fog		According to IEC 68-2-11

### Ordering Options

MA-WA56-DP25N	Antenna Suited for MNT-22 (optional wall/pole adjustable mount)
MA-WA56-DP25NB	Antenna with MNT-22 mount
MA-WA56-DP25SMELY	Antenna with large enclosure, 2 x SMA Female Connector and MNT-22
MA-WA56-DP25SMELZ	Antenna with large enclosure, 2 x SMA Female Connector with PEMs and MNT-22

Patterns are available on our website

MARS Antennas & RF Systems proprietary information

MARS reserves the right to make technical changes or modifications to any of its products and specifications without prior notice and without implementing such changes to prior supplied products. Product images are representative and indicative only. Warranty terms and general conditions of sale are applicable on any purchase of any product, available on MARS website.

3 Hamanor st. Holon 5886103, P.O.Box 1852 Holon 5811801, Israel

Tel: +972-3-5599661 • Fax: +972-3-5599677 • e-mail: mars@marsant.co.il • web: www.mars-antennas.com

## MA-WA56-DP28N

### 4.7-6.425 GHz High Gain, Wideband, Dual Polarized/Dual Slant Antenna

MARS 5 GHz Dual Polarized Antenna designed to provide full coverage for the 5 GHz frequency band.

Additional Features:

- Efficient and stable performance.
- High gain/size ratio.
- Durable construction.
- UV protected radome made of polycarbonate allowing harsh weather installations.



## Specifications

### Electrical

Frequency range		4.7-4.9 GHz	4.9-5.15 GHz	5.15-5.875 GHz	5.875-6.1GHz	6.1-6.425 GHz
GAIN	V-Pol:	28 ± 1dBi	28.5 ± 0.5 dBi	29 ± 0.5 dBi	28.5 ± 0.5 dBi	27.5 ± 1 dBi
	H-Pol:	27 ± 1 dBi	28 ± 0.5 dBi	28.5±0.5 dBi	28 ± 1 dBi	27 ± 1 dBi
VSWR, max.		2.7: 1	2 : 1	1.9 : 1	2 : 1	2.6 :1
Polarization	Dual Pole Dual Slant (opt.)	Dual Polarization V&H ±45°				
3dB Beam-Width, H-Plane, typ.		5.5°	5.2°	4.7°	4.4°	5°
3dB Beam-Width, E-Plane, typ.		5.5°	5.2°	4.7°	4.4°	5°
Side Lobes, min.		ETSI TS3				ETSI TS 2
Cross Polarization, min.	V-Pol:	-26 dB	-26 dB	-23 dB	-23 dB	-23 dB
	H-Pol:	-23 dB	-25 dB	-23 dB	-20 dB	-15 dB
Front to Back Ratio, min.		ETSI TS3				
Port to Port Isolation, typ.		-30 dB				
Input power, max.		10 Watt				
Input Impedance		50 Ohm				
Lightning Protection		DC Grounded				

### Mechanical

Dimensions (HxWxD)	600 x 600 x 22 mm (23.5" x 23.5" x 0.86")
Weight	4.7 kg.
Connector (without enclosure)	2 x N-Type Female
Connector (with enclosure)	2 x SMA
Back Plane	Aluminum; Protected through chemical passivation
Radome	UV Protected, Polycarbonate
Enclosure - Small	171 x 167 x 68 mm. (External dimension)
Mount	See ordering options

### Environmental

Operating Temperature Range	-40°C to +65°C
Vibration	According to IEC 60721-3-4
Wind Load	200 km/h (Survival)
Flammability	UL94
Water Proofing	IP-67
Humidity	ETS 300 019-1-4, EN 302 085 (Annex A.1.1)
Salt Fog	According to IEC 68-2-11

## Ordering Options

MA-WA56-DP28N	Antenna Suited for MNT-60A (optional wall/pole adjustable mount)
MA-WA56-DP28NB	Antenna with MNT-60A mount
MA-WA56-DP28NSMESY	Antenna Suited for MNT-60A (2 x SMA with Small Enclosure)

MARS Antennas & RF Systems proprietary information

MARS reserves the right to make technical changes or modifications to any of its products and specifications without prior notice and without implementing such changes to prior supplied products. Product images are representative and indicative only. Warranty terms and general conditions of sale are applicable on any purchase of any product, available on MARS website.

3 Hamanor st. Holon 5886103, P.O.Box 1852 Holon 5811801, Israel

Tel: +972-3-5599661 • Fax: +972-3-5599677 • e-mail: mars@marsant.co.il • web: www.mars-antennas.com



## MA-WABSA55-DP15\_g

Preliminary

### 5.0-6.0 GHz Beam Steering Active Antenna, Azimuth Scan

Dual polarized Beamforming antenna for beam steering applications :

- 100 Deg coverage by 20 Deg Beamwidth.
- 15 options for beam directions with 5 Deg step.
- Reduces co-channel interferences and pointing independent beams toward various clients.



## Specifications

### Electrical

Frequency range	5.0-6.0 GHz
Polarization	Dual Pol
Elevation 3dB beam width	8° - 10°
Azimuth 3dB Beam width	15° - 20°
Azimuth scan step	(3-7)°
Azimuth beam control range *	+/-45° *
Side lobes, typ.	-10 dB
Modes (External control)	Rx or Tx, Beamforming or Broadcast
<b>Beamforming</b> (V & H polarization):	
	Gain of passive antenna part, typ.
	Gain with LNA's (Broadside), typ.
<u>Rx Mode:</u>	Noise figure (Rx channel), typ.
	Output Operating RF Power (Output PA), typ.
<u>Tx Mode:</u>	Gain with PA (Broadside), typ.
<b>Broadcast</b> (V & H polarization):	
	Gain of passive antenna part, typ.
	Azimuth 3dB Beam width
	Azimuth 5dB Beam width
<u>Rx Mode:</u>	Gain with LNA's, typ.
<u>Tx Mode:</u>	Output Operating RF Power (Output PA), typ.
	Gain with PA, typ.
Max Input RF Power (damage)	18dBm
VSWR	2 : 1
Impedance	50 Ohm
Front to Back Ratio, min.	-30 dB
Cross Polarization, typ.	-20 dB
Port-Port Isolation, typ.	-25 dB
Beam and Modes selection time, typ.	1-2 us
External Power supply	+5V ; PoE (+48 B)
External control interface	GPIO (7 wires)
Lighting protection	DC grounded

\* - For Azimuth beam control range +/- (30-45)° : Gain = Gain, typ. – (~3) dB; Side Lobes < -(1-3)dB.

### Mechanical

Dimensions (HxWxD)	370x370x60mm (TBD)
Weight	TBD
Connectors RF	SMA Type Female
DC connectors	TBD
Radome	UV Protected Polycarbonate, white

### Environmental

Operating Temperature	-20°C to +60°C
Dynamics	IEC 60721-3-4
Humidity	ETS 300 019-1-4, EN 302 085 (annex A.1.1)
Salt Fog	IEC 68-2-11
Water Proofing	IP-67

MARS Antennas & RF Systems proprietary information

MARS reserves the right to make technical changes or modifications to any of its products and specifications without prior notice and without implementing such changes to prior supplied products. Product images are representative and indicative only. Warranty terms and general conditions of sale are applicable on any purchase of any product, available on MARS website.

3 Hamanor st. Holon 5886103, P.O.Box 1852 Holon 5811801, Israel

Tel: +972-3-5599661 • Fax: +972-3-5599677 • e-mail: mars@marsant.co.il • web: www.mars-antennas.com

**MA-PBSA56-DP21**

**Preliminary**

**5-6 GHz Passive Antenna For Beam Steering, Azimuth Scan**

Array antenna for Beam Steering Applications

- Dual polarized antenna four columns each.
- Distance  $0.5 \lambda$  between columns in the center frequency.



**Specifications**

*Electrical*

Frequency range		5 - 6 GHz
Polarization	Dual Pol	V&H
<b>Individual Column</b>		
Gain, typ.		16 dBi
3 dB Beam-Width, Azimuth Plane		$90^\circ \pm 10^\circ$
Cross Polarization, typ.		-20 dB
Front to Back Ratio, min.		-30 dB
<b>Array 4 Columns</b> (Equal Amp & Phase Boresight)		
Gain, typ.		21 dBi
3 dB Beam-Width, Azimuth Plane, typ.		$25^\circ$
Cross Polarization, typ.		-20 dB
Front to Back Ratio, min.		-30 dB
<b>General</b>		
3 dB Beam-Width, Elevation Plane, typ.		$8^\circ$
Side Lobes, Elevation Plane, typ.		-12 dB
Input power, max		10W
Input Impedance		50 Ohm
Lightning Protection		DC Ground

*Mechanical*

Dimensions (HxWxD)		370 x 370 x 40 mm (14.5"x 14.5"x 1.6")
Weight		2 kg
Connector		8 x N-Type, Female
Back Plane		Aluminum protected through chemical passivation
Radome		UV Protected, Plastic
Mount		See Ordering Options

*Environmental*

Operating Temperature Range		- 40°C to + 65°C
Vibration		According to IEC 60721-3-4
Wind Load		200 km/h (survival)
Flammability		UL94
Water Proofing		IP-67
Humidity		ETS 300 019-1-4, EN 302 085 (annex A.1.1)
Salt Fog		According to IEC 68-2-11
Ice and Snow		25mm radial (survival)

**Ordering Options**

MA-PBSA56-DP21	Antenna Suited for MNT-22 (optional wall/pole adjustable mount)
MA-PBSA56-DP21	Antenna with MNT-22 mount

MARS Antennas & RF Systems proprietary information

MARS reserves the right to make technical changes or modifications to any of its products and specifications without prior notice and without implementing such changes to prior supplied products. Product images are representative and indicative only. Warranty terms and general conditions of sale are applicable on any purchase of any product, available on MARS website.

3 Hamanor st. Holon 5886103, P.O.Box 1852 Holon 5811801, Israel

Tel: +972-3-5599661 • Fax: +972-3-5599677 • e-mail: mars@marsant.co.il • web: www.mars-antennas.com

**MA-TBA56-DP18**

**Preliminary**

**5-6 GHz Passive Antenna For Beam Steering, Azimuth Scan**

Array antenna for Beam Steering Applications

- Dual polarized antenna Two Beams each.



**Specifications**

<i>Electrical</i>	
Frequency range	5 - 6 GHz
Gain, typ.	18 dBi
VSWR, max.	1.7 : 1
Polarization	Dual Pol V&H
3 dB Beam-Width, Azimuth Plane, typ.	40°
3 dB Beam-Width, Elevation Plane, typ.	8°
Side Lobes, Elevation Plane, typ.	-12 dB
Number of Beams (each polarization)	4
Beams Directions	±20°
Cross Polarization, typ.	-20 dB
Front to Back Ratio, min.	-30 dB
Input power, max	10W
Input Impedance	50 Ohm
Lightning Protection	DC Ground
<i>Mechanical</i>	
Dimensions (HxWxD)	400 x 300 x 50 mm (15.7" x 11.8" x 2")
Weight	2 kg
Connector	4 x N-Type , Female
Back Plane	Aluminum protected through chemical passivation
Radome	UV Protected, Plastic
Mount	MNT-22
<i>Environmental</i>	
Operating Temperature Range	-40°C to +65°C
Vibration	According to IEC 60721-3-4
Wind Load	200 km/h (survival)
Flammability	UL94
Water Proofing	IP-65
Humidity	ETS 300 019-1-4, EN 302 085 (annex A.1.1)
Salt Fog	According to IEC 68-2-11
Ice and Snow	25mm radial (survival)

**Ordering Options**

MA-TBA56-DP18	Antenna Suited for MNT-22 (optional wall/pole adjustable mount)
MA-TBA56-DP18B	Antenna with MNT-22 mount

MARS Antennas & RF Systems proprietary information

MARS reserves the right to make technical changes or modifications to any of its products and specifications without prior notice and without implementing such changes to prior supplied products. Product images are representative and indicative only. Warranty terms and general conditions of sale are applicable on any purchase of any product, available on MARS website.

3 Hamanor st. Holon 5886103, P.O.Box 1852 Holon 5811801, Israel

Tel: +972-3-5599661 • Fax: +972-3-5599677 • e-mail: mars@marsant.co.il • web: www.mars-antennas.com

## MA-WA62-DP30

### 5.4-6.5 GHz High Gain, Dual Polarized/Dual Slant Antenna

MARS 6 GHz High Gain Broadband Antenna is designed to provide full coverage for the 6GHz frequency band.

Antenna Features:

- Dual slant if mounted diagonally.
- Efficient and stable performance.
- High gain.
- Durable construction.
- UV protected radome made of polycarbonate.
- Easy mounting allowing Az/EI adjustment and 45deg. turn installation.



## Specifications

### Electrical

Frequency range	5.4-6.5 GHz
GAIN	5.4-6.5 GHz @ 29 ± 1 dBi
VSWR, max.	1.7 : 1 @ 5.4-6.5 GHz
Polarization	Dual Pole Dual Slant (opt.)
3 dB Beam-Width, H-Plane, typ.	4.5°
3 dB Beam-Width, E-Plane, typ.	4.5°
Side Lobes, typ.	-12 dB
Cross Polarization, typ.	-25dB
Front to Back Ratio, min.	-40 dB
Port to Port Isolation, min.	-25 dB
Input power, max.	10 Watt
Input Impedance	50 Ohm
Lightning Protection	DC Grounded

### Mechanical

Dimensions (HxWxD)	600 x 600 x 30 mm (23.5" x 23.5" x 1.2")
Weight	4.7kg
Connector	2 x N-Type, Female
Back Plane	Aluminum protected through chemical passivation
Radome	UV Protected, Polycarbonate
Mount	See ordering options

### Environmental

Operating Temperature Range	-40°C to +65°C
Vibration	According to IEC 60721-3-4
Wind Load	200 km/h (survival)
Flammability	UL94
Water Proofing	IP-67
Humidity	ETS 300 019-1-4, EN 302 085 (annex A.1.1)
Salt Fog	According to IEC 68-2-11

## Ordering Options

MA-WA62-DP30	Antenna Suited for MNT-60A (optional wall/pole adjustable mount)
MA-WA62-DP30B	Antenna with MNT-60A mount

MARS Antennas & RF Systems proprietary information

MARS reserves the right to make technical changes or modifications to any of its products and specifications without prior notice and without implementing such changes to prior supplied products. Product images are representative and indicative only. Warranty terms and general conditions of sale are applicable on any purchase of any product, available on MARS website.

3 Hamanor st. Holon 5886103, P.O.Box 1852 Holon 5811801, Israel

Tel: +972-3-5599661 • Fax: +972-3-5599677 • e-mail: mars@marsant.co.il • web: www.mars-antennas.com

## MA-WA62-DP24

### 5.7-6.425 GHz Dual Polarized Subscriber Antenna

#### Antenna Features:

- Dual slant if mounted diagonally.
- Efficient and stable performance.
- High gain/size ratio.
- Light weight and durable construction.
- UV protected radome made of polycarbonate suitable for harsh weather installations.
- Easy mounting allowing Az/EI adjustment and 45deg. turn installation.



### Specifications

#### Electrical

Frequency range	5.7-6.425GHz
Gain ,typ.	24 dBi
VSWR, max.	1.7 : 1
Polarization	Linear, Vertical & Horizontal
Dual Pole	
Dual Slant (opt.)	±45°
3 dB Beam-Width, H-Plane, typ.	8.5°
3 dB Beam-Width, E-Plane, typ.	8.5°
Side Lobes, min.	-12 dB
Cross Polarization, min.	-16 dB
Port to Port Isolation, typ.	-32 dB
Front to Back Ratio, min.	-35 dB
Input power, max.	10 Watt
Input Impedance	50 Ohm
Lightning Protection	DC Grounded

#### Mechanical

Dimensions (HxWxD)	305 x 305 x 15 mm (12" x 12" x 0.6")
Connector	2 x N-Type Female Right Angle
Weight	950 gr.
Back Plane	Aluminum ; protected through chemical passivation
Radome	UV Protected Polycarbonate
Mounting	See ordering options

#### Environmental

Operating Temperature Range	-55°C to +65°C
Vibration	According to IEC 60721-3-4
Wind Load	200 Km/h (Survival)
Flammability	UL94
Water Proofing	IP-67
Humidity	ETS 300 019-1-4, EN 302 085 (Annex A.1.1)
Salt Fog	According to IEC 68-2-11

### Ordering Options

MA-WA62-DP24	Antenna Suited for MNT-22 (optional wall/pole adjustable mount)
MA-WA62-DP24B	Antenna with MNT-22 mount

Patterns are available on our website

MARS Antennas & RF Systems proprietary information

MARS reserves the right to make technical changes or modifications to any of its products and specifications without prior notice and without implementing such changes to prior supplied products. Product images are representative and indicative only. Warranty terms and general conditions of sale are applicable on any purchase of any product, available on MARS website.

3 Hamanor st. Holon 5886103, P.O.Box 1852 Holon 5811801, Israel

Tel: +972-3-5599661 • Fax: +972-3-5599677 • e-mail: mars@marsant.co.il • web: www.mars-antennas.com

## MA-WA62-DP19

### 5.7-6.425 GHz Dual Polarization Subscriber Antenna

MARS 6 GHz Broadband Medium Gain Antenna covers newly approved 5.7-6.425 GHz band.

Additional Features:

- Exceptionally high gain.
- Light weight and durable construction.
- DC grounded for lightning protection.
- Easy mounting allowing Az/EI adjustment.
- UV protected radome suitable for harsh environment installations



## Specifications

### Electrical

Frequency range	5.7-6.425 GHz
GAIN (without cable)	19 ± 1 dBi
VSWR, max.	1.7 : 1
Polarization	Dual Pole Dual Slant (opt.)
	Linear, Vertical & Horizontal ±45° (diamond shape)
3 dB Beam-Width, Az-Plane, typ.	16°
3 dB Beam-Width, EI-Plane, typ.	16°
Side Lobes, min.	-12 dB
Cross Polarization, min.	-16 dB (-20 dB typ.)
Port to Port Isolation, min.	-25 dB (-30 dB typ.)
Front to Back Ratio, min.	-30 dB
Input power, max.	10 Watt
Input Impedance	50 Ohm
Lightning Protection	DC Grounded

### Mechanical

Dimensions (HxWxD)	200 x 200 x 33 mm (7.9" x 7.9" x 1.25")
Connector	2 x N-Type Female
Weight	400 gr.
Radome	UV Protected Polycarbonate
Mounting	See ordering options

### Environmental

Operating Temperature Range	-55°C to +65°C
Vibration	According to IEC 60721-3-4
Wind Load	200 Km/h (Survival)
Flammability	UL94
Humidity	ETS 300 019-1-4, EN 302 085 (Annex A.1.1)
Water Proofing	IP-67
Salt Fog	According to IEC 68-2-11

## Ordering Options

MA-WA62-DP19	Antenna Suited for MNT-23
MA-WA62-DP19B	Antenna with MNT-23 mount

MARS Antennas & RF Systems proprietary information

MARS reserves the right to make technical changes or modifications to any of its products and specifications without prior notice and without implementing such changes to prior supplied products. Product images are representative and indicative only. Warranty terms and general conditions of sale are applicable on any purchase of any product, available on MARS website.

3 Hamanor st. Holon 5886103, P.O.Box 1852 Holon 5811801, Israel

Tel: +972-3-5599661 • Fax: +972-3-5599677 • e-mail: mars@marsant.co.il • web: www.mars-antennas.com

## MA-WA55-TPMIMO

### 5.125-6.1 GHz Triple Polarization MIMO Subscriber Antenna

MARS Triple Polarization antenna provides coverage of 5.125-6.1 GHz frequency band in a single antenna radome.

Additional Features:

- 3 Ports: Dual Slant ( $\pm 45^\circ$ ) and Vertical Polarization.
- Specially designed for MIMO applications for optimal decorrelation.
- Light weight and durable construction.
- UV protected radome made of polycarbonate.
- Can be customized with customer defined back plane and different connector configurations.



### Specifications

#### Electrical

Frequency range	5.125-6.1 GHz
GAIN	Vertical Pol. 19 dBi
	Dual Slant Pol. 17.5 dBi
VSWR, max.	1.7 : 1
Polarization	Dual Slant $\pm 45^\circ$ and Vertical
3 dB Beam-Width-Azimuth, typ.	Dual Slant: $20^\circ$ ; V- Pol $22^\circ$
3 dB Beam-Width-Elevation, typ.	Dual Slant: $19^\circ$ ; V- Pol $14^\circ$
Side Lobes, min.	-12 dB
Front to Back Ratio, min.	-35 dB
Port to Port Isolation	-40 dB (Vertical to $\pm 45^\circ$ Dual Slant)
Port to Port Isolation	-30 dB ( $+45^\circ$ Dual Slant to $-45^\circ$ Dual Slant)
Input power, max.	10 Watt
Input Impedance	50 Ohm
Lightning Protection	DC Grounded

#### Mechanical

Dimensions (HxWxD)	305 x 305 x 15 mm (12" x 12" x 0.6")
Connector	3 x N-Type Female
Weight	1.5 kg.
Mounting	See ordering options
Radome	UV Protected Polycarbonate
Back Plane	Aluminum protected through chemical passivation

#### Environmental

Operating Temperature Range	$-55^\circ\text{C}$ to $+65^\circ\text{C}$
Vibration	According to IEC 60721-3-4
Wind Load	200 Km/h (Survival)
Flammability	UL94
Water Proofing	IP-67
Humidity	ETS 300 019-1-4, EN 302 085 (Annex A.1.1)
Salt Fog	According to IEC 68-2-11

### Ordering Options

MA-WA55-TPMIMO	Antenna Suited for MNT-22 (optional wall/pole adjustable mount)
MA-WA55-TPMIMOB	Antenna with MNT-22 mount

Patterns are available on our website

MARS Antennas & RF Systems proprietary information

MARS reserves the right to make technical changes or modifications to any of its products and specifications without prior notice and without implementing such changes to prior supplied products. Product images are representative and indicative only. Warranty terms and general conditions of sale are applicable on any purchase of any product, available on MARS website.

3 Hamanor st. Holon 5886103, P.O.Box 1852 Holon 5811801, Israel

Tel: +972-3-5599661 • Fax: +972-3-5599677 • e-mail: mars@marsant.co.il • web: www.mars-antennas.com

## MA-WA55-4QP13

### 4.9-6.1 GHz Quad Polarization 4x4 MIMO Subscriber Antenna

Mars Quad Polarization antenna provides coverage of 4.9-6.1 GHz frequency Band.

Additional Features:

- Specially designed for MIMO applications
- Light weight and durable construction.
- UV Protected radome made of Polycarbonate.



Can be customized per customer requirements

## 802.11 ac standard applications approved

### Specifications

#### Electrical

Frequency range	4.9-6.1 GHz
Gain, typ.	4 x 13 dBi
VSWR, max.	1.7 : 1
Polarization	Quad Pole
3dB Beam-Width, H-Plane, typ.	Vertical, Horizontal & Dual Slant ( $\pm 45^\circ$ )
3dB Beam-Width, E-Plane, typ.	37°
Side Lobes, min.	37°
Cross Polarization, typ.	-10 dB
Front to Back Ratio, min.	-13 dB
Port to Port Isolation, min.	-25 dB
Input power, max.	-34 dB
Input Impedance	10 Watt
Lightning Protection	50 Ohm
	DC Grounded

#### Mechanical

Dimensions (HxWxD)	200 x 200 x 33 mm (7.9" x 7.9" x 1.25")
Connector	4 x RA SMA, Female
Weight	400 gr.
Mounting	See ordering options
Radome	UV Protected Polycarbonate
Back Plane	Aluminum protected through chemical passivation.

#### Environmental

Operating Temperature Range	-40°C to +65°C
Vibration	According to IEC 60721-3-4
Wind Load	200 Km/h (Survival)
Flammability	UL94
Water Proofing	IP-67
Humidity	ETS 300 019-1-4, EN 302 085 (Annex A.1.1)
Salt Fog	According to IEC 68-2-11
Ice and Snow	25mm radial (survival)

### Ordering Options

MA-WA55-4QP13	Antenna Suited for MNT-23 (optional wall/pole adjustable mount)
MA-WA55-4QP13B	Antenna with MNT-23 mount

Patterns are available on our website

MARS Antennas & RF Systems proprietary information

MARS reserves the right to make technical changes or modifications to any of its products and specifications without prior notice and without implementing such changes to prior supplied products. Product images are representative and indicative only. Warranty terms and general conditions of sale are applicable on any purchase of any product, available on MARS website.

3 Hamanor st. Holon 5886103, P.O.Box 1852 Holon 5811801, Israel

Tel: +972-3-5599661 • Fax: +972-3-5599677 • e-mail: mars@marsant.co.il • web: www.mars-antennas.com



## MA-WA55-QP4MIMO

### 5.1-5.9 GHz Quad Polarization 4X4 MIMO Subscriber Antenna

Mars Quad Polarization antenna provides coverage of 5.1-5.9 GHz frequency band.

Additional Features:

- Specially designed for MIMO applications
- Lightweight and durable construction.
- UV Protected radome made of Polycarbonate.

Can be customized per customer requirements



### 802.11 ac standard applications approved

#### Specifications

##### Electrical

Frequency range	5.1-5.9 GHz
Gain, typ.	4 X 16 dBi
VSWR, max.	2.0 : 1
Polarization	Quad Pole
3 dB Beam-Width, H-Plane, typ.	Vertical, Horizontal & Dual Slant ( $\pm 45^\circ$ )
3 dB Beam-Width, E-Plane, typ.	25°
Side Lobes, typ.	25°
Cross Polarization, typ.	-12 dB
Front to Back Ratio, min.	-18 dB
Port to Port Isolation	-30 dB
Input power, max.	-36 dB
Input Impedance	10 Watt
Lightning Protection	50 Ohm
	DC Grounded

##### Mechanical

Dimensions (HxWxD)	305 x 305 x 15 mm (12" x 12" x 0.6")
Connector	See Ordering Options
Weight	1.5 Kg.
Mounting	See Ordering Options
Radome	UV Protected Polycarbonate
Back Plane	Aluminum protected through chemical passivation

##### Environmental

Operating Temperature Range	-55°C to +65°C
Vibration	According to IEC 60721-3-4
Wind Load	200 Km/h (Survival)
Flammability	UL94
Water Proofing	IP-67
Humidity	ETS 300 019-1-4, EN 302 085 (Annex A.1.1)
Salt Fog	According to IEC 68-2-11

#### Ordering Options

MA-WA55-QP4MIMO	Antenna with 4xN-Type Female connectors suitable for MNT-22
MA-WA55-QP4MIMOB	Antenna with 4xN-Type Female connectors with MNT-22 mount
MA-WA55-QP4MIMOSMELY	Antenna with large enclosure, 4xPigtails with SMA Connectors and MNT-22

MARS Antennas & RF Systems proprietary information

MARS reserves the right to make technical changes or modifications to any of its products and specifications without prior notice and without implementing such changes to prior supplied products. Product images are representative and indicative only. Warranty terms and general conditions of sale are applicable on any purchase of any product, available on MARS website.

3 Hamanor st. Holon 5886103, P.O.Box 1852 Holon 5811801, Israel

Tel: +972-3-5599661 • Fax: +972-3-5599677 • e-mail: mars@marsant.co.il • web: www.mars-antennas.com

## MA-WA57-QP4MIMO19

### 4.9-6.425 GHz Quad Polarization 4X4 MIMO Subscriber Antenna

Mars Quad Polarization antenna provides coverage of 4.9-6.425 GHz frequency band.

Additional Features:

- Specially designed for MIMO applications
- Lightweight and durable construction.
- UV Protected radome made of Polycarbonate.

Can be customized per customer requirements



## 802.11 ac standard applications approved

### Specifications

#### Electrical

Frequency range	4.9-6.425 GHz
GAIN	4.9-5.15 @ 4x18 dBi 5.15-6.425 @ 4x19 dBi
VSWR, max.	1.7 : 1
Polarization Quad Pole	Vertical, Horizontal & Dual Slant ( $\pm 45^\circ$ )
3 dB Beam-Width-Azimuth, typ.	19°
3 dB Beam-Width-Elevation, typ.	19°
Side Lobes, typ.	-12 dB
Front to Back Ratio, min.	-35 dB
Port to Port Isolation, min.	-34 dB
Input power, max.	10 Watt
Input Impedance	50 Ohm
Lightning Protection	DC Grounded

#### Mechanical

Dimensions (HxWxD)	370 x 370 x 40 mm (14.6" x 14.6" x 1.5")
Connector	4 X N-type Female
Weight	2 kg.
Mounting	See Ordering Options
Radome	UV Protected Polycarbonate
Back Plane	Aluminum protected through chemical passivation

#### Environmental

Operating Temperature Range	-55°C to +65°C
Vibration	According to IEC 60721-3-4
Wind Load	200 Km/h (Survival)
Flammability	UL94
Water Proofing	IP-67
Humidity	ETS 300 019-1-4, EN 302 085 (Annex A.1.1)
Salt Fog	According to IEC 68-2-11

### Ordering Options

MA- WA57-QP4MIMO19	Antenna 4 x N-Type Female connectors Suited for MNT-22 mount
MA- WA57-QP4MIMO19B	Antenna 4 x N-Type Female connectors with MNT-22 mount

MARS Antennas & RF Systems proprietary information

MARS reserves the right to make technical changes or modifications to any of its products and specifications without prior notice and without implementing such changes to prior supplied products. Product images are representative and indicative only. Warranty terms and general conditions of sale are applicable on any purchase of any product, available on MARS website.

3 Hamanor st. Holon 5886103, P.O.Box 1852 Holon 5811801, Israel

Tel: +972-3-5599661 • Fax: +972-3-5599677 • e-mail: mars@marsant.co.il • web: www.mars-antennas.com

## MA-WA56-MIMO5-14

### 5.1-5.9 GHz Subscriber Antenna 5MIMO

MARS subscriber 5MIMO antenna provides coverage of 5.1-5.9 GHz in a single antenna radome.

Additional Features:

- Mid/High gain.
- Light weight and durable construction.
- UV protected radome made of polycarbonate.



Can be customized per customer requirements

## 802.11 ac standard applications approved

### Specifications

#### Electrical

Frequency range	5.1-5.9 GHz
GAIN, typ.	5 x 13.5 dBi
VSWR, max.	1.7 : 1
Polarization	Linear, Vertical & Dual Slant ( $\pm 45^\circ$ )
3dB Beam-Width, H-Plane, typ.	35°
3dB Beam-Width, E-Plane, typ.	35°
Side Lobes, min.	-10 dB
Cross Polarization, typ.	-15 dB
Front to Back Ratio, min.	-20 dB
Port to Port Isolation, min.	-25 dB
Input power, max.	10 Watt
Input Impedance	50 Ohm
Lightning Protection	DC Grounded

#### Mechanical

Dimensions (HxWxD)	305 x 305 x 15 mm
Connector	5 x N-Type ,Female
Weight	840 gr.
Mounting	See Ordering Options
Radome	UV Protected Polycarbonate
Back Plane	Aluminum protected through chemical passivation.

#### Environmental

Operating Temperature Range	-55°C to +65°C
Vibration	According to IEC 60721-3-4
Wind Load	200 Km/h (Survival)
Flammability	UL-94
Water Proofing	IP-67
Humidity	ETS 300 019-1-4, EN 302 085 (Annex A.1.1)
Salt Fog	According to IEC 68-2-11

### Ordering Options

MA-WA56-MIMO5-14	Antenna 5 x N-Type Female connectors Suited for MNT-22 mount
MA-WA56-MIMO5-14B	Antenna 5 x N-Type Female connectors with MNT-22 mount

MARS Antennas & RF Systems proprietary information

MARS reserves the right to make technical changes or modifications to any of its products and specifications without prior notice and without implementing such changes to prior supplied products. Product images are representative and indicative only. Warranty terms and general conditions of sale are applicable on any purchase of any product, available on MARS website.

3 Hamanor st. Holon 5886103, P.O.Box 1852 Holon 5811801, Israel

Tel: +972-3-5599661 • Fax: +972-3-5599677 • e-mail: mars@marsant.co.il • web: www.mars-antennas.com

## MA-WD55-16MIMO

### 4.9-6.1 GHz MIMO Base Station Antenna, 90°

#### Antenna Features:

- Specially designed for MIMO applications.
- Quick and easy installation.
- Easy mounting allowing obtaining required down tilt.
- Suitable for harsh environment installations.
- DC grounded.



## Specifications

### Electrical

Frequency range	4.9-6.1 GHz
GAIN, typ.	3 x 16 dBi
VSWR, max.	1.8 : 1
Polarization	Linear, Vertical
3 dB Beam-Width, H-Plane, typ.	90°
3 dB Beam-Width, E-Plane, typ.	8°
Side Lobes, min.	ETSI EN 302 085 V1.2.3-CS1
Cross Polarization, min.	ETSI EN 302 085 V1.2.3-CS1
Front to Back Ratio, min.	ETSI EN 302 085 V1.2.3-CS1
Input power, max.	50 Watt
Input Impedance	50 Ohm
Lightning Protection	DC Grounded

### Mechanical

Dimensions (HxWxD)	400 x 300 x 50 mm (15.7" x 11.8" x 2")
Weight	2.5 kg.
Connector	3 x N-Type, Female
Back Plane	Aluminum protected through chemical passivation
Radome	UV Protected, Plastic
Mount	See ordering options

### Environmental

Operating Temperature Range	-40°C to +65°C
Vibration	According to IEC 60721-3-4
Wind Load	200 km/h (survival)
Flammability	UL94
Water Proofing	IP-65
Humidity	ETS 300 019-1-4, EN 302 085 (annex A.1.1)
Salt Fog	According to IEC 68-2-11
Ice and Snow	25mm radial (survival)

### Standard Compliance

ETSI EN 302 085 V1.2.3-CS1

## Ordering Options

MA-WD55-16MIMO	Antenna Suited for MNT-22 (optional wall/pole adjustable mount)
MA-WD55-16MIMOB	Antenna with MNT-22 mount

Patterns are available on our website

MARS Antennas & RF Systems proprietary information

MARS reserves the right to make technical changes or modifications to any of its products and specifications without prior notice and without implementing such changes to prior supplied products. Product images are representative and indicative only. Warranty terms and general conditions of sale are applicable on any purchase of any product, available on MARS website.

3 Hamanor st. Holon 5886103, P.O.Box 1852 Holon 5811801, Israel

Tel: +972-3-5599661 • Fax: +972-3-5599677 • e-mail: mars@marsant.co.il • web: www.mars-antennas.com

## MA-WE55-15MIMO

### 4.9-6.1 GHz MIMO Base Station Antenna, 120°

#### Antenna Features:

- Specially designed for MIMO applications.
- Quick and easy installation.
- Easy mounting allowing obtains required down tilt.
- Suitable for harsh environment installations.
- DC grounded.



## Specifications

### Electrical

Frequency range	4.9-6.1 GHz
GAIN, typ.	3 x 15 dBi
VSWR, max.	1.8 : 1
Polarization	Linear, Vertical
3 dB Beam-Width, H-Plane, typ.	120°
3 dB Beam-Width, E-Plane, typ.	8°
Side Lobes, min.	ETSI EN 302 085 V1.2.3-CS1
Cross Polarization, min.	ETSI EN 302 085 V1.2.3-CS1
Front to Back Ratio, min.	ETSI EN 302 085 V1.2.3-CS1
Input power, max.	50 Watt
Input Impedance	50 Ohm
Lightning Protection	DC Grounded

### Mechanical

Dimensions (HxWxD)	400 x 300 x 50 mm (15.7" x 11.8" x 2")
Weight	2.5 kg.
Connector	3 x N-Type, Female
Back Plane	Aluminum protected through chemical passivation
Radome	UV Protected, Plastic
Mount	See ordering options

### Environmental

Operating Temperature Range	-40°C to +65°C
Vibration	According to IEC 60721-3-4
Wind Load	200 km/h (survival)
Flammability	UL94
Water Proofing	IP-65
Humidity	ETS 300 019-1-4, EN 302 085 (annex A.1.1)
Salt Fog	According to IEC 68-2-11
Ice and Snow	25mm radial (survival)

### Standard Compliance

ETSI EN 302 085 V1.2.3 – CS1

## Ordering Options

MA-WE55-15MIMO	Antenna Suited for MNT-22 (optional wall/pole adjustable mount)
MA-WE55-15MIMOB	Antenna with MNT-22 mount

Patterns are available on our website

MARS Antennas & RF Systems proprietary information

MARS reserves the right to make technical changes or modifications to any of its products and specifications without prior notice and without implementing such changes to prior supplied products. Product images are representative and indicative only. Warranty terms and general conditions of sale are applicable on any purchase of any product, available on MARS website.

3 Hamanor st. Holon 5886103, P.O.Box 1852 Holon 5811801, Israel

Tel: +972-3-5599661 • Fax: +972-3-5599677 • e-mail: mars@marsant.co.il • web: www.mars-antennas.com

## MA-WC55-17

### 5 GHz Base Station Antenna, 60°

MARS 60° Broadband Sector Antenna provides a cost effective solution for large scale of WLL, WLAN, H-LAN, ISM, UNII, Public Safety, Municipal MESH Networks and Point-to- Multi-Point applications.

Additional Features:

- Efficient and stable performance with 17 dBi of gain.
- Small size allowing easy blending with any environment.
- Tilt mount allowing quick and easy installation.
- UV protected radome suitable for harsh environment installations.



### Specifications

#### Electrical

Frequency range	4.9-6.1 GHz
GAIN, typ.	17 dBi
VSWR, max.	1.8 : 1
Polarization	Linear, Vertical
3 dB Beam-Width, H-Plane, typ.	60°
3 dB Beam-Width, E-Plane, typ.	8°
Side Lobes, min.	ETSI EN 302 085 V1.2.3 – CS1
Cross Polarization, min.	ETSI EN 302 085 V1.2.3 – CS1
Front to Back Ratio, min.	ETSI EN 302 085 V1.2.3 – CS1
Input power, max	50 Watt
Input Impedance	50 Ohm
Lightning Protection	DC Grounded

#### Mechanical

Dimensions (HxWxD)	573 x 95 x 53 mm (22.6" x 3.7" x 2.1")
Weight	700 gr.
Connector	N-Type, Female
Back Plane	Aluminum; protected through chemical passivation
Radome	UV Protected Polycarbonate
Mount	See ordering options

#### Environmental

Operating Temperature Range	-40°C to +65°C
Vibration	According to IEC 60721-3-4
Wind Load	200 km/h (survival)
Flammability	UL94
Water Proofing	IP-65
Humidity	ETS 300 019-1-4, EN 302 085 (annex A.1.1)
Salt Fog	According to IEC 68-2-11
Ice and Snow	25mm radial (survival)

#### Standard Compliance

	ETSI EN 302 085 V1.2.3 – CS1
--	------------------------------

### Ordering Options

MA-WC55-17	Antenna Suited for MNT-22 (optional wall/pole adjustable mount)
MA-WC55-17B	Antenna with MNT-22 mount

Patterns are available on our website

MARS Antennas & RF Systems proprietary information

MARS reserves the right to make technical changes or modifications to any of its products and specifications without prior notice and without implementing such changes to prior supplied products. Product images are representative and indicative only. Warranty terms and general conditions of sale are applicable on any purchase of any product, available on MARS website.

3 Hamanor st. Holon 5886103, P.O.Box 1852 Holon 5811801, Israel

Tel: +972-3-5599661 • Fax: +972-3-5599677 • e-mail: mars@marsant.co.il • web: www.mars-antennas.com

## MA-WD55-16

### 5 GHz Base Station Antenna, 90°

MARS 90° Broadband Sector Antenna provides a cost effective solution for large scale WLL, WLAN, H-LAN, ISM, UNII, Public Safety, Municipal MESH Networks and Point-to-Multi-Point applications.

Additional Features:

- Stable performance with 16 dBi of gain.
- Small size allowing easy blending with any environment.
- Tilt mount allowing quick and easy installation.
- UV protected radome suitable for harsh environment installations.



### Specifications

#### Electrical

Frequency range	4.9-6.1 GHz
GAIN, typ.	16 dBi
VSWR, max.	1.8 : 1
Polarization	Linear, Vertical
3 dB Beam-Width, H-Plane, typ.	90°
3 dB Beam-Width, E-Plane, typ.	8°
Side Lobes, min.	ETSI EN 302 085 V1.2.3 – CS1
Cross Polarization, min.	ETSI EN 302 085 V1.2.3 – CS1
Front to Back Ratio, min.	ETSI EN 302 085 V1.2.3 – CS1
Input power, max.	50 Watt
Input Impedance	50 Ohm
Lightning Protection	DC Grounded

#### Mechanical

Dimensions (HxWxD)	573 x 95 x 53 mm (22.6" x 3.7" x 2.1")
Weight	700 gr.
Connector	N-Type, Female
Back Plane	Aluminum protected through chemical passivation
Radome	UV Protected Polycarbonate
Mount	See ordering options

#### Environmental

Operating Temperature Range	-40°C to +65°C
Vibration	According to IEC 60721-3-4
Wind Load	200 km/h (survival)
Flammability	UL94
Water Proofing	IP-65
Humidity	ETS 300 019-1-4, EN 302 085 (annex A.1.1)
Salt Fog	According to IEC 68-2-11
Ice and Snow	25mm radial (survival)

#### Standard Compliance

ETSI EN 302 085 V1.2.3 – CS1

### Ordering Options

MA-WD55-16	Antenna Suited for MNT-22 (optional wall/pole adjustable mount)
MA-WD55-16B	Antenna with MNT-22 mount

Patterns are available on our website

MARS Antennas & RF Systems proprietary information

MARS reserves the right to make technical changes or modifications to any of its products and specifications without prior notice and without implementing such changes to prior supplied products. Product images are representative and indicative only. Warranty terms and general conditions of sale are applicable on any purchase of any product, available on MARS website.

3 Hamanor st. Holon 5886103, P.O.Box 1852 Holon 5811801, Israel

Tel: +972-3-5599661 • Fax: +972-3-5599677 • e-mail: mars@marsant.co.il • web: www.mars-antennas.com

## MA-WE55-15

### 4.9-6.1 GHz Base Station Antenna, 120°

MARS 120° Broadband Sector Antenna provides a cost effective solution for large scale WLL, WLAN, H-LAN, ISM, UNII, and Point-to-Multi-Point applications.

Additional Features:

- Stable performance with 15 dBi of gain.
- Small size allowing easy blending with any environment.
- Pole mount allowing quick and easy installation and tilting adjustment.
- UV protected radome suitable for harsh environment installations.



## Specifications

### Electrical

Frequency range	4.9-6.1 GHz
GAIN, typ.	15 dBi
VSWR, max.	1.8 : 1
Polarization	Linear, Vertical
3 dB Beam-Width, H-Plane, typ.	120°
3 dB Beam-Width, E-Plane, typ.	8°
Side Lobes, min.	ETSI EN 302 085 V1.2.3 – CS1
Cross Polarization, min.	ETSI EN 302 085 V1.2.3 – CS1
Front to Back Ratio, min.	ETSI EN 302 085 V1.2.3 – CS1
Input power, max.	50 Watt
Input Impedance	50 Ohm
Lightning Protection	DC Grounded

### Mechanical

Dimensions (HxWxD)	573 x 95 x 53 mm (22.6" x 3.7" x 2.1")
Weight	700 gr.
Connector	N-Type, Female
Back Plane	Aluminum; protected through chemical passivation
Radome	UV Protected Polycarbonate
Mount	See ordering options

### Environmental

Operating Temperature Range	-40°C to +65°C
Vibration	According to IEC 60721-3-4
Wind Load	200 km/h (survival)
Flammability	UL94
Water Proofing	IP-65
Humidity	ETS 300 019-1-4, EN 302 085 (annex A.1.1)
Salt Fog	According to IEC 68-2-11
Ice and Snow	25mm radial (survival)

### Standard Compliance

ETSI EN 302 085 V1.2.3 – CS1

## Ordering Options

MA-WE55-15	Antenna Suited for MNT-22 (optional wall/pole adjustable mount)
MA-WE55-15B	Antenna with MNT-22 mount

Patterns are available on our website

MARS Antennas & RF Systems proprietary information

MARS reserves the right to make technical changes or modifications to any of its products and specifications without prior notice and without implementing such changes to prior supplied products. Product images are representative and indicative only. Warranty terms and general conditions of sale are applicable on any purchase of any product, available on MARS website.

3 Hamanor st. Holon 5886103, P.O.Box 1852 Holon 5811801, Israel

Tel: +972-3-5599661 • Fax: +972-3-5599677 • e-mail: mars@marsant.co.il • web: www.mars-antennas.com



## MA-WB55-20

### 5 GHz Base Station Antenna, 30°

MARS 30° Broadband Sector Antenna provides a cost effective solution for large scale WLL, WLAN, H-LAN, ISM, UNII, Public Safety, Municipal MESH Networks and Point-to-Multi-Point applications.

Additional Features:

- Stable performance with 20 dBi of gain.
- Small size allowing easy blending with any environment.
- Tilt mount allowing quick and easy installation.
- UV protected radome suitable for harsh environment installations.



### Specifications

#### Electrical

Frequency range	4.9-6.1 GHz
GAIN, typ.	20 dBi
VSWR, max.	1.8 : 1
Polarization	Linear, Vertical
3 dB Beam-Width, H-Plane, typ.	30°
3 dB Beam-Width, E-Plane, typ.	8°
Side Lobes, min.	ETSI EN 302 085 V1.2.3 – CS1
Cross Polarization, min.	ETSI EN 302 085 V1.2.3 – CS1
Front to Back Ratio, min.	ETSI EN 302 085 V1.2.3 – CS1
Input power, max.	50 Watt
Input Impedance	50 Ohm
Lightning Protection	DC Grounded

#### Mechanical

Dimensions (HxWxL)	573 x 120 x 115 mm (22.6" x 4.7" x 4.5")
Weight	1 kg.
Connector	N-Type, Female
Back Plane	Aluminum protected through chemical passivation
Radome	UV Protected, Polycarbonate
Mount	See ordering options

#### Environmental

Operating Temperature Range	-40°C to +65°C
Vibration	According to IEC 60721-3-4
Wind Load	200 km/h (survival)
Flammability	UL94
Water Proofing	IP-67
Humidity	ETS 300 019-1-4, EN 302 085 (annex A.1.1)
Salt Fog	According to IEC 68-2-11
Ice and Snow	25mm radial (survival)

#### Standard Compliance

ETSI EN 302 085 V1.2.3 – CS1

### Ordering Options

MA-WB55-20	Antenna Suited for MNT-22 (optional wall/pole adjustable mount)
MA-WB55-20B	Antenna with MNT-22 mount

Patterns are available on our website

MARS Antennas & RF Systems proprietary information

MARS reserves the right to make technical changes or modifications to any of its products and specifications without prior notice and without implementing such changes to prior supplied products. Product images are representative and indicative only. Warranty terms and general conditions of sale are applicable on any purchase of any product, available on MARS website.

3 Hamanor st. Holon 5886103, P.O.Box 1852 Holon 5811801, Israel

Tel: +972-3-5599661 • Fax: +972-3-5599677 • e-mail: mars@marsant.co.il • web: www.mars-antennas.com

## MA-WC55-18H

### 5.5 GHz Horizontal Polarization Base Station Antenna, 65°

MARS 65° Broadband Sector Antenna provides a cost effective solution for large scale WLL, WLAN, H-LAN, ISM, UNII, Public Safety, Municipal MESH Networks and Point-to-Multi-Point applications.

Additional Features:

- Stable performance with 18 dBi of gain.
- Small size allowing easy blending with any environment.
- Tilt mount allowing quick and easy installation.
- UV protected radome suitable for harsh environment installations.



## Specifications

### Electrical

Frequency range	4.9-6.1 GHz
GAIN, typ.	18 dBi
VSWR, max.	1.7 : 1
Polarization	Linear, Horizontal
3 dB Beam-Width, H-Plane, typ.	5°
3 dB Beam-Width, E-Plane, typ.	65°
Side Lobes, min.	ETSI EN 302 085 V1.2.3 – CS2
Cross Polarization, min.	ETSI EN 302 085 V1.2.3 – CS1
Front to Back Ratio, min.	ETSI EN 302 085 V1.2.3 – CS2
Input power, max.	20 Watt
Input Impedance	50 Ohm
Lightning Protection	DC Grounded

### Mechanical

Dimensions (HxWxD)	573 x 95 x 53 mm (22.6" x 3.7" x 2.1")
Weight	600 gr.
Connector	N-Type, Female
Back Plane	Aluminum protected through chemical passivation
Radome	UV Protected, Polycarbonate
Mount	See ordering options

### Environmental

Operating Temperature Range	-40°C to +65°C
Vibration	According to IEC 60721-3-4
Wind Load	200 km/h (survival)
Flammability	UL94
Water Proofing	IP-67
Humidity	ETS 300 019-1-4, EN 302 085 (annex A.1.1)
Salt Fog	According to IEC 68-2-11
Ice and Snow	25mm radial (survival)

### Standard Compliance

ETSI EN 302 085 V1.2.3 – CS1 / CS2

## Ordering Options

MA-WC55-18H	Antenna Suited for MNT-22 (optional wall/pole adjustable mount)
MA-WC55-18HB	Antenna with MNT-22 mount

Patterns are available on our website

MARS Antennas & RF Systems proprietary information

MARS reserves the right to make technical changes or modifications to any of its products and specifications without prior notice and without implementing such changes to prior supplied products. Product images are representative and indicative only. Warranty terms and general conditions of sale are applicable on any purchase of any product, available on MARS website.

3 Hamanor st. Holon 5886103, P.O.Box 1852 Holon 5811801, Israel

Tel: +972-3-5599661 • Fax: +972-3-5599677 • e-mail: mars@marsant.co.il • web: www.mars-antennas.com

## MA-WD55-17H

### 5.5 GHz Horizontal Polarization Base Station Antenna, 90°

MARS 90° Broadband Sector Antenna provides a cost effective solution for large scale WLL, WLAN, H-LAN, ISM, UNII, Public Safety, Municipal MESH Networks and Point-to-Multi-Point applications.

Additional Features:

- Stable performance with 17 dBi of gain.
- Small size allowing for easy blending with any environment.
- Tilt mount allowing quick and easy installation.
- UV protected radome suitable for harsh environment installations.

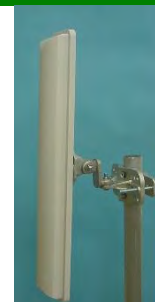

## Specifications

### Electrical

Frequency range	4.9-6.1 GHz
GAIN, typ.	17 dBi
VSWR, max.	1.7 : 1
Polarization	Linear, Horizontal
3 dB Beam-Width, H-Plane, typ.	90°
3 dB Beam-Width, E-Plane, typ.	5°
Side Lobes, min.	ETSI EN 302 085 V1.2.3 – CS2
Cross Polarization, min.	ETSI EN 302 085 V1.2.3 – CS1
Front to Back Ratio, min.	ETSI EN 302 085 V1.2.3 – CS2
Input power, max.	20 Watt
Input Impedance	50 Ohm
Lightning Protection	DC Grounded

### Mechanical

Dimensions (HxWxD)	573 x 95 x 53 mm (22.6" x 3.7" x 2.1")
Weight	600 gr.
Connector	N-Type, Female
Back Plane	Aluminum protected through chemical passivation
Radome	UV Protected, Polycarbonate
Mount	See ordering options

### Environmental

Operating Temperature Range	-40°C to +65°C
Vibration	According to IEC 60721-3-4
Wind Load	200 km/h (survival)
Flammability	UL94
Water Proofing	IP-67
Humidity	ETS 300 019-1-4, EN 302 085 (annex A.1.1)
Salt Fog	According to IEC 68-2-11
Ice and Snow	25mm radial (survival)

### Standard Compliance

ETSI EN 302 085 V1.2.3 – CS1 / CS2

## Ordering Options

MA-WD55-17H	Antenna Suited for MNT-22 (optional wall/pole adjustable mount)
MA-WD55-17HB	Antenna with MNT-22 mount

Patterns are available on our website

MARS Antennas & RF Systems proprietary information

MARS reserves the right to make technical changes or modifications to any of its products and specifications without prior notice and without implementing such changes to prior supplied products. Product images are representative and indicative only. Warranty terms and general conditions of sale are applicable on any purchase of any product, available on MARS website.

3 Hamanor st. Holon 5886103, P.O.Box 1852 Holon 5811801, Israel

Tel: +972-3-5599661 • Fax: +972-3-5599677 • e-mail: mars@marsant.co.il • web: www.mars-antennas.com

## MA-WC62-17

### 6 GHz Base Station Antenna, 60°

MARS 60° Broadband Sector Antenna provides a cost effective solution for large scale WLL, WLAN, H-LAN, ISM, UNII, Public Safety, Municipal MESH Networks and Point-to-Multi-Point applications.

Additional Features:

- Stable performance with 17 dBi of gain.
- Small size allowing easy blending with any environment.
- Tilt mount allowing quick and easy installation.
- UV protected radome suitable for harsh environment installations.



### Specifications

#### Electrical

Frequency range	5.7-6.5 GHz
GAIN, typ.	17 dBi
VSWR, max.	1.7 : 1
Polarization	Linear, Vertical
3 dB Beam-Width, H-Plane, typ.	60°
3 dB Beam-Width, E-Plane, typ.	8°
Side Lobes, min.	ETSI EN 302 085 V1.2.3 – CS1
Cross Polarization, min.	ETSI EN 302 085 V1.2.3 – CS1
Front to Back Ratio, min.	ETSI EN 302 085 V1.2.3 – CS1
Input power, max.	50 Watt
Input Impedance	50 Ohm
Lightning Protection	DC Grounded

#### Mechanical

Dimensions (HxWxD)	573 x 95 x 53 mm (22.6" x 3.7" x 2.1")
Weight	700 gr.
Connector	N-Type, Female
Back Plane	Aluminum protected through chemical passivation
Radome	UV Protected, Polycarbonate
Mount	See ordering options

#### Environmental

Operating Temperature Range	-40°C to +65°C
Vibration	According to IEC 60721-3-4
Wind Load	200 km/h (survival)
Flammability	UL94
Water Proofing	IP-67
Humidity	ETS 300 019-1-4, EN 302 085 (annex A.1.1)
Salt Fog	According to IEC 68-2-11
Ice and Snow	25mm radial (survival)

#### Standard Compliance

ETSI EN 302 085 V1.2.3 – CS1

### Ordering Options

MA-WC62-17	Antenna Suited for MNT-22 (optional wall/pole adjustable mount)
MA-WC62-17B	Antenna with MNT-22 mount

Patterns are available on our website

MARS Antennas & RF Systems proprietary information

MARS reserves the right to make technical changes or modifications to any of its products and specifications without prior notice and without implementing such changes to prior supplied products. Product images are representative and indicative only. Warranty terms and general conditions of sale are applicable on any purchase of any product, available on MARS website.

3 Hamanor st. Holon 5886103, P.O.Box 1852 Holon 5811801, Israel

Tel: +972-3-5599661 • Fax: +972-3-5599677 • e-mail: mars@marsant.co.il • web: www.mars-antennas.com

**MA-WD62-16**

**5.7-6.5 GHz Base Station Antenna, 90°**

MARS 90° Broadband Sector Antenna provides a cost effective solution for large scale WLL, WLAN, H-LAN, ISM, UNII, Public Safety, Municipal MESH Networks and Point-to-Multi-Point applications.

Additional Features:

- Stable performance with 16 dBi of gain.
- Small size allowing easy blending with any environment.
- Tilt mount allowing quick and easy installation.
- UV protected radome suitable for harsh environment installations.



**Specifications**

**Electrical**

Frequency range	5.7-6.5 GHz
GAIN, typ.	16 dBi
VSWR, max.	1.7 : 1
Polarization	Linear, Vertical
3 dB Beam-Width, H-Plane, typ.	90°
3 dB Beam-Width, E-Plane, typ.	8°
Side Lobes, min.	ETSI EN 302 085 V1.2.3 – CS1
Cross Polarization, min.	ETSI EN 302 085 V1.2.3 – CS1
Front to Back Ratio, min.	ETSI EN 302 085 V1.2.3 – CS1
Input power, max.	50 Watt
Input Impedance	50 Ohm
Lightning Protection	DC Grounded

**Mechanical**

Dimensions (HxWxD)	573 x 95 x 53 mm (22.6" x 3.7" x 2.1")
Weight	700 gr.
Connector	N-Type, Female
Back Plane	Aluminum protected through chemical passivation
Radome	UV Protected, Polycarbonate
Mount	See ordering options

**Environmental**

Operating Temperature Range	-40°C to +65°C
Vibration	According to IEC 60721-3-4
Wind Load	200 km/h (survival)
Flammability	UL94
Water Proofing	IP-67
Humidity	ETS 300 019-1-4, EN 302 085 (annex A.1.1)
Salt Fog	According to IEC 68-2-11
Ice and Snow	25mm radial (survival)

**Standard Compliance**

ETSI EN 302 085 V1.2.3 – CS1
------------------------------

**Ordering Options**

MA-WD62-16	Antenna Suited for MNT-22 (optional wall/pole adjustable mount)
MA-WD62-16B	Antenna with MNT-22 mount

Patterns are available on our website

MARS Antennas & RF Systems proprietary information

MARS reserves the right to make technical changes or modifications to any of its products and specifications without prior notice and without implementing such changes to prior supplied products. Product images are representative and indicative only. Warranty terms and general conditions of sale are applicable on any purchase of any product, available on MARS website.

3 Hamanor st. Holon 5886103, P.O.Box 1852 Holon 5811801, Israel

Tel: +972-3-5599661 • Fax: +972-3-5599677 • e-mail: mars@marsant.co.il • web: www.mars-antennas.com

## MA-WE62-15

### 5.7-6.5 GHz Base Station Antenna, 120°

MARS 120° Broadband Sector Antenna provides a cost effective solution for large scale WLL, WLAN, H-LAN, ISM, UNII, Public Safety, Municipal MESH Networks and Point-to-Multi-Point applications.

Additional Features:

- Stable performance with 15 dBi of gain.
- Small size allowing easy blending with any environment.
- Tilt mount allowing quick and easy installation.
- UV protected radome suitable for harsh environment installations.

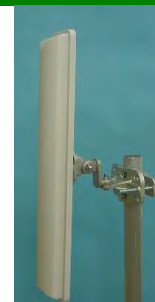

## Specifications

### Electrical

Frequency range	5.7-6.5 GHz
GAIN, typ.	15 dBi
VSWR, max.	1.7 : 1
Polarization	Linear, Vertical
3 dB Beam-Width, H-Plane, typ.	120°
3 dB Beam-Width, E-Plane, typ.	8°
Side Lobes, min.	ETSI EN 302 085 V1.2.3 – CS1
Cross Polarization, min.	ETSI EN 302 085 V1.2.3 – CS1
Front to Back Ratio, min.	ETSI EN 302 085 V1.2.3 – CS1
Input power, max.	50 Watt
Input Impedance	50 Ohm
Lightning Protection	DC Grounded

### Mechanical

Dimensions (HxWxD)	573 x 95 x 53 mm (22.6" x 3.7" x 2.1")
Weight	700 gr.
Connector	N-Type, Female
Back Plane	Aluminum protected through chemical passivation
Radome	UV Protected, Polycarbonate
Mount	See ordering options

### Environmental

Operating Temperature Range	-40°C to +65°C
Vibration	According to IEC 60721-3-4
Wind Load	200 km/h (survival)
Flammability	UL94
Water Proofing	IP-67
Humidity	ETS 300 019-1-4, EN 302 085 (annex A.1.1)
Salt Fog	According to IEC 68-2-11
Ice and Snow	25mm radial (survival)

### Standard Compliance

ETSI EN 302 085 V1.2.3 – CS1

## Ordering Options

MA-WE62-15	Antenna Suited for MNT-22 (optional wall/pole adjustable mount)
MA-WE62-15B	Antenna with MNT-22 mount

Patterns are available on our website

MARS Antennas & RF Systems proprietary information

MARS reserves the right to make technical changes or modifications to any of its products and specifications without prior notice and without implementing such changes to prior supplied products. Product images are representative and indicative only. Warranty terms and general conditions of sale are applicable on any purchase of any product, available on MARS website.

3 Hamanor st. Holon 5886103, P.O.Box 1852 Holon 5811801, Israel

Tel: +972-3-5599661 • Fax: +972-3-5599677 • e-mail: mars@marsant.co.il • web: www.mars-antennas.com

## MA-WC55-DS17

### 4.9-6.1 GHz Dual Slant Base Station Antenna, 60°

MARS Dual Slant  $\pm 45$  degrees 60° sector antenna features:

- Efficient and stable performance with 17 dBi of gain.
- Full 4.9-6.1 GHz band coverage.
- High Isolation ratio.
- Compact size.
- Optional Azimuth & Elevation Adjustable mount.
- UV protected radome suitable for harsh environment installations.
- Square shape.



## Specifications

### Electrical

Frequency range	4.9-6.1 GHz
GAIN, typ.	17 dBi
VSWR, max.	1.7 : 1
Polarization	Dual Slant $\pm 45^\circ$
3 dB Beam-Width, H-Plane, typ.	60°
3 dB Beam-Width, E-Plane, typ.	8°
Port to Port Isolation	-30 dB
Front to Back Ratio, min.	-35 dB
Input power, max.	10 Watt
Input Impedance	50 Ohm
Lightning Protection	DC Grounded

### Mechanical

Dimensions (HxWxD)	370 x 370 x 40 mm (14.5" x 14.5" x 1.6")
Weight	2 kg.
Connector	2x N-Type, Female
Back Plane	Aluminum; protected through chemical passivation
Radome	UV Protected Polycarbonate
Mount	See ordering options

### Environmental

Operating Temperature Range	-40°C to +65°C
Vibration	According to IEC 60721-3-4
Wind Load	200 km/h (survival)
Flammability	UL94
Water Proofing	IP-67
Humidity	ETS 300 019-1-4, EN 302 085 (annex A.1.1)
Salt Fog	According to IEC 68-2-11
Ice and Snow	25mm radial (survival)

## Ordering Options

MA-WC55-DS17	Antenna Suited for MNT-22 (optional wall/pole adjustable mount)
MA-WC55-DS17B	Antenna with MNT-22 mount

Patterns are available on our website

MARS Antennas & RF Systems proprietary information

MARS reserves the right to make technical changes or modifications to any of its products and specifications without prior notice and without implementing such changes to prior supplied products. Product images are representative and indicative only. Warranty terms and general conditions of sale are applicable on any purchase of any product, available on MARS website.

3 Hamanor st. Holon 5886103, P.O.Box 1852 Holon 5811801, Israel

Tel: +972-3-5599661 • Fax: +972-3-5599677 • e-mail: mars@marsant.co.il • web: www.mars-antennas.com

## MA-WD55-DS16

### 4.9-6.1 GHz Dual Slant Base Station Antenna, 90°

MARS Dual Slant  $\pm 45$  degrees 90° sector antenna features:

- Efficient and stable performance with 16 dBi of gain.
- Full 4.9-6.1 GHz band coverage.
- High Isolation ratio.
- Compact size.
- Optional Azimuth & Elevation Adjustable mount.
- UV protected radome suitable for harsh environment installations.
- Square shape.



## Specifications

### Electrical

Frequency range	4.9-6.1 GHz
GAIN, typ.	16 dBi
VSWR, max.	1.7 : 1
Polarization	Dual Slant $\pm 45^\circ$
3 dB Beam-Width, Azimuth, typ.	90°
3 dB Beam-Width, Elevation, typ.	8°
Front to Back Ratio.	-30 dB
Port to Port Isolation	-30 dB
Input power, max.	10 Watt
Input Impedance	50 Ohm
Lightning Protection	DC Grounded

### Mechanical

Dimensions (HxWxD)	370 x 370 x 40 mm (14.5" x 14.5" x 1.6")
Weight	1.8 kg.
Connector	2 x N-Type, Female
Back Plane	Aluminum protected through chemical passivation
Radome	UV Protected Polycarbonate
Mount	See ordering options

### Environmental

Operating Temperature Range	-40°C to +65°C
Vibration	According to IEC 60721-3-4
Wind Load	200 km/h (survival)
Flammability	UL94
Water Proofing	IP-67
Humidity	ETS 300 019-1-4, EN 302 085 (annex A.1.1)
Salt Fog	According to IEC 68-2-11
Ice and Snow	25mm radial (survival)

## Ordering Options

MA-WD55-DS16	Antenna Suited for MNT-22 (optional wall/pole adjustable mount)
MA-WD55-DS16B	Antenna with MNT-22 mount

Patterns are available on our website

MARS Antennas & RF Systems proprietary information

MARS reserves the right to make technical changes or modifications to any of its products and specifications without prior notice and without implementing such changes to prior supplied products. Product images are representative and indicative only. Warranty terms and general conditions of sale are applicable on any purchase of any product, available on MARS website.

3 Hamanor st. Holon 5886103, P.O.Box 1852 Holon 5811801, Israel

Tel: +972-3-5599661 • Fax: +972-3-5599677 • e-mail: mars@marsant.co.il • web: www.mars-antennas.com



## MA-WC56-DP17

### 9.4-1.6 GHz Dual Polarized Base Station Antenna, 60°

MARS 60° Broadband Dual Polarized Sector Antenna provides a cost effective solution for large scale WLL, WLAN, H-LAN, ISM, UNII, Public Safety, Municipal MESH Networks and Point-to-Multi-Point applications.

Additional Features:

- Stable performance with 17/18 dBi of gain.
- Compact size allowing easy blending with any environment.
- Tilt mount allowing quick and easy installation.
- UV protected radome suitable for harsh environment installations.



### Specifications

#### Electrical

Frequency range		4.9-6.1 GHz
GAIN, typ.	V-pol:	18 dBi
	H-pol:	17 dBi
VSWR, max.		1.7 : 1
Polarization		Dual, Vertical & Horizontal
3 dB Beam-Width, H-Plane, typ.		60°
3 dB Beam-Width, E-Plane, typ.		8°
Side Lobes, min.	H-pol:	ETSI EN 302 085 V1.2.3 – CS2
	V-pol:	ETSI EN 302 085 V1.2.3 – CS3
Cross Polarization, min.		-16 dB
Front to Back Ratio, min.		-30 dB
Port to Port Isolation, typ.		-40 dB
Input power, max.		10 Watt
Input Impedance		50 Ohm
Lightning Protection		DC Grounded

#### Mechanical

Dimensions (HxWxD)		370 x 370 x 40 mm (14.5" x 14.5" x 1.6")
Weight		1.8 kg.
Connector (without enclosure)		2 x N-Type, Female
Connector (with enclosure)		2 x SMA
Back Plane		Aluminum protected through chemical passivation
Radome		UV Protected Polycarbonate
Enclosure - Large		287 x 287 x 68 mm. (External dimension)
Mount		See ordering options

#### Environmental

Operating Temperature Range		-55°C to +65°C
Vibration		According to IEC 60721-3-4
Wind Load		200 km/h (survival)
Flammability		UL94
Water Proofing		IP-67
Humidity		ETS 300 019-1-4, EN 302 085 (annex A.1.1)
Salt Fog		According to IEC 68-2-11
Ice and Snow		25mm radial (survival)

### Ordering Options

MA-WC56-DP17	Antenna Suited for MNT-22 (optional wall/pole adjustable mount)
MA-WC56-DP17B	Antenna with MNT-22 mount
MA-WC56-DP17SMEL	Antenna with large enclosure, 2 x SMA Connectors and MNT-22
MA-WC56-DP17SMELZ	Antenna with large enclosure, 2 x SMA Connectors with PEMs and MNT-22

Patterns are available on our website

MARS Antennas & RF Systems proprietary information

MARS reserves the right to make technical changes or modifications to any of its products and specifications without prior notice and without implementing such changes to prior supplied products. Product images are representative and indicative only. Warranty terms and general conditions of sale are applicable on any purchase of any product, available on MARS website.

3 Hamanor st. Holon 5886103, P.O.Box 1852 Holon 5811801, Israel

Tel: +972-3-5599661 • Fax: +972-3-5599677 • e-mail: mars@marsant.co.il • web: www.mars-antennas.com

## MA-WD56-DP16

### 4.9-6.1 GHz Dual Polarized Base Station Antenna, 90°

MARS 90° Broadband Dual Polarized Sector Antenna provides a cost effective solution for large scale WLL, WLAN, H-LAN, ISM, UNII, Public Safety, Municipal MESH Networks and Point-to-Multi-Point applications.

Additional Features:

- Stable performance with 16 dBi of gain.
- Compact size allowing easy blending with any environment.
- Tilt mount allowing quick and easy installation.
- UV protected radome suitable for harsh environment installations.



## Specifications

### Electrical

Frequency range	4.9-6.1 GHz
GAIN, typ.	16 dBi
VSWR, max.	1.7 : 1
Polarization	Dual Vertical & Horizontal
3 dB Beam-Width, H-Plane, typ.	90°
3 dB Beam-Width, E-Plane, typ.	8°
Side Lobes, min.	V-Pol. ETSI EN 302 085 V1.2.3 – CS2 H-Pol. ETSI EN 302 085 V1.2.3 – CS3
Cross Polarization, min.	-15 dB
Front to Back Ratio, min.	-30 dB
Port to Port Isolation, typ.	-30 dB
Input power, max.	10 Watt
Input Impedance	50 Ohm
Lightning Protection	DC Grounded

### Mechanical

Dimensions (HxWxD)	370 x 370 x 40 mm (14.5" x 14.5" x 1.6")
Weight	2 kg.
Connector (without enclosure)	2 x N-Type, Female
Connector (with enclosure)	2 x SMA
Back Plane	Aluminum protected through chemical passivation
Radome	UV Protected Polycarbonate
Enclosure - Large	287 x 287 x 68 mm. (External dimension)
Mount	See ordering options

### Environmental

Operating Temperature Range	-55°C to +65°C
Vibration	According to IEC 60721-3-4
Wind Load	200 km/h (survival)
Flammability	UL94
Water Proofing	IP-67
Humidity	ETS 300 019-1-4, EN 302 085 (annex A.1.1)
Salt Fog	According to IEC 68-2-11
Ice and Snow	25mm radial (survival)

## Ordering Options

MA-WD56-DP16	Antenna Suited for MNT-22 (optional wall/pole adjustable mount)
MA-WD56-DP16B	Antenna with MNT-22 mount
MA-WD56-DP16SMEL	Antenna with large enclosure, 2xSMA Connectors and MNT-22
MA-WD56-DP16SMELZ	Antenna with large enclosure, 2xSMA Connectors with PEMs and MNT-22

Patterns are available on our website

MARS Antennas & RF Systems proprietary information

MARS reserves the right to make technical changes or modifications to any of its products and specifications without prior notice and without implementing such changes to prior supplied products. Product images are representative and indicative only. Warranty terms and general conditions of sale are applicable on any purchase of any product, available on MARS website.

3 Hamanor st. Holon 5886103, P.O.Box 1852 Holon 5811801, Israel

Tel: +972-3-5599661 • Fax: +972-3-5599677 • e-mail: mars@marsant.co.il • web: www.mars-antennas.com

## MA-WD56-DP13

### 5.15-5.875 GHz Dual Polarized Base Station Antenna, 90°

MARS 90° Broadband Dual Polarized Sector Antenna.

Additional Features:

- Stable performance with 13 dBi of gain.
- Compact size allowing easy blending with any environment.
- Tilt mount allowing quick and easy installation.
- UV protected radome suitable for harsh environment installations.



### Specifications

#### Electrical

Frequency range	5.15-5.875 GHz
GAIN, typ.	13 dBi
VSWR, max.	1.7 : 1
Polarization	Dual, Vertical & Horizontal
3 dB Beam-Width, H-Plane, typ.	90°
3 dB Beam-Width, E-Plane, typ.	15°
Cross Polarization, typ.	-15 dB
Front to Back Ratio, min.	-30 dB
Port to Port Isolation, typ.	-20 dB
Input power, max.	10 Watt
Input Impedance	50 Ohm
Lightning Protection	DC Grounded

#### Mechanical

Dimensions (HxWxD)	200 x 200 x 33 mm (7.9" x 7.9" x 1.25")
Weight	400 gr.
Connector	2 x N-Type, Female
Back Plane	Aluminum protected through chemical passivation
Radome	UV Protected Polycarbonate
Mount	See Ordering options

#### Environmental

Operating Temperature Range	-55°C to +65°C
Vibration	According to IEC 60721-3-4
Wind Load	200 km/h (survival)
Flammability	UL94
Water Proofing	IP-67
Humidity	ETS 300 019-1-4, EN 302 085 (annex A.1.1)
Salt Fog	According to IEC 68-2-11
Ice and Snow	25mm radial (survival)

### Ordering Options

MA-WD56-DP13	Antenna Suited for MNT-23 (optional wall/pole adjustable mount)
MA-WD56-DP13B	Antenna with MNT-23 mount

Patterns are available on our website

Mars Antennas & RF Systems proprietary information

MARS reserves the right to make technical changes or modifications to any of its products and specifications without prior notice and without implementing such changes to prior supplied products. Product images are representative and indicative only. Warranty terms and general conditions of sale are applicable on any purchase of any product, available on MARS website.

3 Hamanor st. Holon 58861, P.O.Box 5 AZOR 58008, Israel

Tel: +972-3-5599661 • Fax: +972-3-5599677 • e-mail: mars@marsant.co.il • web: www.mars-antennas.com

## MA-WE56-DP12

### 5.15-5.875 GHz Dual Polarized Base Station Antenna, 120°

MARS 120° Broadband Dual Polarized Sector Antenna.

Additional Features:

- Stable performance with 12 dBi of gain.
- Compact size allowing easy blending with any environment.
- Tilt mount allowing quick and easy installation.
- UV protected radome suitable for harsh environment installations.



## Specifications

### Electrical

Frequency range	5.15-5.875 GHz
GAIN, typ.	12 dBi
VSWR, max.	1.7 : 1
Polarization	Dual, Vertical & Horizontal
3 dB Beam-Width, H-Plane, typ.	120°
3 dB Beam-Width, E-Plane, typ.	15°
Cross Polarization, typ.	-15 dB
Front to Back Ratio, min.	-30 dB
Port to Port Isolation, typ.	-20 dB
Input power, max.	10 Watt
Input Impedance	50 Ohm
Lightning Protection	DC Grounded

### Mechanical

Dimensions (HxWxD)	200 x 200 x 33 mm (7.9" x 7.9" x 1.25")
Weight	400 gr.
Connector	2 x N-Type, Female
Back Plane	Aluminum protected through chemical passivation
Radome	UV Protected Polycarbonate
Mount	See ordering options

### Environmental

Operating Temperature Range	-55°C to +65°C
Vibration	According to IEC 60721-3-4
Wind Load	200 km/h (survival)
Flammability	UL94
Water Proofing	IP-67
Humidity	ETS 300 019-1-4, EN 302 085 (annex A.1.1)
Salt Fog	According to IEC 68-2-11
Ice and Snow	25mm radial (survival)

## Ordering Options

MA-WE56-DP12	Antenna Suited for MNT-23 (optional wall/pole adjustable mount)
MA-WE56-DP12B	Antenna with MNT-23 mount

Patterns are available on our website

MARS Antennas & RF Systems proprietary information

MARS reserves the right to make technical changes or modifications to any of its products and specifications without prior notice and without implementing such changes to prior supplied products. Product images are representative and indicative only. Warranty terms and general conditions of sale are applicable on any purchase of any product, available on MARS website.

3 Hamanor st. Holon 5886103, P.O.Box 1852 Holon 5811801, Israel

Tel: +972-3-5599661 • Fax: +972-3-5599677 • e-mail: mars@marsant.co.il • web: www.mars-antennas.com

## MA-WE56-DP15

### 5.15-5.875 GHz Dual Polarized Base Station Antenna, 120°

MARS **120° Broadband Dual Polarized Base station** Antenna.

Additional Features:

- Stable performance with 15 dBi of gain.
  - Compact size allowing easy blending with any environment.
  - Tilt mount allowing quick and easy installation.
- UV protected radome suitable for harsh environment installations.



## Specifications

### Electrical

Frequency range	5.15-5.875 GHz
GAIN, typ.	14.5 dBi
VSWR, max.	1.7 : 1
Polarization	Dual, Vertical & Horizontal
3 dB Beam-Width, H-Plane, typ.	120°
3 dB Beam-Width, E-Plane, typ.	8°
Cross Polarization, typ.	-15 dB
Front to Back Ratio, min.	-30 dB
Port to Port Isolation, typ.	-25 dB
Input power, max.	10 Watt
Input Impedance	50 Ohm
Lightning Protection	DC Grounded

### Mechanical

Dimensions (HxWxD)	370 x 370 x 40 mm (14.5" x 14.5" x 1.6")
Weight	2 kg.
Connector (without enclosure)	2 x N-Type, Female
Connector (with enclosure)	2 x SMA
Back Plane	Aluminum protected through chemical passivation
Radome	UV Protected Polycarbonate
Enclosure - Large	287 x 287 x 68 mm. (External dimension)
Mount	See ordering options

### Environmental

Operating Temperature Range	-55°C to +65°C
Vibration	According to IEC 60721-3-4
Wind Load	200 km/h (survival)
Flammability	UL94
Water Proofing	IP-67
Humidity	ETS 300 019-1-4, EN 302 085 (annex A.1.1)
Salt Fog	According to IEC 68-2-11
Ice and Snow	25mm radial (survival)

## Ordering Options

MA-WE56-DP15	Antenna Suited for MNT-22 (optional wall/pole adjustable mount)
MA-WE56-DP15B	Antenna with MNT-22 mount
MA-WE56-DP15SMELZ	Antenna with large enclosure, 2 x SMA Connectors with PEMs and MNT-22

MARS Antennas & RF Systems proprietary information

MARS reserves the right to make technical changes or modifications to any of its products and specifications without prior notice and without implementing such changes to prior supplied products. Product images are representative and indicative only. Warranty terms and general conditions of sale are applicable on any purchase of any product, available on MARS website.

3 Hamanor st. Holon 5886103, P.O.Box 1852 Holon 5811801, Israel

Tel: +972-3-5599661 • Fax: +972-3-5599677 • e-mail: mars@marsant.co.il • web: www.mars-antennas.com

## MA-WC62-DP17

### 5.7-6.425 GHz Dual Polarized Base Station Antenna, 60°

MARS 60° Broadband Dual Polarized Sector Antenna provides a cost effective solution for large scale WLL, WLAN, H-LAN, ISM, UNII, Public Safety, Municipal MESH Networks and Point-to-Multi-Point applications.

Additional Features:

- Stable performance with 17 dBi of gain.
- Compact size allowing easy blending with any environment.
- Tilt mount allowing quick and easy installation.
- UV protected radome suitable for harsh environment installations.



## Specifications

### Electrical

Frequency range	5.7-6.425 GHz
GAIN, typ.	17 dBi
VSWR, max.	1.7 : 1
Polarization	Dual Vertical & Horizontal
3 dB Beam-Width, H-Plane, typ.	60°
3 dB Beam-Width, E-Plane, typ.	8.5°
Side Lobes, min. (azimuth)	-25 dB
Cross Polarization, min.	-18 dB
Front to Back Ratio, min.	-40 dB
Port to Port Isolation, typ.	-45 dB
Input power, max.	10 Watt
Input Impedance	50 Ohm
Lightning Protection	DC Grounded

### Mechanical

Dimensions (HxWxD)	370 x 370 x 40 mm (14.5" x 14.5" x 1.6")
Weight	2 kg.
Connector	2 x N-Type, Female
Back Plane	Aluminum protected through chemical passivation
Radome	UV Protected Polycarbonate
Mount	See ordering information

### Environmental

Operating Temperature Range	-55°C to +65°C
Vibration	According to IEC 60721-3-4
Wind Load	200 km/h (survival)
Flammability	UL94
Water Proofing	IP-67
Humidity	ETS 300 019-1-4, EN 302 085 (annex A.1.1)
Salt Fog	According to IEC 68-2-11
Ice and Snow	25mm radial (survival)

## Ordering Options

MA-WC62-DP17	Antenna Suited for MNT-22 (optional wall/pole adjustable mount)
MA-WC62-DP17B	Antenna with MNT-22 mount

Patterns are available on our website

MARS Antennas & RF Systems proprietary information

MARS reserves the right to make technical changes or modifications to any of its products and specifications without prior notice and without implementing such changes to prior supplied products. Product images are representative and indicative only. Warranty terms and general conditions of sale are applicable on any purchase of any product, available on MARS website.

3 Hamanor st. Holon 5886103, P.O.Box 1852 Holon 5811801, Israel

Tel: +972-3-5599661 • Fax: +972-3-5599677 • e-mail: mars@marsant.co.il • web: www.mars-antennas.com

## MA-WD62-DP16

### 5.7-6.425 GHz Dual Polarized Base Station Antenna, 90°

MARS 90° Broadband Dual Polarized Sector Antenna provides a cost effective solution for large scale WLL, WLAN, H-LAN, ISM, UNII, Public Safety, Municipal MESH Networks and Point-to-Multi-Point applications.

Additional Features:

- Stable performance with 16 dBi of gain.
- Compact size allowing easy blending with any environment.
- Tilt mount allowing quick and easy installation.
- UV protected radome suitable for harsh environment installations.



## Specifications

### Electrical

Frequency range	5.7-6.425 GHz
GAIN, typ.	16 dBi
VSWR, max.	1.7 : 1
Polarization	Dual Vertical & Horizontal
3 dB Beam-Width, H-Plane, typ.	90°
3 dB Beam-Width, E-Plane, typ.	8.5°
Side Lobes, min. (azimuth)	-25 dB
Cross Polarization, min.	-18 dB
Front to Back Ratio, min.	-40 dB
Port to Port Isolation, typ.	-45 dB
Input power, max.	10 Watt
Input Impedance	50 Ohm
Lightning Protection	DC Grounded

### Mechanical

Dimensions (HxWxD)	370 x 370 x 40 mm (14.5" x 14.5" x 1.6")
Weight	2 kg.
Connector	2 x N-Type, Female
Back Plane	Aluminum protected through chemical passivation
Radome	UV Protected Polycarbonate
Mount	See ordering options

### Environmental

Operating Temperature Range	-55°C to +65°C
Vibration	According to IEC 60721-3-4
Wind Load	200 km/h (survival)
Flammability	UL94
Water Proofing	IP-67
Humidity	ETS 300 019-1-4, EN 302 085 (annex A.1.1)
Salt Fog	According to IEC 68-2-11
Ice and Snow	25mm radial (survival)

## Ordering Options

MA-WD62-DP16	Antenna Suited for MNT-22 (optional wall/pole adjustable mount)
MA-WD62-DP16B	Antenna with MNT-22 mount

Patterns are available on our website

MARS Antennas & RF Systems proprietary information

MARS reserves the right to make technical changes or modifications to any of its products and specifications without prior notice and without implementing such changes to prior supplied products. Product images are representative and indicative only. Warranty terms and general conditions of sale are applicable on any purchase of any product, available on MARS website.

3 Hamanor st. Holon 5886103, P.O.Box 1852 Holon 5811801, Israel

Tel: +972-3-5599661 • Fax: +972-3-5599677 • e-mail: mars@marsant.co.il • web: www.mars-antennas.com

## MA-WD62-DS16

### 5.7-6.425 GHz Dual Slant Base Station Antenna, 90°

MARS Dual Slant ±45 degrees 90° sector antenna features:

- Efficient and stable performance with 15.5 dBi of gain.
- Full 5.7-6.425 GHz band coverage.
- High Isolation ratio.
- Compact size.
- Optional Azimuth & Elevation Adjustable mount.
- UV protected radome suitable for harsh environment installations.
- Square shape.



## Specifications

### Electrical

Frequency range	5.7-6.425 GHz
GAIN, typ.	15.5 dBi
VSWR, max.	1.7 : 1
Polarization	Dual Slant ±45°
3 dB Beam-Width, Azimuth, typ.	90°
3 dB Beam-Width, Elevation, typ.	8.5°
Side Lobe level ( Elevation),min.	-12 dB
Front to Back Ratio.	-35 dB
Cross Polarization, min.	-15 dB
Port to Port Isolation	-40 dB
Input power, max.	10 Watt
Input Impedance	50 Ohm
Lightning Protection	DC Grounded

### Mechanical

Dimensions (HxWxD)	370 x 370 x 40 mm (14.5" x 14.5" x 1.6")
Weight	1.8 kg.
Connector	2 x N-Type, Female
Back Plane	Aluminum protected through chemical passivation
Radome	UV Protected Polycarbonate
Mount	See ordering options

### Environmental

Operating Temperature Range	-40°C to +65°C
Vibration	According to IEC 60721-3-4
Wind Load	200 km/h (survival)
Flammability	UL94
Water Proofing	IP-67
Humidity	ETS 300 019-1-4, EN 302 085 (annex A.1.1)
Salt Fog	According to IEC 68-2-11
Ice and Snow	25mm radial (survival)

## Ordering Options

MA-WD62-DS16	Antenna Suited for MNT-22 (optional wall/pole adjustable mount)
MA-WD62-DS16B	Antenna with MNT-22 mount

Patterns are available on our website

MARS Antennas & RF Systems proprietary information

MARS reserves the right to make technical changes or modifications to any of its products and specifications without prior notice and without implementing such changes to prior supplied products. Product images are representative and indicative only. Warranty terms and general conditions of sale are applicable on any purchase of any product, available on MARS website.

3 Hamanor st. Holon 5886103, P.O.Box 1852 Holon 5811801, Israel

Tel: +972-3-5599661 • Fax: +972-3-5599677 • e-mail: mars@marsant.co.il • web: www.mars-antennas.com



## MA-WC54-2DS17

### 4.9-6.1 GHz Double Dual Slant Base Station Antenna, 65°

MARS wideband 65° sector antenna provides coverage for 4.9-6.1 GHz band with double dual slant ( $\pm 45^\circ$ ) in a single antenna radome with high aperture efficiency. For optimal nulling the antenna internal columns are separated horizontally with 70mm space and the elements spacing is 43mm.



#### Additional Features:

- Wide coverage
- Total 4 outputs
- Pole or wall mounting
- A possibility of mounting Access Point upon antenna

### Specifications

#### Electrical

Frequency range	4.9-6.1 GHz
GAIN,	4 x 17 $\pm$ 0.5dBi
VSWR, max.	1.7 : 1 (1.5:1 - typ)
Polarization	Dual Slant
3dB Beam-Width, H-Plane, typ.	Double Linear $\pm 45^\circ$
3dB Beam-Width, E-Plane, typ.	65°
Side Lobes, typ.	8°
Cross Polarization, typ.	-12 dB
Port to Port Isolation, typ.	-15 dB
Front to Back Ratio, min.	-30 dB (-25 dB - min)
Input power, max.	-35 dB
Input Impedance	10 Watt
Lightning Protection	50 Ohm
	DC Grounded

#### Mechanical

Dimensions (HxWxD)	370 x 370 x 40 mm (14.5" x 14.5" x 1.6")
Weight	2 Kg.
Connector	4 x N-Type, Female
Back Plane	Aluminum protected through chemical passivation
Radome	UV Protected, Polycarbonate
Mount	See Ordering Options

#### Environmental

Operating Temperature Range	-40°C to +65°C
Vibration	According to IEC 60721-3-4
Wind Load	200 km/h (Survival)
Flammability	UL94
Water Proofing	IP-67
Humidity	ETS 300 019-1-4, EN 302 085 (Annex A.1.1)
Salt Fog	According to IEC 68-2-11

### Specifications

MA-WC54-2DS17	Antenna Suited for MNT-22 (optional wall/pole adjustable mount)
MA-WC54-2DS17B	Antenna with MNT-22 mount

MARS Antennas & RF Systems proprietary information

MARS reserves the right to make technical changes or modifications to any of its products and specifications without prior notice and without implementing such changes to prior supplied products. Product images are representative and indicative only. Warranty terms and general conditions of sale are applicable on any purchase of any product, available on MARS website.

3 Hamanor st. Holon 5886103, P.O.Box 1852 Holon 5811801, Israel

Tel: +972-3-5599661 • Fax: +972-3-5599677 • e-mail: mars@marsant.co.il • web: www.mars-antennas.com

## MA-WD56-DSV16

### 4.9-6.1 GHz Triple Polarizations MIMO Base Station Antenna, 90°

MARS Triple Polarization Sector antenna provides coverage of 4.9-6.1 GHz frequency band in a single antenna radome.

Additional Features:

- 3 Ports: Dual Slant ( $\pm 45^\circ$ ) and Vertical Polarization.
- Specially designed for MIMO applications for optimal decorrelation.
- Light weight and durable construction.
- UV protected radome made of polycarbonate.
- Can be customized with customer defined back plane and different connector configurations.



### Specifications

#### Electrical

Frequency range	4.9-6.1 GHz
GAIN:	Vertical Pol. 16 dBi
	Dual Slant Pol. 16 dBi
VSWR, max.	1.7 : 1
Polarization	Dual Slant: $\pm 45^\circ$ and Vertical
3 dB Beam-Width-Azimuth, typ.	Dual Slant: $90^\circ$ ; V- Pol $90^\circ$
3 dB Beam-Width-Elevation, typ.	Dual Slant: $8^\circ$ ; V- Pol $8^\circ$
Front to Back Ratio, min.	-30 dB
Port to Port Isolation, min.	-30 dB
Input power, max	10 Watt
Input Impedance	50 Ohm
Lightning Protection	DC Grounded

#### Mechanical

Dimensions (HxWxD)	370 x 370 x 40 mm (14.5" x 14.5" x 1.6")
Connector	3 x N-Type Female
Weight	2.1 Kg.
Mounting	See ordering options
Radome	UV Protected Polycarbonate
Back Plane	Aluminum protected through chemical passivation

#### Environmental

Operating Temperature Range	-40°C to +65°C
Vibration	According to IEC 60721-3-4
Wind Load	200 Km/h (Survival)
Flammability	UL94
Water Proofing	IP-67
Humidity	ETS 300 019-1-4, EN 302 085 (Annex A.1.1)
Salt Fog	According to IEC 68-2-11

### Ordering Options

MA-WD56-DSV16	Antenna Suited for MNT-22 (optional wall/pole adjustable mount)
MA-WD56-DSV16B	Antenna with MNT-22 mount

Patterns are available on our website

MARS Antennas & RF Systems proprietary information

MARS reserves the right to make technical changes or modifications to any of its products and specifications without prior notice and without implementing such changes to prior supplied products. Product images are representative and indicative only. Warranty terms and general conditions of sale are applicable on any purchase of any product, available on MARS website.

3 Hamanor st. Holon 5886103, P.O.Box 1852 Holon 5811801, Israel

Tel: +972-3-5599661 • Fax: +972-3-5599677 • e-mail: mars@marsant.co.il • web: www.mars-antennas.com

## 6 GHz – 8 GHz

Subscriber - Dual Pol  
 Sector - Dual Pol

Part Number	Description	Frequency band	Gain	Polarization	Dimension	Antenna type	Page
<b>MA-WA65-DP19</b>	Dual Polarized / Dual Slant Subscriber	6-7 GHz	19 ± 1 dBi	Dual Pole V & H Dual Slant ±45°	200 x 200 x 33 mm	Subscriber Dual Pol	05-1
<b>MA-WA78-DP19N</b>	Dual Polarized Subscriber	7-8 GHz	19 ± 1 dBi	Dual Pole V & H	155 x 155 x 28 mm	Subscriber Dual Pol	05-2
<b>MA-WD78-DP12</b>	Dual Polarized Base Station 90°	7.75-7.9 GHz	12 dBi	Linear, Vertical & Horizontal	155 x 155 x 28 mm	Sector Dual Pol	05-3

MARS Antennas & RF Systems proprietary information

MARS reserves the right to make technical changes or modifications to any of its products and specifications without prior notice and without implementing such changes to prior supplied products. Product images are representative and indicative only. Warranty terms and general conditions of sale are applicable on any purchase of any product, available on MARS website.

3 Hamanor st. Holon 5886103, P.O.Box 1852 Holon 5811801, Israel

Tel: +972-3-5599661 • Fax: +972-3-5599677 • e-mail: mars@marsant.co.il • web: www.mars-antennas.com

## MA-WA65-DP19

### 6-7 GHz Dual Polarization Subscriber Antenna

MARS 6-7 GHz Dual Polarized subscriber Antenna designed to provide full coverage for the 6 GHz frequency band.

Additional Features:

- Efficient and stable performance.
- High gain/size ratio.
- Light weight and durable construction.
- UV protected radome made of polycarbonate suitable for harsh weather installations.



### Specifications

#### Electrical

Frequency range	6-7 GHz
GAIN	19 ± 1 dBi
VSWR, max.	1.7 : 1
Polarization	Dual Pole Dual Slant (opt.)
	Linear, Vertical & Horizontal Dual Slant ± 45°
3 dB Beam-Width-Azimuth, typ.	16°
3 dB Beam-Width-Elevation, typ.	16°
Side Lobes, typ.	-10 dB
Cross Polarization, min.	-15 dB
Front to Back Ratio, min.	-30 dB
Port to Port Isolation, min.	-30 dB
Input power, max.	10 Watt
Input Impedance	50 Ohm
Lightning Protection	DC Grounded

#### Mechanical

Dimensions (HxWxD)	200 x 200 x 33 mm (7.9" x 7.9" x 1.25")
Connector	2 x N-Type, Female
Weight	380 gr.
Mounting	See Ordering Options
Radome	UV Protected Polycarbonate
Back Plane	Aluminum protected through chemical passivation

#### Environmental

Operating Temperature Range	-55°C to +65°C
Vibration	According to IEC 60721-3-4
Wind Load	200 Km/h (Survival)
Flammability	UL94
Water Proofing	IP-67
Humidity	ETS 300 019-1-4, EN 302 085 (Annex A.1.1)
Salt Fog	According to IEC 68-2-11

### Ordering Options

MA-WA65-DP19	Antenna 2 x N-Type Female connectors Suited for MNT-23 mount
MA-WA65-DP19B	Antenna 2 x N-Type Female connectors with MNT-23 mount

Mars Antennas & RF Systems proprietary information

MARS reserves the right to make technical changes or modifications to any of its products and specifications without prior notice and without implementing such changes to prior supplied products. Product images are representative and indicative only. Warranty terms and general conditions of sale are applicable on any purchase of any product, available on MARS website.

3 Hamanor st. Holon 58861, P.O.Box 5 AZOR 58008, Israel

Tel: +972-3-5599661 • Fax: +972-3-5599677 • e-mail: mars@marsant.co.il • web: www.mars-antennas.com

## MA-WA78-DP19N

### 7-8 GHz Dual Polarization Subscriber Antenna

MARS 7-8 GHz Dual Polarized Antenna designed to provide full coverage for the 7 & 8 GHz frequency band.

Additional Features:

- Efficient and stable performance.
- High gain/size ratio.
- Light weight and durable construction.
- UV protected radome made of polycarbonate suitable for harsh weather installations.



## Specifications

### **Electrical**

Frequency range	7-8 GHz
GAIN, typ.	19 ± 1 dBi
VSWR, max.	1.7 : 1
Polarization	Linear, Vertical & Horizontal
3dB Beam-Width, H-Plane, typ.	16°
3dB Beam-Width, E-Plane, typ.	16°
Side Lobes, typ.	-12 dB
Cross Polarization, typ.	-15 dB
Front to Back Ratio, min.	-25 dB
Port to Port Isolation, typ.	-25 dB
Input power, max.	10 Watt
Input Impedance	50 Ohm
Lightning Protection	DC Grounded

### **Mechanical**

Dimensions (HxWxD)	155 x 155 x 28 mm ( 6.1" x 6.1" x 1.1")
Connector	2 x N-Type, Female
Weight	250 gr.
Mounting	See ordering options
Radome	UV Protected Polycarbonate
Back Plane	Aluminum protected through chemical passivation.

### **Environmental**

Operating Temperature Range	-55°C to +65°C
Vibration	According to IEC 60721-3-4
Wind Load	200 Km/h (Survival)
Flammability	UL94
Water Proofing	IP-67
Humidity	ETS 300 019-1-4, EN 302 085 (Annex A.1.1)
Salt Fog	According to IEC 68-2-11

## Ordering Options

MA-WA78-DP19N	Antenna Suited for MNT-23 (optional wall/pole adjustable mount)
MA-WA78-DP19NB	Antenna with MNT-23 mount

Patterns are available on our website

Mars Antennas & RF Systems proprietary information

MARS reserves the right to make technical changes or modifications to any of its products and specifications without prior notice and without implementing such changes to prior supplied products. Product images are representative and indicative only. Warranty terms and general conditions of sale are applicable on any purchase of any product, available on MARS website.

3 Hamanor st. Holon 58861, P.O.Box 5 AZOR 58008, Israel

Tel: +972-3-5599661 • Fax: +972-3-5599677 • e-mail: mars@marsant.co.il • web: www.mars-antennas.com

## MA-WD78-DP12

### 7.75-7.9 GHz Dual Polarization Base Station Antenna 90°

MARS 90° Base Station Antenna with 12 dBi of gain is lightweight yet has a robust and durable construction.

#### Antenna Features:

- Quick and easy installation.
- Small, aesthetic and unobtrusive radome.
- Easily adapted to any RF connector.
- Easy mounting allows obtaining required down tilt degree.



## Specifications

### Electrical

Frequency range	7.75-7.9 GHz
GAIN, typ.	12 dBi
VSWR, max.	1.7 : 1
Polarization	Dual Pole
3 dB Beam-Width, H-Plane, typ.	Linear, Vertical & Horizontal
3 dB Beam-Width, E-Plane, typ.	90°
Side Lobes, min	15°
Cross Polarization, typ.	-12 dB
Front to Back Ratio, min.	-15 dB
Port to Port Isolation, typ.	-25 dB
Input power, max	10 Watt
Input Impedance	50 Ohm
Lightning Protection	DC Grounded

### Mechanical

Dimensions (HxWxD)	155 x 155 x 28 mm ( 6.1"x 6.1"x1.1")
Connector	2 x N-Type, Female
Weight	250 gr.
Mount	See ordering options
Radome	UV Protected Polycarbonate
Back Plane	Aluminum protected through chemical passivation

### Environmental

Operating Temperature Range	-55 °C to +65 °C
Vibration	According to IEC 60721-3-4
Wind Load	200 Km/h (Survival)
Flammability	UL94
Water Proofing	IP-67
Humidity	ETS 300 019-1-4, EN 302 085 (annex A.1.1)
Salt Fog	According to IEC 68-2-11

## Ordering Options

MA-WD78-DP12	Antenna Suited for MNT-23 (optional wall/pole adjustable mount)
MA-WD78-DP12B	Antenna with MNT-23 mount

Patterns are available on our website

Mars Antennas & RF Systems proprietary information

MARS reserves the right to make technical changes or modifications to any of its products and specifications without prior notice and without implementing such changes to prior supplied products. Product images are representative and indicative only. Warranty terms and general conditions of sale are applicable on any purchase of any product, available on MARS website.

3 Hamanor st. Holon 58861, P.O.Box 5 AZOR 58008, Israel

Tel: +972-3-5599661 • Fax: +972-3-5599677 • e-mail: mars@marsant.co.il • web: www.mars-antennas.com

# 10 GHz and Up

Subscriber - Dual Pol  
 Sector - Single Pol

Part Number	Description	Frequency band	Gain	Polarization	Dimension	Antenna type	Page
<b>MA-WA10-DP23</b>	Dual Polarized Subscriber	10.15-11 GHz	23 dBi	Dual Pole V & H	200 x 200 x 33 mm	Subscriber Dual Pol	06-1
<b>MA-WD10-DP14</b>	Dual Slant Base Station, 90°	10.15-10.7 GHz	14 dBi	Dual Vertical & Horizontal	200 x 200 x 33 mm	Sector Dual Pol	06-2
<b>MA-WG10-6H</b>	10.5GHz Sector	10.15-10.65 GHz	15 dBi	Linear, Horizontal	339 x 195 x 40 mm	Sector Single Pol	06-3

MARS Antennas & RF Systems proprietary information

MARS reserves the right to make technical changes or modifications to any of its products and specifications without prior notice and without implementing such changes to prior supplied products. Product images are representative and indicative only. Warranty terms and general conditions of sale are applicable on any purchase of any product, available on MARS website.

3 Hamanor st. Holon 5886103, P.O.Box 1852 Holon 5811801, Israel

Tel: +972-3-5599661 • Fax: +972-3-5599677 • e-mail: mars@marsant.co.il • web: www.mars-antennas.com

## MA-WA10-DP23

### 10.15–11.7GHz Dual Polarization Subscriber Antenna

MARS 10.15-11.7 GHz Dual Polarized Antenna designed to provide full coverage for the 10 GHz frequency band.

Additional Features:

- Efficient and stable performance.
- High gain/size ratio.
- Light weight and durable construction.
- UV protected radome made of polycarbonate suitable for harsh weather installations.



## Specifications

### Electrical

Frequency range	10.15-11.7 GHz
GAIN, typ.	22.5 dBi
VSWR, max.	2.0 : 1
Polarization, Dual Pole.	Linear, Vertical & Horizontal
3dB Beam-Width, H-Plane, typ.	10°
3dB Beam-Width, E-Plane, typ.	10°
Side Lobes, typ.	-12 dB
Cross Polarization, min.	-15 dB
Port to Port Isolation, typ.	-25 dB
Front to Back Ratio, min.	-30 dB
Input power, max.	10 Watt
Input Impedance	50 Ohm
Lightning Protection	DC Grounded

### Mechanical

Dimensions (HxWxD)	200 x 200 x 33 mm (7.9" X 7.9" X 1.25")
Connector	2 x SMA Right Angle Female
Weight	400 gr.
Radome	Polycarbonate UV Protected
Mount	See Ordering Options
Back Plane	Aluminum protected through chemical passivation.

### Environmental

Operating Temperature Range	-40°C to +65°C
Vibration	According to IEC 60721-3-4
Wind Load	200 km/h (Survival)
Flammability	UL94
Water Proofing	IP-67
Humidity	ETS 300 019-1-4, EN 302 085 (Annex A.1.1)
Salt Fog	According to IEC 68-2-11

## Ordering Options

MA-WA10-DP23	Antenna Suited for MNT-23 (optional wall/pole adjustable mount)
MA-WA10-DP23B	Antenna with MNT-23 mount

Patterns are available on our website

MARS Antennas & RF Systems proprietary information

MARS reserves the right to make technical changes or modifications to any of its products and specifications without prior notice and without implementing such changes to prior supplied products. Product images are representative and indicative only. Warranty terms and general conditions of sale are applicable on any purchase of any product, available on MARS website.

3 Hamanor st. Holon 5886103, P.O.Box 1852 Holon 5811801, Israel

Tel: +972-3-5599661 • Fax: +972-3-5599677 • e-mail: mars@marsant.co.il • web: www.mars-antennas.com



## MA-WD10-DP14

### 10.15-10.65 GHz Dual Polarized Base Station Antenna, 90°

MARS 90° Broadband Dual Polarized Sector Antenna designed to provide coverage for 10.15-10.65 GHz frequency band

Features:

- Stable performance
- Compact size allowing for easy blending with any environment
- Tilt mount allowing for quick and easy installation
- UV protected radome suitable for harsh environment installations



## Specifications

### Electrical

Frequency range	10.15-10.65 GHz
GAIN, typ.	14.5 dBi
VSWR, max.	2 : 1
Polarization	Dual Vertical & Horizontal
3 dB Beam-Width, Az-Plane, typ.	90°
3 dB Beam-Width, El-Plane, typ.	10°
Side Lobe Level, typ.	-12 dB
Cross Polarization, typ.	-15 dB
Front to Back Ratio, min.	-30 dB
Port to Port Isolation, min.	-40 dB
Input power, max	10 Watt
Input Impedance	50 Ohm
Lightning Protection	DC Grounded

### Mechanical

Dimensions (HxWxD)	380 x 75 x 80 mm (15" x 3" x 3.1")
Weight	400 gr.
Connector	2 x N-Type, Female
Back Plane	Aluminum protected through chemical passivation
Radome	UV Protected, Plastic
Mount	See Ordering Options

### Environmental

Operating Temperature Range	-40°C to +65°C
Vibration	According to IEC 60721-3-4
Wind Load	200 km/h (survival)
Flammability	UL94
Water Proofing	IP-65
Humidity	ETS 300 019-1-4, EN 302 085 (annex A.1.1)
Salt Fog	According to IEC 68-2-11

## Ordering Options

MA-WD10-DP14	Antenna Suited for MNT-23 (optional wall/pole adjustable mount)
MA-WD10-DP14B	Antenna with MNT-23 mount

Patterns are available on our website

MARS Antennas & RF Systems proprietary information

MARS reserves the right to make technical changes or modifications to any of its products and specifications without prior notice and without implementing such changes to prior supplied products. Product images are representative and indicative only. Warranty terms and general conditions of sale are applicable on any purchase of any product, available on MARS website.

3 Hamanor st. Holon 5886103, P.O.Box 1852 Holon 5811801, Israel

Tel: +972-3-5599661 • Fax: +972-3-5599677 • e-mail: mars@marsant.co.il • web: www.mars-antennas.com

## MA-WG10-6H

### 10.5 GHz Sector Antenna

MARS 10.5 GHz Sector Antenna provides a cost effective solution for large scale WLL / BWA, Point-to- Point applications.

Antenna Features:

- Stable and reliable performance.
- Features horizontal polarization with 15 dBi of gain.
- Antenna is light-weight and yet has a durable construction.
- Suitable for harsh environment installations.
- Easy and quick installation with corrosion-resistant az/el adjustable mount.



### Specifications

#### Electrical

Frequency range	10.15-10.65 GHz
GAIN, min.	15 dBi
Gain Variation Across Main Beam (Ripple), max.	3 dB
VSWR, max.	1.7 : 1
Polarization	Horizontal
3 dB Beam-Width, H-Plane, typ.	84°
3 dB Beam-Width, E-Plane, typ.	5°
Side Lobe Level	ETSI EN 302 085 V1.2.3-CS2
Cross Polarization,min.	ETSI EN 302 085 V1.2.3-CS2
Front to Back Ratio, min.	ETSI EN 302 085 V1.2.3-CS2
Input power, max.	10 Watt
Input Impedance	50 Ohm
Lightning Protection	DC Grounded

#### Mechanical

Dimensions (HxWxD)	339 x 195 x 40 mm (13.3" x 7.7" x 1.6")
Weight	900 gr.
Connector	N-Type, Female
Back Plane	Aluminum; protected through chemical passivation
Radome	UV Protected Plastic
Mount	See ordering options

#### Environmental

Operating Temperature Range	-40°C to +65°C
Vibration	According to IEC 60721-3-4
Wind Load	200 km/h (survival)
Flammability	UL94
Water Proofing	IP-65
Humidity	ETS 300 019-1-4, EN 302 085 (annex A.1.1)
Salt Fog	According to IEC 68-2-11
Ice and Snow	25mm radial (survival)

#### Standard Compliance

ETSI EN 302 085 V1.2.3 - CS2

### Ordering Options

MA-WG10-6H	Antenna Suited for MNT-22 (optional wall/pole adjustable mount)
MA-WG10-6HB	Antenna with MNT-22 mount

Patterns are available on our website

MARS Antennas & RF Systems proprietary information

MARS reserves the right to make technical changes or modifications to any of its products and specifications without prior notice and without implementing such changes to prior supplied products. Product images are representative and indicative only. Warranty terms and general conditions of sale are applicable on any purchase of any product, available on MARS website.

3 Hamanor st. Holon 5886103, P.O.Box 1852 Holon 5811801, Israel

Tel: +972-3-5599661 • Fax: +972-3-5599677 • e-mail: mars@marsant.co.il • web: www.mars-antennas.com

# OMNI

Part Number	Description	Frequency band	Gain	Polarization	Dimension	Antenna type	Page
<b>MA-WO-UWB</b>	Ultra Wide Band OMNI Directional	138-174 MHz 380-450 MHz 450-512 MHz 512-698 MHz 698-746 MHz 746-806 MHz 806-960 MHz 1200-2700 MHz 3300-3800 MHz 4100-6000 MHz	3 dBi 4 dBi 5 dBi 5.5 dBi 6 dBi 7 dBi 7 dBi 8 dBi 10 dBi 11 dBi	Linear, Vertical	540 x 40 Dia mm	OMNI	07-1
<b>MA-CQ26-1X</b>	380 MHz -6 GHz Multi Band Omni	380-806 MHz 806-960 MHz 1395-1432 MHz 1710-2170 MHz 2300-2500 MHz 3300-3700 MHz 4900-6000 MHz	1 (2*) dBi 4 dBi 5 dBi 5 dBi 5 dBi 5 dBi 6 dBi	Linear, Vertical	Base Dia. - 275 Height - 187 mm	OMNI	07-2
<b>MA-CQ27-1X</b>	380 MHz -6 GHz Multi Band Omni	380-806 MHz 806-960 MHz 1395-1432 MHz 1710-2170 MHz 2300-2700 MHz 3300-3700 MHz 4900-6000 MHz	1 (2*) dBi 4 dBi 5 dBi 5 dBi 6 dBi 6 dBi 6 dBi	Linear, Vertical	Base Dia. - 275 Height - 187 mm	OMNI	07-3
<b>MA-CQ29-1X</b>	380 MHz -6 GHz Multi Band Omni	380-806 MHz 806-960 MHz 1700-2500 MHz 2500-2700 MHz 3300-3700 MHz 4900-6000 MHz	1 (2*) dBi 4 dBi 5 dBi 5 dBi 6 dBi 6 dBi	Linear, Vertical	Base Dia. - 275 Height - 187 mm	OMNI	07-4
<b>MA-WO46-2</b>	450-470 MHz OMNI	450-470 MHz	2 dBi	Linear, Vertical	360 x 26 Dia mm	OMNI	07-5
<b>MA-WOLTE-3X</b>	LTE, GSM, UMTS, WLAN, Wi-Fi Multi Band Omni	698-806 MHz 806-960 MHz 1710-2170 MHz 2300-2700 MHz 3300-3800 MHz 4900-6500 MHz	2 dBi 2 dBi 3-4 dBi 5 dBi 4 dBi 6 dBi	Linear, Vertical	Base Dia. - 205 Height - 89 mm	OMNI	07-6
<b>MA-WOLTE-3M1</b>	698-6500 MHz Multi Band Tri-Ports Omni	<b>Port 1 &amp; 2</b> 698-960 MHz 1710-2170 MHz 2.3-2.7 GHz. 3.3-3.8 GHz 4.9- 6.5 GHz <b>Port 3</b> 1710-2170 MHz 2.3-2.7 GHz 3.3-3.8 GHz 4.9- 6.5 GHz	2 dBi 3-4 dBi 5 dBi 4 dBi 6 dBi 3 dBi 3 dBi 4 dBi 6 dBi	Linear, Vertical	Antenna dimension (D,H): 220 x 95 mm  Base dimension (L,W,H): 369 x 270 x 30 mm	OMNI	07-7
<b>MA-WOLTE-DP1</b>	698-6500 MHz Multi Band Dual Polarized Omni	<b>Vertical</b> 698-960 MHz 1710-2170 MHz 2.3-2.7 GHz 3.3-3.8 GHz 4.9- 6.5 GHz <b>Horizontal</b> 2.3-2.7 GHz 4.9- 5.875 GHz	4 dBi 5 dBi 5.5 dBi 7 dBi 7.5 dBi 5 dBi 5 dBi	Linear, Vertical	Base Diameter 275 mm  Height 190 mm	OMNI	07-8

MARS Antennas & RF Systems proprietary information

MARS reserves the right to make technical changes or modifications to any of its products and specifications without prior notice and without implementing such changes to prior supplied products. Product images are representative and indicative only. Warranty terms and general conditions of sale are applicable on any purchase of any product, available on MARS website.

3 Hamanor st. Holon 5886103, P.O.Box 1852 Holon 5811801, Israel

Tel: +972-3-5599661 • Fax: +972-3-5599677 • e-mail: mars@marsant.co.il • web: www.mars-antennas.com

Part Number	Description	Frequency band	Gain	Polarization	Dimension	Antenna type	Page
<b>MA-WOLTE-DP2</b>	698-6500 MHz Multi Band Tri-Ports Omni	<b>Port 1</b> 1.7-2.7 GHz	5 dBi	Linear, Horizontal	Antenna dimension (D,H): 220 x 95 mm  (Stand out from the ceiling)	OMNI	07-9
		<b>Port 2</b> 4.4-6.6 GHz	6 dBi	Linear, Horizontal			
		<b>Port 3</b> 698-960 MHz	4 dBi	Linear, Horizontal			
		1.7-2.3 GHz	3-4 dBi	Linear, Vertical			
<b>MA-WO7402700-5</b>	Multi Band Omni Directional Base Station	740-960 MHz	4 dBi	Linear, Vertical	470 x 66 Dia mm	OMNI	07-10
		1710-2700 MHz	6 dBi				
<b>MA-WO8622-DB2</b>	Dual Pole OMNI Directional	790-960 MHz 1695-2700 MHz	2 dBi 2.5-5.8 dBi	Linear, Vertical	192 x 30 Dia mm	OMNI	07-11
<b>MA-CR26-2X</b>	Multi Band Omni	806-960 MHz	2 dBi	Linear, Vertical	Base Dia. - 205 Height - 89 mm	OMNI	07-12
		1710-2170 MHz	3-4 dBi				
		2300-2700 MHz	5 dBi				
		3400-3700 MHz	5 dBi				
		4900-6000 MHz	5-6 dBi				
<b>MA-CM36-15</b>	Multi Band Omni	806-960 MHz	2 dBi	Linear, Vertical	Base Dia. - 205 Height - 89 mm	OMNI	07-13
		1710-2170 MHz	3-4 dBi				
		2300-2700 MHz	5 dBi				
<b>MA-WO850-5</b>	Omni-Directional	830-870 MHz	5 dBi	Linear, Vertical	Base Dia. - 40 Height - 700 mm	OMNI	07-14
<b>MA-WO91-8X</b>	Omni-Directional	902-928 MHz	8 dBi	Linear, Vertical I	1350 x 64 (Dia.) mm	OMNI	07-15
<b>MA-WO25-DP10</b>	Dual Pole OMNI Directional	2.3-2.7 GHz	Vertical @ 9 dBi Horizontal @ 10 dBi	Vertical & Horizontal	640 x 110(dia.) mm	OMNI	07-16
<b>MA-WO25-9</b>	Omni-Directional	2.3-2.7 GHz	9 dBi	Linear, Vertical	640 x 76 Dia mm	OMNI	07-17
<b>MA-WO25-9H</b>	Omni-Directional	2.3-2.7 GHz	10 dBi	Linear, Horizontal	640 x 76 Dia mm	OMNI	07-18
<b>MA-WO24-DP6</b>	Dual Pole Omni Directional	2.4-2.5 GHz	10 dBi	Dual Pole, V & H	640 x 112 (dia.) mm	OMNI	07-19
<b>MA-WO36-DP10</b>	Dual Pole Omni Directional	3.3-3.8 GHz	Vertical – 9 dBi Horizontal – 10 dBi	Dual Pole, V & H	485 x 85 Dia mm	OMNI	07-20
<b>MA-WO56-DP10</b>	Dual Pole OMNI Directional	4.9-5.9 GHz	4.9-5.1 GHz Vertical @ 8dBi & Horizontal @ 10dBi 5.1-5.9 GHz @ 10dBi	Vertical & Horizontal	365 x 66(dia.) mm	OMNI	07-21
<b>MA-DBO2458-6</b>	Dual Band Omni	2.3-2.7 GHz 4.9-6 GHz	4-5 dBi / 7 dBi	Linear, Vertical	210 x 28.5 Dia. mm	OMNI	07-22
<b>MA-DBO-3H</b>	<b>Dual Band</b> MIMO Omni	2.3-2.7 GHz 4.9-6.1 GHz	3 X 2.5 dBi 3 X 3.5 dBi	Linear, Vertical	200 x 200 x 33 mm	OMNI	07-23
<b>MA-DBO-3MIMO</b>	<b>Dual Band</b> MIMO Omni	2.3-2.7 GHz 4.9-6 GHz	3 X 4 dBi 3 X 7 dBi	Linear, Vertical	205 x 330 mm	OMNI	07-24
<b>MA-WO36-10N</b>	3.5 GHz Omni- Directional Base Station	3.3-3.8 GHz	9.5 dBi (typ.)	Linear, Vertical	470 x 66 mm	OMNI	07-25
<b>MA-WO55-MIMO9NH3</b>	<b>MIMO Omni</b> – Base Station	4.9-5.875 GHz	3 x 9 dBi	Linear, Vertical	330 x 120 mm	OMNI	07-26
<b>MA-WO55-10NH</b>	Omni-Directional Horizontal	4.9-5.875 GHz	10 dBi	Linear, Vertical	315 x 40 Dia. mm	OMNI	07-27
<b>MA-WO56-10H</b>	Omni-Directional	5.1-5.9 GHz	10 dBi	Linear, Horizontal	315 x 40 Dia. mm	OMNI	07-28

MARS Antennas & RF Systems proprietary information

MARS reserves the right to make technical changes or modifications to any of its products and specifications without prior notice and without implementing such changes to prior supplied products. Product images are representative and indicative only. Warranty terms and general conditions of sale are applicable on any purchase of any product, available on MARS website.

3 Hamanor st. Holon 5886103, P.O.Box 1852 Holon 5811801, Israel

Tel: +972-3-5599661 • Fax: +972-3-5599677 • e-mail: mars@marsant.co.il • web: www.mars-antennas.com

## MA-WO-UWB

### 138-6000 MHz Ultra Wide Band OMNI Directional Antenna

MARS MA-WO-UWB is an Ultra Wide Band OMNI Directional Antenna covering continuously all the bands from 138 MHz up to 6 GHz in a single antenna radome.

Perfect matching in all bands with small ground plane.

Excellent OMNI Directional coverage.

The antenna is PIM certified, thus making it suitable for all multi-carrier systems.



### Specifications

#### Electrical

Frequency Range	Gain, typ.	Optimum Ground Plane Size	VSWR
138-174 MHz	3dBi	400 x 400 mm (MG-400)	1.5:1 typ. (3:1 max)
380-450 MHz	4dBi	370 x 370 mm (MG-370)	1.5:1 typ. (2.5:1 max)
450-512 MHz	5dBi	165 x 165 mm (MG-165)	1.5:1 typ. (2.8:1 max)
512-698 MHz	5.5dBi	165 x 165 mm (MG-165)	1.5:1 typ. (2.8:1 max)
698-746 MHz	6dBi	165 x 165 mm (MG-165)	1.5:1 typ. (2.5:1 max)
746-806 MHz	7dBi	165 x 165 mm (MG-165)	1.5:1 typ. (2.5:1 max)
806-960 MHz	7dBi	165 x 165 mm (MG-165)	1.7:1 typ. (2.5:1 max)
1200-2700 MHz	8dBi	Not Required	1.3:1 typ. (2.0:1 max)
3300-3800 MHz	10dBi	Not Required	1.3:1 typ. (1.7:1 max)
4100-6000 MHz	11dBi	Not Required	1.5:1 typ. (2.0:1 max)
Polarization	Linear ,Vertical		
Pattern	OMNI Directional		
PIM, 3rd order, 2X20W	<-155 dBc		
Input Power, max	50 Watts		
Input Impedance	50 Ohm		

#### Mechanical

Dimensions (DxH)	40mm diameter (base diameter 72mm) x 540mm height 1.57" diameter (base diameter 2.8") x 21" height
Weight	350 gr.
Connector	N-Type, Female
Mounting	2" Pole Mount
Radom	UV Protected Plastic
Ground Plane	See Ordering Options & MG-XXX datasheet for the Optimum Ground Plane as specified above

#### Environmental

Operating Temp. Range	-40°C to +70°C
Vibration	According to IEC 60721-3-4
Wind Load	200 Km/h (Survival)
Flammability	UL94
Water Proofing	IP-65
Humidity	ETS 300 019-1-4, EN 302 085 (Annex A.1.1)
Salt Fog	According to IEC 68-2-11

### Ordering Options

MA-WO-UWB	Antenna for 1200-6000 MHz
MA-WO-UWB & MG-400	Antenna for 138-174 MHz
MA-WO-UWB & MG-370	Antenna for 380-450 MHz
MA-WO-UWB & MG-165	Antenna for 450-960 MHz

MARS Antennas & RF Systems proprietary information

MARS reserves the right to make technical changes or modifications to any of its products and specifications without prior notice and without implementing such changes to prior supplied products. Product images are representative and indicative only. Warranty terms and general conditions of sale are applicable on any purchase of any product, available on MARS website.

3 Hamanor st. Holon 5886103, P.O.Box 1852 Holon 5811801, Israel

Tel: +972-3-5599661 • Fax: +972-3-5599677 • e-mail: mars@marsant.co.il • web: www.mars-antennas.com

## MA-CQ26-1X

### 380 MHz-6 GHz Multi Band Omni Antenna

MARS Multi Band Omni Antenna covers all the bands for 2G, 2.5G and 3G cellular, as well as ISM, WLAN, UNII, Bluetooth, Wi-Fi, WMTS and IMT-MC450. The antenna is aesthetic and has unobtrusive profile that blends easily with any environment.

The antenna is easy-installed and is highly recommended as an outstanding logistic solution for In-Building Installations.

The antenna is PIM certified, thus making it suitable for all multi-carrier systems.



### Specifications

#### Electrical

Standard	TETRA, IMT-MC450, WMTS, DVB-T LTE	SMR, AMPS, CDMA, TDMA, GSM 900	WMTS, PCS, DECT, GSM 1900, UMTS	Bluetooth, ISM, WLAN	WLL, Broad-band access Licensed Band	Home land Security, UNII, WLL, H-LAN, Wi-Fi
Frequency range	380-806 MHz	806-960 MHz	1.395-1.432 GHz 1.71-2.17 GHz	2.3-2.5 GHz	3.3-3.7 GHz	4.9-6 GHz
GAIN, typ.	1 (2*)	4	5	5	5	6
VSWR, max.	3:1 (2.5:1*)	2 : 1	2 : 1	2 : 1	1.9 : 1	1.9 : 1
Polarization	Linear, Vertical					
Input power, max.	50 Watt					
Input Impedance	50 Ohm					
PIM, 3rd order, 2X20W (option)	<-155 dBc					

#### Mechanical

Dimensions (HxWxD)	Base Diameter - 275 mm, Height - 187 mm
Weight	550 gr.
Connector	N-Type, Female
Back Plane	Aluminum; protected through chemical passivation
Radome	UV Protected Polycarbonate
Water Proofing	IP-67 (for outdoor use only)
Mount	Ceiling Mounting

#### Environmental

Operating Temp. Range	-40°C to +65°C
Vibration	According to IEC 60721-3-4
Flammability	UL94
Humidity	ETS 300 019-1-4, EN 302 085 (annex A.1.1)

### Ordering Options

MA-CQ26-1X	Antenna Indoor
MA-CQ26-1XT	Antenna Indoor with DC Return Option
MA-CQ26-1XR	Antenna Outdoor
MA-CQ26-1XP	Antenna Indoor PIM Certified
MA-CQ26-1XTP	Antenna Indoor with DC Return Option PIM Certified
MA-CQ26-1XRP	Antenna Outdoor PIM Certified

(\*) Specifications for Ground Plate of 40 cm and up, or above a metal surface, with a spacing of 35-45 mm.

### Patent Pending

Patterns are available on our website.

MARS Antennas & RF Systems proprietary information

MARS reserves the right to make technical changes or modifications to any of its products and specifications without prior notice and without implementing such changes to prior supplied products. Product images are representative and indicative only. Warranty terms and general conditions of sale are applicable on any purchase of any product, available on MARS website.

3 Hamanor st. Holon 5886103, P.O.Box 1852 Holon 5811801, Israel

Tel: +972-3-5599661 • Fax: +972-3-5599677 • e-mail: mars@marsant.co.il • web: www.mars-antennas.com

## MA-CQ27-1X

### 380 MHz-6 GHz Multi Band Omni Antenna

MARS Multi Band Omni Antenna covers continuously all the bands from 380 to 960 MHz and for 2G, 2.5G and 3G cellular, as well as ISM, WLAN, UNII, Bluetooth, Wi-Fi, WMTS IMT-MC450 and LTE.

The antenna is aesthetic and has unobtrusive profile that blends easily with any environment.

The antenna is easy-installed and is highly recommended as an outstanding logistic solution for fast deployments and “In-Building” installations. The antenna is available also for outdoor applications.

The antenna is PIM certified, thus making it suitable for all multi-carrier systems.



### Specifications

#### Electrical

Standard	TETRA, IMT- MC450, WMTS, DVB-T LTE	SMR, AMPS, CDMA, TDMA, GSM 900	WMTS, PCS, DECT, GSM 1900, UMTS	Bluetooth, ISM, WLAN	WLL, Broadband access Licensed Band	Homeland Security, UNII, WLL, H-LAN, Wi- Fi
Frequency range	380-806 MHz	806-960 MHz	1.395-1.432 1.71-2.17 GHz	2.3-2.7 GHz	3.3-3.7 GHz	4.9-6 GHz
GAIN, typ.	1 (2*)	4	5	6	6	6
VSWR, max.	3:1 (2.5:1*)	2 : 1	1.9 : 1	1.9 : 1	1.9 : 1	1.9 : 1
Polarization	Linear, Vertical					
Input power, max	50 Watt					
Input Impedance	50 Ohm					
PIM, 3 <sup>rd</sup> order, 2X20W (optional)	<-155 dBc					

#### Mechanical

Dimensions(HxWxD)	Base Diameter - 275 mm, Height - 187 mm
Weight	550 gr.
Connector	N-Type, Female
Back Plane	Aluminum; protected through chemical passivation
Radome	UV Protected Polycarbonate
Water Proofing	IP-67 (for outdoor use only)
Mount	Ceiling Mounting

#### Environmental

Operating Temp. Range	-40°C to +65°C
Vibration	According to IEC 60721-3-4
Flammability	UL94
Humidity	ETS 300 019-1-4, EN 302 085 (annex A.1.1)

### Ordering Options

MA-CQ27-1X	Antenna Indoor
MA-CQ27-1XT	Antenna Indoor with DC Return Option
MA-CQ27-1XR	Antenna Outdoor
MA-CQ27-1XP	Antenna Indoor PIM certified
MA-CQ27-1XTP	Antenna Indoor with DC Return Option PIM certified
MA-CQ27-1XRP	Antenna Outdoor PIM certified

(\*) Specifications for Ground Plate of 40 cm and up, or above a metal surface, with a spacing of 35-45 mm.

### Patent Pending

Patterns are available on our website.

MARS Antennas & RF Systems proprietary information

MARS reserves the right to make technical changes or modifications to any of its products and specifications without prior notice and without implementing such changes to prior supplied products. Product images are representative and indicative only. Warranty terms and general conditions of sale are applicable on any purchase of any product, available on MARS website.

3 Hamanor st. Holon 5886103, P.O.Box 1852 Holon 5811801, Israel

Tel: +972-3-5599661 • Fax: +972-3-5599677 • e-mail: mars@marsant.co.il • web: www.mars-antennas.com

## MA-CQ29-1X

### 380 MHz-6 GHz Multi Band Omni Antenna

MARS Multi Band Omni Antenna covers continuously all the bands from 380 to 960 MHz and for 2G, 2.5G and 3G cellular, as well as ISM, WLAN, UNII, Bluetooth, Wi-Fi, WMTS IMT-MC450.

The antenna is aesthetic and has unobtrusive profile that blends easily with any environment.

The antenna is easy-installed and is highly recommended as an outstanding logistic solution for fast deployments and "In-Building" installations.



### Specifications

#### Electrical

Standard	TETRA, IMT-MC450, WMTS, DVB-T	SMR, AMPS, CDMA, TDMA, GSM 900	WMTS, PCS, DECT, GSM 1900, UMTS	Bluetooth, ISM, WLAN	WLL, Broad-band access Licensed Band	Homeland Security, UNII, WLL, H-LAN, Wi-Fi
Frequency range	380-806 MHz	806-960 MHz	1.7-2.5 GHz	2.5-2.7 GHz	3.3-3.7 GHz	4.9-6 GHz
GAIN, typ.	1 (2*)	4	5	5	6	6
VSWR, max.	3:1 (2.5:1*)	2 : 1	2 : 1	2.5 : 1	1.6 : 1	1.6 : 1
Polarization	Linear, Vertical					
Input power, max.	50 Watt					
PIM, 3rd order, 2X20W (option)	<-155 dBc					
Input Impedance	50 Ohm					

#### Mechanical

Dimensions (HxWxD)	Base Diameter - 275 mm, Height - 187 mm
Weight	550 gr.
Connector	N-Type, Female
Back Plane	Aluminum; protected through chemical passivation
Radome	UV Protected Polycarbonate
Mount	Ceiling Mounting

#### Environmental

Operating Temp. Range	-40°C to +65°C
Vibration	According to IEC 60721-3-4
Flammability	UL94
Water Proofing	IP-67 (for outdoor use only)
Humidity	ETS 300 019-1-4, EN 302 085 (annex A.1.1)

### Ordering Options

MA-CQ29-1X	Antenna Indoor
MA-CQ29-1XT	Antenna Indoor with DC Return Option
MA-CQ29-1XR	Antenna Outdoor
MA-CQ29-1XP	Antenna Indoor PIM Certified
MA-CQ29-1XTP	Antenna Indoor with DC Return Option PIM Certified
MA-CQ29-1XRP	Antenna Outdoor PIM Certified

(\*) Specifications for Ground Plate of 40 cm and up, or above a metal surface, with a spacing of 35-45 mm.

### Patent Pending

Patterns are available on our website.

MARS Antennas & RF Systems proprietary information

MARS reserves the right to make technical changes or modifications to any of its products and specifications without prior notice and without implementing such changes to prior supplied products. Product images are representative and indicative only. Warranty terms and general conditions of sale are applicable on any purchase of any product, available on MARS website.

3 Hamanor st. Holon 5886103, P.O.Box 1852 Holon 5811801, Israel

Tel: +972-3-5599661 • Fax: +972-3-5599677 • e-mail: mars@marsant.co.il • web: www.mars-antennas.com



## MA-WO64-2

### 450-470 MHz OMNI Antenna

MARS 450-470MHz OMNI Antenna provides a cost effective solution for PMR (Private mobile radio) applications used by operators such as taxis, utilities and emergency services.

Additional Features:

- Excellent and stable performance
- Small and aesthetic profile
- UV protected antenna radome
- Suitable for both indoor and outdoor installations



### Specifications

#### Electrical

Frequency Range	450-470 MHz
GAIN, typ.	2dBi
VSWR, max.	1.5:1
Polarization	Linear Vertical
3 dB Beam-Width, H-Plane, typ.	Omni Directional 360°
3 dB Beam-Width, E-Plane, typ.	70°
Input power, max	10 Watts
Input Impedance	50 Ohm

#### Mechanical

Dimensions (LxD)	360x26 mm
Connector	See Ordering Options
Mount	Ceiling / Pole mount optionally
Weight	300 gr.
Radome	UV Protected Plastic

#### Environmental

Operating Temperature Range	-40°C to +70°C
Vibration	According to IEC 60721-3-4
Water Proofing	IP-67
Flammability	UL94
Humidity	ETS 300 019-1-4, EN 302 085 (annex A.1.1)

### Ordering Options

MA-WO64-2NF	Antenna with N-Type Female and Mount
MA-WO64-2NM	Antenna with N-Type Male
MA-WO64-2SF	Antenna with SMA Female and Mount

MARS Antennas & RF Systems proprietary information

MARS reserves the right to make technical changes or modifications to any of its products and specifications without prior notice and without implementing such changes to prior supplied products. Product images are representative and indicative only. Warranty terms and general conditions of sale are applicable on any purchase of any product, available on MARS website.

3 Hamanor st. Holon 5886103, P.O.Box 1852 Holon 5811801, Israel

Tel: +972-3-5599661 • Fax: +972-3-5599677 • e-mail: mars@marsant.co.il • web: www.mars-antennas.com

## MA-WOLTE-3X

### 698 MHz-6.5 GHz Multi Band Omni Antenna

MARS Multi Band Omni Antenna covers all the bands for 2G, 2.5G and 3G cellular, as well as UHF (760-960 MHz), LTE (698-806 MHz), ISM, WLAN, UNII, Bluetooth and Wi-Fi bands.

The antenna is aesthetic, small and has unobtrusive profile that blends easily with any environment.

The antenna is easy-installed and is highly recommended as an outstanding logistic solution for In-Building Installations.

The antenna is PIM certified, thus making it suitable for all multi-carrier systems.



### Specifications

#### Electrical

Standard	LTE	SMR, AMPS, CDMA, TDMA, GSM 900	PCS, DECT, GSM 1900, UMTS	Bluetooth, ISM, WLAN	WLL	UNII, WLL, H-LAN, Wi-Fi
Frequency range	698-806 MHz	806-960 MHz	1.71-2.17 GHz	2.3-2.7 GHz	3.3-3.8 GHz	4.9-6.5 GHz
GAIN, typ.	2	2	3-4	5	4	6
VSWR, max.	2:1	2.2 : 1	1.9 : 1	2.1 : 1	2 : 1	2 : 1
Polarization	Linear, Vertical					
Input power, max.	50 Watt					
Input Impedance	50 Ohm					
PIM, 3rd order, 2X20W (option)	-150 dBc					

#### Mechanical

Dimensions (HxWxD)	Base Diameter - 205 mm, Height - 89 mm
Weight	220 gr.
Connector	N-Type, Female (See Ordering Options)
Back Plane	Glass epoxy
Radome	UV Protected Polycarbonate
Mount	See Ordering Options

#### Environmental

Operating Temperature Range	-40°C to +65°C
Vibration	According to IEC 60721-3-4
Flammability	UL94
Humidity	ETS 300 019-1-4, EN 302 085 (annex A.1.1)

### Ordering Options

MA-WOLTE-3X	Ceiling Mountable
MA-WOLTE-3X1	Ceiling option with central connector mounting (Long N-type 45 mm)
MA-WOLTE-3XA	Ceiling Mountable with 38 cm pigtail
MA-WOLTE-3XB	Ceiling/Wall Adjustable with MNT-22 mount
MA-WOLTE-3XT	Ceiling/Wall Provision for Adjustable with MNT-22 mount with DC Return
MA-WOLTE-3XP	Ceiling Mountable PIM certified
MA-WOLTE-3X1P	Ceiling option with central connector mounting (Long N-type 45 mm) PIM certified
MA-WOLTE-3XAP	Ceiling Mountable with 38 cm pigtail PIM certified
MA-WOLTE-3XBP	Ceiling/Wall Adjustable with MNT-22 mount PIM certified
MA-WOLTE-3XTP	Ceiling/Wall Provision for Adjustable with MNT-22 mount with DC Return PIM certified

Patterns are available on our website

## Patent Pending

MARS Antennas & RF Systems proprietary information

MARS reserves the right to make technical changes or modifications to any of its products and specifications without prior notice and without implementing such changes to prior supplied products. Product images are representative and indicative only. Warranty terms and general conditions of sale are applicable on any purchase of any product, available on MARS website.

3 Hamanor st. Holon 5886103, P.O.Box 1852 Holon 5811801, Israel

Tel: +972-3-5599661 • Fax: +972-3-5599677 • e-mail: mars@marsant.co.il • web: www.mars-antennas.com

## MA-WOLTE-3M1

### 698-6500 MHz Multi Band Tri-Ports Omni Antenna

MARS Multi Band Tri-Ports Omni Antenna provides coverage of 698-6500 MHz in a single antenna radome.

The Multi Band Tri-Ports Omni Antenna is easy-installed on ceiling and is highly recommended as an outstanding logistic solution for In-Building and outdoor installations and applications.

Additional Features:

- Low/mid gain.
- UV protected radome made of polycarbonate.



## Specifications

### Electrical

Frequency Range	698-6500 MHz	
	Port 1 & 2	Port 3
GAIN, typ	2 dBi @ 698-960 MHz 3-4 dBi @ 1710-2170 MHz 5 dBi @ 2.3-2.7 GHz 4 dBi @ 3.3-3.8 GHz 6 dBi @ 4.9- 6.5 GHz	3 dBi @ 1710-2170 MHz 3 dBi @ 2.3-2.7 GHz 4 dBi @ 3.3-3.8 GHz 6 dBi @ 4.9-6.5 GHz
VSWR, max.	< 2 : 1	
Polarization	Linear, Vertical	
Input power, max	5 Watt	
3 dB Beam Width-Plane	Omni directional	
Port to Port Isolation	698-960 MHz > -14dB & 1710-2170 MHz > -20dB & 2.3-2.7 GHz @ 3.3-3.8 GHz > -25dB & 4.9-6.5 GHz > -30dB	
Input Impedance	50 Ohm	

### Mechanical

Visible dimension (Dia x H) *	220 x 45 mm
Antenna dimension (L x W x H) **	369 x 270 x 95 mm
Weight	900 gr.
Connector	See ordering information
Back Plane	UV Protected Polycarbonate
Radome	UV Protected Polycarbonate
Mounting	Ceiling

### Environmental

Operating Temperature Range	-40°C to +65°C
Wind Load	200 Km/h (Survival)
Vibration	According to IEC 60721-3-4
Water Proofing	IP-67
Flammability	UL94
Salt Fog	According to IEC 68-2-11
Humidity	ETS 300 019-1-4, EN 302 085 (Annex A.1.1)

## Ordering Options

MA-WOLTE-3M1	3x Pigtail 6 feet LMR-195 with N-Type Male (Plenum Rated Cable)
MA-WOLTE-3M1N	Antenna 3 x N-Type Female

(\*) Dimensions for installation inside the ceiling tile

(\*\*) Dimension for installation outside of the tile (4 screws)

MARS Antennas & RF Systems proprietary information

MARS reserves the right to make technical changes or modifications to any of its products and specifications without prior notice and without implementing such changes to prior supplied products. Product images are representative and indicative only. Warranty terms and general conditions of sale are applicable on any purchase of any product, available on MARS website.

3 Hamanor st. Holon 5886103, P.O.Box 1852 Holon 5811801, Israel

Tel: +972-3-5599661 • Fax: +972-3-5599677 • e-mail: mars@marsant.co.il • web: www.mars-antennas.com

## MA-WOLTE-DP1

### 698 MHz – 6.5 GHz Multi Band Dual Polarized Omni Antenna

MARS Multi Band Omni Antenna covers continuously all the bands from 698 to 6500 MHz in Vertical Polarization and 2.3-2.7 GHz & 4.9-5.875 GHz Band in Horizontal Polarization in a single antenna radome.

The antenna is aesthetic and has unobtrusive profile that blends easily with any environment.

The antenna is easy-installed and is highly recommended as an outstanding logistic solution for fast deployments and “In-Building” installations. The antenna is available also for outdoor applications.

The antenna is PIM certified thus making it suitable for all multi-carrier systems.



### Specifications

#### Electrical

Polarization	Horizontal		Vertical				
	2.3-2.7 GHz	4.9-5.875 GHz	698-960 MHz	1.71-2.17 GHz	2.3-2.7 GHz	3.3-3.8 GHz	4.9-6.5 GHz
Frequency range							
GAIN, typ.	5 dBi	5 dBi	4 dBi	5 dBi	5.5 dBi	7 dBi	7.5 dBi
VSWR, max.	2 : 1						
Input power, max.	10 Watt						
Input Impedance	50 Ohm						
PIM, 3rd order, 2X20W (optional)	<-150 dBc						
Port to Port Isolation, typ.	-40 dB						

#### Mechanical

Dimensions (HxWxD)	Base Diameter – 275 mm, Height – 190 mm
Weight	400 gr.
Connector	2 x N-Type, Female
Back Plane	Aluminum; protected through chemical passivation
Radome	UV Protected Plastic
Mount	Ceiling Mounting

#### Environmental

Operating Temperature Range	-40°C to +65°C
Vibration	According to IEC 60721-3-4
Water Proofing	See Ordering Options
Flammability	UL94
Humidity	ETS 300 019-1-4, EN 302 085 (annex A.1.1)

### Ordering Options

MA-WOLTE-DP1	Antenna Indoor
MA-WOLTE-DP1R	Antenna Outdoor (IP67)
MA-WOLTE-DP1P	Antenna Indoor PIM certified
MA-WOLTE-DP1RP	Antenna Outdoor (IP67) PIM certified

Patterns are available on our website

**Patent Pending**

MARS Antennas & RF Systems proprietary information

MARS reserves the right to make technical changes or modifications to any of its products and specifications without prior notice and without implementing such changes to prior supplied products. Product images are representative and indicative only. Warranty terms and general conditions of sale are applicable on any purchase of any product, available on MARS website.

3 Hamanor st. Holon 5886103, P.O.Box 1852 Holon 5811801, Israel

Tel: +972-3-5599661 • Fax: +972-3-5599677 • e-mail: mars@marsant.co.il • web: www.mars-antennas.com

## MA-WOLTE-DP2

### 698 MHz – 6.6 GHz Multi Band Dual Polarized Omni Antenna

MARS Multi Band Omni Antenna covers continuously all the bands from 698 MHz to 6.6 GHz in Vertical Polarization and 1.7-2.7 GHz & 4.6-6.6 GHz Band in Horizontal Polarization in a single antenna radome.

The antenna is aesthetic and has unobtrusive profile that blends easily with any environment.

The antenna is easy-installed and is highly recommended as an outstanding logistic solution for fast deployments and “In-Building” installations. The antenna is available also for outdoor applications.



### Specifications

#### Electrical

	Port 1	Port 2	Port 3				
Frequency range	1.7-2.7 GHz	4.5-6.6 GHz	698-960 MHz	1.7-2.3 GHz	2.3-2.7 GHz	3.3-3.8 GHz	4.6-6.6 GHz
GAIN, typ.	5 dBi	6 dBi	4 dBi	3-4 dBi	5.5 dBi	4 dBi	6 dBi
Polarization.	Linear, Horizontal		Linear, Vertical				
Horizontal Beam width	Omni 360°						
VSWR	1.5:1 typ. 2:1 max.						
Input power, max.	30 Watt						
Input Impedance	50 Ohm						
Port to Port Isolation, typ	-40 dB						

#### Mechanical

Visible dimension (Dia x H) *	220 x 45 mm
Antenna dimension (L x W x H) **	369 x 270 x 95 mm
Weight	900 gr ± 360 Kg.
Connector	3 x N-Type, Female
Back Plane	UV Protected Polycarbonate
Radome	UV Protected Polycarbonate
Mounting	Ceiling Mounting or through 4 holes

#### Environmental

Operating Temp. Range	-40°C to +65°C
Vibration	According to IEC 60721-3-4
Water Proofing	Ordering Option
Flammability	UL94
Humidity	ETS 300 019-1-4, EN 302 085 (annex A.1.1)

## Patent Pending

Available configuration for port 1 & port 2. Other configurations available upon request.

### Ordering Options

Indoor Product Name	Outdoor Product Name (IP67)	Port 1 gain	Port 2 gain
MA-WOLTE-DP2	MA-WOLTE-DP2R	5dBi	6dBi
MA-WOLTE-DP2-5-0	MA-WOLTE-DP2-5-0R	5dBi	N/A
MA-WOLTE-DP2-2-6	MA-WOLTE-DP2-2-6R	2dBi	6dBi
MA-WOLTE-DP2-2-0	MA-WOLTE-DP2-2-0R	2dBi	N/A
MA-WOLTE-DP2-0-6	MA-WOLTE-DP2-0-6R	N/A	6dBi

(\*) Dimensions for installation inside the ceiling tile

(\*\*) Dimension for installation outside of the tile (4 screws)

**Patterns are available on our website**

MARS Antennas & RF Systems proprietary information

MARS reserves the right to make technical changes or modifications to any of its products and specifications without prior notice and without implementing such changes to prior supplied products. Product images are representative and indicative only. Warranty terms and general conditions of sale are applicable on any purchase of any product, available on MARS website.

3 Hamanor st. Holon 5886103, P.O.Box 1852 Holon 5811801, Israel

Tel: +972-3-5599661 • Fax: +972-3-5599677 • e-mail: mars@marsant.co.il • web: www.mars-antennas.com

**MA-WO7402700-5**

**740MHz - 2700MHz Multi Band Omni Directional Base Station Antenna**

MARS Dual Band Base Station Antenna provides a cost effective solution for GSM 900/1800, LTE, WLL, WLAN, ISM, WiMAX, Point-to-Point and Point-to-Multi Point applications as well as MESH networks.  
 UV protected radome suitable for harsh environment installations.  
 Antenna features stable and efficient performance with up to 6 dBi of gain.



**Specifications**

**Electrical**

Frequency range	740-960 MHz	1710-2700 MHz
GAIN, typ.	4 dBi	6 dBi
VSWR,	1.5 : 1 (typ) 2 : 1 (max)	
Polarization	Linear, Vertical	
3 dB Beam-Width, H-Plane, typ.	Omni Directional	
3 dB Beam-Width, E-Plane, typ.	35°	
Input power, max	50 Watt	
Lightning Protection	DC Grounded	
Input Impedance	50 Ohm	

**Mechanical**

Dimensions (HxDia.)	470 x 66 mm (18.5" x 2.5")
Weight	350 gr.
Connector	N-Type, Female
Radome	UV Protected Plastic
Mount	2.5" PM (End) Attachment

**Environmental**

Operating Temperature Range	-40°C to +65°C
Vibration	According to IEC 60721-3-4
Wind Load	200 km/h (survival)
Flammability	UL94
Water Proofing	IP-67
Humidity	ETS 300 019-1-4, EN 302 085 (annex A.1.1)
Salt Fog	According to IEC 68-2-11
Ice and Snow	25mm radial (survival)

MARS Antennas & RF Systems proprietary information

MARS reserves the right to make technical changes or modifications to any of its products and specifications without prior notice and without implementing such changes to prior supplied products. Product images are representative and indicative only. Warranty terms and general conditions of sale are applicable on any purchase of any product, available on MARS website.

3 Hamanor st. Holon 5886103, P.O.Box 1852 Holon 5811801, Israel

Tel: +972-3-5599661 • Fax: +972-3-5599677 • e-mail: mars@marsant.co.il • web: www.mars-antennas.com

**MA-WO2288-DB2**

**009-029 MHz & 5201-8099 MHz Dual Band OMNI Antenna**

MARS Dual Band OMNI antenna provides coverage 009-069 MHz & 5601-0099 MHz in a single antenna radome.

Additional Features:

- Simultaneous coverage of LTE & 802.11 a, b, e, g, n,
- Light weight and durable construction.
- UV protected radome.
- Indoor and Outdoor use
- Low PIM



**Specifications**

**Electrical**

Frequency range	009-069 MHz & 5601-0099 MHz
GAIN, typ.	2 dBi @ 009-069 MHz 2.5-5.8 dBi @ 5601-0099 MHz
VSWR	< 2 : 1 @ 810-945MHz & 1695-2700 MHz ; <2.5:1@ 790-960 MHz
Polarization	Linear Vertical
Horizontal Beam width	360° Omnidirectional
Vertical Beam width	70° @790-960 MHz ; 70°-30°@ 1695-2700 MHz
Passive Intermodulation(2x20W)	<-150 dBc
Input power, max.	20 Watt
Input Impedance	50 Ohm

**Mechanical**

Dimensions (HxD)	192 x 30 mm (7.5" x 1.2")
Connector	N-Type Female
Weight	95 gr.
Radom	UV Protected Plastic
Mount	One hole mounting (16 mm diameter) to surfaces of max. 6mm thickness

**Environmental**

Operating Temperature Range	-40°C to +70°C
Vibration	According to IEC 60721-3-4
Water Proofing	IP-67
Flammability	UL94
Wind Load	6N/at 150 Km/h
Humidity	ETS 300 019-1-4, EN 302 085 (annex A.1.1)

MARS Antennas & RF Systems proprietary information

MARS reserves the right to make technical changes or modifications to any of its products and specifications without prior notice and without implementing such changes to prior supplied products. Product images are representative and indicative only. Warranty terms and general conditions of sale are applicable on any purchase of any product, available on MARS website.

3 Hamanor st. Holon 5886103, P.O.Box 1852 Holon 5811801, Israel

Tel: +972-3-5599661 • Fax: +972-3-5599677 • e-mail: mars@marsant.co.il • web: www.mars-antennas.com

## MA-CR26-2X

### Multi Band Omni Antenna

MARS Multi Band Omni Antenna covers all the bands for 2G, 2.5G and 3G cellular, as well as ISM, WLAN, UNII, Bluetooth and Wi-Fi.  
 The antenna is aesthetic, small and has unobtrusive profile that blends easily with any environment.  
 The antenna is easy-installed and is highly recommended as an outstanding logistic solution for In-Building Installations.

The antenna is PIM certified, thus making it suitable for all multi-carrier systems.



### Specifications

#### Electrical

Standard	SMR, AMPS, CDMA, TDMA, GSM 900	PCS, DECT, GSM 1900, UMTS	Bluetooth, ISM, WLAN	WLL	UNII, WLL, H-LAN, Wi-Fi
Frequency range	806-960 MHz	1.71-2.17 GHz	2.3-2.7 GHz	3.4-3.7 GHz	4.9-6 GHz
GAIN, typ.	2	3-4	5	5	5-6
VSWR, max.	2 : 1	1.6 : 1	1.6 : 1	2 : 1	1.8 : 1
Polarization	Linear, Vertical				
Input power, max	50 Watt				
Input Impedance	50 Ohm				
PIM, 3 <sup>rd</sup> order, 2X20W (optional)	<-155 dBc				

#### Mechanical

Dimensions (HxWxD)	Base Diameter - 205 mm, Height - 89 mm
Weight	220 gr.
Connector	N-Type, Female
Back Plane	Aluminum; protected through chemical passivation
Radome	UV Protected Polycarbonate
Mount	Ceiling Mounting

#### Environmental

Operating Temperature Range	-40°C to +65°C
Vibration	According to IEC 60721-3-4
Flammability	UL94
Humidity	ETS 300 019-1-4, EN 302 085 (annex A.1.1)

### Ordering Options

MA-CR26-2X	Antenna Indoor
MA-CR26-2XR	Antenna Outdoor
MA-CR26-2XT	Antenna Indoor with DC Return Option
MA-CR26-2XP	Antenna Indoor PIM Certified
MA-CR26-2XRP	Antenna Outdoor PIM Certified
MA-CR26-2XTP	Antenna Indoor with DC Return Option PIM Certified

Patterns are available on our website

## Patent Pending

MARS Antennas & RF Systems proprietary information

MARS reserves the right to make technical changes or modifications to any of its products and specifications without prior notice and without implementing such changes to prior supplied products. Product images are representative and indicative only. Warranty terms and general conditions of sale are applicable on any purchase of any product, available on MARS website.

3 Hamanor st. Holon 5886103, P.O.Box 1852 Holon 5811801, Israel

Tel: +972-3-5599661 • Fax: +972-3-5599677 • e-mail: mars@marsant.co.il • web: www.mars-antennas.com



## MA-CM36-15

### Multi Band Omni Antenna

MARS Multi Band Omni Antenna covers all the bands for 2G, 2.5G and 3G cellular, as well as ISM, WLAN and Bluetooth.

The antenna is aesthetic, small and has unobtrusive profile that blends easily with any environment.

The antenna is easy-installed and is highly recommended as an outstanding logistic solution for In-Building Installations.



### Specifications

#### Electrical

Standard	SMR, AMPS, CDMA, TDMA, GSM 900	PCS, DECT, GSM 1900, UMTS	Bluetooth, ISM, WLAN
Frequency range	806-960 MHz	1.71-2.17 GHz	2.3-2.7 GHz
GAIN, typ.	2 dBi	3-4 dBi	5 dBi
VSWR, max.	2 : 1	1.5 : 1	1.6 : 1
Polarization	Linear, Vertical		
Input power, max.	50 Watt		
Input Impedance	50 Ohm		
Lightning Protection	DC Grounded		

#### Mechanical

Dimensions (HxWxD)	Base Diameter - 205 mm, Height - 89 mm
Weight	220 gr.
Connector	N-Type, Female
Back Plane	Aluminum; protected through chemical passivation
Radome	UV Protected Polycarbonate
Mount	Ceiling Mounting

#### Environmental

Operating Temperature Range	-40°C to +65°C
Vibration	According to IEC 60721-3-4
Flammability	UL94
Humidity	ETS 300 019-1-4, EN 302 085 (annex A.1.1)

### Ordering Options

MA-CM36-15	Antenna Indoor
MA-CM36-15R	Antenna Outdoor
MA-CM36-15T	Antenna Indoor with DC Return Option

Patterns are available on our website

## Patent Pending

MARS Antennas & RF Systems proprietary information

MARS reserves the right to make technical changes or modifications to any of its products and specifications without prior notice and without implementing such changes to prior supplied products. Product images are representative and indicative only. Warranty terms and general conditions of sale are applicable on any purchase of any product, available on MARS website.

3 Hamanor st. Holon 5886103, P.O.Box 1852 Holon 5811801, Israel

Tel: +972-3-5599661 • Fax: +972-3-5599677 • e-mail: mars@marsant.co.il • web: www.mars-antennas.com

## MA-WO850-5

### 830-870 MHz Omni Directional Antenna

MARS 830-870 MHz Omni-Directional Base Station Antenna provides a cost effective solution for CDMA.

MA-WO850-5 has a UV protected radome suitable for harsh environment installations.



### Specifications

#### **Electrical**

Frequency Range	830-870 MHz
GAIN,	5 dBi
VSWR, max.	1.5:1
Polarization	Linear, Vertical
3 dB Beam-Width, H-Plane, typ.	Omni – Directional 360°
3 dB Beam-Width, E-Plane, typ.	26°
Input power, max.	50 Watt
Anti-Static Protection	DC Grounded
Input Impedance	50 Ohm

#### **Mechanical**

Dimensions (HxDia.)	700 x 40 mm
Weight	400 gr.
Connector	N-Type, Female
Radome	UV Protected Plastic
Mounting Brackets/Clamps	Aluminum Protected Through Chemical Passivation

#### **Environmental**

Operating Temperature Range	-30°C to +70°C
Vibration	According to IEC 60721-3-4
Wind Load	200 km/h (survival)
Flammability	UL94
Water Proofing	IP-65
Humidity	ETS 300 019-1-4, EN 302 085 (annex A.1.1)

MARS Antennas & RF Systems proprietary information

MARS reserves the right to make technical changes or modifications to any of its products and specifications without prior notice and without implementing such changes to prior supplied products. Product images are representative and indicative only. Warranty terms and general conditions of sale are applicable on any purchase of any product, available on MARS website.

3 Hamanor st. Holon 5886103, P.O.Box 1852 Holon 5811801, Israel

Tel: +972-3-5599661 • Fax: +972-3-5599677 • e-mail: mars@marsant.co.il • web: www.mars-antennas.com

## MA-WO91-8X

### 902-928 MHz Omni-Directional Antenna

MARS ISM Omni - Directional Antenna is a ruggedized model suitable for outdoor installations on end of tower / spike poles.

UV protected radome allowing harsh environment installations.

Antenna features stable and efficient performance with 8 dBi of gain.



### Specifications:

#### *Electrical*

Frequency range	902-928 MHz
GAIN, min.	8 dBi
VSWR, max.	2 : 1
Polarization	Linear, Vertical
3 dB Beam-Width, H-Plane, typ.	Omni directional
3 dB Beam-Width, E-Plane, typ.	14°
Input power, max.	10 Watt
Input Impedance	50 Ohm

#### *Mechanical*

Dimensions (HxDiameter)	1350 x 64 mm (53" x 2.5")
Weight	900 gr.
Connector	N-Type, Female
Back Plane	Aluminum; protected through chemical passivation
Radome	UV Protected Plastic
Mount	2.5" Pole Mount Attachment

#### *Environmental*

Operating Temperature Range	-40°C to +65°C
Vibration	According to IEC 60721-3-4
Wind Load	200 km/h (survival)
Flammability	UL94
Water Proofing	IP-65
Humidity	ETS 300 019-1-4, EN 302 085 (annex A.1.1)
Salt Fog	According to IEC 68-2-11
Ice and Snow	25mm radial (survival)

Patterns are available on our website

MARS Antennas & RF Systems proprietary information

MARS reserves the right to make technical changes or modifications to any of its products and specifications without prior notice and without implementing such changes to prior supplied products. Product images are representative and indicative only. Warranty terms and general conditions of sale are applicable on any purchase of any product, available on MARS website.

3 Hamanor st. Holon 5886103, P.O.Box 1852 Holon 5811801, Israel

Tel: +972-3-5599661 • Fax: +972-3-5599677 • e-mail: mars@marsant.co.il • web: www.mars-antennas.com

## MA-WO25-DP10

### 2.3-2.7 GHz Dual Polarization Omni Directional Antenna

MARS 2.3-2.7 GHz Dual Polarization Omni Directional Antenna provides a stable and efficient performance with 9-10dBi of gain and cost effective solution for large scale applications and systems such as 802.11, Point-to-multi-point, WLAN access points, ISM, WiMAX and more.

The Elevation Patterns without any deviation from the horizon in full band



### Specifications

#### Electrical

Frequency range	2.3 -2.7 GHz
GAIN, typ.	Vertical Polarization @ 9 dBi ; Horizontal Polarization @10 dBi
VSWR, max.	2 : 1
Polarization	Dual Pole Vertical & Horizontal
3 dB Beam-Width Azimuth, typ.	Omni – Directional
3 dB Beam-Width Elevation, typ.	11°
Port to Port Isolation, typ.	-35 dB
Input power, max.	10 Watt
Input Impedance	50 Ohm
Lightning Protection	DC Grounded

#### Mechanical

Dimensions (H x Dia.)	640 x 110 mm
Weight	1.2 Kg.
Connector	2 x N-Type Female
Radome	UV Protected Plastic
Mount	2" Pole Mount

#### Environmental

Operating Temp. Range	-40°C to +65°C
Vibration	According to IEC 60721-3-4
Flammability	UL94
Humidity	ETS 300 019-1-4, EN 302 085 (annex A.1.1)
Water Proofing	IP-65
Wind Load	200 km/h (survival)

MARS Antennas & RF Systems proprietary information

MARS reserves the right to make technical changes or modifications to any of its products and specifications without prior notice and without implementing such changes to prior supplied products. Product images are representative and indicative only. Warranty terms and general conditions of sale are applicable on any purchase of any product, available on MARS website.

3 Hamanor st. Holon 5886103, P.O.Box 1852 Holon 5811801, Israel

Tel: +972-3-5599661 • Fax: +972-3-5599677 • e-mail: mars@marsant.co.il • web: www.mars-antennas.com

## MA-WO25-9

### 2.3-2.7 GHz Omni – Directional Base Station Antenna

MARS 2.4 GHz Base Station Antenna provides a cost effective solution for large scale WLL, WLAN, ISM and Point-to-Multi Point applications. UV protected radome suitable for harsh environment installations. Antenna features stable and efficient performance with 9 dBi of gain.



## Specifications

### Electrical

Frequency range	2.3-2.7 GHz
GAIN, typ.	9 dBi
VSWR, max.	2 : 1
Polarization	Linear, Vertical
3 dB Beam-Width, H-Plane, typ.	Omni - Directional
3 dB Beam-Width, E-Plane, typ.	10°
Input power, max.	50 Watt
Input Impedance	50 Ohm

### Mechanical

Dimensions (HxDia.)	640 x 76mm (25" x 3")
Weight	660 gr.
Connector	N-Type, Female
Radome	UV Protected Plastic
Mount	Pole Mount

### Environmental

Operating Temperature Range	-40°C to +65°C
Vibration	According to IEC 60721-3-4
Wind Load	200 km/h (survival)
Flammability	UL94
Water Proofing	IP-67
Humidity	ETS 300 019-1-4, EN 302 085 (annex A.1.1)
Salt Fog	According to IEC 68-2-11
Ice and Snow	25mm radial (survival)

## Ordering Options

MA-WO25-9	Antenna suited for pole mount
MA-WO25-9S	Antenna heavy duty suited for pole mount

Patterns are available on our website

MARS Antennas & RF Systems proprietary information

MARS reserves the right to make technical changes or modifications to any of its products and specifications without prior notice and without implementing such changes to prior supplied products. Product images are representative and indicative only. Warranty terms and general conditions of sale are applicable on any purchase of any product, available on MARS website.

3 Hamanor st. Holon 5886103, P.O.Box 1852 Holon 5811801, Israel

Tel: +972-3-5599661 • Fax: +972-3-5599677 • e-mail: mars@marsant.co.il • web: www.mars-antennas.com

## MA-WO25-9H

### 2.3 – 2.7 GHz Horizontal Omni Directional

MARS Horizontal polarized Omni Directional antenna provides coverage of 2.3-2.7 GHz with a stable and efficient performance of 10dBi gain.

MARS MA-WO25-9H provides a cost effective solution for large-scale applications and systems such as 802.11b/g, Point-to-multi-point, WLAN access points, WiMAX and more.

MARS Horizontal Omni Directional polarized antenna offers polarization rejection of interference of vertically polarized signals, as used in most WLAN systems.

Main Features:

- Horizontally polarized
- High gain.
- Lightweight and durable construction.
- UV protected radome suitable for harsh environment installations.



### Specifications

#### Electrical

Frequency range	2.3 - 2.7 GHz
GAIN, typ.	10 dBi
VSWR	2 : 1 max. 1.7 : 1 typ.
Polarization	Linear, Horizontal
3 dB Beam-Width Azimuth, typ.	Omni - Directional
3 dB Beam-Width Elevation, typ.	11°
Input power, max.	10 Watt
Input Impedance	50 Ohm
Lightning Protection	DC Grounded

#### Mechanical

Dimensions (L x Ø)	640 x 76 mm
Weight	750 gr.
Connector	N-Type Female
Radome	UV Protected Plastic
Mount	2" Pole Mount

#### Environmental

Operating Temp. Range	-40°C to +65°C
Vibration	According to IEC 60721-3-4
Flammability	UL94
Humidity	ETS 300 019-1-4, EN 302 085 (annex A.1.1)
Water Proofing	IP-65
Wind Load	200 km/h (survival)

Mars Antennas & RF Systems proprietary information

MARS reserves the right to make technical changes or modifications to any of its products and specifications without prior notice and without implementing such changes to prior supplied products. Product images are representative and indicative only. Warranty terms and general conditions of sale are applicable on any purchase of any product, available on MARS website.

3 Hamanor st. Holon 58861, P.O.Box 5 AZOR 58008, Israel

Tel: +972-3-5599661 • Fax: +972-3-5599677 • e-mail: mars@marsant.co.il • web: www.mars-antennas.com

## MA-WO24-DP6

### 2.4 – 2.5 GHz Dual Pole Omni Directional Antenna

MARS 2.4-2.5 GHz Dual Polarization Omni Directional Antenna provides a stable and efficient performance with 10dBi of gain and cost effective solution for large scale applications and systems such as 802.11, Point-to-multi-point, WLAN access points, ISM, WiMAX and more.

The Elevation Patterns without any deviation from the horizon in full band

Very high Isolation between 2 or more antennas when installed Horizontally.



### Specifications

#### **Electrical**

Frequency range	2.4 -2.5 GHz
GAIN, typ.	10 dBi
VSWR, max.	1.8:1
Polarization	Dual Pole, Vertical & Horizontal
3 dB Beam-Width Azimuth, typ.	Omni - Directional
3 dB Beam-Width Elevation, typ.	13°
Down Tilt, typ.	12°
Horizon Isolation, typ.	-30 dB
Port to Port Isolation, typ.	-30 dB
Input power, max.	10 Watt
Input Impedance	50 Ohm
Lightning Protection	DC Grounded

#### **Mechanical**

Dimensions (H x Dia.)	640 x 112 mm
Weight	1.2 kg
Connector	2 x N-Type Female
Radome	UV Protected Plastic
Mount	2" Pole Mount

#### **Environmental**

Operating Temp. Range	-40°C to +65°C
Vibration	According to IEC 60721-3-4
Flammability	UL94
Humidity	ETS 300 019-1-4, EN 302 085 (annex A.1.1)
Water Proofing	IP-65
Wind Load	200 km/h (survival)

MARS Antennas & RF Systems proprietary information

MARS reserves the right to make technical changes or modifications to any of its products and specifications without prior notice and without implementing such changes to prior supplied products. Product images are representative and indicative only. Warranty terms and general conditions of sale are applicable on any purchase of any product, available on MARS website.

3 Hamanor st. Holon 5886103, P.O.Box 1852 Holon 5811801, Israel

Tel: +972-3-5599661 • Fax: +972-3-5599677 • e-mail: mars@marsant.co.il • web: www.mars-antennas.com

## MA-WO36-DP10

### 3.3 - 3.8 GHz Dual Pol Omni Directional Antenna

MARS 3.3-3.8 GHz Dual Polarization Omni Directional Antenna provides a stable and efficient performance with 9-10dBi of gain and cost effective solution for large scale applications and systems such as 802.11, Point-to-multi-point, WLAN access points, ISM, WiMAX and more.

There is no deviation from the horizon in the elevation patterns across the entire band.



### Specifications

#### Electrical

Frequency range	3.3-3.8 GHz
GAIN, typ.	Vertical Polarization @ 9dBi Horizontal Polarization @ 10dBi
VSWR, max.	2 : 1
Polarization	Dual Pole
3 dB Beam-Width Azimuth, typ.	Omni – Directional
3 dB Beam-Width Elevation, typ.	11°
Port to Port Isolation, typ.	-30 dB
Input power, max.	10 Watt
Input Impedance	50 Ohm
Lightning Protection	DC Grounded

#### Mechanical

Dimensions (H x Dia.)	485 x 85 mm (19.1" x 3.35")
Weight	600 gr.
Connector	2 x N-Type Female
Radome	UV Protected Plastic
Mount	2" Pole Mount

#### Environmental

Operating Temp. Range	-40°C to +65°C
Vibration	According to IEC 60721-3-4
Flammability	UL94
Humidity	ETS 300 019-1-4, EN 302 085 (annex A.1.1)
Water Proofing	IP-65
Wind Load	200 km/h (survival)

MARS Antennas & RF Systems proprietary information

MARS reserves the right to make technical changes or modifications to any of its products and specifications without prior notice and without implementing such changes to prior supplied products. Product images are representative and indicative only. Warranty terms and general conditions of sale are applicable on any purchase of any product, available on MARS website.

3 Hamanor st. Holon 5886103, P.O.Box 1852 Holon 5811801, Israel

Tel: +972-3-5599661 • Fax: +972-3-5599677 • e-mail: mars@marsant.co.il • web: www.mars-antennas.com



**MA-WO56-DP10**  
**4.9-5.9 GHz Dual Polarization Omni Directional Antenna**

MARS 4.9-5.9GHz Dual Polarization Omni Directional Antenna provides a cost effective solution for large scale WLL, WLAN, ISM and Point-to-Multi Point applications. UV protected radome suitable for harsh environment installations. Antenna features stable performance with exceptional 10 dBi of gain.

Applications:

- MESH Networks.
- Point-to-Point Applications.



**Specifications**

**Electrical**

Frequency range	4.9 - 5.9 GHz
GAIN, typ.	4.9-5.1 GHz Vertical @ 8dBi & Horizontal @ 10dBi 5.1-5.9 GHz Vertical & Horizontal @ 10dBi
VSWR, 1.7 : 1 typ.	4.9-5.1 @ 2.5:1 max. 5.1-5.9 @ 2: 1 max.
Polarization Dual Pole	Vertical & Horizontal
3 dB Beam-Width, Azimuth, typ.	Omni - Directional
3 dB Beam-Width, Elevation, typ.	11°
Port to Port Isolation	-30 dB typ. -20 dB min.
Input power, max.	10 Watt
Lightning Protection	DC Grounded
Input Impedance	50 Ohm

**Mechanical**

Dimensions (HxDia.)	355 x 66 mm
Weight	370 gr.
Connector	2 X N-Type, Female
Radome	UV Protected Polycarbonate
Mount	2" Pole Mount

**Environmental**

Operating Temperature Range	-40°C to +65°C
Vibration	According to IEC 60721-3-4
Wind Load	200 km/h (survival)
Flammability	UL94
Water Proofing	IP-67
Humidity	ETS 300 019-1-4, EN 302 085 (annex A.1.1)
Salt Fog	According to IEC 68-2-11

MARS Antennas & RF Systems proprietary information

MARS reserves the right to make technical changes or modifications to any of its products and specifications without prior notice and without implementing such changes to prior supplied products. Product images are representative and indicative only. Warranty terms and general conditions of sale are applicable on any purchase of any product, available on MARS website.

3 Hamanor st. Holon 5886103, P.O.Box 1852 Holon 5811801, Israel

Tel: +972-3-5599661 • Fax: +972-3-5599677 • e-mail: mars@marsant.co.il • web: www.mars-antennas.com

## MA-DBO2458-6

### 2.3-2.7 GHz & 4.9-6.0 GHz Dual Band Omni Antenna

MARS Dual Band Omni antenna provides coverage of 2.3 to 2.7 GHz & 4.9 to 6.0 GHz in a single antenna radome.

Additional Features:

- Simultaneous coverage of LTE & 802.11 a, b, e, g, n, WiMAX & 4.9 GHz Public Safety Bands.
- Light weight and durable construction.
- UV protected radome.



### Specifications

#### Electrical

Frequency range	2.3-2.7 GHz & 4.9-6.0 GHz
GAIN, typ.	4 dBi @ 2.3-2.7 GHz 5 dBi @ 2.4-2.5 GHz 7 dBi @ 4.9-6.0 GHz
VSWR, max.	2 : 1
Polarization	Linear Vertical
Input power, max.	10 Watt
Input Impedance	50 Ohm

#### Mechanical

Dimensions (HxDia.)	210 x 28.5 mm (8.3" x 1.1")
Connector	See Ordering Options
Weight	90 gr.
Radom	UV Protected Plastic
Mount	See Ordering Options

#### Environmental

Operating Temperature Range	-40°C to +70°C
Vibration	According to IEC 60721-3-4
Water Proofing	IP-67
Flammability	UL94
Humidity	ETS 300 019-1-4, EN 302 085 (annex A.1.1)

### Ordering Options

MA-DBO2458-6	Antenna with RP N-Type Plug connector
MA-DBO2458-6NF	Antenna with N-Type Female connector
MA-DBO2458-6NM	Antenna with N-Type Male connector
MA-DBO2458-6NF1	Antenna with N-Type Female connector with mount

Patterns are available on our website

MARS Antennas & RF Systems proprietary information

MARS reserves the right to make technical changes or modifications to any of its products and specifications without prior notice and without implementing such changes to prior supplied products. Product images are representative and indicative only. Warranty terms and general conditions of sale are applicable on any purchase of any product, available on MARS website.

3 Hamanor st. Holon 5886103, P.O.Box 1852 Holon 5811801, Israel

Tel: +972-3-5599661 • Fax: +972-3-5599677 • e-mail: mars@marsant.co.il • web: www.mars-antennas.com

## MA-DBO-3H

### 2.3-2.7 GHz & 4.9-6.1 GHz Dual Band 3X3 MIMO Omni Antenna

MARS Dual Band Omni antenna provides coverage of 2.3 to 2.7 GHz & 4.9 to 6.1 GHz in a single antenna radome.

Additional Features:

- Simultaneous coverage of LTE, 802.11 a, b, e, g, n, WiMAX & 4.9 GHz Public Safety Bands.
- Light weight and durable construction.
- UV protected radome made of polycarbonate.



### Specifications

#### Electrical

Frequency range	2.3-2.7 GHz & 4.9-6.1 GHz
GAIN, typ.	2.3-2.7 GHz @ 3 x 2.5 dBi (without cable) 4.9-6.1 @ 3 x 3.5 dBi (without cable)
VSWR, max.	2 : 1 (typ. 1.5:1)
Polarization	Linear Vertical
Input power, max.	20 Watt
Input Impedance	50 Ohm

#### Mechanical

Dimensions (W x L x H)	200 x 200 x 33 mm (7.9" x 7.9" x 1.25")
Connector	See ordering options
Weight	400 gr.
Back Plane	Aluminum; protected through chemical passivation
Radome	UV Protected Polycarbonate
Mount	See ordering options

#### Environmental

Operating Temperature Range	-40°C to +70°C
Vibration	According to IEC 60721-3-4
Water Proofing	IP-67
Flammability	UL94
Humidity	ETS 300 019-1-4, EN 302 085 (annex A.1.1)

### Ordering Options

MA-DBO-3H	Antenna 3 x Coaxial Cable RG 316 with RPSMA Male Right Angle suited for optional ceiling mount MNT-4CL
MA-DBO-3HB	Antenna 3 x Coaxial Cable RG 316 with RPSMA Male Right Angle with MNT-4CL mount
MA-DBO-3H2	Antenna 3x Coaxial Cable RG 316 with N-Type male suited for optional ceiling mount MNT-4CL
MA-DBO-3H2B	Antenna 3x Coaxial Cable RG 316 with N-Type male with MNT-4CL mount

Patterns are available on our website

MARS Antennas & RF Systems proprietary information

MARS reserves the right to make technical changes or modifications to any of its products and specifications without prior notice and without implementing such changes to prior supplied products. Product images are representative and indicative only. Warranty terms and general conditions of sale are applicable on any purchase of any product, available on MARS website.

3 Hamanor st. Holon 5886103, P.O.Box 1852 Holon 5811801, Israel

Tel: +972-3-5599661 • Fax: +972-3-5599677 • e-mail: mars@marsant.co.il • web: www.mars-antennas.com

**MA-DBO-3MIMO**

**2.3-2.7 GHz & 4.9-6 GHz Omni Dual Band MIMO Applications Antenna**

MARS Dual Band MIMO Omni antenna provides coverage of 2.3 to 2.7 GHz & 4.9 to 6 GHz in a single antenna radome.



**Specifications**

**Electrical**

Frequency range	2.3-2.7 GHz & 4.9-6GHz
GAIN, typ.	2.3-2.7 GHz @ 3 x 4 dBi 4.9-6 GHz @ 3 x 7 dBi
VSWR, max.	2 : 1
Patterns.	Omni Directional
Port to Port Isolation.typ	-20 dB
Input power, max.	20 Watt
Input Impedance	50 Ohm

**Mechanical**

Dimensions (DxH)	205 x 330 mm
Connector	3 x N-Type Female
Weight	1.5 Kg.
Back Plane	Aluminium; protected through chemical passivation
Radome	UV Protected Plastic
Mount	Pole Mount

**Environmental**

Operating Temperature Range	-40°C to +70°C
Vibration	According to IEC 60721-3-4
Flammability	UL94
Water Proofing	IP-65
Humidity	ETS 300 019-1-4, EN 302 085 (annex A.1.1)

MARS Antennas & RF Systems proprietary information

MARS reserves the right to make technical changes or modifications to any of its products and specifications without prior notice and without implementing such changes to prior supplied products. Product images are representative and indicative only. Warranty terms and general conditions of sale are applicable on any purchase of any product, available on MARS website.

3 Hamanor st. Holon 5886103, P.O.Box 1852 Holon 5811801, Israel

Tel: +972-3-5599661 • Fax: +972-3-5599677 • e-mail: mars@marsant.co.il • web: www.mars-antennas.com

## MA-WO36-10N

### 3.3-3.8 GHz Omni Directional Base Station Antenna

MARS 3.5 GHz Base Station Antenna provides a cost effective solution for large scale LTE, WLL, WLAN, ISM, WiMAX, Point-to-Multi Point Systems and MESH Networks licensed applications.

UV protected radome suitable for harsh environment installations.

Antenna features stable performance with up to 9.5 dBi of gain.



### Specifications

#### Electrical

Frequency range	3.3-3.8 GHz
GAIN, typ.	9.5 dBi @ 3.4-3.8 GHz 9 dBi @ 3.3-3.4 GHz
VSWR, max.	2 : 1
Polarization	Linear, Vertical
3 dB Beam-Width, H-Plane, typ.	Omni Directional
3 dB Beam-Width, E-Plane, typ.	10°
Input power, max	50 Watt
Input Impedance	50 Ohm

#### Mechanical

Dimensions (HxDia.)	470 x 66 mm (18.5" x 2.5")
Weight	350 gr.
Connector	N-Type, Female
Radome	UV Protected Polycarbonate
Mount	2.5" PM (End) Attachment

#### Environmental

Operating Temperature Range	-40°C to +65°C
Vibration	According to IEC 60721-3-4
Wind Load	200 km/h (survival)
Flammability	UL94
Water Proofing	IP-67
Humidity	ETS 300 019-1-4, EN 302 085 (annex A.1.1)
Salt Fog	According to IEC 68-2-11
Ice and Snow	25mm radial (survival)

Patterns are available on our website

MARS Antennas & RF Systems proprietary information

MARS reserves the right to make technical changes or modifications to any of its products and specifications without prior notice and without implementing such changes to prior supplied products. Product images are representative and indicative only. Warranty terms and general conditions of sale are applicable on any purchase of any product, available on MARS website.

3 Hamanor st. Holon 5886103, P.O.Box 1852 Holon 5811801, Israel

Tel: +972-3-5599661 • Fax: +972-3-5599677 • e-mail: mars@marsant.co.il • web: www.mars-antennas.com

## MA-WO55-MIMO9NH3

### 4.9-5.875 GHz MIMO Omni - Directional Base Station Antenna

MARS MIMO Omni antenna provides coverage of 4.9-5.875 GHz in a single antenna radome.

Additional Features:

- High gain.
- Light weight and durable construction.
- UV protected radome made of plastic.



## Specifications

### Electrical

Frequency range	4.9-5.875 GHz
GAIN, typ.	3 x 9 dBi
VSWR, max.	2 : 1
Polarization	Linear Vertical
3 dB Beam-Width, H-Plane, typ.	Omni - Directional
3 dB Beam-Width, E-Plane, typ.	10°
Input power, max.	50 Watt
Input Impedance	50 Ohm

### Mechanical

Dimensions (DxH)	205 x 330 mm
Connector	3 x N-Type, Female
Weight	600 gr.
Radome	UV Protected Plastic
Mount	Pole Mount

### Environmental

Operating Temperature Range	-40°C to +65°C
Vibration	According to IEC 60721-3-4
Wind Load	200 km/h (survival)
Flammability	UL94
Water Proofing	IP-65
Humidity	ETS 300 019-1-4, EN 302 085 (annex A.1.1)
Salt Fog	According to IEC 68-2-11
Ice and Snow	25mm radial (survival)

Patterns are available on our website

MARS Antennas & RF Systems proprietary information

MARS reserves the right to make technical changes or modifications to any of its products and specifications without prior notice and without implementing such changes to prior supplied products. Product images are representative and indicative only. Warranty terms and general conditions of sale are applicable on any purchase of any product, available on MARS website.

3 Hamanor st. Holon 5886103, P.O.Box 1852 Holon 5811801, Israel

Tel: +972-3-5599661 • Fax: +972-3-5599677 • e-mail: mars@marsant.co.il • web: www.mars-antennas.com

## MA-WO55-10NH

### 4.9-5.875 GHz Omni – Directional Base Station Antenna

MARS 5.8 GHz Base Station Antenna provides a cost effective solution for large scale WLL, WLAN, ISM and Point-to-Multi Point applications.

UV protected radome suitable for harsh environment installations.

Antenna features stable performance with exceptional 10 dBi of gain.

Applications:

- MESH Networks.
- Point-to-Point Applications.



## Specifications

### Electrical

Frequency range	4.9-5.875 GHz
GAIN, typ.	10 dBi
VSWR, max.	4.9-5.15 GHz @ 2 : 1 5.15-5.875 GHz @ 1.8 : 1
Polarization	Linear, Vertical
3 dB Beam-Width, H-Plane, typ.	Omni - Directional
3 dB Beam-Width, E-Plane, typ.	10°
Input power, max.	10 Watt
Input Impedance	50 Ohm

### Mechanical

Dimensions (HxDia.)	315 x 40 mm (12.4" x 1.6")
Weight	210 gr.
Connector	N-Type, Female / N-Type, Male (optional)
Radome	UV Protected Polycarbonate
Mount	2" PM (End) Attachment

### Environmental

Operating Temperature Range	-40°C to +65°C
Vibration	According to IEC 60721-3-4
Wind Load	200 km/h (survival)
Flammability	UL94
Water Proofing	IP-67
Humidity	ETS 300 019-1-4, EN 302 085 (annex A.1.1)
Salt Fog	According to IEC 68-2-11
Ice and Snow	25mm radial (survival)

## Ordering Options

MA-WO55-10NH	Antenna with N-Type, Female Connector
MA-WO55-10NHM	Antenna with N-Type, Male Connector

Patterns are available on our website

MARS Antennas & RF Systems proprietary information

MARS reserves the right to make technical changes or modifications to any of its products and specifications without prior notice and without implementing such changes to prior supplied products. Product images are representative and indicative only. Warranty terms and general conditions of sale are applicable on any purchase of any product, available on MARS website.

3 Hamanor st. Holon 5886103, P.O.Box 1852 Holon 5811801, Israel

Tel: +972-3-5599661 • Fax: +972-3-5599677 • e-mail: mars@marsant.co.il • web: www.mars-antennas.com

## MA-WO56-10H

### 5.1-5.9 GHz Horizontal Omni Directional Antenna

MARS 5.1-5.9GHz Horizontal Omni Directional Antenna provides a cost effective solution for large scale WLL, WLAN, ISM and Point-to-Multi Point applications.

UV protected radome suitable for harsh environment installations.

Antenna features stable performance with exceptional 10 dBi of gain.

Applications:

- MESH Networks.
- Point-to-Point Applications.



## Specifications

### Electrical

Frequency range	5.1 -5.9 GHz
GAIN, typ.	10 dBi
VSWR, max.	2 : 1
Polarization	Linear, Horizontal
3 dB Beam-Width, H-Plane, typ.	Omni - Directional
3 dB Beam-Width, E-Plane, typ.	11°
Input power, max.	10 Watt
Input Impedance	50 Ohm
Lightning Protection	DC Grounded

### Mechanical

Dimensions (HxDia.)	315 x 40 mm (12.4" x 1.6")
Weight	210 gr.
Connector	N-Type, Female
Radome	UV Protected Polycarbonate
Mount	2" Pole Mount

### Environmental

Operating Temperature Range	-40°C to +65°C
Vibration	According to IEC 60721-3-4
Wind Load	200 km/h (survival)
Flammability	UL94
Water Proofing	IP-67
Humidity	ETS 300 019-1-4, EN 302 085 (annex A.1.1)
Salt Fog	According to IEC 68-2-11
Ice and Snow	25mm radial (survival)

MARS Antennas & RF Systems proprietary information

MARS reserves the right to make technical changes or modifications to any of its products and specifications without prior notice and without implementing such changes to prior supplied products. Product images are representative and indicative only. Warranty terms and general conditions of sale are applicable on any purchase of any product, available on MARS website.

3 Hamanor st. Holon 5886103, P.O.Box 1852 Holon 5811801, Israel

Tel: +972-3-5599661 • Fax: +972-3-5599677 • e-mail: mars@marsant.co.il • web: www.mars-antennas.com



## Indoor / DAS

Part Number	Description	Frequency band	Gain	Polarization	Dimension	Antenna type	Page
MA-CQ26-1X	380 MHz -6 GHz Multi Band Omni	380-806 MHz 806-960 MHz 1395-1432 MHz 1710-2170 MHz 2300-2500 MHz 3300-3700 MHz 4900-6000 MHz	1 (2*) dBi 4 dBi 5 dBi 5 dBi 5 dBi 6 dBi	Linear, Vertical	Base Dia. - 275 Height - 187 mm	Indoor / DAS	07-2
MA-CQ27-1X	380 MHz -6 GHz Multi Band Omni	380-806 MHz 806-960 MHz 1395-1432 MHz 1710-2170 MHz 2300-2700 MHz 3300-3700 MHz 4900-6000 MHz	1 (2*) dBi 4 dBi 5 dBi 5 dBi 6 dBi 6 dBi 6 dBi	Linear, Vertical	Base Dia. - 275 Height - 187 mm	Indoor / DAS	07-3
MA-CQ29-1X	380 MHz -6 GHz Multi Band Omni	380-806 MHz 806-960 MHz 1700-2500 MHz 2500-2700 MHz 3300-3700 MHz 4900-6000 MHz	1 (2*) dBi 4 dBi 5 dBi 5 dBi 6 dBi 6 dBi	Linear, Vertical	Base Dia. - 275 Height - 187 mm	Indoor / DAS	07-4
MA-WA43-1X	In-Building Panel	425-445 MHz	4 dBi	Linear, Vertical	225 x 215 x 29 mm	Indoor / DAS	01-22
MA-WA46-1X	In-Building Panel	450-470 MHz	4 dBi	Linear, Vertical	231 x 215 x 29 mm	Indoor / DAS	01-23
MA-WOLTE-3X	LTE, GSM, UMTS, WLAN, Wi-Fi Multi Band Omni	698-806 MHz 806-960 MHz 1710-2170 MHz 2300-2700 MHz 3300-3800 MHz 4900-6500 MHz	2 dBi 2 dBi 3-4 dBi 5 dBi 4 dBi 6 dBi	Linear, Vertical	Base Dia. - 205 Height - 89 mm	Indoor / DAS	07-6
MA-WOLTE-3M1	698-6500 MHz Multi Band Tri-Ports Omni	<b>Port 1 &amp; 2</b> 698-960 MHz 1710-2170 MHz 2.3-2.7 GHz. 3.3-3.8 GHz 4.9- 6.5 GHz <b>Port 3</b> 1710-2170 MHz 2.3-2.7 GHz 3.3-3.8 GHz 4.9- 6.5 GHz	2 dBi 3-4 dBi 5 dBi 4 dBi 6 dBi 3 dBi 3 dBi 4 dBi 6 dBi	Linear, Vertical	Antenna dimension (D,H): 220 x 95 mm  Base dimension (L,W,H): 369 x 270 x 30 mm	Indoor / DAS	07-7
MA-WOLTE-DP1	698-6500 MHz Multi Band Dual Polarized Omni	<b>Vertical</b> 698-960 MHz 1710-2170 MHz 2.3-2.7 GHz 3.3-3.8 GHz 4.9- 6.5 GHz <b>Horizontal</b> 2.3-2.7 GHz 4.9- 5.875 GHz	4 dBi 5 dBi 5.5 dBi 7 dBi 7.5 dBi 5 dBi 5 dBi	Linear, Vertical	Base Diameter 275 mm  Height 190 mm	Indoor / DAS	07-8
MA-CLTE-14	LTE, GSM, UMTS, WLAN, Wi-Fi Multi Band Panel	698-806 MHz 806-960 MHz 1710-2170 MHz 2200-2700 MHz	5 dBi 6 dBi 6.5 dBi 5 dBi	Mixed, Vertical and Horizontal	231 x 215 x 37.5 mm	Indoor / DAS	01-24
MA-WOLTE-DP2	698-6500 MHz Multi Band Tri-Ports Omni	<b>Port 1</b> 1.7-2.7 GHz <b>Port 2</b> 4.4-6.6 GHz <b>Port 3</b> 698-960 MHz 1.7-2.3 GHz 2.3-2.7 GHz. 3.3-3.8 GHz 4.5- 6.6 GHz	5 dBi 6 dBi 4 dBi 3-4 dBi 5.5 dBi 4 dBi 6 dBi	Linear, Horizontal  Linear, Horizontal  Linear, Vertical	Antenna dimension (D,H): 220 x 95 mm  (Stand out from the ceiling)	Indoor / DAS	07-9

MARS Antennas & RF Systems proprietary information

MARS reserves the right to make technical changes or modifications to any of its products and specifications without prior notice and without implementing such changes to prior supplied products. Product images are representative and indicative only. Warranty terms and general conditions of sale are applicable on any purchase of any product, available on MARS website.

3 Hamanor st. Holon 5886103, P.O.Box 1852 Holon 5811801, Israel

Tel: +972-3-5599661 • Fax: +972-3-5599677 • e-mail: mars@marsant.co.il • web: www.mars-antennas.com

Part Number	Description	Frequency band	Gain	Polarization	Dimension	Antenna type	Page
MA-CR26-2X	Multi Band Omni	806-960 MHz 1710-2170 MHz 2300-2700 MHz 3400-3700 MHz 4900-6000 MHz	2 dBi 3-4 dBi 5 dBi 5 dBi 5-6 dBi	Linear, Vertical	Base Dia. - 205 Height - 89 mm	Indoor / DAS	07-12
MA-CM36-15	Multi Band Omni	806-960 MHz 1710-2170 MHz 2300-2700 MHz	2 dBi 3-4 dBi 5 dBi	Linear, Vertical	Base Dia. - 205 Height - 89 mm	Indoor / DAS	07-13
MA-CL67-15	GSM, UMTS, WLAN Multi Band Panel	806-960 MHz 1710-2170 MHz 2200-2700 MHz	8.5 dBi 7.5-10 dBi 5-6.5 dBi	Linear, Vertical	231 x 215 x 37.5 mm	Indoor / DAS	01-25
MA-CN14-11	Multi Band 140°	806-960 MHz 1710-2170 MHz	5 dBi	Linear, Vertical	175 x 35 x 125 mm	Indoor / DAS	01-26
MA-CC60-60	Dual Beam GSM	870-960 MHz 2.4-2.5 GHz	3.5 dBi 4.5 dBi	Linear, Vertical	184 x 100 x 125 mm	Indoor / DAS	01-27

MARS Antennas & RF Systems proprietary information

MARS reserves the right to make technical changes or modifications to any of its products and specifications without prior notice and without implementing such changes to prior supplied products. Product images are representative and indicative only. Warranty terms and general conditions of sale are applicable on any purchase of any product, available on MARS website.

3 Hamanor st. Holon 5886103, P.O.Box 1852 Holon 5811801, Israel

Tel: +972-3-5599661 • Fax: +972-3-5599677 • e-mail: mars@marsant.co.il • web: www.mars-antennas.com

## Mobile

Part Number	Description	Frequency band	Gain	Polarization	Dimension	Antenna type	Page
MA-VMB-5	Multi Band Blade Antenna for Mobile Applications	698-6500 MHz	2-6 dBi	Linear, Vertical	169 x 85 x 88 mm	Mobile	09-1
MA-VM1765-5	Wide Band Blade Antenna for Mobile Applications	1.7-6.5 GHz	6 dBi (typ.)	Linear, Vertical	132 x 79 x 76 mm	Mobile	09-2
MA-VM1765-5S	Wide Band Blade Antenna for Mobile Applications	1.7-6.5 GHz	6 dBi (typ.)	Linear, Vertical	132 x 79 x 76 mm.	Mobile	09-3
MA-DBO2455-3	Dual Band Omni WiMAX Antenna	2.3-2.6 GHz 4.9-6.4 GHz	2 dBi 4 dBi	Linear Vertical	50 (D) x 34 (H) mm	Mobile	09-4

MARS Antennas & RF Systems proprietary information

MARS reserves the right to make technical changes or modifications to any of its products and specifications without prior notice and without implementing such changes to prior supplied products. Product images are representative and indicative only. Warranty terms and general conditions of sale are applicable on any purchase of any product, available on MARS website.

3 Hamanor st. Holon 5886103, P.O.Box 1852 Holon 5811801, Israel

Tel: +972-3-5599661 • Fax: +972-3-5599677 • e-mail: mars@marsant.co.il • web: www.mars-antennas.com

## MA-VMB-5

### 698 MHz–6.5 GHz Multi Band Blade Antenna for Mobile Applications

MARS Blade Antenna is a ruggedized, aerodynamic antenna, for use in mobile applications such as trains, helicopters, buses or cars.

Antenna comes in two versions:

- Fixed Mount (Roof top)
- Magnetic Mount

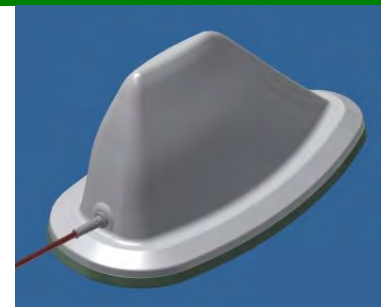

### Specifications

#### Electrical

Standard	LTE	SMR, AMPS, CDMA, TDMA, GSM 900	PCS, DECT, GSM 1900, UMTS	Bluetooth, ISM, WLAN	WLL	UNII, WLL, H-LAN, Wi-Fi
Frequency range	698-806* MHz	806-960 MHz	1.71-2.17 GHz	2.3-2.7 GHz	3.3-3.8 GHz	4.5-6.5 GHz
GAIN, typ.	2dBi	2dBi	3dBi	4dBi	4dBi	6dBi
VSWR, typ.	< 2 : 1					
Polarization	Linear, Vertical					
Pattern	Omni Directional					
Input power, max	5 Watt					
Input Impedance	50 Ohm					

#### Mechanical

Dimensions (LxWxH)	169 x 85 x 88 mm (6.65" x 3.34" x 3.46")
Weight	300 gr.
Connector	See Ordering Information
Back Plane	Steel Protected through Zinc Galvanization
Radome	UV Protected Polycarbonate
Mount	See Ordering Information

#### Environmental

Operating Temp. Range	-40°C to +65°C
Vibration	According to IEC 60721-3-4
Water Proofing	IP-67
Flammability	UL94
Humidity	ETS 300 019-1-4, EN 302 085 (annex A.1.1)

### Ordering Options

Model No.	Application / Mount	Connector
MA-VMB-5M	Magnetic Mount	95 cm RG316 Pigtail Side with SMA, Male
MA-VMB-5F	Fixed Mount (Roof Top)	N-Type, Female

\*Installation on non-metallic objects requires Ground Plane 350x350 mm min.

MARS Antennas & RF Systems proprietary information

MARS reserves the right to make technical changes or modifications to any of its products and specifications without prior notice and without implementing such changes to prior supplied products. Product images are representative and indicative only. Warranty terms and general conditions of sale are applicable on any purchase of any product, available on MARS website.

3 Hamanor st. Holon 5886103, P.O.Box 1852 Holon 5811801, Israel

Tel: +972-3-5599661 • Fax: +972-3-5599677 • e-mail: mars@marsant.co.il • web: www.mars-antennas.com

## MA-VM1765-5

### 1.7-6.5 GHz Wide Band Blade Antenna for Mobile Applications

MARS Wide Band Blade Antenna is a ruggedized and aerodynamic antenna that provides an optimal solution for use in mobile applications such as trains, helicopters, buses or cars.

Additional Features:

- Bottom Mount, Fixed Mount (4 screws from bottom)
- Stable and reliable performance.



### Specifications

#### Electrical

Frequency range	1.7-2.3 GHz	2.3-3.0 GHz	3.0-4.0 GHz	4.0-6.5 GHz
GAIN, typ.	3 dBi	4 dBi	5 dBi	6 dBi
VSWR, max.	2 : 1 max.		1.5 :1 typ.	
Polarization	Linear, Vertical			
Pattern	Omni Directional			
Input power, max	5 Watt			
Input Impedance	50 Ohm			

#### Mechanical

Dimensions (LxWxH)	132 x 79 x 76 mm
Weight	150 gr.
Connector	N-Type Female Bottom
Back Plane	Aluminum, protected through chemical passivation
Radome	UV Protected Polycarbonate
Mount	Bottom Mount, Fixed Mount (4 screws from bottom)

#### Environmental

Operating Temp. Range	-40°C to +65°C
Vibration	According to IEC 60721-3-4
Water Proofing	IP-67
Flammability	UL94
Humidity	ETS 300 019-1-4, EN 302 085 (Annex A.1.1)

Patterns are available on our website.

MARS Antennas & RF Systems proprietary information

MARS reserves the right to make technical changes or modifications to any of its products and specifications without prior notice and without implementing such changes to prior supplied products. Product images are representative and indicative only. Warranty terms and general conditions of sale are applicable on any purchase of any product, available on MARS website.

3 Hamanor st. Holon 5886103, P.O.Box 1852 Holon 5811801, Israel

Tel: +972-3-5599661 • Fax: +972-3-5599677 • e-mail: mars@marsant.co.il • web: www.mars-antennas.com

## MA-VM1765-5S

### 1.7-6.5 GHz Wide Band Blade Antenna for Mobile Applications

MARS Wide Band Blade Antenna is a ruggedized and aerodynamic antenna that provides an optimal solution for use in mobile applications such as trains, helicopters, buses or cars.

Additional Features:

- Magnetic Mount
- Fixed Mount (4 screws from bottom)
- Stable and reliable performance.



### Specifications

#### Electrical

Frequency range	1.7-2.3 GHz	2.3-3.0 GHz	3.0-4.0 GHz	4.0-6.5 GHz
GAIN, typ.	3 dBi	4 dBi	5 dBi	6 dBi
VSWR, max.	2 : 1 max.		1.5 :1 typ.	
Polarization	Linear, Vertical			
Pattern	Omni Directional			
Input power, max	5 Watt			
Input Impedance	50 Ohm			

#### Mechanical

Dimensions (LxWxH)	132 x 79 x 76 mm.
Weight	150 gr.
Connector	SMA Female side
Back Plane	Steel with galvanic protection
Radome	UV Protected Polycarbonate
Mount	Ordering Options

#### Environmental

Operating Temp. Range	-40°C to +65°C
Vibration	According to IEC 60721-3-4
Water Proofing	IP-67
Flammability	UL94
Humidity	ETS 300 019-1-4, EN 302 085 (Annex A.1.1)

### Ordering Options

Model No.	Application / Mount
MA-VM1765-5SM	Magnetic Mount
MA-VM1765-5SF	Fixed Mount (4 screws from bottom)

Patterns are available on our website.

MARS Antennas & RF Systems proprietary information

MARS reserves the right to make technical changes or modifications to any of its products and specifications without prior notice and without implementing such changes to prior supplied products. Product images are representative and indicative only. Warranty terms and general conditions of sale are applicable on any purchase of any product, available on MARS website.

3 Hamanor st. Holon 5886103, P.O.Box 1852 Holon 5811801, Israel

Tel: +972-3-5599661 • Fax: +972-3-5599677 • e-mail: mars@marsant.co.il • web: www.mars-antennas.com

## MA-DBO2455-3

### 2.3-2.7 GHz & 4.9-6.4 GHz Dual Band Omni Antenna

MARS Dual Band Omni antenna provides coverage of 2.3 to 2.7 GHz & 4.9 to 6.4 GHz in a single antenna radome.

Additional Features:

- Simultaneous coverage of LTE, 802.11 a, b, g, WiMAX & 4.9 GHz Public Safety bands.
- Light weight and durable construction.
- UV protected radome made of polycarbonate.
- Suitable for either outdoor (car top) or indoor (ceiling) installations.\*



### Specifications

#### Electrical

Frequency range	2.3-2.7 GHz & 4.9-6.4 GHz
GAIN, typ.	2.3-2.7 GHz @ 2 dBi (on 20+ cm diameter ground plane) ** 4.9-6.4 GHz @ 4 dBi (on 20+ cm diameter ground plane) **
VSWR	2: 1 (max.); 1.5 : 1 (typ.)
Polarization	Linear Vertical
Input power, max.	20 Watt
Input Impedance	50 Ohm

#### Mechanical

Dimensions (H x Dia.)	34 x 54 mm (1.3" x 2.1")
Connector	N-Type Female (Bottom)
Weight	60 gr.
Back Plane	Aluminum; protected through chemical passivation
Radome	UV Protected Polycarbonate
Mount	Fixed Roof Top Mounting

#### Environmental

Operating Temperature Range	-40°C to +70°C
Vibration	According to IEC 60721-3-4
Flammability	UL94
Water Proofing	IP-67
Humidity	ETS 300 019-1-4, EN 302 085 (annex A.1.1)

(\*) Supplied with 78 mm disc for ceiling installation.

(\*\*) Gain without ground plane is:

- 0 dBi @ 2.3-2.7 GHz
- 2 dBi @ 4.9-6.1 GHz

Patterns are available on our website

MARS Antennas & RF Systems proprietary information

MARS reserves the right to make technical changes or modifications to any of its products and specifications without prior notice and without implementing such changes to prior supplied products. Product images are representative and indicative only. Warranty terms and general conditions of sale are applicable on any purchase of any product, available on MARS website.

3 Hamanor st. Holon 5886103, P.O.Box 1852 Holon 5811801, Israel

Tel: +972-3-5599661 • Fax: +972-3-5599677 • e-mail: mars@marsant.co.il • web: www.mars-antennas.com

## Parabolic

Part Number	Description	Frequency band	Gain	Polarization	Dimension	Antenna type	Page
MA-WP2556-DP12	Dual Band Dual Polarization Parabolic Reflector, 1.2m	2.4-2.7 GHz 5.0-6.0 GHz	25 ± 1 dBi 32.5 ± 1 dBi	Dual Polarized	1200 mm. (4 ft.)	Parabolic	10-1
MA-WP56-DP34	Dual Polarization Parabolic Dish, 1.2m	4.9-6.1 GHz	34dBi@5.15-6.10 GHz 32dBi@4.90-5.15 GHz	Dual Polarized	1200 mm. (4 ft.)	Parabolic	10-2
MA-WP56-DP32	Dual Polarization Parabolic Dish, 0.9m	5.1-5.9 GHz	32dBi	Dual Polarized	900 mm. (3 ft.)	Parabolic	10-3
MA-WP61-DP35	Dual Polarization / Dual Slant Parabolic Dish, 1.2m	5.7-6.5 GHz	35dBi	Dual Polarized Dual Slant	1200 mm. (4 ft.)	Parabolic	10-4
MA-WP600-36	Parabolic Dish Antenna, 13cm Diameter	57-64 GHz	36dBi	Vertical or Horizontal	∅ 130 mm. (0.39 ft.)  L x W x H 160 x 160 x 34 mm.	Parabolic	10-5

MARS Antennas & RF Systems proprietary information

MARS reserves the right to make technical changes or modifications to any of its products and specifications without prior notice and without implementing such changes to prior supplied products. Product images are representative and indicative only. Warranty terms and general conditions of sale are applicable on any purchase of any product, available on MARS website.

3 Hamanor st. Holon 5886103, P.O.Box 1852 Holon 5811801, Israel

Tel: +972-3-5599661 • Fax: +972-3-5599677 • e-mail: mars@marsant.co.il • web: www.mars-antennas.com



## MA-WP2556-DP12

### 2.4-2.7 GHz & 5-6 GHz Dual Band Dual Polarization Parabolic Reflector Antenna, 1.2m

MARS brand new Prime focus, Dual Band, Dual Polarization, Parabolic Reflector antenna provides coverage of 2.4-2.7 GHz & 5-6 GHz  
 The Parabolic Reflector antenna has a total of four connectors for vertical & horizontal polarization (2 V&H connectors for 2.4-2.7 GHz and 2 V&H connectors for 5-6 GHz)

Additional features:

- Efficient and stable performance.
- High gain stable performance.
- Suitable for harsh weather.



### Specifications

#### Electrical

	2.4-2.7 GHz	5-6 GHz
Frequency range	2.4-2.7 GHz	5-6 GHz
GAIN, typ.	25 ± 1 dBi	32.5 ± 1 dBi
VSWR, max.	1.7 : 1	2.0 : 1
Polarization	Dual Polarized	
Cross Polarization	10 dB	20 dB
3 dB Beam-Width, H-Plane, typ.	6°	3°
3 dB Beam-Width, E-Plane, typ.	6°	3°
Front to Back Ratio.	-30 dB	-40 dB
Port to Port Isolation	-15 dB	-20 dB
Interband isolation	-20 dB	-20 dB
Input power, max	20 Watt	
Input Impedance	50 Ohm	

#### Mechanical

Dimensions (Ø)	1200 mm. (4 ft.)
Weight	18 kg.
Connector	4 x N-Type, Female
Back Plane	Aluminum protected through chemical passivation
Mount	See Ordering Options

#### Environmental

Operating Temperature Range	-40°C to +65°C
Vibration	According to IEC 60721-3-4
Wind Load	200 km/h (survival)
Flammability	UL94
Water Proofing	IP-65
Humidity	ETS 300 019-1-4, EN 302 085 (annex A.1.1)
Salt Fog	According to IEC 68-2-11
Ice and Snow	25mm radial (survival)

### Ordering Options

MA-WP2556-DP12	Antenna Suited for MNT-WP12 mount
MA-WP2556-DP12B	Antenna with MNT-WP12 mount

MARS Antennas & RF Systems proprietary information

MARS reserves the right to make technical changes or modifications to any of its products and specifications without prior notice and without implementing such changes to prior supplied products. Product images are representative and indicative only. Warranty terms and general conditions of sale are applicable on any purchase of any product, available on MARS website.

3 Hamanor st. Holon 5886103, P.O.Box 1852 Holon 5811801, Israel

Tel: +972-3-5599661 • Fax: +972-3-5599677 • e-mail: mars@marsant.co.il • web: www.mars-antennas.com

## MA-WP56-DP34

### 4.9-6.1 GHz Dual Polarization Parabolic Dish Antenna, 1.2m (4ft)

MARS brand new High Gain, Dual Polarization, Parabolic Dish antenna provides coverage of 4.9 – 6.1 GHz

Additional features:

- Efficient and stable performance.
- High gain stable performance.
- Suitable for harsh weather.



## Specifications

### Electrical

Frequency range	4.9-6.1 GHz
GAIN, typ.	34 dBi @ 5.15-6.10 GHz 32 dBi @ 4.90-5.15 GHz
VSWR, max.	2.0: 1 @ 4.90-5.15 GHz 1.7: 1 @ 5.15-5.90 GHz 2.0: 1 @ 5.90-6.10 GHz
Polarization	Dual Polarized
Side Lobe Level, typ.	-18 dB
Cross Polarization, typ.	-20 dB
3 dB Beam-Width, H-Plane, typ.	3°
3 dB Beam-Width, E-Plane, typ.	3°
Front to Back Ratio	-40 dB
Port to Port Isolation, typ.	-36dB @ 4.9-5.6 GHz -20dB @ 5.6-6.1 GHz
Input power, max	100 Watt
Input Impedance	50 Ohm

### Mechanical

Dimensions (Ø)	1200 mm. (4 ft.)
Weight	18 kg.
Connector	2 x N-Type, Female
Mount	See Ordering Options

### Environmental

Operating Temperature Range	-40°C to +65°C
Vibration	According to IEC 60721-3-4
Wind Load	200 km/h (survival)
Flammability	UL94
Water Proofing	IP-65
Humidity	ETS 300 019-1-4, EN 302 085 (annex A.1.1)
Salt Fog	According to IEC 68-2-11
Ice and Snow	25mm radial (survival)

## Ordering Options

MA-WP56-DP34	Antenna Suited for MNT-WP12 mount
MA-WP56-DP34B	Antenna with MNT-WP12 mount

MARS Antennas & RF Systems proprietary information

MARS reserves the right to make technical changes or modifications to any of its products and specifications without prior notice and without implementing such changes to prior supplied products. Product images are representative and indicative only. Warranty terms and general conditions of sale are applicable on any purchase of any product, available on MARS website.

3 Hamanor st. Holon 5886103, P.O.Box 1852 Holon 5811801, Israel

Tel: +972-3-5599661 • Fax: +972-3-5599677 • e-mail: mars@marsant.co.il • web: www.mars-antennas.com

## MA-WP56-DP32

### 5.1-5.9 GHz Dual Polarization Parabolic Dish Antenna, 0.9m (3ft)

MARS brand new High Gain, Dual Polarization, Parabolic Dish antenna provides coverage of 5.1-5.9 GHz

Additional features:

- Efficient and stable performance.
- High gain stable performance.
- Suitable for harsh weather.



## Specifications

### Electrical

Frequency range	5.1-5.9 GHz
Gain, typ.	32 dBi
VSWR, max.	1.7: 1
Polarization	Dual Polarized
Side Lobe Level, typ.	-15 dB
Cross Polarization, typ.	-20 dB
3 dB Beam-Width, H-Plane, typ.	4°
3 dB Beam-Width, E-Plane, typ.	4°
Front to Back Ratio	-40 dB
Port to Port Isolation, typ.	-36dB @ 5.1 – 5.6 GHz -20dB @ 5.6 – 5.8 GHz
Input power, max	100 Watt
Input Impedance	50 Ohm

### Mechanical

Dimensions (Ø)	900 mm. (3 ft.)
Weight	18 kg.
Connector	2 x N-Type, Female
Mount	See Ordering Options

### Environmental

Operating Temperature Range	-40°C to +65°C
Vibration	According to IEC 60721-3-4
Wind Load	200 km/h (survival)
Flammability	UL94
Water Proofing	IP-65
Humidity	ETS 300 019-1-4, EN 302 085 (annex A.1.1)
Salt Fog	According to IEC 68-2-11
Ice and Snow	25mm radial (survival)

## Ordering Options

MA-WP56-DP32	Antenna Suited for MNT-WP12 mount
MA-WP56-DP32B	Antenna with MNT-WP12 mount

MARS Antennas & RF Systems proprietary information

MARS reserves the right to make technical changes or modifications to any of its products and specifications without prior notice and without implementing such changes to prior supplied products. Product images are representative and indicative only. Warranty terms and general conditions of sale are applicable on any purchase of any product, available on MARS website.

3 Hamanor st. Holon 5886103, P.O.Box 1852 Holon 5811801, Israel

Tel: +972-3-5599661 • Fax: +972-3-5599677 • e-mail: mars@marsant.co.il • web: www.mars-antennas.com

## MA-WP61-DP35

### 5.7-6.5 GHz Dual Polarized Parabolic Dish Antenna, 1.2m (4 ft.)

MARS brand new High Gain, Dual Polarization, Parabolic Dish antenna provides coverage of 5.7 – 6.5 GHz.

Additional features:

- Efficient and stable performance.
- High gain stable performance.
- Suitable for harsh weather.



## Specifications

### Electrical

Frequency range	5.7-6.5 GHz
GAIN, typ.	35 dBi
VSWR, max.	1.7: 1
Polarization	Dual Pole
	Dual Polarization Vertical & Horizontal
Side Lobe Level, typ.	-17 dB
Cross Polarization, typ.	-25 dB
3 dB Beam-Width, H-Plane, typ.	2.5°
3 dB Beam-Width, E-Plane, typ.	2.5°
Front to Back Ratio	-40 dB
Port to Port Isolation, typ.	-35 dB
Input power, max	100 Watt
Input Impedance	50 Ohm

### Mechanical

Dimensions (Ø)	1200 mm. (4 ft.)
Weight	18 kg.
Connector	2 x N-Type, Female
Mount	See Ordering Options

### Environmental

Operating Temperature Range	-40°C to +65°C
Vibration	According to IEC 60721-3-4
Wind Load	200 km/h (survival)
Flammability	UL94
Water Proofing	IP-65
Humidity	ETS 300 019-1-4, EN 302 085 (annex A.1.1)
Salt Fog	According to IEC 68-2-11
Ice and Snow	25mm radial (survival)

## Ordering Options

MA-WP61-DP35	Antenna Suited for MNT-WP12 mount
MA-WP61-DP35B	Antenna with MNT-WP12 mount

MARS Antennas & RF Systems proprietary information

MARS reserves the right to make technical changes or modifications to any of its products and specifications without prior notice and without implementing such changes to prior supplied products. Product images are representative and indicative only. Warranty terms and general conditions of sale are applicable on any purchase of any product, available on MARS website.

3 Hamanor st. Holon 5886103, P.O.Box 1852 Holon 5811801, Israel

Tel: +972-3-5599661 • Fax: +972-3-5599677 • e-mail: mars@marsant.co.il • web: www.mars-antennas.com

**MA-WP600-36** **Preliminary**  
**57-64 GHz Parabolic Dish Antenna, 13cm Diameter**

MARS's brand new **MA-WP600-36** V-Band millimeter wave (mmW) dish antenna covers 57-64 GHz frequencies, with exceptionally efficient performance of 36dBi.

MARS **MA-WP600-36** dish antenna features lightweight of less than 0.35kg and compact size design of 130mm in diameter (0.39ft.), which results in beamwidth of 2.5°.

MARS **MA-WP600-36** low-profile aesthetics design minimizes visual impact in any urban environment or other landscape.

MARS **MA-WP600-36** is pre-assembled.  
 Connect the easy-to-use MNT-22 and install.

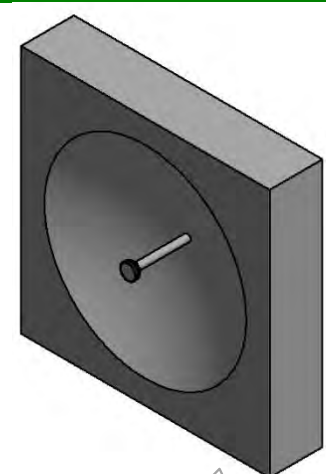

**Specifications**

<i>Electrical</i>	
Frequency range	57 – 64 GHz
Gain, typ.	36 dBi
VSWR, max.	1.5: 1
Polarization	Single Polarized
	Vertical or Horizontal
Side Lobe Level, typ.	-17 dB
Cross Polarization, typ.	-25 dB
3 dB Beam-Width, H-Plane, typ.	2.5°
3 dB Beam-Width, E-Plane, typ.	2.5°
Front to Back Ratio, min.	-40 dB
Input power, max	100 Watt
Input Impedance	50 Ohm
<i>Mechanical</i>	
Dimensions (Ø)	130 mm. (0.39 ft.)
Dimensions (L x W x H)	160 x160 x 34 mm.
Weight	<0.35 kg.
Connector	WR-15 Waveguide with UG-385/U-M Flange
Mount	See Ordering Options
<i>Environmental</i>	
Operating Temperature Range	-40°C to +65°C
Vibration	According to IEC 60721-3-4
Wind Load	200 km/h (survival)
Flammability	UL94
Water Proofing	IP-65
Humidity	ETS 300 019-1-4, EN 302 085 (annex A.1.1)
Salt Fog	According to IEC 68-2-11
Ice and Snow	25mm radial (survival)

**Ordering Options**

MA-WP600-36	Antenna Suited for MNT-22 mount
MA-WP600-36B	Antenna with MNT-22 mount

Mars Antennas & RF Systems proprietary information  
 MARS reserves the right to make technical changes or modifications to any of its products and specifications without prior notice and without implementing such changes to prior supplied products. Product images are representative and indicative only. Warranty terms and general conditions of sale are applicable on any purchase of any product, available on MARS website.

## RF Products

Part Number	Description	Frequency Band (Up/Down Link)	Gain	Dimensions (LxWxD)	Page
MR-PBSMR55-X	SMR/IDEN Personal Bi-Directional Amplifier	Down Link 851-866 MHz Up Link 806-821 MHz	55 dB (min.) 55 dB (min.)	120 x 70 x 35 mm	11-1
MR-BIDEN60-X1W	SMR/IDEN Bi-Directional amplifier	Down Link 851-866 MHz Up Link 806-821 MHz	60 dB (min.) 60 dB (min.)	243 x 160 x 57 mm	11-2
MR-BSMR60-A1W	SMR/IDEN <b>Automatic Control</b> Repeater	Down Link 851-866 MHz Up Link 806-821 MHz	60 dB (min.) 60 dB (min.)	243 x 163 x 57 mm	11-3
MR-BSMR80-XA	SMR/IDEN High Gain Automatic Control Repeater	Down Link 851-866 MHz Up Link 806-821 MHz	80 dB (min.) 80 dB (min.)	280 x 250 x 65 mm	11-4
MR-HSBDA60-X	CDMA High Selective Repeater	Down Link 864-894 MHz Up Link 824-849 MHz	63 dB (min.) 60 dB (min.)	280 x 250 x 65 mm	11-5
MR-PBCT55-X	CDMA/TDMA Personal BDA	Down Link 864-894 MHz Up Link 824-849 MHz	55 dB (min.) 55 dB (min.)	120 x 70 x 35 mm	11-6
MR-PBCT55-A	CDMA/TDMA Personal BDA <b>Automatic Gain Control</b>	Down Link 864-894 MHz Up Link 824-849 MHz	55 dB (min.) 55 dB (min.)	120 x 70 x 35 mm	11-7
MR-BDA60-X1W	CDMA Bi-Directional Amplifier	Down Link 869-879 MHz Up Link 824-834 MHz	60 dB (min.)	243 x 160 x 57 mm	11-8
MR-BGSM60-X1W	GSM Bi-Directional Amplifier	Down Link 947-960 MHz Up Link 902-915 MHz	60 dB (min.) 60 dB (min.)	243 x 160 x 57 mm	11-9
MR-PBGS55-FA	Full Band GSM Automatic Gain Control Repeater	Down Link 935-960 MHz Up Link 890-915 MHz	55 dB (min.) 55 dB (min.)	120 x 70 x 35 mm	11-10
MR-PBGS55-X	GSM Personal Bi-Directional Amplifier	Down Link 947-960 MHz Up Link 824-834 MHz	55 dB (min.) 55 dB (min.)	120 x 70 x 35 mm	11-11
MR-HGSM50-X	GSM1800 Bi-Directional Amplifier	Down Link 1805-1880 MHz Up Link 1710-1785 MHz	45 dB (min.) 45 dB (min.)	310 x 150 x 63 mm	11-12
MR-HSBGSM60	GSM High Selective Repeater	Down Link 935-960 MHz Up Link 890-915 MHz	63 dB (min.) 60 dB (min.)	280 x 250 x 65 mm	11-13
MR-BGSM80-XA	GSM High Gain Automatic Control Repeater	Down Link 935-960 MHz Up Link 890-915 MHz	80 dB (min.) 70 dB (min.)	260 x 250 x 65 mm	11-14
MR-DBHSDG-70YY	<b>Dual Band GSM</b> 900 & 1800 MHz Repeater	Down Link 935-960 MHz Up Link 890-915 MHz  Down Link 1805-1880 MHz Up Link 1710-1785 MHz	70 dB (min.) 70 dB (min.)  70 dB (min.) 70 dB (min.)	310 x 200 x 60 mm	11-15
MR-HSUMTS70-X	UMTS High Selective Bi – Directional Amplifier <b>1Watt</b>	Down Link 2110-2170 MHz Up Link 1920-1980 MHz	75 dB (min) 72 dB (min)	440 x 325 x 180 mm	11-16
MR-UMTS70-20F	UMTS Bi – Directional Amplifier (WCDMA)	Down Link 2110-2170 MHz Up Link 1920-1980 MHz	70 dB (min) 70 dB (min)	280 x 250 x 65 mm	11-17
MR-HSUMTS70-20	UMTS HS Bi – Directional Amplifier	Down Link 2110-2170 MHz Up Link 1920-1980 MHz	73 dB (min) 73 dB (min)	280 x 250 x 65 mm	11-18
MR-HSUMTS70-18	UMTS HS Bi – Directional Amp. (WCDMA)	Down Link 2110-2170 MHz Up Link 1920-1980 MHz	73 dB (min) 70 dB (min)	420 x 250 x 65 mm	11-19
MR-PUMTS50-FA	Full Band UMTS (2GHz) Automatic Gain Control Repeater	Down Link 2110-2170 MHz Up Link 1920-1980 MHz	50 dB (min) 50 dB (min)	120 x 70 x 35 mm	11-20

MARS Antennas & RF Systems proprietary information

MARS reserves the right to make technical changes or modifications to any of its products and specifications without prior notice and without implementing such changes to prior supplied products. Product images are representative and indicative only. Warranty terms and general conditions of sale are applicable on any purchase of any product, available on MARS website.

3 Hamanor st. Holon 5886103, P.O.Box 1852 Holon 5811801, Israel

Tel: +972-3-5599661 • Fax: +972-3-5599677 • e-mail: mars@marsant.co.il • web: www.mars-antennas.com

Part Number	Description	Frequency Band (Up/Down Link)	Gain	Dimensions (LxWxD)	Page
<b>MR-DBHSUC-80</b>	<b>CDMA/UMTS 1Watt Dual Band</b> 850MHz & 2000MHz Repeater	Down Link 869-879 MHz Up Link 824-834 MHz  Down Link 2140-2150 MHz Up Link 1950-1690 MHz	75 dB (min.) 72 dB (min.)  80 dB (min.) 77 dB (min.)	350 x 270 x 100 mm	11-21
<b>MR-DBHSUC-70YY</b>	<b>Dual Band CDMA/UMTS</b> 850 & 2000 MHz Repeater	Down Link 869-879 MHz Up Link 824-834 MHz  Down Link 2140-2150 MHz Up Link 1950-1690 MHz	68 dB (min.) 65 dB (min.)  75 dB (min.) 72 dB (min.)	260 x 200 x 60 mm	11-22
<b>MR-AM800-X</b>	Power Amplifier Cellular Bands	800-960 MHz	30±1 dB	60 x 50 x 20 mm W/O Heat Sink	11-23
<b>MR-AM1800-X</b> <b>MR-AM1900-X</b>	Power Amplifiers – Cellular Bands	PCS1800 GSM1800 1800-1900 MHz PCS1900 GSM1900 1900-2000 MHz	30±1 dB	60 x 50 x 20 mm W/O Heat Sink	11-24
<b>MR-AM2100-X</b>	Power Amplifiers – Cellular Bands	2110-2170 MHz IMT2000, UMTS	11 dB	260 x 250 x 65 mm	11-25
<b>MR-AM1200-2100</b>	Power Amplifiers RF	1200-2100 MHz	20-28 dB	44 x 9 x 25 mm	11-26
<b>MR-RRA30-1</b>	GPS Re-Radiating System	1575.42±2.0 MHz	35 dB		11-27
<b>MR-RRA30-2</b>	GPS Re-Radiating System	1575.42±2.0 MHz	35 dB		11-28
<b>MR-DARF-XX</b>	Dual Active Reject Filter	825-835 MHz	3 dB (min) to 7 dB (max)	19" Box	11-29
<b>MR-PD02-X</b>	2 Way Splitter	800-2500 MHz	0.7dB/1.5 dB typ. / max.	120 x 95 x 30 mm	11-30
<b>MR-PD03-X</b>	3 Way Splitter	800-2000 MHz	1.3 dB	140 x 95 x 30 mm	11-31
<b>MR-PD04-X</b>	4 Way Splitter	800-2200 MHz	1.5 dB	120 x 110 x 30 mm	11-32
<b>MR-PD04-X1</b>	4 Way Splitter	2.3-2.6 GHz	1.5 dB	197 x 136 x 82 mm	11-33

MARS Antennas & RF Systems proprietary information

MARS reserves the right to make technical changes or modifications to any of its products and specifications without prior notice and without implementing such changes to prior supplied products. Product images are representative and indicative only. Warranty terms and general conditions of sale are applicable on any purchase of any product, available on MARS website.

3 Hamanor st. Holon 5886103, P.O.Box 1852 Holon 5811801, Israel

Tel: +972-3-5599661 • Fax: +972-3-5599677 • e-mail: mars@marsant.co.il • web: www.mars-antennas.com

## MR-PBSMR55-X

### SMR / IDEN Bi - Directional Amplifier

MARS Personal BDA provides a cost effective solution for enhancing radio communication in offices and other small area spaces. Amplifier features small size and is easy to install.



### Specifications

#### Electrical

	Down Link	Up Link
Frequency range	851-866 MHz	806-821 MHz
Operational Frequency Band, (Other Available on Request)	851-866 MHz	806-821 MHz
Gain at, min. Attenuation	55 dB	
Pass Band Ripple	±2 dB	
Output Power @ 1 dB Compression	18 dBm	
Noise Figure max.	6.5 dB	
Step Attenuator (2 dB Step)	2 to 30 dB	
Impedance	50 Ohm	
VSWR, max.	2 : 1	
Output IP3, min.	28 dBm	
Input Power, max.	-20 dBm	
Biassing (Through Separate DC Connector)	6V / 400mA (Adaptor MR-PS13 should be Ordered Separately)	

#### Mechanical

Dimensions	120 x 70 x 35 mm
Weight	200 gr.
Connectors	SMA, Female
Housing	Aluminum, Anodized, Black
Mount	Wall / Ceiling Mounting

#### Environmental

Operating Temperature Range	-10°C to +50°C
Humidity, min.	95%

Mars Antennas & RF Systems proprietary information

MARS reserves the right to make technical changes or modifications to any of its products and specifications without prior notice and without implementing such changes to prior supplied products. Product images are representative and indicative only. Warranty terms and general conditions of sale are applicable on any purchase of any product, available on MARS website.

3 Hamanor st. Holon 58861, P.O.Box 5 AZOR 58008, Israel

Tel: +972-3-5599661 • Fax: +972-3-5599677 • e-mail: mars@marsant.co.il • web: www.mars-antennas.com



## MR-BIDEN60-X1W

### SMR / IDEN Bi – Directional Amplifier

Mars BDA series of products provides a cost effective answer for enhancing radio communication in buildings, basements, parking garages and other RF shielded environments. BDA products are designed to receive and amplify RF signals strength in both the "Down Link" and the "Up Link" communication paths.



### Specifications

#### Electrical

	Down Link	Up Link
Frequency range	851-866 MHz	806-821 MHz
Operational Frequency Band, (Other Available on Request)	851-866 MHz	806-821 MHz
Gain at, min. Attenuation	60 dB	
Pass Band Ripple	±1.5 dB	
Output Power @ 1 dB Compression	30 dBm	
Noise Figure max.	6 dB	
Gain Control Range, manual, 2 dB Step	30 dB	
Impedance	50 Ohm	
VSWR, max.	2 : 1	
Output IP3, min.	40 dBm	
Biassing (Through Separate DC Connector)	6.7V / 3A (Adaptor MR-PS30 should be Ordered Separately)	

#### Mechanical

Dimensions	243 x 160 x 57 mm
Weight	2 kg.
Connectors	N-Type, Female

#### Environmental

Operating Temperature Range	-30°C to +70°C
Humidity, min.	95%
Splash, Dust	Protected

MARS Antennas & RF Systems proprietary information

MARS reserves the right to make technical changes or modifications to any of its products and specifications without prior notice and without implementing such changes to prior supplied products. Product images are representative and indicative only. Warranty terms and general conditions of sale are applicable on any purchase of any product, available on MARS website.

3 Hamanor st. Holon 5886103, P.O.Box 1852 Holon 5811801, Israel

Tel: +972-3-5599661 • Fax: +972-3-5599677 • e-mail: mars@marsant.co.il • web: www.mars-antennas.com

## MR-BSMR60-A1W

### SMR / IDEN Automatic Control Repeater

Automatic Control Repeater is a high linear repeater at low power consumption. It provides a cost effective solution for enhancing in-building radio communication, basements, parking garages and other RF shielded environments.

Additional Features:

- Auto Setup
- Overload protection
- Oscillation protection

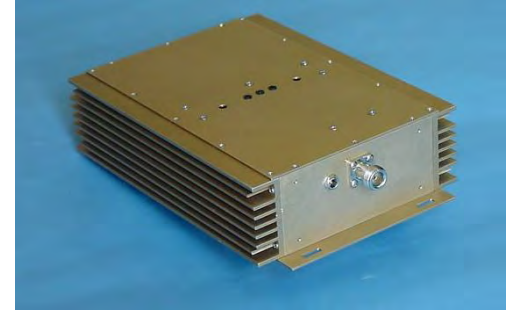

### Specifications

#### Electrical

	Down Link	Up Link
Frequency range	851-866 MHz	806-821 MHz
Operational Frequency Band, (Other available on request)	15 MHz	
Pass Band Ripple	±1.5 dB	
Gain at min. attenuation, min.	60 dB	
Output Power @ 1 dB Compression	30 dBm	
Maximum Output Power	21 dBm	
Output IP3, min.	40 dBm	
Noise Figure at min. attenuation, max.	6 dB	
Range of ALC output power setting points, (Other available by request)	7-21 dBm (up 8 set points)	
Range of AGC	45 dB	
Limited Output Power, (Other available by request)	28 dBm	
Protection from Oscillation and Overload	Automatic	
Impedance	50 Ohm	
VSWR, max.	2 : 1	
Input Power, No Damage, max.	10 dBm	
Biassing (Option - 220 VAC/ DC Adapter included)	6.7 VDC @ 3.5A max	

#### Mechanical

Dimensions	243 x 160 x 57 mm
Weight	2 kg.
Connectors	N-Type, Female
Mount	Wall / Ceiling Mounting

#### Environmental

Operating Temperature Range	-10°C to +50°C
Humidity, min.	95%
Splash, Dust	Protected

MARS Antennas & RF Systems proprietary information

MARS reserves the right to make technical changes or modifications to any of its products and specifications without prior notice and without implementing such changes to prior supplied products. Product images are representative and indicative only. Warranty terms and general conditions of sale are applicable on any purchase of any product, available on MARS website.

3 Hamanor st. Holon 5886103, P.O.Box 1852 Holon 5811801, Israel

Tel: +972-3-5599661 • Fax: +972-3-5599677 • e-mail: mars@marsant.co.il • web: www.mars-antennas.com

## MR-BSMR80-XA

### SMR / IDEN High Gain Automatic Control Repeater

High Gain Automatic Control Repeater is a high linear repeater at low power consumption. It provides a cost effective solution for enhancing in-building radio communication, basements, parking garages and other RF shielded environments.

Additional Features:

- Auto Setup
- Overload protection
- Oscillation protection



### Specifications

#### Electrical

	Down Link 851-866 MHz	Up Link 806-821 MHz
Frequency range		
Operational Frequency Band, (Other available on request)	15 MHz	
Gain at min. attenuation, min.	80 dB	
Output Power @ 1 dB Compression	30 dBm	
Maximum Output Power	25 dBm	
Output IP3, min.	41 dBm	
Pass Band Ripple	1.5 dB	
Noise Figure at min. attenuation, max.	6 dB	
Range of ALC output power setting points, (Other available by request)	15-25 dBm (up 6 set points)	
Range of AGC (*)	45 dB	
Limited Output Power, (Other available by request)	28 dBm	
Protection from Oscillation and Overload	Automatic	
Impedance	50 Ohm	
VSWR, max.	2 : 1	
Input Power, No Damage, max.	-15 dBm	
Biassing (Option - 220 VAC/ DC Adapter included)	6.7 VDC @ 3.5 A max	

#### Mechanical

Dimensions	280 x 250 x 65 mm
Weight	2.5 kg
Connectors	N-Type, Female
Mount	Wall / Ceiling Mounting

#### Environmental

Operating Temperature Range	-10°C to +50°C
Humidity, min.	95%
Splash, Dust	Protected

(\*) Digital 30dB/1dB Step, Analog 15dB

Mars Antennas & RF Systems proprietary information

MARS reserves the right to make technical changes or modifications to any of its products and specifications without prior notice and without implementing such changes to prior supplied products. Product images are representative and indicative only. Warranty terms and general conditions of sale are applicable on any purchase of any product, available on MARS website.

3 Hamanor st. Holon 58861, P.O.Box 5 AZOR 58008, Israel

Tel: +972-3-5599661 • Fax: +972-3-5599677 • e-mail: mars@marsant.co.il • web: www.mars-antennas.com

## MR-HSBDA60-X

### CDMA High Selective Repeater

MARS CDMA High Selective Repeater is a high linear repeater at low power consumption. It provides high frequency selectivity at low power consumption.

Additional Features:

- Auto Setup
- Overload protection
- Oscillation protection
- High spectral purity



### Specifications

#### Electrical

	Down Link	Up Link
Frequency range	869-894 MHz	824-849 MHz
Operational Frequency Band, (Other available on request)	10 MHz;	10 MHz;
Gain at min. attenuation, min.	63 dB	60 dB
Pass Band Ripple	3 dB	
Maximum Output Power	21 dBm	12 dBm
Selectivity: At 1 MHz offset from Pass Band edges, min.	50 dB	50 dB
Noise Figure at min. Attenuation	6.5 dB	
Range of AGC, step 1 dB (*)	30 dB	
Range of ALC Output Power Setting Points, (Other available by request)	8-21 dBm (up 8 set points)	-
Impedance In / Out	50 Ohm	
VSWR In / Out, max.	2 : 1	
Output IP3, min.	40 dBm	34 dBm
Propagation Delay, max.	5 usec	
Limited Output Power	28 dBm	19 dBm
Biasing (220 VAC/DC Adapter Included)	6.7 VDC @ 3.5A, max.	
Emission & Spurious	According to Standards	
Oscillation Protection	Yes	

#### Mechanical

Dimensions	280 x 250 x 65 mm
Weight	2.3 kg.
Connectors	N-Type, Female
Mount	Wall / Ceiling Mounting

#### Environmental

Operating Temperature Range	-10°C to +50°C
Humidity, min.	95%

(\*) The Up Link Gain is Always 3 dB Lower than down Link Gain

MARS Antennas & RF Systems proprietary information

MARS reserves the right to make technical changes or modifications to any of its products and specifications without prior notice and without implementing such changes to prior supplied products. Product images are representative and indicative only. Warranty terms and general conditions of sale are applicable on any purchase of any product, available on MARS website.

3 Hamanor st. Holon 5886103, P.O.Box 1852 Holon 5811801, Israel

Tel: +972-3-5599661 • Fax: +972-3-5599677 • e-mail: mars@marsant.co.il • web: www.mars-antennas.com

## MR-PBCT55-X

### CDMA / TDMA Bi - Directional Amplifier

MARS Personal BDA provides a cost effective solution for enhancing radio communication in offices and other small area spaces. Amplifier features small size and is easy to install.



### Specifications

#### Electrical

	Down Link	Up Link
Frequency range	869-894 MHz	824-849 MHz
Operational Frequency Band, (Other Available on Request)	869-879 MHz	824-834 MHz
Gain at, min. Attenuation	55 dB	
Pass Band Ripple	±2 dB	
Output Power @ 1 dB Compression	18 dBm	
Noise Figure max.	6.5 dB	
Step Attenuator (2 dB Step)	2 to 30 dB	
Impedance	50 Ohm	
VSWR, max.	2 : 1	
Output IP3, min.	28 dBm	
Input Power, max.	-20 dBm	
Biassing (Through Separate DC Connector)	6V / 400 mA (Adaptor MR-PS13 should be Ordered Separately)	

#### Mechanical

Dimensions	120 x 70 x 35 mm
Weight	200 gr.
Connectors	SMA, Female
Housing	Aluminum, Anodized, Black
Mount	Wall / Ceiling Mounting

#### Environmental

Operating Temperature Range	-10°C to +50°C
Humidity, min.	95%

MARS Antennas & RF Systems proprietary information

MARS reserves the right to make technical changes or modifications to any of its products and specifications without prior notice and without implementing such changes to prior supplied products. Product images are representative and indicative only. Warranty terms and general conditions of sale are applicable on any purchase of any product, available on MARS website.

3 Hamanor st. Holon 5886103, P.O.Box 1852 Holon 5811801, Israel

Tel: +972-3-5599661 • Fax: +972-3-5599677 • e-mail: mars@marsant.co.il • web: www.mars-antennas.com

## MR-PBCT55-A

### CDMA Bi - Directional Amplifier /Repeater/

Gain Automatic Control Personal BDA provides a cost effective solution for enhancing radio communication in offices and other small area spaces. Amplifier features small size and is easy to install.



### Specifications

#### Electrical

	Down Link	Up Link
Frequency range	869-894 MHz	824-849 MHz
Operational Frequency Band, MHz (Other Available on Request)	869-879 MHz	824-834 MHz
Gain at, min. Attenuation	55 dB	
Pass Band Ripple	±2 dB	
Output Power @ 1 dB Compression	18 dBm	
Output IP3, min.	28 dBm	
Noise Figure max.	6.5 dB	
ALC	8 dBm	
RF Output Power Range	20 dB	
Impedance	50 Ohm	
VSWR, max.	2 : 1	
Input Power, max.	-20 dBm	
Biassing (Through Separate DC Connector)	6V / 400mA (Adaptor MR-PS13 should be Ordered Separately)	

#### Mechanical

Dimensions	120 x 70 x 35 mm
Weight	200 gr.
Connectors	SMA, Female
Housing	Aluminum, Anodized, Black
Mount	Wall / Ceiling Mounting

#### Environmental

Operating Temperature Range	-10°C to +50°C
Humidity, min.	95%

MARS Antennas & RF Systems proprietary information

MARS reserves the right to make technical changes or modifications to any of its products and specifications without prior notice and without implementing such changes to prior supplied products. Product images are representative and indicative only. Warranty terms and general conditions of sale are applicable on any purchase of any product, available on MARS website.

3 Hamanor st. Holon 5886103, P.O.Box 1852 Holon 5811801, Israel

Tel: +972-3-5599661 • Fax: +972-3-5599677 • e-mail: mars@marsant.co.il • web: www.mars-antennas.com

## MR-BDA60-X1W

### Bi-Directional Amplifier

MARS BDA series of products provides a cost effective answer for enhancing radio communication in buildings, basements, parking garages and other RF shielded environments. BDA products are designed to receive and amplify RF signals strength in both the "Down Link" and the "Up Link" communication paths.



### Specifications

#### Electrical

	Down Link	Up Link
Frequency range	869-894 MHz	824-849 MHz
Operational Frequency Band, MHz (Other Available on Request)	869-879 MHz	824-834 MHz
Gain at, min. Attenuation	60 dB	
Pass Band Ripple	±1.5 dB	
Output Power @ 1 dB Compression	30 dBm	
Noise Figure max.	6 dB	
Gain Control Range, manual, 2 dB Step	30 dB	
Impedance	50 Ohm	
VSWR, max.	2 : 1	
Output IP3, min.	40 dBm	
Biassing (Through Separate DC Connector)	6.7VDC / 3A (Adaptor MR-PS30 should be Ordered Separately)	

#### Mechanical

Dimensions	243 x 160 x 57 mm
Weight	2 kg.
Connectors	N-Type, Female

#### Environmental

Operating Temperature Range	-30°C to +70°C
Humidity, min.	95%
Splash, Dust	Protected

MARS Antennas & RF Systems proprietary information

MARS reserves the right to make technical changes or modifications to any of its products and specifications without prior notice and without implementing such changes to prior supplied products. Product images are representative and indicative only. Warranty terms and general conditions of sale are applicable on any purchase of any product, available on MARS website.

3 Hamanor st. Holon 5886103, P.O.Box 1852 Holon 5811801, Israel

Tel: +972-3-5599661 • Fax: +972-3-5599677 • e-mail: mars@marsant.co.il • web: www.mars-antennas.com

## MR-BGSM60-X1W

### GSM Bi-Directional Amplifier

MARS BDA series of products provides a cost effective answer for enhancing radio communication in buildings, basements, parking garages and other RF shielded environments. BDA products designed to receive and amplify RF signals strength in both "Down Link" and "Up Link" communication paths.



### Specifications

#### Electrical

	Down Link	Up Link
Frequency range	935-960 MHz	890-915 MHz
Operational Frequency Band, MHz (Other Available on Request)	947-960 MHz	902-915 MHz
Gain at, min. Attenuation	60 dB	
Pass Band Ripple	±1.5 dB	
Output Power @ 1 dB Compression	30 dBm	
Noise Figure max.	6 dB	
Gain Control Range, manual, 2 dB Step	30 dB	
Impedance	50 Ohm	
VSWR, max.	2 : 1	
Output IP3, min.	40 dBm	
Biassing (Through Separate DC Connector)	6.7V / 3A (Adaptor MR-PS30 should be Ordered Separately)	

#### Mechanical

Dimensions	243 x 160 x 57 mm
Weight	2 kg.
Connectors	N-Type, Female

#### Environmental

Operating Temperature Range	-10°C to +50°C
Humidity, min.	95%
Splash, Dust	Protected

MARS Antennas & RF Systems proprietary information

MARS reserves the right to make technical changes or modifications to any of its products and specifications without prior notice and without implementing such changes to prior supplied products. Product images are representative and indicative only. Warranty terms and general conditions of sale are applicable on any purchase of any product, available on MARS website.

3 Hamanor st. Holon 5886103, P.O.Box 1852 Holon 5811801, Israel

Tel: +972-3-5599661 • Fax: +972-3-5599677 • e-mail: mars@marsant.co.il • web: www.mars-antennas.com



## MR-PBGS55-FA

### Full Band GSM Automatic Gain Control Repeater

MARS Personal BDA provides a cost effective solution for enhancing radio communication in offices and other small area spaces. Amplifier features small size and is easy to install.



### Specifications

#### Electrical

	Down Link	Up Link
Operational Frequency Band, MHz	935-960 MHz	890-915 MHz
Gain at min. Attenuation	55 dB	
Pass Band Ripple	± 3 dB	
Noise Figure max.	6 dB	
ALC RF Output Power Range	8 dBm	
Impedance	20 dB	
VSWR, max.	50 Ohm	
Output IP3, min.	2 : 1	
Input Power, max.	28 dBm	
Indications	-20 dBm	
Power Supply	Power ON & ALC Leds	
	External PS 220V AC to 6VDC / 400 mA	

#### Mechanical

Dimensions	120 x 70 x 35 mm
Weight	200 gr.
Connectors	SMA, Female
Housing	Aluminum, Anodized, Black
Mount	Wall / Ceiling Mounting

#### Environmental

Operating Temperature Range	-10°C to +50°C
Humidity, min.	95%

Mars Antennas & RF Systems proprietary information

MARS reserves the right to make technical changes or modifications to any of its products and specifications without prior notice and without implementing such changes to prior supplied products. Product images are representative and indicative only. Warranty terms and general conditions of sale are applicable on any purchase of any product, available on MARS website.

3 Hamanor st. Holon 58861, P.O.Box 5 AZOR 58008, Israel

Tel: +972-3-5599661 • Fax: +972-3-5599677 • e-mail: mars@marsant.co.il • web: www.mars-antennas.com

## MR-PBGS55-X

### GSM Bi-Directional Amplifier

MARS Personal BDA provides a cost effective solution for enhancing radio communication in offices and other small area spaces. Amplifier features small size and is easy to install.



### Specifications

#### Electrical

	Down Link	Up Link
Frequency range	935-960 MHz	890-915 MHz
Operational Frequency Band, MHz (Other Available on Request)	947-960 MHz	902-915 MHz
Gain at, min. Attenuation	55 dB	
Pass Band Ripple	±2 dB	
Output Power @ 1 dB Compression	18 dBm	
Noise Figure max.	6.5 dB	
Step Attenuator (2 dB Step)	2 to 30 dB	
Impedance	50 Ohm	
VSWR, max.	2 : 1	
Output IP3, min.	28 dBm	
Input Power, max.	-20 dBm	
Biasing (Through Separate DC Connector)	6V / 400mA (Adaptor MR-PS13 should be Ordered Separately)	

#### Mechanical

Dimensions	120 x 70 x 35 mm
Weight	200 gr.
Connectors	SMA, Female
Housing	Aluminum, Anodized, Black
Mount	Wall / Ceiling Mounting

#### Environmental

Operating Temperature Range	-10°C to +50°C
Humidity, min.	95%

Mars Antennas & RF Systems proprietary information

MARS reserves the right to make technical changes or modifications to any of its products and specifications without prior notice and without implementing such changes to prior supplied products. Product images are representative and indicative only. Warranty terms and general conditions of sale are applicable on any purchase of any product, available on MARS website.

3 Hamanor st. Holon 58861, P.O.Box 5 AZOR 58008, Israel

Tel: +972-3-5599661 • Fax: +972-3-5599677 • e-mail: mars@marsant.co.il • web: www.mars-antennas.com

## MR-HGSM50-X

### GSM1800 Bi-Directional Amplifier

MARS BDA series of products provides a cost effective answer for enhancing radio communication in buildings, basements, parking garages and other RF shielded environments.

BDA products are designed to receive and amplify RF signals strength in both the "Down Link" and the "Up Link" communication paths.



### Specifications

#### Electrical

	Down Link	Up Link
Frequency range	1805-1880 MHz	1710-1785 MHz
Gain at, min. Attenuation		45 dB
Pass Band Ripple		±3 dB
Maximum Output Power		15 dBm
Output Power @ 1 dB Compression		25 dBm
Noise Figure max.		7 dB
Digital Automatic Level Control, 1 dB Step		30 dB
Impedance		50 Ohm
VSWR, max.		2 : 1
Output IP3, min.		38 dBm
Input Power, max.		-15 dBm
Biassing		6.5V / 1500mA

#### Mechanical

Dimensions	310 x 150 x 63 mm
Weight	Less than 2 kg.
Connectors	N-Type, Female
Mount	Panel

#### Environmental

Operating Temperature Range	-10°C to +50°C
Humidity, min.	95%
Splash, Dust	Protected

MARS Antennas & RF Systems proprietary information

MARS reserves the right to make technical changes or modifications to any of its products and specifications without prior notice and without implementing such changes to prior supplied products. Product images are representative and indicative only. Warranty terms and general conditions of sale are applicable on any purchase of any product, available on MARS website.

3 Hamanor st. Holon 5886103, P.O.Box 1852 Holon 5811801, Israel

Tel: +972-3-5599661 • Fax: +972-3-5599677 • e-mail: mars@marsant.co.il • web: www.mars-antennas.com

## MR-HSBGSM60

### GSM High Selective Repeater

GSM High Selective Repeater is a high linear repeater which provides high frequency selectivity at low power consumption.

Additional Features:

- Auto Setup
- Overload protection
- Oscillation protection
- High Spectral Purity



### Specifications

#### Electrical

	Down Link	Up Link
Frequency Range	935-960 MHz	890-915 MHz
Operational Frequency Band, (Other available on request)	11.4 MHz;	11.4 MHz;
Gain at min. attenuation, min.	63 dB	60 dB
Pass Band Ripple	± 1.5 dB	
Maximum Output Power	21 dBm	13 dBm
Output IP3, min.	40 dBm	33 dBm
Range of ALC Output Power Setting Points, (Other available by request)	8-21 dBm (up 8 set points)	-
Limited Output Power, (Other available by request)	28 dBm	19 dBm
Range of AGC, step 1 dB (*)	30 dB	
Noise Figure at min. attenuation, max.	6.5 dB	
Selectivity: At 1 MHz offset from Pass Band edges, min.	50 dB	50 dB
Protection from Oscillation and Overload	Automatic	
Impedance	50 Ohm	
Propagation Delay, max	5 usec.	
VSWR, max.	2 : 1	
Biasing (Option - 220 VAC/ DC Adapter included)	6.7 VDC @ 3.5A max	

#### Mechanical

Dimensions	280 x 250 x 65 mm
Weight	2.5 kg.
Connectors	N-Type, Female
Mount	Wall / Ceiling Mounting

#### Environmental

Operating Temperature Range	-10°C to +50°C
Humidity, min.	95%
Splash, Dust	Protected

(\*) Note 1: the up link Gain is always 3 dB lower than the down link Gain

MARS Antennas & RF Systems proprietary information

MARS reserves the right to make technical changes or modifications to any of its products and specifications without prior notice and without implementing such changes to prior supplied products. Product images are representative and indicative only. Warranty terms and general conditions of sale are applicable on any purchase of any product, available on MARS website.

3 Hamanor st. Holon 5886103, P.O.Box 1852 Holon 5811801, Israel

Tel: +972-3-5599661 • Fax: +972-3-5599677 • e-mail: mars@marsant.co.il • web: www.mars-antennas.com

## MR-BGSM80-XA

### GSM High Gain Automatic Control Repeater

MR-BGSM80-XA is a high linear repeater at low power consumption. It provides a cost effective answer for enhancing radio communication in buildings, basements, parking garages and other RF shielded environments.

Additional Features

- Auto Setup
- Overload protection
- Oscillation protection



### Specifications

#### Electrical

	Down Link	Up Link
Frequency range	935-960 MHz	890-915 MHz
Pass Band, Nominal	25 MHz	
Gain at min. Attenuation, min.	80 dB	70 dB
Maximum Output Power	21 dBm	
Output Power @ 1 dB Compression	30 dBm	
Output IP3, min.	40 dBm	
Pass Band Ripple	±2 dB	
Noise Figure at min. attenuation, max.	5.5 dB	
Range of ALC output power setting points, dBm.	11-21 dBm (up 6 set points)	
Range of AGC, dB.	30 dB	
Limited Output Power, dBm.	28 dBm	
Protection from Oscillation and Overload	Automatic	
Impedance	50 Ohm	
VSWR, max.	2 : 1	
Input Power, No Damage, max.	-15 dBm	
Biasing (220 VAC/DC Adapter included)	6.7 VDC @ 3.5A max	

#### Mechanical

Dimensions	280 x 250 x 65 mm
Weight	2.5 kg.
Connectors	N-Type, Female
Mount	Wall / Ceiling Mounting

#### Environmental

Operating Temperature Range	-10°C to +50°C
Humidity, min.	95%
Splash, Dust	Protected

Mars Antennas & RF Systems proprietary information

MARS reserves the right to make technical changes or modifications to any of its products and specifications without prior notice and without implementing such changes to prior supplied products. Product images are representative and indicative only. Warranty terms and general conditions of sale are applicable on any purchase of any product, available on MARS website.

3 Hamanor st. Holon 58861, P.O.Box 5 AZOR 58008, Israel

Tel: +972-3-5599661 • Fax: +972-3-5599677 • e-mail: mars@marsant.co.il • web: www.mars-antennas.com

## MR-DBHSDG-70YY

### GSM Dual Band (900MHz & 1800MHz) Repeater

MR-DBHSDG-70YY is a high selective dual band medium RF power repeater with full band frequency range.

It provides a cost effective answer for enhancing radio communication in buildings, basements, parking garages and other RF shielded environments.

Additional Features

- Auto Setup
- Oscillation & Overload Protection
- AGC



### Specifications

#### Electrical

	GSM 900		DCS 1800	
	Down Link	Up Link	Down Link	Up Link
Frequency Band*	935-960 MHz	890-915 MHz	1805-1880 MHz	1710-1785 MHz
Gain at min. attenuation	70 dB		70 dB	
Pass Band Ripple	±2 dB		±4 dB	
Max Output Power	15 dBm	15 dBm	18 dBm	18 dBm
Output IP3, min.	36 dBm	36 dBm	40 dBm	40 dBm
Intermodulation products, not more	-45 dBc		-45 dBc	
Limited Output Power (Shut down level)	20 dBm		23 dBm	
Range of AGC	30 dB		30 dB	
Noise Figure at min. attenuation, max.	6 dB		6 dB	
Propagation delay, max.	5 usec		5 usec	
Protection from Oscillation and Overload	Automatic		Automatic	
Impedance	50 Ohm		50 Ohm	
VSWR In/Out, max.	2 : 1		2 : 1	
Indications -Leds	"Power ON", "850 Signal", "2000 Signal"			
Standard: 3GPP TS 25.106	Compliance			
Biasing ( 220 VAC/DC Adapter included)	12 VDC @ 2 A			

#### Mechanical

Dimensions	310 x 200 x 60 mm
Weight	3 kg.
Connectors	N-Type, Female
Mount	Wall/Ceiling Mount

#### Environmental

Operating Temperature Range	-10°C to +50°C
Humidity, min.	95%
Splash, Dust	Protected

(\* ) Other available on request

MARS Antennas & RF Systems proprietary information

MARS reserves the right to make technical changes or modifications to any of its products and specifications without prior notice and without implementing such changes to prior supplied products. Product images are representative and indicative only. Warranty terms and general conditions of sale are applicable on any purchase of any product, available on MARS website.

3 Hamanor st. Holon 5886103, P.O.Box 1852 Holon 5811801, Israel

Tel: +972-3-5599661 • Fax: +972-3-5599677 • e-mail: mars@marsant.co.il • web: www.mars-antennas.com

## MR-HSUMTS70-X

### UMTS HS Bi-Directional Amplifier 1Watt

UMTS High Selective Repeater provides a cost effective answer for enhancing radio communication in buildings, basements, parking garages and other RF shielded environments. BDA products are designed to receive and amplify RF signals strength in both the "Down Link" and the "Up Link" communication paths.



### Specifications

#### Electrical

	Down Link	Up Link
Frequency Range	2110-2170 MHz	1920-1980 MHz
Pass Band (*)	2140-2150 MHz	1950-1960 MHz
Gain at min. Attenuation, min.	75 dB	72 dB
Pass Band Ripple	±1.5 dB	±1.5 dB
Rejection / 1 MHz from Pass Band, min.	45 dB	45 dB
Maximum Output Power	30 dBm	12 dBm
Range of ALC output power setting points (up 8)	30-16 dBm (*)	(*) & (**)
Range of ALC, min.	30 dB	
Output IP3, min.	48 dB	38 dB
Propagation delay, max.	5 usec	
Noise Figure, max.	6 dB	4.5 dB
Impedance	50 Ohm	
VSWR In/Out, max.	2 : 1	
Protection from Oscillation and Overload	Automatic	
Local control & monitoring / RS-232/	Yes	
Current & temperature protection	Yes	
Down RF Power indication	Yes	
Power Supply	220V AC	
Power consumption, max.	50 W	

#### Mechanical

Dimensions	440 x 325 x 180 mm
Weight	Less than 11 kg.
Connectors	N-Type, Female
Mount	Wall / Ceiling Mounting

#### Environmental

Operating Temperature Range	-10°C to +50°C
Humidity, min.	95%
Splash, Dust	Protected

(\*) Other available on request

(\*\*) Up Link Gain is setting 3 dB less than Down Link Gain

MARS Antennas & RF Systems proprietary information

MARS reserves the right to make technical changes or modifications to any of its products and specifications without prior notice and without implementing such changes to prior supplied products. Product images are representative and indicative only. Warranty terms and general conditions of sale are applicable on any purchase of any product, available on MARS website.

3 Hamanor st. Holon 5886103, P.O.Box 1852 Holon 5811801, Israel

Tel: +972-3-5599661 • Fax: +972-3-5599677 • e-mail: mars@marsant.co.il • web: www.mars-antennas.com

## MR-UMTS70-20F

### UMTS Bi-Directional Amplifier (WCDMA)

MR-UMTS70-20F is a full band UMTS linear repeater at low power consumption. It provides a cost effective answer for enhancing radio communication in buildings, basements, parking garages and other RF shielded environments.

#### Additional Features

- Auto Setup.
- Overload & Oscillation protection.
- "Down Link" RF Power indication.



### Specifications

#### Electrical

	Down Link	Up Link
Frequency Band	2110-2170 MHz	1920-1980 MHz
Pass Band - nominal	60 MHz	
Gain at min. attenuation, min.	70 dB	
Pass Band Ripple	± 3 dB	
Maximum Output Power	20 dBm	
Range of ALC output power setting points, dBm	20-6 dBm (up to 8 set points)	
Range of AGC, dB	30 dB	
Output IP3, min.	40 dBm	
Output Power @ 1 dB Compression	30 dBm	
Noise Figure at min. attenuation, max.	5 dB	
Impedance	50 Ohm	
VSWR, max.	2 : 1	
Protection from Oscillation and Overload	Automatic	
Biassing (220 VAC/DC Adapter included)	6.7 VDC @ 2.5A max	

#### Mechanical

Dimensions	280 x 250 x 65 mm
Weight	2.5 kg.
Connectors	N-Type, Female
Mount	Wall / Ceiling Mounting

#### Environmental

Operating Temperature Range	-10°C to +50°C
Humidity, min.	95%
Splash, Dust	Protected

Mars Antennas & RF Systems proprietary information

MARS reserves the right to make technical changes or modifications to any of its products and specifications without prior notice and without implementing such changes to prior supplied products. Product images are representative and indicative only. Warranty terms and general conditions of sale are applicable on any purchase of any product, available on MARS website.

3 Hamanor st. Holon 58861, P.O.Box 5 AZOR 58008, Israel

Tel: +972-3-5599661 • Fax: +972-3-5599677 • e-mail: mars@marsant.co.il • web: www.mars-antennas.com



## MR-HSUMTS70-20

### UMTS HS Bi-Directional Amplifier

MR-HSUMTS70-20 is a high selective linear repeater at low power consumption. It provides a cost effective answer for enhancing radio communication in buildings, basements, parking garages and other RF shielded environments.

Additional Features

- Auto Setup.
- Overload & Oscillation protection.
- "Down Link" RF Power indication.



### Specifications

#### Electrical

	Down Link	Up Link
Frequency Band	2110-2170 MHz	1920-1980 MHz
Pass Band (*)	2140-2150 MHz	1950-1960 MHz
Gain at min. Attenuation, min.	73 dB	
Pass Band Ripple	±1.5 dB	
Rejection / 1 MHz from Pass Band, min.	45 dB	
Maximum Output Power	20dBm	
Range of ALC output power setting points, dBm	20-6 dBm (up to 8 set points)	
Range of AGC, dB	30 dB	
Output IP3, min.	40 dBm	
Output Power @ 1 dB Compression	30 dBm	
Propagation delay, max.	5 usec	
Noise Figure at min. attenuation, max.	6 dB	
Limited Output Power, dBm	28 dBm	
Impedance	50 Ohm	
VSWR, max.	2:1	
Protection from Oscillation and Overload	Automatic	
Biassing (220 VAC/DC Adapter included)	6.7 VDC@ 3.5 A max	

#### Mechanical

Dimensions	280 x 250 x 65 mm
Weight	2.5 kg.
Connectors	N-Type, Female
Mount	Wall / Ceiling Mounting

#### Environmental

Operating Temperature Range	-10°C to +50°C
Humidity, min.	95%
Splash, Dust	Protected

(\*) Other available on request

MARS Antennas & RF Systems proprietary information

MARS reserves the right to make technical changes or modifications to any of its products and specifications without prior notice and without implementing such changes to prior supplied products. Product images are representative and indicative only. Warranty terms and general conditions of sale are applicable on any purchase of any product, available on MARS website.

3 Hamanor st. Holon 5886103, P.O.Box 1852 Holon 5811801, Israel

Tel: +972-3-5599661 • Fax: +972-3-5599677 • e-mail: mars@marsant.co.il • web: www.mars-antennas.com

## MR-HSUMTS70-18

### UMTS HS Bi – Directional Amplifier (WCDMA)

MR-HSUMTS70-18 is a high selective linear repeater at low power consumption. It provides a cost effective answer for enhancing radio communication in buildings, basements, parking garages and other RF shielded environments.

The features of this model are two built-in CDMA 800 / UMTS dual-band duplexers, which allows providing UMTS coverage in existing CDMA 800 area.

Different pass bands are available upon request

Additional Features

- Auto Setup.
- "Down Link" RF Power indication.

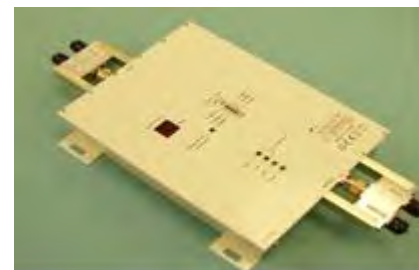

### Specifications

#### Electrical

	Down Link	Up Link
Frequency Band	2110-2170 MHz	1920-1980 MHz
Pass Band(*)	2140-2150 MHz	1950-1960 MHz
Gain at min. Attenuation, min.	73 dB	70 dB
Output Power @ 1 dB Compression	30 dBm	
Pass Band Ripple	±1.5 dB	
Rejection / 1 MHz from Pass Band, min.	45 dB	
Maximum Output Power	20dBm	16dBm
Range of ALC output power setting points, dBm(*)	20-6 dBm (up 8 set points)	Gain is set 3 dB less than Down Link Gain
Range of AGC, dB	30 dB	
Output IP3, min.	40 dBm	
Propagation delay, max.	5 usec	
Noise Figure at min. attenuation, max.	6 dB	
Impedance	50 Ohm	
VSWR, max.	2 : 1	
Protection from Oscillation and Overload	Automatic	
Limited Output Power	28 dBm	
Isolation between RF ports: 800-2000 MHz (internal duplexer)	> 45 dB	
Biassing ( 220 VAC/DC Adapter included)	6.7 VDC @ 3.5A max	

#### Mechanical

Dimensions	420 x 250 x 65 mm
Weight	2.5 kg.
Connectors	N-Type, Female
Mount	Wall / Ceiling Mounting

#### Environmental

Operating Temperature Range	-10°C to +50°C
Humidity, min.	95%
Splash, Dust	Protected

(\*) Other available on request

MARS Antennas & RF Systems proprietary information

MARS reserves the right to make technical changes or modifications to any of its products and specifications without prior notice and without implementing such changes to prior supplied products. Product images are representative and indicative only. Warranty terms and general conditions of sale are applicable on any purchase of any product, available on MARS website.

3 Hamanor st. Holon 5886103, P.O.Box 1852 Holon 5811801, Israel

Tel: +972-3-5599661 • Fax: +972-3-5599677 • e-mail: mars@marsant.co.il • web: www.mars-antennas.com

## MR-PUMTS50-FA

### Full Band UMTS (2GHz) Automatic Gain Control Repeater

MARS Personal BDA provides a cost effective solution for enhancing radio communication in offices and other small area spaces. Amplifier features small size and is easy to install.



### Specifications

#### Electrical

	Down Link	Up Link
Operational Frequency Band, MHz	2110-2170 MHz	1920-1980 MHz
Gain at min. Attenuation	50 dB	
Pass Band Ripple	± 2.5 dB	
Output Power @ 1 dB Compression	17 dBm	
Noise Figure max.	6 dB	
ALC RF Output Power Range	8 dBm	
	20 dB	
Impedance	50 Ohm	
VSWR, max.	2 : 1	
Output IP3, min.	27 dBm	
Input Power, max.	-20 dBm	
Indications	Power ON & ALC Leds	
Power Supply	External PS 220V AC to 6VDC / 400 mA	

#### Mechanical

Dimensions	120 x 70 x 35 mm
Weight	200 gr.
Connectors	SMA, Female
Housing	Aluminum, Anodized, Black
Mount	Wall / Ceiling Mounting

#### Environmental

Operating Temperature Range	-10°C to +50°C
Humidity, min.	95%

Mars Antennas & RF Systems proprietary information

MARS reserves the right to make technical changes or modifications to any of its products and specifications without prior notice and without implementing such changes to prior supplied products. Product images are representative and indicative only. Warranty terms and general conditions of sale are applicable on any purchase of any product, available on MARS website.

3 Hamanor st. Holon 58861, P.O.Box 5 AZOR 58008, Israel

Tel: +972-3-5599661 • Fax: +972-3-5599677 • e-mail: mars@marsant.co.il • web: www.mars-antennas.com

## MR-DBHSUC-80

### CDMA/UMTS 1Watt Dual Band (850MHz & 2000MHz) Repeater

MR-DBHSUC-80 is a high selective (45-50dB) dual band 1Watt RF liner power repeater at low power consumption. It provides a cost effective answer for enhancing radio communication in buildings, basements, parking garages and other RF shielded environments.

Additional Features

- Auto Setup
- Oscillation & Overload Protection
- AGC



### Specifications

#### Electrical

	850MHz		2000MHz	
	Down Link	Up Link	Down Link	Up Link
Frequency Band *	869-879 MHz	824-834 MHz	2140-2150 MHz	1950-1960 MHz
Gain at min. attenuation	75 dB	72 dB	80 dB	77 dB
Gain Difference - DL/UL	3 dB		3 dB	
Pass Band Ripple	± 1.5dB		± 1.5dB	
Max (Linear) Output Power	30 dBm	15 dBm	30 dBm	15 dBm
Intermodulation products, not more	- 43 dBc		- 43 dBc	
Limited Output Power (Shut down level)	33 dBm	18 dBm	33 dBm	18 dBm
Range of AGC	30 dB		30 dB	
Noise Figure at min. attenuation, max.	6 dB		5 dB	
Propagation delay, max	5 usec		5 usec	
Protection from Oscillation and Overload	Automatic		Automatic	
Impedance	50 Ohm		50 Ohm	
VSWR In/Out, max.	2 : 1		2 : 1	
Indications -Leds	"Power ON", "850 Signal", "2000 Signal"			
Standard: 3GPP TS 25.106	Compliance			
Biasing (220 VAC/ DC Adapter included)	100-240VAC, 47-63Hz			

#### Mechanical

Dimensions with connectors	350 x 270 x 100 mm
Weight	< 5 Kg.
Connectors	N-Type, Female
Mount	Wall / Ceiling Mount

#### Environmental

Operating Temperature Range	-10°C to +50°C
Humidity, min.	95%
Splash, Dust	Protected

(\* ) Other available by request;

MARS Antennas & RF Systems proprietary information

MARS reserves the right to make technical changes or modifications to any of its products and specifications without prior notice and without implementing such changes to prior supplied products. Product images are representative and indicative only. Warranty terms and general conditions of sale are applicable on any purchase of any product, available on MARS website.

3 Hamanor st. Holon 5886103, P.O.Box 1852 Holon 5811801, Israel

Tel: +972-3-5599661 • Fax: +972-3-5599677 • e-mail: mars@marsant.co.il • web: www.mars-antennas.com

## MR-DBHSUC-70YY

### CDMA/UMTS Dual Band (850MHz & 2000MHz) Repeater

MR- DBHSUC-70YY is a high selective (45-50dB) dual band medium RF power repeater at low power consumption.

It provides a cost effective answer for enhancing radio communication in buildings, basements, parking garages and other RF shielded environments.

Additional Features

- Auto Setup
- Oscillation & Overload Protection
- AGC



### Specifications

#### Electrical

	CDMA 850		UMTS 2100	
	Down Link	Up Link	Down Link	Up Link
Frequency Band*	869-879 MHz	824-834 MHz	2140-2150 MHz	1950-1960 MHz
Gain at min. attenuation	68 dB	65 dB	75 dB	72 dB
Gain Difference - DL/UL	3 dB		3 dB	
Pass Band Ripple	±1.5 dB		±1.5 dB	
Max Output Power	15 dBm	12 dBm	17 dBm	12 dBm
Intermodulation products, not more	-45 dBc		-45 dBc	
Limited Output Power (Shut down level)	20 dBm	16 dBm	20 dBm	16 dBm
Range of AGC	30 dB		30 dB	
Noise Figure at min. attenuation, max.	6 dB		5 dB	
Propagation delay, max.	5 usec		5 usec	
Protection from Oscillation and Overload	Automatic		Automatic	
Impedance	50 Ohm		50 Ohm	
VSWR In/Out, max.	2 : 1		2 : 1	
Indications - Leds	"Power ON", "850 Signal", "2000 Signal"			
Standard: 3GPP TS 25.106	Compliance			
Biasing ( 220 VAC/DC Adapter included)	12 VDC @ 2 A			

#### Mechanical

Dimensions	260 x 200 x 60 mm
Weight	< 3 kg.
Connectors	N-Type, Female
Mount	Wall/Ceiling Mount

#### Environmental

Operating Temperature Range	-10°C to +50°C
Humidity, min.	95%
Splash, Dust	Protected

(\* ) Other available on request

MARS Antennas & RF Systems proprietary information

MARS reserves the right to make technical changes or modifications to any of its products and specifications without prior notice and without implementing such changes to prior supplied products. Product images are representative and indicative only. Warranty terms and general conditions of sale are applicable on any purchase of any product, available on MARS website.

3 Hamanor st. Holon 5886103, P.O.Box 1852 Holon 5811801, Israel

Tel: +972-3-5599661 • Fax: +972-3-5599677 • e-mail: mars@marsant.co.il • web: www.mars-antennas.com

## MR-AM800-X

### Power Amplifier - Cellular Bands

MARS Power Amplifier features 30 dBi of gain and stable performance. Amplifiers features small size allowing for easy installation.

Can be customized to meet customer's requirements.



### Specifications

#### Electrical

Standard	AMPS, CDMA, TDMA
Frequency range, MHz	800-960 MHz
Gain	30 ± 1 dB
GAIN Flatness, max.	±0.2 dB
VSWR, max.	1.5 : 1
Output Power @1 dB Compression Point	+33 dBm
Noise Figure, max.	4 dB
Output IP3, min.	+46 dBm
Input Power, max.	+10 dBm
Operating Voltage	28 VDC / 600 mA

#### Mechanical

Dimensions	60 x 50 x 20 mm (Without Heat Sink)
RF Connectors	SMA, Female
DC Connector	Feed Through

#### Environmental

Operating Temperature Range	-10°C to +50°C
Humidity, min.	95% RH, IEC 60068-2-56
Splash, Dust	Protected

MARS Antennas & RF Systems proprietary information

MARS reserves the right to make technical changes or modifications to any of its products and specifications without prior notice and without implementing such changes to prior supplied products. Product images are representative and indicative only. Warranty terms and general conditions of sale are applicable on any purchase of any product, available on MARS website.

3 Hamanor st. Holon 5886103, P.O.Box 1852 Holon 5811801, Israel

Tel: +972-3-5599661 • Fax: +972-3-5599677 • e-mail: mars@marsant.co.il • web: www.mars-antennas.com

## MR-BGSM80-XA

### GSM High Gain Automatic Control Repeater

MR-BGSM80-XA is a high linear repeater at low power consumption. It provides a cost effective answer for enhancing radio communication in buildings, basements, parking garages and other RF shielded environments.

Additional Features

- Auto Setup
- Overload protection
- Oscillation protection



### Specifications

#### Electrical

	Down Link 935-960 MHz	Up Link 890-915 MHz
Frequency range		
Pass Band, Nominal		25 MHz
Gain at min. Attenuation, min.	80 dB	70 dB
Maximum Output Power		21 dBm
Output Power @ 1 dB Compression		30 dBm
Output IP3, min.		40 dBm
Pass Band Ripple		±2 dB
Noise Figure at min. attenuation, max.		5.5 dB
Range of ALC output power setting points, dBm.	11-21 dBm (up 6 set points)	
Range of AGC, dB.	30 dB	
Limited Output Power, dBm.	28 dBm	
Protection from Oscillation and Overload	Automatic	
Impedance	50 Ohm	
VSWR, max.	2 : 1	
Input Power, No Damage, max.	-15 dBm	
Biasing (220 VAC/DC Adapter included)	6.7 VDC @ 3.5A max	

#### Mechanical

Dimensions	280 x 250 x 65 mm
Weight	2.5 kg.
Connectors	N-Type, Female
Mount	Wall / Ceiling Mounting

#### Environmental

Operating Temperature Range	-10°C to +50°C
Humidity, min.	95%
Splash, Dust	Protected

MARS Antennas & RF Systems proprietary information

MARS reserves the right to make technical changes or modifications to any of its products and specifications without prior notice and without implementing such changes to prior supplied products. Product images are representative and indicative only. Warranty terms and general conditions of sale are applicable on any purchase of any product, available on MARS website.

3 Hamanor st. Holon 5886103, P.O.Box 1852 Holon 5811801, Israel

Tel: +972-3-5599661 • Fax: +972-3-5599677 • e-mail: mars@marsant.co.il • web: www.mars-antennas.com

## MR-AM2100-X

### Power Amplifiers - Cellular Bands

MARS Power Amplifiers feature high efficiency, linearity and stable performance.

Amplifiers feature small size allowing for easy installation.

Can be customized to meet customer's requirements.



### Specifications

#### **Electrical**

Standard	IMT2000, UMTS
Frequency range, MHz	2110-2170 MHz
Gain	11 dB
GAIN Flatness, max.	±0.5 dB
VSWR, max.	2 : 1
Output Power @ 1 dB Compression Point	+38dBm
Noise Figure, max.	5 dB
Output IP3 @ 2 tone/27dBm	+50 dBm
Impedance	50 Ohm
Shut Down (ON/OFF)	+5V @ 25uA
Operating Voltage	9 VDC @ 1.2A (at 30 dBm RF Pout)

#### **Mechanical**

Dimensions	60 x 50 x 20 mm (Without Heat Sink)
RF Connectors	SMA, Female
DC Connector	Feed Through

#### **Environmental**

Operating Temperature Range	-20°C to +50°C
Humidity, min.	95% RH, IEC 60068-2-56
Splash, Dust	Protected

MARS Antennas & RF Systems proprietary information

MARS reserves the right to make technical changes or modifications to any of its products and specifications without prior notice and without implementing such changes to prior supplied products. Product images are representative and indicative only. Warranty terms and general conditions of sale are applicable on any purchase of any product, available on MARS website.

3 Hamanor st. Holon 5886103, P.O.Box 1852 Holon 5811801, Israel

Tel: +972-3-5599661 • Fax: +972-3-5599677 • e-mail: mars@marsant.co.il • web: www.mars-antennas.com



## MR-AM1200-2100

### RF Amplifier

MARS Power Amplifiers feature 20-28 dBi of gain and stable performance.  
 Amplifiers feature small size allowing for easy installation.  
 Can be customized to meet customer's requirements.

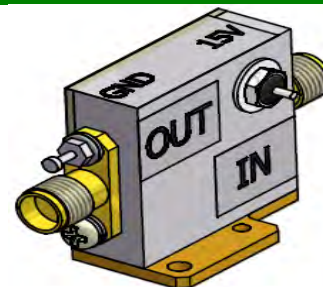

### Specifications

#### **Electrical (temperature +23 °C)**

RF Frequency range	1.2-2.1 GHz
Gain, min.	28 dB @ 1.2 GHz; 24 dB @ 1.5 GHz; 22 dB @ 1.8 GHz; 20 dB @ 2.1 GHz
VSWR, Input/Output	1.8 : 1
Impedance	50 Ohm
Noise Figure, max	2.5 dB
Output Power 1 dB Compression, min	17 dBm
Output IP3, min	30 dBm
Input RF Power (CW), max	15 dBm
DC Power: Voltage, Current, typ.	+(8-15) VDC; 100 mA

#### **Mechanical**

Dimensions (with RF connectors)	44 x 9 x 25 mm
Dimensions (without RF connectors)	25 x 9 x 25 mm
Solder Terminals for DC & GND	2 pcs.
RF Connectors (IN/OUT)	SMA Female
Mount (eye)	2 pcs.

#### **Environmental**

Operating Temperature	-30°C to +55°C
Non Operating Temperature	-30°C to +70°C

MARS Antennas & RF Systems proprietary information

MARS reserves the right to make technical changes or modifications to any of its products and specifications without prior notice and without implementing such changes to prior supplied products. Product images are representative and indicative only. Warranty terms and general conditions of sale are applicable on any purchase of any product, available on MARS website.

3 Hamanor st. Holon 5886103, P.O.Box 1852 Holon 5811801, Israel

Tel: +972-3-5599661 • Fax: +972-3-5599677 • e-mail: mars@marsant.co.il • web: www.mars-antennas.com

## MR-RRA30-1

### MARS GPS Re-Radiating System

MARS GPS Re-Radiating System is repeater kit to provide wireless indoor good GPS signal. This kit consists of three main components: outdoor active antenna, re-radiating amplifier (repeater) and indoor antenna.

MARS GPS System provides a cost effective solution for enhancing GPS communication in showrooms, car parks, trains, buses, GPS service centers etc.

System components feature small size and are easy to install.

Additional features:

- High rejection
- DC feeder for outdoor GPS antenna
- Special Mount
- Cable lengths are available on request



### Specifications

#### Electrical

	Active GPS Antenna MA-GP15-3 (outdoor)	Re-Radiating Amplifier MR-RRA30	GPS Antenna MA-EG15-2P (indoor)
Frequency range, MHz	1575.42 ± 2.0 MHz		
Impedance, Ohm	50	50	50
VSWR	2 : 1	2 : 1	2 : 1
Polarization	RHCP	---	RHCP
Gain of Antenna Element @ Zenith, dBic	2.0 min (-10 min at 0° elevation)	---	2.0 min
Gain, dB	25 (Ampl.)	35	---
Filtering, dB	---	40 @ ± 50MHz	---
Noise Figure, dB	1.6 (Ampl.)	1.0	---
Output Power @ 1dB compress., dBm	---	20	---
Output IP3, dBm	---	32	---
Adjustable Gain, dB	---	30	---
Power Supply, V/mA (220 VAC/ DC adapter included)	5 VDC@ 30 mA (thru RF cable)	(6-12) VDC @ 150 mA	---

#### Mechanical

Dimensions, mm	170 mm (diameter); 100 mm (height)	80 x 70 x 35 mm	40 x 45 x 15 mm
Weight, gr.	500 gr.	150 gr.	60 gr.
Connectors	N-type, Female	SMA, Female	SMA, Male

#### Environmental

Operating Temperature	-30°C to +50°C	-10°C to +50°C	-10°C to +50°C
Storage Temperature	-40°C to +85°C	-40°C to +85°C	-40°C to +85°C

Mars Antennas & RF Systems proprietary information

MARS reserves the right to make technical changes or modifications to any of its products and specifications without prior notice and without implementing such changes to prior supplied products. Product images are representative and indicative only. Warranty terms and general conditions of sale are applicable on any purchase of any product, available on MARS website.

3 Hamanor st. Holon 58861, P.O.Box 5 AZOR 58008, Israel

Tel: +972-3-5599661 • Fax: +972-3-5599677 • e-mail: mars@marsant.co.il • web: www.mars-antennas.com

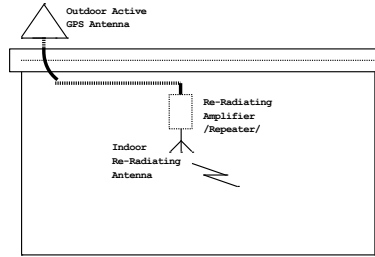

Mars Antennas & RF Systems proprietary information

MARS reserves the right to make technical changes or modifications to any of its products and specifications without prior notice and without implementing such changes to prior supplied products. Product images are representative and indicative only. Warranty terms and general conditions of sale are applicable on any purchase of any product, available on MARS website.

3 Hamanor st. Holon 58861, P.O.Box 5 AZOR 58008, Israel

Tel: +972-3-5599661 • Fax: +972-3-5599677 • e-mail: mars@marsant.co.il • web: www.mars-antennas.com

## MR-DARF-XX

### Dual Active Reject Filter

MARS Dual Active Reject Filter (DARF) provides a cost effective solution for eliminating interfering signals within the cellular frequency band (over 30 dB rejection).

The full system consists of a 19" mountable rack unit that supports up to three dual reject filter modules (see picture), while each module handles one sector.

Additional Features:

- Frequency agile.
- Operates with RX and diversity antenna.



### Specifications

#### *Electrical*

Frequency range	825-835 MHz
IF Frequency	86 MHz
Band Reject (-3 dB)	≤ 150 KHz
Band Reject (-30 dB)	≥ 50 KHz (±5%) non Symmetrical
Null Depth, min.	40 dB
Gain	3 dB (min.) to 7 dB (max.)
Noise Figure, max.	6 dB
Input Intercept Points IP3	≥ -2 dBm
1 dB Compression Point	≥ -12 dBm
Overall Gain over Frequency Band	3 (+3 dB / -2 dB)
Gain Tracking over Frequency Band	≤ 3 +1 dB
Indicators (Led)	Lock Detection, DC
Tuning Step Conversion	25 KHz
DC Voltage	27 V
DC Current, max.	600 mA

#### *Mechanical*

Dimensions	19" Box
RF Connectors	N-Type, Female/Male
DC Connector	Terminal Block
Mount	Free Standing

#### *Environmental*

Operating Temperature Range	-10°C to +50°C
Storage Temperature Range	-10°C to +60°C
Humidity	90%

MARS Antennas & RF Systems proprietary information

MARS reserves the right to make technical changes or modifications to any of its products and specifications without prior notice and without implementing such changes to prior supplied products. Product images are representative and indicative only. Warranty terms and general conditions of sale are applicable on any purchase of any product, available on MARS website.

3 Hamanor st. Holon 5886103, P.O.Box 1852 Holon 5811801, Israel

Tel: +972-3-5599661 • Fax: +972-3-5599677 • e-mail: mars@marsant.co.il • web: www.mars-antennas.com

## MR-PD02-X

### 2 Way Splitter

Can be used to split a signal from a source – or combine signals from multiple sources.

Additional Features:

- Bi-directional splitter/combiner.
- Wide frequency range.
- Reliable and stable performance.
- Small size allowing for easy installation.



### Specifications

#### **Electrical**

Frequency range	800-2500 MHz
Insertion Loss, Over 3 dB, typ. / max.	0.7 dB / 1.5 dB
Output VSWR, max.	2 : 1
Amplitude Balance, max.	0.4 dB
Phase Balance, max.	4°
Isolation, typ.	20 dB
Impedance	50 Ohm
Operating Power	33 dBm

#### **Mechanical**

Dimensions (L x W x H)	120 x 95 x 30 mm (4.7" x 3.7" x 1.2")
Weight	Less than 200 gr.
Number of Outputs	2
Connectors	N-Type, Female
Mounting	Planar / Wall / Ceiling Mount

#### **Environmental**

Operating Temperature Range	-10°C to +55°C
Humidity, min.	95%
Splash, Dust	Protected

Mars Antennas & RF Systems proprietary information

MARS reserves the right to make technical changes or modifications to any of its products and specifications without prior notice and without implementing such changes to prior supplied products. Product images are representative and indicative only. Warranty terms and general conditions of sale are applicable on any purchase of any product, available on MARS website.

3 Hamanor st. Holon 58861, P.O.Box 5 AZOR 58008, Israel

Tel: +972-3-5599661 • Fax: +972-3-5599677 • e-mail: mars@marsant.co.il • web: www.mars-antennas.com

## MR-PD03-X

### 3 Way Splitter

Can be used to split a signal from a source – or combine signals from multiple sources.

Additional Features:

- Bi-directional splitter/combiner
- Wide frequency range
- Reliable and stable performance
- Small size allowing for easy installation



### Specifications

#### **Electrical**

Frequency range	800-2000 MHz
Insertion Loss, Over 4.8 dB	1.3 dB
Output VSWR, max.	1.8 : 1
Amplitude Balance, max.	0.8 dB
Phase Balance, max.	8°
Isolation, typ.	18 dB
Impedance	50 Ohm
Input Power (Load VSWR <1.2)	60 Watt

#### **Mechanical**

Dimensions (L x W x H)	140 x 95 x 30 (5.5" x 3.7" x 1.2")
Weight	Less than 200 gr.
Number of Outputs	3
Connectors	N-Type, Female
Mounting	Planar / Wall / Ceiling Mount

#### **Environmental**

Operating Temperature Range	-40°C to +70°C
Humidity, min.	95%
Splash, Dust	Protected

Mars Antennas & RF Systems proprietary information

MARS reserves the right to make technical changes or modifications to any of its products and specifications without prior notice and without implementing such changes to prior supplied products. Product images are representative and indicative only. Warranty terms and general conditions of sale are applicable on any purchase of any product, available on MARS website.

3 Hamanor st. Holon 58861, P.O.Box 5 AZOR 58008, Israel

Tel: +972-3-5599661 • Fax: +972-3-5599677 • e-mail: mars@marsant.co.il • web: www.mars-antennas.com

## MR-PD04-X

### 4 Way Splitter

Can be used to split a signal from a source or combine signals from multiple sources.

Additional Features:

- Bi-directional splitter/combiner.
- Wide frequency range.
- Reliable and stable performance.
- Easy installation.

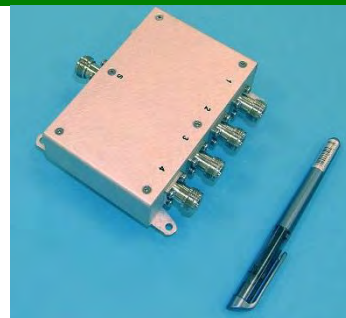

### Specifications

#### **Electrical**

Frequency range	800-2200 MHz
Insertion Loss, max.	1.5 dB
Output VSWR, max.	2 : 1
Amplitude Balance, max.	0.7 dB
Phase Balance, max.	7°
Isolation, typ.	17 dB
Impedance	50 Ohm
Input Power (Load VSWR <2)	60 Watt

#### **Mechanical**

Dimensions (L x W x H)	120 x 110 x 30 mm (4.7" x 4.3" x 1.2")
Number of Outputs	4
Connectors	N-Type, Female
Mounting	Planar / Wall / Ceiling Mount

#### **Environmental**

Operating Temperature Range	-40°C to +70°C
Humidity, min.	95%
Splash, Dust	Protected

Mars Antennas & RF Systems proprietary information

MARS reserves the right to make technical changes or modifications to any of its products and specifications without prior notice and without implementing such changes to prior supplied products. Product images are representative and indicative only. Warranty terms and general conditions of sale are applicable on any purchase of any product, available on MARS website.

3 Hamanor st. Holon 58861, P.O.Box 5 AZOR 58008, Israel

Tel: +972-3-5599661 • Fax: +972-3-5599677 • e-mail: mars@marsant.co.il • web: www.mars-antennas.com

## MR-PD04-X1

### 4 Way Splitter

Professional high performance 4 Way Splitter.

Additional Features:

- Bi-directional splitter.
- Reliable and stable performance.
- Easy installation.



### Specifications

#### **Electrical**

Operating Frequency range	2.3-2.6 GHz
Insertion Loss, max.	0.7 dB
Input/Output VSWR	1.5 Max
Amplitude Balance, max.	0.5 dB
Phase Unbalance, max.	7°
Isolation, min.	20 dB
Impedance	50 Ohm
Power rating, load VSWR better then 1.5:1	20 Watt

#### **Mechanical**

Dimensions (L x W x H)	197 x 136 x 82 [excluding mount]
Weight:	Less than 1.1 kg.
Number of Outputs	4
Connectors	N-Type, Female
Mounting	Mast

#### **Environmental**

Operating Temperature Range	-40°C to +70°C
Humidity, min.	95%
Splash, Dust	Protected

Mars Antennas & RF Systems proprietary information

MARS reserves the right to make technical changes or modifications to any of its products and specifications without prior notice and without implementing such changes to prior supplied products. Product images are representative and indicative only. Warranty terms and general conditions of sale are applicable on any purchase of any product, available on MARS website.

3 Hamanor st. Holon 58861, P.O.Box 5 AZOR 58008, Israel

Tel: +972-3-5599661 • Fax: +972-3-5599677 • e-mail: mars@marsant.co.il • web: www.mars-antennas.com



## Antenna mounts & Enclosure Kits

Part Number	Description	Page
MNT-22	Heavy Duty, Az/EI Adjustable Mount for CPE / Subscriber and Small Base Station Antennas	12-1
MNT-23	Az/EI Adjustable Mount for CPE / Subscriber Antennas	12-2
MNT-1A	Mount for CPE / Subscriber and Small Base Station Antennas	12-3
MNT-5A	Mount for CPE / Subscriber and Small Base Station Antennas	12-4
MNT-25	Mount for CPE / Subscriber and Small Base Station Antennas	12-5
MNT-4X	Az/EI Adjustable Mount for Small Size Antennas	12-6
MNT-60A	Mount for CPE / Subscriber Large Size Antennas	12-7
MK-ES20	Small Enclosure kit	12-8
MK-EL30	Large Enclosure kit	12-9
MG-XXX	Ground Plane for MA-WO-UMB	12-10

MARS Antennas & RF Systems proprietary information

MARS reserves the right to make technical changes or modifications to any of its products and specifications without prior notice and without implementing such changes to prior supplied products. Product images are representative and indicative only. Warranty terms and general conditions of sale are applicable on any purchase of any product, available on MARS website.

3 Hamanor st. Holon 5886103, P.O.Box 1852 Holon 5811801, Israel

Tel: +972-3-5599661 • Fax: +972-3-5599677 • e-mail: mars@marsant.co.il • web: www.mars-antennas.com

## MNT-22

### Mount for CPE / Subscriber and Small Base Station Antennas

#### MNT-22 Features:

- Azimuth and Elevation Adjustable Mount for CPE, Subscriber and Small Base Station Antennas
- Suitable for pole or wall mounting.
- Allows positioning of antenna in 45° slant polarization.
- Made of Die Cast Aluminum.
- Comes with all required hardware in a kit form.
- Heavy duty.

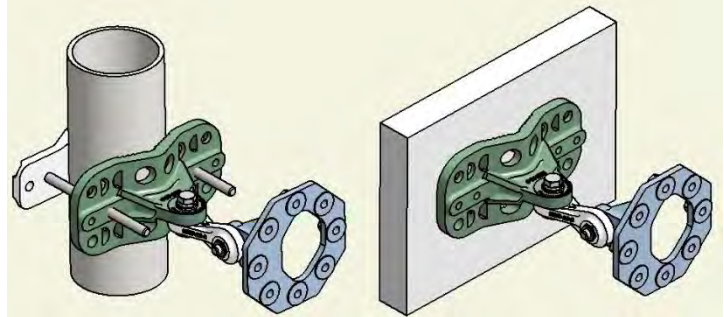

### Specifications

#### **Mechanical**

Material	Aluminum
Kit Weight	0.820 kg.
Load	510 N
Suitable for pole diameter range	25-120 mm *Screws supplied are 80 mm. Longer screws are available on request.
Movement Possibility	Azimuth $\pm 45^\circ$ with antenna 300 x 300 mm mounted Elevation $\pm 45^\circ$ with antenna 300 x 300 mm mounted

#### **Environmental**

Operating Temperature Range	-40°C to +85°C
Vibration	According to IEC 60721-3-4
Flammability	UL94
Ice and Snow	25 mm radial (survival)
Wind Load	210 km/h
Humidity	ETS 300 019-1-4, EN 302 085 (annex A.1.1)

MARS Antennas & RF Systems proprietary information

MARS reserves the right to make technical changes or modifications to any of its products and specifications without prior notice and without implementing such changes to prior supplied products. Product images are representative and indicative only. Warranty terms and general conditions of sale are applicable on any purchase of any product, available on MARS website.

3 Hamanor st. Holon 5886103, P.O.Box 1852 Holon 5811801, Israel

Tel: +972-3-5599661 • Fax: +972-3-5599677 • e-mail: mars@marsant.co.il • web: www.mars-antennas.com

## MNT-23

### Mount for Small Outdoor Antennas

#### MNT-23 Features:

- Azimuth and Elevation Adjustable Mount for Small Outdoor Antennas.
- Free access to cable connector.
- Suitable for pole or wall mounting.
- Made of Die Cast Aluminum.
- Comes with all required hardware in a kit form.
- Heavy duty.

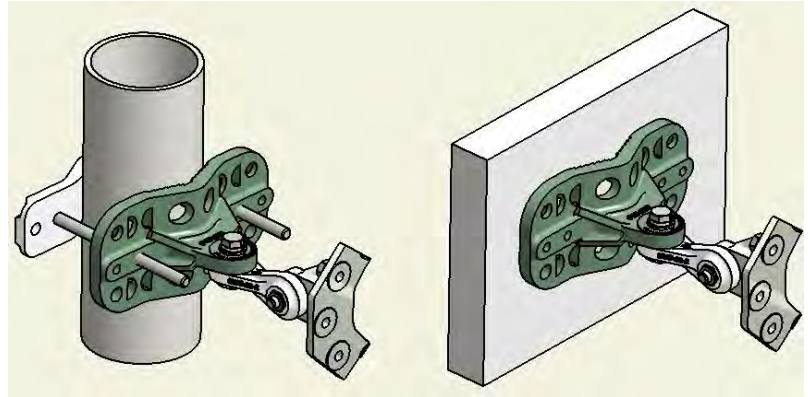

### Specifications

#### **Mechanical**

Material	Aluminum
Kit Weight	0.760 kg.
Load	510 N
Suitable for pole diameter range	25-120 mm *Screws supplied are 80 mm. Longer screws are available on request.
Movement Possibility	Azimuth $\pm 45^\circ$ with antenna 300 x 300 mm mounted Elevation $\pm 45^\circ$ with antenna 300 x 300 mm mounted

#### **Environmental**

Operating Temperature Range	-40°C to +85°C
Vibration	According to IEC 60721-3-4
Flammability	UL94
Ice and Snow	25 mm radial (survival)
Wind Load	210 km/h
Humidity	ETS 300 019-1-4, EN 302 085 (annex A.1.1)

MARS Antennas & RF Systems proprietary information

MARS reserves the right to make technical changes or modifications to any of its products and specifications without prior notice and without implementing such changes to prior supplied products. Product images are representative and indicative only. Warranty terms and general conditions of sale are applicable on any purchase of any product, available on MARS website.

3 Hamanor st. Holon 5886103, P.O.Box 1852 Holon 5811801, Israel

Tel: +972-3-5599661 • Fax: +972-3-5599677 • e-mail: mars@marsant.co.il • web: www.mars-antennas.com

## MNT-1A

### Mount for CPE / Subscriber and Small Base Station Antennas

#### MNT-1A Features:

- Azimuth and Elevation Adjustable Mount for CPE, Subscriber and Small Base Station Antennas.
- Suitable for pole mounting
- Allows positioning of antenna in 45° slant polarization
- Made of Aluminum 5052, Resist to Corrosion
- Comes with all required hardware in a kit form
- Heavy duty



### Specifications

#### Mechanical

Material	Aluminum
Kit Weight	0.6 kg.
Load	510 N
Suitable for pole diameter range	1-3" (inch)
Movement Possibility	Elevation $\pm 16^\circ$ with antenna 500 x 80 mm mounted

#### Environmental

Operating Temperature Range	-40°C to +85°C
Vibration	According to IEC 60721-3-4
Flammability	UL94
Ice and Snow	25 mm radial (survival)
Wind Load	210 km/h
Humidity	ETS 300 019-1-4, EN 302 085 (annex A.1.1)

MARS Antennas & RF Systems proprietary information

MARS reserves the right to make technical changes or modifications to any of its products and specifications without prior notice and without implementing such changes to prior supplied products. Product images are representative and indicative only. Warranty terms and general conditions of sale are applicable on any purchase of any product, available on MARS website.

3 Hamanor st. Holon 5886103, P.O.Box 1852 Holon 5811801, Israel

Tel: +972-3-5599661 • Fax: +972-3-5599677 • e-mail: mars@marsant.co.il • web: www.mars-antennas.com

## MNT-5A

### Mount for Base Station Antennas

#### MNT-5A Features:

- Elevation Tilt Adjustable Mount for large Base Station Antennas.
- Suitable for pole mounting.
- Made from steel
- Comes with all required hardware in a kit form.
- Heavy duty.

Suitable for 800mm height antennas

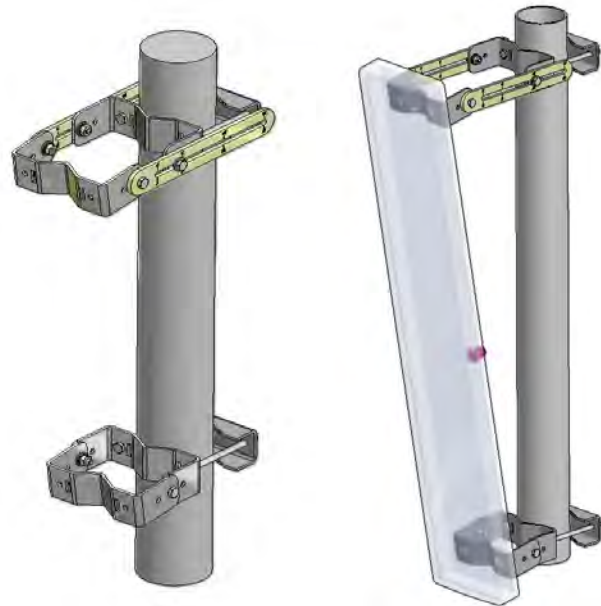

### Specifications

#### *Mechanical*

Material	STEEL
Kit Weight	1.6 kg.
Load	510 N
Suitable for pole diameter range	1-4" (inch)
Movement Possibility	Elevation Tilt $\pm 16^\circ$ with antenna 800x120 mm mounted

#### *Environmental*

Operating Temperature Range	-40°C to +85°C
Vibration	According to IEC 60721-3-4
Flammability	UL94
Ice and Snow	25 mm radial (survival)
Wind Load	210 km/h
Humidity	ETS 300 019-1-4, EN 302 085 (annex A.1.1)

MARS Antennas & RF Systems proprietary information

MARS reserves the right to make technical changes or modifications to any of its products and specifications without prior notice and without implementing such changes to prior supplied products. Product images are representative and indicative only. Warranty terms and general conditions of sale are applicable on any purchase of any product, available on MARS website.

3 Hamanor st. Holon 5886103, P.O.Box 1852 Holon 5811801, Israel

Tel: +972-3-5599661 • Fax: +972-3-5599677 • e-mail: mars@marsant.co.il • web: www.mars-antennas.com

## MNT-25

### Mount for Base Station Antennas

#### MNT-25 Features:

- Elevation Tilt Adjustable Mount for large Base Station Antennas.
- Suitable for pole mounting.
- Made from steel.
- Comes with all required hardware in a kit form.
- Heavy duty.

**Suitable for 1200mm height antennas**

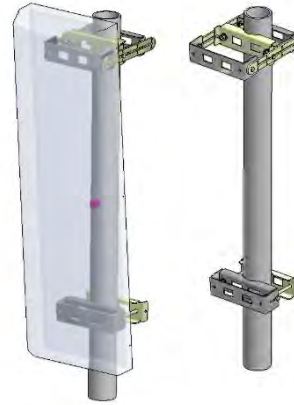

### Specifications

#### *Mechanical*

Material	STEEL
Kit Weight	2.4 kg.
Load	510 N
Suitable for pole diameter range	1-4" (inch)
Movement Possibility	Elevation Tilt $\pm 15^\circ$ with antenna 1200 x 330 mm mounted

#### *Environmental*

Operating Temperature Range	-40°C to +85°C
Vibration	According to IEC 60721-3-4
Flammability	UL94
Ice and Snow	25 mm radial (survival)
Wind Load	210 km/h
Humidity	ETS 300 019-1-4, EN 302 085 (annex A.1.1)

MARS Antennas & RF Systems proprietary information

MARS reserves the right to make technical changes or modifications to any of its products and specifications without prior notice and without implementing such changes to prior supplied products. Product images are representative and indicative only. Warranty terms and general conditions of sale are applicable on any purchase of any product, available on MARS website.

3 Hamanor st. Holon 5886103, P.O.Box 1852 Holon 5811801, Israel

Tel: +972-3-5599661 • Fax: +972-3-5599677 • e-mail: mars@marsant.co.il • web: www.mars-antennas.com

## MNT-4 Series

### For Small Size Antennas

MNT-4G (Glass mount)



MNT-4U (Wall mount)



MNT-4L (Ceiling/Stand mount)



MNT-4LU (Wall/Pole mount)

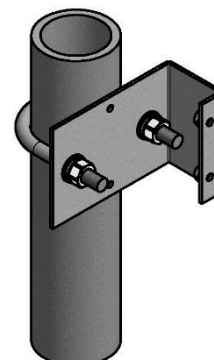

MARS Antennas & RF Systems proprietary information

MARS reserves the right to make technical changes or modifications to any of its products and specifications without prior notice and without implementing such changes to prior supplied products. Product images are representative and indicative only. Warranty terms and general conditions of sale are applicable on any purchase of any product, available on MARS website.

3 Hamanor st. Holon 5886103, P.O.Box 1852 Holon 5811801, Israel

Tel: +972-3-5599661 • Fax: +972-3-5599677 • e-mail: mars@marsant.co.il • web: www.mars-antennas.com

## MNT-60A

### Mount for CPE / Subscriber Large Size Antennas

#### MNT-60A Features:

- Elevation Adjustable Mount for Subscriber Large Size Antennas.
- Suitable for pole or wall mounting.
- Allowing angle inclination of 16°.
- Made of Steel SAE1020, Resist to Corrosion.
- Comes with all required hardware in a kit form.
- Heavy duty.

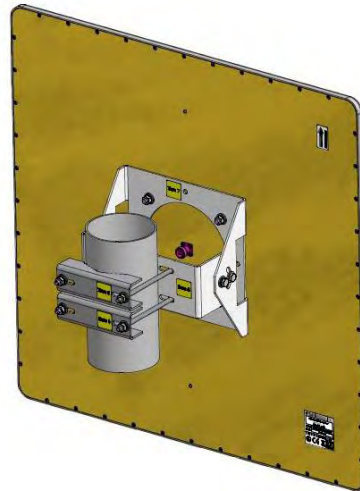

### Specifications

#### **Mechanical**

Material	STEEL, GALVANIZED
Kit Weight	2 kg.
Load	700 N
Suitable for pole diameter range	1-4" (inch)
Movement Possibility	Elevation $\pm 16^\circ$ (with antenna 600 x 600 mm mounted)

#### **Environmental**

Operating Temperature Range	-40°C to +85°C
Vibration	According to IEC 60721-3-4
Flammability	UL94
Ice and Snow	25 mm radial (survival)
Wind Load	210 km/h
Humidity	ETS 300 019-1-4, EN 302 085 (annex A.1.1)

MARS Antennas & RF Systems proprietary information

MARS reserves the right to make technical changes or modifications to any of its products and specifications without prior notice and without implementing such changes to prior supplied products. Product images are representative and indicative only. Warranty terms and general conditions of sale are applicable on any purchase of any product, available on MARS website.

3 Hamanor st. Holon 5886103, P.O.Box 1852 Holon 5811801, Israel

Tel: +972-3-5599661 • Fax: +972-3-5599677 • e-mail: mars@marsant.co.il • web: www.mars-antennas.com



## MK-ES20/MK-ES21

### Small Enclosure Kit

Mars enclosure kit designed for integration of RF PCB from different manufactures with Mars antennas.

Enclosure kit includes:

- Enclosure Die Cast Aluminum.
- Base for RF PCB (See ordering options).
- RJ45 Ethernet Waterproof Connector.

Enclosure Kit Features:

- Suitable for integration with 200x200, 305x305, 370x370 and 600x600 mm Mars antennas\*.
- Suitable for pole or wall azimuth and elevation adjustable mounting.
- Heavy duty.

Suitable for Mount MNT-22 or MNT-60A\*.



(\*) MNT-22 suitable for 200x200, 305x305, 370x370 mm Mars antennas.  
 MNT-60A suitable for 600x600 mm Mars Antennas.

### Specifications

#### **Mechanical**

Enclosure Material	Aluminum A380
Enclosure dimensions (external)	180 x 167 (242 with RJ45) x 68 mm
Base for RF plate material	Aluminum
Base for RF dimensions	150 x 138 mm, height of PCB (max) - 55 mm
Enclosure Finish	White electrostatic powder coating
Connector	RJ45 Ethernet Waterproof Connector
Weight (without MNT)	0.7 kg.
Suitable for pole diameter range	25-120 mm (Screws supplied are 80 mm. Longer screws are available on request)

#### **Environmental**

Operating Temperature Range	-40°C to +65°C
Vibration	According to IEC 60721-3-4
Flammability	UL94
Ice and Snow	25 mm radial (survival)
Water proofing	IP-67
Humidity	ETS 300 019-1-4, EN 302 085 (annex A.1.1)

### Ordering Options

MK-ES20	Base for RF PCB
MK-ES21	Base for RF PCB with embedded PEMs suitable for RB-411/RB-711

MARS Antennas & RF Systems proprietary information

MARS reserves the right to make technical changes or modifications to any of its products and specifications without prior notice and without implementing such changes to prior supplied products. Product images are representative and indicative only. Warranty terms and general conditions of sale are applicable on any purchase of any product, available on MARS website.

3 Hamanor st. Holon 5886103, P.O.Box 1852 Holon 5811801, Israel

Tel: +972-3-5599661 • Fax: +972-3-5599677 • e-mail: mars@marsant.co.il • web: www.mars-antennas.com

## MK-EL30/MK-EL31

### Large Enclosure Kit

Mars enclosure kit designed for integration of RF PCB from different manufactures with Mars antennas.

Enclosure kit includes:

- Enclosure Die Cast Aluminum.
- Base for RF PCB (See ordering options).
- RJ45 Ethernet Waterproof Connector.

Enclosure Kit Features:

- Suitable for integration with 305x305, 370x370 mm Mars antennas.
- Suitable for pole or wall azimuth and elevation adjustable mounting.
- Heavy duty.

Suitable for Mount MNT-22.



### Specifications

#### Mechanical

Enclosure Material	Aluminum A380
Enclosure dimensions (external)	287 x 287 (347 with RJ45) x 68 mm
Base for RF plate material	Aluminum
Base for RF dimensions	245 x 245 mm, height of PCB (from Base for RF to backplane) - 55 mm
Enclosure Finish	White electrostatic powder coating
Connector	RJ45 Ethernet Waterproof Connector
Weight (without MNT-22)	1.35 kg.
Suitable for pole diameter range	25-120 mm (Screws supplied are 80 mm. Longer screws are available on request)

#### Environmental

Operating Temperature Range	-40°C to +65°C
Vibration	According to IEC 60721-3-4
Flammability	UL94
Ice and Snow	25 mm radial (survival)
Water proofing	IP-67
Humidity	ETS 300 019-1-4, EN 302 085 (annex A.1.1)

### Ordering Options

MK-EL30	Base for RF PCB
MK-EL31	Base for RF PCB with embedded PEMs suitable for RB-411/RB-711 and RB-433/RB-733

MARS Antennas & RF Systems proprietary information

MARS reserves the right to make technical changes or modifications to any of its products and specifications without prior notice and without implementing such changes to prior supplied products. Product images are representative and indicative only. Warranty terms and general conditions of sale are applicable on any purchase of any product, available on MARS website.

3 Hamanor st. Holon 5886103, P.O.Box 1852 Holon 5811801, Israel

Tel: +972-3-5599661 • Fax: +972-3-5599677 • e-mail: mars@marsant.co.il • web: www.mars-antennas.com

## MG-XXX Series

### Ground Plane for MA-WO-UMB

#### MG-400

400X400 mm  
ground Plane for  
MA-WO-UMB Antenna  
(for 138-174 MHz)

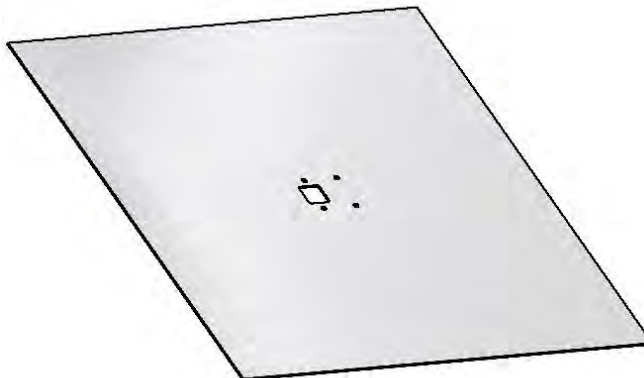

#### MG-370

370X370 mm  
ground Plane for  
MA-WO-UMB Antenna  
(for 380-450 MHz)

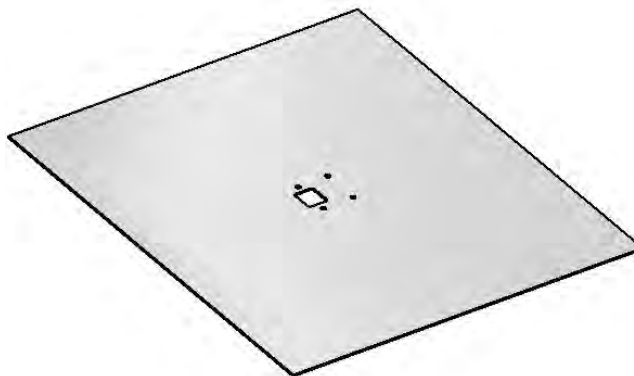

#### MG-165

165X165 mm  
ground Plane for  
MA-WO-UMB Antenna  
(for 406-960 MHz)

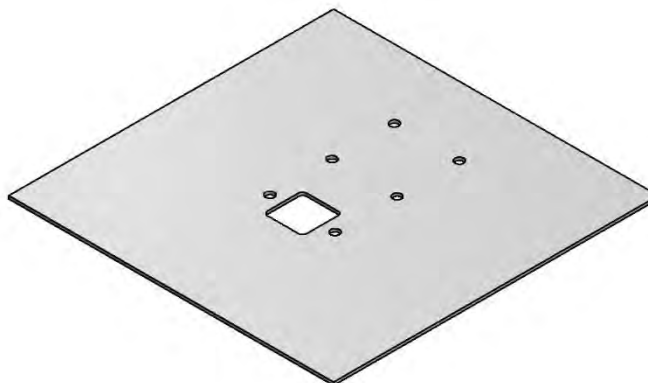

MARS Antennas & RF Systems proprietary information

MARS reserves the right to make technical changes or modifications to any of its products and specifications without prior notice and without implementing such changes to prior supplied products. Product images are representative and indicative only. Warranty terms and general conditions of sale are applicable on any purchase of any product, available on MARS website.

3 Hamanor st. Holon 5886103, P.O.Box 1852 Holon 5811801, Israel

Tel: +972-3-5599661 • Fax: +972-3-5599677 • e-mail: mars@marsant.co.il • web: www.mars-antennas.com



3 Hamanor st. Holon 5886103, Israel

P.O.B 1852 Holon 5811801, Israel

Tel: +972-3-5599661

Fax: +972-3-5599677

E-mail: mars@marsant.co.il

www.mars-antennas.com

