

E-LINE CTK

CABLE TRAY SYSTEMS



Hot Dip Galvanized
CTK Snap-on Cover
Cable Tray Systems



CTK

E-Line CTK

Cable Trays and Modules

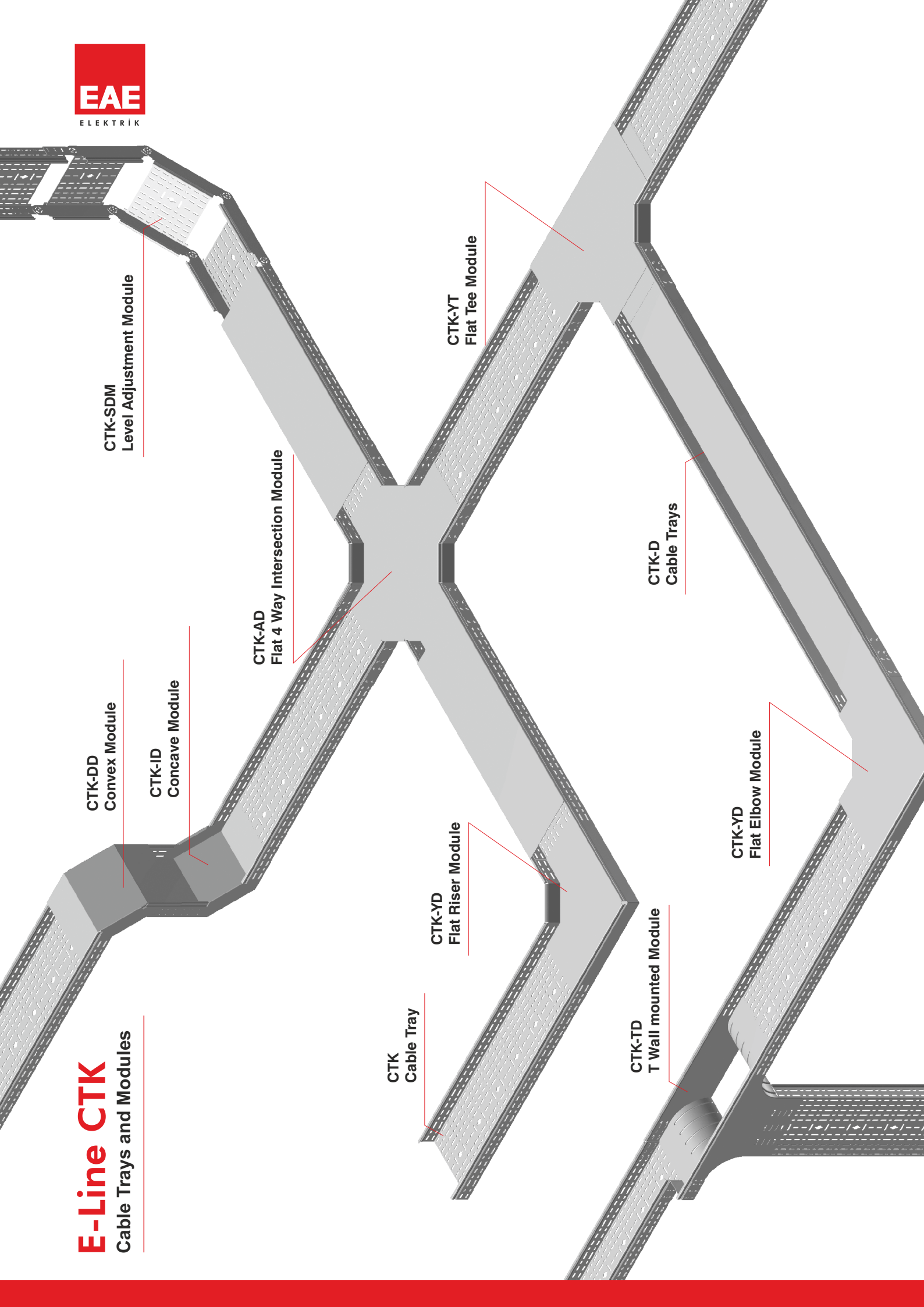

CTK-SDM
Level Adjustment Module

CTK-YT
Flat Tee Module

CTK-AD
Flat 4 Way Intersection Module

CTK-D
Cable Trays

CTK-DD
Convex Module

CTK-ID
Concave Module

CTK
Cable Tray

CTK-YD
Flat Riser Module

CTK-YD
Flat Elbow Module

CTK-TD
T Wall mounted Module

CONTENTS

2	CTK Cable Tray
3	CTK-D Cable Tray
4-11	CTK Cable Tray Modules
12	CTK Joint Fitting
13	CTK Level Adaptation Module
14	CTK Level Adaptation Joint, Hinged Joint, Separator
15-17	CTK Reduction
18	CTK End Cover

CABLE TRAYS SYSTEMS

▶▶ CTK CABLE TRAYS

Hot Dip Galvanized After Fabrication (TS EN ISO 1461)

Description	H (mm)	A (mm)	T (mm)	Weight (kg./m)	Order Code
060 CTK 100	60	100	1,5	2,674	2002142
CTK 100 COVER		100	1,5	1,810	2002190
060 CTK 150	60	150	1,5	3,204	2002143
CTK 150 COVER		150	1,5	2,456	2002191
060 CTK 200	60	200	1,5	3,720	2002144
CTK 200 COVER		200	1,5	3,104	2002192
060 CTK 250	60	250	1,5	4,252	2002145
CTK 250 COVER		250	1,5	3,752	2002193
060 CTK 300	60	300	1,5	4,782	2002146
CTK 300 COVER		300	1,5	4,337	2002194
060 CTK 400	60	400	2	7,969	2002147
CTK 400 COVER		400	2	7,593	2002195
060 CTK 500	60	500	2	9,225	2002148
CTK 500 COVER		500	2	9,321	2002196
060 CTK 600	60	600	2	10,641	2002149
CTK 600 COVER		600	2	11,046	2002197
<hr/>					
075 CTK 100	75	100	1,5	2,946	2002150
CTK 100 COVER		100	1,5	1,810	2002190
075 CTK 150	75	150	1,5	3,476	2002151
CTK 150 COVER		150	1,5	2,456	2002191
075 CTK 200	75	200	1,5	4,007	2002152
CTK 200 COVER		200	1,5	3,104	2002192
075 CTK 250	75	250	1,5	4,538	2002153
CTK 250 COVER		250	1,5	3,752	2002193
075 CTK 300	75	300	1,5	5,069	2002154
CTK 300 COVER		300	1,5	4,337	2002194
075 CTK 400	75	400	2	8,173	2002155
CTK 400 COVER		400	2	7,593	2002195
075 CTK 500	75	500	2	9,586	2002156
CTK 500 COVER		500	2	9,321	2002196
075 CTK 600	75	600	2	11,002	2002157
CTK 600 COVER		600	2	11,046	2002197

Cable Trays

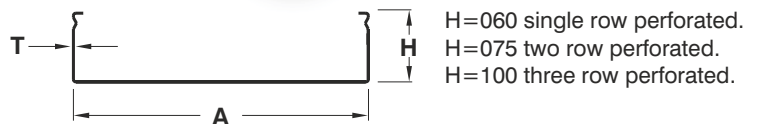
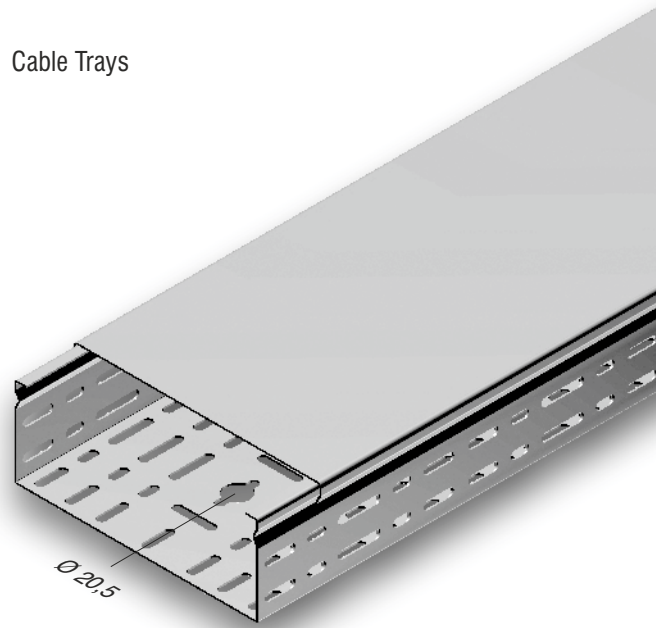

Description	H (mm)	A (mm)	T (mm)	Weight (kg./m)	Order Code
100 CTK 100	100	100	1,5	3,476	2002158
CTK 100 COVER		100	1,5	1,810	2002190
100 CTK 150	100	150	1,5	4,007	2002159
CTK 150 COVER		150	1,5	2,456	2002191
100 CTK 200	100	200	1,5	4,538	2002160
CTK 200 COVER		200	1,5	3,104	2002192
100 CTK 250	100	250	1,5	5,069	2002161
CTK 250 COVER		250	1,5	3,752	2002193
100 CTK 300	100	300	1,5	5,619	2002162
CTK 300 COVER		300	1,5	4,337	2002194
100 CTK 400	100	400	2	8,881	2002163
CTK 400 COVER		400	2	7,593	2002195
100 CTK 500	100	500	2	10,322	2002164
CTK 500 COVER		500	2	9,321	2002196
100 CTK 600	100	600	2	11,712	2002165
CTK 600 COVER		600	2	11,046	2002197

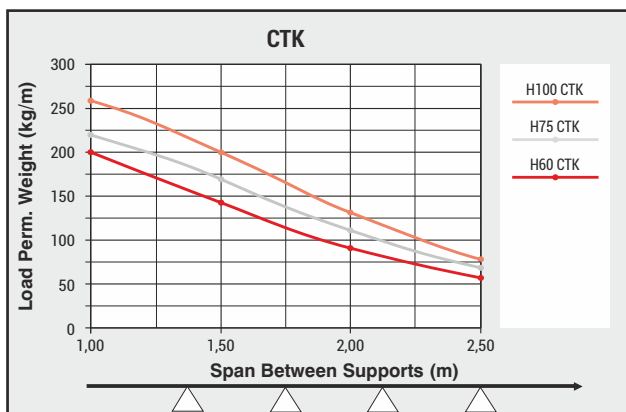

■ Load Perm. Weight may change +/- according to the sheet tolerance and hardness.

Please contact to your customer representative for detailed information.

Sample Order:

Height (H): 100 mm,
Width (A): 200 mm,
Sheet Thickness (T): 1,5 mm,
Plating Type (S): Hot Dip Galvanized,
Module Type: Cable Trays.

- Standard Length 3000 mm.
- For special orders and specifications please contact us.
- Please state the order code when ordering.
- Material weights may vary by ± 10%

▶▶ CTK-D CABLE TRAYS

Hot Dip Galvanized After Fabrication (TS EN ISO 1461)

Description	H (mm)	A (mm)	T (mm)	Weight (kg./m)	Order Code
060 CTK-D 100	60	100	1,5	2,993	2002166
CTK-D 100 COVER		100	1,5	1,810	2002190
060 CTK-D 150	60	150	1,5	3,641	2002167
CTK-D 150 COVER		150	1,5	2,456	2002191
060 CTK-D 200	60	200	1,5	4,289	2002168
CTK-D 200 COVER		200	1,5	3,104	2002192
060 CTK-D 250	60	250	1,5	4,937	2002169
CTK-D 250 COVER		250	1,5	3,752	2002193
060 CTK-D 300	60	300	1,5	5,584	2002170
CTK-D 300 COVER		300	1,5	4,337	2002194
060 CTK-D 400	60	400	2	9,332	2002171
CTK-D 400 COVER		400	2	7,593	2002195
060 CTK-D 500	60	500	2	10,899	2002172
CTK-D 500 COVER		500	2	9,321	2002196
060 CTK-D 600	60	600	2	12,627	2002173
CTK-D 600 COVER		600	2	11,046	2002197
<hr/>					
075 CTK-D 100	75	100	1,5	3,374	2002174
CTK-D 100 COVER		100	1,5	1,810	2002190
075 CTK-D 150	75	150	1,5	4,022	2002175
CTK-D 150 COVER		150	1,5	2,456	2002191
075 CTK-D 200	75	200	1,5	4,668	2002176
CTK-D 200 COVER		200	1,5	3,104	2002192
075 CTK-D 250	75	250	1,5	5,171	2002177
CTK-D 250 COVER		250	1,5	3,752	2002193
075 CTK-D 300	75	300	1,5	5,964	2002178
CTK-D 300 COVER		300	1,5	4,337	2002194
075 CTK-D 400	75	400	2	9,679	2002179
CTK-D 400 COVER		400	2	7,593	2002195
075 CTK-D 500	75	500	2	11,419	2002180
CTK-D 500 COVER		500	2	9,321	2002196
075 CTK-D 600	75	600	2	13,144	2002181
CTK-D 600 COVER		600	2	11,046	2002197

Non Perforated Cable Tray

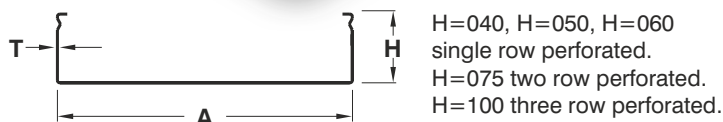
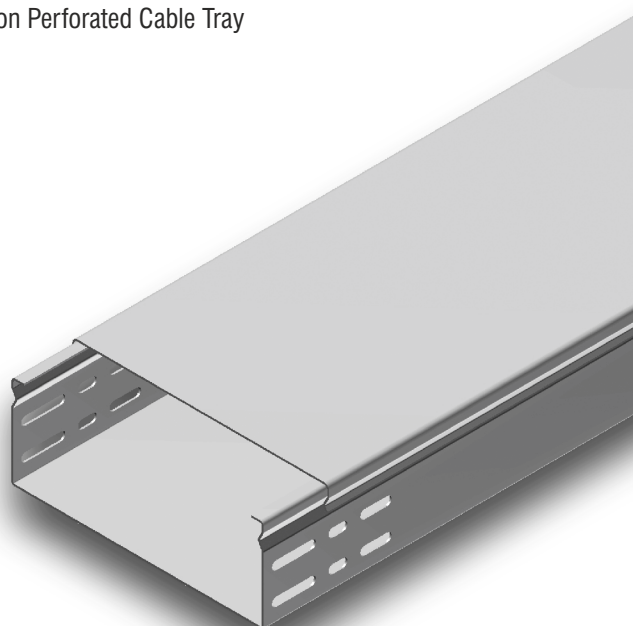

Description	H (mm)	A (mm)	T (mm)	Weight (kg./m)	Order Code
100 CTK-D 100	100	100	1,5	4,013	2002182
CTK-D 100 COVER		100	1,5	1,810	2002190
100 CTK-D 150	100	150	1,5	4,661	2002183
CTK-D 150 COVER		150	1,5	2,456	2002191
100 CTK-D 200	100	200	1,5	5,308	2002184
CTK-D 200 COVER		200	1,5	3,104	2002192
100 CTK-D 250	100	250	1,5	5,955	2002185
CTK-D 250 COVER		250	1,5	3,752	2002193
100 CTK-D 300	100	300	1,5	6,623	2002186
CTK-D 300 COVER		300	1,5	4,337	2002194
100 CTK-D 400	100	400	2	10,531	2002187
CTK-D 400 COVER		400	2	7,593	2002195
100 CTK-D 500	100	500	2	12,247	2002188
CTK-D 500 COVER		500	2	9,321	2002196
100 CTK-D 600	100	600	2	14,020	2002189
CTK-D 600 COVER		600	2	11,046	2002197

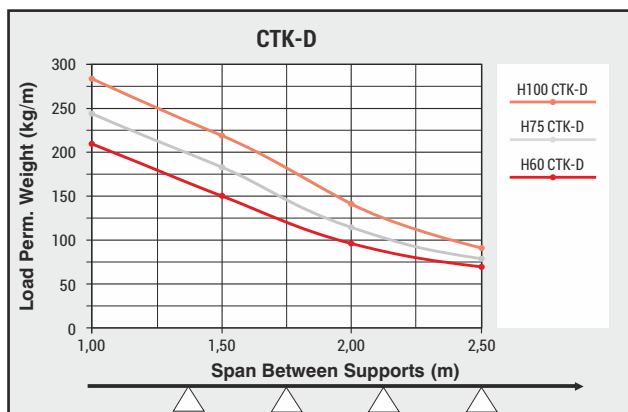

■ Load Perm. Weight may change +/- according to the sheet tolerance and hardness.
Please contact to your customer representative for detailed information.

Sample Order:
Height (H): 75 mm,
Width (A): 500 mm,
Sheet Thickness (T): 1,5 mm,
Plating Type (S): Hot Dip Galvanized,
Module Type: Non perforated cable tray

- Standard Length 3000 mm.
- For special orders and specifications please contact us.
- Please state the order code when ordering.
- Material weights may vary by ± 10%

▶▶ CTK FLAT ELBOW MODULE (45°)

Hot Dip Galvanized After Fabrication (TS EN ISO 1461)

Description	H (mm)	A (mm)	T (mm)	Weight (kg/m)	Order Code
060 CTK 100 YD 45°	60	100	1,5	2,225	3006490
060 CTK 150 YD 45°	60	150	1,5	2,930	3006491
060 CTK 200 YD 45°	60	200	1,5	3,672	3006492
060 CTK 250 YD 45°	60	250	1,5	4,498	3006493
060 CTK 300 YD 45°	60	300	1,5	6,043	3006494
060 CTK 400 YD 45°	60	400	1,5	8,234	3006495
060 CTK 500 YD 45°	60	500	1,5	10,674	3006496
060 CTK 600 YD 45°	60	600	1,5	13,364	3006497
075 CTK 100 YD 45°	75	100	1,5	2,371	3006498
075 CTK 150 YD 45°	75	150	1,5	3,083	3006499
075 CTK 200 YD 45°	75	200	1,5	3,832	3006500
075 CTK 250 YD 45°	75	250	1,5	4,668	3006501
075 CTK 300 YD 45°	75	300	1,5	6,222	3006502
075 CTK 400 YD 45°	75	400	1,5	8,426	3006503
075 CTK 500 YD 45°	75	500	1,5	10,885	3006504
075 CTK 600 YD 45°	75	600	1,5	13,591	3006505
100 CTK 100 YD 45°	100	100	1,5	2,630	3006506
100 CTK 150 YD 45°	100	150	1,5	3,357	3006507
100 CTK 200 YD 45°	100	200	1,5	4,129	3006508
100 CTK 250 YD 45°	100	250	1,5	4,968	3006509
100 CTK 300 YD 45°	100	300	1,5	6,534	3006510
100 CTK 400 YD 45°	100	400	1,5	8,466	3006511
100 CTK 500 YD 45°	100	500	1,5	11,251	3006512
100 CTK 600 YD 45°	100	600	1,5	13,983	3006513

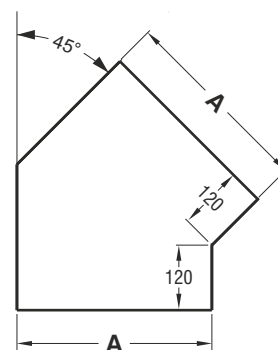
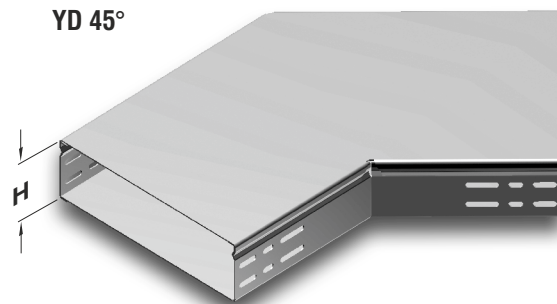

H=060 single row perforated.
 H=075 two rows perforated.
 H=100 three rows perforated.

Sample Order:
 Height (H): 60 mm,
 Width (A,B): 500 mm,
 Sheet Thickness (T): 1,5 mm,
 Plating Type (S): Hot Dip Galvanized,
 Module Type: Flat Elbow Module 45°

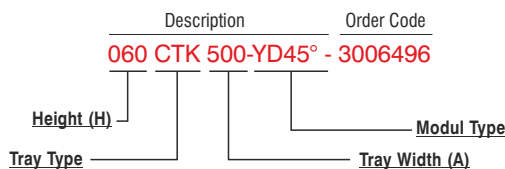

■ Please state the order code when ordering.

■ Material weights may vary by ± 10%

■ For special orders and specifications please contact us.

▶▶ CTK FLAT ELBOW MODULE (90°) Hot Dip Galvanized After Fabrication (TS EN ISO 1461)

Description	H (mm)	A (mm)	T (mm)	Weight (kg/m)	Order Code
060 CTK 100 YD	60	100	1,5	3,023	3006514
060 CTK 150 YD	60	150	1,5	4,187	3006515
060 CTK 200 YD	60	200	1,5	5,506	3006516
060 CTK 250 YD	60	250	1,5	6,974	3006517
060 CTK 300 YD	60	300	1,5	8,593	3006518
060 CTK 400 YD	60	400	1,5	12,286	3006519
060 CTK 500 YD	60	500	1,5	16,583	3006520
060 CTK 600 YD	60	600	1,5	21,427	3006521
<hr/>					
075 CTK 100 YD	75	100	1,5	3,197	3006522
075 CTK 150 YD	75	150	1,5	4,381	3006523
075 CTK 200 YD	75	200	1,5	5,719	3006524
075 CTK 250 YD	75	250	1,5	7,206	3006525
075 CTK 300 YD	75	300	1,5	8,845	3006526
075 CTK 400 YD	75	400	1,5	12,587	3006527
075 CTK 500 YD	75	500	1,5	16,913	3006528
075 CTK 600 YD	75	600	1,5	21,794	3006529
<hr/>					
100 CTK 100 YD	100	100	1,5	3,501	3006530
100 CTK 150 YD	100	150	1,5	4,719	3006531
100 CTK 200 YD	100	200	1,5	6,089	3006532
100 CTK 250 YD	100	250	1,5	7,609	3006533
100 CTK 300 YD	100	300	1,5	9,280	3006534
100 CTK 400 YD	100	400	1,5	13,076	3006535
100 CTK 500 YD	100	500	1,5	17,477	3006536
100 CTK 600 YD	100	600	1,5	22,424	3006537

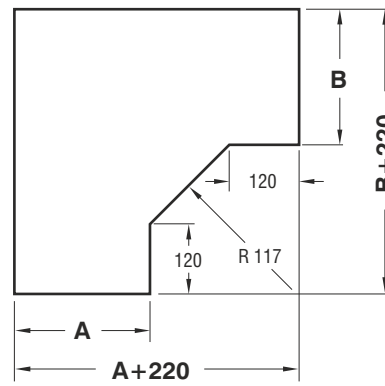
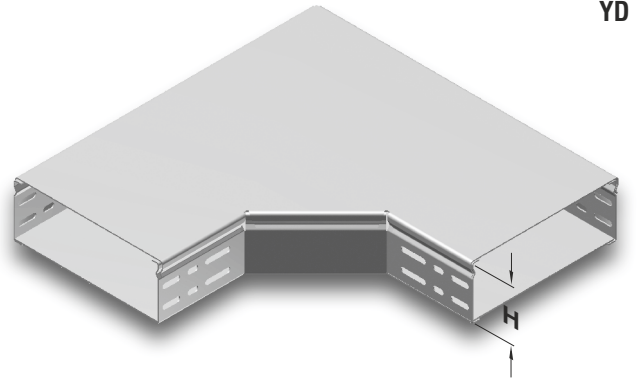

H=060 single row perforated.
H=075 two rows perforated.
H=100 three rows perforated.

Sample Order:
Height (H): 100 mm,
Width (A): 200 mm,
Sheet Thickness (T): 1,5 mm,
Plating Type (S): Hot Dip Galvanized,
Module Type: Flat Elbow Module 90°

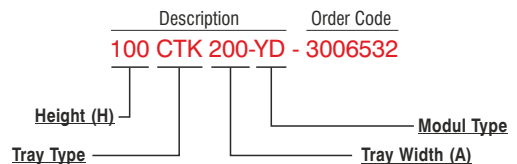

■ Please state the order code when ordering.

■ Material weights may vary by ± 10%

■ For special orders and specifications please contact us.

▶▶ CTK FLAT “T” MODULE

Hot Dip Galvanized After Fabrication (TS EN ISO 1461)

Description	H (mm)	ABC (mm)	T (mm)	Weight (kg./pc.)	Order Code
060 CTK 100 YT	60	100	1,5	4,178	3006538
060 CTK 150 YT	60	150	1,5	5,611	3006539
060 CTK 200 YT	60	200	1,5	7,195	3006540
060 CTK 250 YT	60	250	1,5	8,931	3006541
060 CTK 300 YT	60	300	1,5	10,817	3006542
060 CTK 400 YT	60	400	1,5	15,044	3006543
060 CTK 500 YT	60	500	1,5	19,875	3006544
060 CTK 600 YT	60	600	1,5	23,008	3006545
075 CTK 100 YT	75	100	1,5	4,417	3006546
075 CTK 150 YT	75	150	1,5	6,042	3006547
075 CTK 200 YT	75	200	1,5	7,429	3006548
075 CTK 250 YT	75	250	1,5	9,175	3006549
075 CTK 300 YT	75	300	1,5	11,070	3006550
075 CTK 400 YT	75	400	1,5	15,316	3006551
075 CTK 500 YT	75	500	1,5	20,166	3006552
075 CTK 600 YT	75	600	1,5	23,320	3006553
100 CTK 100 YT	100	100	1,5	4,776	3006554
100 CTK 150 YT	100	150	1,5	6,235	3006555
100 CTK 200 YT	100	200	1,5	7,842	3006556
100 CTK 250 YT	100	250	1,5	9,603	3006557
100 CTK 300 YT	100	300	1,5	11,519	3006558
100 CTK 400 YT	100	400	1,5	15,797	3006559
100 CTK 500 YT	100	500	1,5	20,680	3006560
100 CTK 600 YT	100	600	1,5	23,865	3006561

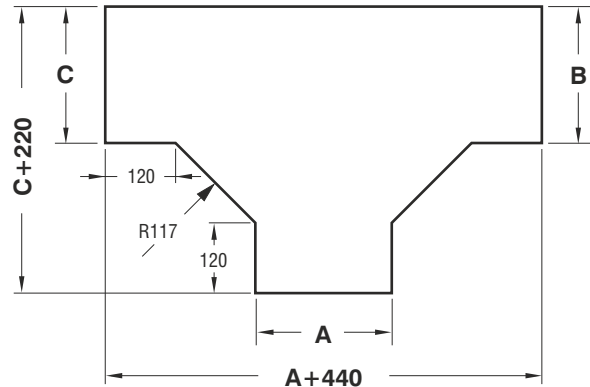
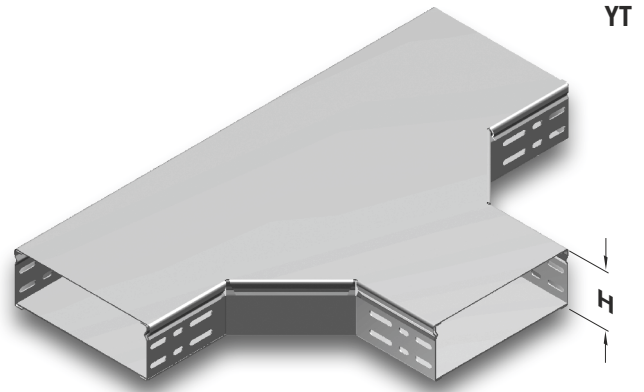

H=060 single row perforated.
 H=075 two rows perforated.
 H=100 three rows perforated.

Sample Order:
 Height (H): 75 mm,
 Width (A,B,C): 200 mm,
 Sheet Thickness (T): 1,5 mm,
 Plating Type (S): Hot Dip Galvanized,
 Module Type: Flat “T”Module.

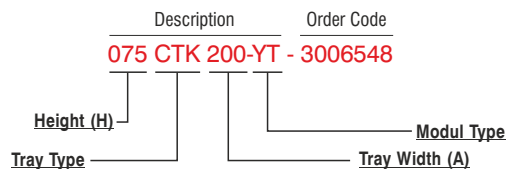

■ Please state the order code when ordering.

■ Material weights may vary by ± 10%

■ For special orders and specifications please contact us.

►► CTK FLAT 4 WAY INTERSECTION MODULE

Hot Dip Galvanized After Fabrication (TS EN ISO 1461)

Description	H (mm)	ABCD (mm)	T (mm)	Weight (kg./pc.)	Order Code
060 CTK 100 AD	60	100	1,5	5,057	3006562
060 CTK 150 AD	60	150	1,5	7,086	3006563
060 CTK 200 AD	60	200	1,5	8,938	3006564
060 CTK 250 AD	60	250	1,5	10,941	3006565
060 CTK 300 AD	60	300	1,5	13,093	3006566
060 CTK 400 AD	60	400	1,5	17,854	3006567
060 CTK 500 AD	60	500	1,5	23,219	3006568
060 CTK 600 AD	60	600	1,5	29,189	3006569
<hr/>					
075 CTK 100 AD	75	100	1,5	5,631	3006570
075 CTK 150 AD	75	150	1,5	7,332	3006571
075 CTK 200 AD	75	200	1,5	9,183	3006572
075 CTK 250 AD	75	250	1,5	11,185	3006573
075 CTK 300 AD	75	300	1,5	13,339	3006574
075 CTK 400 AD	75	400	1,5	18,099	3006575
075 CTK 500 AD	75	500	1,5	23,464	3006576
075 CTK 600 AD	75	600	1,5	29,434	3006577
<hr/>					
100 CTK 100 AD	100	100	1,5	6,074	3006578
100 CTK 150 AD	100	150	1,5	7,774	3006579
100 CTK 200 AD	100	200	1,5	9,625	3006580
100 CTK 250 AD	100	250	1,5	11,628	3006581
100 CTK 300 AD	100	300	1,5	13,782	3006582
100 CTK 400 AD	100	400	1,5	18,542	3006583
100 CTK 500 AD	100	500	1,5	23,906	3006584
100 CTK 600 AD	100	600	1,5	29,876	3006585

Flat 4 Way Intersection Module

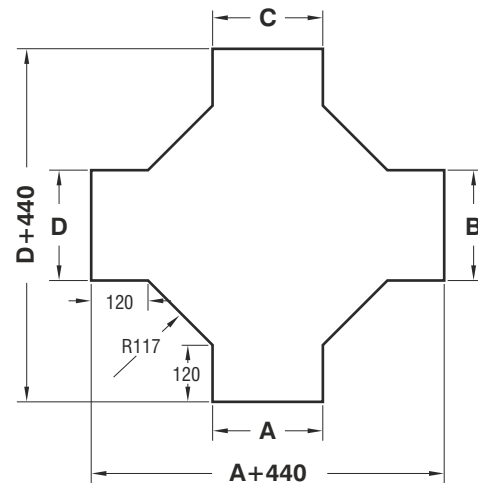
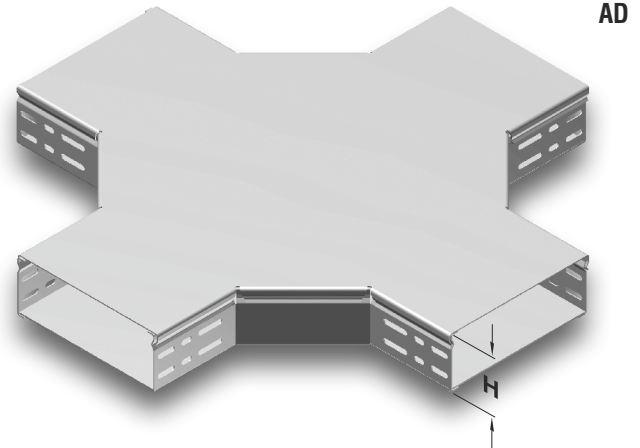

H=060 single row perforated.
H=075 two rows perforated.
H=100 three rows perforated.

Sample Order:
Height (H): 100 mm,
Width (A,B,C,D): 400 mm,
Sheet Thickness (T): 1,5 mm,
Plating Type (S): Hot Dip Galvanized,
Module Type: Flat 4 Way Intersection Module

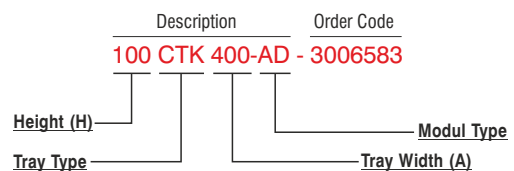

■ Please state the order code when ordering.

■ Material weights may vary by ± 10%

■ For special orders and specifications please contact us.

▶▶ CTK "T" CENTRE DESCENT MODULE

Hot Dip Galvanized After Fabrication (TS EN ISO 1461)

Description	H (mm)	A (mm)	T (mm)	Weight (kg./pc.)	Order Code
060 CTK 100 TO	60	100	1,5	3,886	3006586
060 CTK 150 TO	60	150	1,5	4,926	3006587
060 CTK 200 TO	60	200	1,5	5,964	3006588
060 CTK 250 TO	60	250	1,5	7,004	3006589
060 CTK 300 TO	60	300	1,5	8,042	3006590
060 CTK 400 TO	60	400	1,5	10,120	3006591
060 CTK 500 TO	60	500	1,5	12,198	3006592
060 CTK 600 TO	60	600	1,5	14,277	3006593
<hr/>					
075 CTK 100 TO	75	100	1,5	4,105	3006594
075 CTK 150 TO	75	150	1,5	5,144	3006595
075 CTK 200 TO	75	200	1,5	6,183	3006596
075 CTK 250 TO	75	250	1,5	7,222	3006597
075 CTK 300 TO	75	300	1,5	8,261	3006598
075 CTK 400 TO	75	400	1,5	10,339	3006599
075 CTK 500 TO	75	500	1,5	12,417	3006600
075 CTK 600 TO	75	600	1,5	14,495	3006601
<hr/>					
100 CTK 100 TO	100	100	1,5	4,615	3006602
100 CTK 150 TO	100	150	1,5	5,653	3006603
100 CTK 200 TO	100	200	1,5	6,692	3006604
100 CTK 250 TO	100	250	1,5	7,731	3006605
100 CTK 300 TO	100	300	1,5	8,770	3006606
100 CTK 400 TO	100	400	1,5	10,848	3006607
100 CTK 500 TO	100	500	1,5	12,926	3006608
100 CTK 600 TO	100	600	1,5	15,004	3006609

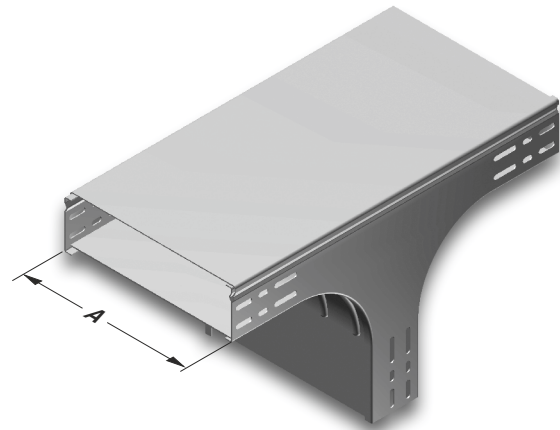

TO

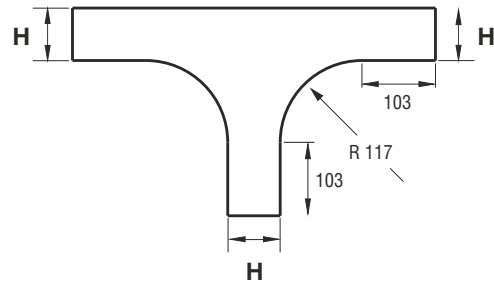

H=060 single row perforated.
H=075 two rows perforated.
H=100 three rows perforated.

Sample Order:
Height (H): 75 mm,
Width (A): 400 mm,
Sheet Thickness (T): 1,5 mm,
Plating Type (S): Hot Dip Galvanized,
Module Type: "T" Centre

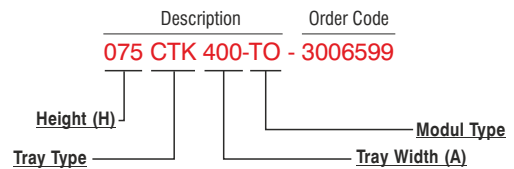

■ Please state the order code when ordering.

■ Material weights may vary by ± 10%

■ For special orders and specifications please contact us.

▶▶ CTK "T" WALL MOUNTED MODULE

Hot Dip Galvanized After Fabrication (TS EN ISO 1461)

Description	H (mm)	A (mm)	B (mm)	T (mm)	Weight (kg./pc.)	Order Code
060 CTK 100 TD	60	100	100	1,5	3,726	3006756
060 CTK 150 TD	60	150	150	1,5	5,046	3006757
060 CTK 200 TD	60	200	200	1,5	6,401	3006758
060 CTK 250 TD	60	250	250	1,5	7,866	3006759
060 CTK 300 TD	60	300	300	1,5	9,372	3006760
060 CTK 400 TD	60	400	300	1,5	13,388	3006761
060 CTK 500 TD	60	500	300	1,5	15,250	3006762
060 CTK 600 TD	60	600	300	1,5	17,767	3006763
075 CTK 100 TD	75	100	100	1,5	3,907	3006764
075 CTK 150 TD	75	150	150	1,5	5,276	3006765
075 CTK 200 TD	75	200	200	1,5	6,672	3006766
075 CTK 250 TD	75	250	250	1,5	8,109	3006767
075 CTK 300 TD	75	300	300	1,5	9,633	3006768
075 CTK 400 TD	75	400	300	1,5	14,173	3006769
075 CTK 500 TD	75	500	300	1,5	16,060	3006770
075 CTK 600 TD	75	600	300	1,5	18,737	3006771
100 CTK 100 TD	100	100	100	1,5	4,231	3006772
100 CTK 150 TD	100	150	150	1,5	5,545	3006773
100 CTK 200 TD	100	200	200	1,5	7,060	3006774
100 CTK 250 TD	100	250	250	1,5	8,514	3006775
100 CTK 300 TD	100	300	300	1,5	10,064	3006776
100 CTK 400 TD	100	400	300	1,5	16,122	3006777
100 CTK 500 TD	100	500	300	1,5	18,823	3006778
100 CTK 600 TD	100	600	300	1,5	21,529	3006779

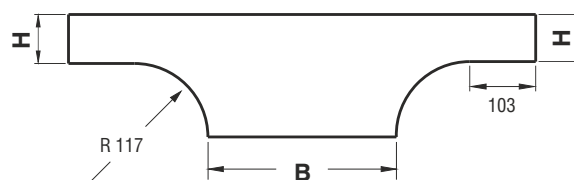
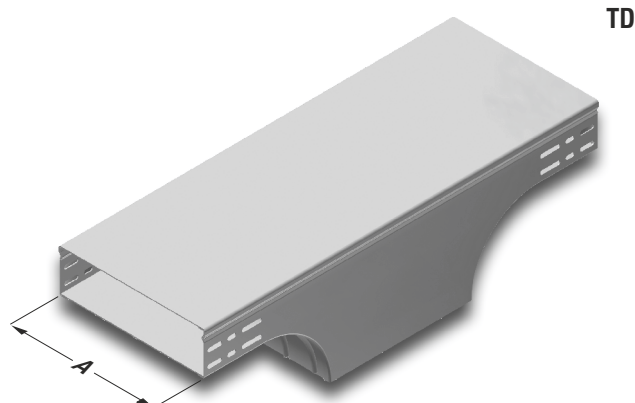

H=060 single row perforated.
 H=075 two rows perforated.
 H=100 three rows perforated.

Sample Order:
 Height (H): 100 mm,
 Width (A): 300 mm,
 Sheet Thickness (T): 1,5 mm,
 Plating Type (S): Hot Dip Galvanized,
 Module Type: "T" Wall Mounted Module

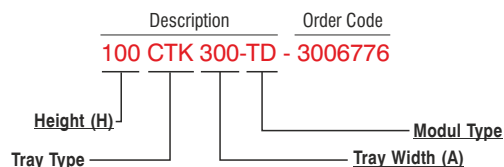

■ Please state the order code when ordering.

■ Material weights may vary by ± 10%

■ For special orders and specifications please contact us.

▶▶ CTK CONCAVE MODULE (90°)

Hot Dip Galvanized After Fabrication (TS EN ISO 1461)

Description	H (mm)	A (mm)	T (mm)	Weight (kg./pc.)	Order Code
060 CTK 100 ID	60	100	1,5	2,122	3006708
060 CTK 150 ID	60	150	1,5	2,674	3006709
060 CTK 200 ID	60	200	1,5	3,225	3006710
060 CTK 250 ID	60	250	1,5	3,777	3006711
060 CTK 300 ID	60	300	1,5	4,330	3006712
060 CTK 400 ID	60	400	1,5	5,433	3006713
060 CTK 500 ID	60	500	1,5	5,924	3006714
060 CTK 600 ID	60	600	1,5	7,150	3006715
075 CTK 100 ID	75	100	1,5	2,325	3006716
075 CTK 150 ID	75	150	1,5	2,893	3006717
075 CTK 200 ID	75	200	1,5	3,462	3006718
075 CTK 250 ID	75	250	1,5	4,029	3006719
075 CTK 300 ID	75	300	1,5	4,598	3006720
075 CTK 400 ID	75	400	1,5	5,733	3006721
075 CTK 500 ID	75	500	1,5	6,870	3006722
075 CTK 600 ID	75	600	1,5	8,006	3006723
100 CTK 100 ID	100	100	1,5	2,701	3006724
100 CTK 150 ID	100	150	1,5	3,295	3006725
100 CTK 200 ID	100	200	1,5	3,887	3006726
100 CTK 250 ID	100	250	1,5	4,481	3006727
100 CTK 300 ID	100	300	1,5	5,075	3006728
100 CTK 400 ID	100	400	1,5	6,263	3006729
100 CTK 500 ID	100	500	1,5	7,451	3006730
100 CTK 600 ID	100	600	1,5	8,639	3006731

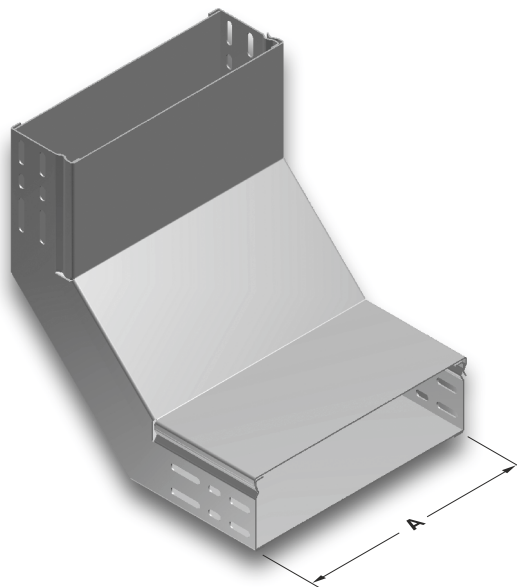

ID

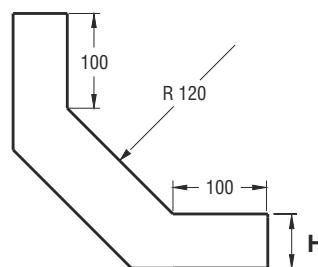

Sample Order:
 Height (H): 100 mm,
 Width (A): 300 mm,
 Sheet Thickness (T): 1,5 mm,
 Plating Type (S): Hot Dip Galvanized,
 Module Type: Concave Module.

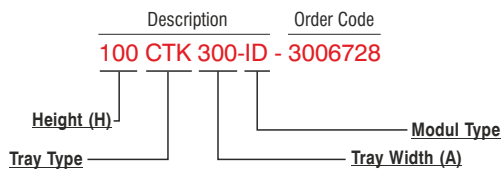

■ Please state the order code when ordering.

■ Material weights may vary by ± 10%

■ For special orders and specifications please contact us.

▶▶ CTK CONVEX MODULE (90°)

Hot Dip Galvanized After Fabrication (TS EN ISO 1461)

Description	H (mm)	A (mm)	T (mm)	Weight (kg./pc.)	Order Code
060 CTK 100 DD	60	100	1,5	2,180	3006732
060 CTK 150 DD	60	150	1,5	2,743	3006733
060 CTK 200 DD	60	200	1,5	3,306	3006734
060 CTK 250 DD	60	250	1,5	3,868	3006735
060 CTK 300 DD	60	300	1,5	4,430	3006736
060 CTK 400 DD	60	400	1,5	5,554	3006737
060 CTK 500 DD	60	500	1,5	6,678	3006738
060 CTK 600 DD	60	600	1,5	7,803	3006739
<hr/>					
075 CTK 100 DD	75	100	1,5	2,329	3006740
075 CTK 150 DD	75	150	1,5	2,892	3006741
075 CTK 200 DD	75	200	1,5	3,454	3006742
075 CTK 250 DD	75	250	1,5	4,016	3006743
075 CTK 300 DD	75	300	1,5	4,578	3006744
075 CTK 400 DD	75	400	1,5	5,702	3006745
075 CTK 500 DD	75	500	1,5	6,827	3006746
075 CTK 600 DD	75	600	1,5	7,951	3006747
<hr/>					
100 CTK 100 DD	100	100	1,5	2,607	3006748
100 CTK 150 DD	100	150	1,5	3,169	3006749
100 CTK 200 DD	100	200	1,5	3,731	3006750
100 CTK 250 DD	100	250	1,5	4,293	3006751
100 CTK 300 DD	100	300	1,5	4,855	3006752
100 CTK 400 DD	100	400	1,5	5,980	3006753
100 CTK 500 DD	100	500	1,5	7,105	3006754
100 CTK 600 DD	100	600	1,5	8,229	3006755

DD

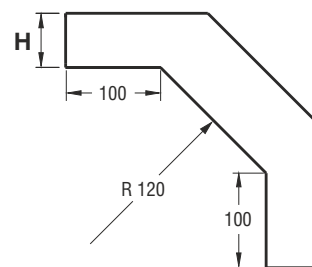
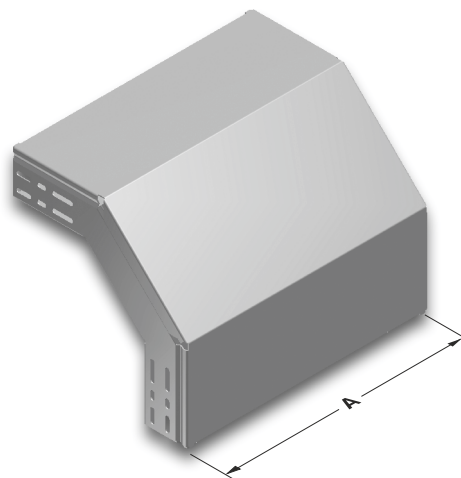

Sample Order:
 Height (H): 100 mm,
 Width (A): 200 mm,
 Sheet Thickness (T): 1,5 mm,
 Plating Type (S): Hot Dip Galvanized,
 Module Type: Convex Module.

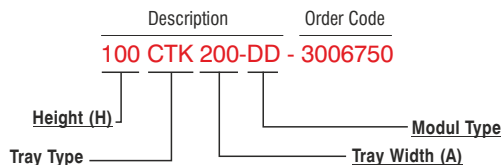

■ Please state the order code when ordering.

■ Material weights may vary by ± 10%

■ For special orders and specifications please contact us.

▶▶ CTK JOINT FITTING

Hot Dip Galvanized After Fabrication (TS EN ISO 1461)

Description	H (mm)	T (mm)	Weight (kg./pc.)	Order Code
60 CTK JOINT FITTING	40	2	0,191	3001965
75-100 CTK JOINT FITTING	55,5	2	0,242	3007413

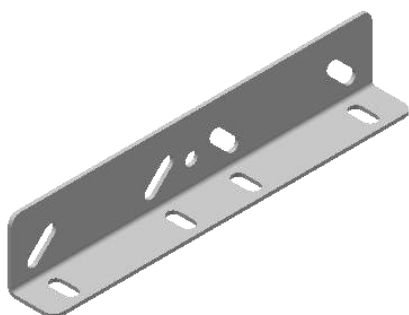

60 CTK CONNECTOR COMPONENT

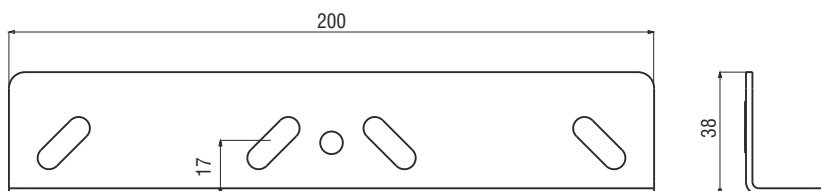

1 Unit of H=60 Connector Component; 4 units M6x12 bolts, 4 units M6 bolt nuts are used.

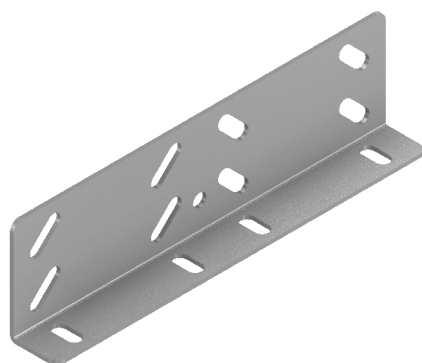

75-100 CTK CONNECTOR COMPONENT

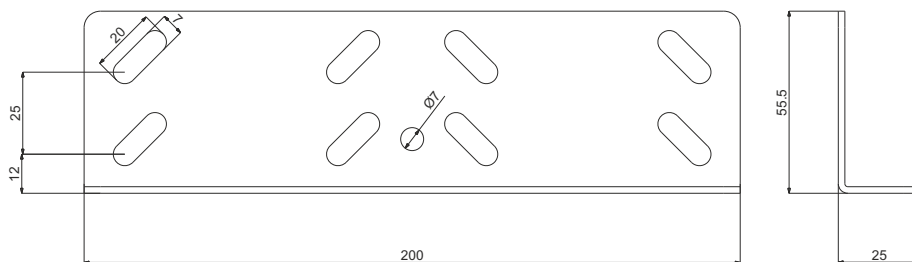

1 Unit of H=75-100 Connector Component; 8 units M6x12 bolts, 8 units M6 bolt nuts are used.

▶▶ CTK LEVEL ADAPTATION MODULE

Hot Dip Galvanized After Fabrication (TS EN ISO 1461)

Description	H (mm)	A (mm)	T (mm)	Weight (kg./set.)	Order Code
060 CTK 100 SDM	60	100	1,5	5,997	3007285
060 CTK 150 SDM	60	150	1,5	7,094	3007286
060 CTK 200 SDM	60	200	1,5	8,190	3007287
060 CTK 250 SDM	60	250	1,5	9,284	3007288
060 CTK 300 SDM	60	300	1,5	10,377	3007289
060 CTK 400 SDM	60	400	1,5	12,570	3007290
060 CTK 500 SDM	60	500	1,5	14,760	3007291
060 CTK 600 SDM	60	600	1,5	16,950	3007292
<hr/>					
075 CTK 100 SDM	75	100	1,5	6,563	3007293
075 CTK 150 SDM	75	150	1,5	7,659	3007294
075 CTK 200 SDM	75	200	1,5	8,756	3007295
075 CTK 250 SDM	75	250	1,5	9,849	3007296
075 CTK 300 SDM	75	300	1,5	10,942	3007297
075 CTK 400 SDM	75	400	1,5	13,135	3007298
075 CTK 500 SDM	75	500	1,5	15,325	3007299
075 CTK 600 SDM	75	600	1,5	17,515	3007300
<hr/>					
100 CTK 100 SDM	100	100	1,5	7,366	3007301
100 CTK 150 SDM	100	150	1,5	8,462	3007302
100 CTK 200 SDM	100	200	1,5	9,559	3007303
100 CTK 250 SDM	100	250	1,5	10,652	3007304
100 CTK 300 SDM	100	300	1,5	11,745	3007305
100 CTK 400 SDM	100	400	1,5	13,938	3007306
100 CTK 500 SDM	100	500	1,5	16,128	3007307
100 CTK 600 SDM	100	600	1,5	18,318	3007308

Grade Changing Module

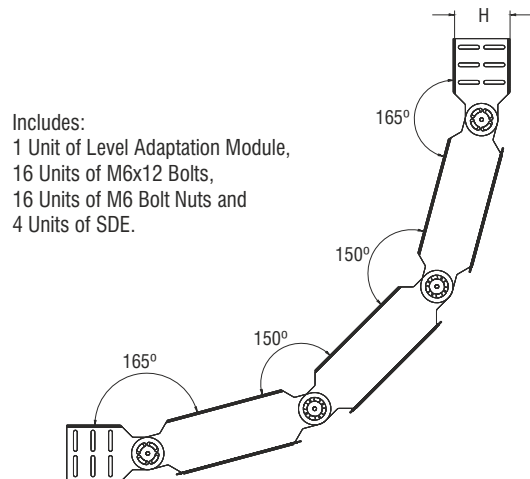
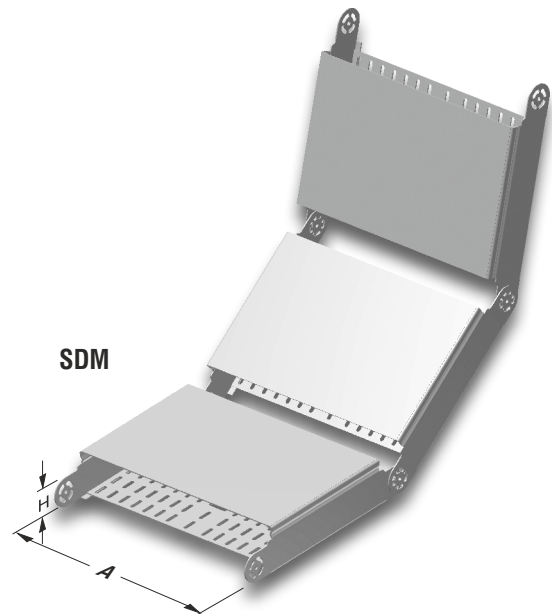

Includes:
 1 Unit of Level Adaptation Module,
 16 Units of M6x12 Bolts,
 16 Units of M6 Bolt Nuts and
 4 Units of SDE.

H=060 single row perforated.
 H=075 two rows perforated.
 H=100 three rows perforated.

Sample Order:
 Height (H): 60 mm,
 Width (A): 400 mm,
 Sheet Thickness (T): 1,5 mm,
 Plating Type (S): Hot Dip Galvanized,
 Module Type: Level Adaptation Module

Description Order Code
060 CTK 400-SDM - 3007290



■ Please state the order code when ordering.

■ Material weights may vary by ± 10%

▶▶ CTK LEVEL ADAPTATION JOINT

Hot Dip Galvanized After Fabrication (TS EN ISO 1461)

Description	H (mm)	T (mm)	Weight (kg./set.)	Order Code
060 CTK SDE	60	2	0,304	3007415
075 CTK SDE	75	2	0,380	3007416
100 CTK SDE	100	2	0,506	3007417

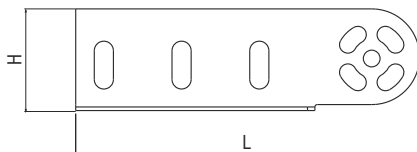

60/75/100 CT-SDE L=160

Grade Changing Connector Set

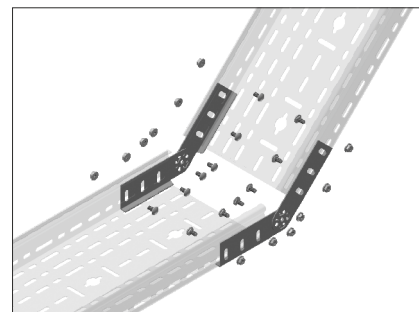
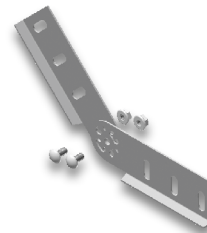

Includes: 4 units of grade changing components, 4 Units of M6x12 Bolts, 4 Units of M6 Bolt Nuts.

▶▶ CTK FLEXIBLE JOINT

Hot Dip Galvanized After Fabrication (TS EN ISO 1461)

Description	H (mm)	T (mm)	Weight (kg./set.)	Order Code
60 FLEXIBLE JOINT (100-150-200-250-300)	53	1,2	0,354	3046731
60 FLEXIBLE JOINT (400-500-600)	53	1,2	0,514	3046732
75 FLEXIBLE JOINT (100-150-200-250-300)	64	1,2	0,466	3046733
75 FLEXIBLE JOINT (400-500-600)	64	1,2	0,677	3046734
100 FLEXIBLE JOINT (100-150-200-250-300)	94	1,2	0,638	3046735
100 FLEXIBLE JOINT (400-500-600)	94	1,2	0,927	3046736

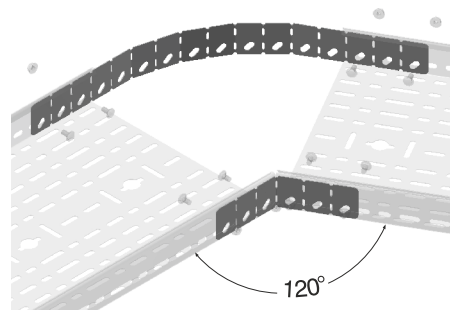

▶▶ CT SEPARATOR

Hot Dip Galvanized After Fabrication (TS EN ISO 1461)

Description	H (mm)	T (mm)	Weight (kg./m.)	Order Code
060 CT SEPARATOR	55	1,2	0,833	3005833
075 CT SEPARATOR	70	1,2	0,991	3006953
100 CT SEPARATOR	95	1,2	1,271	3006952

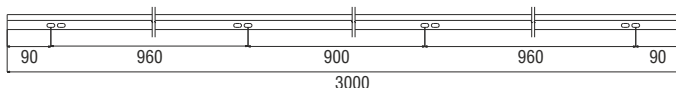
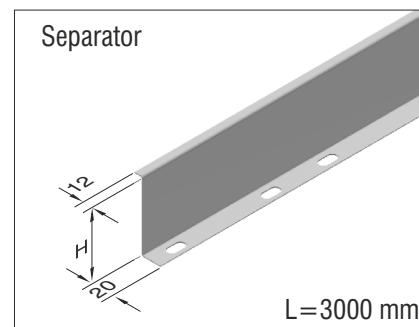

- Please state the order code when ordering.
- For special orders and specifications please contact us.
- Material weights may vary by ± 10%

▶▶ CTK LEFT-HAND REDUCTION

Hot Dip Galvanized After Fabrication (TS EN ISO 1461)

Description	H (mm)	A (mm)	T (mm)	Weight (kg./pc.)	Order Code
60 CTK RD 50	60	50	2	0,187	3007358
60 CTK RD100	60	100	2	0,229	3007359
60 CTK RD150	60	150	2	0,271	3007360
60 CTK RD200	60	200	2	0,312	3007361
60 CTK RD250	60	250	2	0,355	3007362
60 CTK RD300	60	300	2	0,397	3007363
75 CTK RD 50	75	50	2	0,238	3007364
75 CTK RD100	75	100	2	0,293	3007365
75 CTK RD150	75	150	2	0,348	3007366
75 CTK RD200	75	200	2	0,403	3007367
75 CTK RD250	75	250	2	0,458	3007368
75 CTK RD300	75	300	2	0,513	3007369
100 CTK RD 50	100	50	2	0,329	3007370
100 CTK RD100	100	100	2	0,406	3007371
100 CTK RD150	100	150	2	0,483	3007372
100 CTK RD200	100	200	2	0,559	3007373
100 CTK RD250	100	250	2	0,636	3007374
100 CTK RD300	100	300	2	0,713	3007375

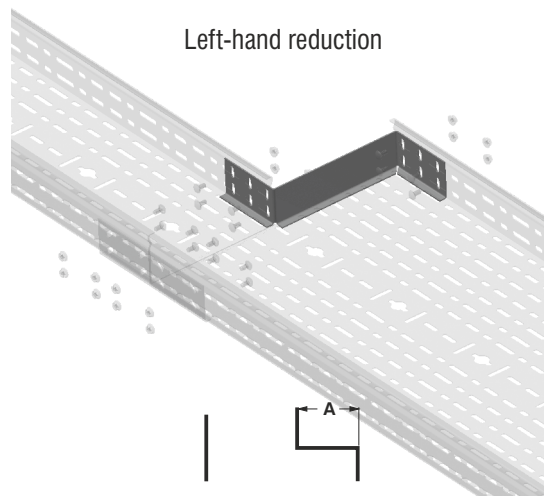

H=060 single row perforated.
H=075 two rows perforated.
H=100 three rows perforated.

Sample Order:
Height (H): 40 mm,
Width (A): 100 mm,
Sheet Thickness (T): 2 mm,
Plating Type (S): Hot Dip Galvanized,
Module Type: Left-hand reduction.

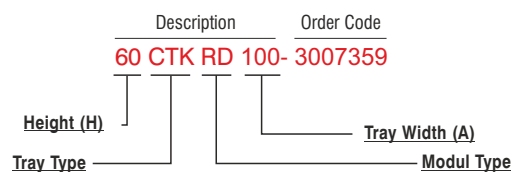

- Please state the order code when ordering.
- For special orders and specifications please contact us.
- Material weights may vary by $\pm 10\%$

▶▶ CTK RIGHT-HAND REDUCTION

Hot Dip Galvanized After Fabrication (TS EN ISO 1461)

Description	H (mm)	A (mm)	T (mm)	Weight (kg./pc.)	Order Code
60 CTK RD 50	60	50	2	0,187	3007376
60 CTK RD100	60	100	2	0,229	3007377
60 CTK RD150	60	150	2	0,271	3007378
60 CTK RD200	60	200	2	0,312	3007379
60 CTK RD250	60	250	2	0,355	3007380
60 CTK RD300	60	300	2	0,397	3007381
75 CTK RD 50	75	50	2	0,238	3007382
75 CTK RD100	75	100	2	0,293	3007383
75 CTK RD150	75	150	2	0,348	3007384
75 CTK RD200	75	200	2	0,403	3007385
75 CTK RD250	75	250	2	0,458	3007386
75 CTK RD300	75	300	2	0,513	3007387
100 CTK RD 50	100	50	2	0,329	3007388
100 CTK RD100	100	100	2	0,406	3007389
100 CTK RD150	100	150	2	0,483	3007390
100 CTK RD200	100	200	2	0,559	3007391
100 CTK RD250	100	250	2	0,636	3007392
100 CTK RD300	100	300	2	0,713	3007393

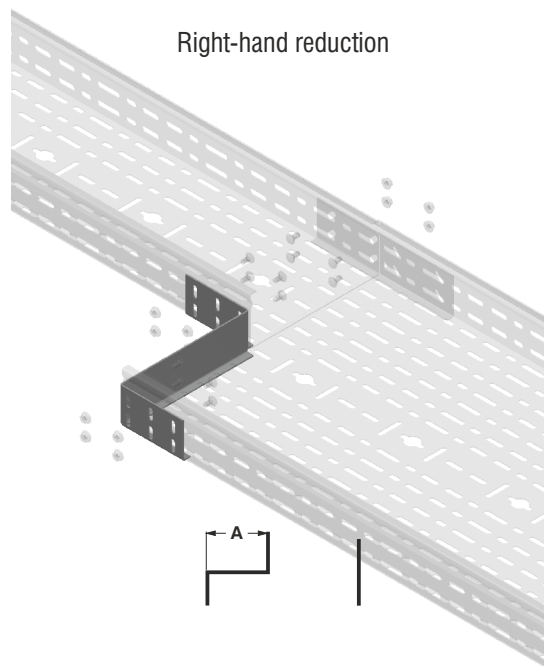

H=060 single row perforated.
H=075 two rows perforated.
H=100 three rows perforated.

Sample Order:
Height (H): 60 mm,
Width (A): 100 mm,
Sheet Thickness (T): 2 mm,
Plating Type (S): Hot Dip Galvanized,
Module Type: Right-hand reduction

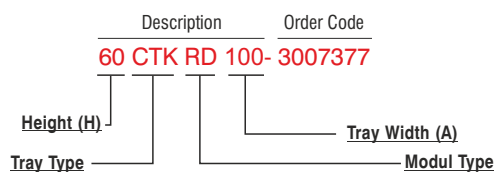

- Please state the order code when ordering.
- For special orders and specifications please contact us.
- Material weights may vary by ± 10%

▶▶ CTK CENTRE REDUCTION

Hot Dip Galvanized After Fabrication (TS EN ISO 1461)

Description	H (mm)	A (mm)	T (mm)	Weight (kg./set.)	Order Code
60 CTK RD 50	60	50	2	0,374	3007394
60 CTK RD100	60	100	2	0,458	3007395
60 CTK RD150	60	150	2	0,541	3007396
60 CTK RD200	60	200	2	0,625	3007397
60 CTK RD250	60	250	2	0,711	3007398
60 CTK RD300	60	300	2	0,794	3007399
<hr/>					
75 CTK RD 50	75	50	2	0,475	3007400
75 CTK RD100	75	100	2	0,585	3007401
75 CTK RD150	75	150	2	0,695	3007402
75 CTK RD200	75	200	2	0,805	3007403
75 CTK RD250	75	250	2	0,915	3007404
75 CTK RD300	75	300	2	1,025	3007405
<hr/>					
100 CTK RD 50	100	50	2	0,658	3007406
100 CTK RD100	100	100	2	0,812	3007407
100 CTK RD150	100	150	2	0,966	3007408
100 CTK RD200	100	200	2	1,118	3007409
100 CTK RD250	100	250	2	1,272	3007410
100 CTK RD300	100	300	2	1,426	3007411

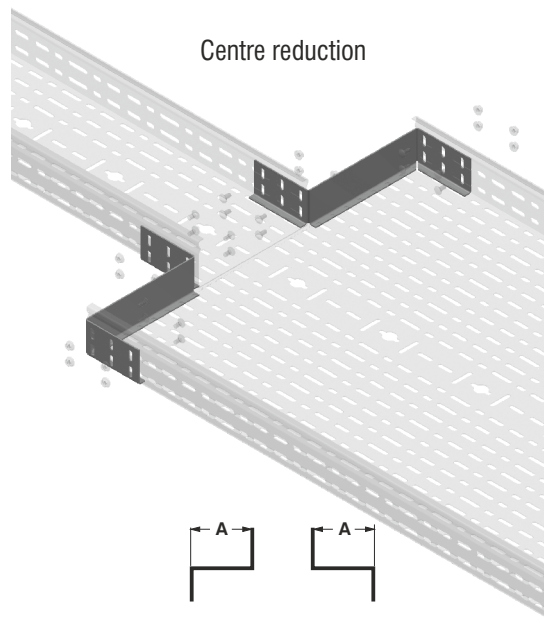

H=060 single row perforated.
H=075 two rows perforated.
H=100 three rows perforated.

Sample Order:
Height (H): 75 mm,
Width (A): 100 mm,
Sheet Thickness (T): 2 mm,
Plating Type (S): Hot Dip Galvanized,
Module Type: Centre reduction.

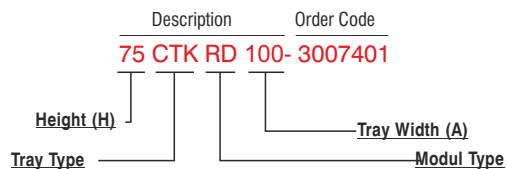

- Please state the order code when ordering.
- For special orders and specifications please contact us.
- Material weights may vary by ± 10%

▶▶ CTK END COVER

Hot Dip Galvanized After Fabrication (TS EN ISO 1461)

Description	H (mm)	A (mm)	T (mm)	Weight (kg./pc.)	Order Code
060 CTK 100	62	106	1,5	0,222	3049183
060 CTK 150	62	156	1,5	0,268	3049184
060 CTK 200	62	206	1,5	0,315	3049185
060 CTK 250	62	256	1,5	0,361	3049186
060 CTK 300	62	306	1,5	0,407	3049187
060 CTK 400	62	406	1,5	0,501	3049188
060 CTK 500	62	506	1,5	0,593	3049189
060 CTK 600	62	606	1,5	0,685	3049190
<hr/>					
075 CTK 100	77	106	1,5	0,276	3049191
075 CTK 150	77	156	1,5	0,332	3049192
075 CTK 200	77	206	1,5	0,388	3049193
075 CTK 250	77	256	1,5	0,444	3049194
075 CTK 300	77	306	1,5	0,501	3049195
075 CTK 400	77	406	1,5	0,613	3049196
075 CTK 500	77	506	1,5	0,725	3049197
075 CTK 600	77	606	1,5	0,837	3049198
<hr/>					
100 CTK 100	102	106	1,5	0,372	3049199
100 CTK 150	102	156	1,5	0,444	3049200
100 CTK 200	102	206	1,5	0,516	3049201
100 CTK 250	102	256	1,5	0,589	3049202
100 CTK 300	102	306	1,5	0,661	3049203
100 CTK 400	102	406	1,5	0,805	3049204
100 CTK 500	102	506	1,5	0,949	3049205
100 CTK 600	102	606	1,5	1,095	3049206

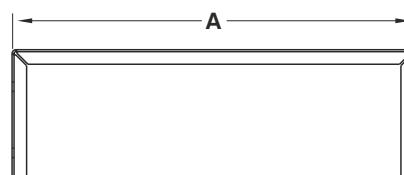
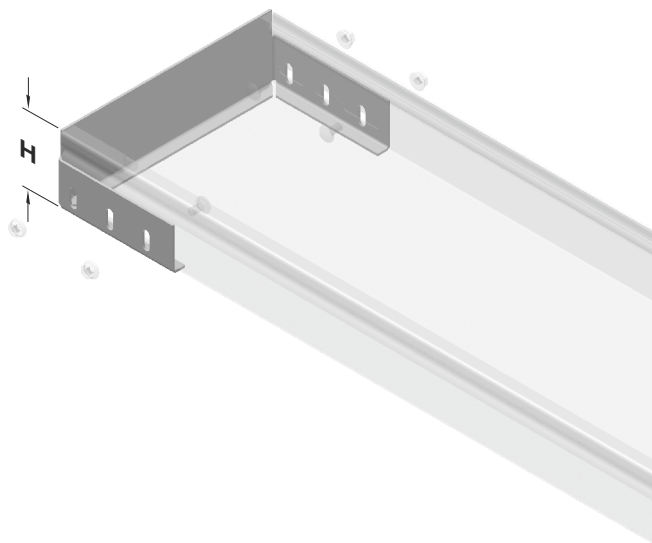

Sample Order:

Description	Order Code
100 CTK 400	3049204

Height (H) |
 Tray Type | | Tray Width (A)

- Please state the order code when ordering.
- For special orders and specifications please contact us.
- Material weights may vary by ± 10%