

ABL



LOW VOLTAGE DEVICES

SEPTEMBER 2017



THE ORIGINAL. SINCE 1925.

LOW VOLTAGE DEVICES

The ABL Plug **4**

SCHUKO **6**

French/Belgian standard **26**

Swiss & International standard **36**

Outlet Boxes, Perilex
Industrial Ethernet **42**

Item Number Directory **47**



THE ABL PLUG

In 1925, Albert Büttner, the founder of our company, invented the SCHUKO plug – the most widespread AC power plug and socket system in the world: Plugs, connectors and sockets for trade, construction and industry.

Apart from SCHUKO, we also offer plugs and sockets according to many other international standards. We develop and manufacture products of the highest 'Made in Germany' quality.

We keep developing our ABL plug further so that it remains ahead of the competition. New materials, new technical features and optimized power connection technologies are the topics that drive us forward.

1 ELAMID

We guarantee superior resilience and impact resistance for our products manufactured from Elamid high performance plastic. Elamid has a high chemical and UV resistance as well as an extremely wide temperature tolerance (-40°C to 80°C). Elamid products, such as those from our Hightech range, are perfect for trade and industrial applications.



2 ELAMID 2K

With the Elamid 2K technology, we succeeded in creating a perfect combination of rubber and Elamid. The result is a range of high quality products for heavy duty applications on construction and industrial sites.

Plugs and connectors from our professionell range are extremely rugged and offer a firm and non-slip grip. With the built-in SCHUKOplus socket, our customers have the choice of another top product made from Elamid 2K.

All Elamid 2K products comply with the IP44 degree of protection, including when they are plugged in.



3 QUICK RELEASE LOCK

To allow users to combine grip and contact carrier easily and quickly, we have created the ABL quick release lock. A mere quarter turn is all that's required to ensure a secure connection between handle and contact carrier.



4 VOLTAGE INDICATOR

Just want to check for voltage? No problem with the voltage indicator available for ABL connectors and triple suspended connectors, making annoying double-checking trips on construction sites a thing of the past.



5 SLIDING CONTACTS

Our solid metal sliding contacts guarantee a long working life and a secure protective earth connection.





PLUGS AND CONNECTORS

SCHUKO Professional	8
SCHUKO Hightech	10
SCHUKO Classic	12
SCHUKO Basic	16

SOCKET OUTLETS

SCHUKO Professional	17
SCHUKO Classic	18
SCHUKO Basic	23
ACCESSORIES	25
ADAPTER	25



ELAMID 2K PLUG

with quick release fastener and twin earthing system · SCHUKO and French/Belgian standard

COLOUR	ITEM NO.	WEIGHT g/EACH	PU
black	1529100	91	5



ELAMID 2K CONNECTOR

with voltage indicator ⊗, quick release fastener and self-closing lid

COLOUR	ITEM NO.	WEIGHT g/EACH	PU
black	1589200	166	5



ELAMID 2K PLUG

with quick release fastener and twin earthing system · SCHUKO and French/Belgian standard

COLOUR	ITEM NO.	WEIGHT g/EACH	PU
red/black	1529140	91	5



ELAMID 2K CONNECTOR

with voltage indicator ⊗, quick release fastener and self-closing lid

COLOUR	ITEM NO.	WEIGHT g/EACH	PU
red/black	1589240	166	5



ELAMID 2K PLUG

with quick release fastener and twin earthing system · SCHUKO and French/Belgian standard

COLOUR	ITEM NO.	WEIGHT g/EACH	PU
grey/black	1529160	91	5



ELAMID 2K CONNECTOR

with voltage indicator ⊗, quick release fastener and self-closing lid

COLOUR	ITEM NO.	WEIGHT g/EACH	PU
grey/black	1589260	166	5

SCHUKO PROFESSIONAL

THREE-WAY CONNECTORS

2-pole + \oplus , 16 A 250 V, DIN/VDE 0620 and IEC 60884 compliant · for wires up to bis 3 x 2,5 mm²
 splash-proof IP54 · \diamond



THREE-WAY SOLID RUBBER CONNECTOR

with voltage indicator \otimes
 and self-closing lid

COLOUR	ITEM NO.	WEIGHT g/EACH	PU
black	1173503	426	5



THREE-WAY SOLID RUBBER CONNECTOR

with voltage indicator \otimes
 and self-closing lid

COLOUR	ITEM NO.	WEIGHT g/EACH	PU
red/black	1173543	426	5



THREE-WAY SOLID RUBBER CONNECTOR

with voltage indicator \otimes
 and self-closing lid

COLOUR	ITEM NO.	WEIGHT g/EACH	PU
grey/black	1173563	426	5

SCHUKO PROFESSIONAL

PRESSURISED WATER-IMPERMEABLE

2-pole + \oplus , 16 A 250 V, DIN/VDE 0620 and IEC 60884 · for wires up to bis 3 x 2,5 mm²
 pressurised water-impermeable IP68 · \diamond



THERMOPLASTIC PLUG

with protective cap

COLOUR	ITEM NO.	WEIGHT g/EACH	PU
blue	1979850	150	5



THERMOPLASTIC CONNECTOR

COLOUR	ITEM NO.	WEIGHT g/EACH	PU
blue	1976850	150	5



THERMOPLASTIC PLUG

with protective cap

COLOUR	ITEM NO.	WEIGHT g/EACH	PU
blue	1989850	130	5

SCHUKO HIGHTECH PLUGS

2-pole + , 16 A 250 V, DIN/VDE 0620 and IEC 60884 · for wires up to bis 3 x 2,5 mm² splash-proof IP44 ·  ELAMID



ELAMID PLUG

with twin earthing system
SCHUKO and
French/Belgian standard

COLOUR	ITEM NO.	WEIGHT g/EACH	PU
blue	1519150	78	10



ELAMID PLUG

with twin earthing system
SCHUKO and
French/Belgian standard

COLOUR	ITEM NO.	WEIGHT g/EACH	PU
red	1519140	78	10



ELAMID PLUG

with twin earthing system
SCHUKO and
French/Belgian standard

COLOUR	ITEM NO.	WEIGHT g/EACH	PU
black	1519100	78	10



ELAMID CONNECTOR

COLOUR	ITEM NO.	WEIGHT g / EACH	PU
blue	1579150	75	10

with shutter

COLOUR	ITEM NO.	WEIGHT g / EACH	PU
blue	1579050	75	10



ELAMID CONNECTOR

with collar / cover splash-proof IP44 · 

COLOUR	ITEM NO.	WEIGHT g / EACH	PU
blue	1579350	98	10

with collar / cover with shutter splashproof IP44 · 

COLOUR	ITEM NO.	WEIGHT g / EACH	PU
blue	1579250	98	10



ELAMID CONNECTOR

COLOUR	ITEM NO.	WEIGHT g / EACH	PU
red	1579140	75	10

with shutter

COLOUR	ITEM NO.	WEIGHT g / EACH	PU
red	1579040	75	10



ELAMID CONNECTOR

with collar / cover splash-proof IP44 · 

COLOUR	ITEM NO.	WEIGHT g / EACH	PU
red	1579340	98	10

with collar / cover with shutter splashproof IP44 · 

COLOUR	ITEM NO.	WEIGHT g / EACH	PU
red	1579240	98	10



ELAMID CONNECTOR

COLOUR	ITEM NO.	WEIGHT g / EACH	PU
black	1579100	75	10

with shutter

COLOUR	ITEM NO.	WEIGHT g / EACH	PU
black	1579000	75	10



ELAMID CONNECTOR

with collar / cover splash-proof IP44 · 

COLOUR	ITEM NO.	WEIGHT g / EACH	PU
black	1579300	98	10

with collar / cover with shutter splashproof IP44 · 

COLOUR	ITEM NO.	WEIGHT g / EACH	PU
black	1579200	98	10

SCHUKO CLASSIC

PLUGS AND CONNECTORS

2-pole + ⊕, 16 A 250 V, DIN/VDE 0620 and IEC 60884 · for wires up to bis 3 x 2,5 mm²



SOLID RUBBER PLUG

with metal quick release
with twin earthing system
SCHUKO and
French/Belgian standard
splash-proof IP44 · ⚡

COLOUR	ITEM NO.	WEIGHT g/EACH	PU
black	1129190	106	20



SOLID RUBBER CONNECTOR

with quick release fastener

COLOUR	ITEM NO.	WEIGHT g/EACH	PU
black	1189090	137	10



SOLID RUBBER CONNECTOR

with quick release fastener
with collar/cover
splash-proof IP44 · ⚡

COLOUR	ITEM NO.	WEIGHT g/EACH	PU
black	1189290	175	10

SCHUKO CLASSIC

THREE-WAY CONNECTOR

2-pole + ⊕, 16 A 250 V, according to DIN/VDE 0620, for wires up to bis 3 x 2,5 mm²



THREE-WAY SOLID RUBBER CONNECTOR

COLOUR	ITEM NO.	WEIGHT g/EACH	PU
black	1473190	368	5

SCHUKO CLASSIC

PLUGS AND CONNECTORS

2-pole + \oplus , 16 A 250 V, acc. to DIN/VDE 0620 and IEC 60884 · for wires up to bis 3 x 2,5 mm²



SOLID RUBBER PLUG

with twin earthing system
SCHUKO and
French/Belgian standard
splash-proof IP44

COLOUR	ITEM NO.	WEIGHT g / EACH	PU
black	1149290	99	20



SOLID RUBBER CONNECTOR

COLOUR	ITEM NO.	WEIGHT g / EACH	PU
black	1169090	119	10



SOLID RUBBER CONNECTOR

with collar / cover
splash-proof IP44

COLOUR	ITEM NO.	WEIGHT g / EACH	PU
black	1169290	175	10

SCHUKO CLASSIC

PLUGS AND CONNECTORS

2-pole + \oplus , 16 A 250 V, acc. to DIN/VDE 0620 and IEC 60884 · for wires up to bis 3 x 2,5 mm²



RUBBER PLUG

with twin earthing system
SCHUKO and
French/Belgian standard
splash-proof IP44

COLOUR	ITEM NO.	WEIGHT g / EACH	PU
black	1149190	86	20



RUBBER CONNECTOR

COLOUR	ITEM NO.	WEIGHT g / EACH	PU
black	1199090	104	10



RUBBER CONNECTOR

with collar/cover
splash-proof IP44

COLOUR	ITEM NO.	WEIGHT g / EACH	PU
black	1199290	137	10

SCHUKO CLASSIC

PLUGS AND CONNECTORS

2-pole + ⊕, 16 A 250 V, acc. to DIN/VDE 0620 and IEC 60884 · for wires up to bis 3 x 1,5 mm²



SOLID RUBBER PLUG

splash-proof IP44

COLOUR	ITEM NO.	WEIGHT g/EACH	PU
black	1429190	72	20



SOLID RUBBER CONNECTOR

COLOUR	ITEM NO.	WEIGHT g/EACH	PU
black	1489090	125	10

SCHUKO CLASSIC

PLUGS AND CONNECTORS

2-pole + ⊕, 16 A 250 V, acc. to DIN/VDE 0620 and IEC 60884 · for wires up to bis 3 x 1,5 mm²



RUBBER PLUG

with twin earthing system
SCHUKO and
French/Belgian standard
splash-proof IP44 · ⚡

COLOUR	ITEM NO.	WEIGHT g/EACH	PU
black	1419190	64	20
orange	1419170	64	20
red	1419140	64	20



RUBBER CONNECTOR

COLOUR	ITEM NO.	WEIGHT g/EACH	PU
black	1479090	117	10
orange	1479070	117	10
red	1479040	117	10



PVC PLUG MINI

with twin earthing system
SCHUKO and
French/Belgian standard

COLOUR	ITEM NO.	WEIGHT g / EACH	PU
grey	1418060	40	20
white	1418080	40	20
yellow	1418050	40	20
black	1418000	40	20



PVC CONNECTOR MINI

COLOUR	ITEM NO.	WEIGHT g / EACH	PU
grey	1679060	83	10
white	1679080	83	10
yellow	1679050	83	10
black	1679000	83	10



PVC PLUG MAXI

with twin earthing system
SCHUKO and
French/Belgian standard
splash-proof IP44

COLOUR	ITEM NO.	WEIGHT g / EACH	PU
grey	1428160	56	20
white	1428180	56	20
yellow	1428150	56	20



PVC CONNECTOR MAXI

COLOUR	ITEM NO.	WEIGHT g / EACH	PU
grey	1478060	92	10
white	1478080	92	10
yellow	1478050	92	10



THERMOPLASTIC PLUG

COLOUR	ITEM NO.	WEIGHT g/EACH	PU
black	1116100	27	50
white	1116110	27	50

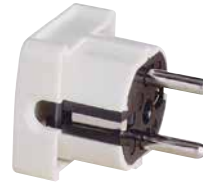

THERMOPLASTIC ANGLE PLUG

with twin earthing system
SCHUKO and
French/Belgian standard

COLOUR	ITEM NO.	WEIGHT g/EACH	PU
black	1400390	35	20
white	1400380	35	20



THERMOPLASTIC ANGLE PLUG

COLOUR	ITEM NO.	WEIGHT g/EACH	PU
black	1107100	34	50
white	1107110	34	50



THERMOPLASTIC CONNECTOR

COLOUR	ITEM NO.	WEIGHT g/EACH	PU
black	1176100	31	20
white	1176110	31	20





THERMOPLASTIC ADAPTER

fibre glass reinforced contact support. plug side with twin earthing system · SCHUKO and French/Belgian standard

COLOUR	ITEM NO.	WEIGHT g/EACH	PU
black	1115000	76	10
white	1115010	76	10

SCHUKO PROFESSIONAL

SCHUKOplus PLUGS

2-pole + \ominus , 16 A 250 V, DIN/VDE 0620
 splash-proof IP54 ·  · 
 with Screw terminals



ELAMID 2 K SOCKET PLUG

flush mounting

COLOUR	ITEM NO.	WEIGHT g/EACH	PU
blue	1561050	53	100
black	1561000	53	100
red	1561040	53	100
yellow	1561030	53	100
grey	1561060	53	100



ELAMID 2 K SOCKET PLUG

flush mounting
 with shutter

COLOUR	ITEM NO.	WEIGHT g/EACH	PU
blue	1562050	55	100

SCHUKO PROFESSIONAL

2-pole + \ominus , 16 A 250 V, acc. to DIN/VDE 0620 and
 IEC 60884 · Pressurised water-impermeable IP68 · 



THERMOPLASTIC WALL-MOUNTED SOCKET OUTLET

with 2 x M20 screw connection

COLOUR	ITEM NO.	WEIGHT g/EACH	PU
blue 	1977751	180	5



THERMOPLASTIC PANEL-MOUNTED SOCKET

COLOUR	ITEM NO.	WEIGHT g/EACH	PU
blue	1987951	90	5



THERMOPLASTIC SOCKET OUTLET

flush mounting IP54 \diamond

COLOUR	ITEM NO.	WEIGHT g/EACH	PU
black	1461000	38	100
red	1461040	38	100
blue	1461050	38	100
grey	1461060	38	100



THERMOPLASTIC SOCKET OUTLET

flush mounting IP54 \diamond

COLOUR	ITEM NO.	WEIGHT g/EACH	PU
black	1461100	38	100
red	1461140	38	100
blue	1461150	38	100
grey	1461160	38	100



THERMOPLASTIC SOCKET OUTLET

flush mounting

COLOUR	ITEM NO.	WEIGHT g/EACH	PU
black	1461300	29	100
blue	1461350	29	100
grey	1461360	29	100



THERMOPLASTIC SOCKET OUTLET

flush mounting IP54 \diamond
with shutter

COLOUR	ITEM NO.	WEIGHT g/EACH	PU
blue	1662050	53	100

SCHUKO CLASSIC

BOWAmini SOCKET OUTLETS

94 x 94 mm



COVER

with hinged lid
stained steel, matt
drip-proof IP41

ITEM NO.	WEIGHT g/EACH	PU
1471ESM	315	1



COVER

with hinged lid
platinum, matt
drip-proof IP41

ITEM NO.	WEIGHT g/EACH	PU
1471PLM	315	1



COVER

with hinged lid
brass, matt
drip-proof IP41

ITEM NO.	WEIGHT g/EACH	PU
1471MSM	315	1



THERMOPLASTIC SOCKET OUTLET

with SCHUKO socket outlet

ITEM NO.	WEIGHT g/EACH	PU
1471601	125	1

All standard socket outlets with an 80 mm cover and support ring fastening available for installation engineering, communication and telecommunications can be mounted into the 1632500 enclosure.

Simple and safe connection with coupling brackets.

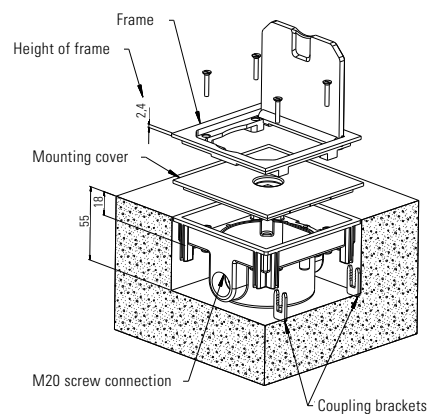



COVER

with hinged lid
stainless steel, matt
drip-proof IP41

ITEM NO.	WEIGHT g/EACH	PU
1632ESM	498	1



COVER

with hinged lid
platinum, matt
drip-proof IP41

ITEM NO.	WEIGHT g/EACH	PU
1632PLM	498	1



COVER

with hinged lid
brass, matt
drip-proof IP41

ITEM NO.	WEIGHT g/EACH	PU
1632MSM	498	1



THERMOPLASTIC DOUBLE SOCKET OUTLET

with double SCHUKO outlet

ITEM NO.	WEIGHT g/EACH	PU
1632602	281	1



THERMOPLASTIC HOUSING BASE

ITEM NO.	WEIGHT g/EACH	PU
1632500	187	1

All standard socket outlets with an 80 mm cover and support ring fastening available for installation engineering, communication and telecommunications can be mounted into the 1632500 enclosure.

Simple and safe connection with coupling brackets.

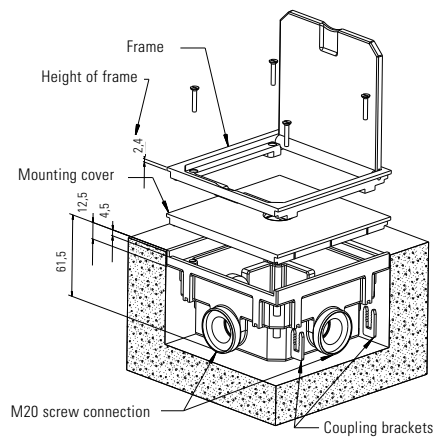





SOCKET OUTLET

cover with hinged lid made of aluminium die-cast
base made of thermoplastic
drip-proof IP41
with shutter (1471461)

COLOUR	ITEM NO.	WEIGHT g/EACH	PU
grey	1471460	301	1
grey	1471461	301	1



DOUBLE SOCKET OUTLET

cover with hinged lid made of aluminium die-cast
base made of aluminium die-cast
drip-proof IP41

COLOUR	ITEM NO.	WEIGHT g/EACH	PU
grey	1632490	575	1



HOUSING

cover with hinged lid
made of aluminium die-cast
base made of thermoplastic
drip-proof IP41

COLOUR	ITEM NO.	WEIGHT g/EACH	PU
grey	1632497	375	1



SOCKET OUTLET

cover with cinged lid
made of aluminium die-cast
base made of thermoplastic
watertight IP66

COLOUR	ITEM NO.	WEIGHT g/EACH	PU
grey	1471360	740	1



THERMOPLASTIC SOCKET OUTLET

flush mounting · suitable for
installation in BOWAmini

COLOUR	ITEM NO.	WEIGHT g/EACH	PU
white	1111810	32	100



THERMOPLASTIC SOCKET OUTLET

flush mounting · with shutter
suitable for installation in BOWAmini

COLOUR	ITEM NO.	WEIGHT g/EACH	PU
white	1111710	33	100



SURFACE-MOUNTED SOCKET OUTLET

COLOUR	ITEM NO.	WEIGHT g/EACH	PU
white	1491010	79	10



BASE PLATE

for item No. 1491010

COLOUR	ITEM NO.	WEIGHT g/EACH	PU
white	1491008	8	10



SURFACE-MOUNTED SOCKET OUTLET

Double

COLOUR	ITEM NO.	WEIGHT g/EACH	PU
white	1492010	128	10



BASE PLATE

for item No. 1492010

COLOUR	ITEM NO.	WEIGHT g/EACH	PU
white	1492008	13	10



SURFACE-MOUNTED SOCKET OUTLET

Triple

COLOUR	ITEM NO.	WEIGHT g/EACH	PU
white	1493010	197	5



BASE PLATE

for item No. 1493010

COLOUR	ITEM NO.	WEIGHT g/EACH	PU
white	1493008	18	10



SURFACE-MOUNTED SOCKET OUTLET

Quadruple

COLOUR	ITEM NO.	WEIGHT g/EACH	PU
white	1694010	214	5



BASE PLATE

for item No.1694010

COLOUR	ITEM NO.	WEIGHT g/EACH	PU
white	0004060	32	10

ACCESSORIES

SOCKET OUTLETS



SURFACE-MOUNTED HOUSING

for socket outlet
1461, 1561, 1562, 1662

COLOUR	ITEM NO.	WEIGHT g/EACH	PU
black	1461007	49	10



MOUNTING PLATE

for surface-mounted housing
for snapping onto DIN rail
acc. to DIN EN 60715 35 mm

ITEM NO.	WEIGHT g/EACH	PU
1461SB	14	100



RUBBER SEAL

for socket outlet 1461, 1462,
CZ, SEV, UL and BS

COLOUR	ITEM NO.	WEIGHT g/EACH	PU
black	8632316	3	100

ADAPTER



CEE PLUG ON SCHUKO SOCKET

3-pole, 16A, 230V, 6 h blue
splash-proof IP44

ITEM NO.	WEIGHT g/EACH	PU
ADP050	165	5



CEE PLUG ON SOCKET F/B-STANDARD

3-pole, 16A, 230V, 6 h blue
splash-proof IP44

ITEM NO.	WEIGHT g/EACH	PU
ADP052	165	5



FRENCH/BELGIAN STANDARD

PLUGS AND CONNECTORS

HIGHTECH	28
CLASSIC	30

SOCKET OUTLETS

HIGHTECH	32
CLASSIC	33
BASIC	34

HIGHTECH PLUGS

2-pole + ⊕, 16 A 250 V, acc. to DIN/VDE 0620 and IEC 60884
for wires up to bis 3 x 2,5 mm² · splash-proof IP44 ·  ELAMID



ELAMID PLUG

with twin earthing system
SCHUKO and
French/Belgian standard

COLOUR	ITEM NO.	WEIGHT g/EACH	PU
blue	1519150	78	10



ELAMID PLUG

with twin earthing system
SCHUKO and
French/Belgian standard

COLOUR	ITEM NO.	WEIGHT g/EACH	PU
red	1519140	78	10



ELAMID PLUG

with twin earthing system
SCHUKO and
French/Belgian standard

COLOUR	ITEM NO.	WEIGHT g/EACH	PU
black	1519100	78	10



HIGHTECH CONNECTORS

2-pole + , 16 A 250 V, acc. to NF C61-314 French standard and NBN C61-112 Belgian standard · for wires up to bis 3 x 2,5 mm²

 ELAMID



ELAMID CONNECTOR

with shutter

COLOUR	ITEM NO.	WEIGHT g/EACH	PU
blue	1579052	75	10



ELAMID CONNECTOR

with shutter
with collar and cover
splash-proof IP44 · 

COLOUR	ITEM NO.	WEIGHT g/EACH	PU
blue	1579252	98	10



ELAMID CONNECTOR

with shutter

COLOUR	ITEM NO.	WEIGHT g/EACH	PU
red	1579042	75	10



ELAMID CONNECTOR

with shutter
with collar and cover
splash-proof IP44 · 

COLOUR	ITEM NO.	WEIGHT g/EACH	PU
red	1579242	98	10



ELAMID CONNECTOR

with shutter

COLOUR	ITEM NO.	WEIGHT g/EACH	PU
black	1579002	75	10



ELAMID CONNECTOR

with shutter
with collar and cover
splash-proof IP44 · 

COLOUR	ITEM NO.	WEIGHT g/EACH	PU
black	1579202	98	10

CLASSIC

PLUGS AND CONNECTORS

2-pole + ⊕, 16 A 250 V, acc. to NF C61-314 French standard and NBN C61-112 Belgian standard · for wires up to bis 3 x 2,5 mm² splash-proof IP44



RUBBER PLUG

with twin earthing system SCHUKO and French/Belgian standards

COLOUR	ITEM NO.	WEIGHT g/EACH	PU
black	1149190	86	20



RUBBER CONNECTOR

with shutter

COLOUR	ITEM NO.	WEIGHT g/EACH	PU
black	1199592	170	10

CLASSIC

THREE-WAY CONNECTORS

2-pole + ⊕, 16 A 250 V, acc. to NF C61-314 French standard and NBN C61-112 Belgian standard · for wires up to bis 3 x 2,5 mm²



THREE-WAY SOLID RUBBER CONNECTOR SELF-CLOSING LID

with shutter splash-proof IP44

COLOUR	ITEM NO.	WEIGHT g/EACH	PU
black	1473597	486	5



THREE-WAY SOLID RUBBER CONNECTOR

splash-proof IP44

COLOUR	ITEM NO.	WEIGHT g/EACH	PU
black	1473292	486	5



THREE-WAY SOLID RUBBER CONNECTOR

with shutter with voltage indicator ⊗

COLOUR	ITEM NO.	WEIGHT g/EACH	PU
black	1473692	383	5

CLASSIC

PLUGS AND CONNECTORS

2-pole + Ⓢ, 16 A 250 V, acc. to NF C61-314 French standard and NBN C61-112 Belgian standard · for wires up to 3 x 1,5 mm²



RUBBER PLUG

with twin earthing system
SCHUKO and
French/Belgian standards
splash-proof IP44

COLOUR	ITEM NO.	WEIGHT g/EACH	PU
black	1419190	64	20



RUBBER CONNECTOR

COLOUR	ITEM NO.	WEIGHT g/EACH	PU
black	1479091	117	10



RUBBER CONNECTOR

with shutter

COLOUR	ITEM NO.	WEIGHT g/EACH	PU
black	1479092	117	10



RUBBER CONNECTOR

splash-proof IP44

COLOUR	ITEM NO.	WEIGHT g/EACH	PU
black	1479291	166	10



RUBBER CONNECTOR

with shutter
splash-proof IP44

COLOUR	ITEM NO.	WEIGHT g/EACH	PU
black	1479292	166	10

CLASSIC

PLUGS AND CONNECTORS

2-pole + Ⓢ, 16 A 250 V, acc. to NF C61-314 French standard and NBN C61-112 Belgian standard · for wires up to bis 3 x 1,5 mm²



PVC PLUG

with twin earthing system
SCHUKO and
French/Belgian standard

COLOUR	ITEM NO.	WEIGHT g/EACH	PU
grey	1418060	40	20
white	1418080	40	20
black	1418000	40	20



PVC CONNECTOR

with shutter

COLOUR	ITEM NO.	WEIGHT g/EACH	PU
grey	1679062	83	10
white	1679082	83	10
black	1679002	83	10

HIGHTECH

SOCKET OUTLETS

2-pole + Ⓧ , 16 A 250 V, acc. to NF C61-314 French standard and NBN C61-112 Belgian standard, IP54



THERMOPLASTIC SOCKET OUTLET

flush mounting IP54 \blacklozenge
with shutter

COLOUR	ITEM NO.	WEIGHT g/EACH	PU
black	1662002	53	100
blue	1662052	53	100
grey	1662062	53	100



CLASSIC

BOWAmini SOCKET OUTLETS

94 x 94 mm



COVER

with hinged lid
stainless steel matt
drip-proof IP41

ITEM NO.	WEIGHT g / EACH	PU
1471ESM	315	1



COVER

with hinged lid
platinum, matt
drip-proof IP41

ITEM NO.	WEIGHT g / EACH	PU
1471PLM	315	1



COVER

with hinged lid
brass, matt
drip-proof IP41

ITEM NO.	WEIGHT g / EACH	PU
1471MSM	315	1



SOCKET OUTLET

thermoplastic
with French/Belgian standard
and shutter

ITEM NO.	WEIGHT g / EACH	PU
1471602	125	1

CLASSIC

BOWAcompact SOCKET OUTLETS

2-pole + ⊕, 16 A 250 V, acc. to NF C61-314 French standard and
NBN C61-112 Belgian standard · for wires up to bis 3 x 1,5 mm²



SOCKET OUTLET MINI

drip-proof IP41
cover with hinged lid
made of aluminium die-cast
base made of thermoplastic
with shutter

COLOUR	ITEM NO.	WEIGHT g / EACH	PU
grey	1471462	301	1

BASIC SOCKET OUTLETS

2-pole + , 16 A 250 V, NF C61-314 French standard and
NBN C61-112 Belgian standard



THERMOPLASTIC SOCKET OUTLET

flush mounting
suitable for installation in
BOWA.94 · with shutter

COLOUR	ITEM NO.	WEIGHT g/EACH	PU
white	1111712	33	100

BASIC SOCKET OUTLETS

2-pole + , 16 A 250 V



SURFACE-MOUNTED SOCKET OUTLET

quadruple, without earthing system

COLOUR	ITEM NO.	WEIGHT g/EACH	PU
white	1804010	159	5

Accessories on page 25





SWISS & INTERNATIONAL STANDARD

PLUGS AND CONNECTORS 38

SOCKET OUTLETS 40

PLUGS & CONNECTORS

acc. to SEV Typ 23, 25
splash-proof IP44



RUBBER PLUG 16 A 250 V

acc. to SEV 5934 Typ 23

COLOUR	ITEM NO.	WEIGHT g/EACH	PU
dark blue	SEV23S	80	20



RUBBER CONNECTOR 16 A 250 V

acc. to SEV 5934 Typ 23
with collar and cover

COLOUR	ITEM NO.	WEIGHT g/EACH	PU
dark blue	SEV23K2	132	10



RUBBER PLUG 16 A 400 V

acc. to SEV 5932 Typ 25

COLOUR	ITEM NO.	WEIGHT g/EACH	PU
red	SEV25S	98	20



RUBBER CONNECTOR 16 A 400 V

acc. to SEV 5932 Typ 25
with collar and cover

COLOUR	ITEM NO.	WEIGHT g/EACH	PU
red	SEV25K2	138	10

PLUGS & CONNECTORS

acc. to SEV Typ 12, 13, 15
splash-proof IP44



RUBBER PLUG 10 A 250 V

acc. to SEV 6534 Typ 12

COLOUR	ITEM NO.	WEIGHT g/EACH	PU
light blue	SEV12S2	79	20



RUBBER CONNECTOR 10 A 250 V

acc. to SEV 6535 Typ 13
with collar and cover

COLOUR	ITEM NO.	WEIGHT g/EACH	PU
light blue	SEV13K2	132	10



RUBBER PLUG 10 A 400 V

acc. to SEV 6532 Typ 15

COLOUR	ITEM NO.	WEIGHT g/EACH	PU
orange	SEV15S	95	20



RUBBER CONNECTOR 10 A 400 V

SEV 6532 Typ 15
with collar and cover

COLOUR	ITEM NO.	WEIGHT g/EACH	PU
orange	SEV15K2	135	10

THREE-WAY CONNECTOR

acc. to SEV Typ 13



THREE-WAY SOLID RUBBER CONNECTOR 10 A 250 V

acc. to SEV 6535 Type 13 with voltage
indicator and self-closing lid
splash-proof IP54

COLOUR	ITEM NO.	WEIGHT g/EACH	PU
blue	SEV313K	486	5

SOCKET OUTLETS

16 A

acc. to SEV Typ 23, 25, IP54 · 



THERMOPLASTIC SOCKET OUTLET 16 A 250 V

flush mounting
acc. to SEV 5934 type 23
with seal in hinged lid

COLOUR	ITEM NO.	WEIGHT g/EACH	PU
--------	----------	---------------	----

grey/blue	1461965	40	100
-----------	---------	----	-----



THERMOPLASTIC SOCKET OUTLET 16 A 400 V

flush mounting
acc. to SEV 5932 type 25
with seal in hinged lid

COLOUR	ITEM NO.	WEIGHT g/EACH	PU
--------	----------	---------------	----

grey/red	SEV1148	65	20
----------	---------	----	----

SOCKET OUTLETS

10 A

acc. to SEV Typ 13, 15, IP54 · 

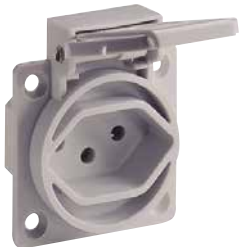

THERMOPLASTIC SOCKET OUTLET 10 A 250 V

flush mounting
acc. to SEV 6535 type 13

COLOUR	ITEM NO.	WEIGHT g/EACH	PU
--------	----------	---------------	----

blue	1461005	37	20
black	1461006	37	20
grey	1461066	37	20



THERMOPLASTIC SOCKET OUTLET 10 A 400 V

flush mounting
acc. to SEV 6532 type 15

COLOUR	ITEM NO.	WEIGHT g/EACH	PU
--------	----------	---------------	----

grey	SEV-100	57	20
------	---------	----	----

SOCKET OUTLETS

INTERNATIONAL STANDARD

USA, CANADA

2-pole + \oplus , 15 A 125 V
acc. to UL498/NEMA 5-15 R,
CSA 22.2 Nr. 42



THERMOPLASTIC SOCKET OUTLET

flush mounting
IP54 · \diamond

COLOUR	ITEM NO.	WEIGHT g/EACH	PU
black	UL12500	45	100
blue	UL12505	45	100
grey	UL12506	45	100

SOCKET OUTLETS

INTERNATIONAL STANDARD

USA, CANADA

2-pole + \oplus , 15 A 125 V
acc. to UL498/NEMA 5-15 R,
CSA 22.2 Nr. 42



THERMOPLASTIC SOCKET OUTLET

flush mounting
IP54

COLOUR	ITEM NO.	WEIGHT g/EACH	PU
black	BS13630	38	100

Accessories on page 25



OUTLET BOXES 44

PERILEX 45

INDUSTRIAL ETHERNET 46

OUTLET BOXES

with screw terminals
compliant with VDE 0606



THERMOPLASTIC OUTLET BOX

for surface mounting
cover with snap lock
terminals: 5 x 2,5 to* 6 mm²

COLOUR	ITEM NO.	WEIGHT g/EACH	PU
white	2505010	80	10



THERMOPLASTIC OUTLET BOX

for flush mounting and surface mounting · cover with snap lock · terminals: 5 x 2,5 to* 6 mm²

COLOUR	ITEM NO.	WEIGHT g/EACH	PU
white	2505110	80	10



THERMOPLASTIC OUTLET BOX

for flush mounting and surface mounting, claw bracket can be snapped out
cover with snap lock
terminals: 5 x 2,5 to* 6 mm²

COLOUR	ITEM NO.	WEIGHT g/EACH	PU
white	2505210	90	10



BASE PLATE IP44

with two cable entries
for outlet boxes 25055

COLOUR	ITEM NO.	WEIGHT g/EACH	PU
white	2505018	32	10



THERMOPLASTIC OUTLET BOX

for flush mounting
flat version · cover with snap lock
terminals: 5 x 2,5 mm²
extra flat – only 11 mm

COLOUR	ITEM NO.	WEIGHT g/EACH	PU
white	2506110	61	10



THREE-CHAMBER OUTLET BOX

for flush mounting and surface mounting
dowel fastening
terminals: 5 x 2,5 to* 6 mm² / 7 x 2,5 mm²

COLOUR	ITEM NO.	WEIGHT g/EACH	PU
white	2518610	166	5

* if conductor section is > 5 x 2,5 mm²
use additional strain relief.

PERILEX
PLUG, CONNECTORS
AND SOCKET OUTLETS

3-pole + N + , 16 A AC 400/230 V
acc. to DIN 49445/46



DUROPLAST PLUG

COLOUR	ITEM NO.	WEIGHT g/EACH	PU
white	2201110	99	10



DUROPLAST CONNECTOR

COLOUR	ITEM NO.	WEIGHT g/EACH	PU
white	2206110	149	10



**DUROPLAST
ANGLE PLUG**

COLOUR	ITEM NO.	WEIGHT g/EACH	PU
white	2407110	113	10



**DUROPLAST
FLUSH-MOUNTED
SOCKET OUTLET**

COLOUR	ITEM NO.	WEIGHT g/EACH	PU
white	2421110	142	10



**DUROPLAST
FLUSH-MOUNTED
SOCKET OUTLET**

splash-proof IP44
with in-wall box

COLOUR	ITEM NO.	WEIGHT g/EACH	PU
white	2451510	234	10



**DUROPLAST
SURFACE-MOUNTED
SOCKET OUTLET**

COLOUR	ITEM NO.	WEIGHT g/EACH	PU
white	2491010	136	10



**DUROPLAST
SURFACE-MOUNTED
SOCKET OUTLET**

splash-proof IP44

COLOUR	ITEM NO.	WEIGHT g/EACH	PU
grey	2441860	271	5

INDUSTRIAL ETHERNET



PANEL-MOUNTED SOCKET IP67

access side: IDC insulation-piercing plug technology · outgoing side: 2 x RJ45 Cat.6 modules 8(8)

ITEM NO.	WEIGHT g / EACH	PU
DG-RJ45	160	10



SOCKET PLUG IP55

access side: IDC insulation-piercing plug technology · outgoing side: 1 x RJ45 Cat.6 module 8(8) RJ45K13
2 x RJ45 Cat.6 modules 8(8) RJ45K23

ITEM NO.	WEIGHT g / EACH	PU
RJ45K13	70	10
RJ45K23	100	10

ITEM NUMBER DIRECTORY

ITEM NO.	PAGE
0004060	24
1107100	16
1107110	16
1111712	34
1111810	23
1115000	16
1115010	16
1116100	16
1116110	16
1129190	12
1149190	13
1149190	30
1149290	13
1169090	13
1169290	13
1173503	9
1173543	9
1173563	9
1176100	16
1176110	16
1189090	12
1189290	12
1199090	13
1199290	13
1199592	30
1400380	16
1400390	16
1418000	15
1418000	31
1418050	15
1418060	15
1418060	31
1418080	15
1418080	31
1419140	14
1419170	14
1419190	14
1419190	31
1428150	15
1428160	15
1428180	15
1429190	14
1461000	18
1461005	40
1461006	40
1461007	25
1461040	18
1461050	18
1461060	18
1461066	40
1461100	18
1461140	18
1461150	18
1461160	18
1461300	18
1461350	18
1461360	18
1461965	40
1461SB	25

ITEM NO.	PAGE
1471360	22
1471460	22
1471461	22
1471462	33
1471601	19
1471602	33
1471ESM	19
1471ESM	33
1471MSM	19
1471MSM	33
1471PLM	19
1471PLM	33
1473190	12
1473292	30
1473597	30
1473692	30
1478050	15
1478060	15
1478080	15
1479040	14
1479070	14
1479090	14
1479091	31
1479092	31
1479291	31
1479292	31
1489090	14
1491008	24
1491010	24
1492008	24
1492010	24
1493008	24
1493010	24
1519100	10
1519100	28
1519140	10
1519140	28
1519150	10
1519150	28
1529100	8
1529140	8
1529160	8
1561000	17
1561030	17
1561040	17
1561050	17
1561060	17
1562050	17
1579000	11
1579002	29
1579040	11
1579042	29
1579050	11
1579052	29
1579100	11
1579140	11
1579150	11
1579200	11
1579202	29

ITEM NO.	PAGE
1579240	11
1579242	29
1579250	11
1579252	29
1579300	11
1579340	11
1579350	11
1589200	8
1589240	8
1589260	8
1632490	22
1632497	22
1632500	20
1632602	20
1632ESM	20
1632MSM	20
1632PLM	20
1662002	32
1662050	18
1662052	32
1662062	32
1679000	15
1679002	31
1679050	15
1679060	15
1679062	31
1679080	15
1679082	31
1694010	24
1804010	34
1976850	9
1977751	17
1979850	9
1987951	17
1989850	9
2201110	45
2206110	45
2407110	45
2421110	45
2441860	45
2451510	45
2491010	45
2505010	44
2505018	44
2505110	44
2505210	44
2506110	44
2518610	44
8632316	25
ADP050	25
ADP052	25
BS13630	41
DG-RJ45	46
RJ45K13	46
RJ45K23	46
SEV-100	40
SEV1148	40
SEV12S2	39
SEV13K2	39

ITEM NO.	PAGE
SEV15K2	39
SEV15S	39
SEV23K2	38
SEV23S	38
SEV25K2	38
SEV25S	38
SEV313K	39
UL12500	41
UL12505	41
UL12506	41



ABL SURSUM
Bayerische Elektrozubehör GmbH & Co. KG

Albert-Büttner-Straße 11
D-91207 Lauf / Pegnitz

Tel. +49 (0) 9123 188-0
Fax +49 (0) 9123 188-188

info@abl.de
www.abl.de