

WORKING CATALOGUE 2021

FLOS
ARCHITECTURAL

FLOS

WORKING CATALOGUE 2021















ITALIANO / ENGLISH



Questa marcatura è presente tra le novità Prodotto / This marker appears alongside Product News

INDEX









LIGHT STRUCTURES

- 10 – Belt 
- 14 – Infra-Structure 
- 28 – Infra-Structure Episode 2 
- 38 – Diversion 
- 52 – Zero Track 
- 66 – The Micro Running Magnet 
- 82 – The Running Magnet 
- 106 – The Tracking Magnet 
- 128 – The Tracking Power 
- 142 – The Fast Track 
- 152 – In-Finity 
- 162 – LED Squad / LED Squad Mini 
- 168 – Light Cut Mini 
- 174 – Moonline 

HIGH COMFORT

- 180 – Oblique 
- 182 – Light Shadow 
- 222 – Light Shadow Pro / Light Shadow Dots 
- 234 – Circle of Light 
- 238 – LED Curtain 

DOWNLIGHTS

- 244 – Kap 
- 354 – Bon Jour 
- 358 – Light Shooter 
- 366 – Light Sniper 
- 372 – UT Downlight 
- 380 – Light Supply 
- 392 – Pure Downlight 
- 398 – Compass 

INDEX

DOWNLIGHTS

404 – Anthony Downlight



406 – Wan Downlight



408 – Light Soldier



412 – Decofix



416 – Johnny



428 – Compass Box Recessed



432 – Battery



440 – Micro Battery



SPOTLIGHTS

● 446 – Camera



454 – Find Me



460 – UT Spot&Pro



478 – Solid Pure



488 – Pure Spot



SPOTLIGHTS

500 – Wan Spot



502 – Fort Knox



CEILING / WALL

● 508 – C1



516 – UT Pro Surface



520 – Kap Surface /
Kap Suspension



530 – Compass Box



● 536 – Super Line /
Super Line Pro



542 – Super Flat



548 – Light Bell



552 – Fort Knox Wall /
Fort Knox Wall Mini



554 – Thin LED



556 – Wall System



562 – G-O



564 – TheBlockofLight



INDEX

CEILING / WALL

566 – Giano



568 – Box



SOFT – LINEAR

597 – Wall Rupture



598 – Softprofile



600 – Kapprofile



SOFT – 3D

605 – Juncos



607 – Wall Piercing



611 – Soft Spun



612 – Abajourd'Hui



SOFT – OUT

615 – USO Boob



617 – USL Out



SOFT – IN

621 – APPS



623 – G-O IN



623 – Teardrop



624 – USO



628 – USO Cove Lighting



631 – Round Light



632 – Square Light



633 – Vertical Light



633 – USB Round



634 – USB Square



572 – TRACKS

578 – DRIVERS

584 – LIGHT SOURCES

586 – TECHNICAL INFORMATION











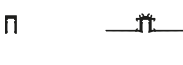

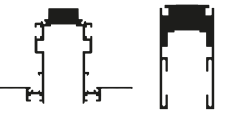













640 – QUICK SEARCH OF PRODUCT

664 – DISTRIBUTION

LIGHT STRUCTURES

Belt, Infra-Structure, Infra-Structure Episode 2,
Diversion, Zero Track, The Micro Running
Magnet, The Running Magnet, The Tracking
Magnet, The Tracking Power, The Fast
Track, In-Finity, LED Squad,
Light Cut Mini, Moonline.

LIGHT STRUCTURES OVERVIEW

		MICRO RUNNING MAGNET		RUNNING MAGNET			FAST TRACK			
										
PHYSICAL CHARACTERISTICS	MOUNTING	SURFACE	RECESSED	RECESSED	SURFACE	SUSPENSION Down / Up & Down	RECESSED	SURFACE		
	COLORS									
	VOLTAGE / TRACK ADAPTER	24 Vdc In-Track			24 Vdc In-Track			48 Vdc In-Track		
	INNER GAP (mm)	5			35			35		
	OUTER GAP (mm)	-	9	-	41		-	49		
	RECESSED DEPTH (mm)	-	17	73,5	-	-	73,5	-		
	HEIGHT (mm)	14	-	86 / 73	100	100	86 / 73	92		
	LENGTH (mm)	1000 / 2000 / 3000			1000 / 1500 / 2000 / 2500 / 3000			1000 / 1500 / 2000 / 3000		
PROFILE EMISSION	✗ (Direct emission & Wall-Washer by means of dedicated light modules)			✓ (Upper emission integrated / direct emission by means of dedicated light modules)			✗			
CONTROL CHARACTERISTICS	NON DIMMABLE	✓			✓			✗		
	DALI	✓			✓			✗		
	CASAMBI	✓ (Individual control integrated)			✓ (Individual control integrated)			✓ (Individual control integrated)		
	1 - 10V	✓			✗			✗		
	PUSH	✗			✗			✗		
	MAIN DIMMING	✗			✗			✗		
	UP&DOWN (Indep)	—			✓			—		
COMPATIBLE LIGHT MODULES	ACCENT LIGHTING	Nano Spot 	Light Shadow Spot 	Spot Module 	Spot 120 	Anthony Spot Track 	Spot 100 	Spot 120 		
	Micro Spot 	Spot 	Multi Spot 4 	Light Shadow / Wall-Washer 	Find Me Suspension 	Spot 175 				
DIFFUSED LIGHTING	Light Stripe Diffused 	Light Stripe Wall-Washer 	Light Stripe 	String Light Ball 	Mini Glo-Ball 	String Light Cone 	Mini Glo-Ball Suspension 	—		

LIGHT STRUCTURES OVERVIEW

	TRACKING MAGNET			INFRA-STRUCTURE	INFRA-STRUCTURE EPISODE 2	DIVERSION		ZERO TRACK	TRACKING POWER		
	RECESSED	SUSP/SURF Down	SUSPENSION Up & Down	SUSPENSION	SURFACE	SURFACE	SUSPENSION	SURFACE	RECESSED	SURFACE	
	48 Vdc In-Track			48 Vdc In-Track	48 Vdc	24 Vdc In-Track		24 Vdc In-Track	240 / 220 Vac In-Track		
	15			15	-	12		8	15		
	-	25		30	-	16		17	15		
	31,5	-	-	-	-	-		-	24,5	-	
	45 / 31	46	52	100 / 300 400 / 700	100 / 200 / 400 600 / 800 / 1000	7		7	37 / 24	32	
	1000 / 1500 / 2000 / 2500 / 3000			1100 / 1600	900 / 1200 / 1500	1000 / 1500 / 2000 / 2500		1000 / 2000 / 3000	1000 / 2000 / 3000 / 4000	1000 / 2000 / 3000	
	✓ (Upper emission integrated / direct emission by means of dedicated light modules)			✗ (Requires dedicated light modules)	✗ (Requires dedicated light modules)	✓ (Down / Up - Down emission)		-	✗		
	✓			✓	✓	✓		✓	✗		
	✓			✓	✓	✓		✓	✓ (Only Wall-Washer)		
	✓ (Individual control integrated)			✓ (Individual control integrated)	✓ (Broadcast control)	✓ (Individual control integrated)		✓ (Individual control integrated)	✗		
	✓			✓	✓	✓		✓	✗		
	✗			✗	✓	✗		✗	✗		
	✗			✗	✗	✗		✗	✗		
	✓			✓	✓	Up 50%		-	-		
	Spot 50	Spot 90	Spot 120	Spot 150			Atom 90	Atom 120	Find Me 0	UT Pro 150	UT Pro 175
	Anthony Spot Track						Find Me 1	Find Me 2	Find Me Suspension	UT Pro 175 Lens	
										Camera 60	Camera 90
	Light Stripe	Wallee	Suspension Glass Downlight 110		Light Tube Covered		Atom 200		UT Pro Wall-Washer		
			Suspension Panel 600		Suspension Cone 300 / 400						
			Light Tube Direct / Indirect / Blind		Light Tube Direct / Indirect						



LIGHT SOURCE
TOP LED
27,5W/m
915 lm/m Up
2000 lm/m Down
2700K/CRI 95

LIGHT SOURCE
TOP LED
29W/m
1050 lm/m Up
2450 lm/m Down
3000K/CRI 95

■ GN Verde
GN Green

■ 18 Pelle Naturale
18 Natural Leather

■ 14 Nero
14 Black



Descrizione

Questo iconico profilo per installazione a sospensione è caratterizzato da un pregiato rivestimento in pelle sviluppato ad hoc per Flos Architectural per rispondere alle esigenze di sicurezza e pulizia di ambienti pubblici e privati. Belt è pura flessibilità, una linea sinuosa la cui natura è in equilibrio tra la morbidezza della pelle e la rigidità dell'alluminio. L'elemento morbido è rappresentato dalla connessione alla rete elettrica, mentre le parti rigide corrispondono alle sorgenti luminose, delle lunghe linee di luce. Ogni profilo è dotato di illuminazione integrata diretta e indiretta ed è possibile controllare ogni emissione individualmente con controllo remoto dell'installazione. L'installazione del prodotto avviene tramite tiranti in cuoio utilizzati per sospendere il profilo luminoso facendoli scorrere attraverso fibbie in metallo dedicate che fungono da agganci a soffitto. Ogni tirante può essere regolato per rispettare la conformazione dell'ambiente. Uno speciale microconnettore integrato nel terminale del profilo luminoso permette di realizzare la connessione elettrica attraverso un semplice scatto. L'elemento di connessione viene nascosto all'interno del passante in cuoio, che funge da sospensione per sostenere la composizione. Profili disponibili con lunghezze di 2 e 3m con finiture in nero, cuoio naturale e verde.

Sistema Ottico

Profilo lineare Up&Down - emissione diretta/indiretta: General Lighting.

Unità di Alimentazione

Il sistema può essere alimentato solo con fonte di alimentazione remota non compresa con i profili. I driver consigliati vanno ordinati separatamente.

Sistema di Regolazione

Sistema dimmerabile con driver 1-10V, DALI o CASAMBI integrato nell'apparecchio. La regolazione individuale dell'emissione diretta e di quella indiretta può essere gestita mediante controllo Casambi o DALI.

Informazioni Aggiuntive

Sistema elettrico alimentato a 48V.
Grado di protezione IP20.

Adatti ad installazioni su superfici normalmente infiammabili.

Conformità e Marchi di Qualità

Apparecchio conforme alla Normativa Tecnica Europea EN60598-1 e relative parti seconde.

Description

This iconic profile for suspended installation features a refined leather surface developed specifically for Flos Architectural to respond to the needs of safety and cleanliness in public and private environments.

Belt is pure flexibility, a sinuous line that creates a balance between the softness of leather and the rigidity of aluminium. The soft part is represented by the connection to the electrical network, while the rigid parts correspond to the light source, the long lines of light.

Each profile is equipped with integrated direct and indirect lighting and each light source can be controlled individually via remote control.

The product is installed with the use of leather straps to hang the lighting profile, sliding the straps through dedicated metal clasps that act as hooks on the ceiling. Each strap may be regulated to match the shape of the environment.

A special microconnector integrated into the terminal of the lighting profile allows for electrical connection through a simple snap. The electrical connection is hidden within the leather strap, which supports the composition. Profiles available with 2- and 3-m lengths in black, natural leather, and green finishes.

Optic system

Linear Up&Down profile – direct/indirect emission: General Lighting.

Power Supply

The system may be powered only with remote power sources not included with the profiles. Recommended drivers sold separately.

Regulation System

Dimmable system with 1–10 V, DALI, or CASAMBI controller integrated inside the fixture. Individual direct and indirect emission may be regulated through a Casambi or DALI control system.

Additional Information

Electrical system powered at 48V.
IP20 protection grade.
Suitable for installation on normally inflammable surfaces.

Standard Compliance and Quality Marks

EN60598-1 European Technical Standards and any subsequent additions.

BELT – LIGHT MODULE STRUCTURE

Belt

Light Source: Top LED 27,5W/m - 915 lm/m UP - 2000 lm/m DOWN - 2700K/CRI 95 / 27,5W/m - 1050 lm/m UP - 2450 lm/m DOWN - 3000K/CRI 95

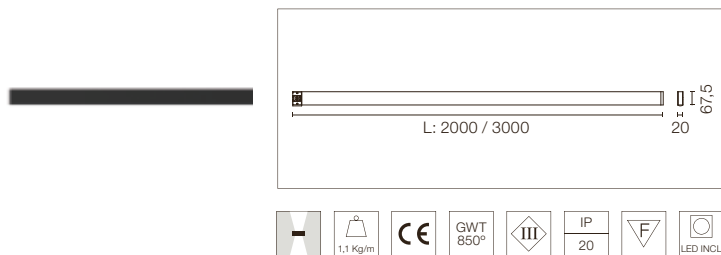

Profilo elettromeccanico da interni con illuminazione lineare integrata per installazione a sospensione disponibile con lunghezza da 2 a 3m. Installazione tramite cinghie di sospensione a soffitto e kit di alimentazione remoto, da ordinare separatamente. Sistema Up&Down controllato tramite DALI o CASAMBI individualmente e via 1-10V insieme (Broadcast).

Electromechanical profile for interior use with integrated linear lighting for suspended installation available with 2 or 3 m lengths. Installation via suspension straps on the ceiling and remote power kit, to be ordered separately. Up&Down system controlled via DALI or CASAMBI individually and via 1-10V all together (Broadcast).

2700K

L: 2000 mm

Dali Version

- 03.8500.GN.DA
- 03.8500.18.DA
- 03.8500.14.DA
- 1-10V (Broadcast)
- 03.8500.GN.1V
- 03.8500.18.1V
- 03.8500.14.1V
- Casambi integrated
- 03.8500.GN.CB
- 03.8500.18.CB
- 03.8500.14.CB

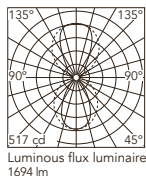

Beam Angle: 60°

h(m)	E(lx)	D(m)
1	517	1.16
2	129	2.31
3	57	3.47
4	32	4.63
5	21	5.79

Luminous flux luminaire
1694 lm

3000K

L: 2000 mm

Dali Version

- 03.8505.GN.DA
- 03.8505.18.DA
- 03.8505.14.DA
- 1-10V (Broadcast)
- 03.8505.GN.1V
- 03.8505.18.1V
- 03.8505.14.1V
- Casambi integrated
- 03.8505.GN.CB
- 03.8505.18.CB
- 03.8505.14.CB

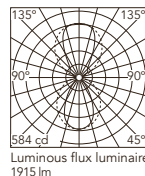

Beam Angle: 60°

h(m)	E(lx)	D(m)
1	584	1.16
2	146	2.31
3	65	3.47
4	37	4.63
5	23	5.79

Luminous flux luminaire
1915 lm

2700K

L: 3000 mm

Dali Version

- 03.8501.GN.DA
- 03.8501.18.DA
- 03.8501.14.DA
- 1-10V (Broadcast)
- 03.8501.GN.1V
- 03.8501.18.1V
- 03.8501.14.1V
- Casambi integrated
- 03.8501.GN.CB
- 03.8501.18.CB
- 03.8501.14.CB

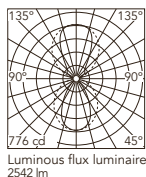

Beam Angle: 60°

h(m)	E(lx)	D(m)
1	776	1.16
2	194	2.31
3	86	3.47
4	48	4.63
5	31	5.79

Luminous flux luminaire
2542 lm

3000K

L: 3000 mm

Dali Version

- 03.8506.GN.DA
- 03.8506.18.DA
- 03.8506.14.DA
- 1-10V (Broadcast)
- 03.8506.GN.1V
- 03.8506.18.1V
- 03.8506.14.1V
- Casambi integrated
- 03.8506.GN.CB
- 03.8506.18.CB
- 03.8506.14.CB

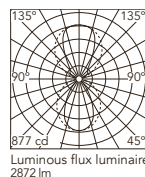

Beam Angle: 60°

h(m)	E(lx)	D(m)
1	877	1.16
2	219	2.31
3	97	3.47
4	55	4.63
5	35	5.79

Luminous flux luminaire
2872 lm

BELT – INSTALLATION

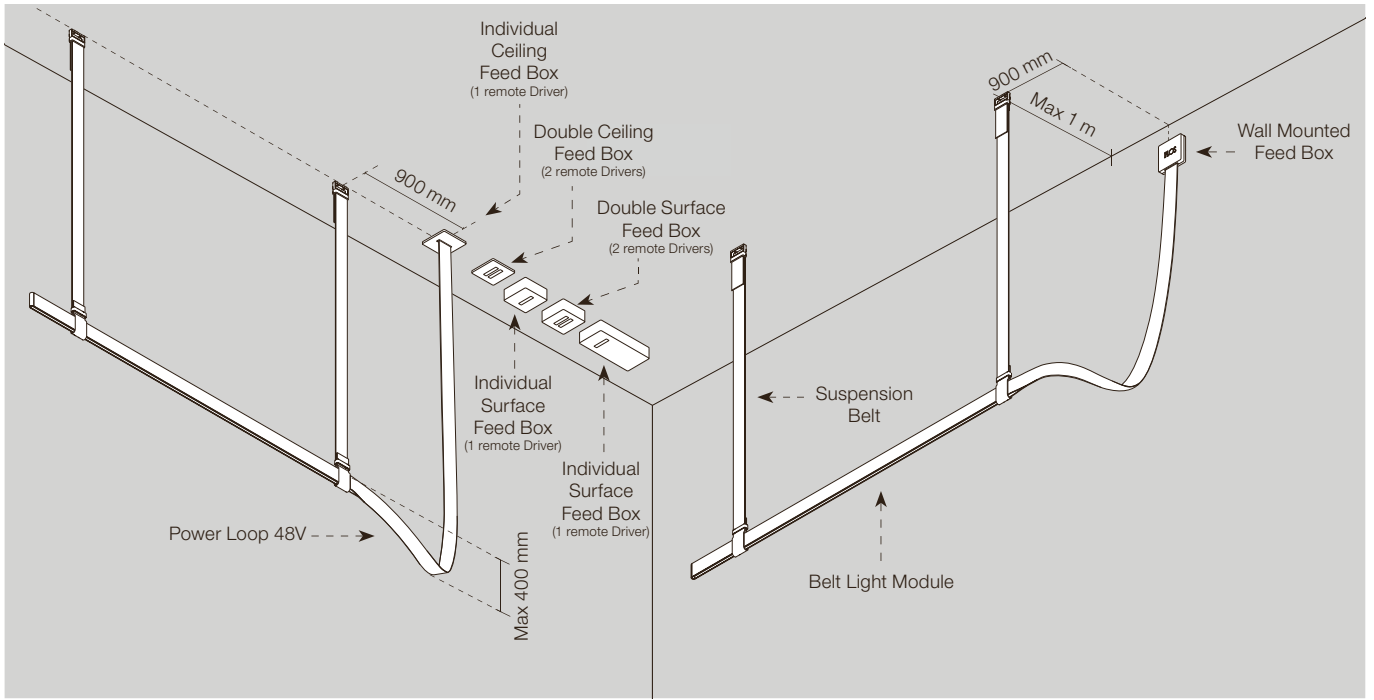

Accessori / Accessories

Cinghia di sospensione. 2 unità.

Suspension strap. 2 units.

Suspension Strap (mm)	Power Loop (mm)
1000	1500
1500	2500
2000	
2500	3500
3000	



- L: 1000 mm
- 03.8510.GN
- 03.8510.18
- 03.8510.14
- L: 1500 mm
- 03.8513.GN
- 03.8513.18
- 03.8513.14
- L: 2000 mm
- 03.8511.GN
- 03.8511.18
- 03.8511.14
- L: 2500 mm
- 03.8514.GN
- 03.8514.18
- 03.8514.14
- L: 3000 mm
- 03.8512.GN
- 03.8512.18
- 03.8512.14

Loop di alimentazione 48V.

48-V power loop.

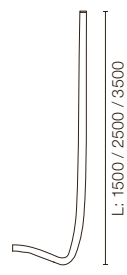





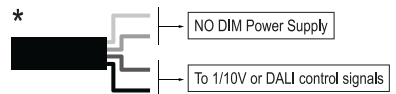
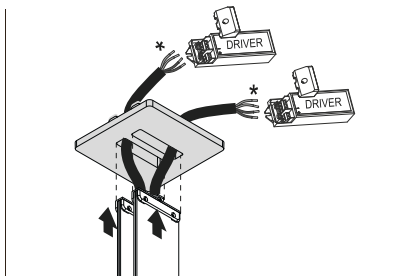
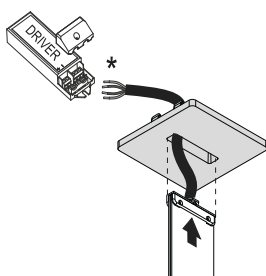



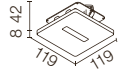

- L: 1500 mm
- 03.8520.GN
- 03.8520.18
- 03.8520.14
- L: 2500 mm
- 03.8521.GN
- 03.8521.18
- 03.8521.14
- L: 3500 mm
- 03.8522.GN
- 03.8522.18
- 03.8522.14

Remote Driver Installations

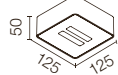

BELT

Accessori / Accessories

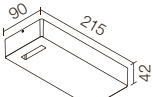
Unità di alimentazione individuale a soffitto. Driver non incluso.	Individual ceiling feed box. Driver not included.			08.0180.00
Unità di alimentazione doppia a soffitto. Driver non incluso.	Double ceiling feed box. Driver not included.			08.0181.00
Unità di alimentazione individuale a parete. Da installare in parallelo al profilo Belt. Driver non incluso.	Wall mounted feed box. To be install in parallel to the Belt profile. Driver not included.			08.0182.00
Unità di alimentazione individuale a superficie. Driver non incluso.	Individual surface feed box. Driver not included.			08.0194.00
Unità di alimentazione doppia a superficie. Driver non incluso.	Double surface feed box. Driver not included.			08.0195.00
Box driver di superficie 96W - 48V, 110-240V.	Surface driver box 96W - 48V, 110-240V.			06.0173.14

Driver / Drivers

Alimentatore LED per installazione remota, 110Vac-135W / 220Vac-200W.	LED power supply source for remote installation, 110Vac-135W / 220Vac-200W.			*60.9607
Alimentatore LED per installazione remota, 48V/120W. 220/240 Vac.	LED power supply source for remote installation, 48V/120W. 220/240 Vac.			*60.9170

* Per il dimensionamento dell'impianto, mantenere un margine di sicurezza di circa il 15% della potenza massima dell'alimentatore LED / For the sizing of the installation keep a safety margin of 15% of the maximum power of the LED power source.

INFRA-STRUCTURE

DESIGNED BY VINCENT VAN DUYSSEN

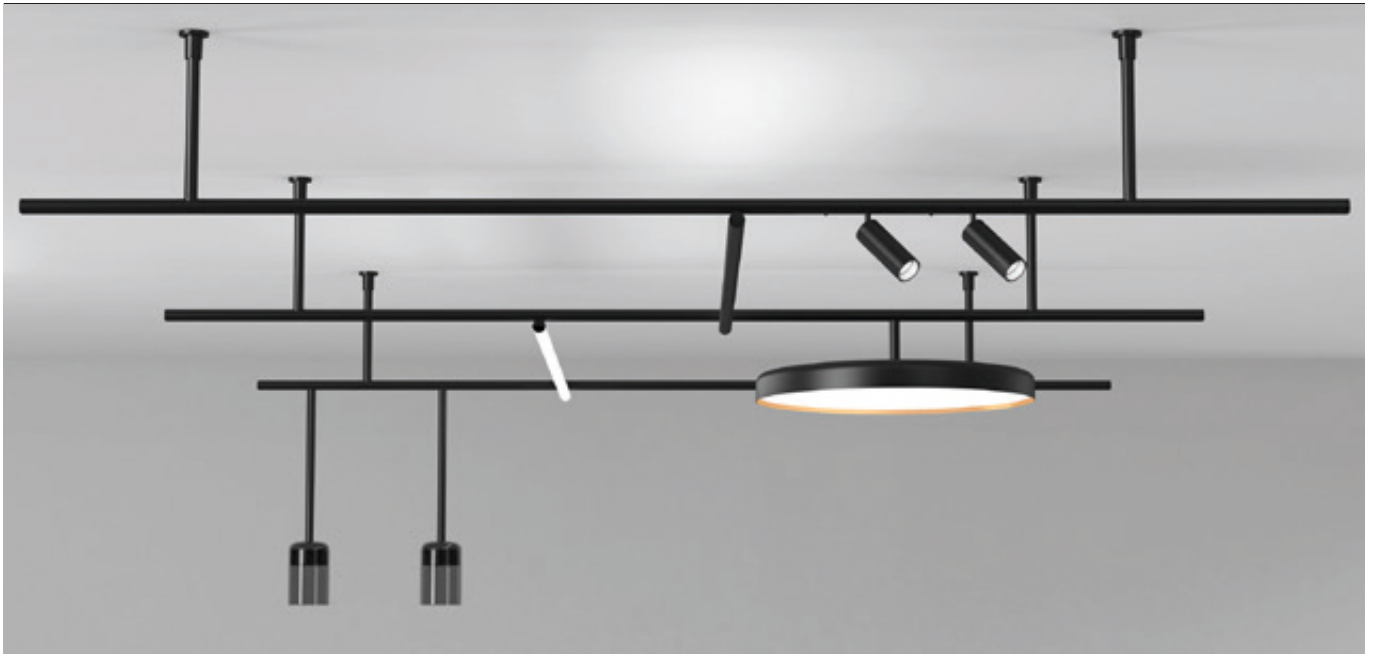

Profiles 40 Bianco
40 White 14 Nero
14 Black

LIGHT MODULES

LIGHT TUBE DIRECT-INDIRECT



LIGHT SOURCE
TOP LED
25W/m
1978 lm/m
2700K/CRI 90
2227 lm/m
3000K/CRI 90

SPOT 50



LIGHT SOURCE
POWER LED
3,5W
286 lm
2700K/CRI 90
307 lm
3000K/CRI 90

SPOT 90



LIGHT SOURCE
POWER LED
8,5W
610 lm
2700K/CRI 90
656 lm
3000K/CRI 90

SPOT 120



LIGHT SOURCE
POWER LED
12W
724 lm
2700K/CRI 90
779 lm
3000K/CRI 90

SPOT 120



LIGHT SOURCE
LED ARRAY
12,5W
1075 lm
2700K/CRI 90
1138 lm
3000K/CRI 90

SPOT 150



LIGHT SOURCE
LED ARRAY
22,5W
2000 lm
2700K/CRI 90
2115 lm
3000K/CRI 90

SUSPENSION PANEL 600



LIGHT SOURCE
TOP LED
40W
3195 lm
2700K/CRI 90
3381 lm
3000K/CRI 90

SUSPENSION GLASS DOWNLIGHT 110



LIGHT SOURCE
LED ARRAY
13,5W
1296 lm
2700K/CRI 90
1371 lm
3000K/CRI 90

Descrizione

Innovativo sistema di illuminazione disegnato da Vincent Van Duysen per l'installazione di superficie a soffitto mediante aste rigide e regolabili.

Nella nuova proposta, oltre alla conosciuta versione "On Board Dimmer", Flos fa un passo avanti, aggiungendo bianchi e corpi illuminanti che possono essere controllati anche con differenti sistemi di controllo remoto: DALI, 1-10V e Casambi.

Entrambe le versioni del profilo sono realizzate con estrusione di alluminio bianco o nero, dotato di conduttori elettrici a 48V.

Inoltre, le versioni controllabili a sistema (DALI, 1-10V), sono dotate di un bus dati in grafite per la regolazione.

Sistema magnetico di installazione dei corpi illuminanti con blocco meccanico di sicurezza.

La famiglia di apparecchi di illuminazione è composta da moduli di illuminazione d'accento con diverse ottiche, sistemi di illuminazione ambientale a luce diretta e indiretta e apparecchi di illuminazione decorativi con il design distintivo di Flos.

Tutti gli apparecchi di illuminazione sono disponibili con potenziometro integrato, dimmabile DALI, 1-10V e Casambi per gestire l'intensità luminosa con una regolazione remota.

Controllo

- Per installazione di corpi illuminanti "On Board Dimmer" usare la versione di binario "On Board Dimmer". I corpi illuminanti in versione DALI e 1-10V sono compatibili esclusivamente con il profilo in versione DALI e 1-10V. I corpi illuminanti in versione Casambi sono compatibili con tutti i profili.

- Per la gestione mediante protocollo DALI è necessario collegare il bus dati di controllo direttamente al profilo.

- Per la gestione 1/10V è necessario che il sistema di controllo sia attivo e collegare il bus dati di controllo direttamente al profilo. In questo caso la regolazione sarà uniforme in tutti gli apparecchi di illuminazione collegati.

- Per gestione con il sistema Casambi (Max. 200 apparecchi) è necessario ordinare apparecchi di illuminazione in versione Casambi. Questi sono compatibili con tutti i profili disponibili nel sistema.

Per la gestione e controllo del sistema Casambi è necessario scaricare la app FLOS Control® powered by Casambi (disponibile in Apple Store e Google Play) per dispositivi mobili.

Numero massimo di interconnessioni tra guide per garantire la comunicazione del segnale DALI o 1-10V: 20 interconnessioni.

Necessaria APP per dispositivi mobili (disponibile su Apple Store).

Sistema Ottico

- Light Tube Direct / Light Tube Indirect / Suspension Glass Downlight 110 / Suspension Panel 600: luce ambiente diffusa.

- Spot 50: Medium.

- Spot 90: Spot, Medium.

- Spot 120 Power LED (stessa fonte luminosa degli Spot 50 e Spot 90): Spot, Medium.

- Spot 120 LED Array (stessa fonte luminosa dello Spot 150): Medium, Flood.

- Spot 150: Spot, Medium, Flood.

Unità di Alimentazione

Alimentatore remoto a 48V non compreso. Max 6A - 320W.

Accessori

Per i moduli di illuminazione Spot, gli accessori di schermatura (honeycomb e crocetta) sono compresi nel prodotto.

Informazioni Aggiuntive

Grado di protezione IP20.

Adatti ad installazioni su superfici normalmente infiammabili.

Conformità e Marchi di Qualità

Apparecchio conforme alla Normativa Tecnica Europea EN60598-1 e relative parti seconde.

Description

Groundbreaking lighting system designed by Vincent Van Duysen for surface installation on ceiling with rigid and adjustable rods.

In the new proposal, beside the successful "On Board Dimmer" version, FLOS goes one step beyond, launching both track and luminaires designed for system management in a variety of options: DALI, 1-10V and Casambi.

Both profile versions are manufactured with aluminium profiling extruded in white or black, provided with electric tracks powered at 48V.

The system controlled versions (DALI, 1-10V) are also equipped with graphite data bus for regulation.

The LED light fixtures are installed by means of a magnetic fixture system with mechanical safety fastening.

The light fixtures product group is composed of accent lighting modules with different optics, direct and indirect light ambient lighting systems and decorative light fixtures with the distinctive Flos design.

All light fixtures are available with potentiometer incorporated, dimmable DALI, 1-10V and Casambi to adjust the light intensity.

Control

- For installation of "On Board Dimmer" fixtures use "On Board Dimmer" track version.

Luminaires DALI and 1-10V are only compatible with track DALI and 1-10V.

Casambi luminaires can be installed on all profiles available in the system.

- To manage using DALI protocol, it is necessary to connect the control data bus directly to the profile.

- For 1-10V management, the control system must be active and the data bus must be connected directly to the profile. In this case, regulation will be uniform in all the connected luminaires.

- For Casambi management (Max. 200 luminaires) it is mandatory to use fixtures in the Casambi version, these are compatible with all profiles available in the system.

For managing and controlling the Casambi system, the FLOS Control® app powered by Casambi for mobile devices is necessary (available in the Apple Store and Google Play).

Maximum number of track interconnections to guarantee the communication of the DALI or 1-10V signal: 20 interconnections.

Optic system

- Light Tube Direct / Light Tube Indirect / Suspension Glass Downlight 110 / Suspension Panel 600: diffuse ambient light.

- Spot 50: Medium.

- Spot 90: Spot, Medium.

- Spot 120 Power LED (same light source as the Spot 50 and Spot 90): Spot, Medium.

- Spot 120 LED Array (same light source as the Spot 150): Medium, Flood.

- Spot 150: Spot, Medium, Flood.

Power Supply

Remote 48V power supply not included. Max 6A - 320W.

Accessories

For the Spot illumination modules, the cross-screening accessories (honeycomb and crosspieces) are incorporated into the product.

Additional Information

IP20 protection grade.

Suitable for installation on normally inflammable surfaces.

Compliance of Standards and Quality Marks

EN60598-1 European Technical Standards and any subsequent additions.

FLOS
CONTROL BY CASAMBI



INFRA-STRUCTURE – PROFILES

Profili

Profilo elettromagnetico tubolare per installazione a superficie su soffitto con fissaggio con aste rigide e regolabili in altezza (25 mm). Aste non regolabili disponibili a richiesta.

I profili possono contenere apparecchi di illuminazione in versione "on board dimmer", DALI o 1-10 V, a seconda del sistema di controllo scelto.

Profili tubolari e terminali di chiusura disponibili in versione compatibile con apparecchi On Board Dimmer e versione compatibile con apparecchi controllabili come sistema (DALI, 1-10V o FLOS Control® by Casambi).

Profili tubolari disponibili in due lunghezze: 1055 mm (separazione tra aste 1100 mm) e 1555 mm (separazione tra aste 1600 mm).

I terminali di chiusura sono anch'essi elettrificati e devono essere ordinati separatamente.

Tutte le aste meccaniche ed elettriche sono comuni alle due versioni e sono disponibili in varie altezze (100, 300, 400 e 700mm).

Diverse versioni di aste di fissaggio:

- Asta meccanica con rosone da Ø50 o da Ø140: per fissaggio di profili.
- Asta di alimentazione elettrica con rosone da Ø50: asta di alimentazione, per installazione remota della fonte di alimentazione in luogo accessibile.
- Asta di alimentazione elettrica con rosone da Ø140: asta di alimentazione per installazione remota della fonte di alimentazione attraverso il rosone.
- Asta di connessione dati con rosone da Ø50 o da Ø140: per connessione alla sorgente di segnale DALI o 1-10V.
- Maschera in alluminio per contrassegnare i punti di fissaggio per l'installazione delle aste disponibile separatamente.

Profiles

Tubular electromagnetic profile for surface installation in ceilings through rigid and adjustable rods (25 mm). Not adjustable rigid rods available on request. Profiles and closure terminals are available in version compatible with luminaries "on board dimmer" and versions compatible with system controlled luminaries (DALI, 1-10V, FLOS Control® by Casambi).

Tubular profiles available in two lengths: 1055 mm (1100 mm separation between rods) and 1555 mm (1600 mm separation between rods).

The closure terminals will also be electrified and must be ordered separately. Mechanical and electrical rods are the same for the two profile versions and they are all available in multiple lengths (100, 300, 400, 700mm).

Different versions of fastening rods:

- Mechanic rod with a Ø50 or Ø140 connection rose: to fasten profiles.
- Electrical rod with a Ø50 connection rose: a supply rod for remote installation of the power supply in an accessible place.
- Electrical rod with a Ø140 connection rose: a supply rod for remote installation of the power supply through the connection rose.
- Data connection rod with a Ø50 or Ø140 connection rose: for connection to DALI or 1-10V bus signal.
- Aluminium stencil to mark the points for installing the rods available as separate item.

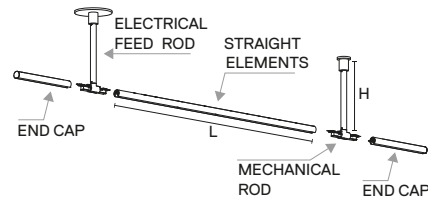

L: 1055 mm / 1555 mm

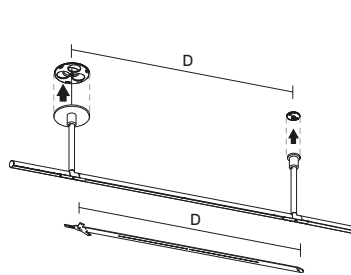

D: 1100 mm / 1600 mm

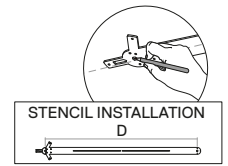

Aluminium Stencil Installation

D: 1100 mm
08.0032.00
D: 1600 mm
08.0033.00

Elementi lineari.

Straight elements.

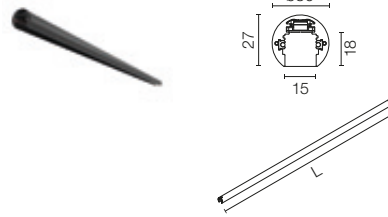

L: 1055 mm (D: 1100 mm)
L: 1555 mm (D: 1600 mm)

On board dimmer/
FLOS Control® by Casambi
compatible

L: 1055 mm
06.5140.40
06.5140.14
L: 1555 mm
06.5141.40
06.5141.14

DALI/1-10V/*FLOS Control® by Casambi
compatible

L: 1055 mm
06.5100.40
06.5100.14
L: 1555 mm
06.5101.40
06.5101.14

Terminale di chiusura.

End cap.



On board dimmer/
FLOS Control® by Casambi
compatible

06.5142.40A
06.5142.14A

DALI/1-10V/*FLOS Control® by Casambi
compatible

06.5135.40A
06.5135.14A

Asta meccanica rosone ø50 mm.
Regolabile 25mm per poter
essere adattato a soffitti
irregolari.

Mechanical rod rose ø50 mm.
Adjustable 25 mm, to adapt it to
irregular ceilings.

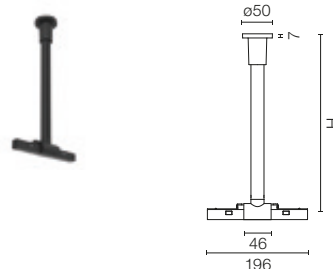

H: 100 mm
06.5110.40
06.5110.14
H: 300 mm
06.5111.40
06.5111.14
H: 400 mm
06.5112.40
06.5112.14
H: 700 mm
06.5113.40
06.5113.14

* Per installazioni esistenti / For existing installations.

INFRA-STRUCTURE – PROFILES

Asta di alimentazione elettrica
rosone ø50 mm.
Regolabile 25mm per poter essere
adattato a soffitti irregolari.

Electrical feed rod rose ø50 mm.
Adjustable 25 mm, to adapt it to
irregular ceilings.

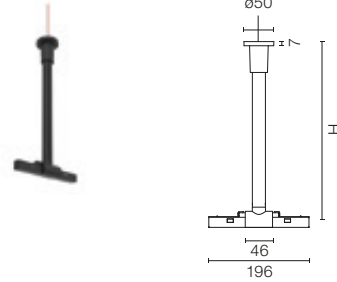

- H: 100 mm
- 06.5120.40
- 06.5120.14
- H: 300 mm
- 06.5121.40
- 06.5121.14
- H: 400 mm
- 06.5122.40
- 06.5122.14
- H: 700 mm
- 06.5123.40
- 06.5123.14

Asta di connessione dati con rosone
ø50 mm.
Utilizzare una per ogni linea della
installazione, per connessione alla
sorgente di segnale DALI o 1-10V.
Regolabile 25mm per poter essere
adattato a soffitti irregolari.

Data connection rod rose ø50mm.
Use one for each line of the
installation, for connection to DALI
or 1-10V signal source.
Adjustable 25 mm, to adapt it to
irregular ceilings.

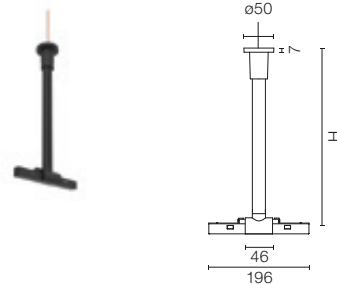

- H: 100 mm
- 06.5150.40
- 06.5150.14
- H: 300 mm
- 06.5151.40
- 06.5151.14
- H: 400 mm
- 06.5152.40
- 06.5152.14
- H: 700 mm
- 06.5153.40
- 06.5153.14

Asta meccanica rosone ø140 mm.
Regolabile 25mm per poter essere
adattato a soffitti irregolari.

Mechanical rod rose ø140 mm.
Adjustable 25 mm, to adapt it to
irregular ceilings.

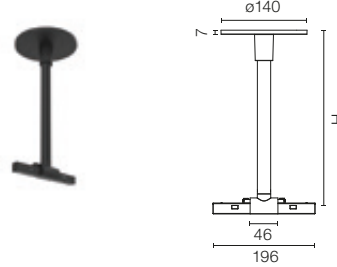

- H: 100 mm
- 06.5115.40
- 06.5115.14
- H: 300 mm
- 06.5116.40
- 06.5116.14
- H: 400 mm
- 06.5117.40
- 06.5117.14
- H: 700 mm
- 06.5118.40
- 06.5118.14

Asta di alimentazione elettrica
rosone ø140 mm.
Regolabile 25mm per poter essere
adattato a soffitti irregolari.

Electrical feed rod rose ø140 mm.
Adjustable 25 mm, to adapt it to
irregular ceilings.

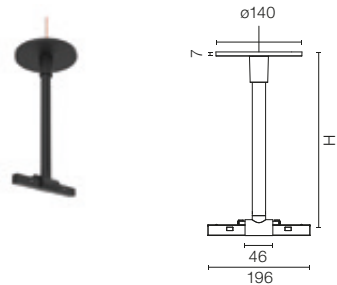

- H: 100 mm
- 06.5125.40
- 06.5125.14
- H: 300 mm
- 06.5126.40
- 06.5126.14
- H: 400 mm
- 06.5127.40
- 06.5127.14
- H: 700 mm
- 06.5128.40
- 06.5128.14

Asta di connessione dati con rosone
ø140 mm.
Utilizzare una per ogni linea della
installazione, per connessione alla
sorgente di segnale DALI o 1-10V.
Regolabile 25mm per poter essere
adattato a soffitti irregolari.

Data connection rod rose ø140mm.
Use one for each line of the
installation, for connection to DALI
or 1-10V signal source.
Adjustable 25 mm, to adapt it to
irregular ceilings.

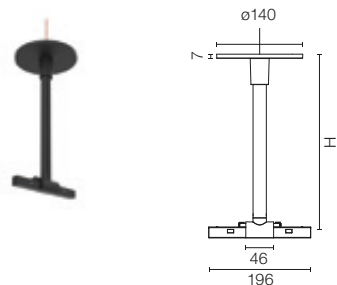

- H: 100 mm
- 06.5155.40
- 06.5155.14
- H: 300 mm
- 06.5156.40
- 06.5156.14
- H: 400 mm
- 06.5157.40
- 06.5157.14
- H: 700 mm
- 06.5158.40
- 06.5158.14

Tubo cieco.

Blind tube.

Modulo meccanico (senza
illuminazione) per l'installazione nel
sistema Infra-Structure. Elementi
di fissaggio girevoli 0°-90°, con
connessione magnetica e blocco
di sicurezza meccanico, per
installazione trasversale tra due linee
di profilo.

A mechanical module (without
lighting) to be installed in the system
infrastructure. Fixing components
that rotate 0°-90°, with a magnetic
connection and a mechanical safety
lock. To be installed transversely
between two profile lines.

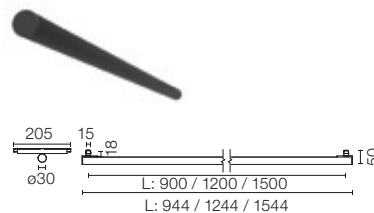

- L: 900 mm
- 03.8120.40
- 03.8120.14
- L: 1200 mm
- 03.8121.40
- 03.8121.14
- L: 1500 mm
- 03.8122.40
- 03.8122.14

Light Tube ø30 Direct

Light Source: Top LED 25W/m - 1978 lm/m - 2700K/CRI 90 / 25W/m - 2227 lm/m - 3000K/CRI 90

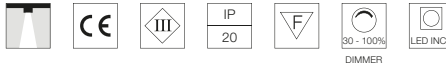
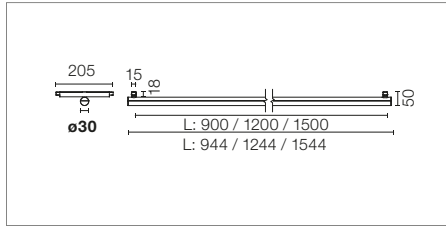

Modulo di illuminazione LED a luce diffusa da installare nel sistema Infra-Structure.

Elementi di fissaggio giratori 0°-90°, con collegamento magnetico e attacco di sicurezza meccanico per installazione trasversale tra due profili.

I Light Tubes sono alimentati solo da una delle estremità e non trasmettono corrente attraverso l'altra estremità.

Per il controllo bluetooth dei moduli luminosi selezionare le versioni con Casambi integrato.

Diffused LED light module to be installed in The Infra-Structure. System turning fastening elements 0°-90° with a magnetic connection and mechanic security lock for a transversally installation between two lines of the profile.

The Light Tube are only fed by one of the ends and do not communicate current through the other end.

For wireless lighting control, choose integrated Casambi versions.

2700K

L: 900 mm - 23W - 1820 lm

On board dimmer

03.8100.40

03.8100.14

*DALI Version

03.8100.40.DA

03.8100.14.DA

*1-10V

03.8100.40.1V

03.8100.14.1V

**Casambi integrated

03.8100.40.CB

03.8100.14.CB

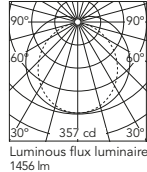

Beam Angle: 106°

h(m) E(lx) D(m)

1 357 7.49

2 89 14.98

3 40 22.47

4 22 29.96

5 14 37.45

Luminous flux luminaire
1456 lm

3000K

L: 900 mm - 23W - 2048 lm

On board dimmer

03.8105.40

03.8105.14

*DALI Version

03.8105.40.DA

03.8105.14.DA

*1-10V

03.8105.40.1V

03.8105.14.1V

**Casambi integrated

03.8105.40.CB

03.8105.14.CB

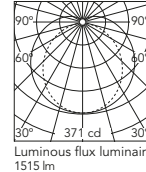

Beam Angle: 106°

h(m) E(lx) D(m)

1 371 7.49

2 93 14.98

3 41 22.47

4 23 29.96

5 15 37.45

Luminous flux luminaire
1515 lm

2700K

L: 1200 mm - 30W - 2366 lm

On board dimmer

03.8101.40

03.8101.14

*DALI Version

03.8101.40.DA

03.8101.14.DA

*1-10V

03.8101.40.1V

03.8101.14.1V

**Casambi integrated

03.8101.40.CB

03.8101.14.CB

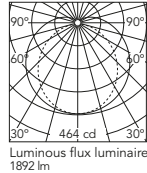

Beam Angle: 106°

h(m) E(lx) D(m)

1 464 7.49

2 116 14.98

3 52 22.47

4 29 29.96

5 19 37.45

Luminous flux luminaire
1892 lm

3000K

L: 1200 mm - 30W - 2663 lm

On board dimmer

03.8106.40

03.8106.14

*DALI Version

03.8106.40.DA

03.8106.14.DA

*1-10V

03.8106.40.1V

03.8106.14.1V

**Casambi integrated

03.8106.40.CB

03.8106.14.CB

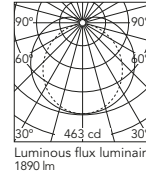

Beam Angle: 106°

h(m) E(lx) D(m)

1 463 7.49

2 116 14.98

3 51 22.47

4 29 29.96

5 19 37.45

Luminous flux luminaire
1890 lm

2700K

L: 1500 mm - 38W - 2912 lm

On board dimmer

03.8102.40

03.8102.14

*DALI Version

03.8102.40.DA

03.8102.14.DA

*1-10V

03.8102.40.1V

03.8102.14.1V

**Casambi integrated

03.8102.40.CB

03.8102.14.CB

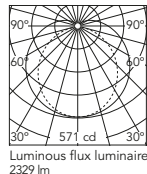

Beam Angle: 106°

h(m) E(lx) D(m)

1 571 7.49

2 143 14.98

3 63 22.47

4 36 29.96

5 23 37.45

Luminous flux luminaire
2329 lm

3000K

L: 1500 mm - 38W - 3278 lm

On board dimmer

03.8107.40

03.8107.14

*DALI Version

03.8107.40.DA

03.8107.14.DA

*1-10V

03.8107.40.1V

03.8107.14.1V

**Casambi integrated

03.8107.40.CB

03.8107.14.CB

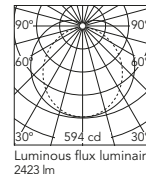

Beam Angle: 106°

h(m) E(lx) D(m)

1 594 7.49

2 149 14.98

3 66 22.47

4 37 29.96

5 24 37.45

Luminous flux luminaire
2423 lm

* Compatibile solo con profili in versione DALI-1-10V / Only compatible with DALI, 1-10V profile version .

** Il sistema di controllo degli apparecchi i versione Casambi si regola direttamente tramite bluetooth con l'applicazione dedicata FLOS Control® by Casambi / The control system with the Casambi version of light fixtures is directly and individually regulated wirelessly using the application FLOS Control® by Casambi.

INFRA-STRUCTURE – LIGHT MODULES

Light Tube ø30 Indirect

Light Source: Top LED 25W/m - 1978 lm/m - 2700K/CRI 90 / 25W/m - 2227 lm/m - 3000K/CRI 90

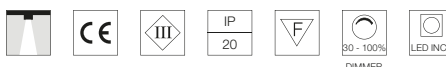
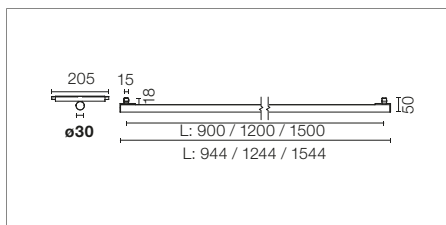

Modulo di illuminazione LED a luce diffusa da installare nel sistema Infra-Structure.

Elementi di fissaggio giratori 0°-90°, con collegamento magnetico e attacco di sicurezza meccanico per installazione trasversale tra due profili.

I Light Tubes sono alimentati solo da una delle estremità e non trasmettono corrente attraverso l'altra estremità.

Per il controllo bluetooth dei moduli luminosi selezionare le versioni con Casambi integrato.

Diffused LED light module to be installed in The Infra-Structure. System turning fastening elements 0°-90° with a magnetic connection and mechanic security lock for a transversally installation between two lines of the profile.

The Light Tube are only fed by one of the ends and do not communicate current through the other end.

For wireless lighting control, choose integrated Casambi versions.

2700K

L: 900 mm - 23W - 1820 lm

On board dimmer

03.8110.40

03.8110.14

*Dali Version

03.8110.40.DA

03.8110.14.DA

*1-10V

03.8110.40.1V

03.8110.14.1V

**Casambi integrated

03.8110.40.CB

03.8110.14.CB

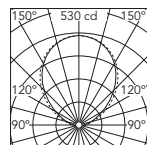

Luminous flux luminaire
1239 lm

Beam Angle: 99°

h(m)	E(lx)	D(m)
1	530	2.12
2	133	4.25
3	59	6.37
4	33	8.50
5	21	10.62

3000K

L: 900 mm - 23W - 2048 lm

On board dimmer

03.8115.40

03.8115.14

*Dali Version

03.8115.40.DA

03.8115.14.DA

*1-10V

03.8115.40.1V

03.8115.14.1V

**Casambi integrated

03.8115.40.CB

03.8115.14.CB

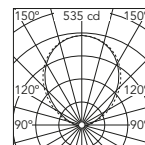

Luminous flux luminaire
1249 lm

Beam Angle: 99°

h(m)	E(lx)	D(m)
1	535	2.12
2	134	4.25
3	59	6.37
4	33	8.50
5	21	10.62

2700K

L: 1200 mm - 30W - 2366 lm

On board dimmer

03.8111.40

03.8111.14

*Dali Version

03.8111.40.DA

03.8111.14.DA

*1-10V

03.8111.40.1V

03.8111.14.1V

**Casambi integrated

03.8111.40.CB

03.8111.14.CB

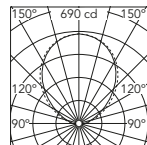

Luminous flux luminaire
1612 lm

Beam Angle: 99°

h(m)	E(lx)	D(m)
1	690	2.12
2	173	4.25
3	77	6.37
4	43	8.50
5	28	10.62

3000K

L: 1200 mm - 30W - 2663 lm

On board dimmer

03.8116.40

03.8116.14

*Dali Version

03.8116.40.DA

03.8116.14.DA

*1-10V

03.8116.40.1V

03.8116.14.1V

**Casambi integrated

03.8116.40.CB

03.8116.14.CB

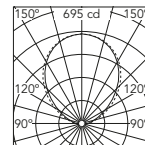

Luminous flux luminaire
1624 lm

Beam Angle: 99°

h(m)	E(lx)	D(m)
1	695	2.12
2	174	4.25
3	77	6.37
4	43	8.50
5	28	10.62

2700K

L: 1500 mm - 38W - 2912 lm

On board dimmer

03.8112.40

03.8112.14

*Dali Version

03.8112.40.DA

03.8112.14.DA

*1-10V

03.8112.40.1V

03.8112.14.1V

**Casambi integrated

03.8112.40.CB

03.8112.14.CB

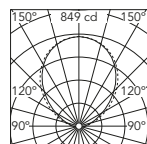

Luminous flux luminaire
1984 lm

Beam Angle: 99°

h(m)	E(lx)	D(m)
1	849	2.12
2	212	4.25
3	94	6.37
4	53	8.50
5	34	10.62

3000K

L: 1500 mm - 38W - 3278 lm

On board dimmer

03.8117.40

03.8117.14

*Dali Version

03.8117.40.DA

03.8117.14.DA

*1-10V

03.8117.40.1V

03.8117.14.1V

**Casambi integrated

03.8117.40.CB

03.8117.14.CB

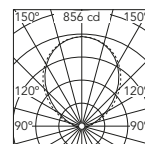

Luminous flux luminaire
1999 lm

Beam Angle: 99°

h(m)	E(lx)	D(m)
1	856	2.12
2	214	4.25
3	95	6.37
4	53	8.50
5	34	10.62

* Compatibile solo con profili in versione DALI-1-10V / Only compatible with DALI, 1-10V profile version .

** Il sistema di controllo degli apparecchi i versione Casambi si regola direttamente tramite bluetooth con l'applicazione dedicata FLOS Control® by Casambi / The control system with the Casambi version of light fixtures is directly and individually regulated wirelessly using the application FLOS Control® by Casambi.

Spot 50

Light Source: Power LED 3,5W - 286 lm - 2700K/CRI 90 / 3,5W - 307 lm - 3000K/CRI 90

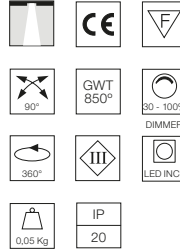
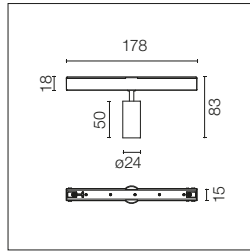

Modulo di illuminazione LED d'accento da installare nel sistema Infra-Structure.

Per il controllo bluetooth dei moduli luminosi selezionare le versioni con Casambi integrato.

Accessori inclusi (honeycomb e filtro a croce antiabbagliamento).

Accent lighting LED module to be installed in The Infra-Structure System.

For wireless lighting control, choose integrated Casambi versions.

Accessories included (honeycomb and screening crosspiece).

2700K

On board dimmer

03.8032.40A
03.8032.05A
03.8032.14A

*Dali Version

03.8032.40ADA
03.8032.05ADA
03.8032.14ADA

**1-10V

03.8032.40A1V
03.8032.05A1V
03.8032.14A1V

**Casambi integrated

03.8032.40ACB
03.8032.05ACB
03.8032.14ACB

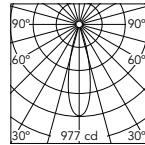

Luminous flux luminaire
205 lm (EXTREME CUT OFF)

Beam Angle: 26°

h(m) E(lx) D(m)

1	977	0.47
2	244	0.94
3	109	1.41
4	61	1.88
5	39	2.35

3000K

On board dimmer

03.8033.40A
03.8033.05A
03.8033.14A

*Dali Version

03.8033.40ADA
03.8033.05ADA
03.8033.14ADA

**1-10V

03.8033.40A1V
03.8033.05A1V
03.8033.14A1V

**Casambi integrated

03.8033.40ACB
03.8033.05ACB
03.8033.14ACB

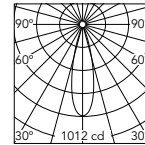

Luminous flux luminaire
212 lm (EXTREME CUT OFF)

Beam Angle: 26°

h(m) E(lx) D(m)

1	1012	0.47
2	253	0.94
3	112	1.41
4	63	1.88
5	40	2.35

* Compatibile solo con profili in versione DALI-1-10V / Only compatible with DALI, 1-10V profile version .

** Il sistema di controllo degli apparecchi in versione Casambi si regola direttamente tramite bluetooth con l'applicazione dedicata FLOS Control® by Casambi / The control system with the Casambi version of light fixtures is directly and individually regulated wirelessly using the application FLOS Control® by Casambi.

INFRA-STRUCTURE – LIGHT MODULES

Spot 90

Light Source: Power LED 8,5W - 610 lm - 2700K/CRI 90 / 8,5W - 656 lm - 3000K/CRI 90

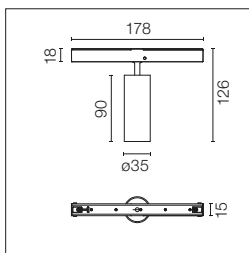

Modulo di illuminazione LED d'accento da installare nel sistema Infra-Structure.

Per il controllo bluetooth dei moduli luminosi selezionare le versioni con Casambi integrato.

Accessori inclusi (honeycomb e filtro a croce antiabbagliamento).

Accent lighting LED module to be installed in The Infra-Structure System.

For wireless lighting control, choose integrated Casambi versions.

Accessories included (honeycomb and screening crosspiece).

2700K

On board dimmer

- 03.8042.40A
- 03.8042.05A
- 03.8042.14A

*Dali Version

- 03.8042.40ADA
- 03.8042.05ADA
- 03.8042.14ADA

*1-10V

- 03.8042.40A1V
- 03.8042.05A1V
- 03.8042.14A1V

**Casambi integrated

- 03.8042.40ACB
- 03.8042.05ACB
- 03.8042.14ACB

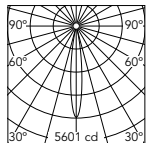

Beam Angle: 14°

h(m)	E(lx)	D(m)
1	5601	0.25
2	1400	0.49
3	622	0.74
4	350	0.98
5	224	1.23

Luminous flux luminaire 428 lm (EXTREME CUT OFF)

3000K

On board dimmer

- 03.8043.40A
- 03.8043.05A
- 03.8043.14A

*Dali Version

- 03.8043.40ADA
- 03.8043.05ADA
- 03.8043.14ADA

*1-10V

- 03.8043.40A1V
- 03.8043.05A1V
- 03.8043.14A1V

**Casambi integrated

- 03.8043.40ACB
- 03.8043.05ACB
- 03.8043.14ACB

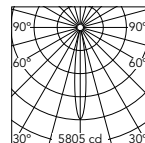

Beam Angle: 14°

h(m)	E(lx)	D(m)
1	5805	0.25
2	1451	0.49
3	645	0.74
4	363	0.98
5	232	1.23

Luminous flux luminaire 443 lm (EXTREME CUT OFF)

2700K

On board dimmer

- 03.8044.40A
- 03.8044.05A
- 03.8044.14A

*Dali Version

- 03.8044.40ADA
- 03.8044.05ADA
- 03.8044.14ADA

*1-10V

- 03.8044.40A1V
- 03.8044.05A1V
- 03.8044.14A1V

**Casambi integrated

- 03.8044.40ACB
- 03.8044.05ACB
- 03.8044.14ACB

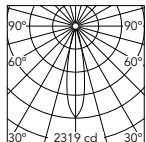

Beam Angle: 22°

h(m)	E(lx)	D(m)
1	2319	0.38
2	580	0.77
3	258	1.15
4	145	1.54
5	93	1.92

Luminous flux luminaire 392 lm (EXTREME CUT OFF)

3000K

On board dimmer

- 03.8045.40A
- 03.8045.05A
- 03.8045.14A

*Dali Version

- 03.8045.40ADA
- 03.8045.05ADA
- 03.8045.14ADA

*1-10V

- 03.8045.40A1V
- 03.8045.05A1V
- 03.8045.14A1V

**Casambi integrated

- 03.8045.40ACB
- 03.8045.05ACB
- 03.8045.14ACB

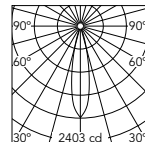

Beam Angle: 22°

h(m)	E(lx)	D(m)
1	2403	0.38
2	601	0.77
3	267	1.15
4	150	1.54
5	96	1.92

Luminous flux luminaire 406 lm (EXTREME CUT OFF)

* Compatibile solo con profili in versione DALI-1-10V / Only compatible with DALI, 1-10V profile version .

** Il sistema di controllo degli apparecchi i versione Casambi si regola direttamente tramite bluetooth con l'applicazione dedicata FLOS Control® by Casambi / The control system with the Casambi version of light fixtures is directly and individually regulated wirelessly using the application FLOS Control® by Casambi.

Spot 120

Light Source: Power LED 12W - 724 lm - 2700K/CRI 90 / 12W - 779 lm - 3000K/CRI 90

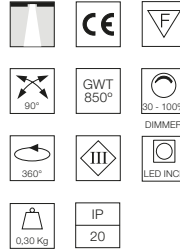
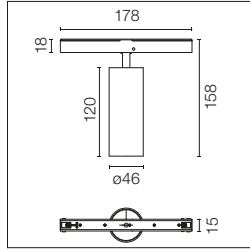

Modulo di illuminazione LED d'accento da installare nel sistema Infra-Structure.

Per il controllo bluetooth dei moduli luminosi selezionare le versioni con Casambi integrato.

Accessori inclusi (honeycomb e filtro a croce antiabbagliamento).

Accent lighting LED module to be installed in The Infra-Structure System.

For wireless lighting control, choose integrated Casambi versions.

Accessories included (honeycomb and screening crosspiece).

2700K

On board dimmer

- 03.8052.40A
- 03.8052.05A
- 03.8052.14A
- *Dali Version
- 03.8052.40ADA
- 03.8052.05ADA
- 03.8052.14ADA
- *1-10V
- 03.8052.40A1V
- 03.8052.05A1V
- 03.8052.14A1V
- **Casambi integrated
- 03.8052.40ACB
- 03.8052.05ACB
- 03.8052.14ACB

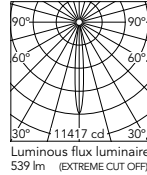

Beam Angle: 11°

h(m)	E(lx)	D(m)
1	11417	0.19
2	2854	0.37
3	1269	0.56
4	714	0.75
5	457	0.93

3000K

On board dimmer

- 03.8053.40A
- 03.8053.05A
- 03.8053.14A
- *Dali Version
- 03.8053.40ADA
- 03.8053.05ADA
- 03.8053.14ADA
- *1-10V
- 03.8053.40A1V
- 03.8053.05A1V
- 03.8053.14A1V
- **Casambi integrated
- 03.8053.40ACB
- 03.8053.05ACB
- 03.8053.14ACB

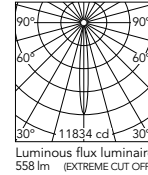

Beam Angle: 11°

h(m)	E(lx)	D(m)
1	11834	0.19
2	2958	0.37
3	1315	0.56
4	740	0.75
5	473	0.93

2700K

On board dimmer

- 03.8054.40A
- 03.8054.05A
- 03.8054.14A
- *Dali Version
- 03.8054.40ADA
- 03.8054.05ADA
- 03.8054.14ADA
- *1-10V
- 03.8054.40A1V
- 03.8054.05A1V
- 03.8054.14A1V
- **Casambi integrated
- 03.8054.40ACB
- 03.8054.05ACB
- 03.8054.14ACB

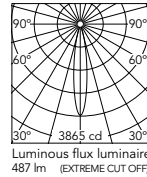

Beam Angle: 17°

h(m)	E(lx)	D(m)
1	3865	0.29
2	966	0.59
3	429	0.88
4	242	1.18
5	155	1.47

3000K

On board dimmer

- 03.8055.40A
- 03.8055.05A
- 03.8055.14A
- *Dali Version
- 03.8055.40ADA
- 03.8055.05ADA
- 03.8055.14ADA
- *1-10V
- 03.8055.40A1V
- 03.8055.05A1V
- 03.8055.14A1V
- **Casambi integrated
- 03.8055.40ACB
- 03.8055.05ACB
- 03.8055.14ACB

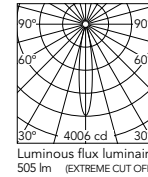

Beam Angle: 17°

h(m)	E(lx)	D(m)
1	4006	0.29
2	1001	0.59
3	445	0.88
4	250	1.18
5	160	1.47

* Compatibile solo con profili in versione DALI-1-10V / Only compatible with DALI, 1-10V profile version .

** Il sistema di controllo degli apparecchi in versione Casambi si regola direttamente tramite bluetooth con l'applicazione dedicata FLOS Control® by Casambi / The control system with the Casambi version of light fixtures is directly and individually regulated wirelessly using the application FLOS Control® by Casambi.

INFRA-STRUCTURE – LIGHT MODULES

Spot 120

Light Source: LED Array 12,5W - 1075 lm - 2700K/CRI 90 / 12,5W - 1138 lm - 3000K/CRI 90

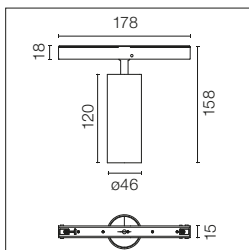

- LED INCL
- CE
- EneC
- 90°
- GWT 850°
- 30 - 100% DIMMER
- 360°
- III
- IP 20
- 0,30 Kg

Modulo di illuminazione LED d'accento da installare nel sistema Infra-Structure.

Per il controllo bluetooth dei moduli luminosi selezionare le versioni con Casambi integrato.

Accessori inclusi (honeycomb e filtro a croce antiabbagliamento).

Accent lighting LED module to be installed in The Infra-Structure System.

For wireless lighting control, choose integrated Casambi versions.

Accessories included (honeycomb and screening crosspiece).

2700K

On board dimmer

- 03.8154.40
- 03.8154.05
- 03.8154.14
- *Dali Version
- 03.8154.40.DA
- 03.8154.05.DA
- 03.8154.14.DA
- *1-10V
- 03.8154.40.1V
- 03.8154.05.1V
- 03.8154.14.1V
- **Casambi integrated
- 03.8154.40.CB
- 03.8154.05.CB
- 03.8154.14.CB

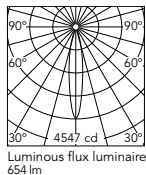

Beam Angle: 17°

h(m)	E(lx)	D(m)
1	4547	0.31
2	1137	0.61
3	505	0.92
4	284	1.23
5	182	1.53

Luminous flux luminaire 654 lm

3000K

On board dimmer

- 03.8155.40
- 03.8155.05
- 03.8155.14
- *Dali Version
- 03.8155.40.DA
- 03.8155.05.DA
- 03.8155.14.DA
- *1-10V
- 03.8155.40.1V
- 03.8155.05.1V
- 03.8155.14.1V
- **Casambi integrated
- 03.8155.40.CB
- 03.8155.05.CB
- 03.8155.14.CB

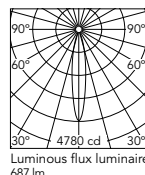

Beam Angle: 17°

h(m)	E(lx)	D(m)
1	4780	0.31
2	1195	0.61
3	531	0.92
4	299	1.23
5	191	1.53

Luminous flux luminaire 687 lm

2700K

On board dimmer

- 03.8156.40
- 03.8156.05
- 03.8156.14
- *Dali Version
- 03.8156.40.DA
- 03.8156.05.DA
- 03.8156.14.DA
- *1-10V
- 03.8156.40.1V
- 03.8156.05.1V
- 03.8156.14.1V
- **Casambi integrated
- 03.8156.40.CB
- 03.8156.05.CB
- 03.8156.14.CB

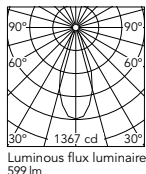

Beam Angle: 40°

h(m)	E(lx)	D(m)
1	1367	0.73
2	342	1.45
3	152	2.18
4	85	2.91
5	55	3.64

Luminous flux luminaire 599 lm

3000K

On board dimmer

- 03.8157.40
- 03.8157.05
- 03.8157.14
- *Dali Version
- 03.8157.40.DA
- 03.8157.05.DA
- 03.8157.14.DA
- *1-10V
- 03.8157.40.1V
- 03.8157.05.1V
- 03.8157.14.1V
- **Casambi integrated
- 03.8157.40.CB
- 03.8157.05.CB
- 03.8157.14.CB

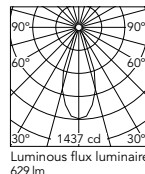

Beam Angle: 40°

h(m)	E(lx)	D(m)
1	1437	0.73
2	359	1.45
3	160	2.18
4	90	2.91
5	57	3.64

Luminous flux luminaire 629 lm

* Compatibile solo con profili in versione DALI-1-10V / Only compatible with DALI, 1-10V profile version .

** Il sistema di controllo degli apparecchi i versione Casambi si regola direttamente tramite bluetooth con l'applicazione dedicata FLOS Control® by Casambi / The control system with the Casambi version of light fixtures is directly and individually regulated wirelessly using the application FLOS Control® by Casambi.

Spot 150

Light Source: LED Array 22,5W - 2000 lm - 2700K/CRI 90 / 22,5W - 2115 lm - 3000K/CRI 90

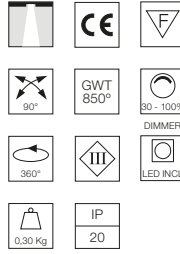
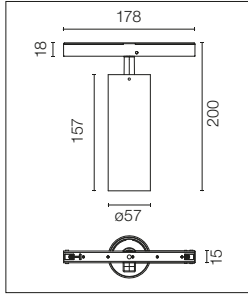

Modulo di illuminazione LED d'accento da installare nel sistema Infra-Structure.
Per il controllo bluetooth dei moduli luminosi selezionare le versioni con Casambi integrato.

Accent lighting LED module to be installed in The Infra-Structure System.
For wireless lighting control, choose integrated Casambi versions.

2700K

On board dimmer

- 03.8072.40
- 03.8072.05
- 03.8072.14
- *Dali Version
- 03.8072.40.DA
- 03.8072.05.DA
- 03.8072.14.DA
- *1-10V
- 03.8072.40.1V
- 03.8072.05.1V
- 03.8072.14.1V
- **Casambi integrated
- 03.8072.40.CB
- 03.8072.05.CB
- 03.8072.14.CB

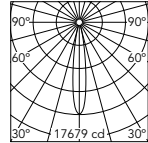

Luminous flux luminaire 1910 lm

h(m)	E(lx)	D(m)
1	17679	0.28
2	4420	0.56
3	1964	0.84
4	1105	1.12
5	707	1.40

3000K

On board dimmer

- 03.8073.40
- 03.8073.05
- 03.8073.14
- *Dali Version
- 03.8073.40.DA
- 03.8073.05.DA
- 03.8073.14.DA
- *1-10V
- 03.8073.40.1V
- 03.8073.05.1V
- 03.8073.14.1V
- **Casambi integrated
- 03.8073.40.CB
- 03.8073.05.CB
- 03.8073.14.CB

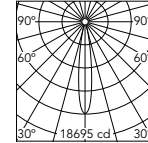

Luminous flux luminaire 2019 lm

h(m)	E(lx)	D(m)
1	18695	0.28
2	4674	0.56
3	2077	0.84
4	1168	1.12
5	748	1.40

2700K

On board dimmer

- 03.8074.40
- 03.8074.05
- 03.8074.14
- *Dali Version
- 03.8074.40.DA
- 03.8074.05.DA
- 03.8074.14.DA
- *1-10V
- 03.8074.40.1V
- 03.8074.05.1V
- 03.8074.14.1V
- **Casambi integrated
- 03.8074.40.CB
- 03.8074.05.CB
- 03.8074.14.CB

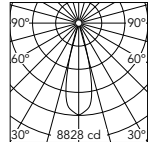

Luminous flux luminaire 1910 lm

h(m)	E(lx)	D(m)
1	8828	0.50
2	2207	1.00
3	981	1.50
4	552	2.00
5	353	2.50

3000K

On board dimmer

- 03.8075.40
- 03.8075.05
- 03.8075.14
- *Dali Version
- 03.8075.40.DA
- 03.8075.05.DA
- 03.8075.14.DA
- *1-10V
- 03.8075.40.1V
- 03.8075.05.1V
- 03.8075.14.1V
- **Casambi integrated
- 03.8075.40.CB
- 03.8075.05.CB
- 03.8075.14.CB

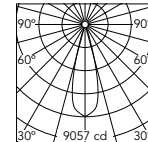

Luminous flux luminaire 1959 lm

h(m)	E(lx)	D(m)
1	9057	0.50
2	2264	1.00
3	1006	1.50
4	566	2.00
5	362	2.50

2700K

On board dimmer

- 03.8076.40
- 03.8076.05
- 03.8076.14
- *Dali Version
- 03.8076.40.DA
- 03.8076.05.DA
- 03.8076.14.DA
- *1-10V
- 03.8076.40.1V
- 03.8076.05.1V
- 03.8076.14.1V
- **Casambi integrated
- 03.8076.40.CB
- 03.8076.05.CB
- 03.8076.14.CB

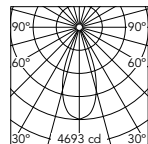

Luminous flux luminaire 1853 lm

h(m)	E(lx)	D(m)
1	4693	0.73
2	1173	1.46
3	521	2.18
4	293	2.91
5	188	3.64

3000K

On board dimmer

- 03.8077.40
- 03.8077.05
- 03.8077.14
- *Dali Version
- 03.8077.40.DA
- 03.8077.05.DA
- 03.8077.14.DA
- *1-10V
- 03.8077.40.1V
- 03.8077.05.1V
- 03.8077.14.1V
- **Casambi integrated
- 03.8077.40.CB
- 03.8077.05.CB
- 03.8077.14.CB

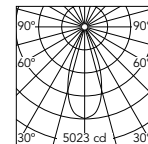

Luminous flux luminaire 1983 lm

h(m)	E(lx)	D(m)
1	5023	0.73
2	1256	1.46
3	558	2.18
4	314	2.91
5	201	3.64

* Compatibile solo con profili in versione DALI-1-10V / Only compatible with DALI, 1-10V profile version .

** Il sistema di controllo degli apparecchi in versione Casambi si regola direttamente tramite bluetooth con l'applicazione dedicata FLOS Control® by Casambi / The control system with the Casambi version of light fixtures is directly and individually regulated wirelessly using the application FLOS Control® by Casambi.

INFRA-STRUCTURE – LIGHT MODULES

Suspension Panel 600

Light Source: Top LED 40W - 3195 lm - 2700K/CRI 90 / 40W - 3381 lm - 3000K/ CRI 90

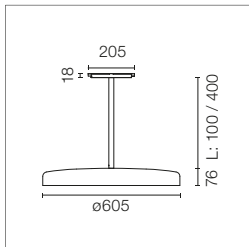

Apparecchio sospeso con asta rigida per installazione nel sistema Infra-Structure.
Per il controllo bluetooth dei moduli luminosi selezionare le versioni con Casambi integrato.

Suspended luminaire with rigid rod, to be installed in the Infra-Structure system.
For wireless lighting control, choose integrated Casambi versions.

E= Finitura Esterna
I= Finitura Interna

E= External Finish
I= Internal Finish

2700K

L: 100 mm

- E I On board dimmer
- 03.8140.40
- E I *Dali Version
- 03.8140.40.DA
- E I *1-10V
- 03.8140.40.1V
- E I **Casambi integrated
- 03.8140.40.CB

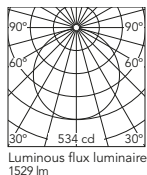

Beam Angle: 113°

h(m)	E(lx)	D(m)
1	534	3.02
2	134	6.04
3	59	9.06
4	33	12.08
5	21	15.10

Luminous flux luminaire 1529 lm

3000K

L: 100 mm

- E I On board dimmer
- 03.8142.40
- E I *Dali Version
- 03.8142.40.DA
- E I *1-10V
- 03.8142.40.1V
- E I **Casambi integrated
- 03.8142.40.CB

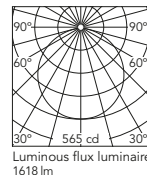

Beam Angle: 113°

h(m)	E(lx)	D(m)
1	565	3.02
2	141	6.04
3	63	9.06
4	35	12.08
5	23	15.10

Luminous flux luminaire 1618 lm

L: 400 mm

- E I On board dimmer
- 03.8141.40
- E I *Dali Version
- 03.8141.40.DA
- E I *1-10V
- 03.8141.40.1V
- E I **Casambi integrated
- 03.8141.40.CB

L: 400 mm

- E I On board dimmer
- 03.8143.40
- E I *Dali Version
- 03.8143.40.DA
- E I *1-10V
- 03.8143.40.1V
- E I **Casambi integrated
- 03.8143.40.CB

2700K

L: 100 mm

- E I On board dimmer
- 03.8140.14
- E I *Dali Version
- 03.8140.14.DA
- E I *1-10V
- 03.8140.14.1V
- E I **Casambi integrated
- 03.8140.14.CB

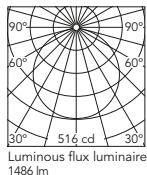

Beam Angle: 114°

h(m)	E(lx)	D(m)
1	516	3.06
2	129	6.11
3	57	9.17
4	32	12.22
5	21	15.28

Luminous flux luminaire 1486 lm

3000K

L: 100 mm

- E I On board dimmer
- 03.8142.14
- E I *Dali Version
- 03.8142.14.DA
- E I *1-10V
- 03.8142.14.1V
- E I **Casambi integrated
- 03.8142.14.CB

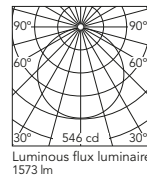

Beam Angle: 114°

h(m)	E(lx)	D(m)
1	546	3.06
2	137	6.11
3	61	9.17
4	34	12.22
5	22	15.28

Luminous flux luminaire 1573 lm

L: 400 mm

- E I On board dimmer
- 03.8141.14
- E I *Dali Version
- 03.8141.14.DA
- E I *1-10V
- 03.8141.14.1V
- E I **Casambi integrated
- 03.8141.14.CB

L: 400 mm

- E I On board dimmer
- 03.8143.14
- E I *Dali Version
- 03.8143.14.DA
- E I *1-10V
- 03.8143.14.1V
- E I **Casambi integrated
- 03.8143.14.CB

* Compatibile solo con profili in versione DALI-1-10V / Only compatible with DALI, 1-10V profile version .

** Il sistema di controllo degli apparecchi in versione Casambi si regola direttamente tramite bluetooth con l'applicazione dedicata FLOS Control® by Casambi / The control system with the Casambi version of light fixtures is directly and individually regulated wirelessly using the application FLOS Control® by Casambi.

Suspension Glass Downlight 110

Light Source: LED Array 13,5W - 1296 lm - 2700K/CRI 90 / 13,5W - 1371 lm - 3000K/CRI 90

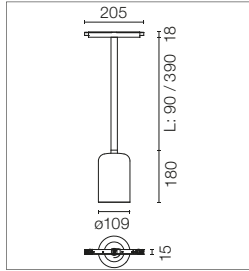

Apparecchio sospeso con asta rigida e vetro soffiato in diverse finiture, per installazione nel sistema Infra-Structure.
Per il controllo bluetooth dei moduli luminosi selezionare le versioni con Casambi integrato.

Suspended luminaire with rigid rod and blown glass in several finishes to be installed in the Infra-Structure system.
For wireless lighting control, choose integrated Casambi versions.

2700K

- Black Rod
- L: 100 mm
- On board dimmer
- 03.8130.00
- 03.8130.FU
- 03.8130.RC
- *Dali Version
- 03.8130.00.DA
- 03.8130.FU.DA
- 03.8130.RC.DA
- *1-10V
- 03.8130.00.1V
- 03.8130.FU.1V
- 03.8130.RC.1V
- **Casambi integrated
- 03.8130.00.CB
- 03.8130.FU.CB
- 03.8130.RC.CB

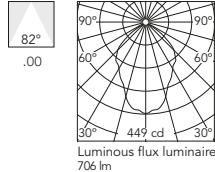

Beam Angle: 82°

h(m)	E(lx)	D(m)
1	449	1.74
2	112	3.48
3	50	5.22
4	28	6.96
5	18	8.71

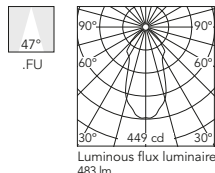

Beam Angle: 47°

h(m)	E(lx)	D(m)
1	449	0.86
2	112	1.72
3	50	2.58
4	28	3.45
5	18	4.31

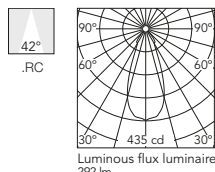

Beam Angle: 42°

h(m)	E(lx)	D(m)
1	435	0.76
2	109	1.52
3	48	2.28
4	27	3.04
5	17	3.80

- Black Rod
- L: 400 mm
- On board dimmer
- 03.8131.00
- 03.8131.FU
- 03.8131.RC
- *Dali Version
- 03.8131.00.DA
- 03.8131.FU.DA
- 03.8131.RC.DA
- *1-10V
- 03.8131.00.1V
- 03.8131.FU.1V
- 03.8131.RC.1V
- **Casambi integrated
- 03.8131.00.CB
- 03.8131.FU.CB
- 03.8131.RC.CB

- White Rod
- L: 100 mm
- On board dimmer
- 03.8135.00
- 03.8135.FU
- 03.8135.RC
- *Dali Version
- 03.8135.00.DA
- 03.8135.FU.DA
- 03.8135.RC.DA
- *1-10V
- 03.8135.00.1V
- 03.8135.FU.1V
- 03.8135.RC.1V
- **Casambi integrated
- 03.8135.00.CB
- 03.8135.FU.CB
- 03.8135.RC.CB

3000K

- Black Rod
- L: 100 mm
- On board dimmer
- 03.8132.00
- 03.8132.FU
- 03.8132.RC
- *Dali Version
- 03.8132.00.DA
- 03.8132.FU.DA
- 03.8132.RC.DA
- *1-10V
- 03.8132.00.1V
- 03.8132.FU.1V
- 03.8132.RC.1V
- **Casambi integrated
- 03.8132.00.CB
- 03.8132.FU.CB
- 03.8132.RC.CB

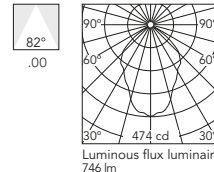

Beam Angle: 82°

h(m)	E(lx)	D(m)
1	474	1.74
2	119	3.48
3	53	5.22
4	30	6.96
5	19	8.71

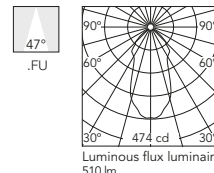

Beam Angle: 47°

h(m)	E(lx)	D(m)
1	474	0.86
2	119	1.72
3	53	2.58
4	30	3.45
5	19	4.31

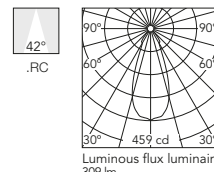

Beam Angle: 42°

h(m)	E(lx)	D(m)
1	459	0.76
2	115	1.52
3	51	2.28
4	29	3.04
5	18	3.80













- Black Rod
- L: 400 mm
- On board dimmer
- 03.8133.00
- 03.8133.FU
- 03.8133.RC
- *Dali Version
- 03.8133.00.DA
- 03.8133.FU.DA
- 03.8133.RC.DA
- *1-10V
- 03.8133.00.1V
- 03.8133.FU.1V
- 03.8133.RC.1V
- **Casambi integrated
- 03.8133.00.CB
- 03.8133.FU.CB
- 03.8133.RC.CB













- White Rod
- L: 100 mm
- On board dimmer
- 03.8137.00
- 03.8137.FU
- 03.8137.RC
- *Dali Version
- 03.8137.00.DA
- 03.8137.FU.DA
- 03.8137.RC.DA
- *1-10V
- 03.8137.00.1V
- 03.8137.FU.1V
- 03.8137.RC.1V
- **Casambi integrated
- 03.8137.00.CB
- 03.8137.FU.CB
- 03.8137.RC.CB

00 Vetro Trasparente / 00 Transparent Glass
 FU Vetro Fumé / FU Smoked Glass
 RC Vetro Rosso / RC Red Glass

* Compatibile solo con profili in versione DALI-1-10V / Only compatible with DALI, 1-10V profile version .

** Il sistema di controllo degli apparecchi i versione Casambi si regola direttamente tramite bluetooth con l'applicazione dedicata FLOS Control® by Casambi / The control system with the Casambi version of light fixtures is directly and individually regulated wirelessly using the application FLOS Control® by Casambi.

- White Rod
L: 400 mm
On board dimmer
-  03.8136.00
 -  03.8136.FU
 -  03.8136.RC
- *Dali Version
-  03.8136.00.DA
 -  03.8136.FU.DA
 -  03.8136.RC.DA
- *1-10V
-  03.8136.00.1V
 -  03.8136.FU.1V
 -  03.8136.RC.1V
- **Casambi integrated
-  03.8136.00.CB
 -  03.8136.FU.CB
 -  03.8136.RC.CB







- White Rod
L: 400 mm
On board dimmer
-  03.8138.00
 -  03.8138.FU
 -  03.8138.RC
- *Dali Version
-  03.8138.00.DA
 -  03.8138.FU.DA
 -  03.8138.RC.DA
- *1-10V
-  03.8138.00.1V
 -  03.8138.FU.1V
 -  03.8138.RC.1V
- **Casambi integrated
-  03.8138.00.CB
 -  03.8138.FU.CB
 -  03.8138.RC.CB

Accessori / Accessories







Spot 150

Crocetta di schermatura, lenti e honeycomb direttamente installabili sulla testa dell'apparecchio di illuminazione senza necessità di accessori di fissaggio. Compatibilità di installazione di honeycomb + lente contemporaneamente.

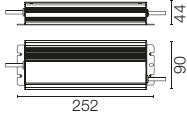
Screening crosspiece, lenses and honeycomb directly installable on the head of the luminaire without needing any fastening accessory. Installation compatible with honeycomb + lense at the same time.

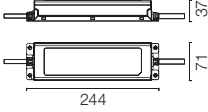
Filtro a croce antiabbagliamento.	Screening crosspiece.		08.8429.00
Lente ellittica.	Elliptical lens.		08.8431.00
Lente flood.	Flood lens.		08.8432.00
Honeycomb.	Honeycomb.		08.8428.00
Cono di schermatura.	Snoot shielding cone.		 08.0526.00 08.0526.40 08.0526.BW

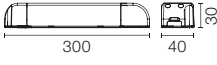
Driver / Drivers

Alimentatore LED per installazione remota, 48V/320W. 100/240 Vac.	LED power supply source for remote installation, 48V/320W. 100/240 Vac.			***RF27321
Alimentatore LED per installazione remota, 110Vac-135W / 220Vac-200W.	LED power supply source for remote installation, 110Vac-135W / 220Vac-200W.			***60.9607
Alimentatore LED per installazione remota, 48V/120W. 220/240 Vac.	LED power supply source for remote installation, 48V/120W. 220/240 Vac.			***60.9170
Scatola di controllo dimmabile 1-10V, 48V. Per installazione remota. Necessaria per trasformare sistemi di controllo 1-10V passivi in attivi.	Dimmable control box 1-10V, 48V. For remote installation. Necessary to transform passive 1-10V control systems into active ones.			 08.0613.14A

*** Per il dimensionamento dell'impianto, mantenere un margine di sicurezza di circa il 15% della potenza massima dell'alimentatore LED / For the sizing of the installation keep a safety margin of 15% of the maximum power of the LED power source.

INFRA-STRUCTURE Episode 2

DESIGNED BY VINCENT VAN DUYSSEN

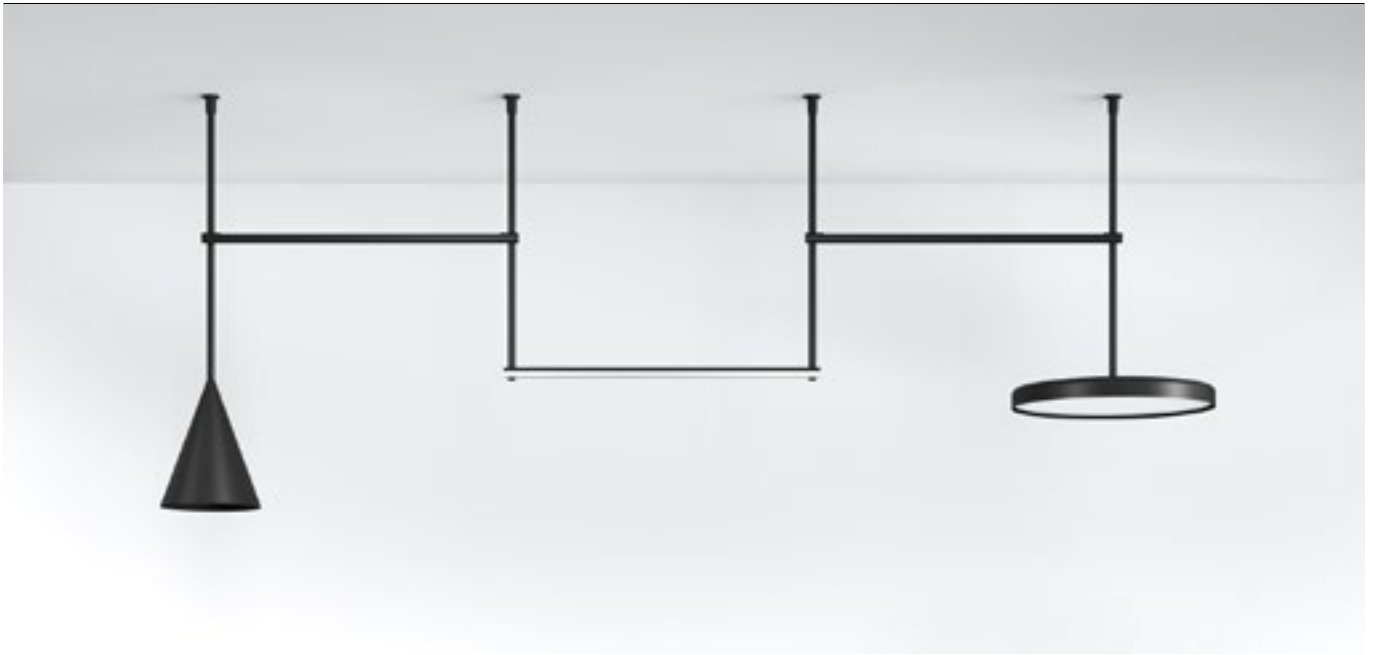

Profiles 40 Bianco
40 White 14 Nero
14 Black

LIGHT MODULES

LIGHT TUBE
DIRECT-INDIRECT

LIGHT SOURCE

TOP LED
24W/m
1978 lm/m
2700K/CRI 90
2227 lm/m
3000K/CRI 90

SUSPENSION
CONE 300

LIGHT SOURCE

TOP LED
30W
2800 lm
2700K/CRI 90
3000 lm
3000K/CRI 90

SUSPENSION
CONE 400

LIGHT SOURCE

TOP LED
41W
3750 lm
2700K/CRI 90
4000 lm
3000K/CRI 90

SUSPENSION
PANEL 600

LIGHT SOURCE

TOP LED
35,5W
3195 lm
2700K/CRI 90
3381 lm
3000K/CRI 90

LIGHT TUBE
COVERED

LIGHT SOURCE

TOP LED
24W/m
1978 lm/m
2700K/CRI 90
2227 lm/m
3000K/CRI 90

Descrizione

La reinterpretazione di un'icona: il design unico di Infra-Structure si evolve grazie ad un nuovo concetto modulare estremamente semplificato. Elementi essenziali ma di grande impatto visivo possono essere combinati per caratterizzare qualsiasi spazio architettonico con una forte presenza scenica. Essenziale struttura tubolare incredibilmente versatile. Grazie ad uno speciale sistema di connessione è possibile combinare elementi verticali e orizzontali tra di loro per creare combinazioni tridimensionali in infinite varianti utilizzando moduli lineari e geometrici. La connessione meccanica tra i singoli moduli che compongono la struttura avviene tramite un sistema a vite che garantisce un'installazione rapida e sicura. Ogni modulo è bloccato in sede con l'integrazione di due piccole grani, pressochè invisibile una volta completata l'installazione. Le connessioni elettriche dei moduli illuminanti sono estremamente semplici da effettuare. Ogni elemento luminoso è completo con un cavo elettrico lungo 4 m equipaggiato con micro-connettore in uscita. Il cavo viene fatto scorrere attraverso le varie sezioni della struttura verticale per essere poi collegato alla rete in corrispondenza del soffitto. Le parti strutturali si fabbricano con elementi tubolari in alluminio estrusi e verniciati in bianco o nero, alimentati a 48V. Controllabili come sistema (DALI, 1-10V, FLOS Control®) tramite driver remoti con controllo broadcast o indipendente tramite un driver per ogni elemento luminoso. La famiglia è composta da moduli di illuminazione generale con varie ottiche e moduli di luce ambiente diretta e indiretta.

Configurazione

L'estrema semplicità degli elementi e la rapidità con cui possono essere combinati permette di liberare la creatività del progetto ottenendo innumerevoli combinazioni. Come in un reticolo tridimensionale, basterà definire quali sono gli assi verticali della struttura per poi unirli visivamente (ed elettricamente) a dei moduli luminosi che possono ruotare liberamente di 360° garantendo un'incredibile flessibilità d'installazione.

Controllo

- Gli apparecchi sono compatibili con sistemi DALI, 1-10V e Casambi.
- Per la gestione tramite 1-10V è necessario che il sistema di controllo sia attivo e il bus di dati sia collegato direttamente al controller. Per un controllo individuale è necessario un driver dimmerabile per ogni modulo luminoso o gruppo di moduli.
- Per la gestione attraverso il sistema Casambi è necessario ordinare un'interfaccia Casambi da collegare ad un driver DALI o 1/10V. Necessaria applicazione FLOS Control® powered by Casambi per dispositivi mobili (disponibile su Apple Store e Google Play).

Sistema Ottico

- Light Tube Direct / Light Tube Indirect / Light Tube Covered / Suspension Panel 600: illuminazione generale diretta.
- Light Tube Indirect: illuminazione generale indiretta.
- Suspension Cone 300 / Suspension Cone 400: illuminazione generale diretta Flood.

Unità di Alimentazione

Alimentatore remoto a 48V non compreso.

Informazioni Aggiuntive

Grado di protezione IP20.
Adatti ad installazioni su superfici normalmente infiammabili.

Conformità e Marchi di Qualità

Apparecchio conforme alla Normativa Tecnica Europea EN60598-1 e relative parti seconde.

Description

The reinterpretation of an icon: the unique design of Infra-Structure evolves thanks to a new, extremely simplified modular concept. The subtle but visually stunning elements can be combined to characterize any architectural space with a strong stage presence. Subtle, incredibly versatile tubular structure. Thanks to a special connection system, it is possible to combine vertical and horizontal elements to create three-dimensional combinations in infinite variations using linear and geometric modules. The mechanical connection between the individual modules that make up the structure is made through a screw system that guarantees a fast and safe installation. Each module is locked in place by integrating two small, almost invisible grub screws once the installation is complete. The electrical connections of the lighting modules are extremely simple to make. Each lighting element is completed by a long 4 m electrical cable equipped with an output micro connector. The cable runs through all the different sections of the vertical structure and is then connected to the grid in the ceiling. All structural components are made of extruded aluminium tubular profiles painted black or white with 48V feeding. The system can be controlled as a group (DALI, 1-10V, FLOS Control®) through remote power supply units with broadcast control or individual control by means of one single driver for each lighting module. The family is made of lighting modules for general lighting featuring different optics and linear lighting modules providing diffused direct or indirect emission.

Configuration

The extreme simplicity of the elements and the speed with which they can be combined allows to free up the creativity of the project and to achieve innumerable combinations. As in a three-dimensional network, simply define the vertical axes of the structure and then connect them visually (and electrically) with lighting modules that can freely rotate 360°. An incredible installation flexibility is guaranteed.

Control

- Lighting modules are compatible with DALI, 1-10V and Casambi.
- For 1-10V management, the control system must be active, and the data bus must be connected directly to the controller. In case of individual control one dimmable driver for each lighting unit or group is required.
- To manage the Casambi system a Casambi interface module must be ordered and connected to a DALI or 1-10V driver. To manage the system it is necessary to download the FLOS Control® powered by Casambi app (available on Apple Store and Google Play).

Optic system

- Light Tube Direct / Light Tube Indirect / Light Tube Covered / Suspension Panel 600: diffused lighting direct.
- Light Tube Indirect: diffused lighting indirect.
- Suspension Cone 300 / Suspension Cone 400: direct Flood lighting.

Power Supply

Remote 48V power supply not included.

Additional Information

IP20 protection grade.
Suitable for installation on normally inflammable surfaces.

Compliance of Standards and Quality Marks

EN60598-1 European Technical Standards and any subsequent additions.

FLOS
CONTROL BY CASAMBI



SURFACE INSTALLATION

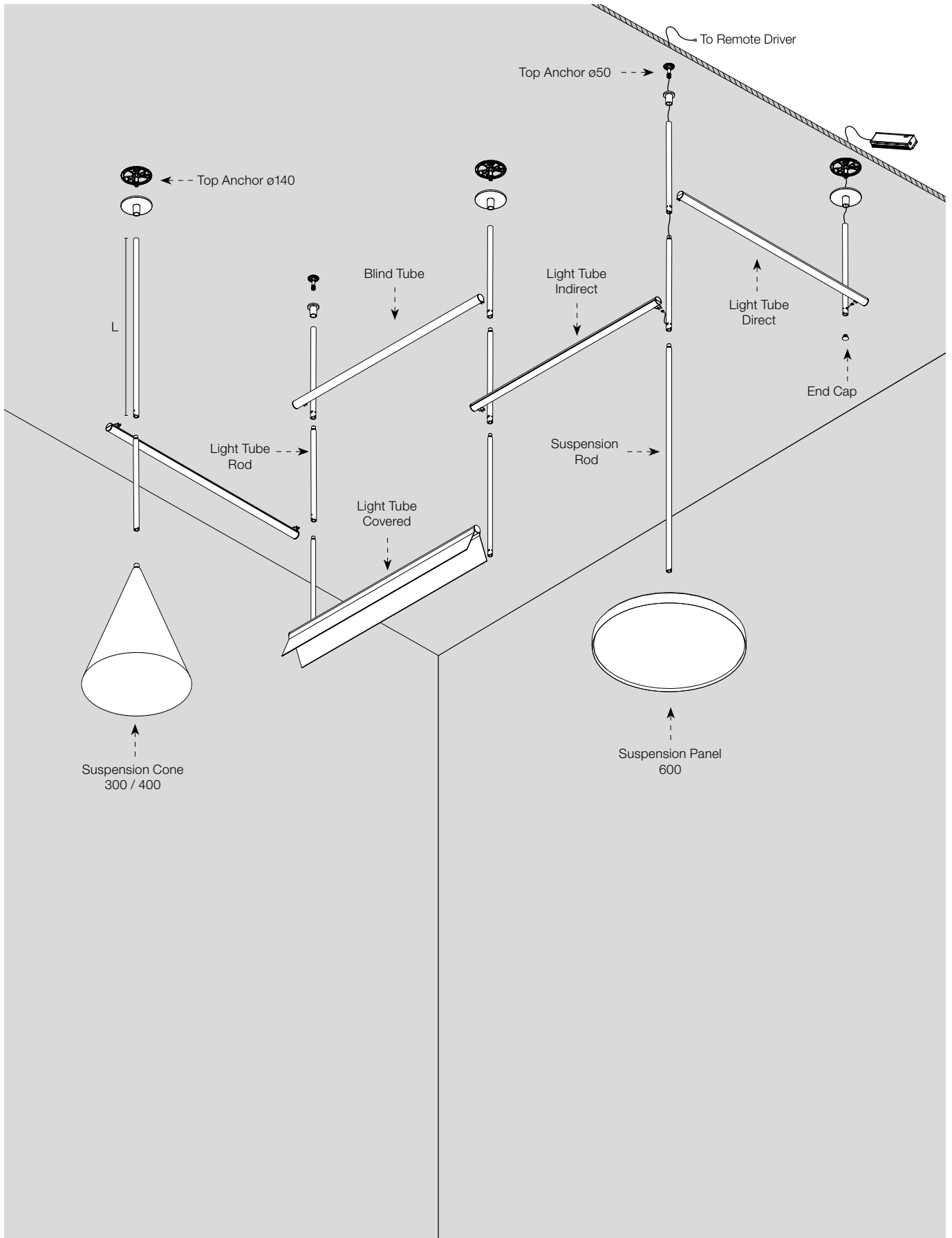

Ancoraggio superiore ø140.
Per installazioni in cui l'unità di alimentazione debba essere nascosta nel controsoffitto e non esista un accesso alternativo. L'elemento decorativo di 140mm nasconde il foro necessario per il passaggio del driver.

Top Anchor ø140.
For installation where the power supply is to be hidden within a drop ceiling and there is no other access. The 140-mm cover conceals the hole needed to install the device.

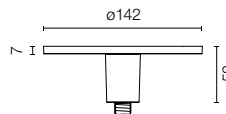

06.5421.40
06.5421.14

Ancoraggio superiore ø50.
Per installazioni in cui l'unità di alimentazione debba essere installata remota o esista un accesso dedicato per la manutenzione dello stesso. L'elemento decorativo di 50mm nasconde il passaggio del cavo ma non permette l'accesso diretto al driver.

Top Anchor ø50.
For installations where the power supply equipment must be installed remotely in an installation box or there is access to it from another point. The 50-mm cover conceals the cable and prevents access to the power supply.

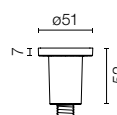

06.5420.40
06.5420.14

Terminale di chiusura.

End cap.



06.5430.40
06.5430.14

Asta.
Elemento tubolare verticale disponibile in diverse lunghezze per la connessione dei moduli di luce lineari. È possibile collegare più elementi insieme tramite un meccanismo di bloccaggio a vite con grano di sicurezza integrato. È possibile passare cavi di alimentazione fino a tre apparecchi per ogni elemento verticale.

Rod.
Rod available in different lengths for connection of direct and indirect linear light tubes. Various elements may be connected simultaneously by means of attachment elements along with a mechanically integrated safety device. Power cables for three luminaires may be fed through each vertical rod.

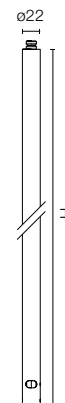

H: 100 mm
06.5400.40
06.5400.14
H: 200 mm
06.5401.40
06.5401.14
H: 400 mm
06.5402.40
06.5402.14
H: 600 mm
06.5403.40
06.5403.14
H: 800 mm
06.5404.40
06.5404.14
H: 1000 mm
06.5405.40
06.5405.14

Asta di sospensione.
Elemento tubolare verticale disponibile in diverse lunghezze per la connessione dei moduli luminosi a sospensione e per estensioni senza connessione ad elementi luminosi. È possibile passare cavi di alimentazione fino a tre apparecchi per ogni elemento verticale.

Suspension Rod.
Rod available in different lengths for connection of "Suspension Panel" and "Suspension Cone" modules and for extensions without connection to a light fixture. Power cables for three luminaires may be fed through each vertical rod.

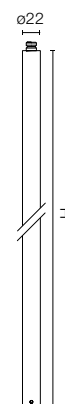

H: 100 mm
06.5410.40
06.5410.14
H: 200 mm
06.5411.40
06.5411.14
H: 400 mm
06.5412.40
06.5412.14
H: 600 mm
06.5413.40
06.5413.14
H: 800 mm
06.5414.40
06.5414.14
H: 1000 mm
06.5415.40
06.5415.14

Tubo cieco.

Blind tube.

Modulo meccanico (senza illuminazione) per l'installazione nel sistema Infra-Structure Episode 2.

A mechanical module (without lighting) to be installed in the system infrastructure Episode 2.

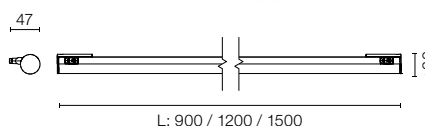

L: 900 mm
03.8430.40
03.8430.14
L: 1200 mm
03.8431.40
03.8431.14
L: 1500 mm
03.8432.40
03.8432.14

• **Infra-Structure Episode 2 è un sistema a binario come Infra-Structure?**

No, Infra-Structure Episode 2 è un sistema modulare ma non ha binari.

• **Come si collegano gli elementi verticali tra di loro?**

La connessione meccanica tra i singoli moduli che compongono la struttura avviene tramite un sistema a vite che garantisce un'installazione rapida e sicura. Ogni modulo è bloccato in sede con l'integrazione di piccoli grani, pressoché invisibile una volta completata l'installazione.

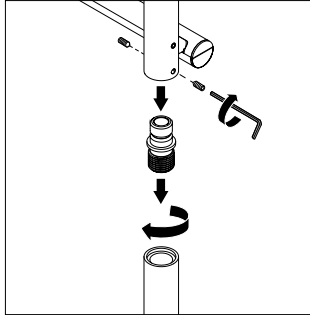

• **Is Infra-Structure Episode 2 a system on tracks like Infra-Structure?**

No. Infra-Structure Episode 2 is a modular system, but it doesn't have tracks.

• **How are the vertical rods connected together?**

The individual modules composing the vertical structure are connected using a system of screws that guarantee quick, safe installation. Each module is fixed in place with the help of small set screws that is practically invisible once installation is complete.

• **È possibile realizzare composizioni non lineari?**

Sì, è possibile. La flessibilità è massima grazie alla connessione meccanica tra gli elementi verticali che può essere regolata secondo l'angolo di rotazione necessario.

• **Is it possible to obtain non-linear compositions?**

Yes. Maximum flexibility is provided for with the mechanical connection between the vertical rods, which can be adjusted to the desired angle.

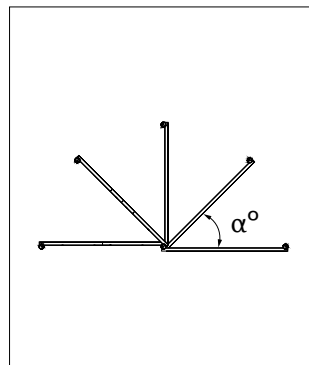
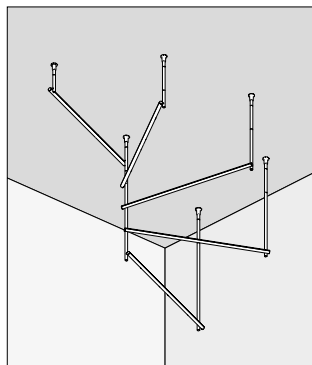

• **Quanti apparecchi posso alimentare attraverso lo stesso elemento verticale?**

È possibile passare cavi di alimentazione fino a tre apparecchi per ogni elemento verticale.

• **How many luminaires can I power using the same vertical rod?**

Power cables for three luminaires may be fed through each vertical rod.

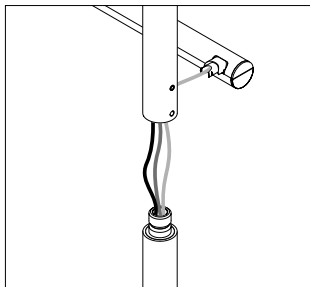

• **È possibile regolare l'intensità della luce nei moduli luminosi?**

Sì, usando il modulo di controllo che proponiamo nella sezione alimentatori tramite DALI, 1-10V e Casambi.

• **Can the light from the luminaires be dimmed?**

Yes. With the control module listed in the equipment section, the amount of light can be regulated via DALI, 1-10V and Casambi.

• **Qual è la lunghezza massima di sospensione?**

I cavi predisposti per ogni modulo luminoso hanno una lunghezza massima di 4 metri.

• **What is the maximum suspension length?**

The cables supplied with the lamp have a maximum length of 4 metres.

• **È possibile installare la struttura con driver remoto nascosto in un controsoffitto?**

Il sistema può essere installato esclusivamente con driver remoto. A questo proposito sono disponibili elementi di ancoraggio a soffitto (rosoni) di 140mm per consentire il passaggio del driver attraverso il soffitto.

• **Can it be installed with the power supply hidden in the drop ceiling?**

The system can only be installed with a hidden power supply. It is equipped with a 140-mm rose for the power to pass through and to hide the hole.

Light Tube Direct

Light Source: Top LED 24W/m - 1978 lm/m - 2700K/CRI 90 / 24W/m - 2227 lm/m - 3000K/CRI 90

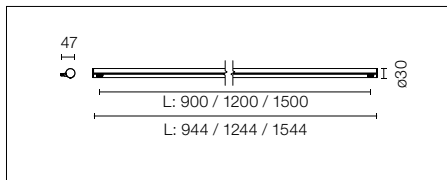

Modulo di illuminazione a LED diffusa predisposto per installazione nel sistema Infra-Structure Episode 2. Elementi di fissaggio e blocco di sicurezza meccanico integrati per installazione trasversale tra due supporti verticali. I Light Tubes si possono alimentare solo da un estremo e non trasmettono corrente all'estremo opposto. Ogni elemento luminoso è completo con un cavo elettrico di 4m di lunghezza equipaggiato con un microconnettore in uscita.

Diffused LED light module to be installed in the Infra-Structure Episode 2. Safety fixing and locking mechanical elements integrated for a transversal installation between two rods of the profile. The Light Tubes are only fed by one of the ends and do not communicate current through the other end. Each lighting element is completed by a long 4m electrical cable equipped with an output microconnector.

2700K

L: 900 mm - 22W - 1820 lm

03.8400.40
03.8400.14

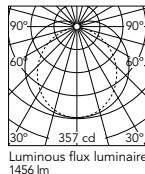

Beam Angle: 150°

3000K

L: 900 mm - 22W - 2048 lm

03.8403.40
03.8403.14

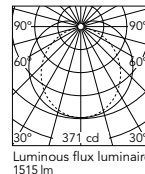

Beam Angle: 150°

2700K

L: 1200 mm - 29W - 2366 lm

03.8401.40
03.8401.14

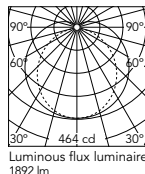

Beam Angle: 150°

3000K

L: 1200 mm - 29W - 2663 lm

03.8404.40
03.8404.14

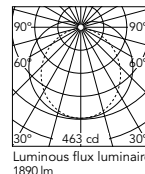

Beam Angle: 150°

2700K

L: 1500 mm - 35,5W - 2912 lm

03.8402.40
03.8402.14

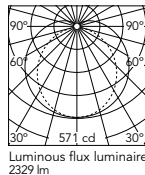

Beam Angle: 150°

3000K

L: 1500 mm - 35,5W - 3278 lm

03.8405.40
03.8405.14

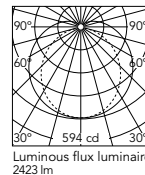

Beam Angle: 150°

Light Tube Indirect

Light Source: Top LED 24W/m - 1978 lm/m - 2700K/CRI 90 / 24W/m - 2227 lm/m - 3000K/CRI 90

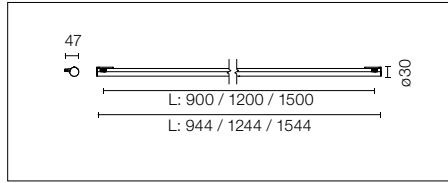

Modulo di illuminazione a LED diffusa indiretta predisposto per installazione nel sistema Infra-Structure Episode 2. Elementi di fissaggio e blocco di sicurezza meccanico integrati per installazione trasversale tra due supporti verticali. I Light Tubes si possono alimentare solo da un estremo e non trasmettono corrente all'estremo opposto. Ogni elemento luminoso è completo con un cavo elettrico di 4m di lunghezza equipaggiato con un microconnettore in uscita.

Diffused indirect LED light module to be installed in the Infra-Structure Episode 2. Safety fixing and locking mechanical elements integrated for a transversal installation between two rods of the profile. The Light Tubes are only fed by one of the ends and do not communicate current through the other end. Each lighting element is completed by a long 4m electrical cable equipped with an output microconnector.

2700K
L: 900 mm - 20W - 1820 lm
03.8410.40
03.8410.14

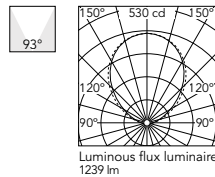

Beam Angle: 93°

h(m)	E(lx)	D(m)
1	530	2.12
2	133	4.25
3	59	6.37
4	33	8.50
5	21	10.62

3000K
L: 900 mm - 20W - 2048 lm
03.8413.40
03.8413.14

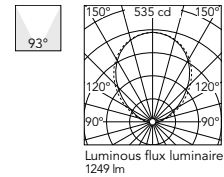

Beam Angle: 93°

h(m)	E(lx)	D(m)
1	535	2.12
2	134	4.25
3	59	6.37
4	33	8.50
5	21	10.62

2700K
L: 1200 mm - 25,5W - 2366 lm
03.8411.40
03.8411.14

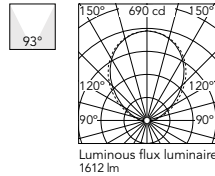

Beam Angle: 93°

h(m)	E(lx)	D(m)
1	690	2.12
2	173	4.25
3	77	6.37
4	43	8.50
5	28	10.62

3000K
L: 1200 mm - 25,5W - 2663 lm
03.8414.40
03.8414.14

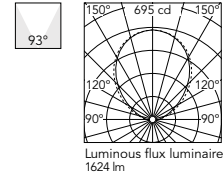

Beam Angle: 93°

h(m)	E(lx)	D(m)
1	695	2.12
2	174	4.25
3	77	6.37
4	43	8.50
5	28	10.62

2700K
L: 1500 mm - 32,5W - 2912 lm
03.8412.40
03.8412.14

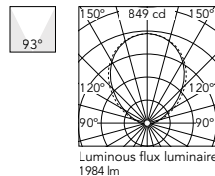

Beam Angle: 93°

h(m)	E(lx)	D(m)
1	849	2.12
2	212	4.25
3	94	6.37
4	53	8.50
5	34	10.62

3000K
L: 1500 mm - 32,5W - 3278 lm
03.8415.40
03.8415.14

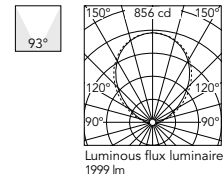

Beam Angle: 93°

h(m)	E(lx)	D(m)
1	856	2.12
2	214	4.25
3	95	6.37
4	53	8.50
5	34	10.62

Suspension Cone 300

Light Source: Top LED 30W - 2800 lm - 2700K/CRI 90 / 30W - 3000 lm - 3000K/CRI 90

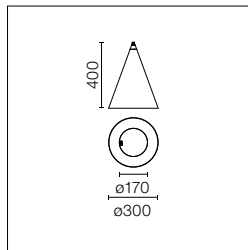

Apparecchio a sospensione con blocco integrato per installazione nel sistema Infra-Structure Episode 2. Ogni elemento luminoso è completo con un cavo elettrico di 4m di lunghezza equipaggiato con un microconnettore in uscita.

Suspended luminaire with locking system integrated, to be installed in the Infra-Structure Episode 2 system. Each lighting element is completed by a long 4m electrical cable equipped with an output microconnector.

2700K
03.8440.40
03.8440.14

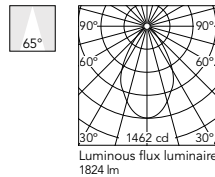

Beam Angle: 65°

h(m)	E(lx)	D(m)
1	1462	1.27
2	365	2.53
3	162	3.80
4	91	5.06
5	58	6.33

@White (40)

3000K
03.8442.40
03.8442.14

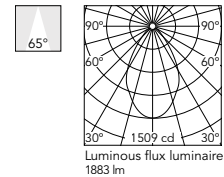

Beam Angle: 65°

h(m)	E(lx)	D(m)
1	1509	1.27
2	377	2.53
3	168	3.80
4	94	5.06
5	60	6.33

@White (40)

Suspension Cone 400

Light Source: Top LED 41W - 3750 lm - 2700K/CRI 90 / 41W - 4000 lm - 3000K/CRI 90

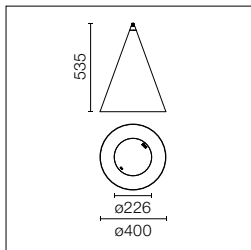

Apparecchio a sospensione con blocco integrato per installazione nel sistema Infra-Structure Episode 2. Ogni elemento luminoso è completo con un cavo elettrico di 4m di lunghezza equipaggiato con un microconnettore in uscita.

Suspended luminaire with locking system integrated, to be installed in the Infra-Structure Episode 2 system. Each lighting element is completed by a long 4m electrical cable equipped with an output microconnector.

2700K
 03.8441.40
 03.8441.14

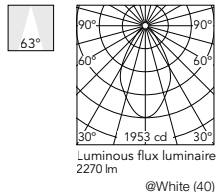

Beam Angle: 63°

h(m)	E(lx)	D(m)
1	1953	1.22
2	488	2.43
3	217	3.65
4	122	4.86
5	78	6.08

3000K
 03.8443.40
 03.8443.14

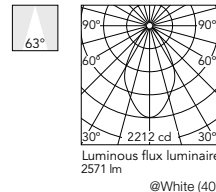

Beam Angle: 63°

h(m)	E(lx)	D(m)
1	2212	1.22
2	553	2.43
3	246	3.65
4	138	4.86
5	88	6.08

Suspension Panel 600

Light Source: Power LED 35,5W - 3195 lm - 2700K/CRI 90 / 35,5W - 3381 lm - 3000K/CRI 90

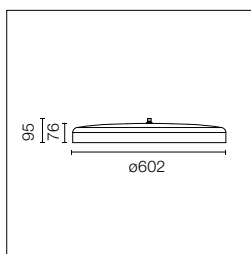

Apparecchio a sospensione con blocco integrato per installazione nel sistema Infra-Structure Episode 2. Ogni elemento luminoso è completo con un cavo elettrico di 4m di lunghezza equipaggiato con un microconnettore in uscita.

Suspended luminaire with locking system integrated, to be installed in the Infra-Structure Episode 2 system. Each lighting element is completed by a long 4m electrical cable equipped with an output microconnector.

2700K
 03.8450.40
 03.8450.14

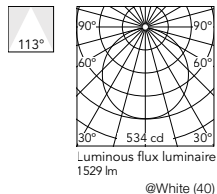

Beam Angle: 113°

h(m)	E(lx)	D(m)
1	534	3.02
2	134	6.04
3	59	9.06
4	33	12.08
5	21	15.10

3000K
 03.8451.40
 03.8451.14

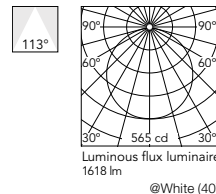

Beam Angle: 113°

h(m)	E(lx)	D(m)
1	565	3.02
2	141	6.04
3	63	9.06
4	35	12.08
5	23	15.10

Light Tube Covered

Light Source: Top LED 24W/m - 1978 lm/m - 2700K/CRI 90 / 24W/m - 2227 lm/m - 3000K/CRI 90

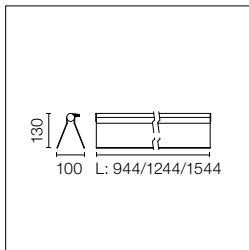

1.90 Kg

850°
 IP 20

Modulo di illuminazione a LED diffusa diretta con schermo integrato, predisposto per installazione nel sistema Infra-Structure Episode 2. Elementi di fissaggio e blocco di sicurezza meccanico integrati per installazione trasversale tra due supporti verticali. I Light Tubes si possono alimentare solo da un estremo e non trasmettono corrente all'estremo opposto. Ogni elemento luminoso è completo con un cavo elettrico di 4m di lunghezza equipaggiato con un microconnettore in uscita.

Diffused direct shielded LED light module to be installed in the Infra-Structure Episode 2. Safety fixing and locking mechanical elements integrated for a transversal installation between two rods of the profile. The Light Tubes are only fed by one of the ends and do not communicate current through the other end. Each lighting element is completed by a long 4m electrical cable equipped with an output microconnector.

2700K

L: 900 mm - 22W - 1820 lm

03.8420.40
03.8420.14

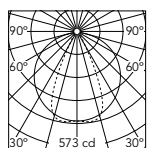

Beam Angle: 50°

h(m)	E(lx)	D(m)
1	573	0.94
2	143	1.87
3	64	2.81
4	36	3.74
5	23	4.68

Luminous flux luminaire 860 lm

3000K

L: 900 mm - 22W - 2048 lm

03.8423.40
03.8423.14

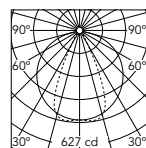

Beam Angle: 50°

h(m)	E(lx)	D(m)
1	627	0.94
2	157	1.87
3	70	2.81
4	39	3.74
5	25	4.68

Luminous flux luminaire 942 lm

2700K

L: 1200 mm - 29W - 2366 lm

03.8421.40
03.8421.14

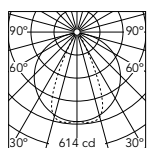

Beam Angle: 50°

h(m)	E(lx)	D(m)
1	614	0.94
2	153	1.87
3	68	2.81
4	38	3.74
5	25	4.68

Luminous flux luminaire 921 lm

3000K

L: 1200 mm - 29W - 2663 lm

03.8424.40
03.8424.14

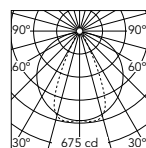

Beam Angle: 50°

h(m)	E(lx)	D(m)
1	675	0.94
2	169	1.87
3	75	2.81
4	42	3.74
5	27	4.68

Luminous flux luminaire 1012 lm

2700K

L: 1500 mm - 35,5W - 2912 lm

03.8422.40
03.8422.14

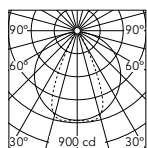

Beam Angle: 50°

h(m)	E(lx)	D(m)
1	900	0.94
2	225	1.87
3	100	2.81
4	56	3.74
5	36	4.68

Luminous flux luminaire 1351 lm

@White (40)

3000K

L: 1500 mm - 35,5W - 3278 lm

03.8425.40
03.8425.14

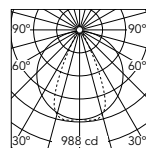

Beam Angle: 50°

h(m)	E(lx)	D(m)
1	988	0.94
2	247	1.87
3	110	2.81
4	62	3.74
5	40	4.68

Luminous flux luminaire 1483 lm

@White (40)

Driver / Drivers

Alimentatore LED per installazione remota, 48V/320W. 100/240 Vac.

LED power supply source for remote installation, 48V/320W. 100/240 Vac.

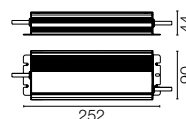

*RF27321

Alimentatore LED per installazione remota, 110Vac-135W / 220Vac-200W.

LED power supply source for remote installation, 110Vac-135W / 220Vac-200W.

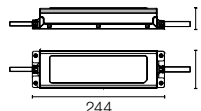

*60.9607

Alimentatore LED per installazione remota, 48V/120W. 220/240 Vac.

LED power supply source for remote installation, 48V/120W. 220/240 Vac.

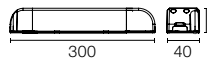

*60.9170

Casambi Broadcast

Driver Casambi 220-240V. Necessario driver e controller da ordinare separatamente. Intervallo di dimmerazione 0-100%.

Casambi controller 220-240V. Driver and external interface required have to be ordered separately. Dimming range 0-100%.

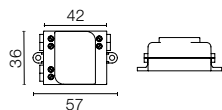

60.9392

Uplight dimmer DALI Push 48V PWM per controllo di illuminazione indiretta (UP).

DALI Push 48V PWM Uplight dimmer for controlling indirect lighting (UP).



60.9678

Uplight dimmer 1-10V Push 48V PWM per controllo di illuminazione indiretta (UP).

1-10V Push 48V PWM Uplight dimmer for controlling indirect lighting (UP).



60.9395

Regulation Systems

0/1-10V / DALI Installation

0/1-10V / DALI CONTROL SIGNAL

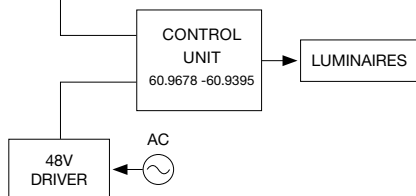

CASAMBI Installation

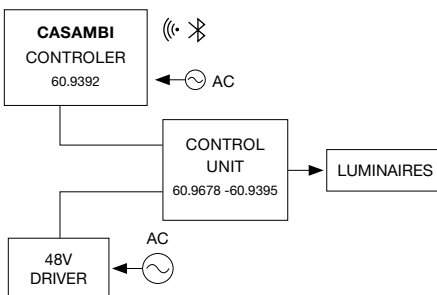

PUSH Installation

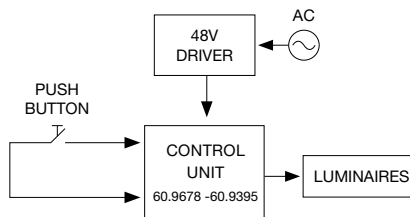

* Per il dimensionamento dell'impianto, mantenere un margine di sicurezza di circa il 15% della potenza massima dell'alimentatore LED / For the sizing of the installation keep a safety margin of 15% of the maximum power of the LED power source.

** Ha bisogno di una scatola di montaggio. Interfaccia DALI compatibile (IEC 62386-101/102) per il controllo dell'illuminazione indiretta. Attenzione: trattandosi di un componente DALI compatibile, potrebbe non rispondere a funzioni avanzate del protocollo DALI. Per ulteriori informazioni si prega di consultare le caratteristiche tecniche nella pagina web Flos / It needs an installation box. Compatible DALI interface (IEC 62386-101/102) for controlling indirect lighting. Please note that since it is a DALI compatible component, it may not respond to advanced DALI protocol functions. For more information, see the technical specifications section on the Flos website.

DIVERSION

DESIGNED BY PIERO LISSONI



Surface/Suspension Profiles 40 Bianco 40 White 1A Anodic Ice 1A Anodic Ice 14 Nero 14 Black CZ Bronzo CZ Bronze

LIGHT MODULES STRUCTURES

DOWN	UP&DOWN	DOWN + SPOTS	UP&DOWN + SPOTS
LIGHT SOURCE TOP LED 13,5W/m 1540 lm/m 2700K/CRI 90 3000K/CRI 90	LIGHT SOURCE TOP LED 20,5W/m 2284 lm/m 2700K/CRI 90 3000K/CRI 90	LIGHT SOURCE TOP LED 11W/m 1255 lm/m 2700K/CRI 90 3000K/CRI 90	LIGHT SOURCE TOP LED 18W/m 1999 lm/m 2700K/CRI 90 3000K/CRI 90

LIGHT MODULES

ATOM 90	ATOM 120
LIGHT SOURCE POWER LED 5,5W 450 lm 2700K/CRI 90 485 lm 3000K/CRI 90	LIGHT SOURCE POWER LED 8W 635 lm 2700K/CRI 90 680 lm 3000K/CRI 90

Descrizione

Questo innovativo sistema di profili per installazione a superficie e sospensione è caratterizzato da una flessibilità eccezionale. I profili sono dotati di illuminazione integrata diretta e indiretta ed è possibile completare ogni profilo con due faretti per creare combinazioni di illuminazione d'accento. I faretti disponibili per questo sistema fanno parte della linea Atom disegnata anch'essa da Piero Lissoni.

L'elemento chiave è il giunto di alimentazione e unione tra profili, che permette di realizzare connessioni a 360° ogni 45°, permettendo il collegamento di 8 profili sullo stesso giunto. In questo modo il sistema offre infinite possibilità, dato che è possibile realizzare quasi qualsiasi composizione concepibile, garantendone l'adattabilità a diversi spazi architettonici.

Profili in alluminio estruso con lunghezze comprese tra 1 e 2,5m con finiture in bianco, nero, anodic ice e bronzo.

Sistema Ottico

- Profilo lineare down - emissione diretta: General Lighting.
- Profilo lineare up&down - emissione diretta/indiretta: General Lighting.
- Profilo lineare down + 2 faretti - emissione diretta e d'accento: General Lighting, Spot, Medium.
- Profilo lineare up&down + 2 faretti - emissione diretta/indiretta e d'accento: General Lighting, Spot, Medium.

Unità di Alimentazione

Il sistema può essere alimentato solo con fonte di alimentazione remota non compresa con i profili. I driver consigliati possono essere alimentati tra 90 e 305Vac e vanno ordinati separatamente.

Sistema di Regolazione

Sistema regolabile con driver 1-10V, DALI o Casambi. Sistema di controllo broadcast. La regolazione per la versione up&down viene realizzata simultaneamente e non è possibile rendere indipendenti l'emissione superiore e quella inferiore. Per regolazione individuale via Casambi utilizzare gli spot versione Casambi, con alimentazione non dimmerabile.

Informazioni Aggiuntive

Sistema elettrico alimentato a 24V e limitato ad una corrente massima di 5A e 120W. Grado di protezione IP20. Adatti ad installazioni su superfici normalmente infiammabili.

Conformità e Marchi di Qualità

Apparecchio conforme alla Normativa Tecnica Europea EN60598-1 e relative parti seconde.

Description

This innovative profile system for surface and suspended installation is characterized by its high flexibility. Profiles are equipped with integrated lighting available in direct and indirect emission with the possibility of adding two spots in order to combine accent and detail lighting. The spotlights available for this system are part of the Atom family designed by Piero Lissoni.

The key part of the system is the joint for powering and joining profiles together, which allows to create configurations in 360°, every 45°, as well as to easily connect up to 8 profiles to the same joint piece. Herewith, the system offers an endless number of combinations. It can be composed to create any imaginable structure and can be adapted to different architectural spaces. System of extruded aluminum profiles from 1m up to 2.5m in white, black, anodic ice and bronze finish.

Optic system

- Down linear profile - direct light output: General lighting.
- Up&down linear profile - direct/indirect light output: General lighting.
- Down linear profile + 2 spots - direct light output and accent lighting: General lighting, Spot, Medium.
- Up&down linear profile + 2 spots - direct/indirect light output and accent lighting: General lighting, Spot, Medium.

Power Supply

The system can be powered by a remote power supply which is not included. Recommended drivers can be fed between 90 and 305Vac and must be ordered separately.

Regulation System

System controlled by 1-10V, DALI or Casambi. Broadcast control system. The light dimming for the up&down version can only happen simultaneously. The upper and lower emission cannot be controlled individually.

For individual regulation via Casambi, use the Casambi version of spots, with non-dimmable power supply.

Additional Information

Electrical system powered at 24Vdc and limited to a maximum current of 5A and a maximum power of 120W. IP20 protection grade. Suitable for installation on normally inflammable surfaces.

Standard Compliance and Quality Marks

EN60598-1 European Technical Standards and any subsequent additions.

FLOS
CONTROL BY CASAMBI



HOW TO ORDER

1 CHOOSE YOUR PROFILE AND LENGTH

DOWN PROFILE



L: 1 / 1,5 / 2 / 2,5 m

UP&DOWN PROFILE



L: 1 / 1,5 / 2 / 2,5 m

DOWN + SPOTS PROFILE



L: 1 / 1,5 / 2 / 2,5 m

UP&DOWN + SPOTS PROFILE



L: 1 / 1,5 / 2 / 2,5 m

2 COMPLETE WITH MOUNTING ACCESSORIES



Accessories

Surface joint



Mechanical

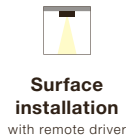

Accessories

Recessed power joint



Electrical and mechanical

or

Recessed power joint with rose



Electrical and mechanical

Surface joint



Mechanical

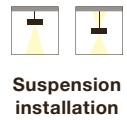

Accessories

Recessed joint



Mechanical

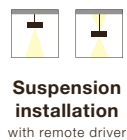

Power suspension joint



Electrical and mechanical

or

Recessed power joint with rose



Electrical and mechanical

Suspension joint



Mechanical



57W - 220 - 240 V

or



120W - 110 - 240 V

1-10V

(select the driver with the appropriate power according to the needs of your project)



57W - 220 - 240 V

or



120W - 110 - 240 V

1-10V

(select the driver with the appropriate power according to the needs of your project)

3 SELECT POWER SUPPLY AND CONTROL OPTION

Surface installation

Surface power supply





1-10 / Dali broadcast / Casambi broadcast

Recessed installation

or  120W - 110 - 240 V

or  120W - 110 - 240 V

or  57W - 220 - 240 V

or  120W - 110 - 240 V

or  **Dali broadcast**

or  **Casambi broadcast**

or  **Casambi**
(select the driver with the appropriate power according to the needs of your project)

Surface installation

Surface power supply





1-10V / Dali broadcast / Casambi broadcast

Suspension installation

or  120W - 110 - 240 V

or  120W - 110 - 240 V

or  57W - 220 - 240 V

or  120W - 110 - 240 V

or  **Dali broadcast**

or  **Casambi broadcast**

or  **Casambi**
(select the driver with the appropriate power according to the needs of your project)

4 SELECT A LIGHT MODULE AND CONTROL OPTION

Atom 90



S/M

Atom 120



S/M

Atom 90



S/M

Casambi

Atom 120



S/M

Casambi

Diversion Down

Light Source: Top LED 13,5 W/m - 1540 lm/m - 2700K/CRI 90 - 3000K/CRI 90

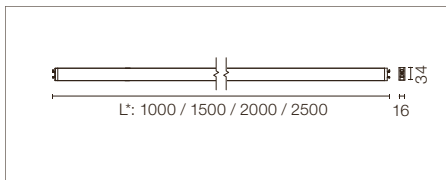

Profilo elettromeccanico da interni con illuminazione lineare diretta integrata per installazione a superficie o in sospensione. Con lunghezze da 1 a 2,5m* (distanza tra i centri dei giunti sferici). Da fissare con kit di alimentazione e giunto meccanico da ordinare separatamente. Kit di alimentazione e giunto meccanico da ordinare separatamente. Sistema controllato con driver 1-10V, DALI o Casambi. Sistema di controllo broadcast. Dimmer non compreso.

Electro-mechanical profile for indoor application with integrated direct linear light element for surface or suspended installation. With lengths varying from 1 to 2.5m* (distance between ball joint centers). Fixation by a joint with power kit. Power kit and mechanical joint must be ordered separately. System controlled by 1-10V driver, DALI or Casambi. Broadcast control system. Dimmer not included.

2700K

L: 1000 mm - 13,5W - 1540 lm

- 09.8000.40
- 09.8000.1A
- 09.8000.14
- 09.8000.CZ

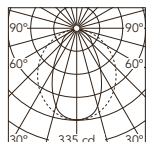

Beam Angle: 62°

h(m)	E(lx)	D(m)
1	335	1.21
2	84	2.41
3	37	3.62
4	21	4.82
5	13	6.03

Luminous flux luminaire 634 lm

L: 1500 mm - 20,5W - 2310 lm

- 09.8002.40
- 09.8002.1A
- 09.8002.14
- 09.8002.CZ

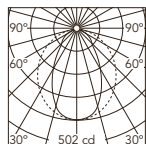

Beam Angle: 62°

h(m)	E(lx)	D(m)
1	502	1.21
2	125	2.41
3	56	3.62
4	31	4.82
5	20	6.03

Luminous flux luminaire 951 lm

L: 2000 mm - 27,5W - 3080 lm

- 09.8004.40
- 09.8004.1A
- 09.8004.14
- 09.8004.CZ

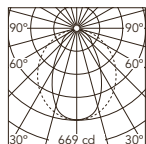

Beam Angle: 62°

h(m)	E(lx)	D(m)
1	669	1.21
2	167	2.41
3	74	3.62
4	42	4.82
5	27	6.03

Luminous flux luminaire 1267 lm

L: 2500 mm - 34,5W - 3850 lm

- 09.8006.40
- 09.8006.1A
- 09.8006.14
- 09.8006.CZ

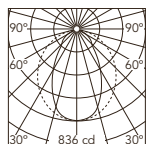

Beam Angle: 62°

h(m)	E(lx)	D(m)
1	836	1.21
2	209	2.41
3	93	3.62
4	52	4.82
5	33	6.03

Luminous flux luminaire 1584 lm

@White (40)

3000K

L: 1000 mm - 13,5W - 1540 lm

- 09.8001.40
- 09.8001.1A
- 09.8001.14
- 09.8001.CZ

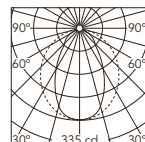

Beam Angle: 62°

h(m)	E(lx)	D(m)
1	335	1.21
2	84	2.41
3	37	3.62
4	21	4.82
5	13	6.03

Luminous flux luminaire 634 lm

L: 1500 mm - 20,5W - 2310 lm

- 09.8003.40
- 09.8003.1A
- 09.8003.14
- 09.8003.CZ

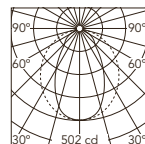

Beam Angle: 62°

h(m)	E(lx)	D(m)
1	502	1.21
2	125	2.41
3	56	3.62
4	31	4.82
5	20	6.03

Luminous flux luminaire 951 lm

L: 2000 mm - 27,5W - 3080 lm

- 09.8005.40
- 09.8005.1A
- 09.8005.14
- 09.8005.CZ

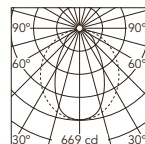

Beam Angle: 62°

h(m)	E(lx)	D(m)
1	669	1.21
2	167	2.41
3	74	3.62
4	42	4.82
5	27	6.03

Luminous flux luminaire 1267 lm

L: 2500 mm - 34,5W - 3850 lm

- 09.8007.40
- 09.8007.1A
- 09.8007.14
- 09.8007.CZ

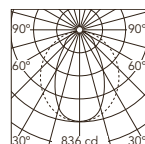

Beam Angle: 62°

h(m)	E(lx)	D(m)
1	836	1.21
2	209	2.41
3	93	3.62
4	52	4.82
5	33	6.03

Luminous flux luminaire 1584 lm

@White (40)

DIVERSION – LIGHT MODULES STRUCTURES

Diversion Up&Down

Light Source: Top LED 20,5 W/m - 744 lm/m UP - 1540 lm/m DOWN - 2700K/CRI 90 - 3000K/CRI 90

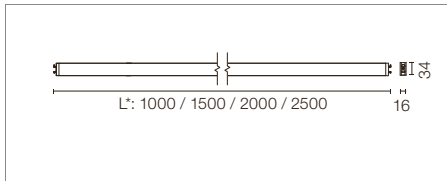

Profilo elettromeccanico da interni con illuminazione lineare diretta e indiretta integrata per installazione a superficie o in sospensione. Con lunghezze da 1 a 2,5m* (distanza tra i centri dei giunti sferici). Da fissare con kit di sospensione alimentato e sostenuto mediante giunto. Kit di alimentazione e giunto meccanico da ordinare separatamente. Sistema controllato con driver 1-10V, DALI o Casambi. Sistema di controllo broadcast. Dimmer non compreso.

Electro-mechanical profile for indoor application with integrated direct and indirect linear light element for surface or suspended installation. With lengths varying from 1 to 2.5m* (distance between ball joint centers). Fixation by fed suspension kit and suspended by a joint. Power kit and mechanical joint must be ordered separately. System controlled by 1-10V driver, DALI or Casambi. Broadcast control system. Dimmer not included.

2700K

L: 1000 mm - 20,5W
744 lm UP - 1540 lm DOWN



- 09.8010.40
- 09.8010.1A
- 09.8010.14
- 09.8010.CZ

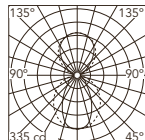

Beam Angle: 62°

h(m)	E(lx)	D(m)
1	335	1.21
2	84	2.41
3	37	3.62
4	21	4.82
5	13	6.03

Luminous flux luminaire 1244 lm

L: 1500 mm - 32W
1116 lm UP - 2310 lm DOWN



- 09.8012.40
- 09.8012.1A
- 09.8012.14
- 09.8012.CZ

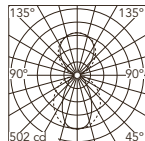

Beam Angle: 62°

h(m)	E(lx)	D(m)
1	502	1.21
2	125	2.41
3	56	3.62
4	31	4.82
5	20	6.03

Luminous flux luminaire 1867 lm

L: 2000 mm - 43W
1488 lm UP - 3080 lm DOWN



- 09.8014.40
- 09.8014.1A
- 09.8014.14
- 09.8014.CZ

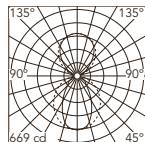

Beam Angle: 62°

h(m)	E(lx)	D(m)
1	669	1.21
2	167	2.41
3	74	3.62
4	42	4.82
5	27	6.03

Luminous flux luminaire 2489 lm

L: 2500 mm - 54,5W
1860 lm UP - 3850 lm DOWN



- 09.8016.40
- 09.8016.1A
- 09.8016.14
- 09.8016.CZ

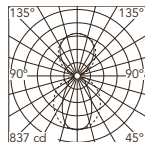

Beam Angle: 62°

h(m)	E(lx)	D(m)
1	837	1.21
2	209	2.41
3	93	3.62
4	52	4.82
5	33	6.03

Luminous flux luminaire 3111 lm

@White (40)

3000K

L: 1000 mm - 20,5W
744 lm UP - 1540 lm DOWN



- 09.8011.40
- 09.8011.1A
- 09.8011.14
- 09.8011.CZ

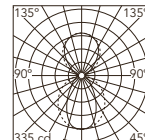

Beam Angle: 62°

h(m)	E(lx)	D(m)
1	335	1.21
2	84	2.41
3	37	3.62
4	21	4.82
5	13	6.03

Luminous flux luminaire 1244 lm

L: 1500 mm - 32W
1116 lm UP - 2310 lm DOWN



- 09.8013.40
- 09.8013.1A
- 09.8013.14
- 09.8013.CZ

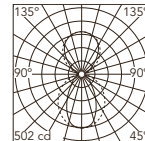

Beam Angle: 62°

h(m)	E(lx)	D(m)
1	502	1.21
2	125	2.41
3	56	3.62
4	31	4.82
5	20	6.03

Luminous flux luminaire 1867 lm

L: 2000 mm - 43W
1488 lm UP - 3080 lm DOWN



- 09.8015.40
- 09.8015.1A
- 09.8015.14
- 09.8015.CZ

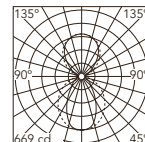

Beam Angle: 62°

h(m)	E(lx)	D(m)
1	669	1.21
2	167	2.41
3	74	3.62
4	42	4.82
5	27	6.03

Luminous flux luminaire 2489 lm

L: 2500 mm - 54,5W
1860 lm UP - 3850 lm DOWN



- 09.8017.40
- 09.8017.1A
- 09.8017.14
- 09.8017.CZ

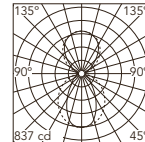

Beam Angle: 62°

h(m)	E(lx)	D(m)
1	837	1.21
2	209	2.41
3	93	3.62
4	52	4.82
5	33	6.03

Luminous flux luminaire 3111 lm

@White (40)

Diversion Down + Spots

Light Source: Top LED 11W/m* - 1255 lm/m - 2700K/CRI 90 - 3000K/CRI 90

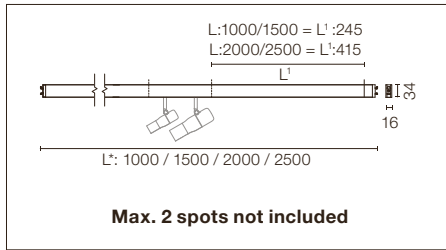

Profilo elettromeccanico da interni con illuminazione lineare diretta integrata e spazio per due spot, per installazione a superficie o in sospensione. Con lunghezze da 1 a 2,5m* (distanza tra i centri dei giunti sferici). Da fissare con kit di sospensione alimentato e sostenuto mediante giunto. Kit di alimentazione e giunto meccanico da ordinare separatamente. Sistema controllato con driver 1-10V, DALI o Casambi. Sistema di controllo broadcast. Dimmer non compreso. Nelle strutture in sospensione composte da un unico profilo, è necessario equilibrare i faretto per evitarne l'inclinazione.

Electro-mechanical profile for indoor application with integrated direct linear light element and space for two spots, for surface or suspended installation. With lengths varying from 1 to 2.5m* (distance between ball joint centers). Fixation by fed suspension kit and suspended by a joint. Power kit and mechanical joint must be ordered separately. System controlled by 1-10V driver, DALI or Casambi. Broadcast control system. Dimmer not included. For single profile structures, suspended version, balance the spot to avoid profile tilting.

2700K

L: 1000 mm - 11W - 1255 lm

- 09.8020.40
- 09.8020.1A
- 09.8020.14
- 09.8020.CZ

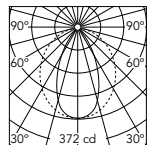

Beam Angle: 52°

h(m)	E(lx)	D(m)
1	372	0.97
2	93	1.93
3	41	2.90
4	23	3.87
5	15	4.84

Luminous flux luminaire 516 lm

3000K

L: 1000 mm - 11W - 1255 lm

- 09.8021.40
- 09.8021.1A
- 09.8021.14
- 09.8021.CZ

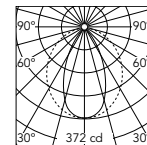

Beam Angle: 52°

h(m)	E(lx)	D(m)
1	372	0.97
2	93	1.93
3	41	2.90
4	23	3.87
5	15	4.84

Luminous flux luminaire 516 lm

L: 1500 mm - 18W - 2097 lm

- 09.8022.40
- 09.8022.1A
- 09.8022.14
- 09.8022.CZ

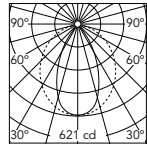

Beam Angle: 52°

h(m)	E(lx)	D(m)
1	621	0.97
2	155	1.93
3	69	2.90
4	39	3.87
5	25	4.84

Luminous flux luminaire 863 lm

L: 1500 mm - 18W - 2097 lm

- 09.8023.40
- 09.8023.1A
- 09.8023.14
- 09.8023.CZ

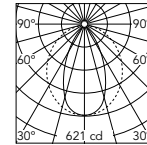

Beam Angle: 52°

h(m)	E(lx)	D(m)
1	621	0.97
2	155	1.93
3	69	2.90
4	39	3.87
5	25	4.84

Luminous flux luminaire 863 lm

L: 2000 mm - 25W - 2939 lm

- 09.8024.40
- 09.8024.1A
- 09.8024.14
- 09.8024.CZ

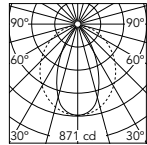

Beam Angle: 52°

h(m)	E(lx)	D(m)
1	871	0.97
2	218	1.93
3	97	2.90
4	54	3.87
5	35	4.84

Luminous flux luminaire 1209 lm

L: 2000 mm - 25W - 2939 lm

- 09.8025.40
- 09.8025.1A
- 09.8025.14
- 09.8025.CZ

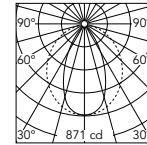

Beam Angle: 52°

h(m)	E(lx)	D(m)
1	871	0.97
2	218	1.93
3	97	2.90
4	54	3.87
5	35	4.84

Luminous flux luminaire 1209 lm

L: 2500 mm - 32W - 3781 lm

- 09.8026.40
- 09.8026.1A
- 09.8026.14
- 09.8026.CZ

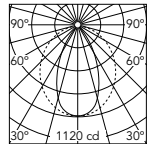

Beam Angle: 52°

h(m)	E(lx)	D(m)
1	1120	0.97
2	280	1.93
3	124	2.90
4	70	3.87
5	45	4.84

Luminous flux luminaire 1556 lm

@White (40)

L: 2500 mm - 32W - 3781 lm

- 09.8027.40
- 09.8027.1A
- 09.8027.14
- 09.8027.CZ

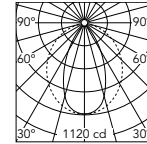

Beam Angle: 52°

h(m)	E(lx)	D(m)
1	1120	0.97
2	280	1.93
3	124	2.90
4	70	3.87
5	45	4.84

Luminous flux luminaire 1556 lm

@White (40)

* Potenza senza proiettori / Power without spots.

DIVERSION – LIGHT MODULES STRUCTURES

Diversion Up&Down + Spots

Light Source: Top LED 18W/m* - 1999 lm/m - 2700K/CRI 90 - 3000K/CRI 90

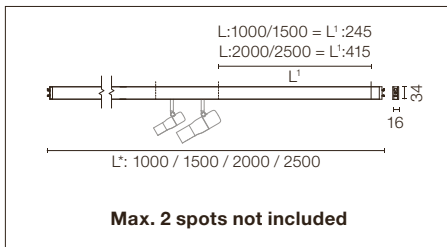

Profilo elettromeccanico da interni con illuminazione lineare diretta integrata e spazio per due spot, per installazione a superficie o in sospensione. Con lunghezze da 1 a 2,5m* (distanza tra i centri dei giunti sferici). Da fissare con kit di sospensione alimentato e sostenuto mediante giunto. Kit di alimentazione e giunto meccanico da ordinare separatamente. Sistema controllato con driver 1-10V, DALI o Casambi. Sistema di controllo broadcast. Dimmer non compreso. Nelle strutture in sospensione composte da un unico profilo, è necessario equilibrare i faretti per evitarne l'inclinazione.

Electro-mechanical profile for indoor application with integrated direct linear light element and space for two spots, for surface or suspended installation. With lengths varying from 1 to 2.5m* (distance between ball joint centers). Fixation by fed suspension kit and suspended by a joint. Power kit and mechanical joint must be ordered separately. System controlled by 1-10V driver, DALI or Casambi. Broadcast control system. Dimmer not included. For single profile structures, suspended version, balance the spot to avoid profile tilting.

2700K

L: 1000 mm - 18W
744 lm UP - 1255 lm DOWN

- 09.8030.40
- 09.8030.1A
- 09.8030.14
- 09.8030.CZ

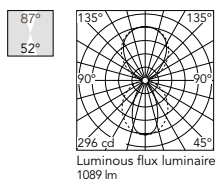

Beam Angle: 52°

h(m)	E(lx)	D(m)
1	296	0.97
2	74	1.93
3	33	2.90
4	18	3.87
5	12	4.84

L: 1500 mm - 29,5W
1166 lm UP - 2097 lm DOWN

- 09.8032.40
- 09.8032.1A
- 09.8032.14
- 09.8032.CZ

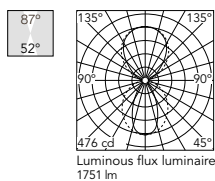

Beam Angle: 52°

h(m)	E(lx)	D(m)
1	476	0.97
2	119	1.93
3	53	2.90
4	30	3.87
5	19	4.84

L: 2000 mm - 40,5W
1488 lm UP - 2939 lm DOWN

- 09.8034.40
- 09.8034.1A
- 09.8034.14
- 09.8034.CZ

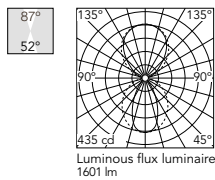

Beam Angle: 52°

h(m)	E(lx)	D(m)
1	435	0.97
2	109	1.93
3	48	2.90
4	27	3.87
5	17	4.84

L: 2500 mm - 52W
1816 lm UP - 3781 lm DOWN

- 09.8036.40
- 09.8036.1A
- 09.8036.14
- 09.8036.CZ

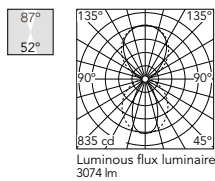

Beam Angle: 52°

h(m)	E(lx)	D(m)
1	835	0.97
2	209	1.93
3	93	2.90
4	52	3.87
5	33	4.84

@White (40)

3000K

L: 1000 mm - 18W
744 lm UP - 1255 lm DOWN

- 09.8031.40
- 09.8031.1A
- 09.8031.14
- 09.8031.CZ

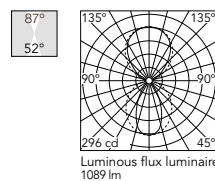

Beam Angle: 52°

h(m)	E(lx)	D(m)
1	296	0.97
2	74	1.93
3	33	2.90
4	18	3.87
5	12	4.84

L: 1500 mm - 29,5W
1166 lm UP - 2097 lm DOWN

- 09.8033.40
- 09.8033.1A
- 09.8033.14
- 09.8033.CZ

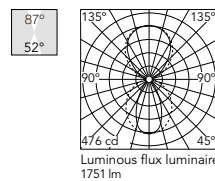

Beam Angle: 52°

h(m)	E(lx)	D(m)
1	476	0.97
2	119	1.93
3	53	2.90
4	30	3.87
5	19	4.84

L: 2000 mm - 40,5W
1488 lm UP - 2939 lm DOWN

- 09.8035.40
- 09.8035.1A
- 09.8035.14
- 09.8035.CZ

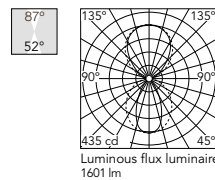

Beam Angle: 52°

h(m)	E(lx)	D(m)
1	435	0.97
2	109	1.93
3	48	2.90
4	27	3.87
5	17	4.84

L: 2500 mm - 52W
1816 lm UP - 3781 lm DOWN

- 09.8037.40
- 09.8037.1A
- 09.8037.14
- 09.8037.CZ

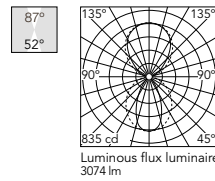

Beam Angle: 52°

h(m)	E(lx)	D(m)
1	835	0.97
2	209	1.93
3	93	2.90
4	52	3.87
5	33	4.84

@White (40)

* Potenza senza proiettori / Power without spots.

DIVERSION – LIGHT MODULES

Atom 90 Designed By Piero Lissoni

Light Source: Power LED 5,5W - 450 lm - 2700K/CRI 90 / 5,5W - 485 lm - 3000K/CRI 90

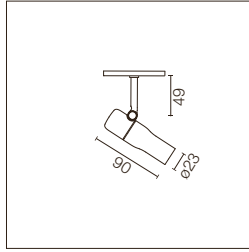

Modulo di illuminazione LED d'accento, installabile sul sistema Diversion. Convertitore elettronico DC/DC incorporato. Sistema regolabile con driver 1-10V, DALI o Casambi. Sistema di controllo broadcast. Dimmer non incluso. Per controllare individualmente gli spot tramite Casambi selezionare gli spot in versione Casambi. Accessori inclusi (honeycomb e filtro a croce antiabbagliamento).

LED accent lighting module to be installed in the Diversion system. Electronic DC/DC converter incorporated. System controlled by 1-10V, DALI or Casambi. Broadcast control system. Dimmer not included. To individually control the spots via Casambi, choose the Casambi version of spots. Accessories included (honeycomb and screening crosspiece).

- 2700K**
- 09.3831.40A
 - 09.3831.1AA
 - 09.3831.14A
 - 09.3831.CZA
 - Casambi
 - 09.3931.40A
 - 09.3931.14A
 - 09.3931.CZA

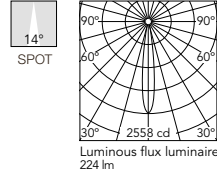

h(m)	E(lx)	D(m)
1	2558	0.25
2	640	0.51
3	284	0.76
4	160	1.02
5	102	1.27

- 3000K**
- 09.3830.40A
 - 09.3830.1AA
 - 09.3830.14A
 - 09.3830.CZA
 - Casambi
 - 09.3930.40A
 - 09.3930.14A
 - 09.3930.CZA

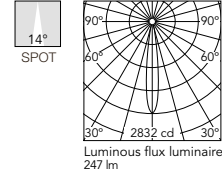

h(m)	E(lx)	D(m)
1	2832	0.25
2	708	0.51
3	315	0.76
4	177	1.02
5	113	1.27

- 2700K**
- 09.3833.40A
 - 09.3833.1AA
 - 09.3833.14A
 - 09.3833.CZA
 - Casambi
 - 09.3933.40A
 - 09.3933.14A
 - 09.3933.CZA

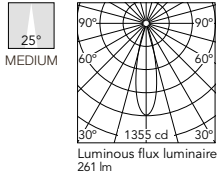

h(m)	E(lx)	D(m)
1	1355	0.45
2	339	0.89
3	151	1.34
4	85	1.79
5	54	2.23

- 3000K**
- 09.3832.40A
 - 09.3832.1AA
 - 09.3832.14A
 - 09.3832.CZA
 - Casambi
 - 09.3932.40A
 - 09.3932.14A
 - 09.3932.CZA

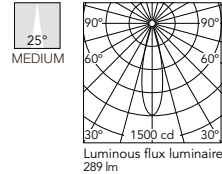

h(m)	E(lx)	D(m)
1	1500	0.45
2	375	0.89
3	167	1.34
4	94	1.79
5	60	2.23

Atom 120 Designed By Piero Lissoni

Light Source: Power LED 8W - 635 lm - 2700K/CRI 90 / 8W - 680 lm - 3000K/CRI 90

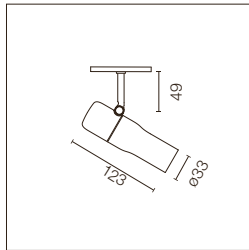

Modulo di illuminazione LED d'accento, installabile sul sistema Diversion. Convertitore elettronico DC/DC incorporato. Sistema regolabile con driver 1-10V, DALI o Casambi. Sistema di controllo broadcast. Dimmer non incluso. Per controllare individualmente gli spot tramite Casambi selezionare gli spot in versione Casambi. Accessori inclusi (honeycomb e filtro a croce antiabbagliamento).

LED accent lighting module to be installed in the Diversion system. Electronic DC/DC converter incorporated. System controlled by 1-10V, DALI or Casambi. Broadcast control system. Dimmer not included. To individually control the spots via Casambi, choose the Casambi version of spots. Accessories included (honeycomb and screening crosspiece).

- 2700K**
- 09.3841.40A
 - 09.3841.1AA
 - 09.3841.14A
 - 09.3841.CZA
 - Casambi
 - 09.3941.40A
 - 09.3941.14A
 - 09.3941.CZA

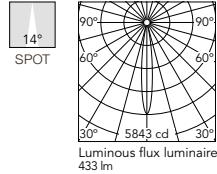

h(m)	E(lx)	D(m)
1	5843	0.24
2	1461	0.48
3	649	0.72
4	365	0.95
5	234	1.19

- 3000K**
- 09.3840.40A
 - 09.3840.1AA
 - 09.3840.14A
 - 09.3840.CZA
 - Casambi
 - 09.3940.40A
 - 09.3940.14A
 - 09.3940.CZA

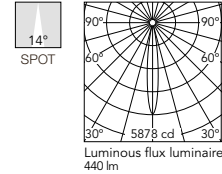

h(m)	E(lx)	D(m)
1	5878	0.24
2	1469	0.49
3	653	0.73
4	367	0.97
5	235	1.21

- 2700K**
- 09.3843.40A
 - 09.3843.1AA
 - 09.3843.14A
 - 09.3843.CZA
 - Casambi
 - 09.3943.40A
 - 09.3943.14A
 - 09.3943.CZA

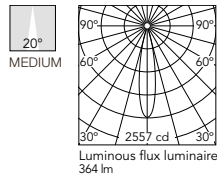

h(m)	E(lx)	D(m)
1	2557	0.35
2	639	0.70
3	284	1.06
4	160	1.41
5	102	1.76

- 3000K**
- 09.3842.40A
 - 09.3842.1AA
 - 09.3842.14A
 - 09.3842.CZA
 - Casambi
 - 09.3942.40A
 - 09.3942.14A
 - 09.3942.CZA

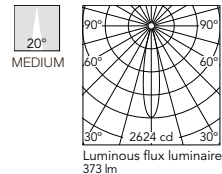

h(m)	E(lx)	D(m)
1	2624	0.35
2	656	0.70
3	292	1.06
4	164	1.41
5	105	1.76

DIVERSION – DRIVERS

Driver / Drivers

Remote Installation

Fonte di alimentazione remota.
Regolabile mediante protocollo 1/10V o non regolabile. 24V.

Remote power supply.
Dimmable through 1/10V protocol or Non Dimmable. 24V.

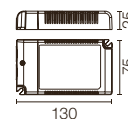

57W - 220/240V
RF28212

Fonte di alimentazione remota.
Regolabile mediante protocollo 1/10V. 24V.

Remote power supply.
Dimmable through 1/10V protocol. 24V.

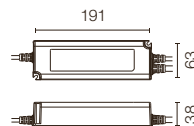

120W - 110*/240V
60.9416

*UL max 100W

Fonte di alimentazione remota.
Regolabile mediante protocollo DALI. 24V.

Remote power supply.
Dimmable through DALI protocol. 24V.

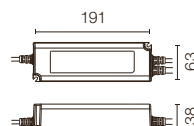

120W - 110*/240V
60.9426

*UL max 100W

Driver Casambi. Si consiglia di regolare il livello minimo al 5%. È necessario 1-10V o driver Dali, da ordinare separatamente.

Casambi controller. It is recommended to adjust the minimum level of regulation to 5%. Requires 1-10V or Dali driver. It must be ordered separately.

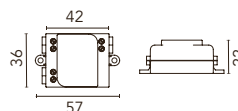

220-240Vac
60.9392

Remote Driver Installations - Broadcast

Driver Option 1 (DALI)

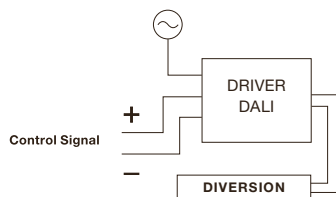

Driver Option 2 (1-10V)

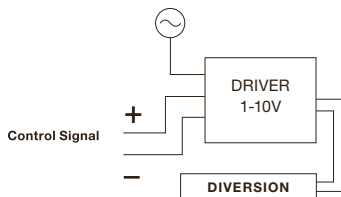

Driver Option 3 Casambi Interface (Broadcast)

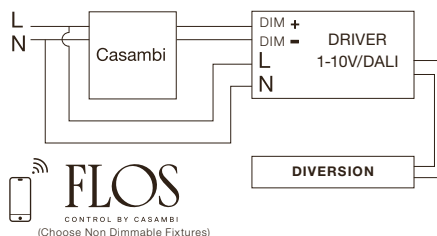

Spots CASAMBI Individual & NO DIM Linear Lights

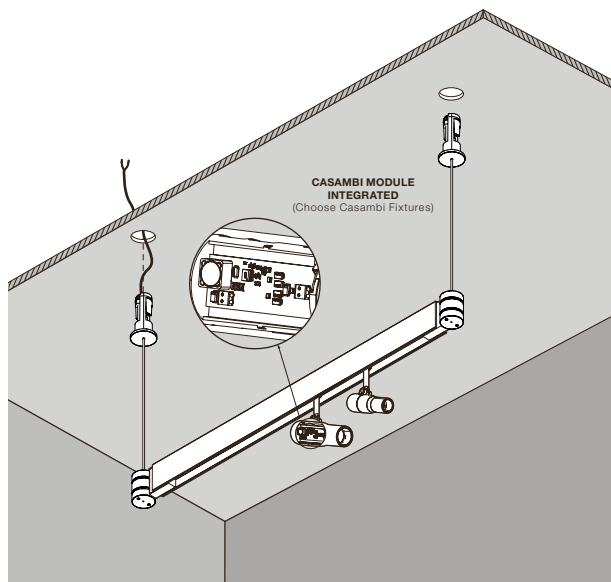

DIVERSION – INSTALLATION

SUSPENSION INSTALLATION

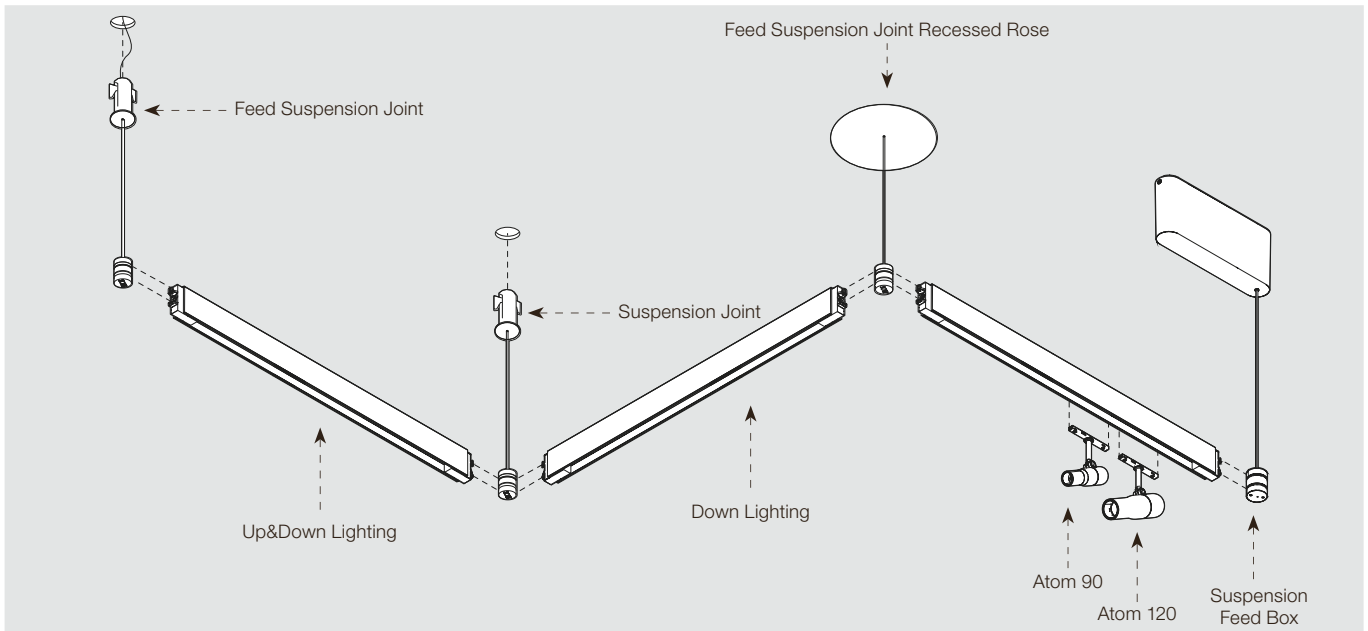

Accessori / Accessories

Giunto di alimentazione per sospensione. 24V.
Cavo di alimentazione: 3800mm.

Feed suspension joint. 24V.
Power cable: 3800 mm.



06.5300.40
06.5300.1A
06.5300.14
06.5300.CZ

Giunto di sospensione.
Filo in acciaio 0,6mm di spessore e lunghezza 3800 mm.

Suspension joint.
0.6 mm thick, 3800 mm long steel wire.



06.5301.40
06.5301.1A
06.5301.14
06.5301.CZ

Giunto di alimentazione per sospensione da incassare con rosone. 24V.
Cavo di alimentazione: 3800mm.

Feed suspension joint with rose, for recessing. 24V.
Power cable: 3800 mm.



06.5302.40
06.5302.1A
06.5302.14
06.5302.CZ

Cassetta di alimentazione in sospensione per installazione a superficie. 24V.
Cavo di alimentazione: 3800mm.
Driver compreso. (1-10V/DALI/Casambi).

Suspension feed box, for surface installation. 24V.
Power cable: 3800 mm.
Driver included (1-10V/DALI/Casambi).

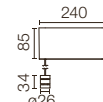

1-10V / 57W - 220-240Vac
06.5310.40
06.5310.1A
06.5310.14
06.5310.CZ
*DALI / 57W - 220-240Vac
06.5314.40
06.5314.1A
06.5314.14
06.5314.CZ
Casambi / 57W - 220-240Vac
06.5311.40
06.5311.1A
06.5311.14
06.5311.CZ

Giunto di sospensione per installazione a superficie.
Filo in acciaio 0,6mm di spessore e lunghezza 3800 mm.

Suspension joint, for surface installation.
0.6 mm thick, 3800 mm long steel wire.



06.5303.40
06.5303.1A
06.5303.14
06.5303.CZ

* Interfaccia DALI compatibile (IEC 62386-101/102). Attenzione: trattandosi di un componente DALI compatibile, potrebbe non rispondere a funzioni avanzate del protocollo DALI. Per ulteriori informazioni si prega di consultare le caratteristiche tecniche nella pagina web Fios / Compatible DALI interface (IEC 62386-101/102). Please note that since it is a DALI compatible component, it may not respond to advanced DALI protocol functions. For more information, see the technical specifications section on the Fios website.

DIVERSION – INSTALLATION

SURFACE INSTALLATION

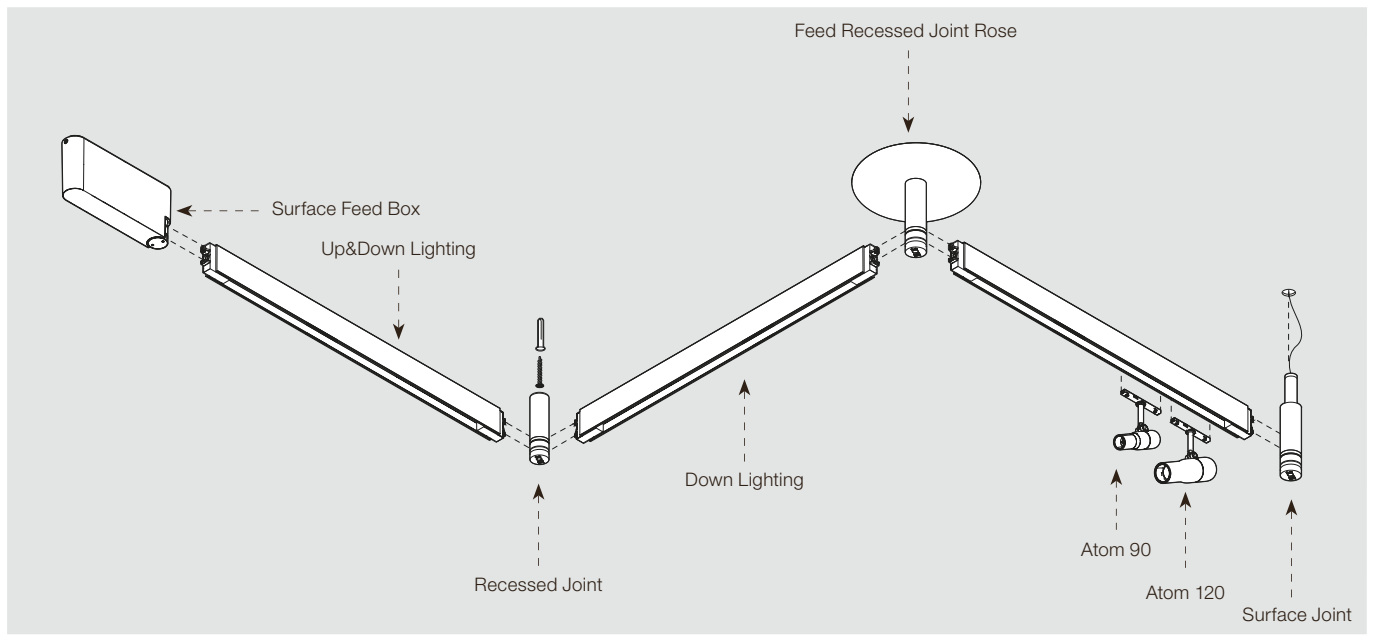

Accessori / Accessories

Giunto di alimentazione a incasso. 24V.

Feed recessed joint. 24V



- 06.5304.40
- 06.5304.1A
- 06.5304.14
- 06.5304.CZ

Giunto a incasso e a superficie.

Recessed / surface joint.



- 06.5305.40
- 06.5305.1A
- 06.5305.14
- 06.5305.CZ

Giunto di alimentazione da incasso con rosone. 24V.

Feed recessed joint rose. 24V.

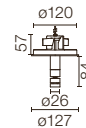

- 06.5306.40
- 06.5306.1A
- 06.5306.14
- 06.5306.CZ

Cassetta di alimentazione per installazione a superficie. 24V. Driver compreso (1-10V/DALI/Casambi).

Surface feed box, for ceiling installation. 24V. Driver included (1-10V/DALI/Casambi).



- 1-10V / 57W - 220-240Vac
- 06.5312.40
- 06.5312.1A
- 06.5312.14
- 06.5312.CZ
- *DALI / 57W - 220-240Vac
- 06.5315.40
- 06.5315.1A
- 06.5315.14
- 06.5315.CZ
- Casambi / 57W - 220-240Vac
- 06.5313.40
- 06.5313.1A
- 06.5313.14
- 06.5313.CZ

* Interfaccia DALI compatibile (IEC 62386-101/102). Attenzione: trattandosi di un componente DALI compatibile, potrebbe non rispondere a funzioni avanzate del protocollo DALI. Per ulteriori informazioni si prega di consultare le caratteristiche tecniche nella pagina web Fios / Compatible DALI interface (IEC 62386-101/102). Please note that since it is a DALI compatible component, it may not respond to advanced DALI protocol functions. For more information, see the technical specifications section on the Fios website.

• **Quanti profili possono essere alimentati dalla stessa fonte di alimentazione?**

Il limite è dato dalla la potenza. Usando la fonte di alimentazione di 120W bisogna adeguare il numero di apparecchi a questa potenza massima.

• **Quanti profili possono essere collegati a un solo giunto?**

Allo stesso giunto possono essere collegati massimo 8 profili.

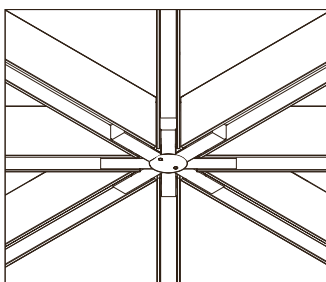

• **How many profiles can I feed up with the same driver?**

Power is the limit. When using the 120W driver model, the number of luminaires must be adjusted to that maximum consumption.

• **How many profiles can I connect to one single joint?**

It is possible to connect up to 8 profiles to the same joint.

• **Quanti profili possono essere alimentati da un solo giunto di alimentazione?**

Il massimo sono 8, uno ogni 45°, e il limite è dato dalla potenza che deve essere inferiore a 120W.

- Esempio 1: usando i profili di 1m e di illuminazione diretta (DOWN).

Potenza Modulo luce = 13,5W.

$120W/13,5W = 8,88$ moduli, arrotondando al numero intero per difetto abbiamo un massimo di 8 moduli.

Quindi il giunto potrà essere completato con un massimo di 8 moduli lineari di luce senza faretti.

- Esempio 2: usando i profili di 2,5m con emissione diretta e indiretta (Up&Down) con due faretti Atom 120.

Potenza Modulo luce + 2 faretti = $54,5W + 2 \times 8W = 70,5W$. $120W/70,5W = 1,7$ moduli, arrotondando al numero intero per difetto abbiamo un massimo di 1 modulo.

Quindi il giunto potrà essere completato con un solo modulo lineare di luce con due faretti. Per aggiungere altri elementi allo stesso giunto, questi dovranno essere alimentati da un altro giunto nell'estremo opposto.

È fondamentale configurare gli interruttori situati agli estremi di ogni profilo per evitare di attivare/disattivare varie fonti di alimentazione, cosa che provocherebbe un cattivo funzionamento del sistema.

• **How many profiles can I feed up with one single feeding joint?**

The maximum quantity is 8 pieces, one every 45°. The limit is represented by their total power consumption which has to be less than 120W.

- Example 1; when using 1m profiles with direct light emission (DOWN).

Lighting module power consumption = 13,5W.

$120W/13,5W = 8,88$ lighting modules, which means 8 modules maximum.

The joint could therefore feature up to 8 light modules single emission without spots.

- Example 2; when using 2,5m profiles featuring direct/indirect light emission (Up&Down) with 2 Atom 120 spots.

Lighting module power consumption including 2 spots = $54,5W + 2 \times 8W = 70,5W$.

$120W/70,5W = 1,7$ modules, which means 1 module maximum.

It is therefore possible to complete a joint attaching only one lighting module Up&Down equipped with two spots. In order to add more elements to the same joint, these will need to be fed by another dedicated joint located on the opposite side of the profile.

Please make sure to set the integrated switches located at the end of each profile. This will avoid switching multiple power supplies, which would cause the entire system to malfunction.

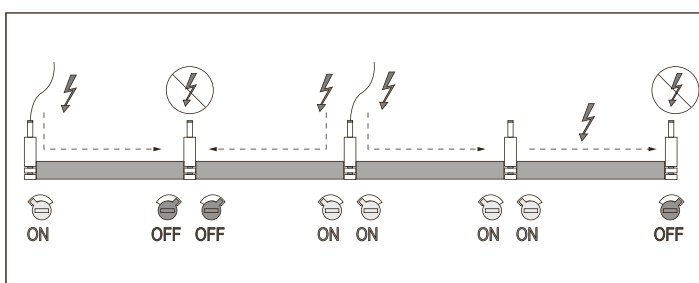
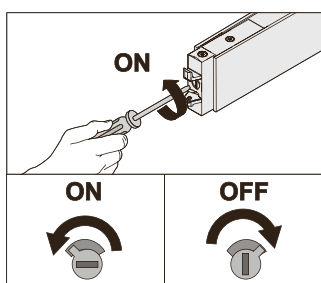

• **Posso controllare ogni apparecchio individualmente?**

No, il sistema è controllato simultaneamente (broadcast). L'illuminazione diretta e indiretta non possono essere separate per essere controllate in modo indipendente.

I moduli con illuminazione indiretta sono dotati di un commutatore per ridurre la potenza massima al 50%, fissando questa potenza massima senza incidere sulle opzioni di regolazione DALI, 1-10V o Casambi.

• **Can I control each luminaire individually?**

No, the entire system is controlled simultaneously (broadcast). Direct and indirect lighting cannot be separated for independent control either.

Modules with indirect illumination are equipped with a switch to reduce the maximum power of 50%, establishing it as the maximum without affecting the DALI, 1-10V or Casambi dimming options.

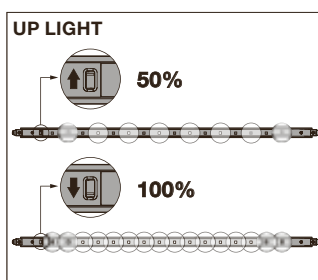

• **Con una alimentazione a superficie qual è il profilo più grande che è possibile installare?**

- Up&Down - 2500mm
- Up&Down + 2 Spots - 2000m
- Down - 2500mm
- Down + 2 Spots - 2500mm

• **Che tipo di configurazioni posso realizzare con il sistema Diversion?**

A titolo di esempio mostriamo le seguenti configurazioni; le possibilità sono pressoché infinite tenendo conto che l'angolo minimo di rotazione tra i profili è di 45° e il carico massimo dipende dall'unità di alimentazione selezionata. (Unità di alimentazione non inclusa, a secondo dell'installazione il driver può essere installato remoto o all'interno di box dedicati in superficie o sospensione).

• **Which is the biggest profile I can install with the surface power supply?**

- Up&Down - 2500mm
- Up&Down + 2 Spots - 2000m
- Down - 2500mm
- Down + 2 Spots - 2500mm

• **Which kind of layouts can be designed with Diversion?**

As an example, we show the following compositions; the possibilities of configuration with this system are almost endless considering that the minimum angle between two profiles is 45° and the maximum load depends on the feeding equipment selected. (Feeding equipment is not included, depending on the installation, the equipment can be remote or with suspension or surface boxes).

Example No.1

- 6 x Light Module Diversion Down + Spots - L 1000 mm
- 2 x Light Module Diversion Down - L 1000 mm
- 12 x Atom 120
- 5 x Joint
- 2 x Power Joint

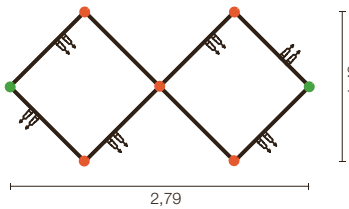

Example No.2

- 6 x Light Module Diversion Down + Spots - L 1000 mm
- 2 x Light Module Diversion Down - L 1000 mm
- 12 x Atom 90
- 1 x Power Joint Suspension
- 3 x Joint Suspension
- 1 x Power Joint Surface
- 3 x Joint Surface

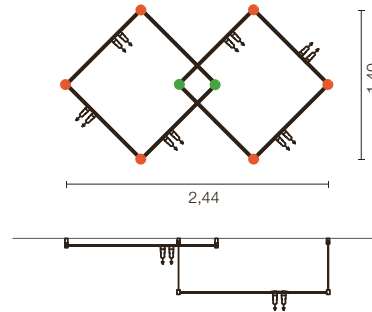

Example No.3

- 4 x Light Module Diversion Down + Spots - L 1000 mm
- 2 x Light Module Diversion Down - L 1000 mm
- 8 x Atom 120
- 4 x Joint
- 2 x Power Joint

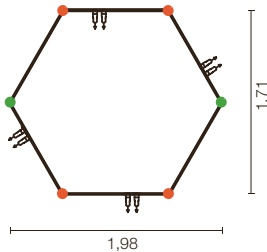

Example No.4

- 3 x Light Module Diversion Down + Spots - L 1000 mm
- 6 x Atom 90
- 3 x Joint
- 1 x Power Joint

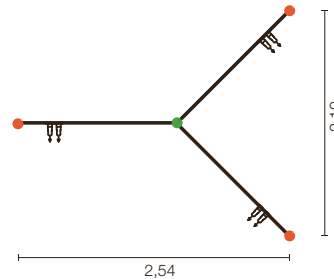

Example No.5

- 5 x Light Module Diversion Down + Spots - L 1000 mm
- 3 x Light Module Diversion Down - L 1000 mm
- 1 x Light Module Diversion Down + Spots - L 1500 mm
- 1 x Light Module Diversion Down - L 1500 mm
- 1 x Light Module Diversion Down + Spots - L 2000 mm
- 1 x Light Module Diversion Down - L 2000 mm
- 14 x Atom 90
- 6 x Joint
- 3 x Power Joint

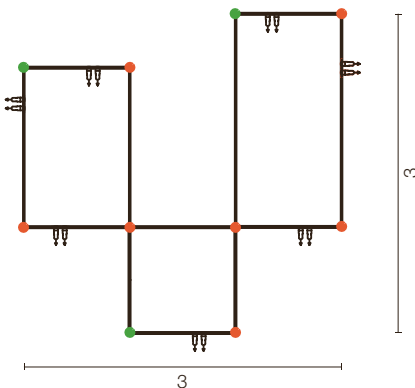

Example No.6

- 3 x Light Module Diversion Up&Down + Spots - L 1500 mm
- 6 x Atom 90
- 3 x Joint
- 1 x Power Joint

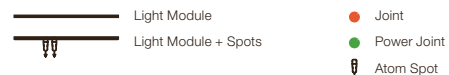
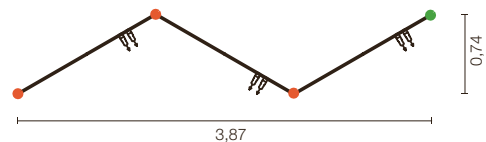

ZERO TRACK

DESIGNED BY FLOS ARCHITECTURAL

SURFACE

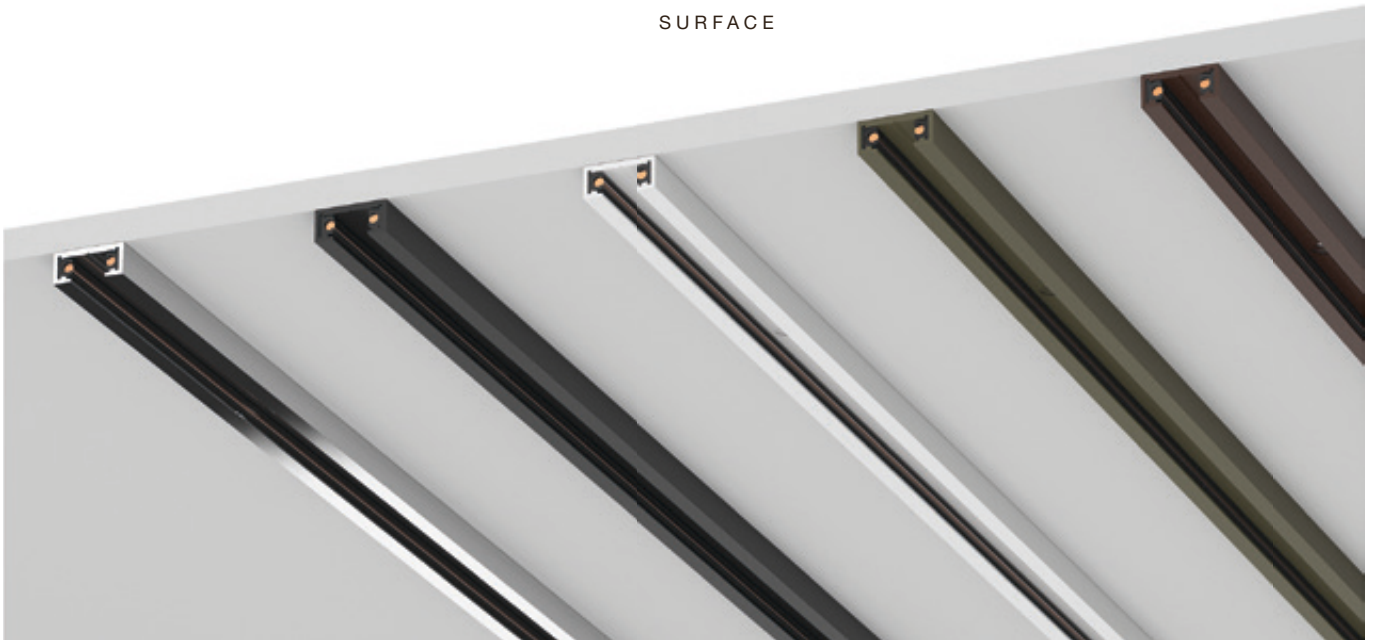

Surface Profiles

 40 Bianco	 06 Cromo	 14 Nero	 CZ Bronzo	 18 Deep brown
 40 White	 06 Chrome	 14 Black	 CZ Bronze	 18 Deep brown

LIGHT MODULES

FIND ME 0



LIGHT SOURCE
POWER LED
3,5W
300 lm
2700K/CRI 90
325 lm
3000K/CRI 90

FIND ME 1



LIGHT SOURCE
POWER LED
5,5W
450 lm
2700K/CRI 90
485 lm
3000K/CRI 90

FIND ME 2



LIGHT SOURCE
POWER LED
10,5W
650 lm
2700K/CRI 90
700 lm
3000K/CRI 90

FIND ME 1
SUSPENSION

LIGHT SOURCE
POWER LED
5,5W
450 lm
2700K/CRI 90
485 lm
3000K/CRI 90

ATOM 90



LIGHT SOURCE
POWER LED
5,5W
450 lm
2700K/CRI 90
485 lm
3000K/CRI 90

ATOM 120



LIGHT SOURCE
POWER LED
8W
635 lm
2700K/CRI 90
680 lm
3000K/CRI 90

ATOM 200



LIGHT SOURCE
POWER LED
10,5W
1050 lm
2700K/CRI 90
1150 lm
3000K/CRI 90

Descrizione

Questo nuovo sistema di profili per installazione a superficie è caratterizzato da dimensioni ridotte che conferiscono un'estetica minimalista molto apprezzata in svariati spazi architettonici. Per soluzioni a soffitti non accessibili, il sistema è fornito con fonti di alimentazione attenuabili integrate, con sistema di controllo broadcast 1-10V.

Alimentazione remota dimmerabile disponibile con 1/10V, DALI e Casambi Broadcast. Unità di alimentazione in superficie disponibile con protocollo 1/10V. Sistema Casambi disponibile per controllo dimmerazione individuale di ogni unità luminosa tramite app FLOS Control® powered by Casambi per dispositivi mobili (Apple Store e Google Play).

Il sistema a guide di alluminio estruso è fornito con lunghezza fino a 3m e nei colori bianco, nero, deep brown, bronzo e cromo.

Sono dotati di binari elettrificati alimentabili a 24 Vdc.

Sistema Ottico

- Find Me 0: Spot, Medium.
- Find Me 1: Spot, Medium.
- Find Me 2: Spot, Medium, Flood.
- Find Me 1 Suspension: Spot, Medium.
- Atom 90: Spot, Medium.
- Atom 120: Spot, Medium.
- Atom 200: General lighting.

Unità di Alimentazione

Il sistema può essere alimentato da una fonte remota non inclusa o con l'apparecchiatura di alimentazione da inserire nella guida, fornita con una fonte di alimentazione regolabile.

Il connettore di alimentazione iniziale dispone di uno spazio per l'ingresso dei cavi sia nella parte superiore che in quella laterale. Il connettore di alimentazione, l'alimentatore intermedio e gli elementi angolari di 90° si possono alimentare esclusivamente dal retro.

La lunghezza massima della pista con lo stesso driver è di 10 metri.

Informazioni Aggiuntive

Sistema elettrico alimentato a 24V e limitato ad una corrente massima di 5A e 120W.

Grado di protezione IP20.

Adatti ad installazioni su superfici normalmente incombustibili.

Conformità e Marchi di Qualità

Apparecchio conforme alla Normativa Tecnica Europea EN60598-1 e relative parti seconde.

Description

This new system of profiles for surface installation is characterized by its reduced dimensions, providing a minimalist aesthetic which is highly appreciated in various architectural spaces. For non-accessible ceilings, the system has integrated dimmable power supplies, controlled by 1-10V broadcast control systems.

Available remote power supplies dimmable through 1/10V, DALI and Casambi Broadcast systems. Surface feeding unit available with 1/10V protocol. Casambi system available for individual bluetooth dimming of each light unit through the app FLOS Control® powered by Casambi for mobile (available on Apple Store and Google Play).

The system of extruded aluminum tracks up to 3 meters in white, black, deep brown bronze and chrome.

They are equipped with electric s supporting 24Vdc power supplies.

Optic system

- Find Me 0: Spot, Medium.
- Find Me 1: Spot, Medium.
- Find Me 2: Spot, Medium, Flood.
- Find Me 1 Suspension: Spot, Medium.
- Atom 90: Spot, Medium.
- Atom 120: Spot, Medium.
- Atom 200: General lighting.

Power Supply

The system can be powered by a remote power supply (not included) or by power supply equipments to be inserted in the track, which include a dimmable power supply.

The initial power connector has a space for cable insertion through both the upper and side parts. The power connector, middle power supply and 90° corners can be powered only from the back.

The maximum length of the track with the same driver is 10 meters.

Additional Information

Electrical system powered at 24Vdc and limited to a maximum current of 5A and a maximum power of 120W. IP20 protection grade.

Suitable for installation on normally inflammable surfaces.

Standard Compliance and Quality Marks

EN60598-1 European Technical Standards and any subsequent additions.

FLOS
CONTROL BY CASAMBI



HOW TO ORDER

1 CHOOSE YOUR PROFILE AND LENGTH

SURFACE PROFILE



L: 1 / 2 / 3 m



2 COMPLETE WITH MOUNTING ACCESSORIES

Feed connector



Right & Left

End cap



Intermediate Feed connector



Straight

Stopper



Intermediate connector



Feed 90° Corner



Feed Inner 90° Corner



Feed T piece



Feed Cross piece



3 SELECT POWER SUPPLY AND CONTROL OPTION

Recessed installation

remote driver



25W / 36W / 57W



120W

Non Dimmable / 1-10V



120W

Dali broadcast



+



or



Non Dimmable / 1-10V
25W / 36W / 57W

Dali
120W

Casambi broadcast



or



+

Casambi
integrated spots

Casambi individual

(select the driver with the appropriate power according to the needs of your project)

Surface installation



or



Non Dimmable / 1-10V



or

+

Casambi
integrated spots



Casambi individual

4 SELECT A LIGHT MODULE AND CONTROL OPTION

Standard /
Casambi Integrated (individual control)

Find Me 0



S/M

Atom 90



S/M

Find Me 1



S/M

Atom 120



S/M

Find Me 2



S/M/F

Atom 200



General Lighting

Find Me Suspension



S/M

ZERO TRACK SURFACE – PROFILES

Profili

Profilo elettromeccanico da interni per installazione a superficie (soffitto o parete). Da fissare con tappi a vite specifici forniti con il profilo. Disponibili lunghezze da 1m a 3m.

Il connettore di alimentazione, i connettori intermedi e i tappi vanno ordinati separatamente.

Disponibili connettori meccanici angolari complanari alimentabili a 90° e curvi (elemento simmetrico da sinistra e destra), connettori angolari di 90° con cambio di quota (parete-soffitto o parete-parete), e connettori a "T" e "X".

Disponibili elementi di connessione alimentabili complanari a 90° e curvi. Per installazioni verticali è necessario installare lo stopper, da ordinare separatamente.

Profiles

Electro-mechanical indoor profile for surface installation (ceiling or wall). To be fixed with specific screw plugs that come with the profile. 1-meter to 3-meters lengths.

It is necessary to order the power connector, intermediate connectors and covers separately.

Feed unit connectors available as 90° flat corner and curve (symmetric element for left/right corner), ceiling/wall - wall/wall inner corner, as well as "T" and "X" shape.

For vertical installations, installing the stopper is mandatory. It must be ordered separately.

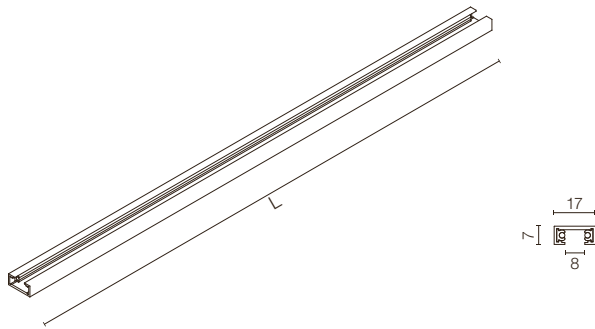

L: 1 m / 2 m / 3 m

L: 1000 mm	06.2500.40
	06.2500.06
	06.2500.14
	06.2500.CZ
	06.2500.18
L: 2000 mm	06.2501.40
	06.2501.06
	06.2501.14
	06.2501.CZ
	06.2501.18
L: 3000 mm	06.2502.40
	06.2502.06
	06.2502.14
	06.2502.CZ
	06.2502.18

Connettore di alimentazione per apparecchio remoto. Possibile entrata del cavo di alimentazione sia nella parte superiore che laterale.

Feed unit for remote power supply unit. Power cable inserting is possible both from the top and the side.

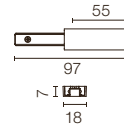

06.2540.40
06.2540.14
06.2540.CZ
06.2540.18

Connettore di alimentazione intermedio. Ingresso del cavo di alimentazione superiore.

Feed intermediate connector. Upper feeding cable entry.

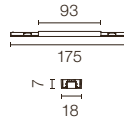

06.2541.40
06.2541.14
06.2541.CZ
06.2541.18

Angolo esterno.

Intermediate connector.

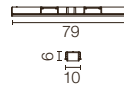

06.2506.40
06.2506.14

Angolo piatto 90°. Presenta uno spazio posteriore che rende possibile la connessione di alimentazione.

90° flat corner. Can be powered. It has a rear space for the supply connection.

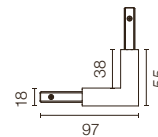

06.2542.40
06.2542.14
06.2542.CZ
06.2542.18

Angolo interno soffitto/parete - parete/parete. Presenta uno spazio posteriore su ogni lato che rende possibile la connessione di alimentazione.

Ceiling/wall - wall/wall inner corner. Can be powered. It has two spaces for the supply connection located on each side at the rear.

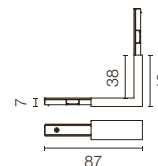

06.2543.40
06.2543.14
06.2543.CZ
06.2543.18

Curva interna soffitto/soffitto - parete/parete. Alimentabile dal retro.

Interior ceiling/ceiling-wall/ wall curve. Can be powered via connections on the back.

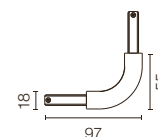

06.2544.40
06.2544.14
06.2544.CZ
06.2544.18

Connettore a forma di "T".
Alimentabile dal retro.

T-shaped connector. Can be
powered via connections on the
back.

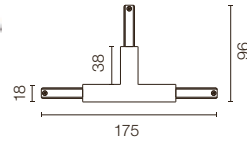

06.2545.40
06.2545.14
06.2545.CZ
06.2545.18

Connettore a forma di "X".
Alimentabile dal retro.

Cross-shaped connector. Can be
powered via connections on the
back.

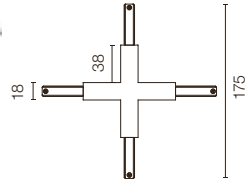

06.2546.40
06.2546.14
06.2546.CZ
06.2546.18

Terminale di chiusura.

End cap.



06.2509.40
06.2509.14
06.2509.CZ
06.2509.18

Stopper. Per fissaggio di
apparecchi di illuminazione su
guide verticali.

Stopper. For fixing luminaires in
vertical track installations.



08.0630.40
08.0630.14

ZERO TRACK – LIGHT MODULES

Find Me 0 Designed By Jorge Herrera

Light Source: Power LED 3,5W - 300 lm - 2700K/CRI 90 / 3,5W - 325 lm - 3000K/CRI 90

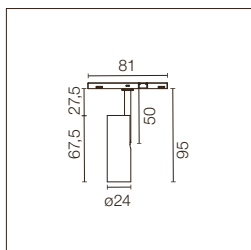

- GWT 850°
- 90°
- 360°
- 0,06 Kg
-
- IP 20
- 15°
- 25°
- 30°
- 45°
- 60°
- 90°
- 120°
- 150°
- 180°
- 225°
- 270°
- 315°
- 360°

Modulo di illuminazione LED d'accento, installabile sul sistema Zero Track.
 Convertitore elettronico DC/DC incorporato. Modulo controllato tramite driver 1-10V, DALI o Casambi in modalità broadcast. Dimmer non incluso.
 Per il controllo individuale degli apparecchi selezionare le versioni con Casambi integrato.
 Accessori inclusi (honeycomb e filtro a croce antiabbagliamento).

LED accent lighting module to be installed in the Zero Track system. Incorporated DC/DC electronic converter. Module regulated via 1–10-V DALI or Casambi driver in broadcast mode. Dimmer not included.
 To individually control the lights, select integrated Casambi versions. Accessories included (honeycomb and screening crosspiece).

- 2700K**
- 09.3801.40A
 - 09.3801.06A
 - 09.3801.14A
 - 09.3801.CZA
 - 09.3801.18A
- **Casambi integrated
- 09.3901.40A
 - 09.3901.06A
 - 09.3901.14A
 - 09.3901.CZA
 - 09.3901.18A

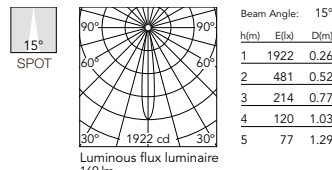

- 3000K**
- 09.3800.40A
 - 09.3800.06A
 - 09.3800.14A
 - 09.3800.CZA
 - 09.3800.18A
- **Casambi integrated
- 09.3900.40A
 - 09.3900.06A
 - 09.3900.14A
 - 09.3900.CZA
 - 09.3900.18A

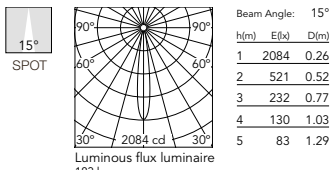

- 2700K**
- 09.3803.40A
 - 09.3803.06A
 - 09.3803.14A
 - 09.3803.CZA
 - 09.3803.18A
- **Casambi integrated
- 09.3903.40A
 - 09.3903.06A
 - 09.3903.14A
 - 09.3903.CZA
 - 09.3903.18A

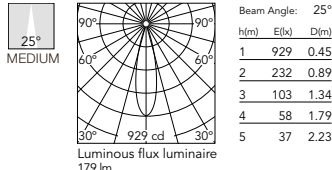

- 3000K**
- 09.3802.40A
 - 09.3802.06A
 - 09.3802.14A
 - 09.3802.CZA
 - 09.3802.18A
- **Casambi integrated
- 09.3902.40A
 - 09.3902.06A
 - 09.3902.14A
 - 09.3902.CZA
 - 09.3902.18A

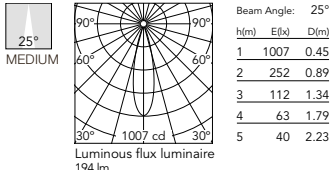

** Il sistema di controllo con apparecchi in versione Casambi si regola direttamente via bluetooth tramite la applicazione FLOS Control® powered by CASAMBI. Le altre regolazioni saranno di tipo broadcast (tutti i moduli luminosi si dimmerano insieme) / The control system with the Casambi version of light fixtures is directly and individually regulated wirelessly using the application FLOS Control® powered by Casambi. Other types of regulation are broadcast (all lights are regulated at the same time).

ZERO TRACK – LIGHT MODULES

Find Me 2 Designed By Jorge Herrera

Light Source: Power LED 10,5W* - 650 lm - 2700K/CRI90 / 10,5W* - 700 lm - 3000K/CRI90

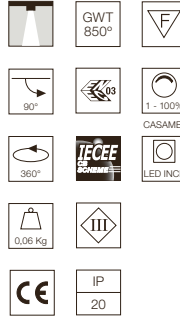
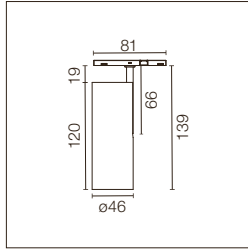

Modulo di illuminazione LED d'accento, installabile sul sistema Zero Track.

Convertitore elettronico DC/DC incorporato. Modulo controllato tramite driver 1-10V, DALI o Casambi in modalità broadcast. Dimmer non incluso.

Per il controllo individuale degli apparecchi selezionare le versioni con Casambi integrato.

Accessori inclusi (honeycomb e filtro a croce antiabbagliamento).

LED accent lighting module to be installed in the Zero Track system. Incorporated DC/DC electronic converter. Module regulated via 1–10-V DALI or Casambi driver in broadcast mode. Dimmer not included.

To individually control the lights, select integrated Casambi versions. Accessories included (honeycomb and screening crosspiece).

2700K

09.3862.40A
09.3862.06A*
09.3862.14A
09.3862.CZA
09.3862.18A

**Casambi integrated

09.3962.40A
09.3962.06A*
09.3962.14A
09.3962.CZA
09.3962.18A

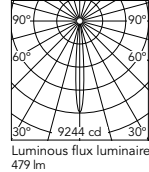

Beam Angle: 10°

h(m)	E(lx)	D(m)
1	9244	0.18
2	2311	0.35
3	1027	0.53
4	578	0.70
5	370	0.88

Luminous flux luminaire
479 lm**3000K**

09.3860.40A
09.3860.06A*
09.3860.14A
09.3860.CZA
09.3860.18A

**Casambi integrated

09.3960.40A
09.3960.06A*
09.3960.14A
09.3960.CZA
09.3960.18A

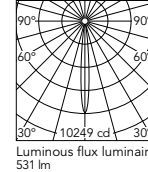

Beam Angle: 10°

h(m)	E(lx)	D(m)
1	10249	0.18
2	2562	0.35
3	1139	0.53
4	641	0.70
5	410	0.88

Luminous flux luminaire
531 lm**2700K**

09.3863.40A
09.3863.06A*
09.3863.14A
09.3863.CZA
09.3863.18A

**Casambi integrated

09.3963.40A
09.3963.06A*
09.3963.14A
09.3963.CZA
09.3963.18A

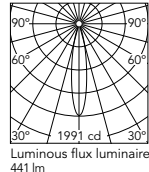

Beam Angle: 19°

h(m)	E(lx)	D(m)
1	1991	0.34
2	498	0.67
3	221	1.01
4	124	1.34
5	80	1.68

Luminous flux luminaire
441 lm**3000K**

09.3861.40A
09.3861.06A*
09.3861.14A
09.3861.CZA
09.3861.18A

**Casambi integrated

09.3961.40A
09.3961.06A*
09.3961.14A
09.3961.CZA
09.3961.18A

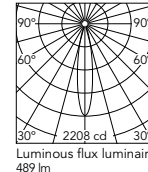

Beam Angle: 19°

h(m)	E(lx)	D(m)
1	2208	0.34
2	552	0.67
3	245	1.01
4	138	1.34
5	88	1.68

Luminous flux luminaire
489 lm**2700K**

09.3865.40A
09.3865.06A*
09.3865.14A
09.3865.CZA
09.3865.18A

**Casambi integrated

09.3965.40A
09.3965.06A*
09.3965.14A
09.3965.CZA
09.3965.18A

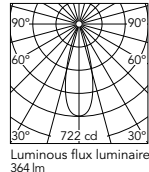

Beam Angle: 32°

h(m)	E(lx)	D(m)
1	722	0.57
2	180	1.15
3	80	1.72
4	45	2.29
5	29	2.87

Luminous flux luminaire
364 lm**3000K**

09.3864.40A
09.3864.06A*
09.3864.14A
09.3864.CZA
09.3864.18A

**Casambi integrated

09.3964.40A
09.3964.06A*
09.3964.14A
09.3964.CZA
09.3964.18A

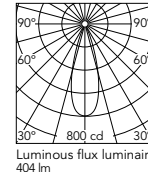

Beam Angle: 32°

h(m)	E(lx)	D(m)
1	800	0.57
2	200	1.15
3	89	1.72
4	50	2.29
5	32	2.87

Luminous flux luminaire
404 lm

* Per la finitura cromata la potenza è 8W. / For chrome finishes their power is 8W.

** Il sistema di controllo con apparecchi in versione Casambi si regola direttamente via bluetooth tramite la applicazione FLOS Control® powered by CASAMBI. Le altre regolazioni saranno di tipo broadcast (tutti i moduli luminosi si dimmerano insieme) / The control system with the Casambi version of light fixtures is directly and individually regulated wirelessly using the application FLOS Control® powered by Casambi. Other types of regulation are broadcast (all lights are regulated at the same time).

ZERO TRACK – LIGHT MODULES

Find Me 1 Suspension Designed By Jorge Herrera

Light Source: Power LED 5,5W - 450 lm - 2700K/CRI 90 / 5,5W - 485 lm - 3000K/CRI 90

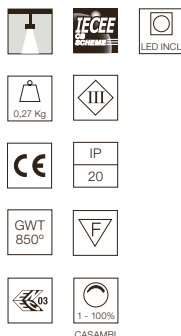
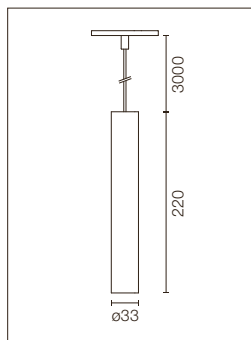

Modulo di illuminazione LED d'accento, installabile sul sistema Zero Track.
 Convertitore elettronico DC/DC incorporato. Modulo controllato tramite driver 1-10V, DALI o Casambi in modalità broadcast. Dimmer non incluso.
 Per il controllo individuale degli apparecchi selezionare le versioni con Casambi integrato.
 Non installabile su guide verticali. Accessori inclusi (honeycomb e filtro a croce antiabbagliamento).

LED accent lighting module to be installed in the Zero Track system. Incorporated DC/DC electronic converter. Module regulated via 1–10-V DALI or Casambi driver in broadcast mode. Dimmer not included.
 To individually control the lights, select integrated Casambi versions. Not suitable for vertical installations. Accessories included (honeycomb and screening crosspiece).

- 2700K**
- 09.3822.40A
 - 09.3822.06A
 - 09.3822.14A
 - 09.3822.CZA
 - 09.3822.18A
- **Casambi integrated
- 09.3922.40A
 - 09.3922.06A
 - 09.3922.14A
 - 09.3922.CZA
 - 09.3922.18A

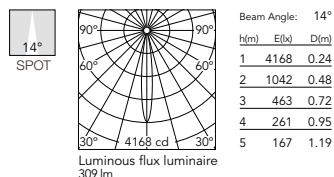

- 3000K**
- 09.3820.40A
 - 09.3820.06A
 - 09.3820.14A
 - 09.3820.CZA
 - 09.3820.18A
- **Casambi integrated
- 09.3920.40A
 - 09.3920.06A
 - 09.3920.14A
 - 09.3920.CZA
 - 09.3920.18A

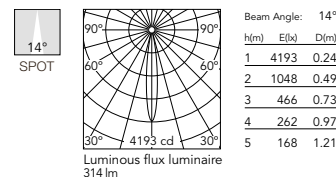

- 2700K**
- 09.3823.40A
 - 09.3823.06A
 - 09.3823.14A
 - 09.3823.CZA
 - 09.3823.18A
- **Casambi integrated
- 09.3923.40A
 - 09.3923.06A
 - 09.3923.14A
 - 09.3923.CZA
 - 09.3923.18A

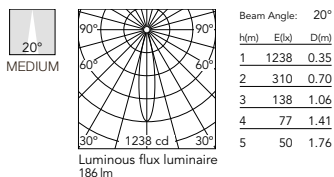

- 3000K**
- 09.3821.40A
 - 09.3821.06A
 - 09.3821.14A
 - 09.3821.CZA
 - 09.3821.18A
- **Casambi integrated
- 09.3921.40A
 - 09.3921.06A
 - 09.3921.14A
 - 09.3921.CZA
 - 09.3921.18A

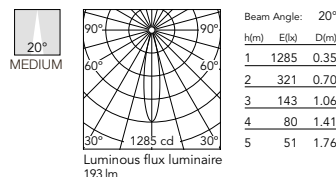

** Il sistema di controllo con apparecchi in versione Casambi si regola direttamente via bluetooth tramite la applicazione FLOS Control® powered by CASAMBI. Le altre regolazioni saranno di tipo broadcast (tutti i moduli luminosi si dimmerano insieme) / The control system with the Casambi version of light fixtures is directly and individually regulated wirelessly using the application FLOS Control® powered by Casambi. Other types of regulation are broadcast (all lights are regulated at the same time).

Atom 90 Designed By Piero Lissoni

Light Source: Power LED 5,5W* - 450 lm - 2700K/CRI 90 / 5,5W* - 485 lm - 3000K/CRI 90

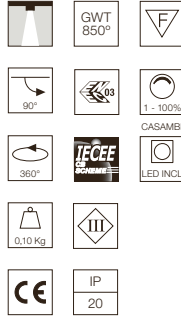
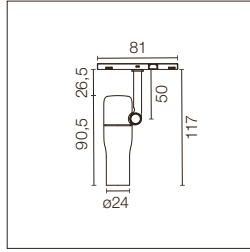

Modulo di illuminazione LED d'accento, installabile sul sistema Zero Track.

Convertitore elettronico DC/DC incorporato. Modulo controllato tramite driver 1-10V, DALI o Casambi in modalità broadcast. Dimmer non incluso.

Per il controllo individuale degli apparecchi selezionare le versioni con Casambi integrato. Accessori inclusi (honeycomb e filtro a croce antiabbagliamento).

LED accent lighting module to be installed in the Zero Track system. Incorporated DC/DC electronic converter. Module regulated via 1-10-V DALI or Casambi driver in broadcast mode. Dimmer not included.

To individually control the lights, select integrated Casambi versions. Accessories included (honeycomb and screening crosspiece).

2700K

- 09.3831.40A
- 09.3831.06A*
- 09.3831.14A
- 09.3831.CZA
- 09.3831.18A
- **Casambi integrated
- 09.3931.40A
- 09.3931.06A*
- 09.3931.14A
- 09.3931.CZA
- 09.3931.18A

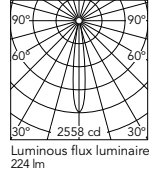

Beam Angle: 14°

h(m)	E(lx)	D(m)
1	2558	0.25
2	640	0.51
3	284	0.76
4	160	1.02
5	102	1.27

3000K

- 09.3830.40A
- 09.3830.06A*
- 09.3830.14A
- 09.3830.CZA
- 09.3830.18A
- **Casambi integrated
- 09.3930.40A
- 09.3930.06A*
- 09.3930.14A
- 09.3930.CZA
- 09.3930.18A

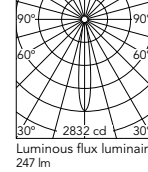

Beam Angle: 14°

h(m)	E(lx)	D(m)
1	2832	0.25
2	708	0.51
3	315	0.76
4	177	1.02
5	113	1.27

2700K

- 09.3833.40A
- 09.3833.06A*
- 09.3833.14A
- 09.3833.CZA
- 09.3833.18A
- **Casambi integrated
- 09.3933.40A
- 09.3933.06A*
- 09.3933.14A
- 09.3933.CZA
- 09.3933.18A

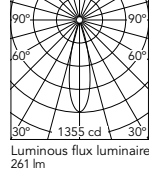

Beam Angle: 25°

h(m)	E(lx)	D(m)
1	1355	0.45
2	339	0.89
3	151	1.34
4	85	1.79
5	54	2.23

3000K

- 09.3832.40A
- 09.3832.06A*
- 09.3832.14A
- 09.3832.CZA
- 09.3832.18A
- **Casambi integrated
- 09.3932.40A
- 09.3932.06A*
- 09.3932.14A
- 09.3932.CZA
- 09.3932.18A

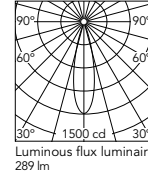

Beam Angle: 25°

h(m)	E(lx)	D(m)
1	1500	0.45
2	375	0.89
3	167	1.34
4	94	1.79
5	60	2.23

* Per la finitura cromata la potenza è 4,7W. / For chrome finishes their power is 4.7W.

** Il sistema di controllo con apparecchi in versione Casambi si regola direttamente via bluetooth tramite la applicazione FLOS Control® powered by CASAMBI. Le altre regolazioni saranno di tipo broadcast (tutti i moduli luminosi si dimmerano insieme) / The control system with the Casambi version of light fixtures is directly and individually regulated wirelessly using the application FLOS Control® powered by Casambi. Other types of regulation are broadcast (all lights are regulated at the same time).

ZERO TRACK – LIGHT MODULES

Atom 120 Designed By Piero Lissoni

Light Source: Power LED 8W* - 635 lm - 2700K/CRI 90 / 8W* - 680 lm - 3000K/CRI 90

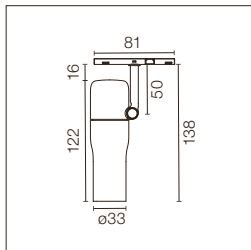

- GWT 850°
- F
- 90°
- 0.3
- 1 - 100%
- CASAMBI
- 360°
- IFCEE
- LED INCL
- 0,22 Kg
- III
- CE
- IP 20

Modulo di illuminazione LED d'accento, installabile sul sistema Zero Track.
Convertitore elettronico DC/DC incorporato. Modulo controllato tramite driver 1-10V, DALI o Casambi in modalità broadcast. Dimmer non incluso.
Per il controllo individuale degli apparecchi selezionare le versioni con Casambi integrato.
Accessori inclusi (honeycomb e filtro a croce antiabbagliamento).

LED accent lighting module to be installed in the Zero Track system. Incorporated DC/DC electronic converter. Module regulated via 1-10-V DALI or Casambi driver in broadcast mode. Dimmer not included.
To individually control the lights, select integrated Casambi versions. Accessories included (honeycomb and screening crosspiece).

2700K

- 09.3841.40A
- 09.3841.06A*
- 09.3841.14A
- 09.3841.CZA
- 09.3841.18A

**Casambi integrated

- 09.3941.40A
- 09.3941.06A*
- 09.3941.14A
- 09.3941.CZA
- 09.3941.18A

14° SPOT

Beam Angle: 14°

h(m)	E(lx)	D(m)
1	5843	0.24
2	1461	0.48
3	649	0.72
4	365	0.95
5	234	1.19

Luminous flux luminaire 5843 cd
433 lm

3000K

- 09.3840.40A
- 09.3840.06A*
- 09.3840.14A
- 09.3840.CZA
- 09.3840.18A

**Casambi integrated

- 09.3940.40A
- 09.3940.06A*
- 09.3940.14A
- 09.3940.CZA
- 09.3940.18A

14° SPOT

Beam Angle: 14°

h(m)	E(lx)	D(m)
1	5878	0.24
2	1469	0.49
3	653	0.73
4	367	0.97
5	235	1.21

Luminous flux luminaire 5878 cd
440 lm

2700K

- 09.3843.40A
- 09.3843.06A*
- 09.3843.14A
- 09.3843.CZA
- 09.3843.18A

**Casambi integrated

- 09.3943.40A
- 09.3943.06A*
- 09.3943.14A
- 09.3943.CZA
- 09.3943.18A

20° MEDIUM

Beam Angle: 20°

h(m)	E(lx)	D(m)
1	2557	0.35
2	639	0.70
3	284	1.06
4	160	1.41
5	102	1.76

Luminous flux luminaire 2557 cd
364 lm

3000K

- 09.3842.40A
- 09.3842.06A*
- 09.3842.14A
- 09.3842.CZA
- 09.3842.18A

**Casambi integrated

- 09.3942.40A
- 09.3942.06A*
- 09.3942.14A
- 09.3942.CZA
- 09.3942.18A

20° MEDIUM

Beam Angle: 20°

h(m)	E(lx)	D(m)
1	2624	0.35
2	656	0.70
3	292	1.06
4	164	1.41
5	105	1.76

Luminous flux luminaire 2624 cd
373 lm

Atom 200 Designed By Piero Lissoni

Light Source: Power LED 10,5W - 1050 lm - 2700K/CRI 90 / 10,5W - 1150 lm - 3000K/CRI 90

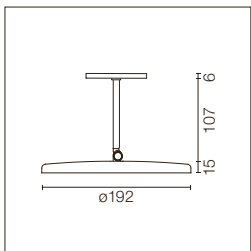

- GWT 850°
- F
- 90°
- 0.3
- 1 - 100%
- CASAMBI
- 360°
- IFCEE
- LED INCL
- 0,47 Kg
- III
- CE
- IP 20

Modulo di illuminazione LED generale, installabile sul sistema Zero Track.
Convertitore elettronico DC/DC incorporato. Modulo controllato tramite driver 1-10V, DALI o Casambi in modalità broadcast. Dimmer non incluso.
Per il controllo individuale degli apparecchi selezionare le versioni con Casambi integrato.
Non installabile su guide verticali.

LED general lighting module to be installed in the Zero Track system. Incorporated DC/DC electronic converter. Module regulated via 1-10-V DALI or Casambi driver in broadcast mode. Dimmer not included.
To individually control the lights, select integrated Casambi versions. Not suitable for vertical installations.

2700K

- 09.3851.40
- 09.3851.06
- 09.3851.14
- 09.3851.CZ
- 09.3851.18

**Casambi integrated

- 09.3951.40
- 09.3951.06
- 09.3951.14
- 09.3951.CZ
- 09.3951.18

110°

Beam Angle: 110°

h(m)	E(lx)	D(m)
1	145	2.86
2	36	5.73
3	16	8.59
4	9	11.45
5	6	14.32

Luminous flux luminaire 145 cd
395 lm

3000K

- 09.3850.40
- 09.3850.06
- 09.3850.14
- 09.3850.CZ
- 09.3850.18

**Casambi integrated

- 09.3950.40
- 09.3950.06
- 09.3950.14
- 09.3950.CZ
- 09.3950.18

110°

Beam Angle: 110°

h(m)	E(lx)	D(m)
1	156	2.86
2	39	5.73
3	17	8.59
4	10	11.45
5	6	14.32

Luminous flux luminaire 156 cd
424 lm

* Per la finitura cromata la potenza è 6W. / For chrome finishes their power is 6W.

** Il sistema di controllo con apparecchi in versione Casambi si regola direttamente via bluetooth tramite la applicazione FLOS Control® powered by CASAMBI. Le altre regolazioni saranno di tipo broadcast (tutti i moduli luminosi si dimmerano insieme) / The control system with the Casambi version of light fixtures is directly and individually regulated wirelessly using the application FLOS Control® powered by Casambi. Other types of regulation are broadcast (all lights are regulated at the same time).

Driver / Drivers

1-10V Broadcast / Non Dimmable

Surface Installation

Fonte di alimentazione finale per installazione a superficie. Regolabile mediante protocollo 1/10V o non regolabile. Non installabile su guide a parete. Intervallo di dimmerazione 20-100%.

Power supply surface end. Dimmable through 1/10V protocol or Non Dimmable. Cannot be installed on wall tracks. Dimming range 20-100%.

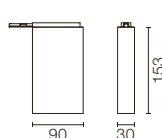

57W - 220/240V
06.2510.40
06.2510.06
06.2510.14
06.2510.CZ
06.2510.18

1-10V Broadcast / Non Dimmable

Surface Installation

Fonte di alimentazione intermedia per installazione a superficie. Regolabile mediante protocollo 1/10V o non regolabile. Non installabile su guide a parete. Intervallo di dimmerazione 20-100%.

Power supply surface middle. Dimmable through 1/10V protocol or Non Dimmable. Not suitable for wall installations. Dimming range 20-100%.

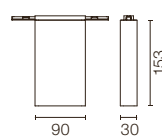

57W - 220/240V
06.2511.40
06.2511.06
06.2511.14
06.2511.CZ
06.2511.18

Non Dimmable

Remote Installation

Fonte di alimentazione remota. Non regolabile. 220/240V.

Remote power supply. Non Dimmable. 220/240V.

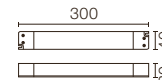

120W - 220/240V
60.9516

1-10V Broadcast / Non Dimmable

Remote Installation

Fonte di alimentazione remota. Regolabile mediante protocollo 1/10V o non regolabile. Intervallo di dimmerazione 20-100%.

Remote power supply. Dimmable through 1/10V protocol or Non Dimmable. Dimming range 20-100%.

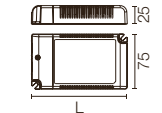

25W - 110/240V - L:110
RF28210
36W-110V / 45W-240V - L:120
RF28211
57W - 220/240V - L:130
RF28212

1-10V Broadcast / Non Dimmable

Remote Installation

Fonte di alimentazione remota. Regolabile mediante protocollo 1/10V o non regolabile. Intervallo di dimmerazione 20-100%.

Remote power supply. Dimmable through 1/10V protocol or Non Dimmable. Dimming range 20-100%.

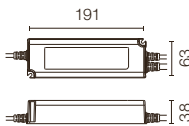

120W - 110*/240V
60.9416
*UL max 100W

DALI

Remote Installation

Fonte di alimentazione remota. Regolabile mediante protocollo DALI. Intervallo di dimmerazione 10-100%.

Remote power supply. Dimmable through DALI protocol. Dimming range 10-100%.

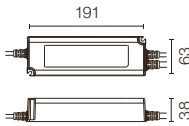

120W - 110*/240V
60.9426
*UL max 100W

Casambi

Remote Installation

Driver Casambi 220-240V. È necessario 1-10V o driver Dali, da ordinare separatamente. Intervallo di dimmerazione 10-100%.

Casambi controller 220-240V. Requires 1-10V or Dali driver. It must be ordered separately. Dimming range 10-100%.

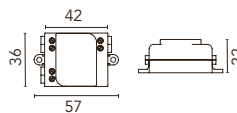

60.9392

Track Length (m)	% Driver Nominal Power
1	95
2	95
3	95
4	95
5	95
6	93
7	91
8	89
9	87
10	85

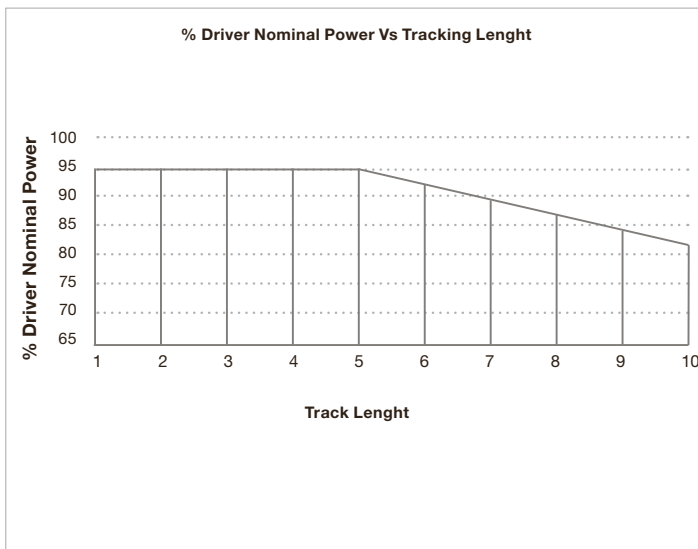

Example:

Ref. 60.9361: 57W / 4 m track
57W x 0,95 = 54,15W available

	W luminary	N° luminaries	W luminaries
Find Me 0	3,5	3	10,5
Find Me 1	5,5	0	0
Find Me 2	10,5	0	0
Atom 90	5,5	3	16,5
Atom 120	8	2	16
Atom 200	10,5	1	10,5
Total system power: 53,5W			

Remote Driver Installations - Broadcast

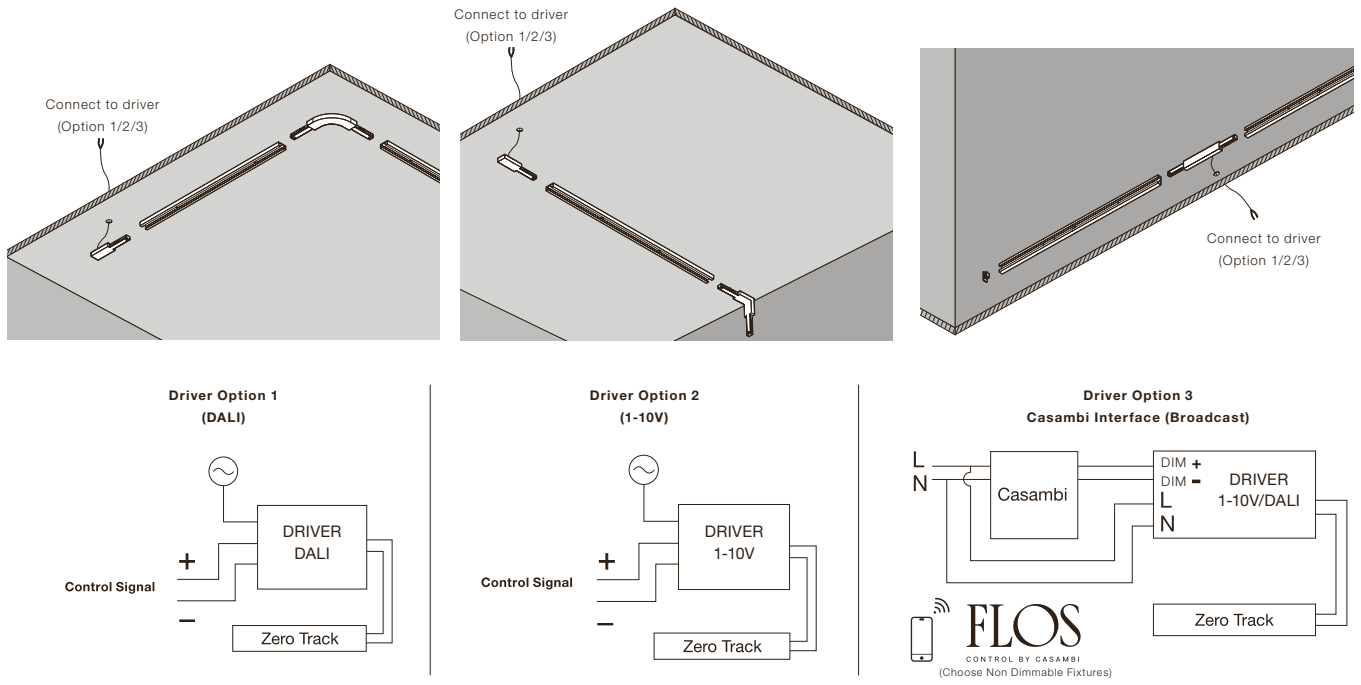

Surface Driver Installations - Broadcast

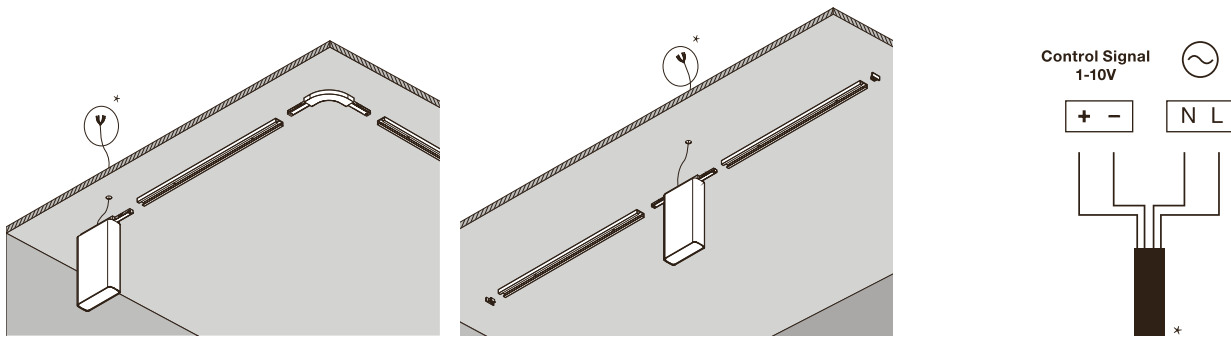

Individual Control Casambi Bluetooth



THE MICRO RUNNING MAGNET

DESIGNED BY FLOS ARCHITECTURAL

RECESSED

SURFACE



Recessed Profiles 14 Nero
 14 Black

Surface Profiles 40 Bianco
 40 White
 14 Nero
 14 Black

LIGHT MODULES

NANO SPOT



LIGHT SOURCE
 POWER LED
 2W
 165 lm
 2700K/CRI 90
 170 lm
 3000K/CRI 90
 185 lm
 4000K/CRI 90
 200 lm
 5000K/CRI 90

MICRO SPOT



LIGHT SOURCE
 POWER LED
 3W
 275 lm
 2700K/CRI 90
 295 lm
 3000K/CRI 90
 315 lm
 4000K/CRI 90
 335 lm
 5000K/CRI 90

SPOT



LIGHT SOURCE
 POWER LED
 6W
 545 lm
 2700K/CRI 90
 585 lm
 3000K/CRI 90
 625 lm
 4000K/CRI 90
 665 lm
 5000K/CRI 90

LIGHT SHADOW
SPOT

LIGHT SOURCE
 POWER LED
 3W
 270 lm
 2700K/CRI 90
 285 lm
 3000K/CRI 90
 300 lm
 4000K/CRI 90
 320 lm
 5000K/CRI 90

LIGHT STRIPE
DIFFUSEDLIGHT STRIPE
WALL-WASHER

LIGHT SOURCE
 TOP LED
 15W/m
 1440 lm/m
 2700K/CRI 90
 1550 lm/m
 3000K/CRI 90
 1660 lm
 4000K/CRI 90
 1775 lm
 5000K/CRI 90

Descrizione

Innovativo programma di strutture ultraminiaturizzate in versione a incasso e superficie. Compatibile con un'ampia gamma di soluzioni di illuminazione professionali mediante fissaggio magnetico. La soluzione definitiva per l'illuminazione espositiva.

Un programma completo e professionale che al di là delle dimensioni ridotte garantisce una luce equilibrata e attraente capace di risaltare ogni oggetto nel miglior modo a 360°.

La quintessenza della luce integrata, ottenuta grazie ad un profilo di soli 5mm che permette la totale integrazione di micro apparecchi progettati per fondersi con la struttura fin quasi a scomparire.

Le incredibili dimensioni ridotte del profilo che caratterizza il programma esaltano la flessibilità della luce e il suo rapporto con l'architettura. L'installazione dei corpi illuminanti avviene tramite supporto magnetico all'interno del profilo per una semplicità d'uso senza eguali.

Fissaggio magnetico degli apparecchi di illuminazione, che consente la manipolazione a caldo. I corpi illuminanti si possono orientare da accesi ottenendo enorme flessibilità e adattabilità della configurazione in qualunque momento. Tutti i profili strutturali di Micro Running Magnet sono fabbricati con alluminio estruso bianco o nero, provvisto di circuito elettrico alimentato a 24V, sul quale si installano le unità luminose a LED compatibili tramite un sistema di fissaggio magnetico.

Gamma completa di proiettori disponibile in varie potenze e dimensioni. Tutti i prodotti includono micro lenti professionali stabilizzate in acrilico per un controllo massimo degli effetti luminosi.

Controllo:

- DALI: controllo remoto in broadcast (dimmerazione di tutte le unità luminose in gruppo).

- 1/10V: controllo remoto in broadcast (dimmerazione di tutte le unità luminose in gruppo).

- Casambi: controllo remoto in broadcast tramite applicazione dedicata FLOS Control®.

App necessaria per i dispositivi mobili (disponibile su Apple Store e Google Play).

Sistema Ottico

Unità luminose d'accento disponibili con ottica intensiva (Lente Spot) e con ottica estensiva (Lente Medium, Flood e Wide Flood). Moduli di illuminazione lineare con emissione diretta diffusa o wall-washer, disponibile in varie lunghezze da 300mm fino a 1200mm.

Unità di alimentazione

Unità di alimentazione remota 24V non inclusa.

Informazioni Aggiuntive

The Micro Running Magnet è un sistema elettrico alimentato a 24V e limitato ad una corrente massima di 5A e 120W per evitare sovraccarico. Ogni volta che si raggiungono 120W di carico è necessario realizzare una nuova connessione tramite un profilo di alimentazione.

Indice di protezione IP20.

Installabile su superfici normalmente infiammabili.

Raccomandato per l'installazione su superfici in cartongesso di 12,5 mm di spessore per la versione da incasso.

Conformità e Marchi di Qualità

Apparecchio conforme alla Normativa Tecnica Europea EN60598-1 e relative parti seconde.

Description

Innovative program of ultra-miniaturized structures in recessed and surface versions. Compatible with a wide range of professional lighting solutions by means of magnetic fixing. The Micro Running Magnet is the ultimate solution for exhibition lighting. A complete and professional program that, in addition to its reduced dimensions, provides a balanced and attractive light to highlight each object in the best way and in 360°.

The quintessence of integrated light obtained thanks to a profile of only 5 mm that allows the total integration of micro-devices designed to be combined with the structure until they disappear almost completely.

The incredibly small profile size that characterizes the program enhances the light's flexibility and its relationship with the architecture. The lighting bodies are installed by means of a magnetic support inside the profile, providing an unparalleled ease of use.

Magnetic fixing of the luminaries, which allows hot handling. The lighting bodies can be orientated when they are still on, achieving enormous flexibility and adaptability in the configuration at any time. The profile of all The Micro Running Magnet structural tracks is extruded aluminum, painted black or white, housing a graphite electric track fed at 24V, on which all magnetic luminaries are installed simply by insertion.

Complete range of micro-projectors available in various powers and sizes. They all include professional acrylic stabilized micro-lenses for a maximum control of lighting effects.

Control

- DALI: broadcasting remote control (dimming of all the luminaires in a single group).

- 1/10V: broadcasting remote control (dimming of all the luminaires in a single group).

- Casambi: broadcast control through a tablet or smartphone application (FLOS Control®).

App needed for mobile devices (available in Apple Store y Google Play).

Optic system

The accent light modules are available with intensive optics (spot lens) and extensive optics (medium, flood and wide flood lens). Linear lighting modules with direct diffused or wall-washer light emission, available in different lengths from 300mm up to 1200mm.

Power Supply

Remote 24V power supply not included.

Additional Information

The Micro Running Magnet is a 24V electrical system limited to a maximum power current of 5A and 120W to avoid overloads. After every 120W make a new connection with a feed unit profile.

IP20 protection grade.

Suitable for installation on normally inflammable surfaces.

For Recessed version, installation on 12.5 mm-thick plasterboard surfaces is recommended.

Compliance of Standards and Quality Marks

EN60598-1 European Technical Standards and any subsequent additions

FLOS
CONTROL BY CASAMBI



HOW TO ORDER

1 CHOOSE YOUR PROFILE AND LENGTH

RECESSED PROFILE

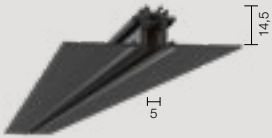

L: 1 / 1,5 / 2 / 2,5 / 3 m

2 COMPLETE WITH MOUNTING ACCESSORIES

Feed connector



Intermediate connector



Straight

End cap



90° Corner



Electrical / Mechanical joint

Inner corner



Electrical / Mechanical joint

3 SELECT POWER SUPPLY

Recessed installation
Remote power supply



25W / 45W / 75W

or



120W

1/10V or Non Dimmable

(select the driver with the appropriate power according to the needs of your project)



120W

Dali broadcast



25W / 45W / 75W

or



120W

Casambi broadcast

(select the driver with the appropriate power according to the needs of your project)

SURFACE/SUSPENSION DOWN PROFILE

L: 1 / 1,5 / 2 / 2,5 / 3 m

2 COMPLETE WITH MOUNTING ACCESSORIES

Feed connector

Intermediate connector

Straight

End cap

90° Corner

Electrical / Mechanical

Inner corner

Electrical / Mechanical

3 SELECT POWER SUPPLY

Recessed installation
Remote power supply

25W / 45W / 75W

or

120W

1/10V or Non Dimmable

(select the driver with the appropriate power according to the needs of your project)

120W

Dali broadcast

25W / 45W / 75W

or

120W

Casambi broadcast

(select the driver with the appropriate power according to the needs of your project)

THE MICRO RUNNING MAGNET

4 SELECT A LIGHT MODULE

Light Stripe Diffused



L: 300 mm / 600 mm / 900 mm / 1200 mm



General lighting

Light Stripe Wall-Washer



L: 300 mm / 600 mm / 900 mm / 1200 mm



Wall-Washer

Nano Spot



M/F

Micro Spot



S/M/F

Spot



S/M

Light Shadow Spot



S/M/F/WF

THE MICRO RUNNING MAGNET RECESSED – PROFILES

Profili

Profilo elettromeccanico di dimensioni ridottissime per installazione ad incasso su soffitti e pareti di cartongesso disponibile con lunghezze da 1 a 3m.

Accessori di fissaggio inclusi con i profili.

Angoli di 90° disponibili nello stesso piano (elemento simmetrico per angolo destro e sinistro).

Profiles

Electromechanical profile of reduced size for recessed installation in plasterboard ceilings/walls with lengths from 1 to 3 m.

Fastening accessories included with the profiles.

90° corners available in the same plane (symmetrical element for left and right corners).

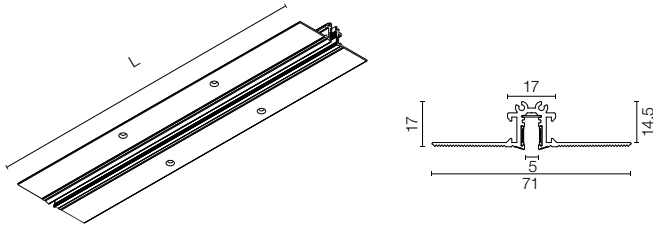

L: 1 m / 1,5 m / 2m / 2,5m / 3 m

- L: 1000 mm 06.6000.14
- L: 1500 mm 06.6001.14
- L: 2000 mm 06.6002.14
- L: 2500 mm 06.6003.14
- L: 3000 mm 06.6004.14

Angolo 90°.
Collegamento elettrico/meccanico.
Non alimentabile. Gli apparecchi non possono essere montati sugli angoli.

90° Corner.
Electrical/mechanical connection.
Non-feedable. Luminaires cannot be located on corners.

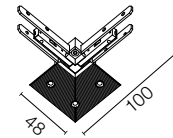

■ 06.6030.14

Angolo interno.
Collegamento elettrico/meccanico.
Non alimentabile. Gli apparecchi non possono essere montati sugli angoli.

Inner corner.
Electrical/mechanical connection.
Non-feedable. Luminaires cannot be located on corners.

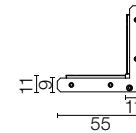

■ 06.6032.14

Connettore di alimentazione.
Cavo da 2m incluso.
Collegamento elettrico. Gli apparecchi non possono essere montati sul connettore.

Feed connector.
2m cable included.
Electrical connection. Luminaires cannot be located in the connector.

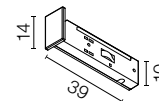

■ 06.6034.14

Connettore intermedio.
Collegamento elettrico. Gli apparecchi non possono essere montati sul connettore.

Intermediate connector.
Electrical connection. Luminaires cannot be located in the connector.

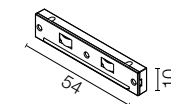

■ 06.6035.14

Terminale di chiusura. Kit di 1 unità.

End cap. 1 unit kit.



■ 06.6036.14

Profili

Profilo elettromeccanico di dimensioni ridottissime per installazione in superficie (soffitto o parete) disponibile con lunghezze da 1 a 3m.
 Accessori di fissaggio inclusi con i profili.
 Angoli di 90° disponibili nello stesso piano (elemento simmetrico per angolo destro e sinistro).
 La parte interna del profilo è fornita sempre nera.

Profiles

Electromechanical profile of reduced size for installation on surfaces (ceiling or wall) with lengths from 1 to 3 m.
 Fastening accessories included with the profiles.
 90° corners available in the same plane (symmetrical element for left and right corners).
 The inner part of the profile is always supplied in black.

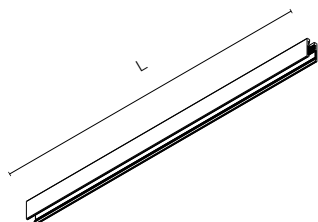

L: 1 m / 1,5 m / 2m / 2,5m / 3 m

- L: 1000 mm
 - 06.6010.40
 - 06.6010.14
- L: 1500 mm
 - 06.6011.40
 - 06.6011.14
- L: 2000 mm
 - 06.6012.40
 - 06.6012.14
- L: 2500 mm
 - 06.6013.40
 - 06.6013.14
- L: 3000 mm
 - 06.6014.40
 - 06.6014.14

Angolo 90°.
 Collegamento elettrico/meccanico.
 Non alimentabile. Gli apparecchi non possono essere montati sugli angoli.

90° Corner.
 Electrical/mechanical connection.
 Non-feedable. Luminaires cannot be located on corners.

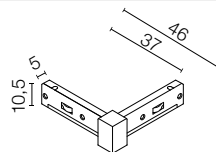

- 06.6031.40
- 06.6031.14

Angolo interno.
 Collegamento elettrico/meccanico.
 Non alimentabile. Gli apparecchi non possono essere montati sugli angoli.

Inner corner.
 Electrical/mechanical connection.
 Non-feedable. Luminaires cannot be located on corners.

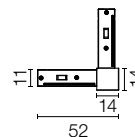

- 06.6033.40
- 06.6033.14

Connettore di alimentazione.
 Cavo da 2m incluso.
 Collegamento elettrico. Gli apparecchi non possono essere montati sul connettore.

Feed connector.
 2m cable included.
 Electrical connection. Luminaires cannot be located in the connector.

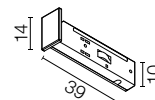

- 06.6034.40
- 06.6034.14

Connettore intermedio.
 Collegamento elettrico. Gli apparecchi non possono essere montati sul connettore.

Intermediate connector.
 Electrical connection. Luminaires cannot be located in the connector.

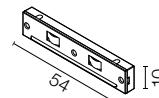

- 06.6035.14

Terminale di chiusura. Kit di 1 unità.

End cap. 1 unit kit.



- 06.6036.40
- 06.6036.14

THE MICRO RUNNING MAGNET – INSTALLATION PROFILES

SURFACE INSTALLATION

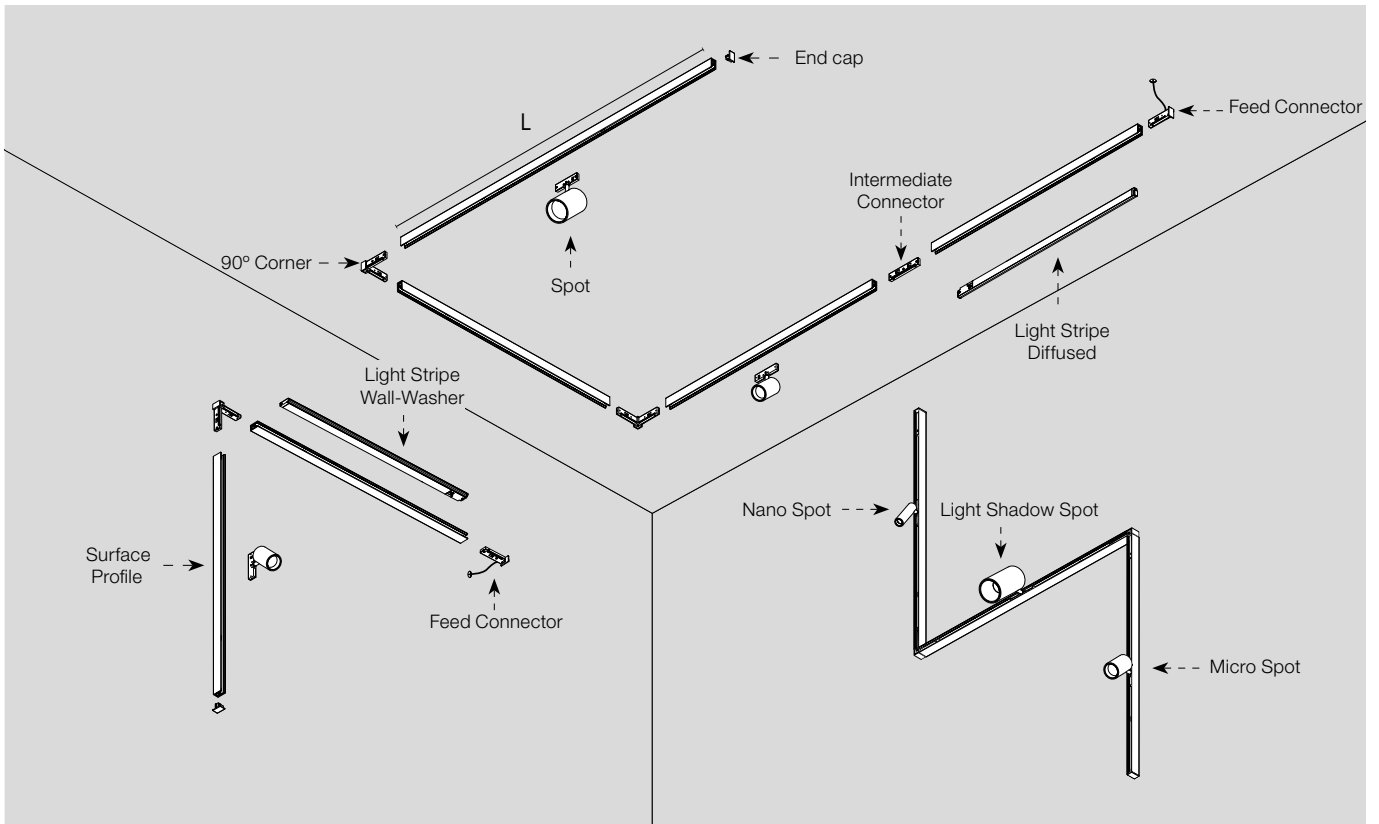

RECESSED INSTALLATION

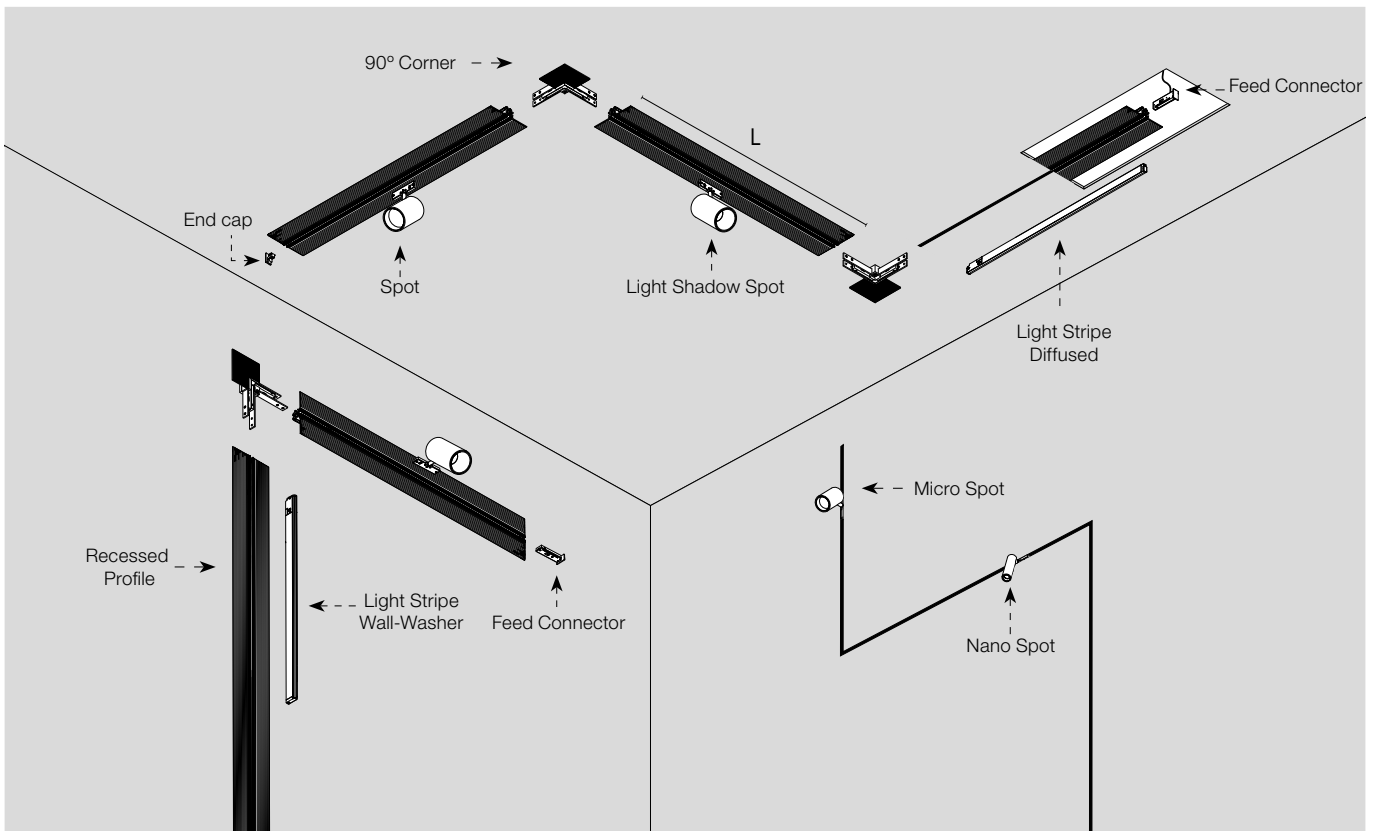

• **Posso tagliare i profili?**

Sì, i profili si possono tagliare in qualsiasi punto e la connessione elettrica può essere ripristinata grazie al connettore intermedio disponibile come accessorio.

• **Can I cut the profiles?**

Yes. The profiles can be cut at any point and the electrical connection continued using the intermediate connector.

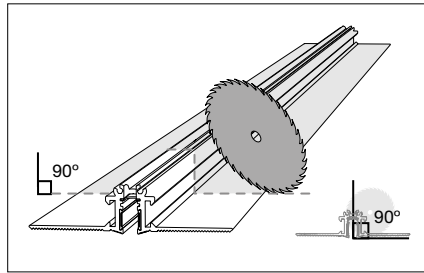

• **Posso installare un proiettore negli angoli o tra due profili?**

No, i pezzi angolari non hanno spazio libero per alloggiare gli apparecchi, l'angolo e i giunti tra i profili contengono le connessioni elettriche, funzionando come connettori intermedi.

• **Can I place a spotlight in the corners or between two profiles?**

No, the corner pieces have no free space for luminaires, the corner and the joints between profiles contain the electrical connections as intermediate connectors.

• **È possibile regolare l'intensità degli apparecchi individualmente?**

No, utilizzando i driver consigliati è possibile dimmerare il sistema ma gli apparecchi saranno dimmerati sempre tutti insieme.

• **Can I dim the luminaires individually?**

No. By using the recommended equipment, they can be adjusted, but all at once.

• **Qual è la lunghezza massima che si può alimentare in una struttura con un singolo driver?**

La massima lunghezza alimentabile di un profilo è pari a 10 metri.

• **What is the maximum length that can be powered with one power supply on a structure?**

The maximum length of a profile that can be powered with one power source is 10 metres.

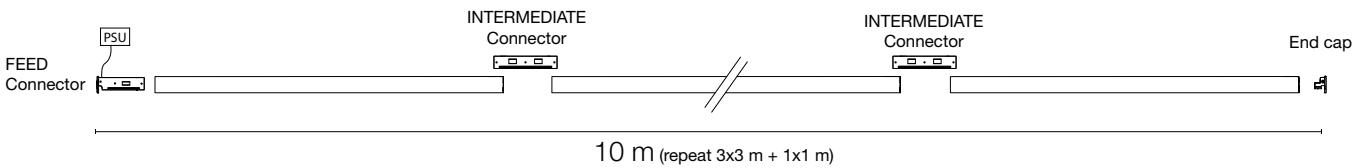

• **È possibile alimentare la struttura da un modulo angolare o da un connettore intermedio?**

No, gli angoli ed i connettori intermedi del sistema non sono alimentabili.

• **Can I power a structure from a corner or intermediate connector?**

No. The corners and intermediate connector of this system cannot be powered.

THE MICRO RUNNING MAGNET – LIGHT MODULES

Light Stripe Diffused

Light Source: Top LED 15W/m - 1440 lm/m - 2700K/CRI 90 / 15W/m - 1550 lm/m - 3000K/CRI 90 / 15W/m - 1660 lm/m - 4000K/CRI 90 / 15W/m - 1775 lm/m - 5000K/CRI 90

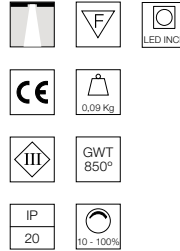
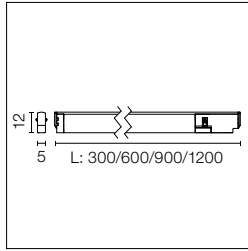

Modulo di illuminazione a LED con emissione di luce diffusa compatibile con The Micro Running System. Convertitore elettronico di corrente DC/DC integrato.

Diffused LED light module to be installed in The Micro Running Magnet System. Built-in DC/DC electronic voltage converter.

2700K
L: 300 mm - 4,5W
03.2260.14

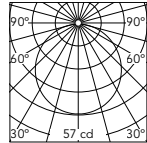

Beam Angle: 114°

h(m)	E(lx)	D(m)
1	57	3.11
2	14	6.21
3	6	9.32
4	4	12.43
5	2	15.53

Luminous flux luminaire 205 lm

2700K
L: 600 mm - 9W
03.2264.14

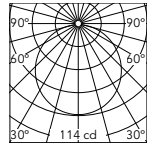

Beam Angle: 114°

h(m)	E(lx)	D(m)
1	114	3.11
2	29	6.21
3	13	9.32
4	7	12.43
5	5	15.53

Luminous flux luminaire 411 lm

2700K
L: 900 mm - 13,5W
03.2268.14

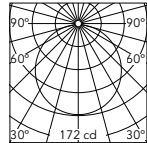

Beam Angle: 114°

h(m)	E(lx)	D(m)
1	172	3.11
2	43	6.21
3	19	9.32
4	11	12.43
5	7	15.53

Luminous flux luminaire 616 lm

2700K
L: 1200 mm - 18W
03.2272.14

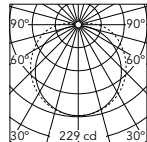

Beam Angle: 114°

h(m)	E(lx)	D(m)
1	229	3.11
2	57	6.21
3	25	9.32
4	14	12.43
5	9	15.53

Luminous flux luminaire 821 lm

4000K
L: 300 mm - 4,5W
03.2262.14

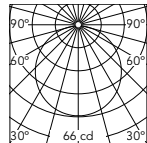

Beam Angle: 114°

h(m)	E(lx)	D(m)
1	66	3.11
2	16	6.21
3	7	9.32
4	4	12.43
5	3	15.53

Luminous flux luminaire 237 lm

4000K
L: 600 mm - 9W
03.2266.14

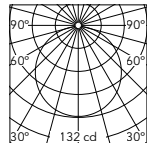

Beam Angle: 114°

h(m)	E(lx)	D(m)
1	132	3.11
2	33	6.21
3	15	9.32
4	8	12.43
5	5	15.53

Luminous flux luminaire 473 lm

4000K
L: 900 mm - 13,5W
03.2270.14

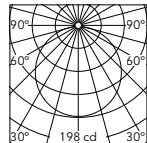

Beam Angle: 114°

h(m)	E(lx)	D(m)
1	198	3.11
2	49	6.21
3	22	9.32
4	12	12.43
5	8	15.53

Luminous flux luminaire 710 lm

4000K
L: 1200 mm - 18W
03.2274.14

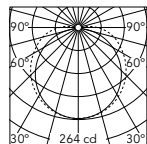

Beam Angle: 114°

h(m)	E(lx)	D(m)
1	264	3.11
2	66	6.21
3	29	9.32
4	16	12.43
5	11	15.53

Luminous flux luminaire 947 lm

3000K
L: 300 mm - 4,5W
03.2261.14

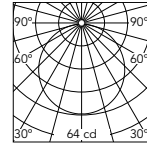

Beam Angle: 114°

h(m)	E(lx)	D(m)
1	64	3.11
2	16	6.21
3	7	9.32
4	4	12.43
5	3	15.53

Luminous flux luminaire 230 lm

3000K
L: 600 mm - 9W
03.2265.14

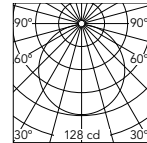

Beam Angle: 114°

h(m)	E(lx)	D(m)
1	128	3.11
2	32	6.21
3	14	9.32
4	8	12.43
5	5	15.53

Luminous flux luminaire 460 lm

3000K
L: 900 mm - 13,5W
03.2269.14

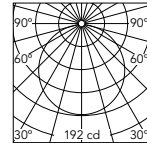

Beam Angle: 114°

h(m)	E(lx)	D(m)
1	192	3.11
2	48	6.21
3	21	9.32
4	12	12.43
5	8	15.53

Luminous flux luminaire 689 lm

3000K
L: 1200 mm - 18W
03.2273.14

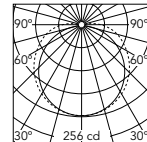

Beam Angle: 114°

h(m)	E(lx)	D(m)
1	256	3.11
2	64	6.21
3	28	9.32
4	16	12.43
5	10	15.53

Luminous flux luminaire 919 lm

5000K
L: 300 mm - 4,5W
03.2263.14

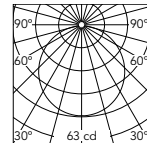

Beam Angle: 114°

h(m)	E(lx)	D(m)
1	63	3.11
2	16	6.21
3	7	9.32
4	4	12.43
5	3	15.53

Luminous flux luminaire 226 lm

5000K
L: 600 mm - 9W
03.2267.14

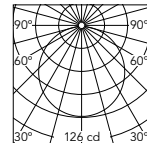

Beam Angle: 114°

h(m)	E(lx)	D(m)
1	126	3.11
2	31	6.21
3	14	9.32
4	8	12.43
5	5	15.53

Luminous flux luminaire 452 lm

5000K
L: 900 mm - 13,5W
03.2271.14

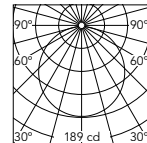

Beam Angle: 114°

h(m)	E(lx)	D(m)
1	189	3.11
2	47	6.21
3	21	9.32
4	12	12.43
5	8	15.53

Luminous flux luminaire 678 lm

5000K
L: 1200 mm - 18W
03.2275.14

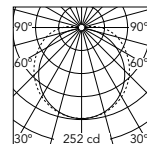

Beam Angle: 114°

h(m)	E(lx)	D(m)
1	252	3.11
2	63	6.21
3	28	9.32
4	16	12.43
5	10	15.53

Luminous flux luminaire 904 lm

Light Stripe Wall-Washer

Light Source: Top LED 15W/m - 1440 lm/m - 2700K/CRI 90 / 15W/m - 1550 lm/m - 3000K/CRI 90 / 15W/m - 1660 lm/m - 4000K/CRI 90 / 15W/m -1775 lm/m - 5000K/CRI 90

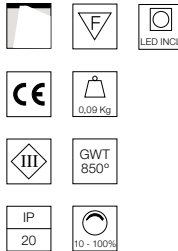
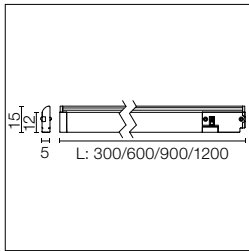

Modulo di illuminazione a LED con emissione asimmetrica wall-washer compatibile con The micro Running System. Convertitore elettronico di corrente DC/DC integrato.

Asymmetric wall-washer LED light module to be installed in The Micro Running Magnet System. Built-in DC/DC electronic voltage converter.

2700K
L: 300 mm - 4,5W
03.2280.14

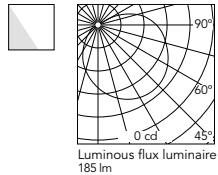

3000K
L: 300 mm - 4,5W
03.2281.14

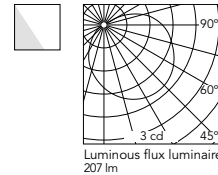

2700K
L: 600 mm - 9W
03.2284.14

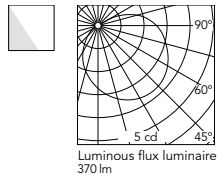

3000K
L: 600 mm - 9W
03.2285.14

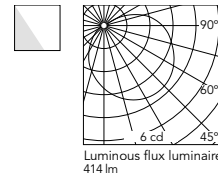

2700K
L: 900 mm - 13,5W
03.2288.14

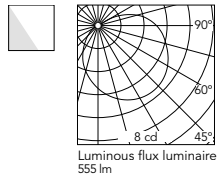

3000K
L: 900 mm - 13,5W
03.2289.14

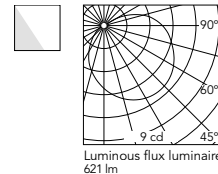

2700K
L: 1200 mm - 18W
03.2292.14

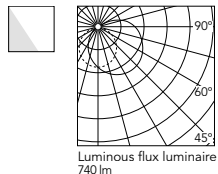

3000K
L: 1200 mm - 18W
03.2293.14

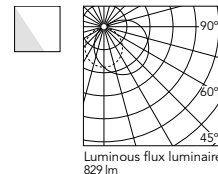

4000K
L: 300 mm - 4,5W
03.2282.14

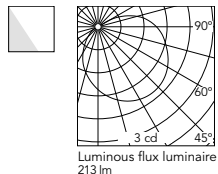

5000K
L: 300 mm - 4,5W
03.2283.14

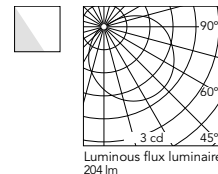

4000K
L: 600 mm - 9W
03.2286.14

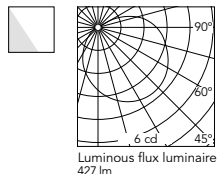

5000K
L: 600 mm - 9W
03.2287.14

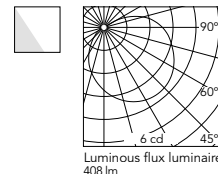

4000K
L: 900 mm - 13,5W
03.2290.14

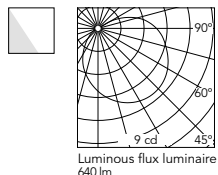

5000K
L: 900 mm - 13,5W
03.2291.14

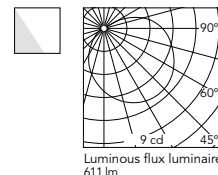

4000K
L: 1200 mm - 18W
03.2294.14

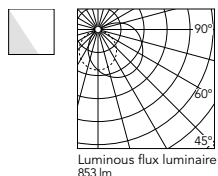

5000K
L: 1200 mm - 18W
03.2295.14

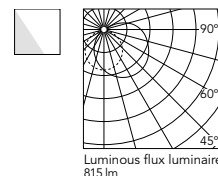

THE MICRO RUNNING MAGNET – LIGHT MODULES

Nano Spot

Light Source: Power LED 2W - 165 lm - 2700K/CRI 90 / 2W - 170 lm - 3000K/CRI 90 / 2W - 185 lm - 4000K/CRI 90 / 2W - 200 lm - 5000K/CRI 90

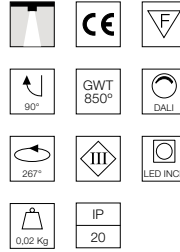
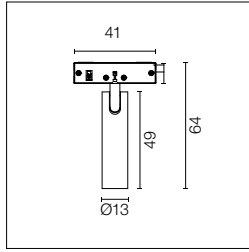

Modulo di illuminazione LED d'accento da installare nel sistema The Micro Running Magnet. Convertitore elettronico di corrente DC/DC integrato.

Accent lighting LED module to be installed in The Running Magnet System. Built-in DC/DC electronic voltage converter.

Optic Medium 2700K

03.2210.40A
03.2210.14A

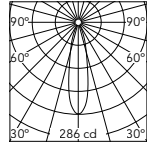

Beam Angle: 23°

h(m)	E(lx)	D(m)
1	286	0.41
2	72	0.83
3	32	1.24
4	18	1.65
5	11	2.06

Luminous flux luminaire 73 lm

Optic Flood 2700K

03.2215.40A
03.2215.14A

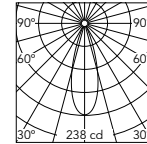

Beam Angle: 32°

h(m)	E(lx)	D(m)
1	238	0.57
2	60	1.15
3	26	1.72
4	15	2.29
5	10	2.87

Luminous flux luminaire 77 lm

3000K

03.2211.40A
03.2211.14A

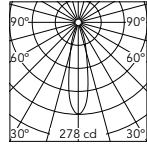

Beam Angle: 23°

h(m)	E(lx)	D(m)
1	278	0.41
2	69	0.83
3	31	1.24
4	17	1.65
5	11	2.06

Luminous flux luminaire 70 lm

3000K

03.2216.40A
03.2216.14A

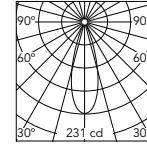

Beam Angle: 32°

h(m)	E(lx)	D(m)
1	231	0.57
2	58	1.15
3	26	1.72
4	14	2.29
5	9	2.87

Luminous flux luminaire 75 lm

4000K

03.2212.40A
03.2212.14A

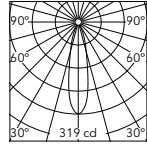

Beam Angle: 28°

h(m)	E(lx)	D(m)
1	319	0.41
2	80	0.83
3	35	1.24
4	20	1.65
5	13	2.06

Luminous flux luminaire 81 lm

4000K

03.2217.40A
03.2217.14A

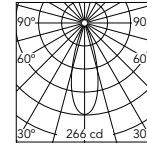

Beam Angle: 31°

h(m)	E(lx)	D(m)
1	266	0.57
2	66	1.15
3	30	1.72
4	17	2.29
5	11	2.87

Luminous flux luminaire 86 lm

5000K

03.2213.40A
03.2213.14A

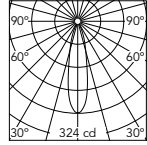

Beam Angle: 23°

h(m)	E(lx)	D(m)
1	324	0.41
2	81	0.83
3	36	1.24
4	20	1.65
5	13	2.06

Luminous flux luminaire 82 lm

5000K

03.2218.40A
03.2218.14A

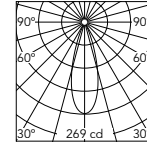

Beam Angle: 32°

h(m)	E(lx)	D(m)
1	269	0.57
2	67	1.15
3	30	1.72
4	17	2.29
5	11	2.87

Luminous flux luminaire 87 lm

Micro Spot

Light Source: Power LED 3W - 275 lm - 2700K/CRI 90 / 3W - 295 lm - 3000K/CRI 90 / 3W - 315 lm - 4000K/CRI 90 / 3W - 335 lm - 5000K/CRI 90

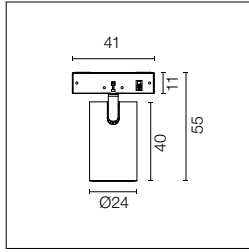

Modulo di illuminazione LED
 d'accento da installare nel sistema
 The Micro Running Magnet.
 Convertitore elettronico di corrente
 DC/DC integrato.
 Disponibile accessorio honeycomb.
 Da ordinare separatamente.
 Honeycomb accessory available.
 Must be ordered separately.

Modulo di illuminazione LED d'accento da installare nel sistema The Micro Running Magnet. Convertitore elettronico di corrente DC/DC integrato.

Accent lighting LED module to be installed in The Running Magnet System. Built-in DC/DC electronic voltage converter.

Disponibile accessorio honeycomb. Da ordinare separatamente.

Honeycomb accessory available. Must be ordered separately.

Optic Spot 2700K

- 03.2300.40A
- 03.2300.14A

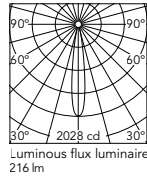

Beam Angle: 16°

h(m)	E(lx)	D(m)
1	2028	0.27
2	507	0.54
3	225	0.82
4	127	1.09
5	81	1.36

Optic Medium 2700K

- 03.2220.40A
- 03.2220.14A

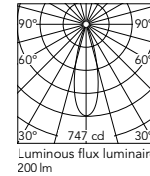

Beam Angle: 28°

h(m)	E(lx)	D(m)
1	747	0.51
2	187	1.02
3	83	1.54
4	47	2.05
5	30	2.56

3000K

- 03.2301.40A
- 03.2301.14A

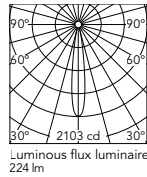

Beam Angle: 16°

h(m)	E(lx)	D(m)
1	2103	0.27
2	526	0.54
3	234	0.82
4	131	1.09
5	84	1.36

3000K

- 03.2221.40A
- 03.2221.14A

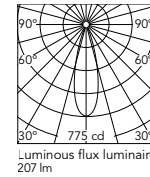

Beam Angle: 28°

h(m)	E(lx)	D(m)
1	775	0.51
2	194	1.02
3	86	1.54
4	48	2.05
5	31	2.56

4000K

- 03.2302.40A
- 03.2302.14A

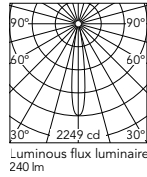

Beam Angle: 16°

h(m)	E(lx)	D(m)
1	2249	0.27
2	562	0.54
3	250	0.82
4	141	1.09
5	90	1.36

4000K

- 03.2222.40A
- 03.2222.14A

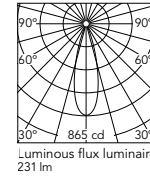

Beam Angle: 28°

h(m)	E(lx)	D(m)
1	865	0.51
2	216	1.02
3	96	1.54
4	54	2.05
5	35	2.56

5000K

- 03.2303.40A
- 03.2303.14A

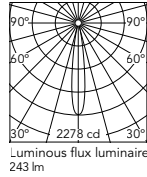

Beam Angle: 16°

h(m)	E(lx)	D(m)
1	2278	0.27
2	570	0.54
3	253	0.82
4	142	1.09
5	91	1.36

5000K

- 03.2223.40A
- 03.2223.14A

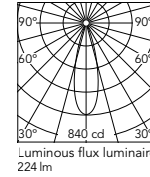

Beam Angle: 28°

h(m)	E(lx)	D(m)
1	840	0.51
2	210	1.02
3	93	1.54
4	52	2.05
5	34	2.56

Optic Flood 2700K

- 03.2225.40A
- 03.2225.14A

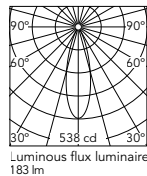

Beam Angle: 31°

h(m)	E(lx)	D(m)
1	538	0.54
2	134	1.09
3	60	1.63
4	34	2.17
5	22	2.72

3000K

- 03.2226.40A
- 03.2226.14A

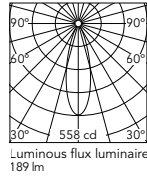

Beam Angle: 31°

h(m)	E(lx)	D(m)
1	558	0.54
2	139	1.09
3	62	1.63
4	35	2.17
5	22	2.72

4000K

- 03.2227.40A
- 03.2227.14A

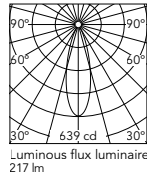

Beam Angle: 31°

h(m)	E(lx)	D(m)
1	639	0.54
2	160	1.09
3	71	1.63
4	40	2.17
5	26	2.72

5000K

- 03.2228.40A
- 03.2228.14A

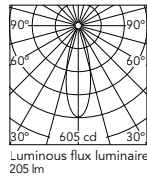

Beam Angle: 31°

h(m)	E(lx)	D(m)
1	605	0.54
2	151	1.09
3	67	1.63
4	38	2.17
5	24	2.72

THE MICRO RUNNING MAGNET – LIGHT MODULES

Spot

Light Source: Power LED 6W - 545 lm - 2700K/CRI 90 / 6W - 585 lm - 3000K/CRI 90 / 6W - 625 lm - 4000K/CRI 90 / 6W - 665 lm - 5000K/CRI 90

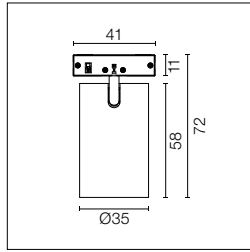

- 90°
- GWT 850°
- DALI
- LED INCL
- IP 20
- 0,07 Kg

Modulo di illuminazione LED d'accento da installare nel sistema The Micro Running Magnet. Convertitore elettronico di corrente DC/DC integrato.

Accent lighting LED module to be installed in The Running Magnet System. Built-in DC/DC electronic voltage converter.

Disponibile accessorio honeycomb. Da ordinare separatamente.

Honeycomb accessory available. Must be ordered separately.

Optic Spot 2700K

- 03.2230.40A
- 03.2230.14A

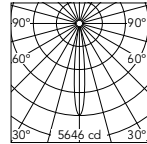

Beam Angle: 13°

h(m)	E(lx)	D(m)
1	5646	0.23
2	1411	0.45
3	627	0.68
4	353	0.90
5	226	1.13

Luminous flux luminaire 340 lm

3000K

- 03.2231.40A
- 03.2231.14A

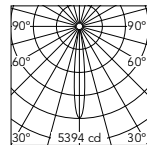

Beam Angle: 13°

h(m)	E(lx)	D(m)
1	5394	0.23
2	1349	0.45
3	599	0.68
4	337	0.90
5	216	1.13

Luminous flux luminaire 324 lm

4000K

- 03.2232.40A
- 03.2232.14A

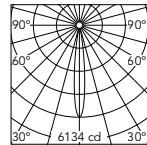

Beam Angle: 13°

h(m)	E(lx)	D(m)
1	6134	0.23
2	1534	0.45
3	682	0.68
4	383	0.90
5	245	1.13

Luminous flux luminaire 369 lm

5000K

- 03.2233.40A
- 03.2233.14A

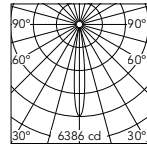

Beam Angle: 13°

h(m)	E(lx)	D(m)
1	6386	0.23
2	1597	0.45
3	710	0.68
4	399	0.90
5	255	1.13

Luminous flux luminaire 384 lm

Optic Medium 2700K

- 03.2235.40A
- 03.2235.14A

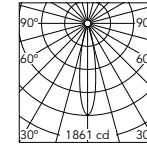

Beam Angle: 20°

h(m)	E(lx)	D(m)
1	1861	0.35
2	465	0.71
3	207	1.06
4	116	1.41
5	74	1.77

Luminous flux luminaire 315 lm

3000K

- 03.2236.40A
- 03.2236.14A

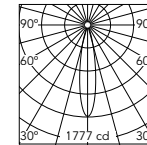

Beam Angle: 20°

h(m)	E(lx)	D(m)
1	1777	0.35
2	444	0.71
3	197	1.06
4	111	1.41
5	71	1.77

Luminous flux luminaire 301 lm

4000K

- 03.2237.40A
- 03.2237.14A

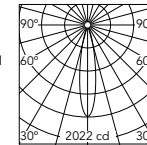

Beam Angle: 20°

h(m)	E(lx)	D(m)
1	2022	0.35
2	505	0.71
3	225	1.06
4	126	1.41
5	81	1.77

Luminous flux luminaire 342 lm

5000K

- 03.2238.40A
- 03.2238.14A

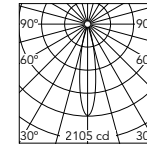

Beam Angle: 20°

h(m)	E(lx)	D(m)
1	2105	0.35
2	526	0.71
3	234	1.06
4	132	1.41
5	84	1.77

Luminous flux luminaire 356 lm

Light Shadow Spot

Light Source: Power LED 3W - 270 lm - 2700K/CRI 90 / 3W - 285 lm - 3000K/CRI 90 / 3W - 300 lm - 4000K/CRI 90 / 3W - 320 lm - 5000K/CRI 90

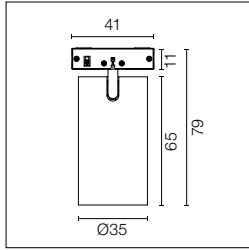

Modulo di illuminazione LED d'accento da installare nel sistema The Micro Running Magnet. Convertitore elettronico di corrente DC/DC integrato.

Accent lighting LED module to be installed in The Running Magnet System. Built-in DC/DC electronic voltage converter.

Optic Spot 2700K
03.2240.40
03.2240.14

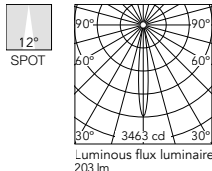

Beam Angle: 12°

h(m)	E(lx)	D(m)
1	3463	0.21
2	866	0.42
3	385	0.63
4	216	0.84
5	139	1.05

Luminous flux luminaire 203 lm

Optic Medium 2700K
03.2245.40
03.2245.14

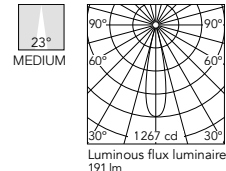

Beam Angle: 23°

h(m)	E(lx)	D(m)
1	1267	0.40
2	317	0.80
3	141	1.20
4	79	1.60
5	51	2.00

Luminous flux luminaire 191 lm

3000K
03.2241.40
03.2241.14

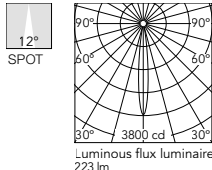

Beam Angle: 12°

h(m)	E(lx)	D(m)
1	3800	0.21
2	950	0.42
3	422	0.63
4	237	0.84
5	152	1.05

Luminous flux luminaire 223 lm

3000K
03.2246.40
03.2246.14

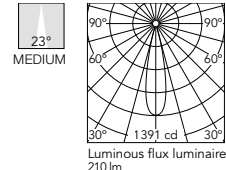

Beam Angle: 23°

h(m)	E(lx)	D(m)
1	1391	0.40
2	348	0.80
3	155	1.20
4	87	1.60
5	56	2.00

Luminous flux luminaire 210 lm

4000K
03.2242.40
03.2242.14

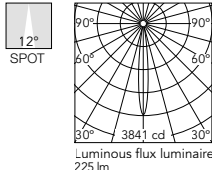

Beam Angle: 12°

h(m)	E(lx)	D(m)
1	3841	0.21
2	960	0.42
3	427	0.63
4	240	0.84
5	154	1.05

Luminous flux luminaire 225 lm

4000K
03.2247.40
03.2247.14

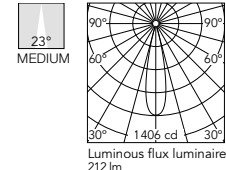

Beam Angle: 23°

h(m)	E(lx)	D(m)
1	1406	0.40
2	351	0.80
3	156	1.20
4	88	1.60
5	56	2.00

Luminous flux luminaire 212 lm

5000K
03.2243.40
03.2243.14

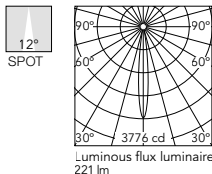

Beam Angle: 12°

h(m)	E(lx)	D(m)
1	3776	0.21
2	944	0.42
3	420	0.63
4	236	0.84
5	151	1.05

Luminous flux luminaire 221 lm

5000K
03.2248.40
03.2248.14

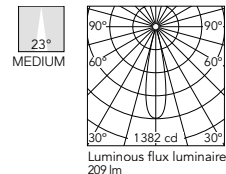

Beam Angle: 23°

h(m)	E(lx)	D(m)
1	1382	0.40
2	345	0.80
3	154	1.20
4	86	1.60
5	55	2.00

Luminous flux luminaire 209 lm

Optic Flood 2700K
03.2250.40
03.2250.14

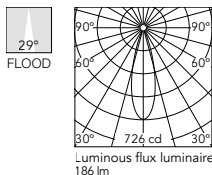

Beam Angle: 29°

h(m)	E(lx)	D(m)
1	726	0.51
2	182	1.03
3	81	1.54
4	45	2.05
5	29	2.57

Luminous flux luminaire 186 lm

Optic Wide Flood 2700K
03.2255.40
03.2255.14

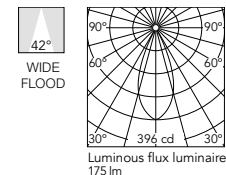

Beam Angle: 42°

h(m)	E(lx)	D(m)
1	396	0.77
2	99	1.53
3	44	2.30
4	25	3.07
5	16	3.83

Luminous flux luminaire 175 lm

3000K
03.2251.40
03.2251.14

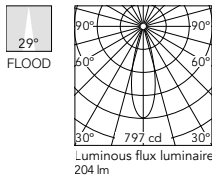

Beam Angle: 29°

h(m)	E(lx)	D(m)
1	797	0.51
2	199	1.03
3	89	1.54
4	50	2.05
5	32	2.57

Luminous flux luminaire 204 lm

3000K
03.2256.40
03.2256.14

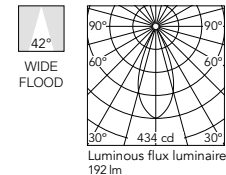

Beam Angle: 42°

h(m)	E(lx)	D(m)
1	434	0.77
2	108	1.53
3	48	2.30
4	27	3.07
5	17	3.83

Luminous flux luminaire 192 lm

4000K
03.2252.40
03.2252.14

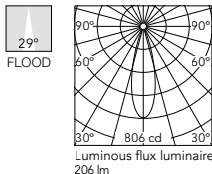

Beam Angle: 29°

h(m)	E(lx)	D(m)
1	806	0.51
2	201	1.03
3	90	1.54
4	50	2.05
5	32	2.57

Luminous flux luminaire 206 lm

4000K
03.2257.40
03.2257.14

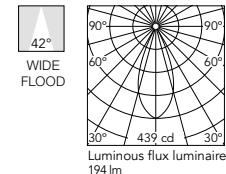

Beam Angle: 42°

h(m)	E(lx)	D(m)
1	439	0.77
2	110	1.53
3	49	2.30
4	27	3.07
5	18	3.83

Luminous flux luminaire 194 lm

5000K
03.2253.40
03.2253.14

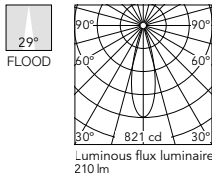

Beam Angle: 29°

h(m)	E(lx)	D(m)
1	821	0.51
2	205	1.03
3	91	1.54
4	51	2.05
5	33	2.57

Luminous flux luminaire 210 lm

5000K
03.2258.40
03.2258.14

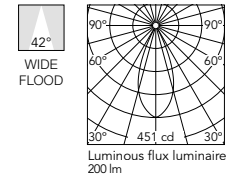

Beam Angle: 42°

h(m)	E(lx)	D(m)
1	451	0.77
2	113	1.53
3	50	2.30
4	28	3.07
5	18	3.83

Luminous flux luminaire 200 lm

Accessori / Accessories

Micro Spot

Honeycomb.

Honeycomb.



08.0190.14

Spot

Honeycomb.

Honeycomb.



08.0191.14

Driver / Drivers

Remote Installation

Fonte di alimentazione remota 24V.
Regolabile mediante protocollo
1/10V o non regolabile.
Intervallo di dimmerazione 20-100%.

24V remote power supply.
Dimmable through 1/10V protocol
or Non Dimmable.
Dimming range 20-100%.

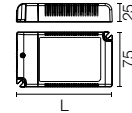

25W 110/240V – L:110
RF28210
36W-110V / 45W-240V – L:120
RF28211
57W 220/240V – L:130
RF28212

Remote Installation

Fonte di alimentazione remota 24V.
Regolabile mediante protocollo
1/10V.
Intervallo di dimmerazione 20-100%.

24V remote power supply.
Dimmable through 1/10V protocol.
Dimming range 20-100%.

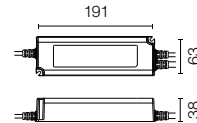

120W 110/240V
60.9416

*UL max 100W

DALI

Remote Installation

Fonte di alimentazione remota 24V.
Regolabile mediante protocollo
DALI.
Intervallo di dimmerazione 10-100%.

24V remote power supply.
Dimmable through DALI protocol.
Dimming range 10-100%.

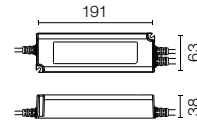

120W 110/240V
60.9426

*UL max 100W

Casambi

Remote Installation

Driver Casambi 220-240V.
Si consiglia di regolare il livello
minimo al 5%.
È necessario 24V, 1-10V o driver
Dali, da ordinare separatamente.
Intervallo di dimmerazione 20-100%.

Casambi controller 220-240V.
It is recommended to adjust the
minimum level of regulation to 5%.
Requires 24V, 1-10V or Dali driver.
It must be ordered separately.
Dimming range 20-100%.

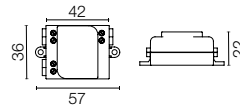

60.9392

THE MICRO RUNNING MAGNET

Remote Driver Installations - Broadcast

Connect to driver
(Option 1/2/3)

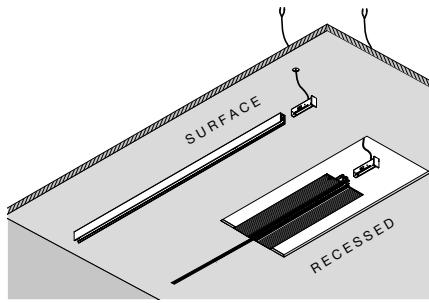

**Driver Option 1
(DALI)**

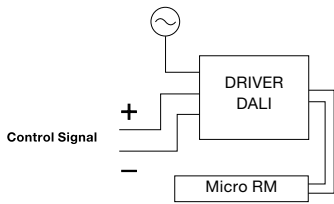

**Driver Option 2
(1-10V)**

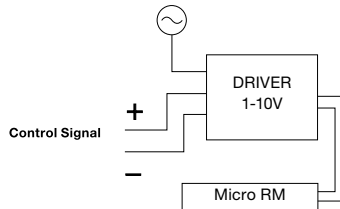

**Driver Option 3
Casambi Interface (Broadcast)**

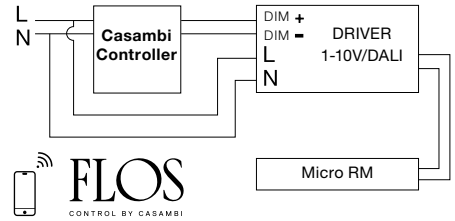

THE RUNNING MAGNET

DESIGNED BY FLOS ARCHITECTURAL

RECESSED

SURFACE

SUSPENSION
UP&DOWN / DOWN



Recessed Profiles 14 Nero
14 Black

Surface/Suspension Profiles 40 Bianco
40 White 14 Nero
14 Black

LIGHT MODULES

LIGHT STRIPE



LIGHT SOURCE
TOP LED
25W/m
2060 lm/m
2700K/CRI 90
2178 lm/m
3000K/CRI 90

SPOT MODULE



LIGHT SOURCE
POWER LED
8W
560 lm
2700K/CRI 90
600 lm
3000K/CRI 90

SPOT 120



LIGHT SOURCE
POWER LED
12,5W/14W DALI
985 lm
2700K/CRI 90
1060 lm
3000K/CRI 90

MULTI SPOT 4



LIGHT SOURCE
POWER LED
10W
4x226 lm
2700K/CRI 90
4x240 lm
3000K/CRI 90

LIGHT SHADOW



LIGHT SOURCE
POWER LED
10,8W
4x270 lm
2700K/CRI 90
4x285 lm
3000K/CRI 90

LIGHT SHADOW W-W



LIGHT SOURCE
POWER LED
10,8W
4x270 lm
2700K/CRI 90
4x285 lm
3000K/CRI 90

STRING LIGHT



LIGHT SOURCE
POWER LED
16W
1310 lm
2700K/CRI 90
1404 lm
3000K/CRI 90

MINI GLO-BALL



LIGHT SOURCE
POWER LED
3,5/7W
2700K/CRI 80
3000K/CRI 80

FIND ME SUSPENSION



LIGHT SOURCE
POWER LED
8W
560 lm
2700K/CRI 90
600 lm
3000K/CRI 90

ANTHONY SPOT TRACK



LIGHT SOURCE
POWER LED
16W
1310 lm
2700K/CRI 90
1404 lm
3000K/CRI 90



Light Stripe



Spot



Surface



Suspension



Recessed
Flos Kit
Installation



Recessed
Conventional
Installation

THE RUNNING MAGNET

Descrizione

Innovativo sistema di illuminazione per interni per installazione a superficie, sospesa o ad incasso in pareti o soffitti in cartongesso; comprende profilati magnetici in cui si posizionano i moduli di illuminazione LED.

Tutti i profili strutturali del Running Magnet sono stati fabbricati con intelaiature in alluminio estruso in bianco e nero, provviste di piste elettriche in grafite alimentate a 24V, sulle quali si installano gli apparecchi d'illuminazione LED mediante un sistema di fissaggio magnetico. La versione sospesa è anche disponibile per luce indiretta. La famiglia The Running Magnet si completa con moduli di illuminazione ambiente e d'accento con diverse ottiche, oltre a una selezione di apparecchi di illuminazione decorativi estratti e adattati dalla FLOS Home Collection. I moduli di illuminazione integrano un sistema di fissaggio magnetico che consente una mobilità e flessibilità completa. Tutti i moduli luce sono disponibili con potenziometro installato, con opzione dimmerabile DALI o Casambi.

Controllo

- Per la gestione mediante protocollo DALI è necessario collegare il bus dati di controllo direttamente al profilo.
- Per la gestione mediante Casambi (fino a 200 apparecchi) bisogna ordinare apparecchi in versione Casambi; questi sono compatibili con qualsiasi profilo del sistema. Necessaria app FLOS Control® powered by Casambi per dispositivi mobili (disponibile su Apple Store e Google Play).

Sistema Ottico

Il modulo di luce d'accento è disponibile con ottica intensiva (spot lens) e con ottiche estensive (narrow and wide narrow lens).

Unità di Alimentazione

Alimentatore remoto a 24V non compreso.

Accessori

- Diverse lenti per Spot Module e Multi Spot 4.
- Anello esterno di schermatura per Spot Module.
- Lente ellittica, flood e schermo antiabbagliamento honeycomb per Anthony Spot track.
- Schermo antiabbagliamento honeycomb e filtro a croce inclusi in Spot 120.

Informazioni Aggiuntive

Installabile solo su superfici di cartongesso da 12,5 mm di spessore per la versione Recessed.

Il Running Magnet è un sistema elettrico alimentato a 24 V e limitato a una corrente massima di 8A e 185W per evitare sovraccarichi.

Ogni volta che si raggiungono i 185W si deve effettuare nuovamente la connessione tramite un profilo di alimentazione.

Nella versione Up&Down l'illuminazione indiretta e il binario elettromeccanico hanno alimentazioni indipendenti.

Grado di protezione IP20.

Adatti ad installazioni su superfici normalmente infiammabili.

Conformità e Marchi di Qualità

Apparecchio conforme alla Normativa Tecnica Europea EN60598-1 e relative parti seconde.

Description

Innovative lighting system for indoor use, for surface, suspended or recessed mounting on plasterboard walls or ceilings, comprising a series of magnetic tracks that house the LED lighting modules.

The profile of all The Running Magnet structural tracks is extruded aluminum, painted black or white, housing a graphite electric track fed at 24V, on which all magnetic luminaires are installed simply by insertion.

Suspended track is also available with the option of indirect lighting.

The Running Magnet family is completed with ambient lighting units and accent units with different optics, as well as a selection of decorative luminaires taken and adapted from FLOS Home Collection.

The lighting modules incorporate a magnetic mounting system for total mobility and flexibility. All light modules are available with on board potentiometer, DALI dimmable option and Casambi.

Control

- To manage using DALI protocol, it is necessary to connect the control data bus directly to the profile.
- To manage using Casambi (Max. 200 luminaires) it is necessary to order fixtures in the Casambi version, these are compatible with all profiles available for the system. The app FLOS Control® powered by Casambi for mobile devices is also necessary (available on Apple Store and Google Play).

Optic system

The accent light module is available with intensive optics (spot lens) and extensive optics (narrow and wide narrow lens).

Power Supply

Remote 24V power supply not included.

Accessories

- Different lenses for Spot Module and Multi Spot 4.
- Screening external ring for Spot Module.
- Elliptical, flood lens and honeycomb for Anthony Spot Track.
- Honeycomb and crosspiece included in Spot 120.

Additional Information

The Recessed version can only be installed on 12.5 mm thick plasterboard surfaces.

The Running Magnet 2.0 is a 24V electrical system limited to a maximum power current of 8A and 185W to avoid overloads.

After every 185W make a new connection with a feed unit profile.

In the Up&Down version indirect illumination and the electromechanical track are powered independently.

IP20 protection grade.

Suitable for installation on normally inflammable surfaces.

Compliance of Standards and Quality Marks

EN60598-1 European Technical Standards and any subsequent additions.

FLOS
CONTROL BY CASAMBI



HOW TO ORDER

1 CHOOSE YOUR PROFILE AND LENGTH

RECESSED PROFILE

L: 1 / 1,5 / 2 / 2,5 / 3 m

2 COMPLETE WITH MOUNTING ACCESSORIES

End cap
Included with feed profile

90° Corner
Electrical / mechanical joint

Inner corner
Electrical / mechanical joint

Outer corner
Electrical / mechanical joint

Accessories

Recessed installation

Fixed ceiling kit or Adjustable ceiling kit

SURFACE/SUSPENSION DOWN PROFILE

L: 1 / 1,5 / 2 / 2,5 / 3 m

End cap
Included with feed profile

90° Corner
Electrical / mechanical joint

Inner corner
Electrical / mechanical joint

Accessories

Surface installation

Fixed ceiling kit (Included)

Suspension Down installation

Suspension kit (Included with profile)

Surface rose or Recessed rose

SUSPENSION UP&DOWN PROFILE

L: 1 / 1,5 / 2 / 2,5 / 3 m

End cap
Included with feed profile

90° Corner
Electrical / mechanical joint

Accessories

Suspension Up&Down installation

Intermediate suspension kit (Included with profile)

Surface rose or Recessed rose

THE RUNNING MAGNET

3 SELECT POWER SUPPLY AND CONTROL OPTION

Recessed installation

Remote power supply



(select the driver with the appropriate power according to the needs of your project)

Surface installation

Remote power supply



Non Dimmable / Dali / Casambi

(select the driver with the appropriate power according to the needs of your project)

Suspension Down installation

Remote power supply



(select the driver with the appropriate power according to the needs of your project)

Surface power supply

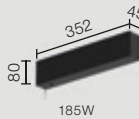

185W

Non Dimmable / Dali / Casambi

Suspension Up&Down installation

Remote power supply

Surface power supply

Down instal.

Up instal.

Down instal.

Up instal.



(select the driver with the appropriate power according to the needs of your project)

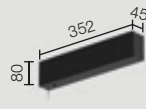

185W

Non Dim / Spots Casambi



60W / 120W OR 200W

(select the driver with the appropriate power according to the needs of your project)



60W / 120W

(select the driver with the appropriate power according to the needs of your project)

+



185W

Dali

4 SELECT A LIGHT MODULE AND CONTROL OPTION

Non Dimmable / Dali / Casambi

Light Stripe



Spot Module



Spot 120



Multi Spot 4



Light Shadow



Light Shadow W-W



String Light



Mini Glo-Ball



Find Me Suspension



Anthony Spot Track



THE RUNNING MAGNET RECESSED – PROFILES

Profili

Binario elettromeccanico per installazioni a incasso su soffitti/pareti in cartongesso.

Binari lineari disponibili in due versioni: profili di alimentazione per collegamento a driver, e profili intermedi. Entrambe le versioni con lunghezze da 1 m a 3 m. Calotte comprese nei profili di alimentazione.

Disponibili angoli a 90° sul medesimo piano (elemento simmetrico per angoli sinistro e destro), angoli simmetrici a 90° su piano diverso all'interno e all'esterno. Predisposti per collegamento a driver.

Kit di fissaggio, fissi o regolabili, disponibili (opzionale). I kit di fissaggio a soffitto consentono l'installazione senza la necessità di profili di fissaggio in alluminio. Consigliato per impianti in cui si può installare il profilo Running Magnet prima del controsoffitto in cartongesso.

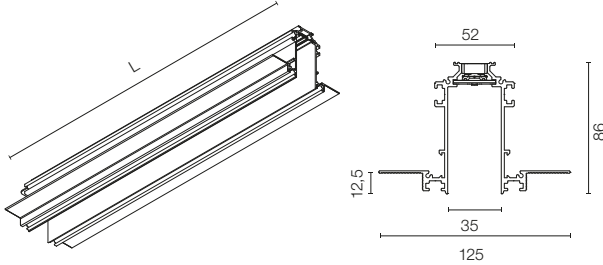

L: 1 m / 1,5 m / 2 m / 2,5 m / 3 m

Profiles

Electromechanical profile for recessed installation in plasterboard ceilings and walls.

Linear profiles available in two versions: power feed profiles for connecting to a driver, and intermediate profiles. Both versions available in lengths from 1 m to 3 m. Covers included with the power feed profiles.

90° corners available in the same plane (symmetrical element for left and right corners), symmetrical 90° inner and outer corners in different planes. For connection to the driver.

Permanent or adjustable fastening kits available (optional). The fastening kits for the roof permit installing without using aluminum fastening profiles. Recommended for installations where the Running Magnet cannot be installed before the suspended plasterboard ceiling.

Feed Unit Profiles

- L: 1000 mm
■ 06.1638.14
- L: 1500 mm
■ 06.1639.14
- L: 2000 mm
■ 06.1640.14
- L: 2500 mm
■ 06.1641.14
- L: 3000 mm
■ 06.1642.14

Intermediate Profiles

- L: 1000 mm
■ 06.1643.14
- L: 1500 mm
■ 06.1644.14
- L: 2000 mm
■ 06.1645.14
- L: 2500 mm
■ 06.1646.14
- L: 3000 mm
■ 06.1647.14

Angolo 90°.
Alimentabile.

90° Corner.
Can be powered.

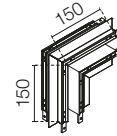

■ 06.1648.14

Angolo interno.
Alimentabile.

Inner corner.
Can be powered.

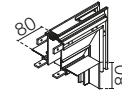

■ 06.1650.14

Angolo esterno.
Alimentabile.

Outer corner.
Can be powered.

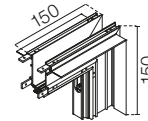

■ 06.1651.14

Kit di fissaggio a soffitto fisso
(opzionale). Kit da 2 unità.

Fixed ceiling kit (optional).
2 unit kit.

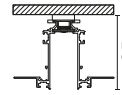

■ 08.8866.14

Kit di fissaggio a soffitto regolabile
(opzionale). Kit da 2 unità.

Adjustable ceiling kit (optional).
2 unit kit.

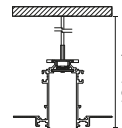

■ 08.8867.14

Profile (mm)	Quantities Ceiling Kit (units)
1000 / 1500	2
2000 / 2500	3
3000	4

I terminale di chiusura sono inclusi in tutti i profili di alimentazione. Si devono ordinare separatamente solo se l'impianto è composto esclusivamente da profili intermedi e alimentato agli angoli.

End caps come complete with all the feed unit profiles. These should only be ordered separately if the installation is exclusively composed of intermediate profiles and fed by corners.



■ 08.8865.14A

THE RUNNING MAGNET SURFACE – PROFILES

Profili

Binario elettromeccanico per installazioni a superficie.

Binari lineari disponibili in due versioni: profili di alimentazione per collegamento a driver, e profili intermedi. Entrambe le versioni con lunghezze da 1 m a 3 m.

Calotte comprese nei profili di alimentazione. Accessori di fissaggio inclusi in tutti i prodotti.

Disponibili angoli a 90° sul medesimo piano (elemento simmetrico per angoli sinistro e destro), e angoli simmetrici a 90° su piano diverso all'interno, comuni in versioni Surface e Down. Predisposti per collegamento a driver.

La parte interna del profilo è fornita sempre in nero.

Profiles

Electromechanical profile for surface-mounting.

Linear profiles available in two versions: power feed profiles for connecting to a driver, and intermediate profiles. Both versions available in lengths from 1 m to 3 m.

Covers included with the power feed profiles. Attachment accessories included with all products.

90° corners available in the same plane (symmetrical element for left and right corner) and 90° symmetrical internal corners in a different plane, for the Surface and Down versions. For connection to the driver.

The inner part of the profile is always supplied in black.

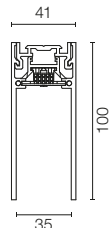
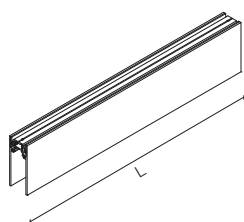

L: 1 m / 1,5 m / 2 m / 2,5 m / 3 m

Feed Unit Profiles

L: 1000 mm

06.1600.40

06.1600.14

L: 1500 mm

06.1601.40

06.1601.14

L: 2000 mm

06.1602.40

06.1602.14

L: 2500 mm

06.1603.40

06.1603.14

L: 3000 mm

06.1604.40

06.1604.14

Intermediate Profiles

L: 1000 mm

06.1605.40

06.1605.14

L: 1500 mm

06.1606.40

06.1606.14

L: 2000 mm

06.1607.40

06.1607.14

L: 2500 mm

06.1608.40

06.1608.14

L: 3000 mm

06.1609.40

06.1609.14

Angolo 90°.
Alimentabile.

90° Corner.
Can be powered.



06.1610.40
06.1610.14

Angolo interno.
Alimentabile.

Inner corner.
Can be powered.

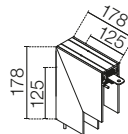

06.1612.40
06.1612.14

I terminali di chiusura sono inclusi in tutti i profili di alimentazione. Si devono ordinare separatamente solo se l'impianto è composto esclusivamente da profili intermedi e alimentato agli angoli.

End caps come complete with all the feed unit profiles. These should only be ordered separately if the installation is exclusively composed of intermediate profiles and fed by corners.



08.8887.40A
08.8887.14A

THE RUNNING MAGNET SUSPENSION UP&DOWN – PROFILES

Profili

Binario elettromeccanico per installazioni a sospensione.
 Gli elementi lineari in versione Up&Down comprendono illuminazione LED indiretta nella parte superiore del profilo. Si possono alimentare con alimentazione condivisa o indipendente.
 Binari lineari disponibili in due versioni: profili di alimentazione per collegamento al driver, e profili intermedi. Entrambe le versioni con lunghezze da 1 m a 3 m.
 Calotte comprese nei profili di alimentazione. Accessori per collegamento (cavo di alimentazione da 4,2 m) e sospensione (cavo in acciaio da 4 m) a soffitto compresi in tutti i prodotti lineari di alimentazione o intermedi.
 Disponibili angoli a 90° sul medesimo piano (elemento simmetrico per angoli sinistro e destro). Non predisposti per collegamento a driver.
 Gli angoli delle versioni sospese del Running Magnet non sono dotati di illuminazione indiretta. L'illuminazione indiretta può essere controllata come un circuito separato se è alimentata da un apparecchio speciale e, nel caso di DALI, dotata di un apparecchio opzionale di controllo DALI da ordinare separatamente.
 I profili non si possono tagliare.
 La parte interna del profilo è fornita sempre in nero.

Profiles

Electromechanical profile for suspended installations.
 Linear elements in the Up&Down version include indirect LED illumination in the upper part of the profile. Shared or separate power feed.
 Linear profiles available in two versions: power feed profiles for connecting to a driver, and intermediate profiles. Both versions available in lengths from 1 m to 3 m.
 Covers included with the power feed profiles. Ceiling connection (4.2 m feed cable) and suspension (4m steel cable) accessories included in all linear feed or intermediate products.
 90° corners in the same plane (symmetrical element for right and left corners). Not provided for connection to the driver.
 The corners of the Suspended Running Magnet versions are not fitted with indirect illumination. Indirect illumination can be managed as a separate circuit if powered by a dedicated driver and, in the case of the DALI installation, if equipped with a dedicated optional DALI controller. To be ordered separately.
 Profiles cannot be cut.
 The inner part of the profile is always supplied in black.

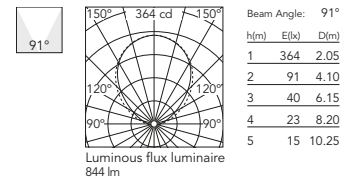
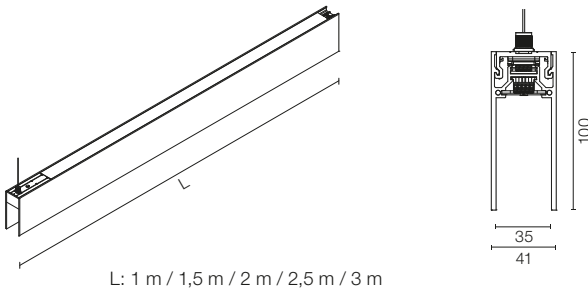

Light Source: Top LED 8,4W/m Up - 950 lm/m Up - 3000K/CRI 90

Feed Unit Profiles

L: 1000 mm
 06.1614.40A
 06.1614.14A

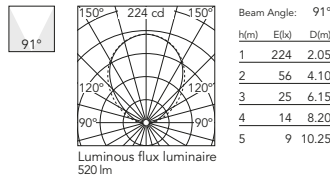

Intermediate Profiles

L: 1000 mm
 06.1619.40A
 06.1619.14A

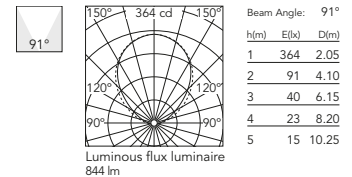

L: 1500 mm
 06.1615.40A
 06.1615.14A

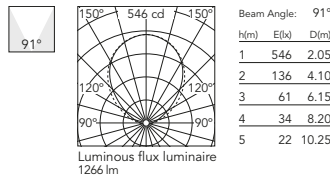

L: 1500 mm
 06.1620.40A
 06.1620.14A

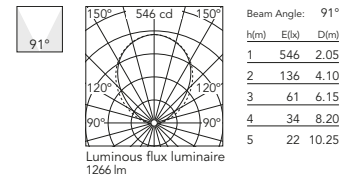

L: 2000 mm
 06.1616.40A
 06.1616.14A

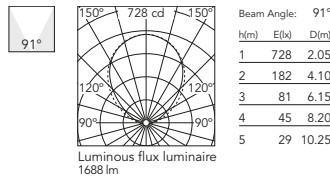

L: 2000 mm
 06.1621.40A
 06.1621.14A

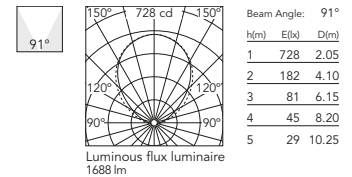

L: 2500 mm
 06.1617.40A
 06.1617.14A

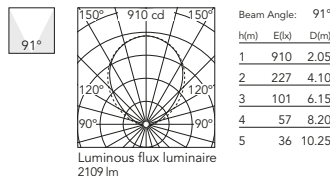

L: 2500 mm
 06.1622.40A
 06.1622.14A

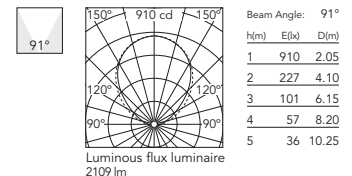

L: 3000 mm
 06.1618.40A
 06.1618.14A

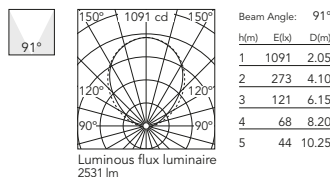

L: 3000 mm
 06.1623.40A
 06.1623.14A

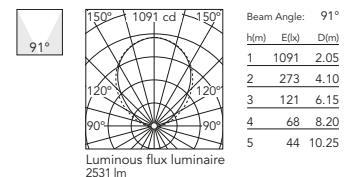

Angolo 90°.
 Non alimentabile. Compreso 1 kit di sospensione con cavo.

90° Corner.
 Cannot be powered. Includes 1 cable suspension kit.

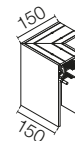

06.1624.40
 06.1624.14

THE RUNNING MAGNET SUSPENSION DOWN – PROFILES

Profili

Binario elettromeccanico per installazioni a sospensione.
 Binari lineari disponibili in due versioni: profili di alimentazione per collegamento a driver, e profili intermedi. Entrambe le versioni con lunghezze da 1 m a 3 m.
 Calotte comprese nei profili di alimentazione.
 Accessori per collegamento (cavo di alimentazione da 4,2 m) e sospensione (cavo in acciaio da 4 m) a soffitto compresi in tutti i prodotti lineari di alimentazione o intermedi.
 Disponibili angoli a 90° sul medesimo piano (elemento simmetrico per angoli sinistro e destro), comuni in versioni Surface e Down. Predisposti per collegamento a driver.
 La parte interna del profilo è fornita sempre in nero.

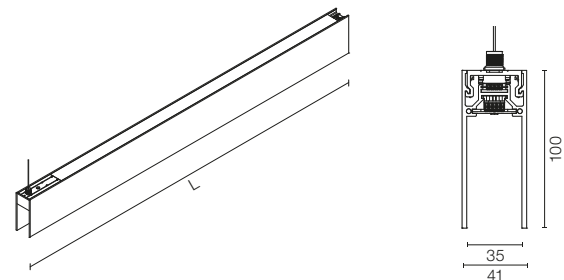

L: 1 m / 1,5 m / 2 m / 2,5 m / 3 m

Profiles

Electromechanical profile for suspended installations.
 Linear profiles available in two versions: power feed profiles for connecting to a driver, and intermediate profiles. Both versions available in lengths from 1 m to 3 m.
 Covers included with the power feed profiles.
 Ceiling connection (4.2 m feed cable) and suspension (4 m steel cable) accessories included in all linear feed or intermediate products. 90° corners in the same plane (symmetrical element for right and left corners) for the Surface and Down versions. Provided for connection to the driver.
 The inner part of the profile is always supplied in black.

Feed Unit Profiles

- L: 1000 mm
- 06.1626.40
- 06.1626.14
- L: 1500 mm
- 06.1627.40
- 06.1627.14
- L: 2000 mm
- 06.1628.40
- 06.1628.14
- L: 2500 mm
- 06.1629.40
- 06.1629.14
- L: 3000 mm
- 06.1630.40
- 06.1630.14

Intermediate Profiles

- L: 1000 mm
- 06.1631.40
- 06.1631.14
- L: 1500 mm
- 06.1632.40
- 06.1632.14
- L: 2000 mm
- 06.1633.40
- 06.1633.14
- L: 2500 mm
- 06.1634.40
- 06.1634.14
- L: 3000 mm
- 06.1635.40
- 06.1635.14

Angolo 90°.

90° Corner.

Non alimentabile. Compreso 1 kit di sospensione con cavo.

Cannot be powered. Includes 1 cable suspension kit.



Cannot be powered

- 06.1657.40
- 06.1657.14

Alimentabile. Compresi 2 kit di sospensione con cavo.

Can be powered. Includes 2 cable suspension kits.

Can be powered

- 06.1656.40
- 06.1656.14

The Running Magnet Suspension Up&Down / Down

I terminale di chiusura sono inclusi in tutti i profili di alimentazione. Si devono ordinare separatamente solo se l'impianto è composto esclusivamente da profili intermedi e alimentato agli angoli.

End caps come complete with all the feed unit profiles. These should only be ordered separately if the installation is exclusively composed of intermediate profiles and fed by corners.



- 08.8887.40A
- 08.8887.14A

Per strutture chiuse (quadrati e rettangoli) / Down grid structures (square or rectangle shapes)

Angolo 90° per strutture a griglia. Modulo angolare per la costruzione di strutture a griglia perfettamente chiuse. Alimentabile. Dimensioni 153x153.

Corner 90° Grid. Corner to build grid structures perfectly closed. Feed unit. Dimensions 153x153.

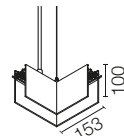

- 06.1740.14

Unione a T per strutture a griglia. Modulo a forma di T per la costruzione di strutture a griglia perfettamente chiuse. Alimentabile. Dimensioni 265x265.

T-Joint Grid Down. T piece to build grid structures perfectly closed. Feed unit. Dimensions 265x153.

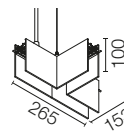

- 06.1741.14

Unione a X per strutture a griglia. Modulo a forma di X per la costruzione di strutture a griglia perfettamente chiuse. Alimentabile. Dimensioni 265x265.

X-Joint Grid Down. Cross piece to build grid structures perfectly closed. Feed unit. Dimensions 265x265.

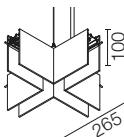

- 06.1742.14

THE RUNNING MAGNET SUSPENSION

Accessori / Accessories

Rosone di alimentazione di superficie. Apparecchio, cavi di alimentazione e sospensione non forniti, da ordinare separatamente.

Surface rose. Equipment, power cable and suspension cable not included. They must be ordered separately.

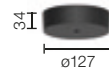

08.8883.40A
08.8883.14A

Scatola di alimentazione in superficie, sia per illuminazione diretta sia per illuminazione diretta e indiretta con alloggiamento per il driver. Apparecchio 24V/185W - 110/240V incluso. Cavi non forniti.

Surface power supply for direct and indirect lighting with housing for the driver. 24V/185W - 110/240V equipment included. Cables not included.



08.8886.40
08.8886.14

Regolatore DALI e apparecchio 24V/185W - 110/240V per alimentare e controllare tanto l'illuminazione diretta quanto quella indiretta, incluso. Cavi non forniti.

DALI controller and 24V/185W - 110/240V equipment to supply and control both the direct and indirect lighting, included. Cables not included.

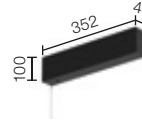

08.8886.40.DA
08.8886.14.DA

Rosone di alimentazione incassato. Driver non incluso, da ordinare separatamente.

Recessed power supply rose. Equipment not included. To be ordered separately.



08.8889.40
08.8889.14

THE RUNNING MAGNET – INSTALLATION PROFILES

SUSPENSION INSTALLATION

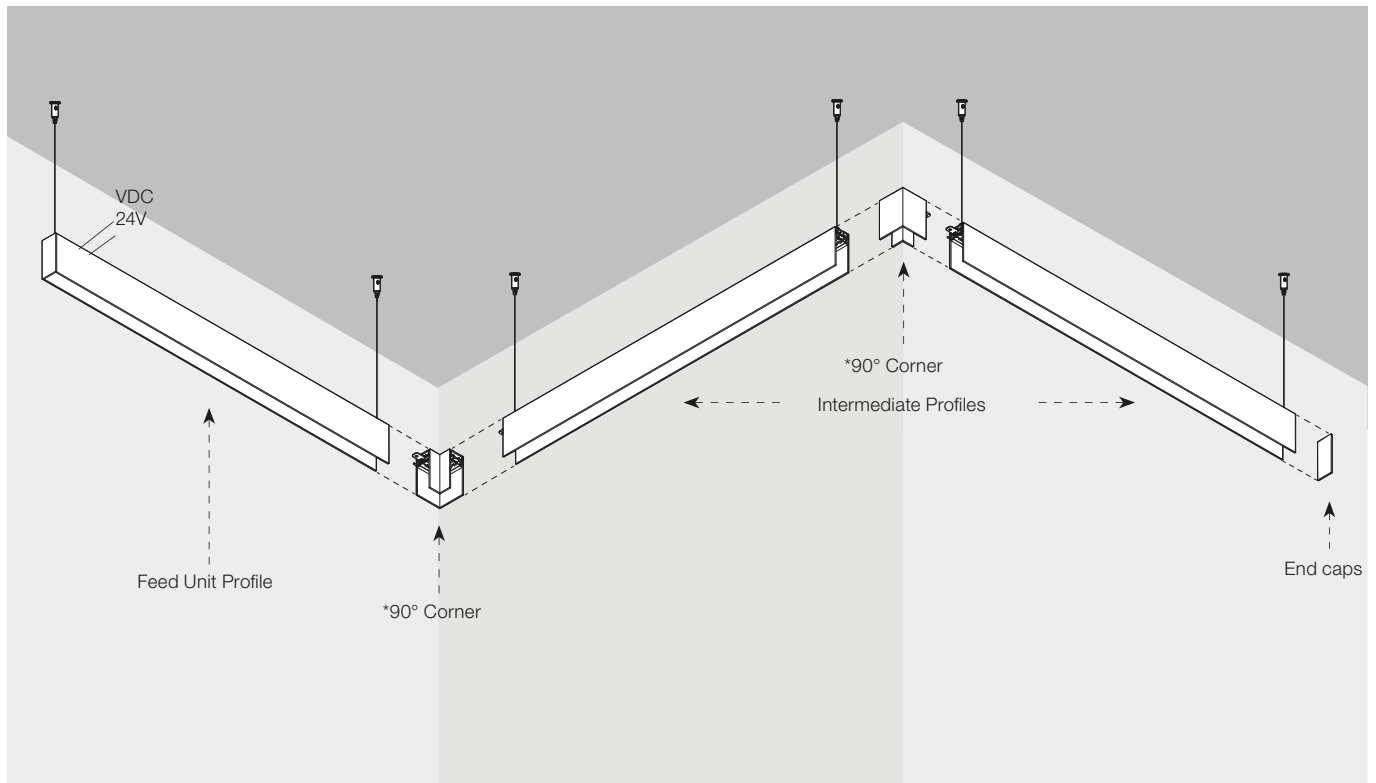

*Angoli predisposti per alimentare la struttura, solo in versione DOWN / Corners provided to feed the structure, only in the DOWN version.

THE RUNNING MAGNET – INSTALLATION PROFILES

RECESSED INSTALLATION

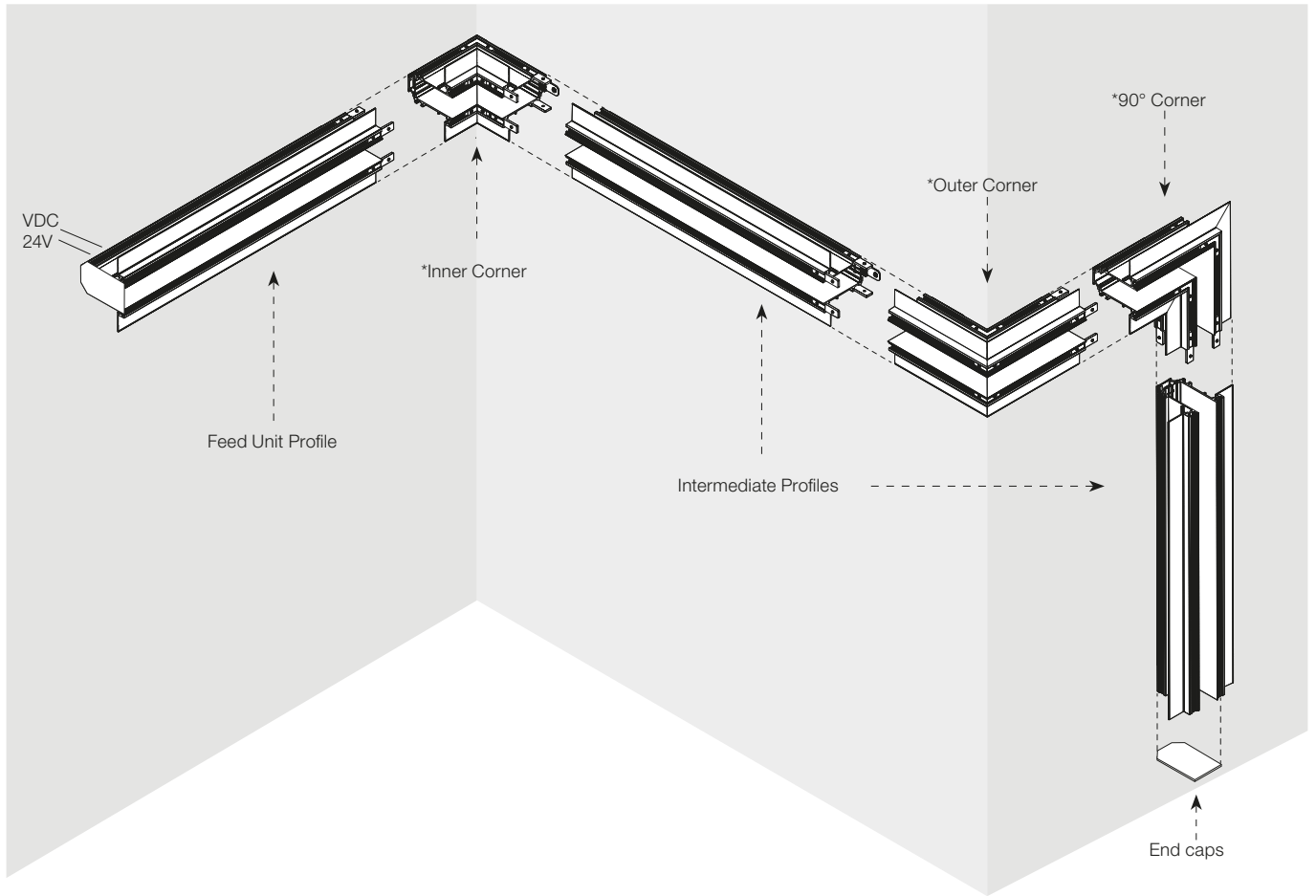

SURFACE INSTALLATION

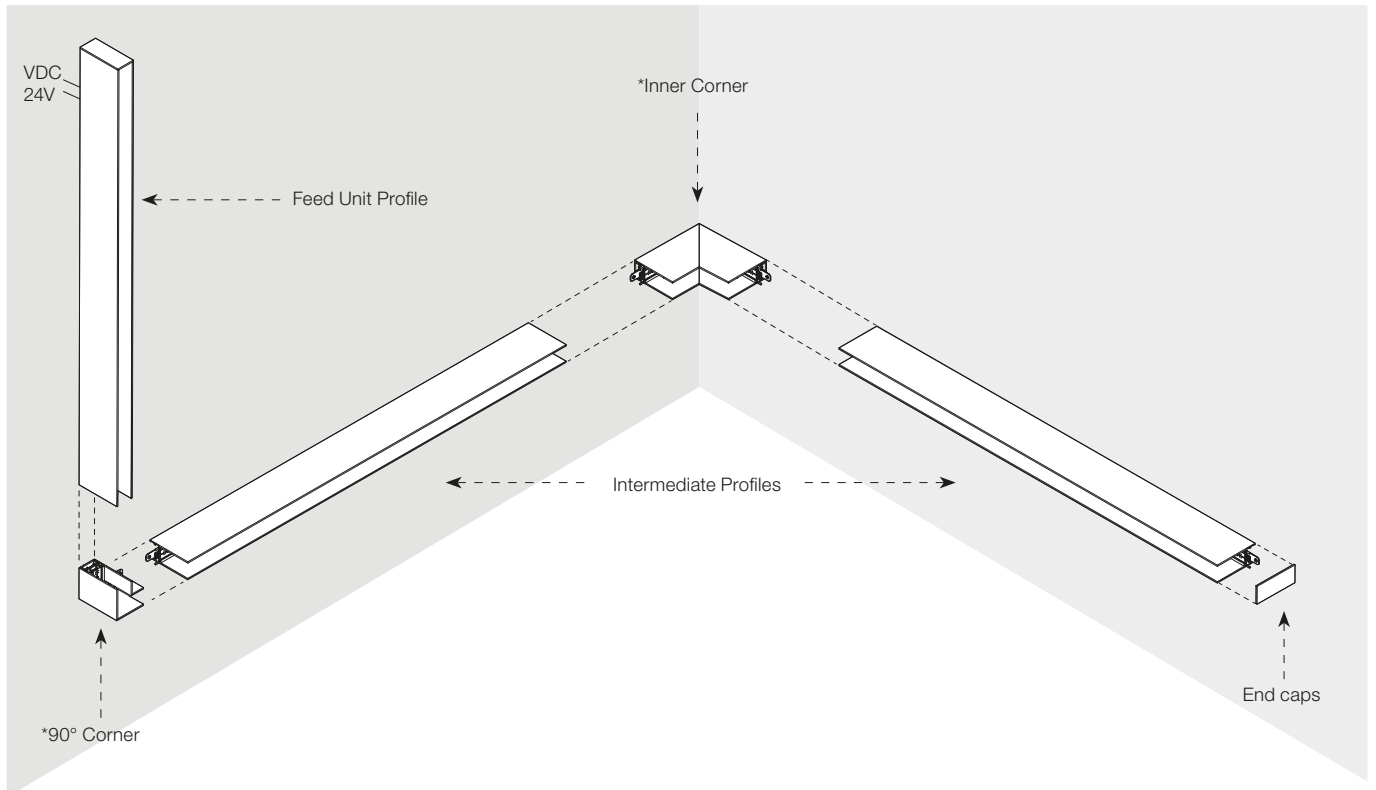

*Angoli predisposti per alimentare la struttura / Corners provided to feed the structure.

THE RUNNING MAGNET – FAQ

• **Posso alimentare una struttura direttamente da un angolo, senza utilizzare un profilo di alimentazione?**

Sì, gli angoli sono predisposti per alimentare una struttura in entrambe le direzioni senza la necessità di utilizzare un profilo di alimentazione. È sufficiente tener conto del fatto che si dovranno ordinare separatamente i coperchi dei profili, dato che non sono inclusi negli angoli e nei profili intermedi.

Gli angoli della versione Up&Down non si possono alimentare.

• **Posso utilizzare un profilo di alimentazione per alimentare una struttura in superficie dal centro?**

Sì, per alimentare una struttura in superficie dal centro (in entrambe le direzioni), saranno necessari due profili di alimentazione con due fonti di alimentazione, una per ciascun profilo di alimentazione, oppure la medesima fonte di alimentazione per entrambi i profili di alimentazione, rispettando i limiti elettrici. La connessione meccanica tra i due profili si può realizzare senza alcun problema.

• **Can I feed a structure directly from a corner without using a feed unit profile?**

Yes, corners are prepared to feed a structure in both directions without the need for a feed unit profile. Simply remember that you'll have to order the End cap profiles separately because they are not included in corners and intermediate profiles.

Take note that corners in Up&Down versions cannot be fed.

• **Can I use a feed unit profile to feed a surface structure from the center?**

Yes, to feed a surface structure from the center (in both directions), you'll need to use two feed unit profiles with two power supplies connected, one to each feed unit profile, or connect the same power supply to both feed unit profiles, respecting any potential electrical limitations. The mechanical connection can be made between profiles without any problem.

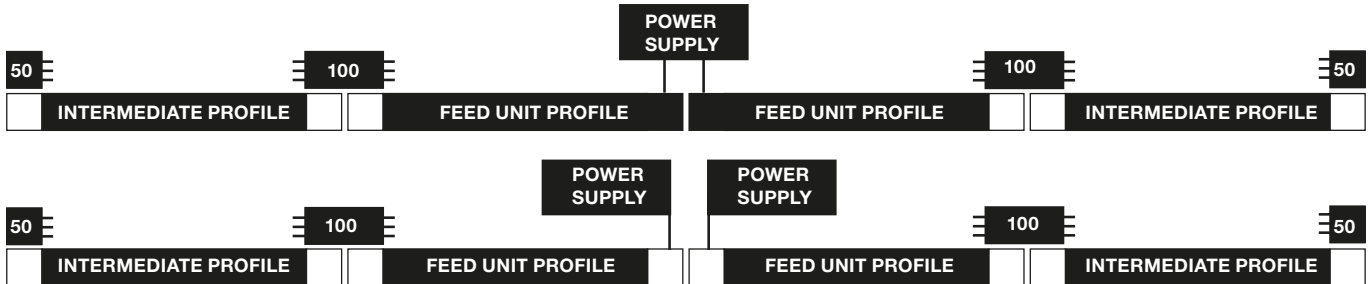

• **Posso tagliare un profilo?**

Sì, i profili si possono tagliare della misura desiderata (eccetto nella versione Up&Down). Si deve tener conto del fatto che, una volta tagliato un profilo, si perde la continuità elettrica. Se il profilo tagliato non è quello che chiude la struttura (nel cui caso non è necessaria la continuità elettrica) il tratto seguente dovrà essere nuovamente alimentato con un angolo o un profilo di alimentazione.

Se il lato tagliato fa parte del modulo finale della composizione bisogna isolare elettricamente il terminale di chiusura metallico.

• **Can I cut a profile?**

Yes, profiles can be cut to the desired length (except Up&Down version). Once a profile is cut, the electrical continuity is lost. If the cut element is not the one that closes the structure (in that case you don't need electrical continuity) the next section must be fed with a corner or a feed unit profile.

If the cut side is at the end, the metallic end cap must be electrically insulated.

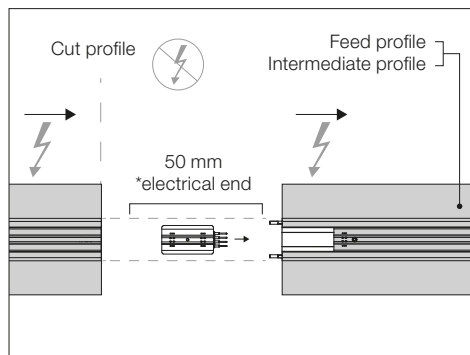
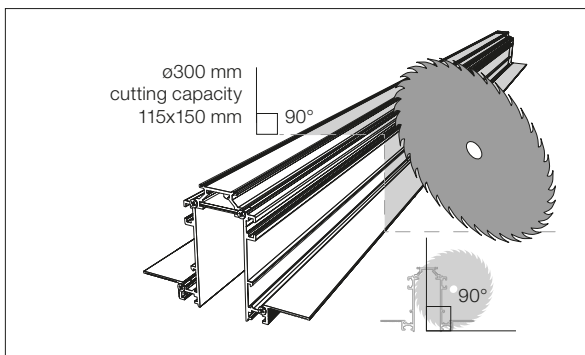

*Compreso nei profili di alimentazione o end cap /
Included with feed profiles or end caps.

THE RUNNING MAGNET – FAQ

• Posso controllare in modo indipendente l'illuminazione diretta e indiretta nella versione Up&Down?

Sì, per controllare l'illuminazione diretta e indiretta in modo indipendente si deve semplicemente collegare una fonte di alimentazione alla connessione di illuminazione indiretta e un'altra a quella diretta, consentendo così di controllare le diverse fonti in modo indipendente.

Se si desidera utilizzare un sistema di regolazione DALI, allora la fonte di alimentazione collegata all'illuminazione indiretta si deve collegare a un regolatore DALI (60.8635).

• Can I independently control the Up Light and the Down Light in the Up&Down version?

Yes, to control the Up Light and Down Light independently you just have to connect one power supply to the down electrical connector and another one to the up electrical connector. This allows you to manage the different light sources independently.

If you want to use a DALI Dimmable system for the Up Light and the Down Light, then the power supply connected to Up Light must be connected to a Dali controller (60.8635).

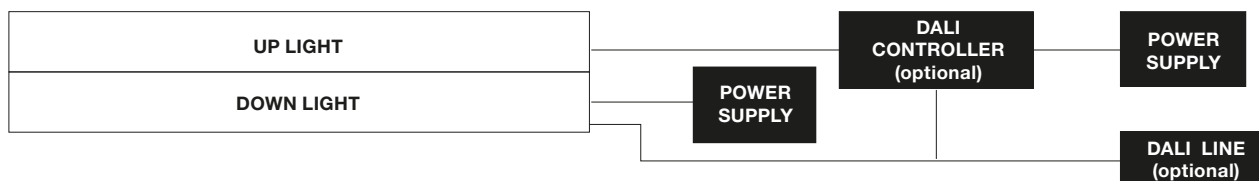

• Posso controllare in modo indipendente gli apparecchi d'illuminazione installati in una struttura con un regolatore DALI?

Sì, il sistema DALI identificherà ciascun apparecchio di illuminazione installato individualmente e consentirà di controllarlo in modo indipendente.

• Per realizzare la struttura DALI mi serve l'unità di controllo dimmabile DALI 60.8635?

Gli apparecchi d'illuminazione sono già dotati di elettronica DALI, pertanto l'unità di controllo DALI non sarà necessaria.

L'unità di controllo DALI 60.8635 sarà necessaria solo per controllare l'illuminazione indiretta con un sistema DALI nella versione Up&Down.

• Qual è la distanza massima permessa tra la fonte di alimentazione e il profilo?

Con la fonte di alimentazione da 200W (60.9352) del nostro catalogo, la distanza massima concessa è:

- . Cavo da Ø 1,5 mm: 3 m
- . Cavo da Ø 2,5 mm: 5 m

• Qual è la lunghezza massima alimentabile con una fonte di alimentazione in una struttura?

La lunghezza massima di un profilo che è possibile alimentare con una fonte di alimentazione è 8 m.

• Posso utilizzare una fonte di alimentazione diversa - meno potente?

Tutte le informazioni pubblicate sul nostro sito Web, catalogo e istruzioni di installazione sono conformi ai test realizzati con la nostra fonte di alimentazione da 200W (60.9352) raccomandata per i nostri prodotti.

Tuttavia, si può utilizzare una fonte di alimentazione diversa per alimentare i profili, tenendo tuttavia in considerazione i limiti elettrici da rispettare.

Deve essere una fonte di alimentazione da 24V con una corrente elettrica massima di 8A.

• Can I independently control the luminaires installed in the structure with a DALI controller?

Yes, the DALI system will identify each luminaire installed in the profile with a unique address, and will allow you to independently manage each one.

• Do I need the Dimmable Dali controller 60.8635 to make the DALI structure?

The luminaries to be installed in the track are already equipped with Dali electronic, so a Dali controller is not required for these.

The 60.8635 DALI Controller is only required to make the Up indirect Light controllable with a DALI system in the Up&Down version.

• What is the maximum distance allowed between the driver and the profile?

With the 200W power supply (60.9352) in our catalogue, the maximum distance allowed is:

- . Ø 1.5 mm cable: 3 m
- . Ø 2.5 mm cable: 5 m

• What is the maximum length that can be fed with one power supply?

The maximum profile length that can be fed with a power supply is 8 m.

• Can I use a different, less powerful power supply?

All the information published on our website, and in our catalogue and installation instructions sheets is adjusted to the tests we perform with our 200W power supply (60.9352), which we recommend for our products.

However, a different power supply can be used to feed the profiles but the electrical limitations that it will have to accomplish should be taken into account.

It should be a 24V power supply with a maximum electric current of 8A.

Light Stripe

Light Source: Top LED 25W/m - 2060 lm/m - 2700K/CRI 90 / 25W/m - 2178 lm/m - 3000K/CRI 90

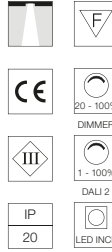
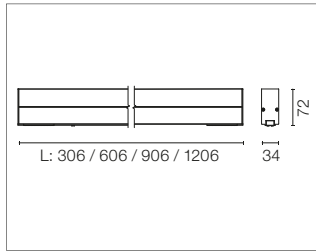

Modulo di illuminazione LED a luce diffusa da installare nel sistema The Running Magnet. Coperchi opalini per creare linee di luce continue inclusi. Per il controllo bluetooth dei moduli luminosi selezionare le versioni con Casambi integrato.

Diffused LED light module to be installed in The Running Magnet System. Opaline end caps to create continuous lines of light included. For wireless lighting control, choose integrated Casambi versions.

2700K

L: 300 mm - 7,5W - 618lm
On board dimmer

03.7000.14

Dali Version

03.7000.14ADA

**Casambi Integrated

03.7000.14.CB

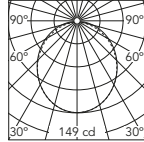

Luminous flux luminaire
416 lm

Beam Angle: 105°

h(m)	E(lx)	D(m)
1	149	2.76
2	37	5.52
3	17	8.28
4	9	11.04
5	6	13.81

3000K

L: 300 mm - 7,5W - 653lm
On board dimmer

03.7001.14

Dali Version

03.7001.14ADA

**Casambi Integrated

03.7001.14.CB

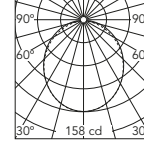

Luminous flux luminaire
440 lm

Beam Angle: 105°

h(m)	E(lx)	D(m)
1	158	2.76
2	39	5.52
3	18	8.28
4	10	11.04
5	6	13.81

2700K

L: 600 mm - 15W - 1237lm
On board dimmer

03.7002.14

Dali Version

03.7002.14ADA

**Casambi Integrated

03.7002.14.CB

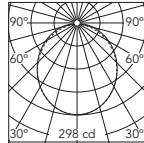

Luminous flux luminaire
833 lm

Beam Angle: 105°

h(m)	E(lx)	D(m)
1	298	2.76
2	75	5.52
3	33	8.28
4	19	11.04
5	12	13.81

3000K

L: 600 mm - 15W - 1307lm
On board dimmer

03.7003.14

Dali Version

03.7003.14ADA

**Casambi Integrated

03.7003.14.CB

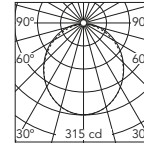

Luminous flux luminaire
880 lm

Beam Angle: 105°

h(m)	E(lx)	D(m)
1	315	2.76
2	79	5.52
3	35	8.28
4	20	11.04
5	13	13.81

2700K

On board dimmer
L: 900 mm - 22,5W - 1855lm

03.7004.14

Dali Version

03.7004.14ADA

**Casambi Integrated

03.7004.14.CB

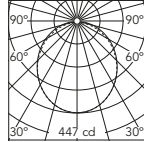

Luminous flux luminaire
1249 lm

Beam Angle: 105°

h(m)	E(lx)	D(m)
1	447	2.76
2	112	5.52
3	50	8.28
4	28	11.04
5	18	13.81

3000K

On board dimmer
L: 900 mm - 22,5W - 1960lm

03.7005.14

Dali Version

03.7005.14ADA

**Casambi Integrated

03.7005.14.CB

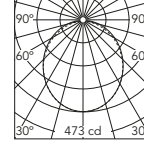

Luminous flux luminaire
1320 lm

Beam Angle: 105°

h(m)	E(lx)	D(m)
1	473	2.76
2	118	5.52
3	53	8.28
4	30	11.04
5	19	13.81

2700K

On board dimmer
L: 1200 mm - 30W - 2473lm

03.7006.14

Dali Version

03.7006.14ADA

**Casambi Integrated

03.7006.14.CB

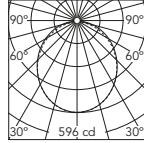

Luminous flux luminaire
1665 lm

Beam Angle: 105°

h(m)	E(lx)	D(m)
1	596	2.76
2	149	5.52
3	66	8.28
4	37	11.04
5	24	13.81

3000K

On board dimmer
L: 1200 mm - 30W - 2614lm

03.7007.14

Dali Version

03.7007.14ADA

**Casambi Integrated

03.7007.14.CB

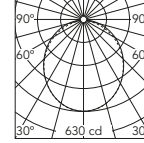

Luminous flux luminaire
1760 lm

Beam Angle: 105°

h(m)	E(lx)	D(m)
1	630	2.76
2	158	5.52
3	70	8.28
4	39	11.04
5	25	13.81

THE RUNNING MAGNET – LIGHT MODULES

Spot Module

Light Source: Power LED 8W - 560 lm - 2700K/CRI 90 / 8W - 600 lm - 3000K/CRI 90

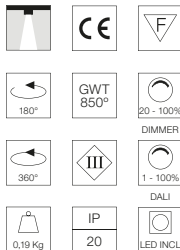
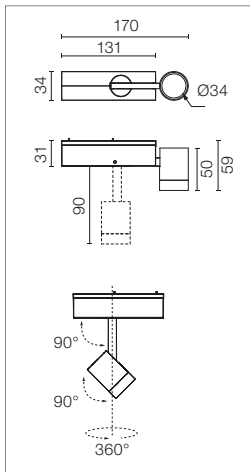

Modulo di illuminazione LED d'accento da installare nel sistema The Running Magnet. Convertitore elettronico di corrente DC/DC integrato. Per il controllo bluetooth dei moduli luminosi selezionare le versioni con Casambi integrato.

Accent lighting LED module to be installed in The Running Magnet System. Built-in DC/DC electronic voltage converter. For wireless lighting control, choose integrated Casambi versions.

Spot Module No DALI: Massimo 21 spot per ciascun driver.
Spot Module DALI: Massimo 14 spot per ciascun driver.

Spot Module No DALI: Maximum 21 spots for a single driver.
Spot Module DALI: Maximum 14 spots for a single driver.
Maximum 64 spots for a single DALI controller.

Massimo 64 spot per ciascun regolatore DALI.

See available accessories.

Vedi accessori disponibili.

2700K

On board dimmer

03.6303.14B

Dali Version

03.6303.14CDA

**Casambi Integrated

03.6303.14BCB

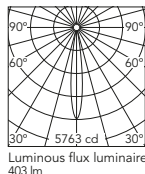

Beam Angle: 14°

h(m)	E(lx)	D(m)
1	5763	0.24
2	1441	0.49
3	640	0.73
4	360	0.98
5	231	1.22

3000K

On board dimmer

03.6302.14B

Dali Version

03.6302.14CDA

**Casambi Integrated

03.6302.14BCB

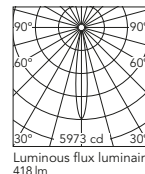

Beam Angle: 14°

h(m)	E(lx)	D(m)
1	5973	0.24
2	1493	0.49
3	664	0.73
4	373	0.98
5	239	1.22

Accessori / Accessories

Spot Module

Anello schermante esterno per spot module Running Magnet realizzato in alluminio e con finitura nera per un incremento del comfort visivo.

Screening external ring for Running Magnet spot module in aluminium with a black finish to enhance the visual comfort.



08.8427.14

** Il sistema di controllo degli apparecchi in versione Casambi si regola direttamente tramite bluetooth con l'applicazione dedicata FLOS Control® by Casambi / The control system with the Casambi version of light fixtures is directly and individually regulated wirelessly using the application FLOS Control® by Casambi.

Multi Spot 4

Light Source: Power LED 10W - 4x226 lm - 2700K/CRI 90 / 10W - 4x240 lm - 3000K/CRI 90

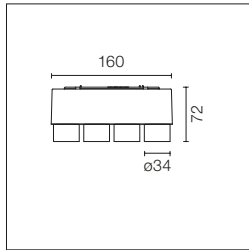

Modulo di illuminazione LED d'accento da installare nel sistema The Running Magnet. Convertitore elettronico di corrente DC/DC integrato. Per il controllo bluetooth dei moduli luminosi selezionare le versioni con Casambi integrato.

Accent lighting LED module to be installed in The Running Magnet System. Built-in DC/DC electronic voltage converter. For wireless lighting control, choose integrated Casambi versions.

See available accessories.

Vedi accessori disponibili.

2700K

- On board dimmer
- 03.6305.14
- Dali Version
- 03.6305.14ADA
- **Casambi Integrated
- 03.6305.14.CB



SPOT

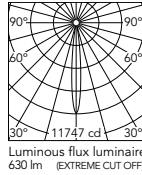

Beam Angle: 11°

h(m)	E lx	D(m)
1	11747	0.20
2	2937	0.40
3	1305	0.60
4	734	0.80
5	470	1.00

3000K

- On board dimmer
- 03.6306.14
- Dali Version
- 03.6306.14ADA
- **Casambi Integrated
- 03.6306.14.CB



SPOT

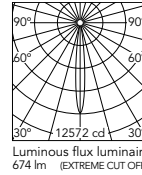

Beam Angle: 11°

h(m)	E lx	D(m)
1	12572	0.20
2	3143	0.40
3	1397	0.60
4	786	0.80
5	503	1.00

Accessori / Accessories

Spot Module & Multi Spot 4

Lente frosted medium.
Accessorio ad ottica medium.



08.8760.00



SPOT MODULE

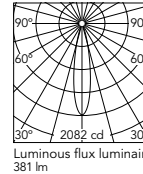

Beam Angle: 21°

h(m)	E lx	D(m)
1	2082	0.36
2	520	0.73
3	231	1.09
4	130	1.46
5	83	1.82



MULTI SPOT

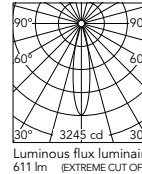

Beam Angle: 21°

h(m)	E lx	D(m)
1	3245	0.37
2	811	0.75
3	361	1.12
4	203	1.50
5	130	1.87

Lente frosted flood.
Accessorio ad ottica flood.



08.8761.00



SPOT MODULE

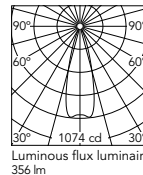

Beam Angle: 31°

h(m)	E lx	D(m)
1	1074	0.55
2	269	1.09
3	119	1.64
4	67	2.19
5	43	2.73



MULTI SPOT

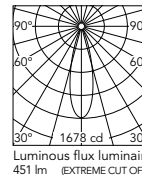

Beam Angle: 28°

h(m)	E lx	D(m)
1	1678	0.50
2	420	1.00
3	186	1.51
4	105	2.01
5	67	2.51

Lente ellittica.

Elliptical lens.



08.8759.00



SPOT MODULE

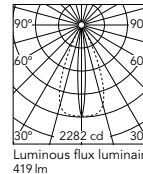

Beam Angle: 46°

h(m)	E lx	D(m)
1	2282	0.17
2	571	0.34
3	254	0.51
4	143	0.68
5	91	0.85



MULTI SPOT

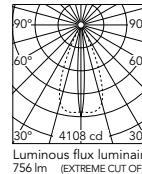

Beam Angle: 46°

h(m)	E lx	D(m)
1	4108	0.15
2	1027	0.30
3	456	0.44
4	257	0.59
5	164	0.74

** Il sistema di controllo degli apparecchi i versione Casambi si regola direttamente tramite bluetooth con l'applicazione dedicata FLOS Control® by Casambi / The control system with the Casambi version of light fixtures is directly and individually regulated wirelessly using the application FLOS Control® by Casambi.

THE RUNNING MAGNET – LIGHT MODULES

Spot 120

Light Source: Power LED 12,5W/14W DALI - 985 lm - 2700K/CRI 90 / 12,5W/14W DALI - 1060 lm - 3000K/CRI 90

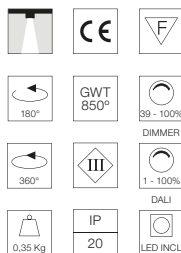
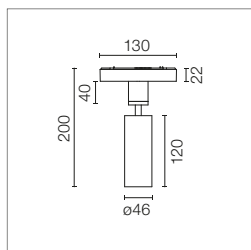

Modulo di illuminazione LED d'accento da installare nel sistema The Running Magnet. Convertitore elettronico di corrente DC/DC integrato. Per il controllo bluetooth dei moduli luminosi selezionare le versioni con Casambi integrato.

Spot Module No DALI:
Massimo 14 spot per ciascun driver.

Spot Module DALI:
Massimo 11 spot per ciascun driver.

Accessori inclusi (honeycomb e filtro a croce antiabbagliamento).

Accent lighting LED module to be installed in The Running Magnet System. Built-in DC/DC electronic voltage converter. For wireless lighting control, choose integrated Casambi versions.

Spot Module No DALI:
Maximum 14 spots for a single driver.

Spot Module DALI:
Maximum 11 spots for a single driver.

Accessories included (honeycomb and screening crosspiece).

2700K

On board dimmer

03.6285.40
03.6285.14

Dali Version

03.6285.40ADA
03.6285.14ADA

**Casambi Integrated

03.6285.40.CB
03.6285.14.CB

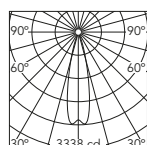

Luminous flux luminaire
707 lm (EXTREME CUT OFF)

Beam Angle: 25°

h(m)	E(lx)	D(m)
1	3338	0.44
2	835	0.89
3	371	1.33
4	209	1.78
5	134	2.22

3000K

On board dimmer

03.6284.40
03.6284.14

Dali Version

03.6284.40ADA
03.6284.14ADA

**Casambi Integrated

03.6284.40.CB
03.6284.14.CB

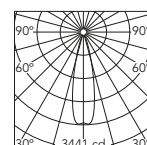

Luminous flux luminaire
731 lm (EXTREME CUT OFF)

Beam Angle: 25°

h(m)	E(lx)	D(m)
1	3441	0.45
2	860	0.89
3	382	1.34
4	215	1.78
5	138	2.23

2700K

On board dimmer

03.6286.40
03.6286.14

Dali Version

03.6286.40ADA
03.6286.14ADA

**Casambi Integrated

03.6286.40.CB
03.6286.14.CB

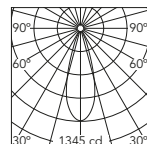

Luminous flux luminaire
430 lm (EXTREME CUT OFF)

Beam Angle: 33°

h(m)	E(lx)	D(m)
1	1345	0.59
2	336	1.17
3	149	1.76
4	84	2.34
5	54	2.93

3000K

On board dimmer

03.6287.40
03.6287.14

Dali Version

03.6287.40ADA
03.6287.14ADA

**Casambi Integrated

03.6287.40.CB
03.6287.14.CB

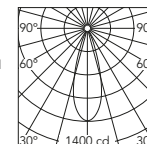

Luminous flux luminaire
444 lm (EXTREME CUT OFF)

Beam Angle: 33°

h(m)	E(lx)	D(m)
1	1400	0.58
2	350	1.16
3	156	1.75
4	88	2.33
5	56	2.91

THE RUNNING MAGNET – LIGHT MODULES

Light Shadow

Light Source: Power LED 10,8W - 4x270 lm - 2700K/CRI 90 / 10,8W - 4x285 lm - 3000K/CRI 90

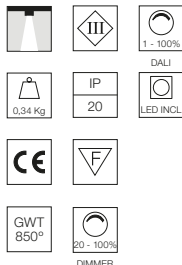
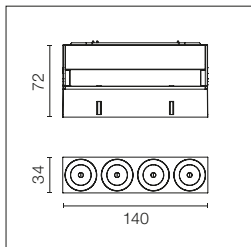

Modulo di illuminazione LED con 4 farette e ad abbagliamento limitato, installabili sul sistema The Running Magnet.
Convertitore elettronico corrente DC/DC incorporato.
Per il controllo bluetooth dei moduli luminosi selezionare le versioni con Casambi integrato.

LED lighting module, with 4 spotlights and low glare, to be installed in the The Running Magnet system.
DC/DC, built-in electronic current converter.
For wireless lighting control, choose integrated Casambi versions.

E= Finitura Esterna
I= Finitura Interna

E= External Finish
I= Internal Finish

Optic Spot 2700K

- E I On board dimmer
03.8949.40A
03.8949.14A
- E I Dali Version
03.8949.40BDA
03.8949.14BDA
- E I **Casambi Integrated
03.8949.40ACB
03.8949.14ACB

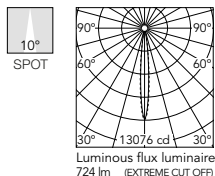

Beam Angle: 10°

h(m)	E(%)	D(m)
1	13076	0.18
2	3269	0.36
3	1453	0.54
4	817	0.72
5	523	0.90

Optic Spot 3000K

- E I On board dimmer
03.8953.40A
03.8953.14A
- E I Dali Version
03.8953.40BDA
03.8953.14BDA
- E I **Casambi Integrated
03.8953.40ACB
03.8953.14ACB

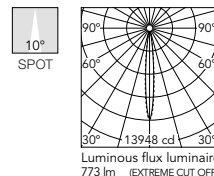

Beam Angle: 10°

h(m)	E(%)	D(m)
1	13948	0.18
2	3487	0.36
3	1550	0.54
4	872	0.72
5	558	0.90

2700K

- E I On board dimmer
03.8948.40A
03.8948.14A
- E I Dali Version
03.8948.40BDA
03.8948.14BDA
- E I **Casambi Integrated
03.8948.40ACB
03.8948.14ACB

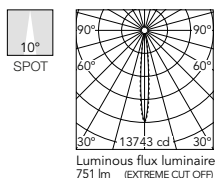

Beam Angle: 10°

h(m)	E(%)	D(m)
1	13743	0.17
2	3436	0.35
3	1527	0.52
4	859	0.70
5	550	0.87

3000K

- E I On board dimmer
03.8952.40A
03.8952.14A
- E I Dali Version
03.8952.40BDA
03.8952.14BDA
- E I **Casambi Integrated
03.8952.40ACB
03.8952.14ACB

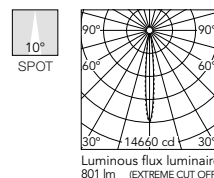

Beam Angle: 10°

h(m)	E(%)	D(m)
1	14660	0.17
2	3665	0.35
3	1629	0.52
4	916	0.70
5	586	0.87

2700K

- E I On board dimmer
03.8950.40A
03.8950.14A
- E I Dali Version
03.8950.40BDA
03.8950.14BDA
- E I **Casambi Integrated
03.8950.40ACB
03.8950.14ACB

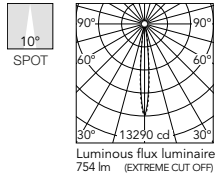

Beam Angle: 10°

h(m)	E(%)	D(m)
1	13290	0.18
2	3322	0.36
3	1477	0.55
4	831	0.73
5	532	0.91

3000K

- E I On board dimmer
03.8954.40A
03.8954.14A
- E I Dali Version
03.8954.40BDA
03.8954.14BDA
- E I **Casambi Integrated
03.8954.40ACB
03.8954.14ACB

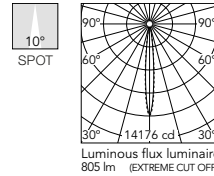

Beam Angle: 10°

h(m)	E(%)	D(m)
1	14176	0.18
2	3544	0.36
3	1575	0.55
4	886	0.73
5	567	0.91

2700K

- E I On board dimmer
03.8951.40A
03.8951.14A
- E I Dali Version
03.8951.40BDA
03.8951.14BDA
- E I **Casambi Integrated
03.8951.40ACB
03.8951.14ACB

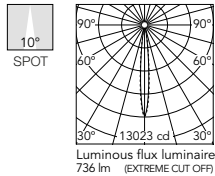

Beam Angle: 10°

h(m)	E(%)	D(m)
1	13023	0.18
2	3256	0.36
3	1447	0.55
4	814	0.73
5	521	0.91

3000K

- E I On board dimmer
03.8955.40A
03.8955.14A
- E I Dali Version
03.8955.40BDA
03.8955.14BDA
- E I **Casambi Integrated
03.8955.40ACB
03.8955.14ACB

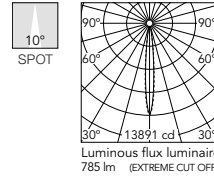

Beam Angle: 10°

h(m)	E(%)	D(m)
1	13891	0.18
2	3473	0.36
3	1543	0.55
4	868	0.73
5	556	0.91

** Il sistema di controllo degli apparecchi in versione Casambi si regola direttamente tramite bluetooth con l'applicazione dedicata FLOS Control® by Casambi / The control system with the Casambi version of light fixtures is directly and individually regulated wirelessly using the application FLOS Control® by Casambi.

**Optic Medium
2700K**

E I On board dimmer
03.9621.40A
03.9621.14A

E I Dali Version
03.9621.40BDA
03.9621.14BDA

E I **Casambi Integrated
03.9621.40ACB
03.9621.14ACB

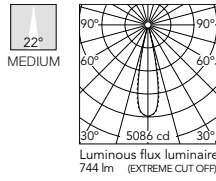

Beam Angle: 22°

h(m)	E(k)	D(m)
1	5086	0.39
2	1272	0.78
3	565	1.17
4	318	1.56
5	203	1.95

**Optic Medium
3000K**

E I On board dimmer
03.9631.40A
03.9631.14A

E I Dali Version
03.9631.40BDA
03.9631.14BDA

E I **Casambi Integrated
03.9631.40ACB
03.9631.14ACB

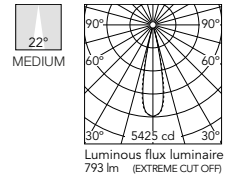

Beam Angle: 22°

h(m)	E(k)	D(m)
1	5425	0.39
2	1356	0.78
3	603	1.17
4	339	1.56
5	217	1.95

2700K

E I On board dimmer
03.9620.40A
03.9620.14A

E I Dali Version
03.9620.40BDA
03.9620.14BDA

E I **Casambi Integrated
03.9620.40ACB
03.9620.14ACB

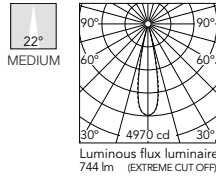

Beam Angle: 22°

h(m)	E(k)	D(m)
1	4970	0.39
2	1243	0.78
3	552	1.17
4	311	1.56
5	199	1.95

3000K

E I On board dimmer
03.9630.40A
03.9630.14A

E I Dali Version
03.9630.40BDA
03.9630.14BDA

E I **Casambi Integrated
03.9630.40ACB
03.9630.14ACB

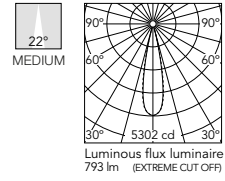

Beam Angle: 22°

h(m)	E(k)	D(m)
1	5302	0.39
2	1325	0.78
3	589	1.17
4	331	1.56
5	212	1.95

2700K

E I On board dimmer
03.9622.40A
03.9622.14A

E I Dali Version
03.9622.40BDA
03.9622.14BDA

E I **Casambi Integrated
03.9622.40ACB
03.9622.14ACB

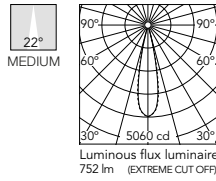

Beam Angle: 22°

h(m)	E(k)	D(m)
1	5060	0.39
2	1265	0.77
3	562	1.16
4	316	1.55
5	202	1.94

3000K

E I On board dimmer
03.9632.40A
03.9632.14A

E I Dali Version
03.9632.40BDA
03.9632.14BDA

E I **Casambi Integrated
03.9632.40ACB
03.9632.14ACB

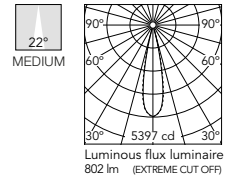

Beam Angle: 22°

h(m)	E(k)	D(m)
1	5397	0.39
2	1349	0.77
3	600	1.16
4	337	1.55
5	216	1.94

2700K

E I On board dimmer
03.9623.40A
03.9623.14A

E I Dali Version
03.9623.40BDA
03.9623.14BDA

E I **Casambi Integrated
03.9623.40ACB
03.9623.14ACB

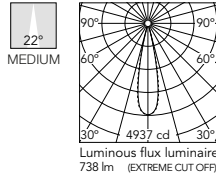

Beam Angle: 22°

h(m)	E(k)	D(m)
1	4937	0.39
2	1234	0.78
3	549	1.17
4	309	1.56
5	197	1.95

3000K

E I On board dimmer
03.9633.40A
03.9633.14A

E I Dali Version
03.9633.40BDA
03.9633.14BDA

E I **Casambi Integrated
03.9633.40ACB
03.9633.14ACB

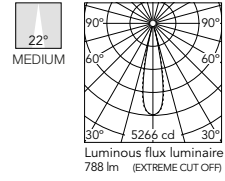

Beam Angle: 22°

h(m)	E(k)	D(m)
1	5266	0.39
2	1316	0.78
3	585	1.17
4	329	1.56
5	211	1.95

** Il sistema di controllo degli apparecchi a versione Casambi si regola direttamente tramite bluetooth con l'applicazione dedicata FLOS Control® by Casambi / The control system with the Casambi version of light fixtures is directly and individually regulated wirelessly using the application FLOS Control® by Casambi.

Light Shadow

Light Source: Power LED 10,8W - 4x270 lm - 2700K/CRI 90 / 10,8W - 4x285 lm - 3000K/CRI 90

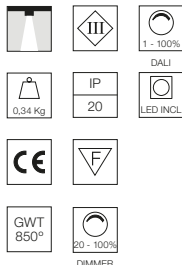
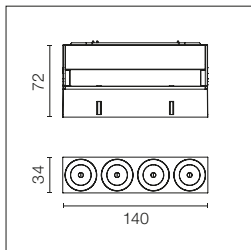

Modulo di illuminazione LED con 4 faretti e ad abbagliamento limitato, installabili sul sistema The Running Magnet.
Convertitore elettronico corrente DC/DC incorporato.
Per il controllo bluetooth dei moduli luminosi selezionare le versioni con Casambi integrato.

LED lighting module, with 4 spotlights and low glare, to be installed in the The Running Magnet system.
DC/DC, built-in electronic current converter.
For wireless lighting control, choose integrated Casambi versions.

E= Finitura Esterna
I= Finitura Interna

E= External Finish
I= Internal Finish

Optic Flood 2700K

- E I On board dimmer
- 03.9626.40A
- 03.9626.14A
- E I Dali Version
- 03.9626.40BDA
- 03.9626.14BDA
- E I **Casambi Integrated
- 03.9626.40ACB
- 03.9626.14ACB

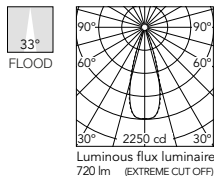

Beam Angle: 33°

h(m)	E(lx)	D(m)
1	2250	0.60
2	563	1.19
3	250	1.79
4	141	2.39
5	90	2.99

Luminous flux luminaire 720 lm (EXTREME CUT OFF)

Optic Flood 3000K

- E I On board dimmer
- 03.9636.40A
- 03.9636.14A
- E I Dali Version
- 03.9636.40BDA
- 03.9636.14BDA
- E I **Casambi Integrated
- 03.9636.40ACB
- 03.9636.14ACB

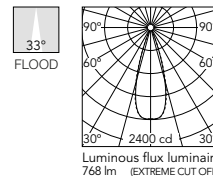

Beam Angle: 33°

h(m)	E(lx)	D(m)
1	2400	0.60
2	600	1.19
3	267	1.79
4	150	2.39
5	96	2.99

Luminous flux luminaire 768 lm (EXTREME CUT OFF)

2700K

- E I On board dimmer
- 03.9625.40A
- 03.9625.14A
- E I Dali Version
- 03.9625.40BDA
- 03.9625.14BDA
- E I **Casambi Integrated
- 03.9625.40ACB
- 03.9625.14ACB

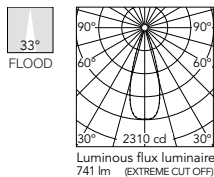

Beam Angle: 33°

h(m)	E(lx)	D(m)
1	2310	0.59
2	577	1.18
3	257	1.78
4	144	2.37
5	92	2.96

Luminous flux luminaire 741 lm (EXTREME CUT OFF)

3000K

- E I On board dimmer
- 03.9635.40A
- 03.9635.14A
- E I Dali Version
- 03.9635.40BDA
- 03.9635.14BDA
- E I **Casambi Integrated
- 03.9635.40ACB
- 03.9635.14ACB

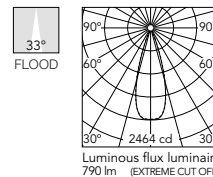

Beam Angle: 33°

h(m)	E(lx)	D(m)
1	2464	0.59
2	616	1.18
3	274	1.78
4	154	2.37
5	99	2.96

Luminous flux luminaire 790 lm (EXTREME CUT OFF)

2700K

- E I On board dimmer
- 03.9627.40A
- 03.9627.14A
- E I Dali Version
- 03.9627.40BDA
- 03.9627.14BDA
- E I **Casambi Integrated
- 03.9627.40ACB
- 03.9627.14ACB

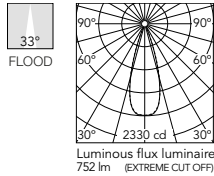

Beam Angle: 33°

h(m)	E(lx)	D(m)
1	2330	0.60
2	582	1.19
3	259	1.79
4	146	2.38
5	93	2.98

Luminous flux luminaire 752 lm (EXTREME CUT OFF)

3000K

- E I On board dimmer
- 03.9637.40A
- 03.9637.14A
- E I Dali Version
- 03.9637.40BDA
- 03.9637.14BDA
- E I **Casambi Integrated
- 03.9637.40ACB
- 03.9637.14ACB

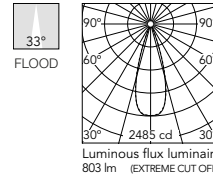

Beam Angle: 33°

h(m)	E(lx)	D(m)
1	2485	0.60
2	621	1.19
3	276	1.79
4	155	2.38
5	99	2.98

Luminous flux luminaire 803 lm (EXTREME CUT OFF)

2700K

- E I On board dimmer
- 03.9628.40A
- 03.9628.14A
- E I Dali Version
- 03.9628.40BDA
- 03.9628.14BDA
- E I **Casambi Integrated
- 03.9628.40ACB
- 03.9628.14ACB

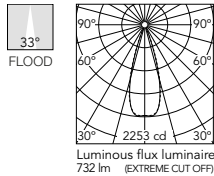

Beam Angle: 33°

h(m)	E(lx)	D(m)
1	2253	0.60
2	563	1.20
3	250	1.79
4	141	2.39
5	90	2.99

Luminous flux luminaire 732 lm (EXTREME CUT OFF)

3000K

- E I On board dimmer
- 03.9638.40A
- 03.9638.14A
- E I Dali Version
- 03.9638.40BDA
- 03.9638.14BDA
- E I **Casambi Integrated
- 03.9638.40ACB
- 03.9638.14ACB

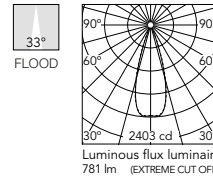

Beam Angle: 33°

h(m)	E(lx)	D(m)
1	2403	0.60
2	601	1.20
3	267	1.79
4	150	2.39
5	96	2.99

Luminous flux luminaire 781 lm (EXTREME CUT OFF)

** Il sistema di controllo degli apparecchi in versione Casambi si regola direttamente tramite bluetooth con l'applicazione dedicata FLOS Control® by Casambi / The control system with the Casambi version of light fixtures is directly and individually regulated wirelessly using the application FLOS Control® by Casambi.

**Optic Wide Flood
2700K**

- E I On board dimmer
- 03.9661.40A
- 03.9661.14A
- E I Dali Version
- 03.9661.40BDA
- 03.9661.14BDA
- E I **Casambi Integrated
- 03.9661.40ACB
- 03.9661.14ACB

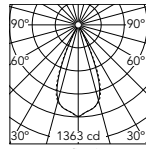

Beam Angle: 47°

h(m)	E(lx)	D(m)
1	1363	0.83
2	341	1.67
3	151	2.50
4	85	3.34
5	55	4.17

Luminous flux luminaire
731 lm

**Optic Wide Flood
3000K**

- E I On board dimmer
- 03.9665.40A
- 03.9665.14A
- E I Dali Version
- 03.9665.40BDA
- 03.9665.14BDA
- E I **Casambi Integrated
- 03.9665.40ACB
- 03.9665.14ACB

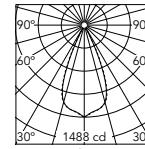

Beam Angle: 47°

h(m)	E(lx)	D(m)
1	1488	0.84
2	372	1.69
3	165	2.53
4	93	3.38
5	60	4.22

Luminous flux luminaire
784 lm

2700K

- E I On board dimmer
- 03.9660.40A
- 03.9660.14A
- E I Dali Version
- 03.9660.40BDA
- 03.9660.14BDA
- E I **Casambi Integrated
- 03.9660.40ACB
- 03.9660.14ACB

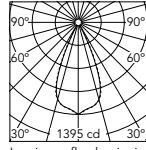

Beam Angle: 47°

h(m)	E(lx)	D(m)
1	1395	0.84
2	349	1.69
3	155	2.53
4	87	3.38
5	56	4.22

Luminous flux luminaire
735 lm

3000K

- E I On board dimmer
- 03.9664.40A
- 03.9664.14A
- E I Dali Version
- 03.9664.40BDA
- 03.9664.14BDA
- E I **Casambi Integrated
- 03.9664.40ACB
- 03.9664.14ACB

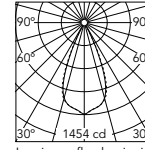

Beam Angle: 47°

h(m)	E(lx)	D(m)
1	1454	0.83
2	363	1.67
3	162	2.50
4	91	3.34
5	58	4.17

Luminous flux luminaire
780 lm

2700K

- E I On board dimmer
- 03.9662.40A
- 03.9662.14A
- E I Dali Version
- 03.9662.40BDA
- 03.9662.14BDA
- E I **Casambi Integrated
- 03.9662.40ACB
- 03.9662.14ACB

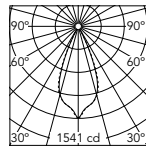

Beam Angle: 45°

h(m)	E(lx)	D(m)
1	1541	0.80
2	385	1.60
3	171	2.40
4	96	3.19
5	62	3.99

Luminous flux luminaire
739 lm

3000K

- E I On board dimmer
- 03.9666.40A
- 03.9666.14A
- E I Dali Version
- 03.9666.40BDA
- 03.9666.14BDA
- E I **Casambi Integrated
- 03.9666.40ACB
- 03.9666.14ACB

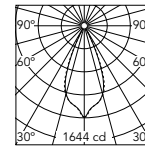

Beam Angle: 45°

h(m)	E(lx)	D(m)
1	1644	0.80
2	411	1.60
3	183	2.40
4	103	3.19
5	66	3.99

Luminous flux luminaire
789 lm

2700K

- E I On board dimmer
- 03.9663.40A
- 03.9663.14A
- E I Dali Version
- 03.9663.40BDA
- 03.9663.14BDA
- E I **Casambi Integrated
- 03.9663.40ACB
- 03.9663.14ACB

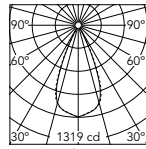

Beam Angle: 47°

h(m)	E(lx)	D(m)
1	1319	0.84
2	330	1.69
3	147	2.53
4	82	3.38
5	53	4.22

Luminous flux luminaire
716 lm

3000K

- E I On board dimmer
- 03.9667.40A
- 03.9667.14A
- E I Dali Version
- 03.9667.40BDA
- 03.9667.14BDA
- E I **Casambi Integrated
- 03.9667.40ACB
- 03.9667.14ACB

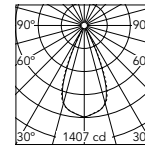

Beam Angle: 47°

h(m)	E(lx)	D(m)
1	1407	0.84
2	352	1.69
3	156	2.53
4	88	3.38
5	56	4.22

Luminous flux luminaire
764 lm

** Il sistema di controllo degli apparecchi a versione Casambi si regola direttamente tramite bluetooth con l'applicazione dedicata FLOS Control® by Casambi / The control system with the Casambi version of light fixtures is directly and individually regulated wirelessly using the application FLOS Control® by Casambi.

THE RUNNING MAGNET – LIGHT MODULES

Light Shadow Wall-Washer

Light Source: Power LED 10,8W - 4x270 lm - 2700K/CRI 90 / 10,8W - 4x285 lm - 3000K/CRI 90

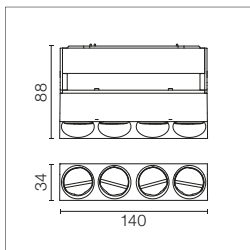

- LED INCL
- III
- 0.34 Kg
- IP 20
- CE
- F
- GWT 850°
- DALI

Modulo di illuminazione LED con 4 faretti e ad abbagliamento limitato, installabili sul sistema The Running Magnet.
Convertitore elettronico corrente DC/DC incorporato.
Per il controllo bluetooth dei moduli luminosi selezionare le versioni con Casambi integrato.

LED lighting module, with 4 spotlights and low glare, to be installed in the The Running Magnet system.
DC/DC, built-in electronic current converter.
For wireless lighting control, choose integrated Casambi versions.

2700K

- On board dimmer
- 03.9905.40A
- 03.9905.14A
- Dali Version
- 03.9905.40BDA
- 03.9905.14BDA
- **Casambi Integrated
- 03.9905.40ACB
- 03.9905.14ACB

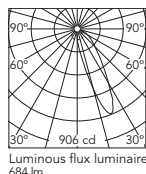

Beam Angle: 46°

h(m)	E(lx)	D(m)
1	906	0.48
2	227	0.97
3	101	1.45
4	57	1.94
5	36	2.42

3000K

- On board dimmer
- 03.9904.40A
- 03.9904.14A
- Dali Version
- 03.9904.40BDA
- 03.9904.14BDA
- **Casambi Integrated
- 03.9904.40ACB
- 03.9904.14ACB

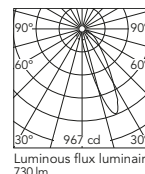

Beam Angle: 46°

h(m)	E(lx)	D(m)
1	967	0.48
2	242	0.97
3	107	1.45
4	60	1.94
5	39	2.42

String Light Sphere

Light Source: Power LED 16W - 1310 lm - 2700K/CRI 90 / 16W - 1404 lm - 3000K/CRI 90

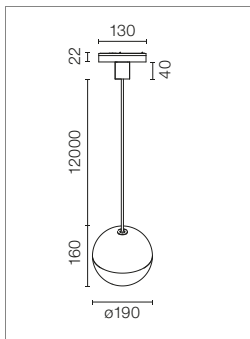

- GWT 850°
- 30 - 100% DIMMER
- 1.27 Kg
- III
- SPHERE
- 1 - 100% DALI
- 1.15 Kg
- IP 20
- LED INCL
- CONE
- CE
- F

Modulo di illuminazione LED generale da installare nel sistema The Running Magnet. Convertitore elettronico di corrente DC/DC integrato.
Per il controllo bluetooth dei moduli luminosi selezionare le versioni con Casambi integrato.

General lighting LED module to be installed in The Running Magnet System. Built-in DC/DC electronic voltage converter.
For wireless lighting control, choose integrated Casambi versions.

Spot Module No DALI:
Massimo 9 spot per ciascun driver.

Spot Module No DALI:
Maximum 9 spots for a single driver.

String Light Cone

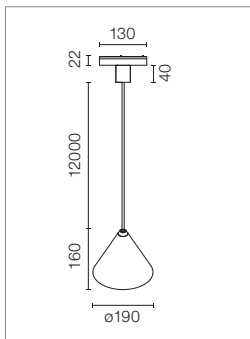

String Light Sphere 2700K

- On board dimmer
- 03.6295.14
- Dali Version
- 03.6295.14.DA
- **Casambi Integrated
- 03.6295.14.CB

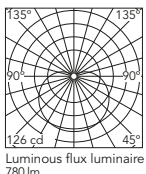

Beam Angle: 114°

h(m)	E(lx)	D(m)
1	195	3.09
2	49	6.17
3	22	9.26
4	12	12.34
5	8	15.43

String Light Sphere 3000K

- On board dimmer
- 03.6296.14
- Dali Version
- 03.6296.14.DA
- **Casambi Integrated
- 03.6296.14.CB

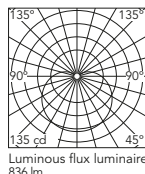

Beam Angle: 114°

h(m)	E(lx)	D(m)
1	210	3.09
2	52	6.17
3	23	9.26
4	13	12.34
5	8	15.43

String Light Cone 2700K

- On board dimmer
- 03.6297.14
- Dali Version
- 03.6297.14.DA
- **Casambi Integrated
- 03.6297.14.CB

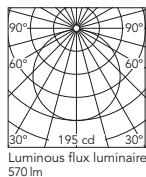

String Light Cone 3000K

- On board dimmer
- 03.6298.14
- Dali Version
- 03.6298.14.DA
- **Casambi Integrated
- 03.6298.14.CB

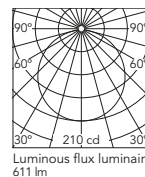

THE RUNNING MAGNET – LIGHT MODULES

Mini Glo-Ball

Light Source: Power LED 7W - 800 lm - 2700K/CRI 80 / 7W - 880 lm - 3000K/CRI 80

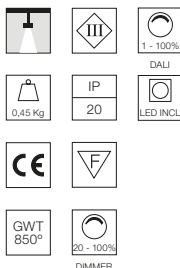
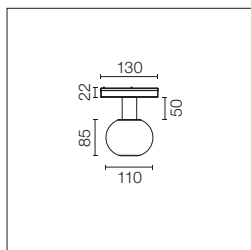

Modulo di illuminazione LED generale da installare nel sistema The Running Magnet. Convertitore elettronico di corrente DC/DC integrato. Per il controllo bluetooth dei moduli luminosi selezionare le versioni con Casambi integrato.

General lighting LED module to be installed in The Running Magnet System. Built-in DC/DC electronic voltage converter. For wireless lighting control, choose integrated Casambi versions.

Spot Module No DALI:
Massimo 21 spot per ciascun driver.
Spot Module DALI:
Massimo 14 spot per ciascun driver.

Spot Module No DALI:
Maximum 21 spots for a single driver.
Spot Module DALI:
Maximum 14 spots for a single driver.

2700K

On board dimmer

03.6260.14B

Dali Version

03.6260.14ADA

*Casambi Integrated

03.6260.14.CB

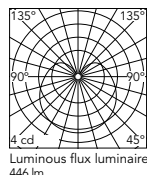

Luminous flux luminaire
446 lm

3000K

On board dimmer

03.6261.14B

Dali Version

03.6261.14ADA

*Casambi Integrated

03.6261.14.CB

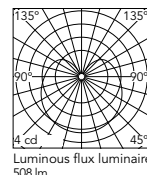

Luminous flux luminaire
508 lm

Mini Glo-Ball S

Light Source: Power LED 3,5W - 400 lm - 2700K/CRI 80 / 3,5W - 440 lm - 3000K/CRI 80

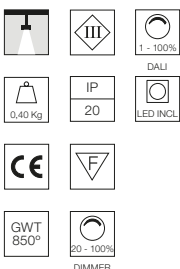
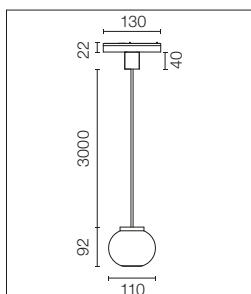

Modulo di illuminazione LED generale da installare nel sistema The Running Magnet. Convertitore elettronico di corrente DC/DC integrato. Per il controllo bluetooth dei moduli luminosi selezionare le versioni con Casambi integrato.

General lighting LED module to be installed in The Running Magnet System. Built-in DC/DC electronic voltage converter. For wireless lighting control, choose integrated Casambi versions.

Spot Module No DALI:
Massimo 21 spot per ciascun driver.
Spot Module DALI:
Massimo 14 spot per ciascun driver.

Spot Module No DALI:
Maximum 21 spots for a single driver.
Spot Module DALI:
Maximum 14 spots for a single driver.

2700K

On board dimmer

03.6262.14B

Dali Version

03.6262.14ADA

**Casambi Integrated

03.6262.14.CB

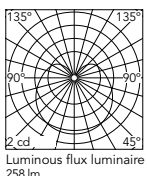

Luminous flux luminaire
258 lm

3000K

On board dimmer

03.6263.14B

Dali Version

03.6263.14ADA

**Casambi Integrated

03.6263.14.CB

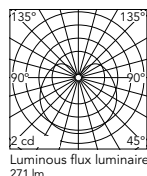

Luminous flux luminaire
271 lm

Find Me 1 Suspension

Light Source: Power LED 8W - 560 lm - 2700K/CRI 90 / 8W - 600 lm - 3000K/CRI 90

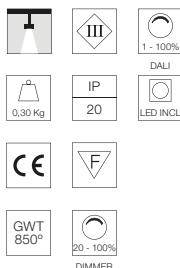
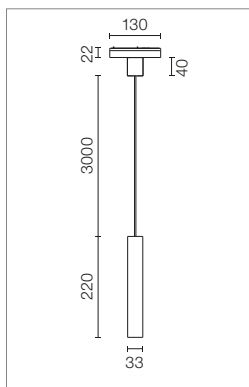

Modulo di illuminazione LED d'accento da installare nel sistema The Running Magnet. Convertitore elettronico di corrente DC/DC integrato.

Per il controllo bluetooth dei moduli luminosi selezionare le versioni con Casambi integrato.

Accent lighting LED module to be installed in The Running Magnet System. Built-in DC/DC electronic voltage converter.

For wireless lighting control, choose integrated Casambi versions.

Spot Module No DALI:
Massimo 21 spot per ciascun driver.

Spot Module DALI:
Massimo 14 spot per ciascun driver.

Spot Module No DALI:
Maximum 21 spots for a single driver.

Spot Module DALI:
Maximum 14 spots for a single driver.

2700K

On board dimmer

03.6272.30D
03.6272.06D
03.6272.14D

Dali Version

03.6272.30EDA
03.6272.06EDA
03.6272.14EDA

**Casambi Integrated

03.6272.30DCB
03.6272.06DCB
03.6272.14DCB

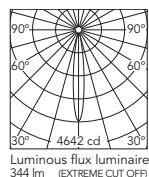

Beam Angle: 14°

h(m)	E(lx)	D(m)
1	4642	0.24
2	1160	0.48
3	516	0.72
4	290	0.95
5	186	1.19

3000K

On board dimmer

03.6273.30D
03.6273.06D
03.6273.14D

Dali Version

03.6273.30EDA
03.6273.06EDA
03.6273.14EDA

**Casambi Integrated

03.6273.30DCB
03.6273.06DCB
03.6273.14DCB

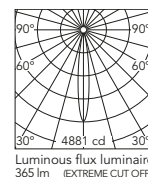

Beam Angle: 14°

h(m)	E(lx)	D(m)
1	4881	0.24
2	1220	0.49
3	542	0.73
4	305	0.97
5	195	1.21

Anthony Spot Track By Antonio Citterio

Light Source: Power LED 16W - 1310 lm - 2700K/CRI 90 / 16W - 1404 lm - 3000K/CRI 90

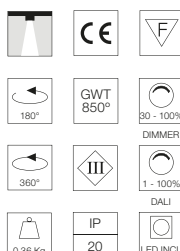
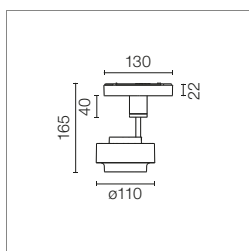

Modulo di illuminazione LED d'accento da installare nel sistema The Running Magnet. Convertitore elettronico di corrente DC/DC integrato.

Per il controllo bluetooth dei moduli luminosi selezionare le versioni con Casambi integrato.

Accent lighting LED module to be installed in The Running Magnet System. Built-in DC/DC electronic voltage converter.

For wireless lighting control, choose integrated Casambi versions.

Spot Module No DALI:
Massimo 9 spot per ciascun driver.

Spot Module No DALI:
Maximum 9 spots for a single driver.

See available accessories.

Vedi accessori disponibili.

2700K

On board dimmer

03.6277.40A
03.6277.14A

Dali Version

03.6277.40ADA
03.6277.14ADA

**Casambi Integrated

03.6277.40ACB
03.6277.14ACB

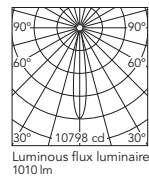

Beam Angle: 15°

h(m)	E(lx)	D(m)
1	10798	0.27
2	2700	0.54
3	1200	0.81
4	675	1.09
5	432	1.36

3000K

On board dimmer

03.6274.40A
03.6274.14A

Dali Version

03.6274.40ADA
03.6274.14ADA

**Casambi Integrated

03.6274.40ACB
03.6274.14ACB

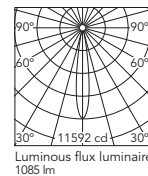

Beam Angle: 15°

h(m)	E(lx)	D(m)
1	11592	0.27
2	2898	0.54
3	1288	0.81
4	724	1.09
5	464	1.36

2700K

On board dimmer

03.6278.40A
03.6278.14A

Dali Version

03.6278.40ADA
03.6278.14ADA

**Casambi Integrated

03.6278.40ACB
03.6278.14ACB

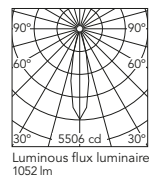

Beam Angle: 22°

h(m)	E(lx)	D(m)
1	5506	0.40
2	1376	0.79
3	612	1.19
4	344	1.58
5	220	1.98

3000K

On board dimmer

03.6275.40A
03.6275.14A

Dali Version

03.6275.40ADA
03.6275.14ADA

**Casambi Integrated

03.6275.40ACB
03.6275.14ACB

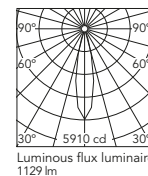

Beam Angle: 22°



h(m)	E(lx)	D(m)
1	5910	0.40
2	1478	0.79
3	657	1.19
4	369	1.58
5	236	1.98

** Il sistema di controllo degli apparecchi i versione Casambi si regola direttamente tramite bluetooth con l'applicazione dedicata FLOS Control® by Casambi / The control system with the Casambi version of light fixtures is directly and individually regulated wirelessly using the application FLOS Control® by Casambi.

THE RUNNING MAGNET

Accessori / Accessories



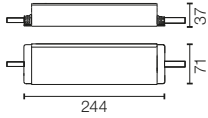

Anthony Spot Track

Lente ellittica.	Elliptical lens.		08.8418.68A
Honeycomb.	Honeycomb.		08.8419.14A
Lente flood. Per ottenere l'ottica flood (35°) richiedere Anthony Spot Medium + lente flood.	Flood lens. To obtain flood optics (35°) order Anthony Spot Medium + flood lens.		08.0050.00

Driver / Drivers

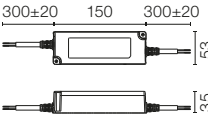
Alimentatore LED per installazione remota in quadro elettrico 24V/200W. Per evitare problemi di sovraccarico si consiglia di installare un alimentatore indipendente ogni 185W. 100/240V.	LED power supply source for remote installation in 24V/200W electric control panel. To avoid problems of overload it is recommended to install a power source every 185W. 100/240V.			RF28143
--	--	---	--	---------

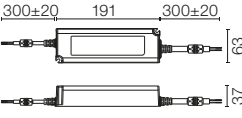
The Running Magnet Up&Down version

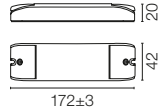
Trasformatore elettronico per LED a tensione costante (24V). 100/240V.	Electronic transformer with constant voltage (24V) for LED. 100/240V.			60W 60.9089 Up lighting max 6m
Trasformatore elettronico per LED a tensione costante (24V). 100/240V.	Electronic transformer with constant voltage (24V) for LED. 100/240V.			120W RF28688 Up lighting max 8m
Unità di controllo dimmer DALI con 1 canale per la regolazione di moduli LED, per drivers di 24V. Alimentatore non incluso.	Dimmable DALI control unit with 1 channel for 24V LED modules. Power supply not included.			60.8635

Per il dimensionamento dell'impianto, mantenere un margine di sicurezza di circa il 15% della potenza massima dell'alimentatore LED / For the sizing of the installation keep a safety margin of 15% of the maximum power of the LED power source.

THE TRACKING MAGNET

DESIGNED BY FLOS ARCHITECTURAL

FLOS
CONTROL BY CASAMBI

Available on the
App Store

GET IT ON
Google Play

RECESSED

SURFACE

SUSPENSION
UP&DOWN/DOWN



Recessed Profiles 14 Nero
14 Black

Surface/Suspension Profiles 40 Bianco
40 White

05 Alluminio Lucido
05 Polished Aluminium

14 Nero
14 Black

LIGHT MODULES

LIGHT STRIPE



LIGHT SOURCE
TOP LED
20W/m
1859 lm/m
2700K/CRI 90
1967 lm/m
3000K/CRI 90

SPOT 50



LIGHT SOURCE
POWER LED
3,5W
286 lm
2700K/CRI 90
307 lm
3000K/CRI 90

SPOT 90



LIGHT SOURCE
POWER LED
8,5W
610 lm
2700K/CRI 90
656 lm
3000K/CRI 90

SPOT 120



LIGHT SOURCE
POWER LED
12W
724 lm
2700K/CRI 90
779 lm
3000K/CRI 90

SPOT 120



LIGHT SOURCE
LED ARRAY
12,5W
1075 lm
2700K/CRI 90
1138 lm
3000K/CRI 90

SPOT 150



LIGHT SOURCE
LED ARRAY
22,5W
2000 lm
2700K/CRI 90
2115 lm
3000K/CRI 90

ANTHONY SPOT TRACK



LIGHT SOURCE
LED ARRAY
16,5W
1620 lm
2700K/CRI 90
1730 lm
3000K/CRI 90

WALLEE



LIGHT SOURCE
TOP LED
10W
773 lm
2700K/CRI 90
818 lm
3000K/CRI 90



Surface
Flos Kit
Installation



Recessed
Flos Kit
Installation



Recessed
Conventional
Installation



Anthony Spot

THE TRACKING MAGNET

Descrizione

Rinnovato sistema di illuminazione da interno, per installazioni in sospensione, in superficie e da incasso in pareti/soffitti di cartongesso. Nella nuova proposta, oltre alla conosciuta versione "On Board Dimmer", Flos fa un passo avanti, aggiungendo binario e corpi illuminanti che possono essere controllati anche con differenti sistemi di controllo remoto: DALI, 1-10V e Casambi. Esistono tre versioni di profilo (incasso, superficie/sospensione e Up&Down), tutte realizzate con estrusione di alluminio, max 3m, estruso in bianco, nero o alluminio lucido, dotato di conduttori elettrici a 48V. Inoltre, le versioni controllabili a sistema (DALI, 1-10V), sono dotate di un bus dati in grafite per la regolazione. Sistema magnetico di installazione dei corpi illuminanti. La famiglia Tracking Magnet si completa con moduli di illuminazione ambientale e d'accento, con diverse ottiche. Gli apparecchi di illuminazione sono disponibili con potenziometro integrato, dimmerazione DALI, 1-10V e Casambi.

Controllo

- Per installazione di corpi illuminanti "On Board Dimmer" usare la versione di binario "On Board Dimmer". I corpi illuminanti in versione DALI e 1-10V sono compatibili esclusivamente con il profilo in versione DALI, 1-10V. I corpi illuminanti in versione Casambi sono compatibili con tutti i profili. - Per la gestione mediante protocollo DALI è necessario collegare il bus dati di controllo direttamente al profilo. - Per il controllo 1-10V è necessario attivare il sistema di controllo (SOURCE, il driver genera il segnale di tensione) e collegare il bus dati di controllo direttamente al profilo. Se il driver è di tipo passivo (SINK) è necessaria l'unità Control Dimming box (situata tra l'unità di controllo e la guida), da ordinare separatamente nella sezione accessori. Con il sistema di gestione 1-10V tutti gli apparecchi vengono regolati contemporaneamente (in blocco o broadcast). - Per gestione con il sistema Casambi (Max. 200 apparecchi) è necessario ordinare apparecchi di illuminazione in versione Casambi. Questi sono compatibili con tutti i profili disponibili nel sistema. Per la gestione e controllo del sistema Casambi è necessario scaricare la app FLOS Control® powered by Casambi (disponibile in Apple Store e Google Play) per dispositivi mobili. Per garantire la comunicazione del segnale DALI o 1-10V sarà permesso un massimo di 20 interconnessioni tra guide tagli compresi, o 20 metri. Per garantire la comunicazione del segnale DALI o 1-10V il sarà permesso un numero massimo di 3 tagli di guida. La versione UP&DOWN presenta un'interfaccia DALI compatibile per il controllo dell'illuminazione indiretta. Attenzione: trattandosi di un componente DALI compatibile, potrebbe non rispondere a funzioni avanzate del protocollo DALI. Per ulteriori informazioni si prega di consultare le caratteristiche tecniche nella pagina web Flos. La versione UP&DOWN può essere controllata in modo indipendente mediante DALI. Compatibilità con "BTicino My Home" (consultare il Front Office).

Sistema Ottico

- Light Stripe: luce ambiente diffusa.
- Spot 50: Medium.
- Spot 90: Medium.
- Spot 120 Power LED (stessa fonte luminosa degli Spot 50 e Spot 90): Spot, Medium.
- Spot 120 LED Array (stessa fonte luminosa dello Spot 150): Medium, Flood.
- Spot 150: Spot, Medium, Flood.
- Anthony Spot: Spot, Medium, Flood (con filtro flood).
- Wallee: Illuminazione di quadri a parete.

Unità di Alimentazione

Alimentatore remoto a 48V non compreso.

Accessori

Per il modulo di illuminazione Anthony Spot esistono lenti ellittiche, flood (da utilizzare con Anthony Spot Medium) ed elementi antiabbagliamento. Per i moduli di illuminazione Spot tracking gli accessori honeycomb e filtro a croce antiabbagliamento incorporati nel prodotto. Le versioni Suspension offrono due sistemi di sospensione che si devono ordinare separatamente: aste rigide per evitare l'inclinazione del profilo (strutture rettilinee senza angoli) o per installazioni dove è necessario un sistema di fissaggio più rigido, oltre al cavo d'acciaio consigliato se nella struttura è compreso un angolo, dove l'inclinazione non comparirà mai.

Informazioni Aggiuntive

La versione Recessed può essere installata solo su superfici di cartongesso di 12,5mm di spessore. The Tracking Magnet è un sistema elettrico alimentato a 48V e limitato a una corrente massima di 6.6A e 320W per evitare sovraccarichi. Lunghezza massima con un solo driver 20m. Grado di protezione IP20. Adatti ad installazioni su superfici normalmente infiammabili.

Conformità e Marchi di Qualità

Apparecchio conforme alla Normativa Tecnica Europea EN60598-1 e relative parti.

Description

Renewed indoor lighting system for surface, suspended and recessed in plasterboard wall/ceiling installation. In the new proposal, beside the successful "On Board Dimmer" version, FLOS goes one step beyond, launching both track and luminaires designed for system management in a variety of options: DALI, 1-10V and Casambi. There are three profile versions (recessed, surface/suspension and Up&Down), all manufactured with aluminium profiling of a maximum of 3m extruded in white, black or polished aluminium, provided with electric tracks powered at 48V. Furthermore, the system controlled versions (DALI, 1-10V) are equipped with graphite data bus for regulation. Luminaires are installed through a magnetic fixing system. The Tracking Magnet product group is complemented with ambient and accent lighting modules, with different optics. The light fixtures are available with potentiometer incorporated, dimmable DALI, 1-10V or Casambi for remote setting.

Control

- For installation of "On Board Dimmer" fixtures use "On Board Dimmer" track version. Luminaires DALI and 1-10V are only compatible with track DALI, 1-10V. Casambi luminaires can be installed on all profiles available in the system. - To manage using DALI protocol, it is necessary to connect the control data bus directly to the profile. - For the 1-10V management, the control system needs to be active (SOURCE, the controller generates the power signal) and the control data bus needs to be directly connected to the profile. If the controller is passive (SINK), the Control Dimming box unit will be necessary. It is located between the control unit and the track, and it must be ordered separately from the accessories department. In the 1-10V management system, all luminaires are dimmed at the same time (as a block or broadcast). - For Casambi management (Max. 200 luminaires) it is mandatory to use fixtures in the Casambi version, these are compatible with all profiles available in the system. For managing and controlling the Casambi system, the FLOS Control® app powered by Casambi for mobile devices is necessary (available in the Apple Store and Google Play). Maximum number of track interconnections to guarantee the communication of the DALI or 1-10V signal: 20 interconnections including cuts, or 20 meters. Maximum number of track cuts to guarantee the communication of the DALI or 1-10V signal: 3 cuts. The UP&DOWN version has a compatible DALI interface for controlling indirect lighting. Please note that since it is a DALI compatible component, it may not respond to advanced DALI protocol functions. For more information, see the technical specifications section on the Flos website. The UP&DOWN version can be controlled independently via DALI. Compatible with "BTicino My home" (please consult Front Office).

Optic system

- Light Stripe: diffuse ambient light.
- Spot 50: Medium.
- Spot 90: Medium.
- Spot 120 Power LED (same light source as the Spot 50 and Spot 90): Spot, Medium.
- Spot 120 LED Array (same light source as the Spot 150): Medium, Flood.
- Spot 150: Spot, Medium, Flood.
- Anthony Spot: Spot, Medium, Flood (with flood filter).
- Wallee: Wall frame lighting.

Power Supply

Remote 48V power supply not included.

Accessories

For the Anthony Spot lighting module there are elliptical, flood lenses (to be used with Anthony Spot Medium) and screening elements. For the Spot tracking lighting modules, the honeycomb and screening crossbrace accessories are incorporated in the product. The Suspension versions offer two suspension systems that must be ordered separately: rigid bars to stop the profile tilting (straight structures with no corners) or for installations requiring a more rigid fixture system, and steel cable, recommended if a corner is included in the structure, where the tilt will not appear in any case.

Additional Information

Recessed version only to be installed in 12.5mm thick plasterboard surfaces. The Tracking Magnet is a 48V electrical system limited to a maximum power current of 6.6A and 320W to avoid overloads. Maximum length with a single power source is 20 m. IP20 protection grade. Suitable for installation on normally inflammable surfaces.

Compliance of Standards and Quality Marks

EN60598-1 European Technical Standards and any subsequent additions.

HOW TO ORDER

1 CHOOSE YOUR PROFILE AND LENGTH

RECESSED PROFILE

L: 1 / 1,5 / 2 / 2,5 / 3 m

SURFACE/SUSPENSION DOWN PROFILE

L: 1 / 1,5 / 2 / 2,5 / 3 m

SUSPENSION UP&DOWN PROFILE

L: 1 / 1,5 / 2 / 2,5 / 3 m

2 COMPLETE WITH MOUNTING ACCESSORIES

Feed connector 	End cap
Intermediate connector 	90° Corner
Straight Flexible/Electrical corner 	mechanical joint
Inner corner 	Outer corner
mechanical joint 	mechanical joint

Feed connector 	End cap
Intermediate connector 	90° Corner
Straight Flexible/Electrical corner 	mechanical joint
Inner corner 	
mechanical joint 	

Power connector profile 	End cap
Intermediate connector 	90° Corner
Straight Flexible/Electrical corner 	mechanical joint
Intermediate suspension kit 	

Recessed installation

Accessories

Fixed ceiling kit or Adjustable ceiling kit

Surface installation

Accessories

Fixed ceiling kit

Suspension Down installation

Accessories

Suspension kit

Surface rose or Recessed rose

Power cable

Rigid rod or Suspension cable

Suspension Up&Down installation

Accessories

Surface rose or Recessed rose

Power cable

Rigid rod or Suspension cable

THE TRACKING MAGNET

3 SELECT POWER SUPPLY AND CONTROL OPTION

Recessed installation Remote power supply



185W or 320W
(select the driver with the appropriate power according to the needs of your project)

On board dimmer / Casambi / Dali



185W or 320W
(select the driver with the appropriate power according to the needs of your project)



1-10V control box
(needed only to transform sink into source control signal)

1-10V

4 SELECT A LIGHT MODULE AND CONTROL OPTION

Dali / 1-10V / Casambi / On board dimmer

Light Stripe



General lighting

Spot 50



M

Surface installation Remote power supply



185W or 320W
(select the driver with the appropriate power according to the needs of your project)

On board dimmer / Casambi / Dali



185W or 320W
(select the driver with the appropriate power according to the needs of your project)



1-10V control box
(needed only to transform sink into source control signal)

1-10V

Suspension Down installation Remote power supply



185W or 320W
(select the driver with the appropriate power according to the needs of your project)

On board dimmer / Casambi / Dali



185W or 320W
(select the driver with the appropriate power according to the needs of your project)



1-10V control box
(needed only to transform sink into source control signal)

1-10V

Surface power supply

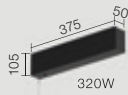

(only for 1-10V source signal)

On board dimmer / Casambi / Dali / 1-10V

Spot 90



S/M

Spot 120



S/M/F

Spot 150



S/M/F

Anthony Spot Track



S/M

Suspension Up&Down installation

Remote power supply

Surface power supply

Down instal.

Up instal.

Down instal.

Up instal.

On board dimmer



185W or 320W

Casambi

Dali



185W or 320W



DALI Push

1-10V



185W or 320W



1-10V control box
(needed only to transform sink into source control signal)



1-10V Push

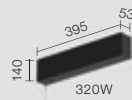

395 53 140
320W

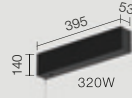

395 53 140
320W

(only for 1-10V source signal)

Wallee



General lighting

THE TRACKING MAGNET RECESSED – PROFILES

Profili

Binario elettromeccanico per installazione a incasso in soffitti di cartongesso con lunghezze da 1 m a 3 m.

Disponibile versione compatibile con apparecchi "On Board Dimmer" e Casambi. Versione compatibile con apparecchi controllabili tramite sistema DALI e 1-10V.

Angoli e connettori comuni per le due versioni di binario.

Necessario ordinare separatamente il connettore di alimentazione, i connettori intermedi e i tappi.

Disponibili angoli meccanici da 90° sullo stesso piano (elemento simmetrico per angolo sinistro e destro), angoli simmetrici da 90° su diverso livello all'interno e all'esterno.

Necessario ordinare separatamente il connettore flessibile per assicurare la continuità elettrica negli angoli.

Non è possibile installare gli spot negli angoli.

Kit di fissaggio, fissi o regolabili, disponibili (opzionale). I kit di fissaggio a soffitto consentono l'installazione senza la necessità di profili di fissaggio in alluminio. Consigliato per impianti in cui si può installare il profilo Tracking Magnet prima del controsoffitto in cartongesso.

Profiles

Electromechanical profile for recessed installation in plasterboard ceilings and walls, available in lengths from 1m to 3m.

A version compatible with 'On Board Dimmer' and Casambi light fixtures is available. Version compatible with controllable lights such as DALI and 1-10V systems. Corners, connectors and accessories common for the two profile versions.

Feed connector, intermediated connector and end-caps to be ordered separately.

Mechanical 90° corners available in the same plane (symmetrical element for left and right corners), symmetrical 90° inner and outer corners in different planes.

Intermediate connectors to be ordered separately if electrical continuity on corners is required.

Corners do not admit installation of spots.

Fixed or adjustable fastening kits available (optional). The fastening kits for the roof permit installing without using aluminium fastening profiles.

Recommended for installations where the Tracking Magnet can be installed before the suspended plasterboard ceiling.

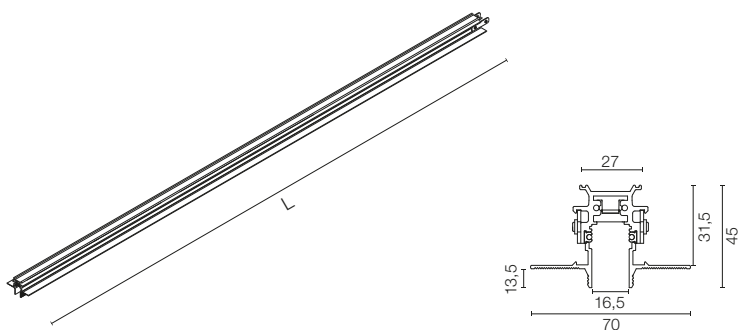

L: 1 m / 1,5 m / 2 m / 2,5 m / 3 m

Casambi / On board dimmer compatible

- L: 1000 mm
- 06.5050.14
- L: 1500 mm
- 06.5051.14
- L: 2000 mm
- 06.5052.14
- L: 2500 mm
- 06.5053.14
- L: 3000 mm
- 06.5054.14

Casambi / DALI / 1-10V compatible

- L: 1000 mm
- 06.5040.14
- L: 1500 mm
- 06.5041.14
- L: 2000 mm
- 06.5042.14
- L: 2500 mm
- 06.5043.14
- L: 3000 mm
- 06.5044.14

Angolo meccanico 90°. Per creare continuità elettrica richiedere il connettore intermedio flessibile.

90° mechanical corner. To create electrical continuity, order with the flexible intermediate connector.

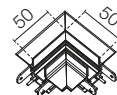

■ 06.5045.14

Angolo meccanico interno. Per creare continuità elettrica richiedere il connettore intermedio flessibile.

Inner mechanical corner. To create electrical continuity, order with the flexible intermediate connector.

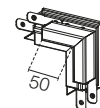

■ 06.5046.14

Angolo meccanico esterno. Per creare continuità elettrica richiedere il connettore intermedio flessibile.

Outer mechanical corner. To create electrical continuity, order with the flexible intermediate connector.

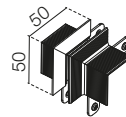

■ 06.5047.14

Connettore di alimentazione.

Feed connector.

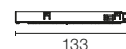

■ 08.0611.14

Connettore intermedio.

Intermediate connector.

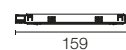

Straight
■ 08.0612.14

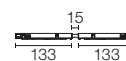

Flexible/Electrical corner
■ 08.0614.14

THE TRACKING MAGNET RECESSED – PROFILES

Kit di fissaggio a soffitto fisso
(opzionale). Kit da 2 unità.

Fixed ceiling kit (optional).
2 unit kit.

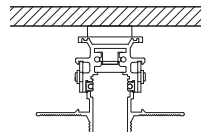

08.8866.14

Kit di fissaggio a soffitto regolabile
(opzionale). Kit da 2 unità.

Adjustable ceiling kit (optional).
2 unit kit.

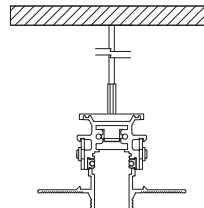

08.8867.14

Profile (mm)	Quantities Ceiling Kit
1000 / 1500	1
2000 / 2500	2
3000	2

Terminale di chiusura. Si devono
ordinare separatamente. Kit da 2
unità.

End caps. To be ordered separately.
2 unit kit.



06.5008.14

THE TRACKING MAGNET SURFACE/SUSPENSION – PROFILES

Profili

Binario elettromeccanico per installazioni in superficie o sospese, con lunghezze da 1 m a 3 m.
 Disponibile versione compatibile con apparecchi "On Board Dimmer" e Casambi. Versione compatibile con apparecchi controllabili tramite sistema DALI e 1-10V.
 Angoli e connettori comuni per le due versioni di binario.
 Necessario ordinare separatamente il connettore di alimentazione, i connettori intermedi, i tappi e gli accessori di fissaggio. Disponibili angoli meccanici da 90° sullo stesso piano (elemento simmetrico per angolo sinistro e destro) e angoli simmetrici da 90° su un piano diverso, all'interno.
 Necessario ordinare separatamente il connettore flessibile per assicurare la continuità elettrica negli angoli.
 Non è possibile installare gli spot negli angoli.

Profiles

Electromechanical profile for surface-mounting, available in lengths from 1m to 3m.
 A version compatible with 'On Board Dimmer' and Casambi light fixtures is available. Version compatible with controllable lights such as DALI and 1-10V systems. Corners, connectors and accessories common for the two profile versions.
 Feed connector, intermediated connector, end-caps and attachment accessories to be ordered separately.
 Mechanical 90° corners available in the same plane (symmetrical element for left and right corner) and 90° symmetrical internal corners in a different plane. Intermediate connectors to be ordered separately if electrical continuity on corners is required.
 Corners do not admit installation of spots.

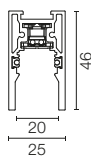
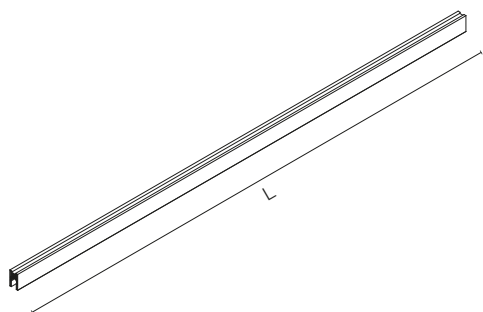

L: 1 m / 1,5 m / 2 m / 2,5 m / 3 m

Casambi / On board dimmer compatible

L: 1000 mm

- 06.5060.40
- 06.5060.05
- 06.5060.14

L: 1500 mm

- 06.5061.40
- 06.5061.05
- 06.5061.14

L: 2000 mm

- 06.5062.40
- 06.5062.05
- 06.5062.14

L: 2500 mm

- 06.5063.40
- 06.5063.05
- 06.5063.14

L: 3000 mm

- 06.5064.40
- 06.5064.14

Casambi / DALI / 1-10V compatible

L: 1000 mm

- 06.5010.40
- 06.5010.05
- 06.5010.14

L: 1500 mm

- 06.5011.40
- 06.5011.05
- 06.5011.14

L: 2000 mm

- 06.5012.40
- 06.5012.05
- 06.5012.14

L: 2500 mm

- 06.5013.40
- 06.5013.05
- 06.5013.14

L: 3000 mm

- 06.5014.40
- 06.5014.14

Angolo meccanico 90°.
 Per creare continuità elettrica richiedere il connettore intermedio flessibile.

90° mechanical corner.
 To create electrical continuity, order with the flexible intermediate connector.

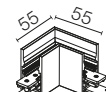

- 06.5015.40
- 06.5015.05
- 06.5015.14

Angolo interno.
 Solo per versione surface.

Inner mechanical corner.
 Only for surface version.

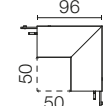

- 06.5016.40
- 06.5016.05
- 06.5016.14

Connettore di alimentazione.

Feed connector.

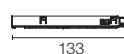

- 08.0611.14

Connettore intermedio.

Intermediate connector.

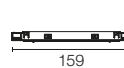

- Straight
- 08.0612.14

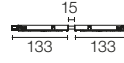

- Flexible/Electrical corner
- 08.0614.14

Terminale di chiusura. Si devono ordinare separatamente. Kit da 2 unità.

End caps. To be ordered separately. 2 unit kit.



- 06.5017.40
- 06.5017.05
- 06.5017.14

THE TRACKING MAGNET SURFACE/SUSPENSION

Accessori / Accessories

Suspension

Rosone di alimentazione di superficie. Apparecchio, cavi di alimentazione e sospensione non forniti, da ordinare separatamente. Non valido per installazioni con aste di sospensione.

Surface rose. Equipment, power cable and suspension cable not included. They must be ordered separately. Not suitable for installations with suspension rods.



08.8883.40A
08.8883.14A

Rosone di alimentazione incassato. Apparecchio, cavi di alimentazione e sospensione non forniti, da ordinare separatamente. Non valido per installazioni con aste di sospensione.

Recessed power supply rose. Equipment, power cable and suspension cable not included. They must be ordered separately. Not suitable for installations with suspension rods.



08.8889.40
08.8889.14

Cavo di alimentazione trasparente 4 poli, sezione 0,75 mm² e lunghezza 4m.

4-pole, 0.75 mm² section, 4-meter long, transparent power cable.



06.0157.00

Aste rigide per evitare l'inclinazione del profilo (strutture rettilinee senza angoli) o per installazioni in cui è necessario un sistema di fissaggio più rigido. Rigid rod to avoid the profile from tilting (rectilinear structures without corners) or to be installed in places where a more rigid fixing system is required.

Tige di sospensione con rosone 1 m filetto m6. Incompatibile con cassetta di alimentazione a superficie.

1 m suspension rod with ceiling rose. M6 thread. Not applicable with a Surface power box.



60.3014.11
60.3014.14

Set prolunga tige sospensione 1 m filetto m6.

1 m suspension rod extension set m6 thread.



60.3097.11
60.3097.14

Cavo in acciaio di 4m per sospensione, consigliato se la struttura presenta uno o più angoli, dato che in queste strutture la guida non si inclina, anche se non si compensa il peso degli apparecchi.

A 4-meter steel suspension cable is recommended if the structure includes one or more angles, since in these structures the track does not tilt even if the weight of the luminaries is not balanced.



08.8634.00

Quantità di elementi di fissaggio necessari (cavi o aste): quando si effettua l'unione di profili rettilinei, la quantità necessaria sarà il risultato della somma degli elementi necessari per ciascun profilo, secondo la tabella, meno uno per ciascuna unione.

Amount of fastening elements necessary (cables or rods): for the union of rectilinear profiles, the necessary amounts shall be the sum of the necessary elements for each profile, according to the table, one less for each joint.

Profile (mm)	Quantities Ceiling Kit
1000 / 1500	2
2000 / 2500	3
3000	4

Suspension

Scatola di alimentazione a superficie con apparecchio incluso 320W/48Vdc. Cavo trasparente a 4 poli e di 4m compreso. Non valido per installazioni con aste di sospensione. Per controllare 1-10V usare solo segnali attivi.

Surface power supply with 320W / 48Vdc driver included. 4-meter, 4-pole transparent cable included. Not suitable for installations with suspension rods. For 1-10V control, use only active signals.

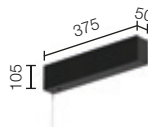

08.0600.40
08.0600.14

Kit di fissaggio a soffitto. Kit da 2 unità.

Ceiling fixing kit. 2 unit kit.



Surface
08.0615.00

Suspension
08.0616.00

THE TRACKING MAGNET SUSPENSION UP&DOWN – PROFILES

Profili

Profilo elettromeccanico per installazioni sospese.
 Gli elementi lineari in versione Up&Down includono illuminazione LED indiretta nella parte superiore del profilo.
 Disponibile versione compatibile con apparecchi "On Board Dimmer" e Casambi. Versione compatibile con apparecchi controllabili tramite sistema DALI e 1-10V.
 I profili non si possono tagliare. I tappi devono essere ordinati separatamente.
 Accessori di sospensione (cavo in acciaio e bacchette) si devono ordinare separatamente.
 Disponibili angoli da 90° sullo stesso piano (elemento simmetrico per angolo sinistro e destro).
 Gli angoli non hanno illuminazione indiretta. L'illuminazione indiretta si controlla con circuito comune alla luce diretta o separatamente.
 La versione Up&Down può essere controllata in modo indipendente mediante DALI.

Profiles

Electrical/mechanical profile for suspended installations.
 The linear elements in the Up&Down version include indirect LED lighting in the upper part of the profile.
 A version compatible with 'On Board Dimmer' and Casambi light fixtures is available. Version compatible with controllable lights such as DALI and 1-10V systems.
 The profiles cannot be cut. The end caps must be ordered separately.
 Suspension accessories (steel cable and rods) should be ordered separately.
 90° corners available in the same plan (symmetrical element for left and right corners).
 The corners do not have indirect lighting. Indirect lighting can be controlled either through the same circuit than direct lighting or independently.
 The Up&Down version can be controlled independently via DALI.

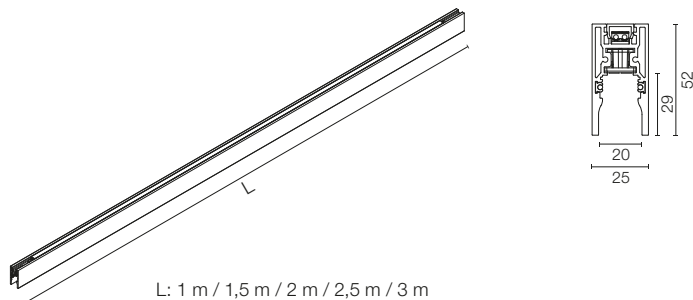

L: 1 m / 1,5 m / 2 m / 2,5 m / 3 m

Light Source: Top LED 6,5W/m Up - 630 lm/m Up - 3000K/CRI 80

<p>Casambi / On board dimmer compatible L: 1000 mm 06.5070.40 06.5070.05 06.5070.14</p>	<p>Beam Angle: 81° h(m) E(lx) D(m) 1 195 1.72 2 49 3.44 3 22 5.15 4 12 6.87 5 8 8.59</p> <p>Luminous flux luminaire 419 lm</p>	<p>Casambi / DALI / 1-10V compatible L: 1000 mm 06.5020.40 06.5020.05 06.5020.14</p>	<p>Beam Angle: 81° h(m) E(lx) D(m) 1 195 1.72 2 49 3.44 3 22 5.15 4 12 6.87 5 8 8.59</p> <p>Luminous flux luminaire 419 lm</p>
<p>L: 1500 mm 06.5071.40 06.5071.05 06.5071.14</p>	<p>Beam Angle: 81° h(m) E(lx) D(m) 1 292 1.72 2 73 3.44 3 32 5.15 4 18 6.87 5 12 8.59</p> <p>Luminous flux luminaire 629 lm</p>	<p>L: 1500 mm 06.5021.40 06.5021.05 06.5021.14</p>	<p>Beam Angle: 81° h(m) E(lx) D(m) 1 292 1.72 2 73 3.44 3 32 5.15 4 18 6.87 5 12 8.59</p> <p>Luminous flux luminaire 629 lm</p>
<p>L: 2000 mm 06.5072.40 06.5072.05 06.5072.14</p>	<p>Beam Angle: 81° h(m) E(lx) D(m) 1 390 1.72 2 97 3.44 3 43 5.15 4 24 6.87 5 16 8.59</p> <p>Luminous flux luminaire 838 lm</p>	<p>L: 2000 mm 06.5022.40 06.5022.05 06.5022.14</p>	<p>Beam Angle: 81° h(m) E(lx) D(m) 1 390 1.72 2 97 3.44 3 43 5.15 4 24 6.87 5 16 8.59</p> <p>Luminous flux luminaire 838 lm</p>
<p>L: 2500 mm 06.5073.40 06.5073.05 06.5073.14</p>	<p>Beam Angle: 81° h(m) E(lx) D(m) 1 487 1.72 2 122 3.44 3 54 5.15 4 30 6.87 5 19 8.59</p> <p>Luminous flux luminaire 1048 lm</p>	<p>L: 2500 mm 06.5023.40 06.5023.05 06.5023.14</p>	<p>Beam Angle: 81° h(m) E(lx) D(m) 1 487 1.72 2 122 3.44 3 54 5.15 4 30 6.87 5 19 8.59</p> <p>Luminous flux luminaire 1048 lm</p>
<p>L: 3000 mm 06.5074.40 06.5074.14</p>	<p>Beam Angle: 81° h(m) E(lx) D(m) 1 585 1.72 2 146 3.44 3 65 5.15 4 37 6.87 5 23 8.59</p> <p>Luminous flux luminaire 1257 lm</p>	<p>L: 3000 mm 06.5024.40 06.5024.14</p>	<p>Beam Angle: 81° h(m) E(lx) D(m) 1 585 1.72 2 146 3.44 3 65 5.15 4 37 6.87 5 23 8.59</p> <p>Luminous flux luminaire 1257 lm</p>

THE TRACKING MAGNET SUSPENSION UP&DOWN – PROFILES

Accessori / Accessories

Angolo meccanico 90°. Due connessioni finali di sospensione incluse. Cavo in acciaio non incluso. Senza illuminazione nella parte superiore. Connessioni della parte superiore inclusi.

90° mechanical angle. Two end suspension connections included. Steel cable not included. No lighting on the upper part. Upper part connections included.

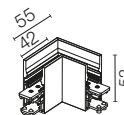

06.5025.40
06.5025.05
06.5025.14

Kit di sospensione intermedio per unione profili. Include la connessione elettrica della parte superiore. Connettore intermedio necessario da ordinare separatamente. Cavo in acciaio non incluso.

Intermediate suspension kit for joining profiles. It includes the electrical connection of the upper part. An intermediate connector is necessary. It must be ordered separately. Steel cable not included.



08.0627.00

Connettore alimentazione. Include due accessori di sospensione per gli estremi del profilo e cavo elettrico di 6 poli e 4 metri. Cavo in acciaio non incluso. Gli accessori centrali di sospensione sono compresi con il profilo.

Power connector. Includes two suspension accessories for the profile ends and a 6-pole and 4-meter long electrical cable. Steel cable not included. Central suspension accessories are included in the profile.

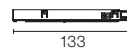

08.0626.00

Connettore intermedio.

Intermediate connector.

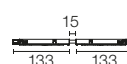
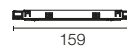

Straight

08.0612.14

Flexible/Electrical corner

08.0614.14

Terminale di chiusura. Si devono ordinare separatamente. Kit da 2 unità.

End caps. To be ordered separately. 2 unit kit.



06.5026.40
06.5026.05
06.5026.14

Rosone di alimentazione di superficie. Apparecchio, cavi di alimentazione e sospensione non forniti, da ordinare separatamente.

Surface rose. Equipment, power cable and suspension cable not included. They must be ordered separately.



08.8883.40A
08.8883.14A

Rosone di alimentazione incassato. Apparecchio, cavi di alimentazione e sospensione non forniti, da ordinare separatamente.

Recessed power supply rose. Equipment, power cable and suspension cable not included. They must be ordered separately.

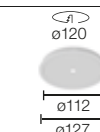

08.8889.40
08.8889.14

Aste rigide per evitare l'inclinazione del profilo (strutture rettilinee senza angoli) o per installazioni in cui è necessario un sistema di fissaggio più rigido. Rigid rod to avoid the profile from tilting (rectilinear structures without corners) or to be installed in places where a more rigid fixing system is required.

Tige di sospensione con rosone 1 m filetto m6. Incompatibile con cassetta di alimentazione a superficie.

Suspension rod with 1 m rose. m6 thread. Not applicable with a surface power box.



60.3014.11
60.3014.14

Set prolunga tige sospensione 1 m filetto m6.

1 m suspension rod extension set m6 thread.



60.3097.11
60.3097.14

Quantità di elementi di fissaggio necessaria (cavi e giunti): quando si realizza l'unione di profili lineari la quantità necessaria per installazioni ad incasso sarà pari alla somma degli elementi necessari per ogni profilo meno uno per ogni unione. Per installazioni in superficie la quantità sarà pari alla somma degli elementi.

Number of fastening elements necessary (cables and connections): when linear profiles are joined, the number necessary for recessed installation is equal to the sum of the elements necessary for each profile minus one for each junction. For surface installation, the number is equal to the sum of the elements.



08.8634.00

Profile (mm)	Quantities Ceiling Kit
1000 / 1500	2
2000 / 2500	3
3000	4

Scatola di alimentazione in superficie con apparecchio incluso 320W / 48Vdc. Cavi elettrici e in acciaio non inclusi. Non valido per installazione con aste di sospensione. DALI / 1-10V / 0-10V / No dim.

Surface power supply with driver included 320W / 48Vdc. Steel and electric cables not included. Not valid for installation with suspension rods. DALI / 1-10V / 0-10V / No dim.

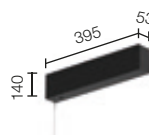

1-10V
08.0631.40
08.0631.14
DALI Version
08.0632.40
08.0632.14

THE TRACKING MAGNET – INSTALLATION PROFILES

RECESSED INSTALLATION

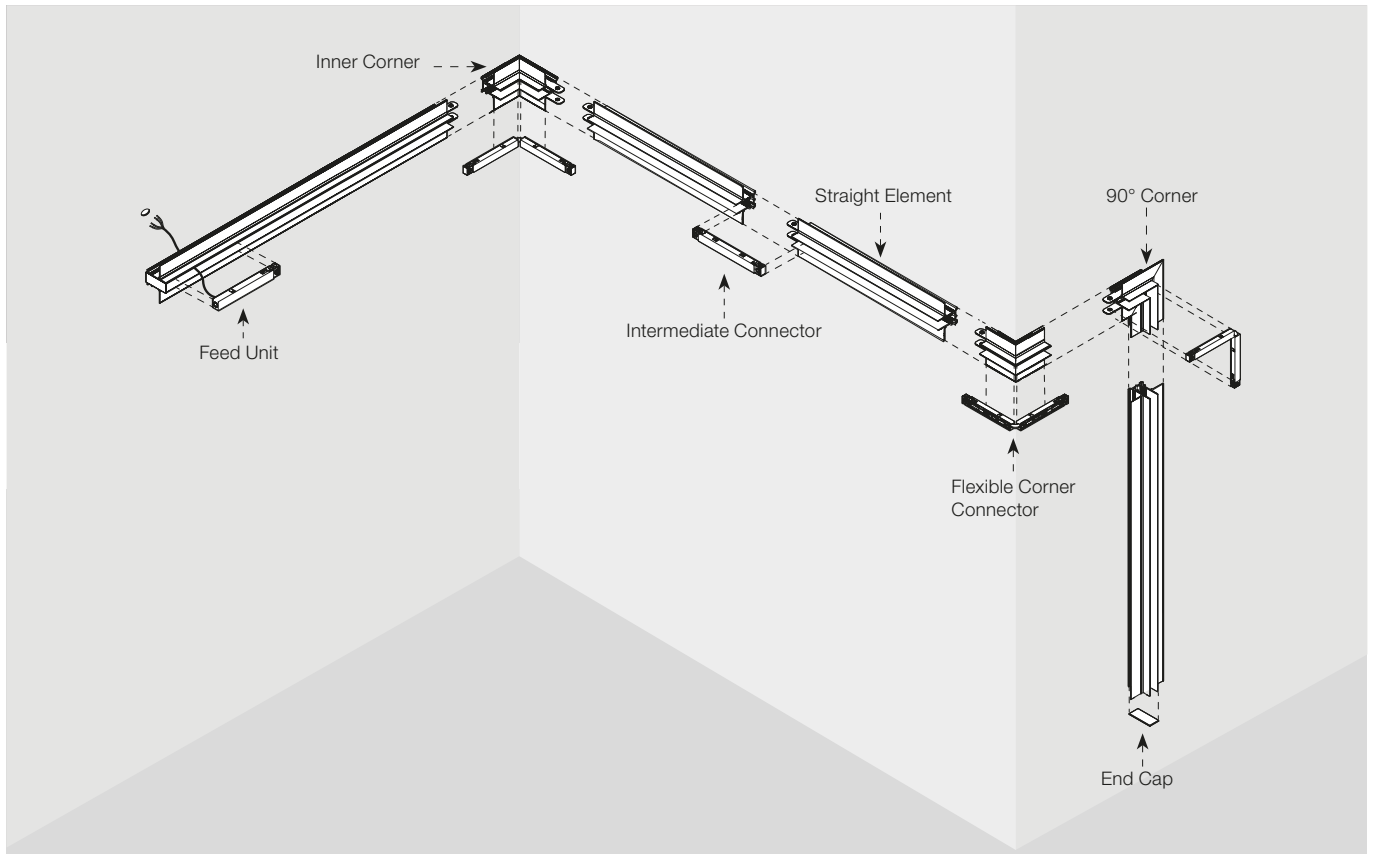

SURFACE INSTALLATION

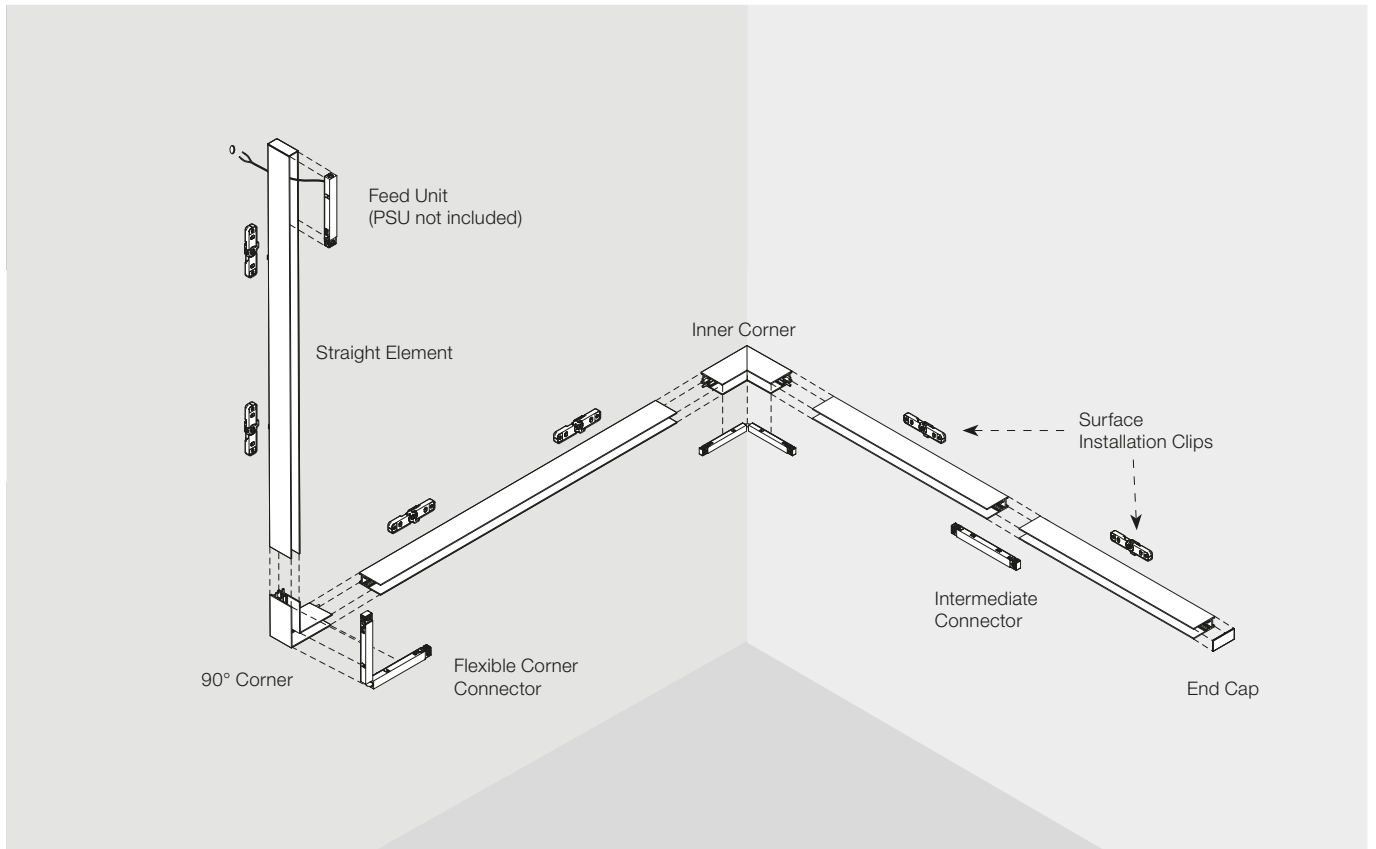

THE TRACKING MAGNET – INSTALLATION PROFILES

SUSPENSION INSTALLATION

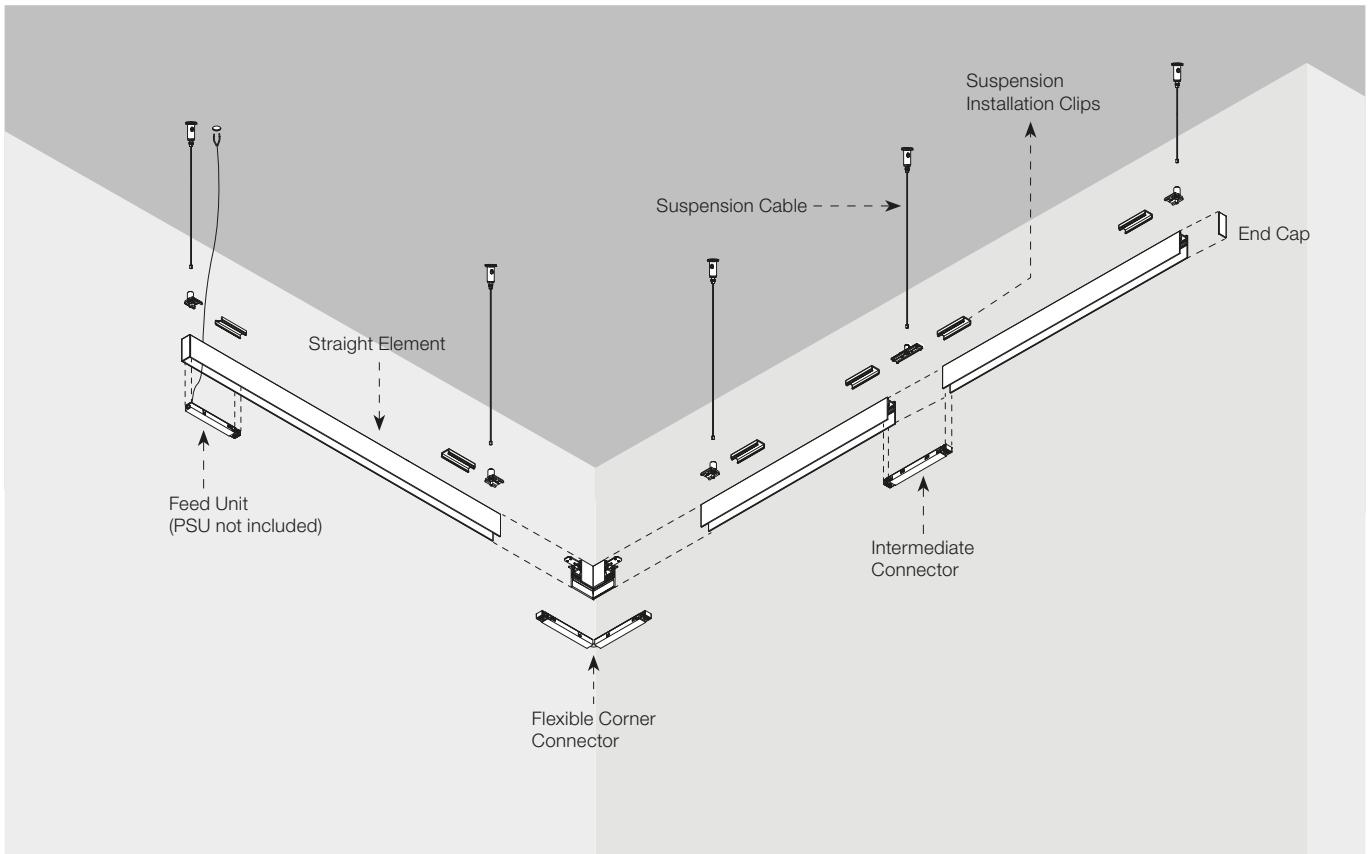

THE TRACKING MAGNET – FAQ

• Posso alimentare una struttura direttamente da un angolo?

Sì, bisogna usare uno o due connettori di alimentazione per i profili lineari vicino all'angolo, in base alla necessità di alimentare solo uno o entrambi i profili collegati.

• Can I feed a structure directly from a corner?

Yes. One or two power connectors must be used for linear profiles along with the corner, depending on whether you want to power just one of the profiles connected to the corner or both profiles.

• Posso tagliare un profilo?

I profili possono essere tagliati alla misura richiesta, meno nelle versioni Up&Down. Tagliare sempre rispettando lo spazio riservato al passaggio del cavo di alimentazione. La continuità elettrica si ottiene con il connettore intermedio. In caso di necessità di una nuova alimentazione dopo il taglio, si deve trapanare attraverso il passaggio del cavo di alimentazione, nella zona senza pista di grafite riservata a tal fine e utilizzare un connettore di alimentazione; non si deve mai trapanare attraverso le piste di grafite.

• Can I cut a profile?

Yes, profiles can be cut to the desired size, except for the Up & Down versions. Always cut respecting the space reserved for inserting the power cable. The electrical continuity is done with the intermediate connector. If you need a new power cable after cutting, you must drill the power cable's pass-through hole in the area free of graphite tracks reserved for that purpose and use a feed connector, you should never drill through the graphite tracks.

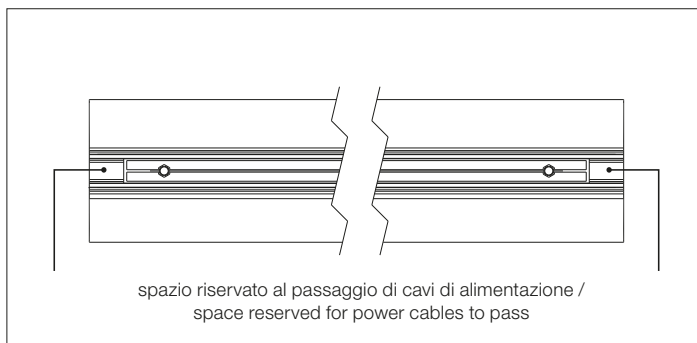
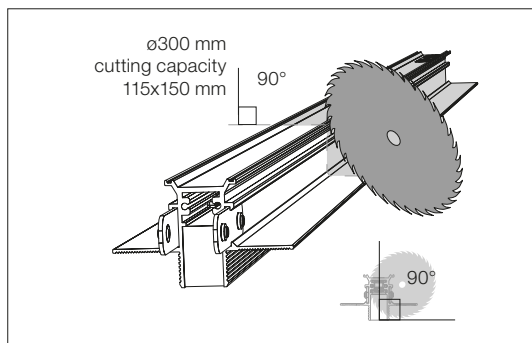

• Qual è la distanza massima permessa tra la fonte di alimentazione e il profilo?

Con gli alimentatori raccomandati, la distanza massima ammessa è:

- . Cavo da Ø 1,5 mm: 3 m
- . Cavo da Ø 2,5 mm: 5 m

• What is the maximum distance allowed between the driver and the profile?

With the recommended power sources, the maximum distance permitted is:

- . Ø1.5 mm cable: 3 m
- . Ø2.5 mm cable: 5 m

• Qual è la lunghezza massima alimentabile con una fonte di alimentazione in una struttura?

La lunghezza massima di un profilo alimentato con fonte di alimentazione è di 20 metri, o la distanza risultante da 7 interconnessioni, tagli compresi.

• What is the maximum length that can be fed with one power supply?

The maximum length of a profile that can be fed with a power supply is 20 meters or the resulting distance after 7 interconnections including cuts.

• Posso utilizzare una fonte di alimentazione diversa - meno potente?

Tutte le informazioni pubblicate sul nostro sito web, sul catalogo e sulle istruzioni di installazione si basano sui test effettuati con gli alimentatori raccomandati per i nostri prodotti. Deve essere un alimentatore da 48V con una potenza massima di 320W.

• Can I use a different, less powerful power supply?

All the information published on our website, catalogue and installation instructions meet the tests executed with the power sources recommended for our products. It must be a 48V power source with a maximum power of 320W.

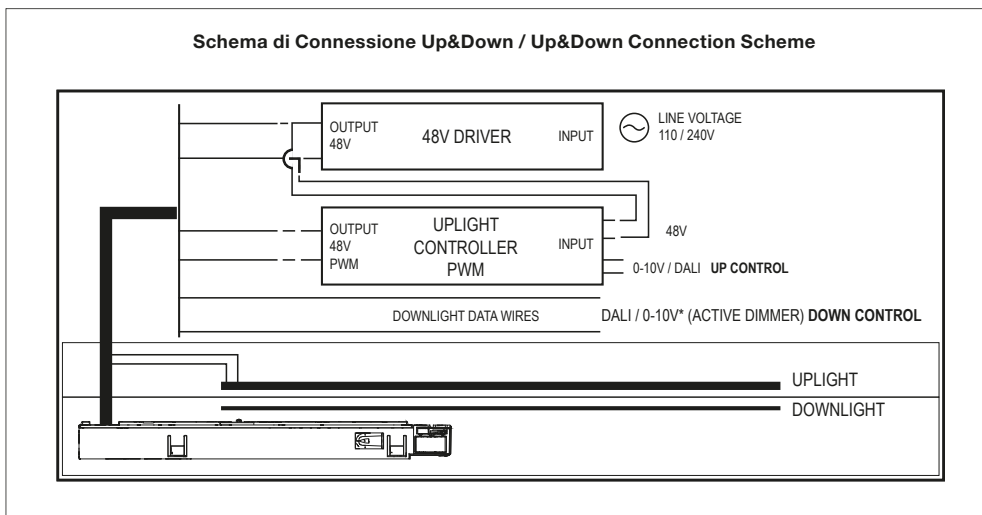

Light Stripe

Light Source: Top LED 20W/m - 1859 lm/m - 2700K/CRI 90 / 20W/m - 1967 lm/m - 3000K/CRI 90

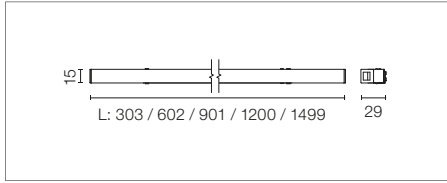

Modulo di illuminazione LED a luce diffusa da installare nel sistema The Tracking Magnet. Tappi terminali opal non compresi, da ordinare separatamente (08.0125.00 - include due esemplari).

Diffused LED light module to be installed in The Tracking Magnet System. Opal end covers not included. They must be ordered separately (08.0125.00 - two units included).

Per il controllo bluetooth dei moduli luminosi selezionare le versioni con Casambi integrato.

For wireless lighting control, choose integrated Casambi versions.

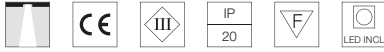

2700K

L: 300 mm - 6W - 558lm
On board dimmer

03.8000.14

*Dali Version

03.8000.14.DA

*1-10V

03.8000.14.1V

**Casambi integrated

03.8000.14.CB

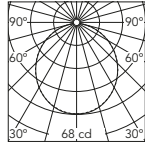

Beam Angle: 109°

h(m)	E(lx)	D(m)
1	68	2.80
2	17	5.59
3	8	8.39
4	4	11.18
5	3	13.98

Luminous flux luminaire
191 lm

3000K

L: 300 mm - 6W - 590lm
On board dimmer

03.8005.14

*Dali Version

03.8005.14.DA

*1-10V

03.8005.14.1V

**Casambi integrated

03.8005.14.CB

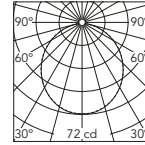

Beam Angle: 109°

h(m)	E(lx)	D(m)
1	72	2.80
2	18	5.59
3	8	8.39
4	5	11.18
5	3	13.98

Luminous flux luminaire
202 lm

2700K

L: 600 mm - 12W - 1115lm
On board dimmer

03.8001.14

*Dali Version

03.8001.14.DA

*1-10V

03.8001.14.1V

**Casambi integrated

03.8001.14.CB

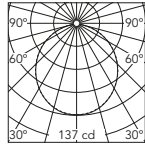

Beam Angle: 109°

h(m)	E(lx)	D(m)
1	137	2.80
2	34	5.59
3	15	8.39
4	9	11.18
5	5	13.98

Luminous flux luminaire
383 lm

3000K

L: 600 mm - 12W - 1180lm
On board dimmer

03.8006.14

*Dali Version

03.8006.14.DA

*1-10V

03.8006.14.1V

**Casambi integrated

03.8006.14.CB

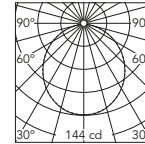

Beam Angle: 109°

h(m)	E(lx)	D(m)
1	144	2.80
2	36	5.59
3	16	8.39
4	9	11.18
5	6	13.98

Luminous flux luminaire
405 lm

2700K

L: 900 mm - 18W - 1673lm
On board dimmer

03.8002.14

*Dali Version

03.8002.14.DA

*1-10V

03.8002.14.1V

**Casambi integrated

03.8002.14.CB

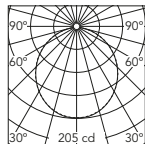

Beam Angle: 109°

h(m)	E(lx)	D(m)
1	205	2.80
2	51	5.59
3	23	8.39
4	13	11.18
5	8	13.98

Luminous flux luminaire
574 lm

3000K

L: 900 mm - 18W - 1770lm
On board dimmer

03.8007.14

*Dali Version

03.8007.14.DA

*1-10V

03.8007.14.1V

**Casambi integrated

03.8007.14.CB

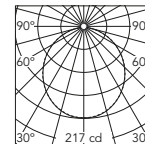

Beam Angle: 109°

h(m)	E(lx)	D(m)
1	217	2.80
2	54	5.59
3	24	8.39
4	14	11.18
5	9	13.98

Luminous flux luminaire
607 lm

2700K

L: 1200 mm - 24W - 2230lm
On board dimmer

03.8003.14

*Dali Version

03.8003.14.DA

*1-10V

03.8003.14.1V

**Casambi integrated

03.8003.14.CB

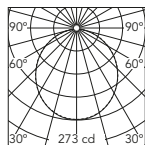

Beam Angle: 109°

h(m)	E(lx)	D(m)
1	273	2.80
2	68	5.59
3	30	8.39
4	17	11.18
5	11	13.98

Luminous flux luminaire
766 lm

3000K

L: 1200 mm - 24W - 2360lm
On board dimmer

03.8008.14

*Dali Version

03.8008.14.DA

*1-10V

03.8008.14.1V

**Casambi integrated

03.8008.14.CB

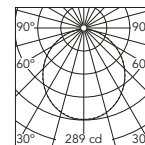

Beam Angle: 109°

h(m)	E(lx)	D(m)
1	289	2.80
2	72	5.59
3	32	8.39
4	18	11.18
5	12	13.98

Luminous flux luminaire
809 lm

2700K

L: 1500 mm - 30W - 2788lm
On board dimmer

03.8004.14

*Dali Version

03.8004.14.DA

*1-10V

03.8004.14.1V

**Casambi integrated

03.8004.14.CB

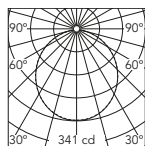

Beam Angle: 109°

h(m)	E(lx)	D(m)
1	341	2.80
2	85	5.59
3	38	8.39
4	21	11.18
5	14	13.98

Luminous flux luminaire
957 lm

3000K

L: 1500 mm - 30W - 2950lm
On board dimmer

03.8009.14

*Dali Version

03.8009.14.DA

*1-10V

03.8009.14.1V

**Casambi integrated

03.8009.14.CB

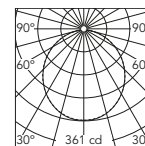

Beam Angle: 109°

h(m)	E(lx)	D(m)
1	361	2.80
2	90	5.59
3	40	8.39
4	23	11.18
5	14	13.98

Luminous flux luminaire
1012 lm

* Compatibile solo con profili in versione DALI-1-10V / Only compatible with DALI, 1-10V profile version .

** Il sistema di controllo degli apparecchi a versione Casambi si regola direttamente tramite bluetooth con l'applicazione dedicata FLOS Control® by Casambi / The control system with the Casambi version of light fixtures is directly and individually regulated wirelessly using the application FLOS Control® by Casambi.

THE TRACKING MAGNET – LIGHT MODULES

Spot 50

Light Source: Power LED 3,5W - 286 lm - 2700K/CRI 90 / 3,5W - 307 lm - 3000K/CRI 90

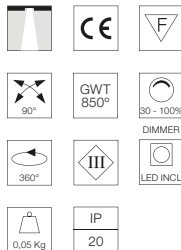
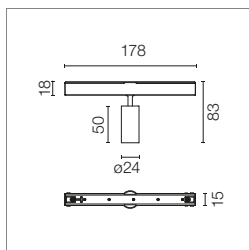

Modulo di illuminazione LED d'accento da installare nel sistema The Tracking Magnet.

Per il controllo bluetooth dei moduli luminosi selezionare le versioni con Casambi integrato.

Accessori inclusi (honeycomb e filtro a croce antiabbagliamento).

Accent lighting LED module to be installed in The Tracking Magnet System.

For wireless lighting control, choose integrated Casambi versions.

Accessories included (honeycomb and screening crosspiece).

2700K

On board dimmer

03.8032.40A
03.8032.05A
03.8032.14A

*Dali Version

03.8032.40ADA
03.8032.05ADA

03.8032.14ADA

*1-10V

03.8032.40A1V

03.8032.05A1V

03.8032.14A1V

**Casambi integrated

03.8032.40ACB

03.8032.05ACB

03.8032.14ACB

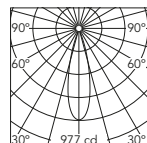

Luminous flux luminaire
205 lm (EXTREME CUT OFF)

Beam Angle: 26°

h(m)	E(lx)	D(m)
1	977	0.47
2	244	0.94
3	109	1.41
4	61	1.88
5	39	2.35

3000K

On board dimmer

03.8033.40A
03.8033.05A
03.8033.14A

*Dali Version

03.8033.40ADA
03.8033.05ADA

03.8033.14ADA

*1-10V

03.8033.40A1V

03.8033.05A1V

03.8033.14A1V

**Casambi integrated

03.8033.40ACB

03.8033.05ACB

03.8033.14ACB

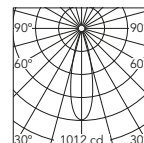

Luminous flux luminaire
212 lm (EXTREME CUT OFF)

Beam Angle: 26°

h(m)	E(lx)	D(m)
1	1012	0.47
2	253	0.94
3	112	1.41
4	63	1.88
5	40	2.35

* Compatibile solo con profili in versione DALI-1-10V / Only compatible with DALI, 1-10V profile version .

** Il sistema di controllo degli apparecchi in versione Casambi si regola direttamente tramite bluetooth con l'applicazione dedicata FLOS Control® by Casambi / The control system with the Casambi version of light fixtures is directly and individually regulated wirelessly using the application FLOS Control® by Casambi.

THE TRACKING MAGNET – LIGHT MODULES

Spot 90

Light Source: Power LED 8,5W - 610 lm - 2700K/CRI 90 / 8,5W - 656 lm - 3000K/CRI 50

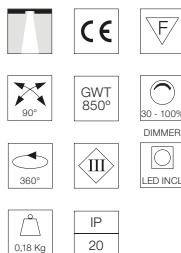
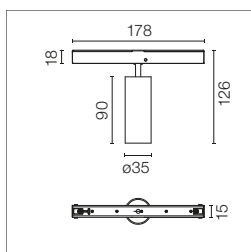

Modulo di illuminazione LED d'accento da installare nel sistema The Tracking Magnet.
Per il controllo bluetooth dei moduli luminosi selezionare le versioni con Casambi integrato.
Accessori inclusi (honeycomb e filtro a croce antiabbagliamento).

Accent lighting LED module to be installed in The Tracking Magnet System.
For wireless lighting control, choose integrated Casambi versions.
Accessories included (honeycomb and screening crosspiece).

2700K

On board dimmer

03.8042.40A
03.8042.05A
03.8042.14A

*Dali Version

03.8042.40ADA
03.8042.05ADA
03.8042.14ADA

*1-10V

03.8042.40A1V
03.8042.05A1V
03.8042.14A1V

**Casambi integrated

03.8042.40ACB
03.8042.05ACB
03.8042.14ACB

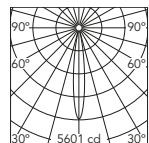

Beam Angle: 14°

h(m)	E(lx)	D(m)
1	5601	0.25
2	1400	0.49
3	622	0.74
4	350	0.98
5	224	1.23

Luminous flux luminaire 428 lm (EXTREME CUT OFF)

3000K

On board dimmer

03.8043.40A
03.8043.05A
03.8043.14A

*Dali Version

03.8043.40ADA
03.8043.05ADA
03.8043.14ADA

*1-10V

03.8043.40A1V
03.8043.05A1V
03.8043.14A1V

**Casambi integrated

03.8043.40ACB
03.8043.05ACB
03.8043.14ACB

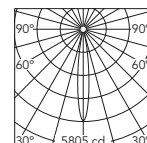

Beam Angle: 14°

h(m)	E(lx)	D(m)
1	5805	0.25
2	1451	0.49
3	645	0.74
4	363	0.98
5	232	1.23

Luminous flux luminaire 443 lm (EXTREME CUT OFF)

2700K

On board dimmer

03.8044.40A
03.8044.05A
03.8044.14A

*Dali Version

03.8044.40ADA
03.8044.05ADA
03.8044.14ADA

*1-10V

03.8044.40A1V
03.8044.05A1V
03.8044.14A1V

**Casambi integrated

03.8044.40ACB
03.8044.05ACB
03.8044.14ACB

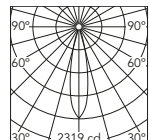

Beam Angle: 22°

h(m)	E(lx)	D(m)
1	2319	0.38
2	580	0.77
3	258	1.15
4	145	1.54
5	93	1.92

Luminous flux luminaire 392 lm (EXTREME CUT OFF)

3000K

On board dimmer

03.8045.40A
03.8045.05A
03.8045.14A

*Dali Version

03.8045.40ADA
03.8045.05ADA
03.8045.14ADA

*1-10V

03.8045.40A1V
03.8045.05A1V
03.8045.14A1V

**Casambi integrated

03.8045.40ACB
03.8045.05ACB
03.8045.14ACB

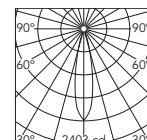

Beam Angle: 22°

h(m)	E(lx)	D(m)
1	2403	0.38
2	601	0.77
3	267	1.15
4	150	1.54
5	96	1.92

Luminous flux luminaire 406 lm (EXTREME CUT OFF)

* Compatibile solo con profili in versione DALI-1-10V / Only compatible with DALI, 1-10V profile version .

** Il sistema di controllo degli apparecchi i versione Casambi si regola direttamente tramite bluetooth con l'applicazione dedicata FLOS Control® by Casambi / The control system with the Casambi version of light fixtures is directly and individually regulated wirelessly using the application FLOS Control® by Casambi.

THE TRACKING MAGNET – LIGHT MODULES

Spot 120

Light Source: Power LED 12W - 724 lm - 2700K/CRI 90 / 12W - 779 lm - 3000K/CRI 90

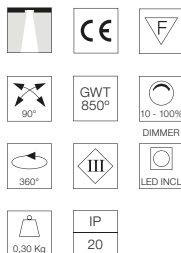
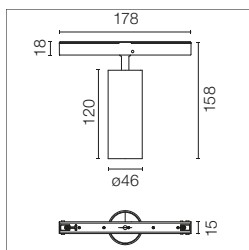

Modulo di illuminazione LED d'accento da installare nel sistema The Tracking Magnet.

Per il controllo bluetooth dei moduli luminosi selezionare le versioni con Casambi integrato.

Accessori inclusi (honeycomb e filtro a croce antiabbagliamento).

Accent lighting LED module to be installed in The Tracking Magnet System.

For wireless lighting control, choose integrated Casambi versions.

Accessories included (honeycomb and screening crosspiece).

2700K

On board dimmer

- 03.8052.40A
- 03.8052.05A
- 03.8052.14A
- *Dali Version
- 03.8052.40ADA
- 03.8052.05ADA
- 03.8052.14ADA
- *1-10V
- 03.8052.40A1V
- 03.8052.05A1V
- 03.8052.14A1V
- **Casambi integrated
- 03.8052.40ACB
- 03.8052.05ACB
- 03.8052.14ACB

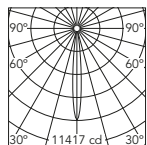

Beam Angle: 11°

h(m)	E(lx)	D(m)
1	11417	0.19
2	2854	0.37
3	1269	0.56
4	714	0.75
5	457	0.93

Luminous flux luminaire
539 lm (EXTREME CUT OFF)

3000K

On board dimmer

- 03.8053.40A
- 03.8053.05A
- 03.8053.14A
- *Dali Version
- 03.8053.40ADA
- 03.8053.05ADA
- 03.8053.14ADA
- *1-10V
- 03.8053.40A1V
- 03.8053.05A1V
- 03.8053.14A1V
- **Casambi integrated
- 03.8053.40ACB
- 03.8053.05ACB
- 03.8053.14ACB

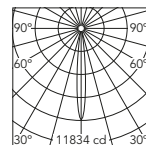

Beam Angle: 11°

h(m)	E(lx)	D(m)
1	11834	0.19
2	2958	0.37
3	1315	0.56
4	740	0.75
5	473	0.93

Luminous flux luminaire
558 lm (EXTREME CUT OFF)

2700K

On board dimmer

- 03.8054.40A
- 03.8054.05A
- 03.8054.14A
- *Dali Version
- 03.8054.40ADA
- 03.8054.05ADA
- 03.8054.14ADA
- *1-10V
- 03.8054.40A1V
- 03.8054.05A1V
- 03.8054.14A1V
- **Casambi integrated
- 03.8054.40ACB
- 03.8054.05ACB
- 03.8054.14ACB

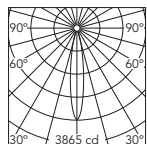

Beam Angle: 17°

h(m)	E(lx)	D(m)
1	3865	0.29
2	966	0.59
3	429	0.88
4	242	1.18
5	155	1.47

Luminous flux luminaire
487 lm (EXTREME CUT OFF)

3000K

On board dimmer

- 03.8055.40A
- 03.8055.05A
- 03.8055.14A
- *Dali Version
- 03.8055.40ADA
- 03.8055.05ADA
- 03.8055.14ADA
- *1-10V
- 03.8055.40A1V
- 03.8055.05A1V
- 03.8055.14A1V
- **Casambi integrated
- 03.8055.40ACB
- 03.8055.05ACB
- 03.8055.14ACB

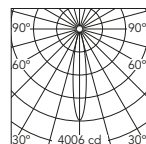

Beam Angle: 17°

h(m)	E(lx)	D(m)
1	4006	0.29
2	1001	0.59
3	445	0.88
4	250	1.18
5	160	1.47

Luminous flux luminaire
505 lm (EXTREME CUT OFF)

* Compatibile solo con profili in versione DALI-1-10V / Only compatible with DALI, 1-10V profile version .

** Il sistema di controllo degli apparecchi i versione Casambi si regola direttamente tramite bluetooth con l'applicazione dedicata FLOS Control® by Casambi / The control system with the Casambi version of light fixtures is directly and individually regulated wirelessly using the application FLOS Control® by Casambi.

THE TRACKING MAGNET – LIGHT MODULES

Spot 120

Light Source: LED Array 12,5W - 1075 lm - 2700K/CRI 90 / 12,5W - 1138 lm - 3000K/CRI 90

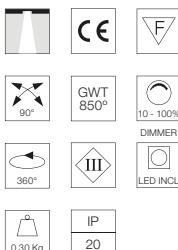
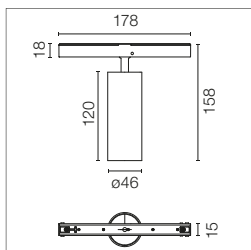

Modulo di illuminazione LED d'accento da installare nel sistema The Tracking Magnet.

Per il controllo bluetooth dei moduli luminosi selezionare le versioni con Casambi integrato.

Accessori inclusi (honeycomb e filtro a croce antiabbagliamento).

Accent lighting LED module to be installed in The Tracking Magnet System.

For wireless lighting control, choose integrated Casambi versions.

Accessories included (honeycomb and screening crosspiece).

2700K

On board dimmer

- 03.8154.40
- 03.8154.05
- 03.8154.14
- *Dali Version
- 03.8154.40.DA
- 03.8154.05.DA
- 03.8154.14.DA
- *1-10V
- 03.8154.40.1V
- 03.8154.05.1V
- 03.8154.14.1V
- **Casambi integrated
- 03.8154.40.CB
- 03.8154.05.CB
- 03.8154.14.CB

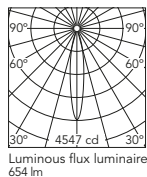

Beam Angle: 17°

h(m)	E(lx)	D(m)
1	4547	0.31
2	1137	0.61
3	505	0.92
4	284	1.23
5	182	1.53

3000K

On board dimmer

- 03.8155.40
- 03.8155.05
- 03.8155.14
- *Dali Version
- 03.8155.40.DA
- 03.8155.05.DA
- 03.8155.14.DA
- *1-10V
- 03.8155.40.1V
- 03.8155.05.1V
- 03.8155.14.1V
- **Casambi integrated
- 03.8155.40.CB
- 03.8155.05.CB
- 03.8155.14.CB

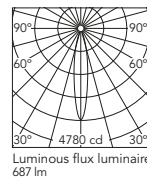

Beam Angle: 17°

h(m)	E(lx)	D(m)
1	4780	0.31
2	1195	0.61
3	531	0.92
4	299	1.23
5	191	1.53

2700K

On board dimmer

- 03.8156.40
- 03.8156.05
- 03.8156.14
- *Dali Version
- 03.8156.40.DA
- 03.8156.05.DA
- 03.8156.14.DA
- *1-10V
- 03.8156.40.1V
- 03.8156.05.1V
- 03.8156.14.1V
- **Casambi integrated
- 03.8156.40.CB
- 03.8156.05.CB
- 03.8156.14.CB

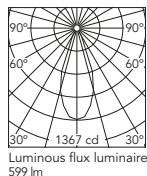

Beam Angle: 40°

h(m)	E(lx)	D(m)
1	1367	0.73
2	342	1.45
3	152	2.18
4	85	2.91
5	55	3.64

3000K

On board dimmer

- 03.8157.40
- 03.8157.05
- 03.8157.14
- *Dali Version
- 03.8157.40.DA
- 03.8157.05.DA
- 03.8157.14.DA
- *1-10V
- 03.8157.40.1V
- 03.8157.05.1V
- 03.8157.14.1V
- **Casambi integrated
- 03.8157.40.CB
- 03.8157.05.CB
- 03.8157.14.CB

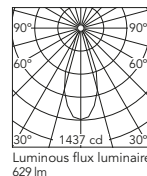

Beam Angle: 40°

h(m)	E(lx)	D(m)
1	1437	0.73
2	359	1.45
3	160	2.18
4	90	2.91
5	57	3.64

* Compatibile solo con profili in versione DALI-1-10V / Only compatible with DALI, 1-10V profile version .

** Il sistema di controllo degli apparecchi i versione Casambi si regola direttamente tramite bluetooth con l'applicazione dedicata FLOS Control® by Casambi / The control system with the Casambi version of light fixtures is directly and individually regulated wirelessly using the application FLOS Control® by Casambi.

Spot 150

Light Source: LED Array 22,5W - 2000 lm - 2700K/CRI 90 / 22,5W - 2115 lm - 3000K/CRI 90

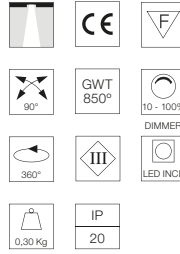
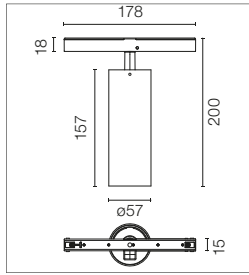

Modulo di illuminazione LED d'accento da installare nel sistema The Tracking Magnet.
Per il controllo bluetooth dei moduli luminosi selezionare le versioni con Casambi integrato.

Accent lighting LED module to be installed in The Tracking Magnet System.
For wireless lighting control, choose integrated Casambi versions.

2700K

On board dimmer

- 03.8072.40
- 03.8072.05
- 03.8072.14
- *Dali Version
- 03.8072.40.DA
- 03.8072.05.DA
- 03.8072.14.DA
- *1-10V
- 03.8072.40.1V
- 03.8072.05.1V
- 03.8072.14.1V
- **Casambi integrated
- 03.8072.40.CB
- 03.8072.05.CB
- 03.8072.14.CB

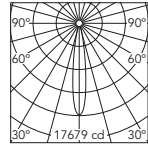
Luminous flux luminaire
1910 lm

Beam Angle: 16°			
h(m)	E(lx)	D(m)	
1	17679	0.28	
2	4420	0.56	
3	1964	0.84	
4	1105	1.12	
5	707	1.40	

3000K

On board dimmer

- 03.8073.40
- 03.8073.05
- 03.8073.14
- *Dali Version
- 03.8073.40.DA
- 03.8073.05.DA
- 03.8073.14.DA
- *1-10V
- 03.8073.40.1V
- 03.8073.05.1V
- 03.8073.14.1V
- **Casambi integrated
- 03.8073.40.CB
- 03.8073.05.CB
- 03.8073.14.CB

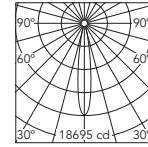
Luminous flux luminaire
2019 lm

Beam Angle: 16°			
h(m)	E(lx)	D(m)	
1	18695	0.28	
2	4674	0.56	
3	2077	0.84	
4	1168	1.12	
5	748	1.40	

2700K

On board dimmer

- 03.8074.40
- 03.8074.05
- 03.8074.14
- *Dali Version
- 03.8074.40.DA
- 03.8074.05.DA
- 03.8074.14.DA
- *1-10V
- 03.8074.40.1V
- 03.8074.05.1V
- 03.8074.14.1V
- **Casambi integrated
- 03.8074.40.CB
- 03.8074.05.CB
- 03.8074.14.CB

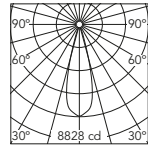
Luminous flux luminaire
1910 lm

Beam Angle: 28°			
h(m)	E(lx)	D(m)	
1	8828	0.50	
2	2207	1.00	
3	981	1.50	
4	552	2.00	
5	353	2.50	

3000K

On board dimmer

- 03.8075.40
- 03.8075.05
- 03.8075.14
- *Dali Version
- 03.8075.40.DA
- 03.8075.05.DA
- 03.8075.14.DA
- *1-10V
- 03.8075.40.1V
- 03.8075.05.1V
- 03.8075.14.1V
- **Casambi integrated
- 03.8075.40.CB
- 03.8075.05.CB
- 03.8075.14.CB

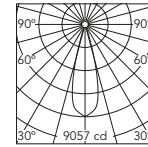
Luminous flux luminaire
1959 lm

Beam Angle: 28°			
h(m)	E(lx)	D(m)	
1	9057	0.50	
2	2264	1.00	
3	1006	1.50	
4	566	2.00	
5	362	2.50	

2700K

On board dimmer

- 03.8076.40
- 03.8076.05
- 03.8076.14
- *Dali Version
- 03.8076.40.DA
- 03.8076.05.DA
- 03.8076.14.DA
- *1-10V
- 03.8076.40.1V
- 03.8076.05.1V
- 03.8076.14.1V
- **Casambi integrated
- 03.8076.40.CB
- 03.8076.05.CB
- 03.8076.14.CB

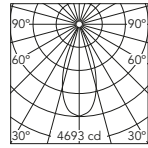
Luminous flux luminaire
1853 lm

Beam Angle: 40°			
h(m)	E(lx)	D(m)	
1	4693	0.73	
2	1173	1.46	
3	521	2.18	
4	293	2.91	
5	188	3.64	

3000K

On board dimmer

- 03.8077.40
- 03.8077.05
- 03.8077.14
- *Dali Version
- 03.8077.40.DA
- 03.8077.05.DA
- 03.8077.14.DA
- *1-10V
- 03.8077.40.1V
- 03.8077.05.1V
- 03.8077.14.1V
- **Casambi integrated
- 03.8077.40.CB
- 03.8077.05.CB
- 03.8077.14.CB

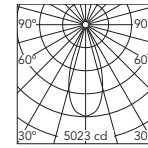
Luminous flux luminaire
1983 lm

Beam Angle: 40°			
h(m)	E(lx)	D(m)	
1	5023	0.73	
2	1256	1.46	
3	558	2.18	
4	314	2.91	
5	201	3.64	

* Compatibile solo con profili in versione DALI-1-10V / Only compatible with DALI, 1-10V profile version .

** Il sistema di controllo degli apparecchi i versione Casambi si regola direttamente tramite bluetooth con l'applicazione dedicata FLOS Control® by Casambi / The control system with the Casambi version of light fixtures is directly and individually regulated wirelessly using the application FLOS Control® by Casambi.

THE TRACKING MAGNET – LIGHT MODULES

Anthony Spot Track By Antonio Citterio

Light Source: LED Array 16,5W - 1620 lm - 2700K/CRI 90 / 16,5W - 1730 lm - 3000K/CRI 90

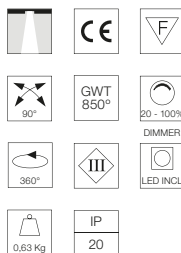
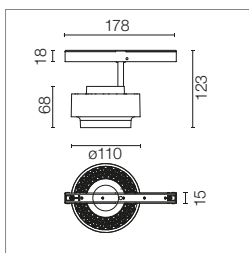

Modulo di illuminazione LED d'accento da installare nel sistema The Tracking Magnet.
Per il controllo bluetooth dei moduli luminosi selezionare le versioni con Casambi integrato.

Accent lighting LED module to be installed in The Tracking Magnet System.
For wireless lighting control, choose integrated Casambi versions.

Vedi accessori disponibili.

See available accessories.

2700K

On board dimmer

03.8025.40
03.8025.05
03.8025.14

*Dali Version

03.8025.40.DA
03.8025.05.DA

03.8025.14.DA
*1-10V

03.8025.40.1V
03.8025.05.1V
03.8025.14.1V

**Casambi integrated

03.8025.40.CB
03.8025.05.CB
03.8025.14.CB

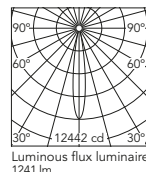

Beam Angle: 15°

h(m)	El(x)	D(m)
1	12442	0.27
2	3110	0.54
3	1382	0.81
4	778	1.07
5	498	1.34

Luminous flux luminaire
1242 lm**3000K**

On board dimmer

03.8027.40
03.8027.05
03.8027.14

*Dali Version

03.8027.40.DA
03.8027.05.DA

03.8027.14.DA
*1-10V

03.8027.40.1V
03.8027.05.1V
03.8027.14.1V

**Casambi integrated

03.8027.40.CB
03.8027.05.CB
03.8027.14.CB

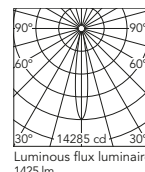

Beam Angle: 15°

h(m)	El(x)	D(m)
1	14285	0.27
2	3571	0.54
3	1587	0.81
4	893	1.07
5	571	1.34

Luminous flux luminaire
1425 lm**2700K**

On board dimmer

03.8026.40
03.8026.05
03.8026.14

*Dali Version

03.8026.40.DA
03.8026.05.DA

03.8026.14.DA
*1-10V

03.8026.40.1V
03.8026.05.1V
03.8026.14.1V

**Casambi integrated

03.8026.40.CB
03.8026.05.CB
03.8026.14.CB

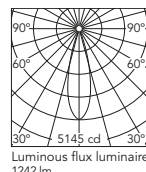

Beam Angle: 28°

h(m)	El(x)	D(m)
1	5145	0.49
2	1286	0.98
3	572	1.47
4	322	1.97
5	206	2.46

Luminous flux luminaire
1242 lm**3000K**

On board dimmer

03.8028.40
03.8028.05
03.8028.14

*Dali Version

03.8028.40.DA
03.8028.05.DA

03.8028.14.DA
*1-10V

03.8028.40.1V
03.8028.05.1V
03.8028.14.1V

**Casambi integrated

03.8028.40.CB
03.8028.05.CB
03.8028.14.CB

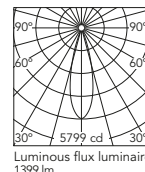

Beam Angle: 28°

h(m)	El(x)	D(m)
1	5799	0.49
2	1450	0.98
3	644	1.47
4	362	1.97
5	232	2.46

Luminous flux luminaire
1399 lm

* Compatibile solo con profili in versione DALI-1-10V / Only compatible with DALI, 1-10V profile version .

** Il sistema di controllo degli apparecchi i versione Casambi si regola direttamente tramite bluetooth con l'applicazione dedicata FLOS Control® by Casambi / The control system with the Casambi version of light fixtures is directly and individually regulated wirelessly using the application FLOS Control® by Casambi.

THE TRACKING MAGNET – LIGHT MODULES

Wallee Designed By Niels Bendtsen

Light Source: Top LED 10W - 773 lm - 2700K/CRI 90 / 10W - 818 lm - 3000K/CRI 90

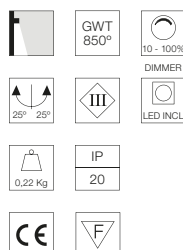
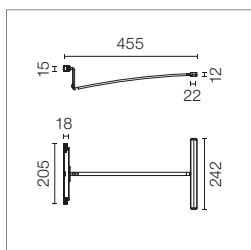

Modulo di illuminazione LED da installare nel sistema The Tracking Magnet.

Per il controllo bluetooth dei moduli luminosi selezionare le versioni con Casambi integrato.

Per l'installazione di Wallee, può essere necessaria una regolazione manuale da parte del cliente/installatore. Le informazioni si trovano nel manuale di istruzioni. Permesso solo per installazioni con Tracking Magnet Recessed e in orizzontale.

Include supporto per quadri fino a 5 kg.

Lighting LED module to be installed in The Tracking Magnet System. For wireless lighting control, choose integrated Casambi versions.

When installing Wallee, it may require a manual adjustment by the client/installer. Find information on how to carry out this adjustment in the instruction sheets. Only allowed with Tracking Magnet Recessed and horizontal installation. Includes frame holder up to 5kg.

2700K

On board dimmer

 03.8090.40

 03.8090.14

*Dali Version

 03.8090.40.DA

 03.8090.14.DA

*1-10V

 03.8090.40.1V

 03.8090.14.1V

**Casambi integrated

 03.8090.40.CB

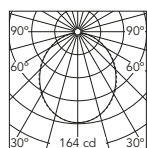
 03.8090.14.CB

Beam Angle: 103°

h(m)	E(lx)	D(m)
1	164	2.50
2	41	5.00
3	18	7.49
4	10	9.99
5	7	12.49

Luminous flux luminaire 431 lm

3000K

On board dimmer

 03.8091.40

 03.8091.14

*Dali Version

 03.8091.40.DA

 03.8091.14.DA

*1-10V

 03.8091.40.1V

 03.8091.14.1V

**Casambi integrated

 03.8091.40.CB

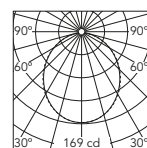



 03.8091.14.CB

Beam Angle: 103°



h(m)	E(lx)	D(m)
1	169	2.50
2	42	5.00
3	19	7.49
4	11	9.99
5	7	12.49

Luminous flux luminaire 446 lm

Accessori / Accessories**Spot 150**

Filtro a croce antiabbagliamento.	Screening crosspiece.		08.8429.00
Lente ellittica.	Elliptical lens.		08.8431.00
Lente flood.	Flood lens.		08.8432.00
Honeycomb.	Honeycomb.		08.8428.00
Cono di schermatura.	Snoot shielding cone.		<input checked="" type="checkbox"/> 08.0526.00 <input type="checkbox"/> 08.0526.40 <input checked="" type="checkbox"/> 08.0526.BW

Anthony Spot

Lente ellittica.	Elliptical lens.		08.8418.68A
Honeycomb.	Honeycomb.		08.8419.14A
Lente flood. Per ottenere l'ottica flood (35°) richiedere Anthony Spot Medium + lente flood.	Flood lens. To obtain flood optics (35°) order Anthony Spot Medium + flood lens.		08.0050.00

* Compatibile solo con profili in versione DALI-1-10V / Only compatible with DALI, 1-10V profile version.

** Il sistema di controllo degli apparecchi in versione Casambi si regola direttamente tramite bluetooth con l'applicazione dedicata FLOS Control® by Casambi / The control system with the Casambi version of light fixtures is directly and individually regulated wirelessly using the application FLOS Control® by Casambi.

THE TRACKING MAGNET

Driver / Drivers

Alimentatore LED per installazione remota, 48V/320W. 100/240 Vac.

LED power supply source for remote installation, 48V/320W. 100/240 Vac.

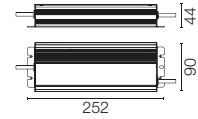

***60.8919

Alimentatore LED per installazione remota, 110Vac-135W / 220Vac-200W.

LED power supply source for remote installation, 110Vac-135W / 220Vac-200W.

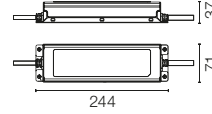

***60.9607

Scatola di controllo dimmabile 1-10V, 48V. Necessaria per trasformare sistemi di controllo 1-10V passivi (sink) in attivi (source). Per installazione remota.

Dimmable control box 1-10V, 48V. Necessary to transform sink 1-10V control systems into source ones. For remote installation.



■ 08.0613.14A

È necessario un sistema di controllo attivo (SOURCE) e il collegamento del bus di dati di controllo direttamente al profilo. Per sistemi passivi (SINK) è necessaria l'unità di controllo Dimming BOX (posizionata tra l'unità di controllo e il binario). / An active control system (SOURCE) is required and the data bus must be connected directly to the profile. For passive systems (SINK), a Dimming BOX Control unit is required (located between the control unit and the profile).

The Tracking Magnet Suspension Up&Down version

Uplight dimmer DALI Push 48V PWM per controllo di illuminazione indiretta (UP).

DALI Push 48V PWM Uplight dimmer for controlling indirect lighting (UP).



60.9678

Uplight dimmer 1-10V Push 48V PWM per controllo di illuminazione indiretta (UP).

1-10V Push 48V PWM Uplight dimmer for controlling indirect lighting (UP).



60.9395

*** Per il dimensionamento dell'impianto, mantenere un margine di sicurezza di circa il 15% della potenza massima dell'alimentatore LED. / For the sizing of the installation keep a safety margin of 15% of the maximum power of the LED power source.

THE TRACKING POWER
DESIGNED BY FLOS ARCHITECTURAL

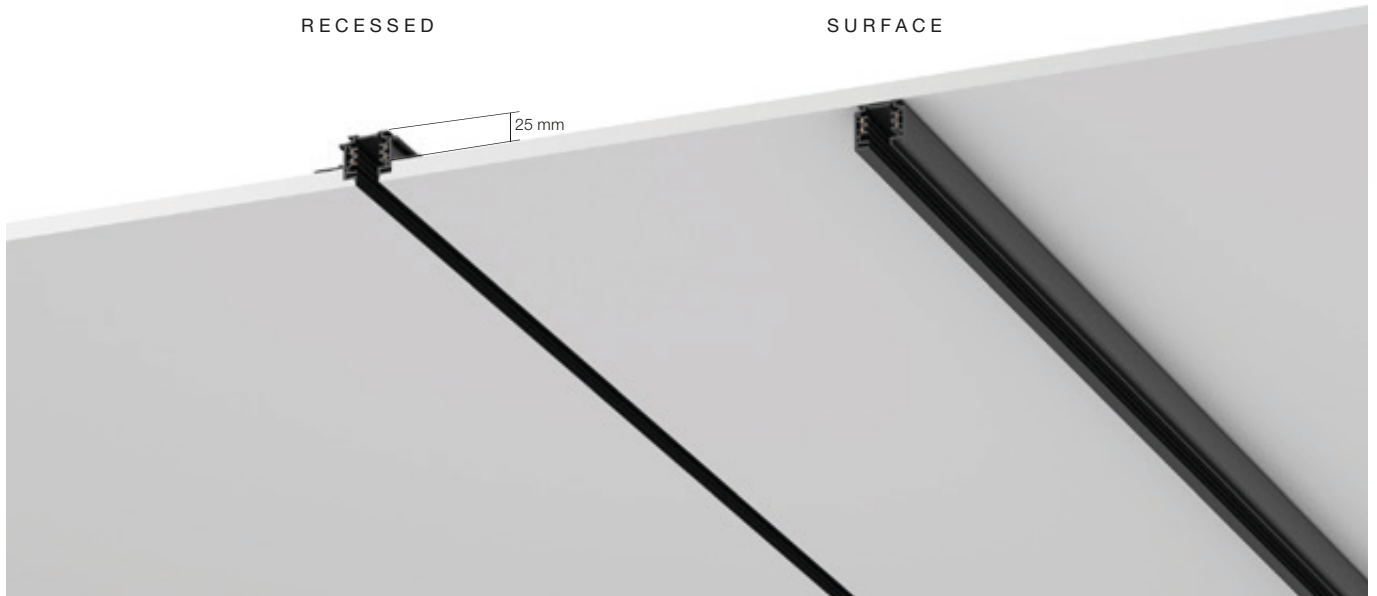

Recessed Profiles 14 Nero
 14 Black

Surface Profiles 40 Bianco
 40 White 14 Nero
 14 Black

LIGHT MODULES

UT PRO
150



LIGHT SOURCE
LED ARRAY
23,5W
2400 lm
3000K/CRI 80
1950 lm
3000K/CRI 90
2150 lm
4000K/CRI 90

UT PRO
175



LIGHT SOURCE
LED ARRAY
35,3W
4145 lm
3000K/CRI 80
3425 lm
3000K/CRI 90
3569 lm
4000K/CRI 90

UT PRO
175 LENS



LIGHT SOURCE
LED ARRAY
35,3W
3950 lm
3000K/CRI 80
3250 lm
3000K/CRI 90
3400 lm
4000K/CRI 90

UT PRO
WALL-WASHER



LIGHT SOURCE
TOP LED
25,5W
2700 lm
3000K/CRI 90
2900 lm
4000K/CRI 90

UT PRO
150 GA-69



LIGHT SOURCE
LED ARRAY
23,5W
2300 lm
3000K/CRI 80
1950 lm
3000K/CRI 90
2009 lm
4000K/CRI 90

UT PRO
175 GA-69



LIGHT SOURCE
LED ARRAY
35,3W
4145 lm
3000K/CRI 80
3425 lm
3000K/CRI 90
3569 lm
4000K/CRI 90

UT PRO
175 LENS
GA-69



LIGHT SOURCE
LED ARRAY
35,3W
3950 lm
3000K/CRI 80
3250 lm
3000K/CRI 90
3400 lm
4000K/CRI 90

UT PRO
WALL-WASHER
GA-69



LIGHT SOURCE
TOP LED
25,5W
2700 lm
3000K/CRI 90
2900 lm
4000K/CRI 90

Descrizione

Profilo trifase esclusivo per illuminazione di interni in versione a incastro a tetto, che grazie a un impatto visivo minimo offre una totale integrazione nell'architettura.

I profili strutturali del Tracking Power sono stati realizzati in alluminio estruso nero, provvisti di piste elettriche sulle quali si installano gli apparecchi con il sistema esclusivo di fissaggio Flos.

Dopo l'installazione della guida, si vedrà solo una piccola linea spessa 15 mm.

La famiglia Tracking Power si completa con un'ampia gamma di proiettori che, abbinati a un'elettronica esclusiva integrata nel corpo dell'apparecchio di illuminazione, eliminano i volumi non necessari ottenendo così una grande integrazione.

Sono disponibili soluzioni per profili trifasici standard, e non è permessa la regolazione remota.

Sistema Ottico

I moduli di luce UT Pro 150 e UT Pro 175 sono disponibili con ottiche spot, medium e flood e con riflettori di vetro borosilicato ad alta efficienza incorporato.

Il modulo di luce UT Pro 175 Lens è dotato di una lente che permette di regolare l'angolo di apertura da 13° a 56°.

Il modulo di luce UT Pro Wall-Washer offre una distribuzione luminosa omogenea in un bagnatore di parete ad alta prestazione.

Accessori

Disponibile crocetta di schermatura, lente ellittica, lente Flood e Honeycomb per i moduli di illuminazione d'accento UT Pro 150 e UT Pro 175.

Informazioni Aggiuntive

Tutti gli apparecchi sono dotati di un adattatore di dimensioni ridotte che una volta installato viene perfettamente integrato nel profilo, disegnato specialmente per l'uso su profilo FLOS The Tracking Power.

Disponibili apparecchi di illuminazione con adattatore standard Nordic GA69 per installazione su guide trifase standard FLOS. Compatibilità garantita con guide trifase fabbricate da Nordic, Eutrac, Erco, Zumtobel e iGuzzini. Inoltre, tutti gli apparecchi sono disponibili in versione surface per un'installazione a livello del soffitto.

- UT Pro 150, UT Pro 175, UT Pro 175 Lens:

Possibilità di rotazione a 360° su asse verticale e a 90° su asse orizzontale. Meccanismo di blocco dell'asse orizzontale incorporato.

Grado di protezione IP20.

- UT Pro Wall-Washer:

Possibilità di rotazione a 360° su asse verticale e a 15° su asse orizzontale.

Disponibile versione DALI con adattatore GA-600.

Grado di protezione IP20.

- Profilo:

Installabile esclusivamente su superfici di cartongesso di 12,5 mm di spessore.

Adatto ad installazioni su superfici normalmente infiammabili.

Conformità e Marchi di Qualità

Apparecchio conforme alla Normativa Tecnica Europea EN60598-1 e relative parti seconde.

Description

Exclusive 3-phase lighting profile for indoor use in ceiling recessed version which, thanks to its low visual impact, offers a complete integration into the architecture.

Tracking Power's structural profiles are manufactured in black extruded aluminium, fitted with electric tracks where luminaires are installed using the exclusive Flos mounting system.

Once the track has been installed, only a 15 mm thick line is noticeable.

The Tracking Power family is completed with a wide range of projectors which, combined with exclusive electronics integrated into the body of the luminaire, eliminate unnecessary volume and, as a result, have greater integration.

Standard 3-phase tracks solutions available, cannot be remotely dimmed.

Optic System

Light modules UT Pro 150 and UT Pro 175 are available with spot, medium and flood optics and a built-in high-efficiency borosilicate glass reflector.

The light module UT Pro 175 Lens incorporates an adjustable lens which allows regulating the opening angle from 13° to 56°.

The light module UT Pro Wall-Washer brings a uniform light distribution in a high-performance wall-washer.

Accessories

Shielding cylinder, elliptical lens, flood and honeycomb lens for accent lighting modules UT Pro 150 and UT Pro 175 available.

Additional Information

All luminaires have incorporated a small adapter that, once installed, is completely integrated within the profile, especially designed for FLOS profile The Tracking Power. Luminaires with standard adapter Nordic GA69 for installation in FLOS standard 3-phase tracks available. Guaranteed compatibility with 3-phase tracks manufactured by Nordic, Eutrac, Erco, Zumtobel and iGuzzini.

Moreover, all the luminaires are available in surface version allowing to be fitted flush to the ceiling.

- UT Pro 150, UT Pro 175 and UT Pro 175 Lens:

Possibility of 360° rotation in the vertical axis and 90° rotation in the horizontal axis. Blocking mechanism for horizontal axis integrated.

IP20 protection grade.

- UT Pro Wall-Washer:

Possibility of 360° rotation in vertical axis and 15° rotation in horizontal axis.

DALI version available with GA-600 adaptor.

IP20 protection grade.

- Profile:

Can only be installed in 12.5mm thick plaster-board.

Suitable for installation on normally inflammable surfaces.

Compliance of Standards and Quality Marks

EN60598-1 European Technical Standards and any subsequent additions.

HOW TO ORDER

1 CHOOSE YOUR PROFILE AND LENGTH

RECESSED PROFILE

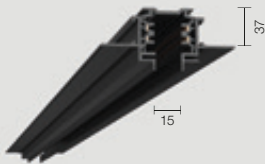

L: 1 / 2 / 3 / 4 m

2 COMPLETE WITH MOUNTING ACCESSORIES

Mains feed connector and End Cap



Right or Left

Feed 90° Corner



Right or Left
Electrical / mechanical joint

Intermediate connector



Straight



Recessed installation

Accessories

Adjustable ceiling kit
(Optional)



SURFACE/SUSPENSION DOWN PROFILE



EUTRAC

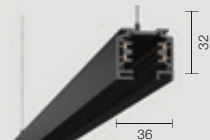

EUTRAC



L: 1 / 2 / 3 m

Mains feed connector



Right

Left

End cap



Intermediate connector



Feed 90° Corner



Earth outside



Earth inside



Surface installation

Accessories

Ceiling fixing kit



Suspension installation

Ceiling fixing kit



+

Suspension kit



THE TRACKING POWER

3 SELECT A LIGHT MODULE

UT Pro 150



On board dimmer



S/M/F

UT Pro 175



On board dimmer



S/M/F

UT Pro 175 Lens



On board dimmer



Lens in / Lens out

UT Pro Wall-Washer



Non dimmable



Wall-Washer

UT Pro 150



On board dimmer



S/M/F

UT Pro 175



On board dimmer



S/M/F

UT Pro 175 Lens



On board dimmer



Lens in / Lens out

UT Pro Wall-Washer



Non dimmable



Wall-Washer

UT Pro 150 GA-69



On board dimmer



S/M/F

UT Pro 175 GA-69



On board dimmer



S/M/F

UT Pro 175 Lens GA-69



On board dimmer



Lens in / Lens out

UT Pro Wall-Washer GA-69



Non dimmable



Wall-Washer

THE TRACKING POWER RECESSED – PROFILES

Profili

Profili trifase con impatto minimo nell'architettura (15 mm), per installazioni a incasso in soffitti di cartongesso.
 Profili lineari disponibili in quattro lunghezze: 1 m, 2 m, 3 m e 4 m.
 Disponibili angoli a 90° sullo stesso piano (diversi elementi per angolo sinistro e destro).
 Necessario connettore intermedio lineare per collegare i vari profili.
 Connettori di alimentazione disponibili per installazione su lato sinistro o destro.
 Terminale di chiusura inclusi nei connettori di alimentazione.
 Il fissaggio del Tracking Power si effettua avvitando le ali del profilo alla superficie del cartongesso, aiutandosi con i profili di alluminio di fissaggio.
 Il kit di fissaggio a soffitto regolabile (opzionale) consente l'installazione senza la necessità di profili di fissaggio in alluminio. Consigliato per impianti in cui si può installare il profilo Tracking Power prima del controsoffitto in cartongesso.

Profiles

Three-phase profile with minimum impact on the architecture (15 mm) for embedded installations in plasterboard ceilings.
 Linear profiles available in four lengths: 1 m, 2 m, 3 m and 4 m.
 90° corners on the same plane are also available (different elements for the left and right corners).
 A linear intermediate connector is required to connect several profiles.
 Power supply connectors available for the installation on the left or right-hand side.
 End caps included in the power supply connectors.
 The fastening of the Tracking Power is performed by screwing the sides of the profile to the plasterboard surface, aided by aluminium fastening profiles.
 The adjustable ceiling fastening kit (optional) permits the installation without the need for fastening aluminium profiles. Recommended for installations where the Tracking Power profile can be installed before the suspended plasterboard.

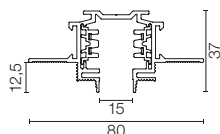
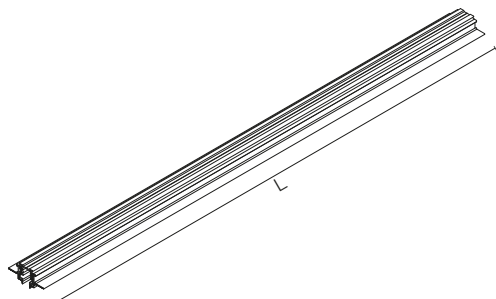

- L: 1000 mm
- 06.1800.14
- L: 2000 mm
- 06.1801.14
- L: 3000 mm
- 06.1802.14
- L: 4000 mm
- 06.1803.14

L: 1 m / 2 m / 3 m / 4 m

Angolo 90°.
 Con connessione di alimentazione elettrica.

90° Corner.
 With electrical feeding connection.

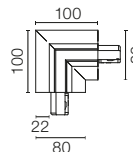

- Right
- 06.1804.14
- Left
- 06.1805.14

Connettore di alimentazione.
 Coperchio incluso.

Feed connector. End cap included.

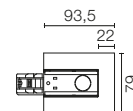

- Right
- 06.1807.14
- Left
- 06.1806.14

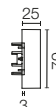

Connettore lineare intermedio.

Intermediate linear connector.



- 60.3319.14

Kit di fissaggio a soffitto regolabile (opzionale). Kit da 2 unità.

Adjustable ceiling kit (optional). 2 unit kit.

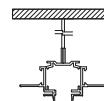

- 08.8439.14

Profile (mm)	Quantities Ceiling Kit
1000	1
2000	2
3000	3
4000	4

THE TRACKING POWER SURFACE – PROFILES

Profili

Profili trifase per installazioni di superficie standard EUTRAC, compatibile con apparecchi di illuminazione del sistema Tracking Power.

Profiles

Three-phase profile for standard EUTRAC surface installations compatible with Tracking Power light fixtures.

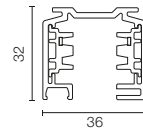
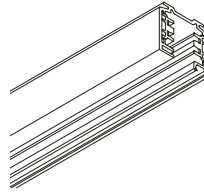

1000 mm	60.3330.11A
	60.3330.14
2000 mm	60.3331.11A
	60.3331.14
3000 mm	60.3336.11A
	60.3336.14

L: 1 m / 2 m / 3 m

Connettore di alimentazione.

Feed connector.



Right	60.3317.11A
	60.3317.14
Left	60.3318.11A
	60.3318.14

Connettore lineare intermedio.

Intermediate linear connector.



	60.3319.11A
	60.3319.14

Terminale di chiusura.

End cap.



	60.3333.11A
	60.3333.14

Angolo 90°.
Con connessione di alimentazione elettrica.

90° Corner.
With electrical feeding connection.



Earth Outside	60.3320.11A
	60.3320.14
Earth Inside	60.3321.11A
	60.3321.14

Fissaggio a soffitto o per kit a sospensione.

Ceiling fixture or fixture for suspension kit.



	60.3351.11A
	60.3351.14

Kit a sospensione, cavo da 1,5 m.
Richiedere insieme a 60.3351.

Suspension kit, 1.5 m cable. Order together with 60.3351.



60.3345

THE TRACKING POWER RECESSED/SURFACE – INSTALLATION

Per garantire la sicurezza elettrica dell'impianto, il profilo di Tracking Power è asimmetrico e offre una forma unica per l'installazione degli apparecchi d'illuminazione. Nello schema viene illustrata la posizione del binario neutra (linea rossa) per le diverse configurazioni possibili, che si deve comporre in base ai requisiti di ciascun impianto, rispettando la continuità elettrica.

The Tracking Power profile is asymmetric to ensure the electric safety in the installation, and it provides a unique form in the installation of luminaires. The diagram shows the position of the neutral track (red line) for the different possible configurations, which must be composed according to the requirements for each installation, respecting the electric continuity.

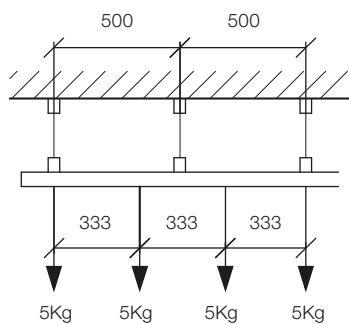
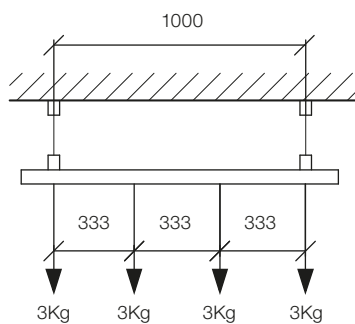
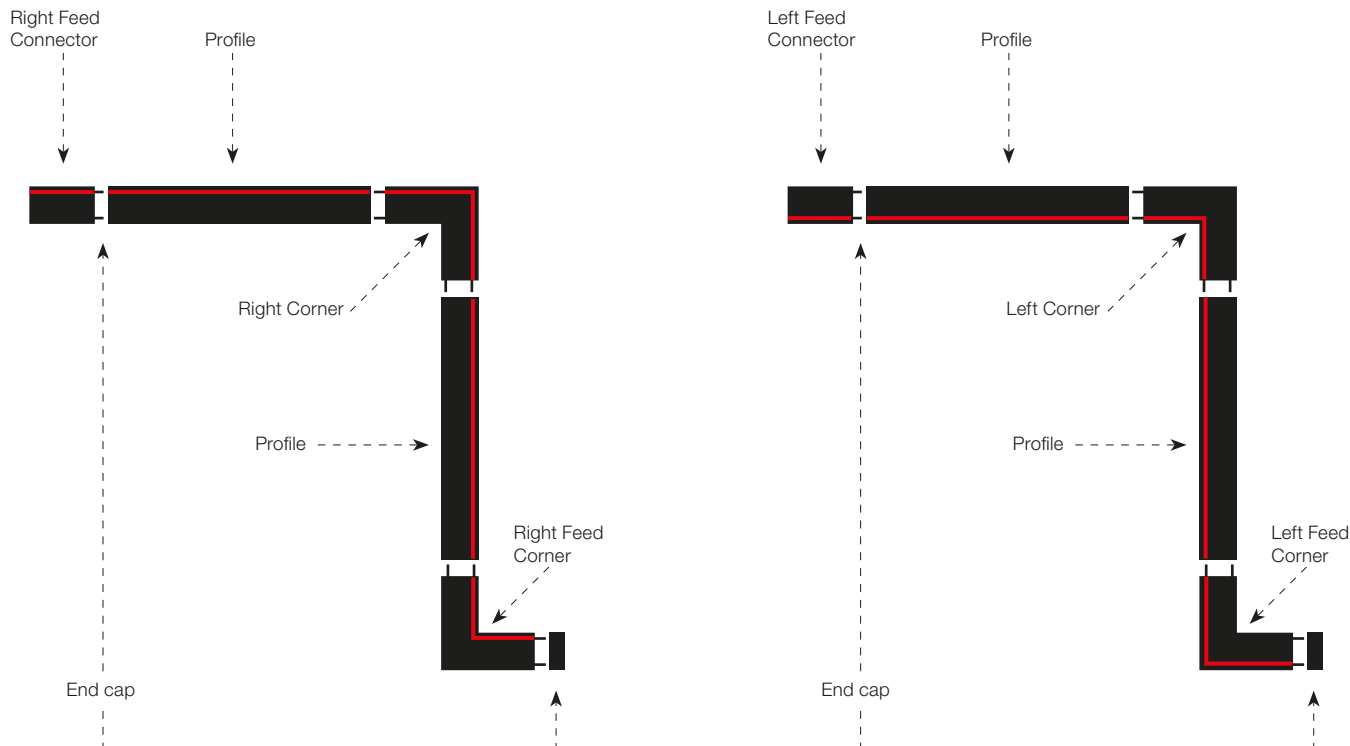

THE TRACKING POWER – LIGHT MODULES

UT Pro 150

Light Source: LED Array 23,5W - 2400 lm - 3000K/CRI 80 / 23,5W - 1950 lm - 3000K/CRI 90 / 23,5W - 2150 lm - 4000K/CRI 90

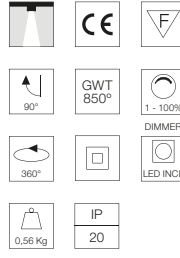
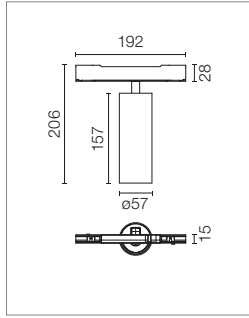

Proiettore per installazione su profilo Tracking Power con fonte di luce LED. Fonte di alimentazione 120-277V integrata. Riflettore ad alto rendimento compreso.

Spotlight to be installed in Tracking Power profile with LED light source. 120-277V power supply integrated. High performance reflector included.

Le versioni .40 hanno l'adattatore a guida, il braccio e la parte posteriore della testa neri. Nelle versioni "all white" l'adattatore a guida, il braccio e la parte posteriore della testa sono bianchi, e solo l'anello antiabbagliamento è nero.

.40 versions come with the track adapter, the arm and the rear of the head in black. In the "All white" versions, the track adapter, the arm, the rear of the head and the head are white. Only the anti-glare ring is black.

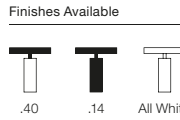

- 3000K - CRI 80**
On board dimmer
- 09.7210.40A
 - 09.7210.14A
 - All White
 - 09.7210.40A78

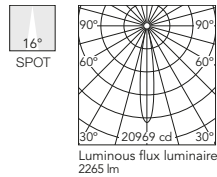

- 3000K - CRI 90**
On board dimmer
- 09.7216.40A
 - 09.7216.14A
 - All White
 - 09.7216.40A78

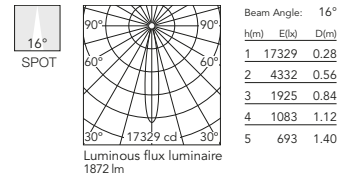

- 4000K - CRI 90**
On board dimmer
- 09.7211.40A
 - 09.7211.14A
 - All White
 - 09.7211.40A78

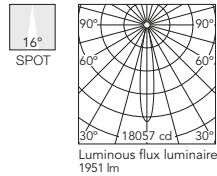

- 3000K - CRI 90**
On board dimmer
- 09.7217.40A
 - 09.7217.14A
 - All White
 - 09.7217.40A78

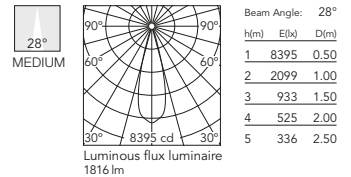

- 3000K - CRI 80**
On board dimmer
- 09.7212.40A
 - 09.7212.14A
 - All White
 - 09.7212.40A78

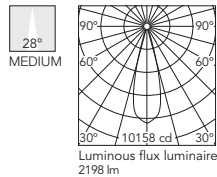

- 4000K - CRI 90**
On board dimmer
- 09.7213.40A
 - 09.7213.14A
 - All White
 - 09.7213.40A78

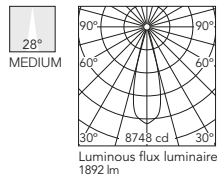

- 3000K - CRI 80**
On board dimmer
- 09.7214.40A
 - 09.7214.14A
 - All White
 - 09.7214.40A78

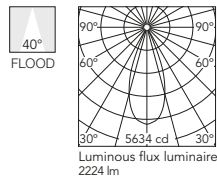

- 3000K - CRI 90**
On board dimmer
- 09.7218.40A
 - 09.7218.14A
 - All White
 - 09.7218.40A78

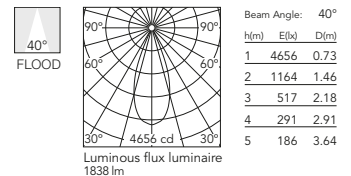

- 4000K - CRI 90**
On board dimmer
- 09.7215.40A
 - 09.7215.14A
 - All White
 - 09.7215.40A78

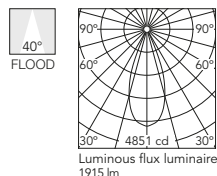

THE TRACKING POWER – LIGHT MODULES

UT Pro 175

Light Source: LED Array 35,3W - 3950 lm - 3000K/CRI 80 / 35,3W - 3250 lm - 3000K/CRI 90 / 35,3W - 3400 lm - 4000K/CRI 90

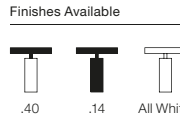
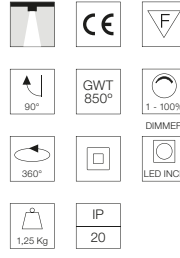
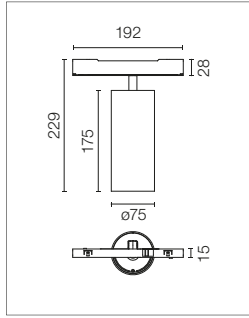

Proiettore per installazione su profilo Tracking Power con fonte di luce LED. Fonte di alimentazione 120-277V integrata. Riflettore ad alto rendimento compreso.

Le versioni .40 hanno l'adattatore a guida, il braccio e la parte posteriore della testa neri. Nelle versioni "all white" l'adattatore a guida, il braccio e la parte posteriore della testa sono bianchi, e solo l'anello antiabbagliamento è nero.

Spotlight to be installed in Tracking Power profile with LED light source. 120-277V power supply integrated. High performance reflector included.

.40 versions come with the track adapter, the arm and the rear of the head in black. In the "All white" versions, the track adapter, the arm, the rear of the head and the head are white. Only the anti-glare ring is black.

- 3000K - CRI 80**
On board dimmer
 09.7300.40
 09.7300.14
 All White
 09.7300.40.78

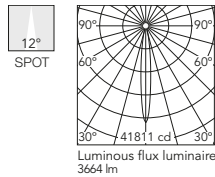

- 3000K - CRI 90**
On board dimmer
 09.7301.40
 09.7301.14
 All White
 09.7301.40.78

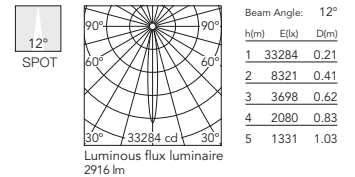

- 4000K - CRI 90**
On board dimmer
 09.7302.40
 09.7302.14
 All White
 09.7302.40.78

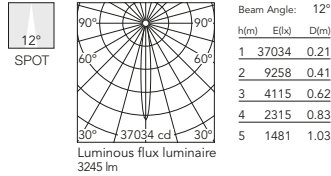

- 3000K - CRI 80**
On board dimmer
 09.7303.40
 09.7303.14
 All White
 09.7303.40.78

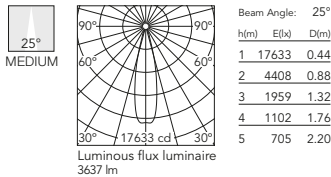

- 3000K - CRI 90**
On board dimmer
 09.7304.40
 09.7304.14
 All White
 09.7304.40.78

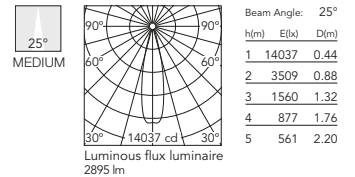

- 4000K - CRI 90**
On board dimmer
 09.7305.40
 09.7305.14
 All White
 09.7305.40.78

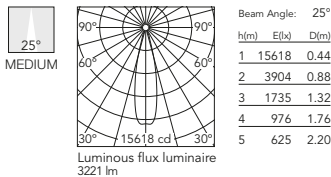

- 3000K - CRI 80**
On board dimmer
 09.7306.40
 09.7306.14
 All White
 09.7306.40.78

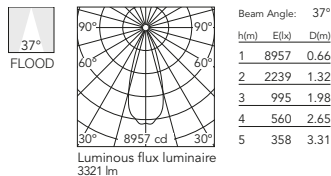

- 3000K - CRI 90**
On board dimmer
 09.7307.40
 09.7307.14
 All White
 09.7307.40.78

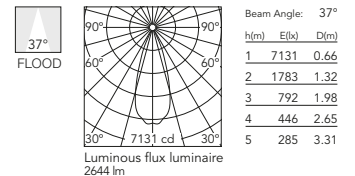

- 4000K - CRI 90**
On board dimmer
 09.7308.40
 09.7308.14
 All White
 09.7308.40.78

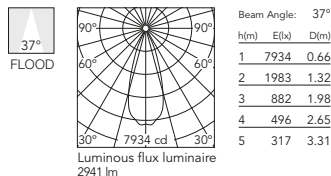

THE TRACKING POWER – LIGHT MODULES

UT Pro 175 Lens

Light Source: LED Array 35,3W - 3950 lm - 3000K/CRI 80 / 35,3W - 3250 lm - 3000K/CRI 90 / 35,3W - 3400 lm - 4000K/CRI 90

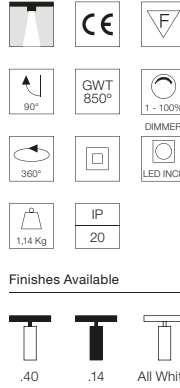
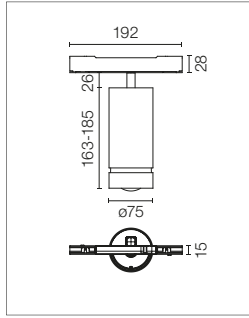

Proiettore per installazione su profilo Tracking Power con fonte di luce LED. Dotato di lente che permette di regolare l'angolo di apertura da 13° a 56°. Fonte di alimentazione 120-277V integrata.

Spotlight to be installed in Tracking Power profile with LED light source. Includes adjustable lens allowing opening angle calibration from 13° to 56°. 120-277V power supply integrated.

Le versioni .40 hanno l'adattatore a guida, il braccio e la parte posteriore della testa neri. Nelle versioni "all white" l'adattatore a guida, il braccio e la parte posteriore della testa sono bianchi, e solo l'anello antiabbagliamento è nero.

.40 versions come with the track adapter, the arm and the rear of the head in black. In the "All white" versions, the track adapter, the arm, the rear of the head and the head are white. Only the anti-glare ring is black.

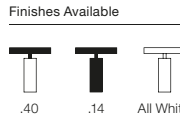

- 3000K - CRI 80**
On board dimmer
- 09.7370.40
 - 09.7370.14
 - All White
 - 09.7370.40.78

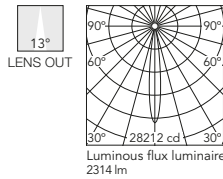

Beam Angle: 13°

h(m)	E(lx)	D(m)
1	28212	0.23
2	7053	0.46
3	3135	0.70
4	1763	0.93
5	1128	1.16

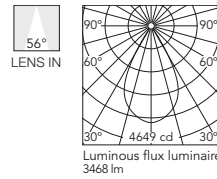

Beam Angle: 56°

h(m)	E(lx)	D(m)
1	4649	1.07
2	1162	2.14
3	517	3.21
4	291	4.29
5	186	5.36

- 3000K - CRI 90**
On board dimmer
- 09.7371.40
 - 09.7371.14
 - All White
 - 09.7371.40.78

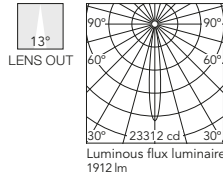

Beam Angle: 13°

h(m)	E(lx)	D(m)
1	23312	0.23
2	5828	0.46
3	2590	0.70
4	1457	0.93
5	932	1.16

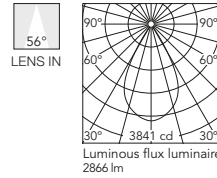

Beam Angle: 56°

h(m)	E(lx)	D(m)
1	3841	1.07
2	960	2.14
3	427	3.21
4	240	4.29
5	154	5.36

- 4000K - CRI 90**
On board dimmer
- 09.7372.40
 - 09.7372.14
 - All White
 - 09.7372.40.78

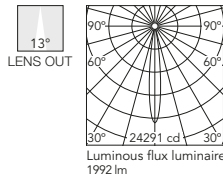

Beam Angle: 13°

h(m)	E(lx)	D(m)
1	24291	0.23
2	6073	0.46
3	2699	0.70
4	1518	0.93
5	972	1.16

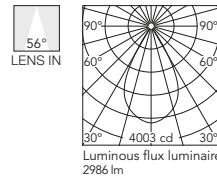

Beam Angle: 56°

h(m)	E(lx)	D(m)
1	4003	1.07
2	1001	2.14
3	445	3.21
4	250	4.29
5	160	5.36

UT Pro Wall-Washer

Light Source: Top LED 25,5W - 2700 lm - 3000K/CRI 90 / 25,5W - 2900 lm - 4000K/CRI 90

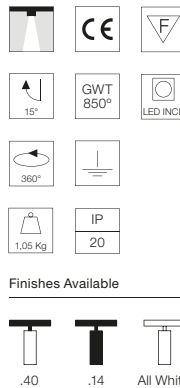
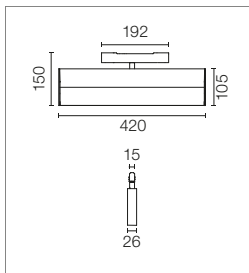

Modulo d'illuminazione Wall-Washer installabile su profilo Tracking Power con fonte di luce LED. Fonte di alimentazione 220-240V integrata.

Wall-Washer lighting module to be installed in Tracking Power profile with LED light source. 220-240V power supply integrated.

Le versioni .40 hanno l'adattatore a guida, il braccio e la parte posteriore della testa neri. Nelle versioni "all white" l'adattatore a guida, il braccio e la parte posteriore della testa sono bianchi, e solo l'anello antiabbagliamento è nero.

.40 versions come with the track adapter, the arm and the rear of the head in black. In the "All white" versions, the track adapter, the arm, the rear of the head and the head are white. Only the anti-glare ring is black.



- 3000K - CRI 90**
Non Dimmable
- 09.7500.40
 - 09.7500.14
 - All White
 - 09.7500.40.78

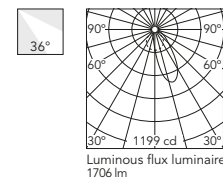

Beam Angle: 36°

h(m)	E(lx)	D(m)
1	1199	0.78
2	300	1.56
3	133	2.34
4	75	3.12
5	48	3.90

- 4000K - CRI 90**
Non Dimmable
- 09.7501.40
 - 09.7501.14
 - All White
 - 09.7501.40.78

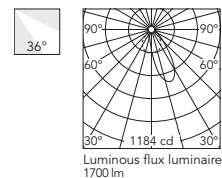

Beam Angle: 36°

h(m)	E(lx)	D(m)
1	1184	0.76
2	296	1.52
3	132	2.28
4	74	3.04
5	47	3.80

THE TRACKING POWER – LIGHT MODULES

UT Pro 150 GA-69

Light Source: LED Array 23,5W - 2300 lm - 3000K/CRI 80 / 23,5W - 1950 lm - 3000K/CRI 90 / 23,5W - 2009 lm - 4000K/CRI 90

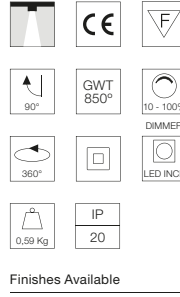
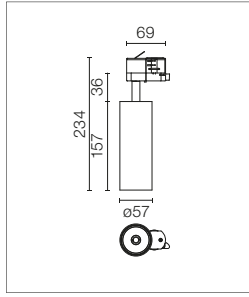

Proiettore per installazione su guida trifase standard con fonte di luce LED. Fonte di alimentazione 120-270V integrata.

Spotlight to be installed in standard 3-phase track with LED light source. 120-270V power supply integrated.

Le versioni .40 hanno l'adattatore a guida, il braccio e la parte posteriore della testa neri. Nelle versioni "all white" l'adattatore a guida, il braccio e la parte posteriore della testa sono bianchi, e solo l'anello antiabbagliamento è nero.

.40 versions come with the track adapter, the arm and the rear of the head in black. In the "All white" versions, the track adapter, the arm, the rear of the head and the head are white. Only the anti-glare ring is black.

Finishes Available



- 3000K - CRI 80**
On board dimmer
- 09.7270.40A
 - 09.7270.14A
 - All White
 - 09.7270.40A78

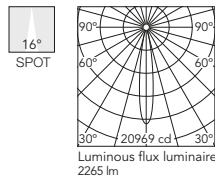

Beam Angle: 16°

h(m)	E(lx)	D(m)
1	20969	0.28
2	5242	0.56
3	2330	0.84
4	1311	1.12
5	839	1.40

- 3000K - CRI 90**
On board dimmer
- 09.7276.40A
 - 09.7276.14A
 - All White
 - 09.7276.40A78

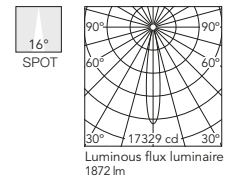

Beam Angle: 16°

h(m)	E(lx)	D(m)
1	17329	0.28
2	4332	0.56
3	1925	0.84
4	1083	1.12
5	693	1.40

- 4000K - CRI 90**
On board dimmer
- 09.7271.40A
 - 09.7271.14A
 - All White
 - 09.7271.40A78

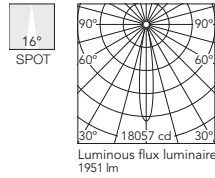

Beam Angle: 16°

h(m)	E(lx)	D(m)
1	18057	0.28
2	4514	0.56
3	2006	0.84
4	1129	1.12
5	722	1.40

- 3000K - CRI 80**
On board dimmer
- 09.7272.40A
 - 09.7272.14A
 - All White
 - 09.7272.40A78

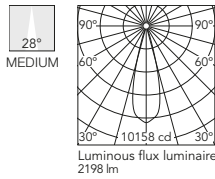

Beam Angle: 28°

h(m)	E(lx)	D(m)
1	10158	0.50
2	2540	1.00
3	1129	1.50
4	635	2.00
5	406	2.50

- 3000K - CRI 90**
On board dimmer
- 09.7277.40A
 - 09.7277.14A
 - All White
 - 09.7277.40A78

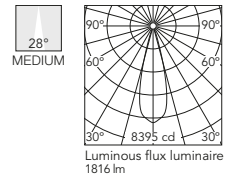

Beam Angle: 28°

h(m)	E(lx)	D(m)
1	8395	0.50
2	2099	1.00
3	933	1.50
4	525	2.00
5	336	2.50

- 4000K - CRI 90**
On board dimmer
- 09.7273.40A
 - 09.7273.14A
 - All White
 - 09.7273.40A78

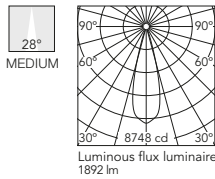

Beam Angle: 28°

h(m)	E(lx)	D(m)
1	8748	0.50
2	2187	1.00
3	972	1.50
4	547	2.00
5	350	2.50

- 3000K - CRI 80**
On board dimmer
- 09.7274.40A
 - 09.7274.14A
 - All White
 - 09.7274.40A78

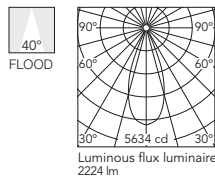

Beam Angle: 40°

h(m)	E(lx)	D(m)
1	5634	0.73
2	1408	1.46
3	626	2.18
4	352	2.91
5	225	3.64

- 3000K - CRI 90**
On board dimmer
- 09.7278.40A
 - 09.7278.14A
 - All White
 - 09.7278.40A78

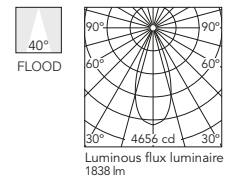

Beam Angle: 40°

h(m)	E(lx)	D(m)
1	4656	0.73
2	1164	1.46
3	517	2.18
4	291	2.91
5	186	3.64

- 4000K - CRI 90**
On board dimmer
- 09.7275.40A
 - 09.7275.14A
 - All White
 - 09.7275.40A78

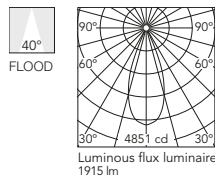

Beam Angle: 40°

h(m)	E(lx)	D(m)
1	4851	0.73
2	1213	1.46
3	539	2.18
4	303	2.91
5	194	3.64

THE TRACKING POWER – LIGHT MODULES

UT Pro 175 GA-69

Light Source: LED Array 35,3W - 3950 lm - 3000K/CRI 80 / 35,3W - 3250 lm - 3000K/CRI 90 / 35,3W - 3400 lm - 4000K/CRI 90

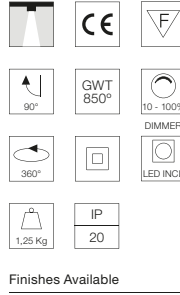
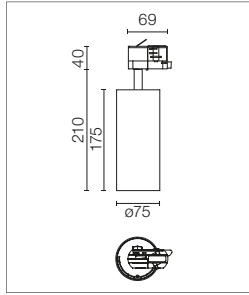

Proiettore per installazione su guida trifase standard con fonte di luce LED. Fonte di alimentazione 120-270V integrata.

Spotlight to be installed in standard 3-phase track with LED light source. 120-270V power supply integrated.

Le versioni .40 hanno l'adattatore a guida, il braccio e la parte posteriore della testa neri. Nelle versioni "all white" l'adattatore a guida, il braccio e la parte posteriore della testa sono bianchi, e solo l'anello antiabbagliamento è nero.

.40 versions come with the track adapter, the arm and the rear of the head in black. In the "All white" versions, the track adapter, the arm, the rear of the head and the head are white. Only the anti-glare ring is black.

Finishes Available



- 3000K - CRI 80**
On board dimmer
- 09.7310.40
 - 09.7310.14
 - All White
 - 09.7310.40.78

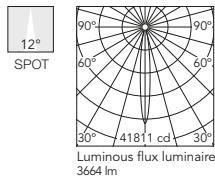

- 3000K - CRI 90**
On board dimmer
- 09.7311.40
 - 09.7311.14
 - All White
 - 09.7311.40.78

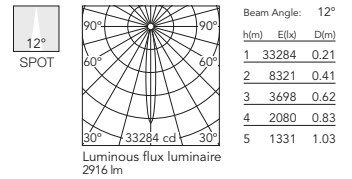

- 4000K - CRI 90**
On board dimmer
- 09.7312.40
 - 09.7312.14
 - All White
 - 09.7312.40.78

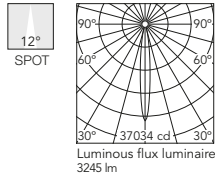

- 3000K - CRI 90**
On board dimmer
- 09.7314.40
 - 09.7314.14
 - All White
 - 09.7314.40.78

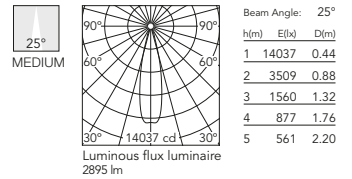

- 3000K - CRI 80**
On board dimmer
- 09.7313.40
 - 09.7313.14
 - All White
 - 09.7313.40.78

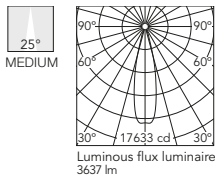

- 4000K - CRI 90**
On board dimmer
- 09.7315.40
 - 09.7315.14
 - All White
 - 09.7315.40.78

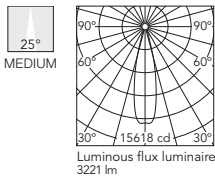

- 3000K - CRI 90**
On board dimmer
- 09.7317.40
 - 09.7317.14
 - All White
 - 09.7317.40.78

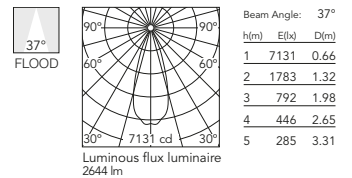

- 3000K - CRI 80**
On board dimmer
- 09.7316.40
 - 09.7316.14
 - All White
 - 09.7316.40.78

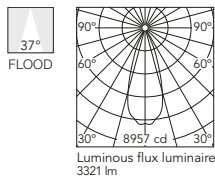

- 4000K - CRI 90**
On board dimmer
- 09.7318.40
 - 09.7318.14
 - All White
 - 09.7318.40.78

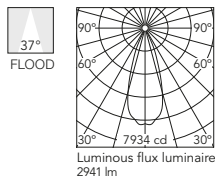

THE TRACKING POWER – LIGHT MODULES

UT Pro 175 Lens GA-69

Light Source: LED Array 35,3W - 3950 lm - 3000K/CRI 80 / 35,3W - 3250 lm - 3000K/CRI 90 / 35,3W - 3400 lm - 4000K/CRI 90

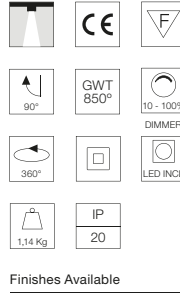
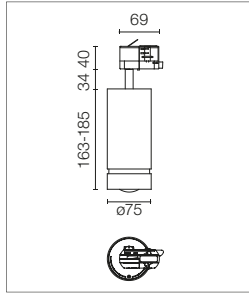

Proiettore per installazione su guida trifase standard con fonte di luce LED. Dotato di lente che permette di regolare l'angolo di apertura da 13° a 56°. Fonte di alimentazione 120-270V integrata.

Spotlight to be installed in standard 3-phase track with LED light source. Includes adjustable lens allowing opening angle calibration from 13° to 56°. 120-270V power supply integrated.

Le versioni .40 hanno l'adattatore a guida, il braccio e la parte posteriore della testa neri. Nelle versioni "all white" l'adattatore a guida, il braccio e la parte posteriore della testa sono bianchi, e solo l'anello antiabbagliamento è nero.

.40 versions come with the track adapter, the arm and the rear of the head in black. In the "All white" versions, the track adapter, the arm, the rear of the head and the head are white. Only the anti-glare ring is black.

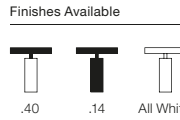

- 3000K - CRI 80**
On board dimmer
- 09.7373.40
 - 09.7373.14
 - All White
 - 09.7373.40.78

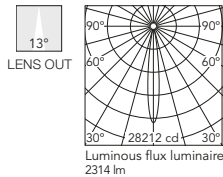

Beam Angle: 13°

h(m)	E(lx)	D(m)
1	28212	0.23
2	7053	0.46
3	3135	0.70
4	1763	0.93
5	1128	1.16

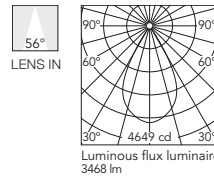

Beam Angle: 56°

h(m)	E(lx)	D(m)
1	4649	1.07
2	1162	2.14
3	517	3.21
4	291	4.29
5	186	5.36

- 3000K - CRI 90**
On board dimmer
- 09.7374.40
 - 09.7374.14
 - All White
 - 09.7374.40.78

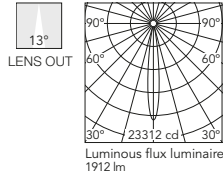

Beam Angle: 13°

h(m)	E(lx)	D(m)
1	23312	0.23
2	5828	0.46
3	2590	0.70
4	1457	0.93
5	932	1.16

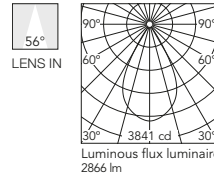

Beam Angle: 56°

h(m)	E(lx)	D(m)
1	3841	1.07
2	960	2.14
3	427	3.21
4	240	4.29
5	154	5.36

- 4000K - CRI 90**
On board dimmer
- 09.7375.40
 - 09.7375.14
 - All White
 - 09.7375.40.78

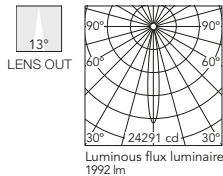

Beam Angle: 13°

h(m)	E(lx)	D(m)
1	24291	0.23
2	6073	0.46
3	2699	0.70
4	1518	0.93
5	972	1.16

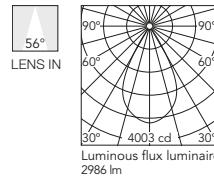

Beam Angle: 56°

h(m)	E(lx)	D(m)
1	4003	1.07
2	1001	2.14
3	445	3.21
4	250	4.29
5	160	5.36

UT Pro Wall-Washer GA-69 (Dali GA-600)

Light Source: Top LED 25,5W - 2700 lm - 3000K/CRI 90 / 25,5W - 2900 lm - 4000K/CRI 90

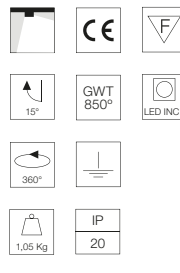
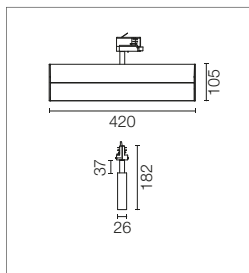

Modulo d'illuminazione Wall-Washer installabile su guida trifase standard con fonte di luce LED. Fonte di alimentazione 220-240V integrata. Per la versione DALI sono necessari profili dimmerabili (consultare capitolo "Tracks").

Wall-Washer lighting module to be installed in standard 3-phase track with LED light source. 220-240V power supply integrated. DALI version requires dimmable tracks (please refer to the "Tracks" chapter).

Le versioni .40 hanno l'adattatore a guida, il braccio e la parte posteriore della testa neri. Nelle versioni "all white" l'adattatore a guida, il braccio e la parte posteriore della testa sono bianchi, e solo l'anello antiabbagliamento è nero.

.40 versions come with the track adapter, the arm and the rear of the head in black. In the "All white" versions, the track adapter, the arm, the rear of the head and the head are white. Only the anti-glare ring is black.



- 3000K - CRI 90**
Non Dimmable
- 09.7504.40
 - 09.7504.14
 - All White
 - 09.7504.40.78

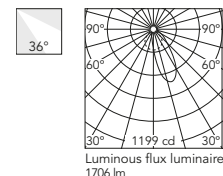

Beam Angle: 36°

h(m)	E(lx)	D(m)
1	1199	0.72
2	300	1.54
3	133	2.34
4	75	3.12
5	48	3.92

- 4000K - CRI 90**
Non Dimmable
- 09.7505.40
 - 09.7505.14
 - All White
 - 09.7505.40.78

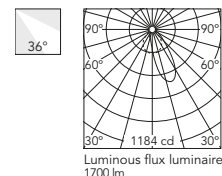

Beam Angle: 36°

h(m)	E(lx)	D(m)
1	1184	0.76
2	296	1.52
3	132	2.28
4	74	3.04
5	47	3.80

- Dali Version**
- 09.7504.40.DA
 - 09.7504.14.DA
 - All White
 - 09.7504.40.YU

- Dali Version**
- 09.7505.40.DA
 - 09.7505.14.DA
 - All White
 - 09.7505.40.YU





THE TRACKING POWER

Accessori / Accessories

UT Pro 150 / UT Pro 175

Crocetta di schermatura, lenti e honeycomb direttamente installabili sulla testa dell'apparecchio di illuminazione senza necessità di accessori di fissaggio. Compatibilità di installazione di honeycomb + lente contemporaneamente.

Screening crosspiece, lenses and honeycomb directly installable on the head of the luminaire without needing any fastening accessory. Installation compatible with honeycomb + lense at the same time.

Filtro a croce antiabbagliamento.	Screening crosspiece.		UT Pro 150 08.8429.00 UT Pro 175 08.9108.00
Lente ellittica.	Elliptical lens.		UT Pro 150 08.8431.00 UT Pro 175 08.9109.00
Lente flood.	Flood lens.		UT Pro 150 08.8432.00 UT Pro 175 08.9110.00
Honeycomb.	Honeycomb.		UT Pro 150 08.8428.00 UT Pro 175 08.9107.00
Cono di schermatura.	Snoot shielding cone.		UT Pro 150 08.0526.00 08.0526.40 08.0526.BW UT Pro 175 08.9111.00

THE TRACKING POWER – INSTALLATION PROFILES

WALL-WASHER INSTALLATION

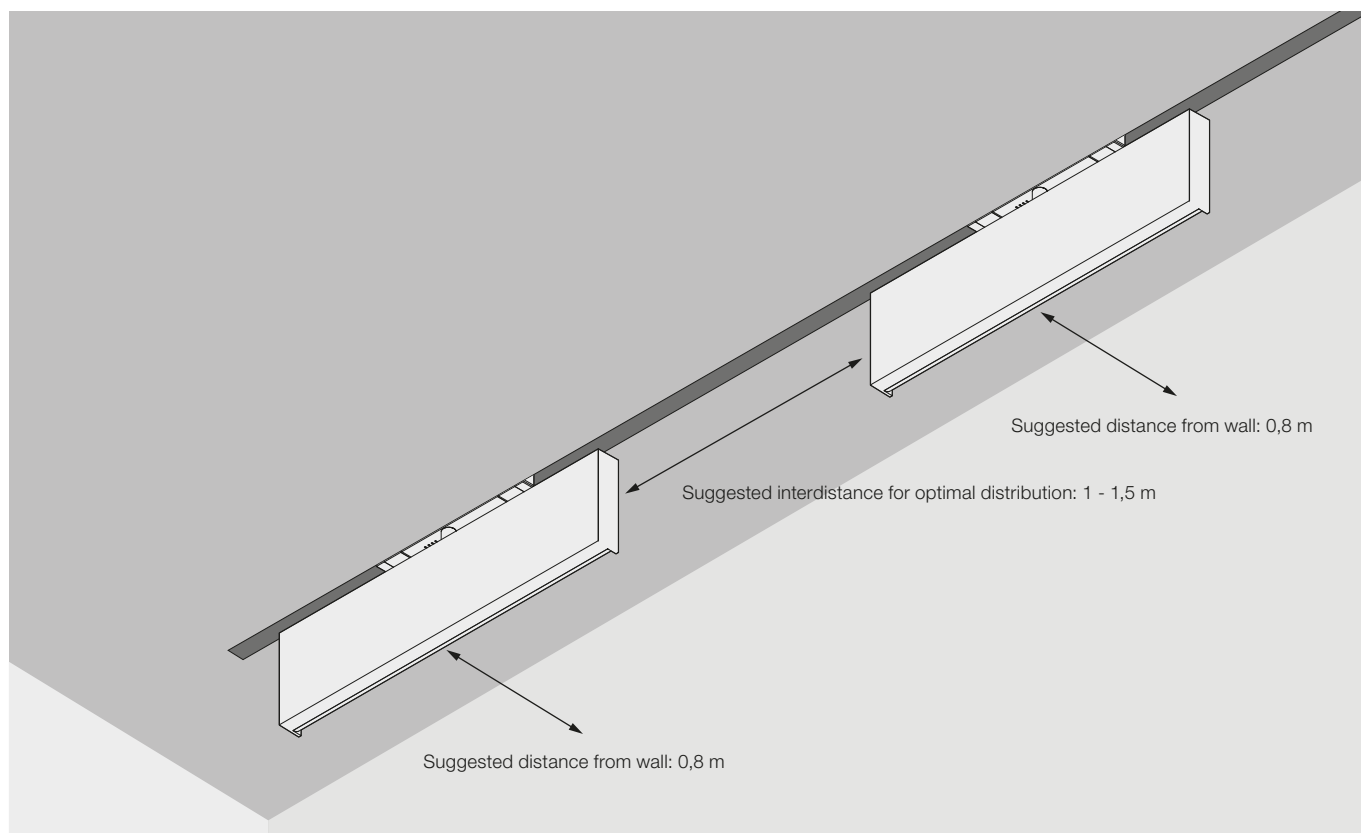

THE FAST TRACK
DESIGNED BY FLOS ARCHITECTURAL

RECESSED

SURFACE

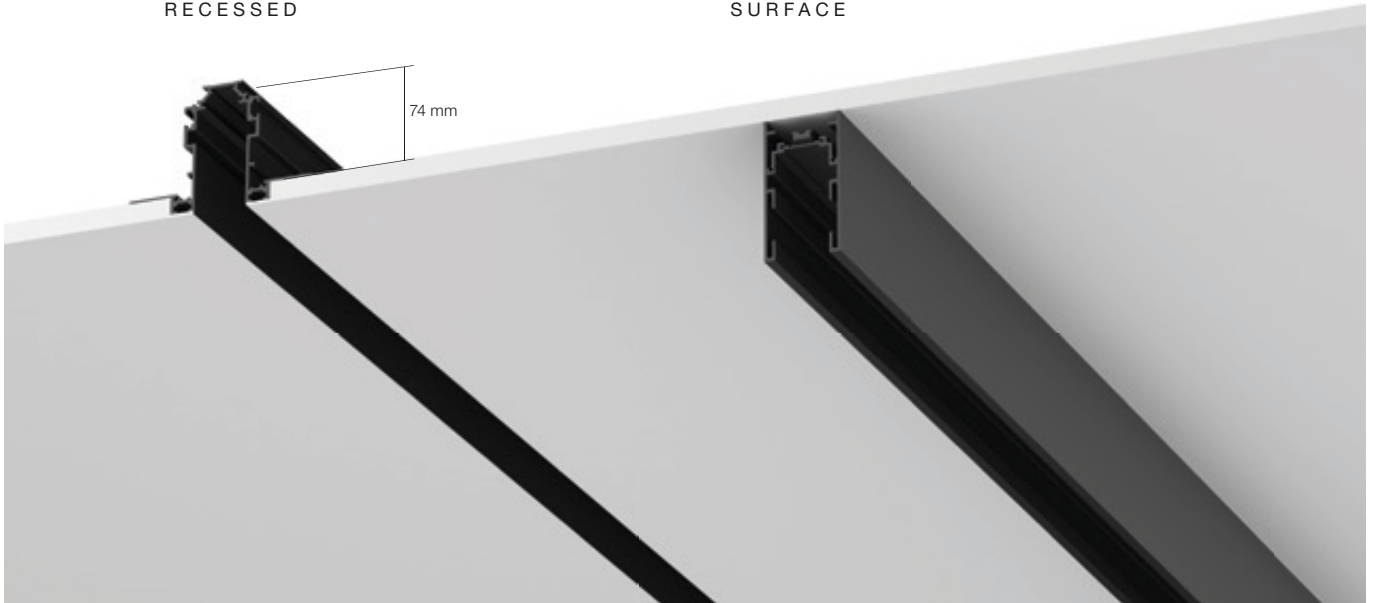

Recessed Profiles 14 Nero
14 Black

Surface Profiles 40 Bianco
40 White 14 Nero
14 Black

LIGHT MODULES

THE FAST TRACK
SPOT 100



LIGHT SOURCE
POWER LED
13W
780 lm
3000K/CRI 90
830 lm
4000K/CRI 90

THE FAST TRACK
SPOT 150



LIGHT SOURCE
LED ARRAY
25,5W
1950 lm
3000K/CRI 90
2110 lm
4000K/CRI 90

14 Nero
14 Black

BW Bianco
BW White



THE FAST TRACK

Descrizione

Unico sistema al mondo che permette di muovere, orientare e regolare l'intensità dei differenti gruppi di corpi illuminanti a distanza.

Sistema per interni disponibile nelle versioni per montaggio in superficie e in casso a soffitto. Dotato di controllo wireless con sistema FLOS Control® by Casambi gestito tramite App dedicata per dispositivi mobili (copre una distanza di circa 20m). Il sistema permette controllare fino a 200 apparecchi tramite App.

I moduli di illuminazione sono dotati di servocomandi per movimento e orientazione, sensori per rilevare altri faretti e l'estremo della guida.

Il sistema è in grado di rilevare in qualsiasi momento la posizione di ogni faretto, fino a un massimo di 24 scene di luce, memorizzandone orientazione, rotazione e intensità luminosa per un uso futuro, oltre a 4 programmazioni orarie per cambiare da una scena all'altra.

E' anche possibile cambiare completamente scena di luce recuperando le composizioni memorizzate con un semplice click. La traslazione va effettuata sempre in modo manuale e individuale attraverso la APP.

Profili strutturali del sistema di alluminio estruso nero e placcati bianchi per la versione 4.0, provvisti di piste elettriche alimentate a 48V, su cui vengono installati con un sistema di fissaggio meccanico degli apparecchi LED.

La famiglia è composta da moduli di illuminazione d'accento, con diverse ottiche.

L'unico sistema di controllo disponibile è FLOS Control® by Casambi.

Necessaria APP per dispositivi mobili (disponibile in Apple Store e Google Play).

La lunghezza massima per ciascun alimentatore è di 20 m. La distanza massima tra la fonte di alimentazione e l'inizio della guida è di 2m.

Sistema Ottico

I moduli di illuminazione d'accento sono disponibili con ottiche in vetro ad alto rendimento con angoli super spot, spot, medium e flood.

Unità di Alimentazione

Alimentatore remoto da 48V non inclusa.

Informazioni Aggiuntive

Grado di protezione IP20.

Adatti ad installazioni su superfici normalmente infiammabili.

Conformità e Marchi di Qualità

Apparecchio conforme alla Normativa Tecnica Europea EN60598-1 e relative parti seconde.

Description

Only system in the world that allows the intensity of different groups of light fittings to be moved, oriented, and adjusted at a distance.

Indoor system available in versions for installation on surfaces and recessed installation on the ceiling. Equipped with wireless control via the FLOS Control® by Casambi system managed using the dedicated app for mobile devices (covers a distance of about 20 m). The system allows up to 200 devices to be controlled via the app.

The lighting modules incorporate servos for moving and orienting them, as well as sensors to detect other spots and the end of the track.

The system can recognize the location of each spot at all times and memorize up to 24 scenes of light. It memorizes the orientation, rotation and light intensity for later use, as well as 4 time schedules to change from one scene to another.

The light scene can also be completely changed by recovering the memorized compositions with a simple click. The movement must always be performed manually and individually through the APP.

Structural profiles of the system are manufactured in black extruded aluminum and are white plated for the 40 version, provided with electric tracks fed at 48V, on which the LED luminaries are installed by means of a mechanical fixing system.

The family is composed of accent lighting, with different optics.

The only available control system is FLOS Control® by Casambi.

The app for mobile devices is also necessary (available in the Apple Store and Google Play).

The maximum length for each power source is 20 m.

The maximum length between the power supply and the start of the track is 2 m.

Optic system

The accent light modules are available with high-performance crystal optics. Super spot, spot, medium and flood angles.

Power Supply

Remote 48V power source not included.

Additional Information

IP20 protection grade.

Suitable for installation on normally inflammable surfaces.

Compliance of Standards and Quality Marks

EN60598-1 European Technical Standards and any subsequent additions.

FLOS
CONTROL BY CASAMBI



HOW TO ORDER

1 CHOOSE YOUR PROFILE AND LENGTH

2 COMPLETE WITH MOUNTING ACCESSORIES

RECESSED PROFILE

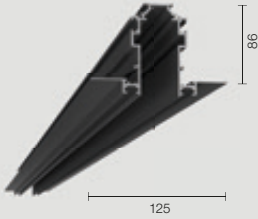

L: 1 / 1,5 / 2 / 3 m

Feed cable



End cap



Intermediate cable



Stopper



Electrical



Recessed installation

Accessories
(Optional)

Fixed ceiling kit



Adjustable ceiling kit



or

SURFACE PROFILE

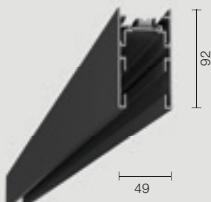

L: 1 / 1,5 / 2 / 3 m

Feed cable



End cap



Intermediate cable



Stopper



Electrical



Surface installation

Fixing ceiling kit included with the profile

THE FAST TRACK

3 SELECT POWER SUPPLY

Recessed installation

Remote power supply



185W



320W

(select the driver with the appropriate power according to the needs of your project)

4 SELECT A LIGHT MODULE

Spot 100



Casambi integrated



SS/S/M

Spot 150



Casambi integrated



S/M/F

THE FAST TRACK – RECESSED PROFILES

Profili

Profilo elettromeccanico per installazioni a incasso su soffitti di cartongesso con lunghezze da 1 a 3 metri. I cavi di alimentazione e interconnessione vanno ordinati separatamente.

I coperchi devono essere ordinati separatamente. Kit di ancoraggio, fisso o regolabile, disponibili (optional). I kit di ancoraggio a soffitto consentono l'installazione senza il bisogno di profili TC in alluminio di ancoraggio.

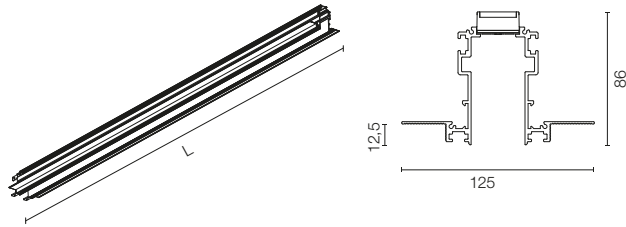

L: 1 m / 1,5 m / 2 m / 3 m

Profiles

Electro-mechanical profile for recessed installations in plasterboard ceilings, with 1m to 3m lengths. Power and interconnection cables must be ordered separately.

The covers must be ordered separately. Fixed or adjustable fastening kits available (optional). The roof fastening kits enable installation without the need for aluminium TC fastening profiles.

- L: 1000 mm 06.1850.14
- L: 1500mm 06.1851.14
- L: 2000 mm 06.1852.14
- L: 3000 mm 06.1853.14

Kit di fissaggio a soffitto fisso (opzionale). Kit da 2 unità.

Fixed ceiling kit (optional). 2 unit kit.

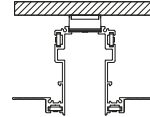

■ 08.8866.14

Kit di fissaggio a soffitto regolabile (opzionale). Kit da 2 unità. Per l'installazione è necessaria un'asta filettata M6, non compresa.

Adjustable ceiling kit (optional). 2 unit kit. Installation requires a M6 threaded rod, not included.

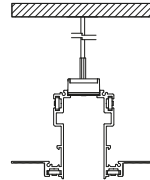

■ 08.8867.14

Profile (mm)	Quantities Ceiling Kit
1000	1
2000	2
3000	2
4000	3

Asta di sospensione da 1 m con rosone con filettatura m6.

1-m suspension rod with ceiling rose with m6 thread.

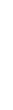

□ 60.3097.11
■ 60.3097.14

Terminale di chiusura. Si devono ordinare separatamente. Kit da 2 unità.

End caps. To be ordered separately. 2 unit kit.



■ 08.9070.14

THE FAST TRACK – SURFACE PROFILES

Profili

Profilo elettromeccanico per installazioni a superficie su soffitti di cartongesso con lunghezze da 1 a 3 metri. Non valido per installazioni a sospensione. I cavi di alimentazione e interconnessione vanno ordinati separatamente. I tappi vanno ordinati separatamente. Kit di fissaggio a soffitto fisso incluso.

Profiles

Electro-mechanical profile for surface installations in plasterboard ceilings, with 1m to 3m lengths. Not suitable for suspended installations. Power and interconnection cables must be ordered separately. Covers must be ordered separately. Fixed ceiling kit included.

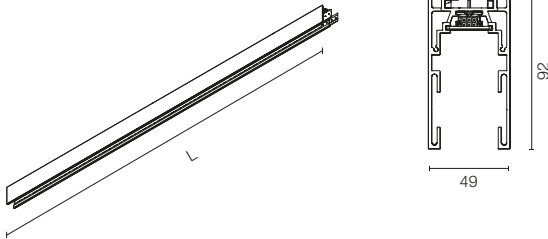

L: 1 m / 1,5 m / 2 m / 3 m

- L: 1000 mm
 - 06.1860.40
 - 06.1860.14
- L: 1500 mm
 - 06.1861.40
 - 06.1861.14
- L: 2000 mm
 - 06.1862.40
 - 06.1862.14
- L: 3000 mm
 - 06.1863.40
 - 06.1863.14

Terminale di chiusura. Da ordinare separatamente. Kit da 2 unità.

End caps. Must be ordered separately. 2 unit kit.



- 08.9071.40
- 08.9071.14

The Fast Track Recessed / Surface versions

Stopper. Per evitare che gli spot invadano zone della guida alimentate da un altro driver ed evitare di superare la potenza massima permessa in ogni driver. Può essere usato anche per limitare il movimento per altri motivi.

Stopper. To prevent spots from invading track areas powered by another driver and to prevent exceeding the maximum allowed power of each driver. It can also be used to limit movement for other reasons.



- 08.9074.14

Cavo di alimentazione.

Power feed cable.



06.0303.00

Cavo di connessione. Connessione elettrica.

Connection cable. Electrical connection.



06.0301.00

THE FAST TRACK – INSTALLATION PROFILES

RECESSED INSTALLATION

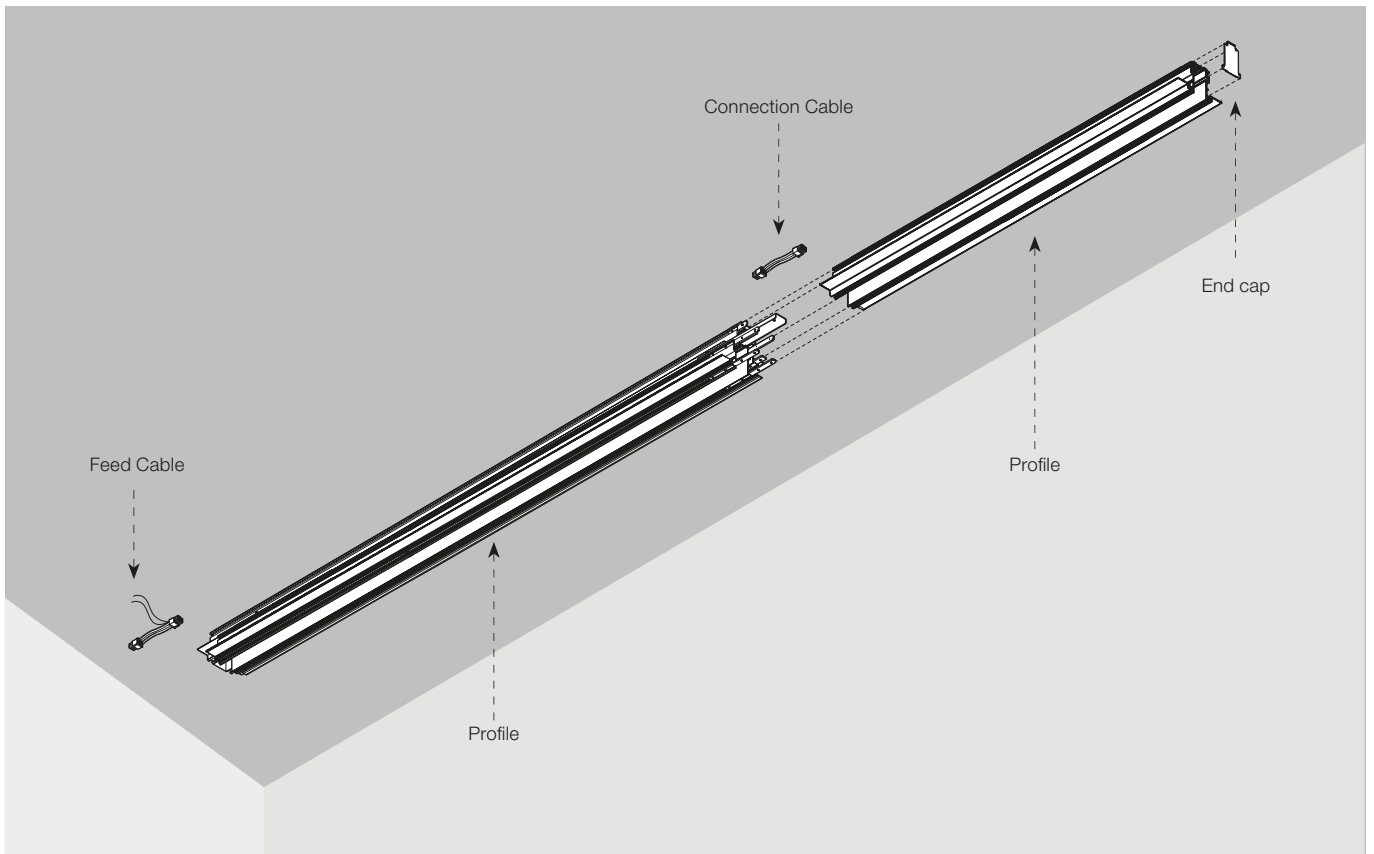

SURFACE INSTALLATION

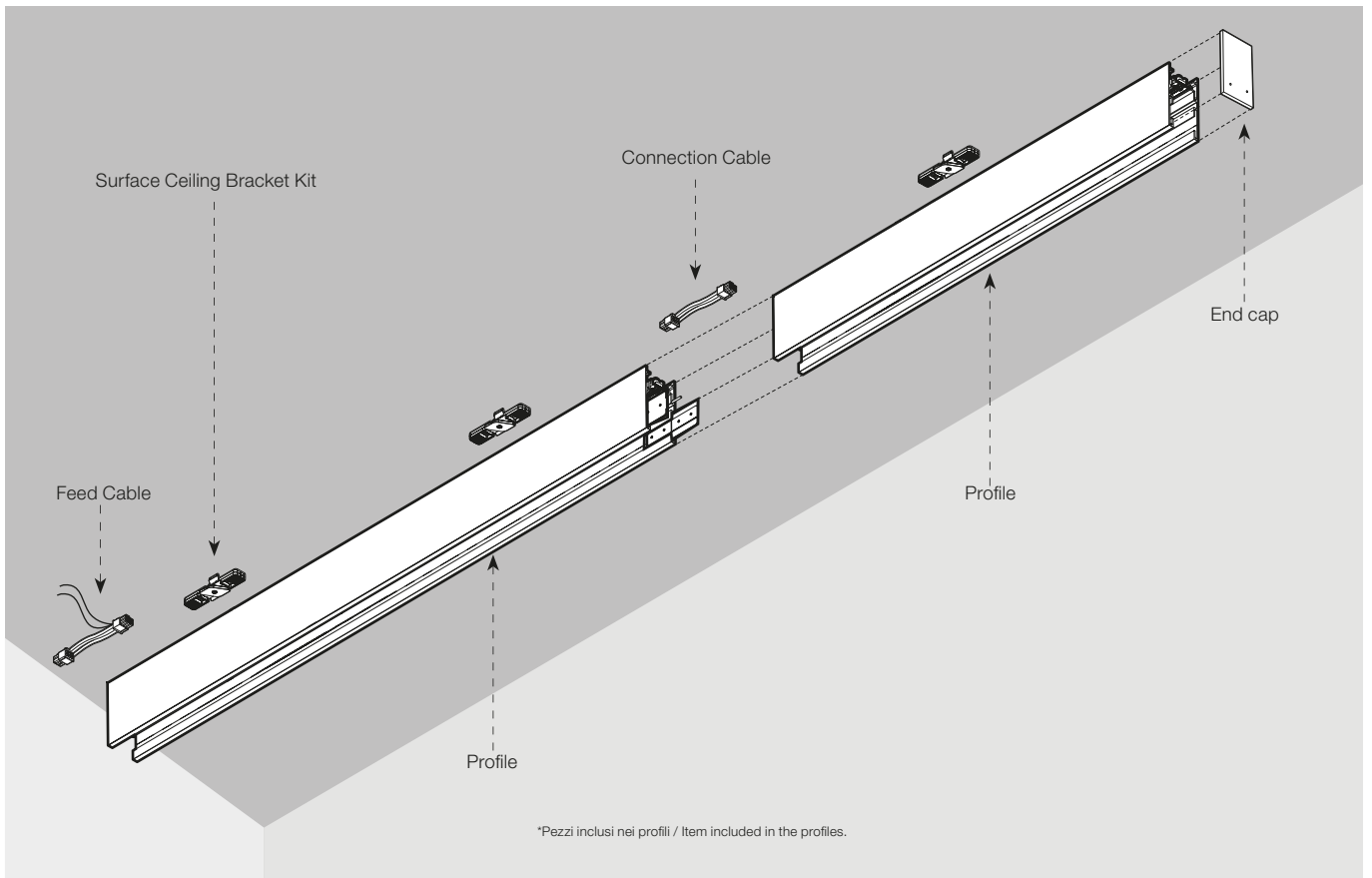

THE FAST TRACK – LIGHT MODULES

The Fast Track Spot 100

Light Source: Power LED 13W - 830 lm - 3000K/CRI 90 / 13W - 878 lm - 4000K/CRI 90

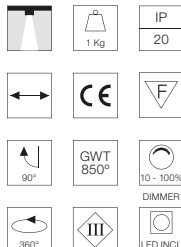
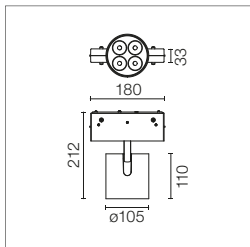

Proiettore per l'installazione nel profilo del sistema The Fast Track con sorgente luminosa LED e con ottica super spot, molto utile per grandi altezze, medium e flood. Le scatole degli apparecchi sono prodotte solo in nero.

Spotlight to be installed in the The Fast Track system profile with a LED light source and super spot optic, very useful for great heights, medium and flood. The boxes of the luminaries are manufactured only in black.

3000K

**Casambi integrated
09.9070.BW
09.9070.14

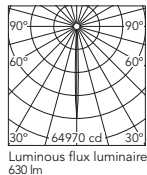

Beam Angle: 4°

h(m)	E(lx)	D(m)
1	64970	0.07
2	16243	0.14
3	7219	0.21
4	4061	0.28
5	2599	0.35

Luminous flux luminaire
630 lm

4000K

**Casambi integrated
09.9075.BW
09.9075.14

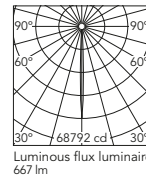

Beam Angle: 4°

h(m)	E(lx)	D(m)
1	68792	0.07
2	17198	0.14
3	7644	0.21
4	4300	0.28
5	2752	0.35

Luminous flux luminaire
667 lm

3000K

**Casambi integrated
09.9071.BW
09.9071.14

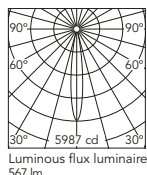

Beam Angle: 15°

h(m)	E(lx)	D(m)
1	5987	0.26
2	1497	0.52
3	665	0.77
4	374	1.03
5	239	1.29

Luminous flux luminaire
567 lm

4000K

**Casambi integrated
09.9076.BW
09.9076.14

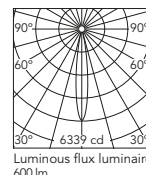

Beam Angle: 15°

h(m)	E(lx)	D(m)
1	6339	0.26
2	1585	0.52
3	704	0.77
4	396	1.03
5	254	1.29

Luminous flux luminaire
600 lm

3000K

**Casambi integrated
09.9072.BW
09.9072.14

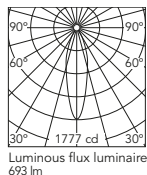

Beam Angle: 27°

h(m)	E(lx)	D(m)
1	1777	0.48
2	444	0.95
3	197	1.43
4	111	1.91
5	71	2.38

Luminous flux luminaire
693 lm

4000K

**Casambi integrated
09.9077.BW
09.9077.14

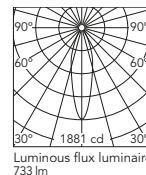

Beam Angle: 27°

h(m)	E(lx)	D(m)
1	1881	0.48
2	470	0.95
3	209	1.43
4	118	1.91
5	75	2.38

Luminous flux luminaire
733 lm

** Il sistema di controllo degli apparecchi i versione Casambi si regola direttamente tramite bluetooth con l'applicazione dedicata FLOS Control® by Casambi / The control system with the Casambi version of light fixtures is directly and individually regulated wirelessly using the application FLOS Control® by Casambi.

The Fast Track Spot 150

Light Source: LED Array 25,5W - 2080 lm - 3000K/CRI 90 / 25,5W - 2262 lm - 4000K/CRI 90

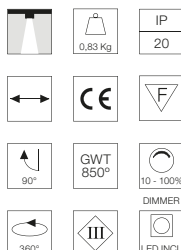
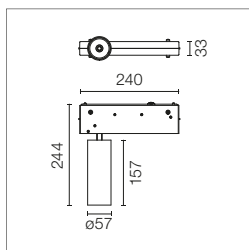

Proiettore per l'installazione nel profilo del sistema The Fast Track con sorgente luminosa LED e ottiche in vetro: spot, medium e flood ad alto rendimento. Le scatole degli apparecchi sono prodotte solo in nero.

Spotlight to be installed in the The Fast Track system profile with a LED light source and glass optics: high performance spot, medium and flood lights. The boxes of the luminaries are manufactured only in black.

3000K

**Casambi integrated

09.9083.BW

09.9083.14

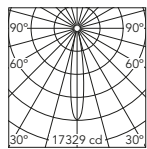

Beam Angle: 16°

h(m) E(lx) D(m)

1 17329 0.28

2 4332 0.56

3 1925 0.84

4 1083 1.12

5 693 1.40

Luminous flux luminaire
1872 lm**4000K**

**Casambi integrated

09.9086.BW

09.9086.14

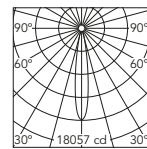

Beam Angle: 16°

h(m) E(lx) D(m)

1 18057 0.28

2 4514 0.56

3 2006 0.84

4 1129 1.12

5 722 1.40

Luminous flux luminaire
1951 lm**3000K**

**Casambi integrated

09.9084.BW

09.9084.14

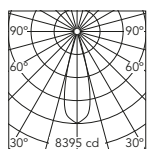

Beam Angle: 28°

h(m) E(lx) D(m)

1 8395 0.50

2 2099 1.00

3 933 1.50

4 525 2.00

5 336 2.50

Luminous flux luminaire
1816 lm**4000K**

**Casambi integrated

09.9087.BW

09.9087.14

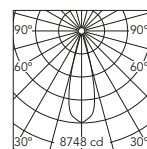

Beam Angle: 28°

h(m) E(lx) D(m)

1 8748 0.50

2 2187 1.00

3 972 1.50

4 547 2.00

5 350 2.50

Luminous flux luminaire
1892 lm**3000K**

**Casambi integrated

09.9085.BW

09.9085.14

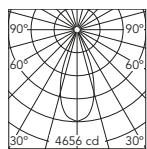

Beam Angle: 40°

h(m) E(lx) D(m)

1 4656 0.73

2 1164 1.46

3 517 2.18

4 291 2.91

5 186 3.64

Luminous flux luminaire
1838 lm**4000K**

**Casambi integrated

09.9088.BW

09.9088.14

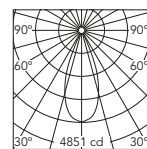

Beam Angle: 40°

h(m) E(lx) D(m)

1 4851 0.73

2 1213 1.46

3 539 2.18

4 303 2.91

5 194 3.64

Luminous flux luminaire
1915 lm

Accessori / Accessories

The Fast Track Spot 150

Crocetta di schermatura, lenti e honeycomb direttamente installabili sulla testa dell'apparecchio di illuminazione senza necessità di accessori di fissaggio. Compatibilità di installazione di honeycomb + lente contemporaneamente.

Screening crosspiece, lenses and honeycomb directly installable on the head of the luminaire without needing any fastening accessory. Installation compatible with honeycomb + lense at the same time.

Filtro a croce antiabbagliamento.

Screening crosspiece.



08.8429.00

Lente ellittica.

Elliptical lens.



08.8431.00

Lente flood.

Flood lens.



08.8432.00

Honeycomb.

Honeycomb.



08.8428.00

Cono di schermatura.

Snoot shielding cone.



 08.0526.00
08.0526.40
08.0526.BW

THE FAST TRACK

Driver / Drivers

Alimentatore LED per installazione remota, 48V/320W. 100/240 Vac.

LED power supply source for remote installation, 48V/320W. 100/240 Vac.

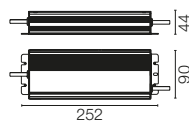

*RF27321

Alimentatore LED per installazione remota, 110Vac-135W / 220Vac-200W.

LED power supply source for remote installation, 110Vac-135W / 220Vac-200W.

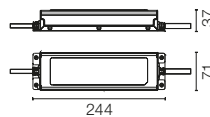

*60.9607

Alimentatore LED per installazione remota, 48V/120W. 220/240 Vac.

LED power supply source for remote installation, 48V/120W. 220/240 Vac.

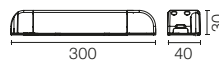

*60.9170

IN-FINITY

DESIGNED BY FLOS ARCHITECTURAL

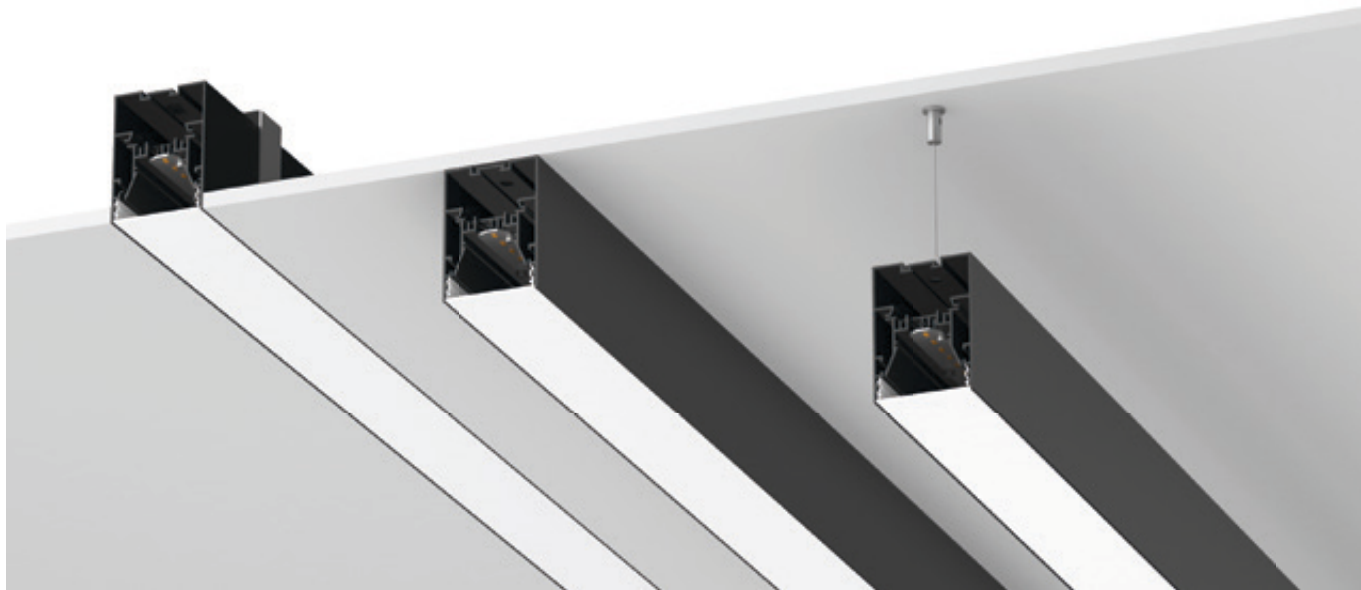

RECESSED TRIM / NO TRIM



35 mm

LIGHT SOURCE
TOP LED
18,5W/m
2665 lm/m
3000K/CRI 80
18,5W/m
2800 lm/m
4000K/CRI 80

SURFACE



70 mm

LIGHT SOURCE
TOP LED
25W/m
2985 lm/m
3000K/CRI 80
25W/m
3135 lm/m
4000K/CRI 80

SUSPENSION DOWN



100 mm

LIGHT SOURCE
TOP LED
25,5W/m
3110 lm/m
3000K/CRI 80
25,5W/m
3265 lm/m
4000K/CRI 80

SUSPENSION UP&DOWN



35 mm

LIGHT SOURCE
TOP LED
31,5W/m
1785 lm/m UP
2665 lm/m DOWN
3000K/CRI 80
31,5W/m
1875 lm/m UP
2800 lm/m DOWN
4000K/CRI 80

70 mm

LIGHT SOURCE
TOP LED
38W/m
1785 lm/m UP
2985 lm/m DOWN
3000K/CRI 80
38W/m
1875 lm/m UP
3135 lm/m DOWN
4000K/CRI 80

100 mm

LIGHT SOURCE
TOP LED
38,5W/m
1785 lm/m UP
3110 lm/m DOWN
3000K/CRI 80
38,5W/m
1875 lm/m UP
3265 lm/m DOWN
4000K/CRI 80

□ 30 Bianco
30 White

■ 02 Grigio Anodizzato
02 Anodized Grey

■ 14 Nero
14 Black



Descrizione

Sistema per illuminazione LED per installazione ad incasso, a parete o a sospensione progettato per le aree di lavoro e gli spazi professionali.

Gli apparecchi per illuminazione sono disponibili in larghezze di 35 mm, 70 mm o 100 mm.

Il sistema è formato da elementi lineari con misure da 565 mm fino a 3095 mm, angoli piani o angoli per modifica direzione soffitto-parete e accessori tipo tappi di chiusura e kit di sospensione.

In tutte le versioni, gli apparecchi per illuminazione sono forniti con:

- Moduli di luce LED con driver incluso, nelle versioni 3000K e 4000K.
- Profilo di alluminio per l'installazione.
- Riflettore.
- Sistema di giunzione per la connessione dei moduli.
- Cavo di sicurezza anti caduta degli apparecchi per illuminazione, allo scopo di garantire la massima protezione durante i lavori d'installazione.

Sono disponibili due diffusori differenti: opalino per l'illuminazione generale o diffusore microprismato per un ottimo comfort visivo. Disponibili anche come accessorio separato per completare spazi vuoti in strutture con angoli o lunghezza superiore a 3m.

Il profilo esterno della versione Recessed No Trim è disponibile solo nella finitura bianca. Tutte le altre versioni sono disponibili con le seguenti finiture: bianco, grigio anodizzato e nero.

Unità di Alimentazione

Drivers inclusi nei moduli d'illuminazione per connessione diretta a rete 220-240V o altri moduli del sistema.

Accessori

- Terminali di chiusura. Da ordinare separatamente.
- Kit di sospensione.
- Kit di alimentazione.

Informazioni Aggiuntive

Disponibile nella versione DALI 1-100%.

Versione dimmerabile 1-10V su richiesta.

Grado di protezione IP20, IP40.

Classe di isolamento I.

Conformità e Marchi di Qualità

Apparecchio conforme alla Normativa Tecnica Europea EN60598-1 e relative parti seconde.

Description

LED lighting system for recessed, surface or suspended installation, designed for work areas and the illumination of professional spaces. Luminaires are available in three different sections of 35 mm, 70 mm or 100 mm.

The system is composed of straight elements, with a range of measurements, from 565 up to 3095 mm, corner elements for angles on the same surface, or with wall-ceiling surface change, accessories such as end covers, and a suspension kit.

In all versions the luminaires come with:

- LED lighting modules, including drivers, in 3000K or 4000K versions.
- aluminum installation channel.
- Reflector.
- Junction system for the connection of the system's modular element.

- Safety cable to protect against the lamp's accidental falling, to provide for maximum safety during installation.

Two different diffusers are available: opal, for general, diffuse lighting; or a micro-prismatic for a better visual comfort. Also available as separate accessories to fill gaps in structures with corners or longer than 3 meters.

The external profile of the Recessed No Trim version is only available in white finish. All other versions are available in these finishes: white, anodized grey and black.

Power Supply

Drivers included in lighting modules for 220-240V connections to mains or to other lighting modules.

Accessories

- End caps. Must be ordered separately.
- Suspension kit.
- Feed unit kit.

Additional Information

Also available in DALI 1-100% version.

Dimmable 1-10V version under request.

IP20, IP40 protection degree.

Insulation Class I.

Standard Compliance and Quality Marks

EN60598-1 European Technical Standards and any subsequent additions.



Recessed
No Trim



Recessed
Trim



Surface



Suspension
Down



Suspension
Up&Down

IN - FINITY

Profili

Elementi lineari e angolari d'illuminazione in diverse lunghezze, che consentono composizioni specifiche per ciascun progetto, o poter essere completate con un coperchio su ciascuna estremità in modo da essere utilizzato come un singolo apparecchio luminoso. Tutti gli elementi del sistema sono completamente illuminati dal modulo LED incluso, e comprendono il driver necessario per il loro funzionamento, il canale d'installazione ed il diffusore della versione selezionata. Elementi a X o T personalizzati disponibili su richiesta.

Profiles

Straight elements of different lengths and corner elements, to be composed according to the specific need of each project or to be completed by a pair of end caps and used as a single lamp. All system elements are completely illuminated by an included LED module, the required driver, installation channel, and the diffuser for the version selected. Custom X or T elements available under request.

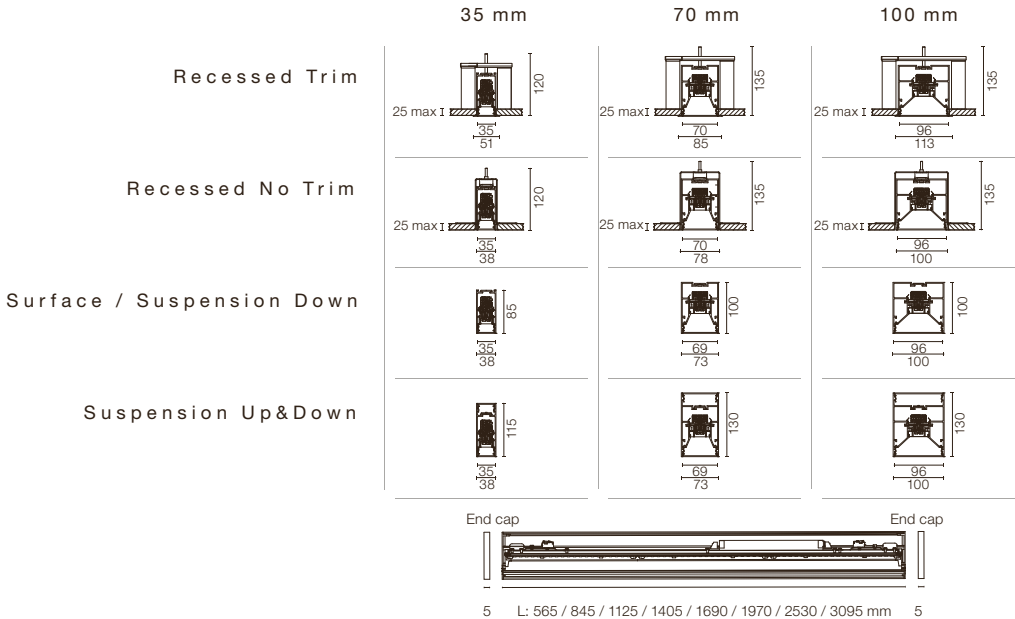

Angolo Piatto / Flat Corner

Apparecchio per illuminazione di angoli che si trovano sulla stessa superficie; completo di driver, canale d'installazione ed il diffusore della versione selezionata.

Corner element lamps for angles on the same surface, complete with a driver, installation channel and the diffuser for the version selected.



*L: 586 mm - N35 / L: 603 mm - N70 / L: 618 mm - N100

Angolo Diedro / Dihedral Corner

Apparecchio per illuminazione di angoli che si trovano su superfici differenti (esempio: angolo da soffitto a parete); completo di driver, canale d'installazione ed il diffusore della versione selezionata. Non disponibile per le versioni di sospensione.

Corner element lamps for angles with surface changes (example: angle ceiling / wall), complete with a driver, installation channel and the diffuser for the version selected. For suspended versions not available.

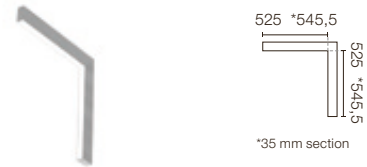

Emergenza / Emergency

Modulo di emergenza disponibile in tutte le versioni, tranne che per la Up&Down. Nell'uso normale, stesso consumo dell'In-Finity standard. Nell'uso d'emergenza, emette un 10% del flusso luminoso normale per 3 ore.

Emergency module available for all versions except for the Up&Down version. In normal use, it uses the same power consumption as the standard In-Finity. In emergency use, it emits 10% of normal use during 3 hours.

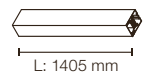

*Diffusore Opalino / Opal Diffuser

Illuminazione d'ambiente diffusa, uniforme e schermata. Disponibile anche come accessorio separato per completare spazi vuoti in strutture con angoli o lunghezza superiore a 3m.

Diffuse, glare free and uniform lighting throughout the room. Also available as separate accessory to fill gaps in structures with corners or longer than 3 meters.



*Diffusore Microprismato / Micro-Prismatic Diffuser

Diffusore altamente efficiente per illuminazione schermata di UGR<19, grazie alla sua esclusiva struttura microprismatica multistrato. Disponibile anche come accessorio separato per completare spazi vuoti in strutture con angoli o lunghezza superiore a 3m.

Highly efficient multilayer diffuser that, thanks to its unique micro-prismatic texture, provides a glare free UGR<19 light beam. Also available as separate accessory to fill gaps in structures with corners or longer than 3 meters.



IN-FINITY

COME OTTENERE IL PROPRIO CODICE / HOW TO GET YOUR CODE

Per una comprensione più rapida e una panoramica della gamma, la struttura della numerazione della famiglia In-Finity è stata creata per corrispondere alle richieste di ciascuna installazione specifica. In base alla seguente tabella, per ciascun campo, basta scegliere il numero o lettera corrispondente alla versione In-Finity desiderata e si otterrà il codice finale.

For a quicker understanding and easier overview of the range, the part number structure for the In-Finity family has been created to be composed to match the requests of each specific installation.

According to the following table, for each field, just choose the number or letter corresponding to the In-Finity version you need, and you'll have the final code.

		N	70	S	25	4	U	14B	DA
Sezione / Section									
35 mm	35								
70 mm	70								
100 mm	10								
*Installazione / Installation									
Recessed Trim	T								
Recessed No Trim	N								
Surface	S								
Suspension Down	D								
Suspension Up&Down	U								
Elementi / Elements									
Lineare / Straight 565 mm	05								
Lineare / Straight 845 mm	08								
Lineare / Straight 1125 mm	11								
Lineare / Straight 1405 mm	14								
Lineare / Straight 1690 mm	16								
Lineare / Straight 1970 mm	19								
Lineare / Straight 2530 mm	25								
Lineare / Straight 3095 mm	30								
Angolo Piatto / Flat Corner	FC								
Angolo Diedro / Dihedral Corner	DC								
Emergenza / Emergency (1405 mm)	EM								
Temperatura del Colore / Color T* (°K)									
3000K	3								
4000K	4								
**Ottica / Optic									
General Lighting (Opal)	G								
Micro-Prismatic Diffuser	U								
Colori / Colours									
		35 - 70 - 100							
Bianco / White	30B	30							
Grigio Anodizzato / Anodized Grey	02B	02							
Nero / Black	14B	14							
Versione / Version									
		35 - 70 - 100							
Standard (Non Dimmable)									
Dali	DA								

* La versione Recessed No Trim è disponibile solo nella finitura bianca (30). / No Trim Recessed version is only available in white finish (30).

Nelle versioni Suspension è disponibile solo l'angolo piatto. / In Suspension versions only available flat corner.

Nella versione Suspension Up&Down non è disponibile il profilo lineare da 565 mm. / Suspension Up&Down version is not available in 565 mm linear profile.

**Disponibili anche come accessorio separato per completare spazi vuoti in strutture con angoli o lunghezza superiore a 3m / Also available as separate accessories to fill gaps in structures with corners or longer than 3 m.

IN - FINITY

In-Finity Surface 35 mm

Light Source: Top LED 18,5W/m - 2665 lm/m - 3000K/CRI 80 / 18,5W/m - 2800 lm/m - 4000K/CRI 80

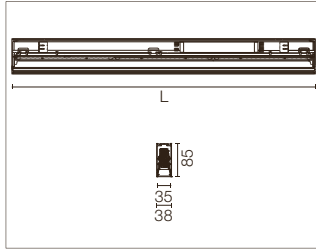

Sistema modulare d'illuminazione da superficie LED, formato da moduli LED, profilo di alluminio e diffusore. Drivers inclusi nei moduli d'illuminazione per il collegamento alla rete elettrica di 220-240V o ad altri moduli di illuminazione.

LED modular system for surface installation, including LED luminaires, aluminum installation profile, and diffusers. Drivers included in lighting modules for 220-240V connection to mains or to other lighting modules.

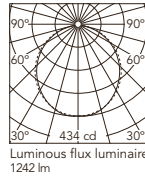

Beam Angle	h(m)	E lx	D(m)
1	434	2.84	
2	108	5.68	
3	48	8.52	
4	27	11.36	
5	17	14.19	

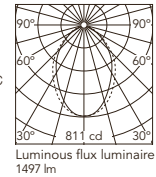

Beam Angle	h(m)	E lx	D(m)
1	811	1.55	
2	203	3.11	
3	90	4.66	
4	51	6.22	
5	32	7.77	

In-Finity Surface 70 mm

Light Source: Top LED 25W/m - 2985 lm/m - 3000K/CRI 80 / 25W/m - 3135 lm/m - 4000K/CRI 80

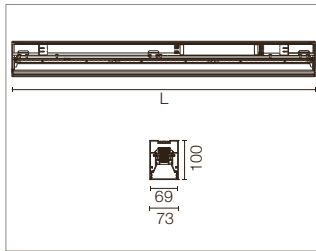

Sistema modulare d'illuminazione da superficie LED, formato da moduli LED, profilo di alluminio e diffusore. Drivers inclusi nei moduli d'illuminazione per il collegamento alla rete elettrica di 220-240V o ad altri moduli di illuminazione.

LED modular system for surface installation, including LED luminaires, aluminum installation profile, and diffusers. Drivers included in lighting modules for 220-240V connection to mains or to other lighting modules.

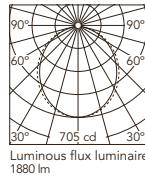

Beam Angle	h(m)	E lx	D(m)
1	705	2.51	
2	176	5.03	
3	78	7.54	
4	44	10.05	
5	28	12.57	

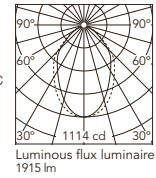

Beam Angle	h(m)	E lx	D(m)
1	1114	1.46	
2	278	2.92	
3	124	4.38	
4	70	5.84	
5	45	7.30	

In-Finity Surface 100 mm

Light Source: Top LED 25,5W/m - 3110 lm/m - 3000K/CRI 80 / 25,5W/m - 3265 lm/m - 4000K/CRI 80

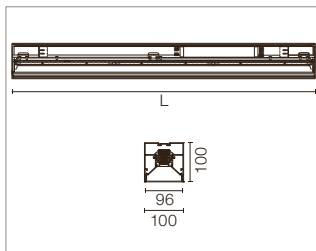

Sistema modulare d'illuminazione da superficie LED, formato da moduli LED, profilo di alluminio e diffusore. Drivers inclusi nei moduli d'illuminazione per il collegamento alla rete elettrica di 220-240V o ad altri moduli di illuminazione.

LED modular system for surface installation, including LED luminaires, aluminum installation profile, and diffusers. Drivers included in lighting modules for 220-240V connection to mains or to other lighting modules.

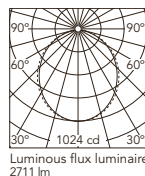

Beam Angle	h(m)	E lx	D(m)
1	1024	2.54	
2	256	5.07	
3	114	7.61	
4	64	10.14	
5	41	12.68	

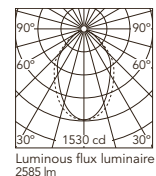

Beam Angle	h(m)	E lx	D(m)
1	1530	1.47	
2	383	2.95	
3	170	4.42	
4	96	5.90	
5	61	7.37	

IN - FINITY

In-Finity Recessed Trim 35 mm

Light Source: Top LED 18,5W/m - 2665 lm/m - 3000K/CRI 80 / 18,5W/m - 2800 lm/m - 4000K/CRI 80

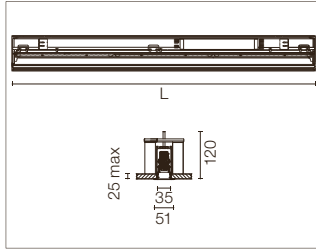

Sistema modulare di illuminazione ad incasso LED trim/no trim, formato da moduli LED, profilo di alluminio e diffusore. Drivers inclusi nei moduli d'illuminazione per il collegamento alla rete elettrica di 220-240V o ad altri moduli di illuminazione.

LED modular system for recessed trim/no trim installation, including LED luminaires, aluminum installation profile and diffusers. Drivers included in lighting modules for 220-240V connection to mains or to other lighting modules.

In-Finity Recessed No Trim 35 mm

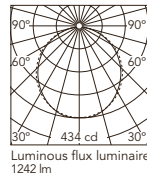
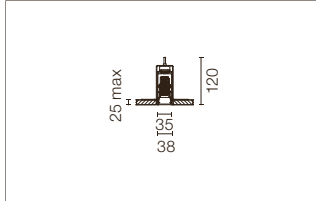

Beam Angle: 110°

h(m)	E(lx)	D(m)
1	434	2.84
2	108	5.68
3	48	8.52
4	27	11.36
5	17	14.19

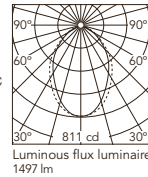

Beam Angle: 76°

h(m)	E(lx)	D(m)
1	811	1.55
2	203	3.11
3	90	4.66
4	51	6.22
5	32	7.77

In-Finity Recessed Trim 70 mm

Light Source: Top LED 25W/m - 2985 lm/m - 3000K/CRI 80 / 25W/m - 3135 lm/m - 4000K/CRI 80

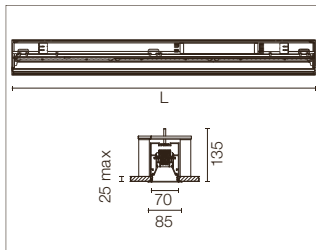
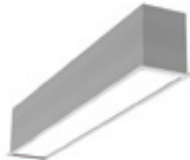

Sistema modulare di illuminazione ad incasso LED trim/no trim, formato da moduli LED, profilo di alluminio e diffusore. Drivers inclusi nei moduli d'illuminazione per il collegamento alla rete elettrica di 220-240V o ad altri moduli di illuminazione.

LED modular system for recessed trim/no trim installation, including LED luminaires, aluminum installation profile and diffusers. Drivers included in lighting modules for 220-240V connection to mains or to other lighting modules.

In-Finity Recessed No Trim 70 mm

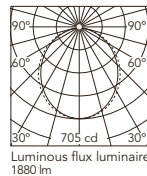
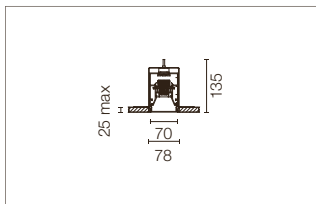

Beam Angle: 103°

h(m)	E(lx)	D(m)
1	705	2.51
2	176	5.03
3	78	7.54
4	44	10.05
5	28	12.57

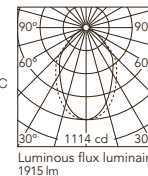

Beam Angle: 72°

h(m)	E(lx)	D(m)
1	1114	1.46
2	278	2.92
3	124	4.38
4	70	5.84
5	45	7.30

In-Finity Recessed Trim 100 mm

Light Source: Top LED 25,5W/m - 3110 lm/m - 3000K/CRI 80 / 25,5W/m - 3265 lm/m - 4000K/CRI 80

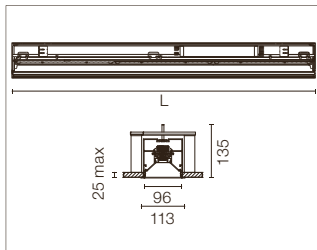
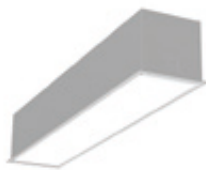

Sistema modulare di illuminazione ad incasso LED trim/no trim, formato da moduli LED, profilo di alluminio e diffusore. Drivers inclusi nei moduli d'illuminazione per il collegamento alla rete elettrica di 220-240V o ad altri moduli di illuminazione.

LED modular system for recessed trim/no trim installation, including LED luminaires, aluminum installation profile and diffusers. Drivers included in lighting modules for 220-240V connection to mains or to other lighting modules.

In-Finity Recessed No Trim 100 mm

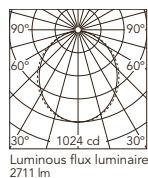
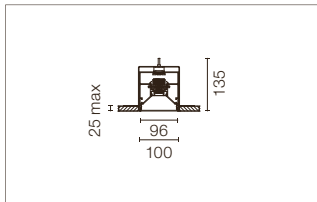

Beam Angle: 103°

h(m)	Et(x)	D(m)
1	1024	2.54
2	256	5.07
3	114	7.61
4	64	10.14
5	41	12.68

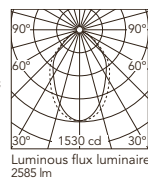

Beam Angle: 73°

h(m)	Et(x)	D(m)
1	1530	1.47
2	383	2.95
3	170	4.42
4	96	5.90
5	61	7.37

In-Finity Suspension Down 35 mm

Light Source: Top LED 18,5W/m - 2665 lm/m - 3000K/CRI 80 / 18,5W/m - 2800 lm/m - 4000K/CRI 80

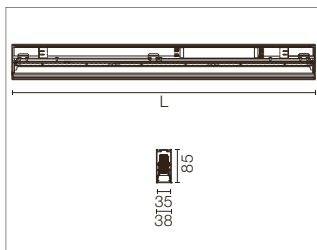

Sistema modulare d'illuminazione a sospensione LED formato da moduli LED, profilo di alluminio e diffusore. Drivers inclusi nei moduli d'illuminazione per il collegamento alla rete elettrica di 220-240V o ad altri moduli di illuminazione. Kit di sospensione non incluso.

LED modular system for suspended installation, including LED luminaires, aluminum installation profile, and diffusers. Drivers included in lighting modules for 220-240V connection to mains or to other lighting modules. Suspension kit not included.

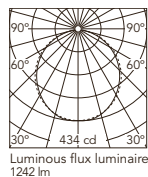

Beam Angle: 110°

h(m)	Et(x)	D(m)
1	434	2.84
2	108	5.68
3	48	8.52
4	27	11.36
5	17	14.19

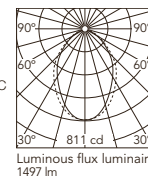

Beam Angle: 76°

h(m)	Et(x)	D(m)
1	811	1.55
2	203	3.11
3	90	4.66
4	51	6.22
5	32	7.77

In-Finity Suspension Down 70 mm

Light Source: Top LED 25W/m - 2985 lm/m - 3000K/CRI 80 / 25W/m - 3135 lm/m - 4000K/CRI 80

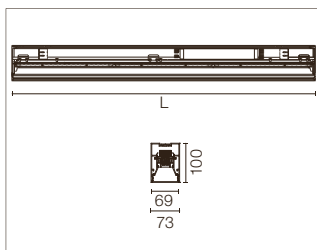

Sistema modulare d'illuminazione a sospensione LED formato da moduli LED, profilo di alluminio e diffusore. Drivers inclusi nei moduli d'illuminazione per il collegamento alla rete elettrica di 220-240V o ad altri moduli di illuminazione. Kit di sospensione non incluso.

LED modular system for suspended installation, including LED luminaires, aluminum installation profile, and diffusers. Drivers included in lighting modules for 220-240V connection to mains or to other lighting modules. Suspension kit not included.

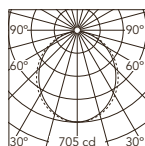

Luminous flux luminaire 1880 lm

Beam Angle: 103°

h(m)	E(lx)	D(m)
1	705	2.51
2	176	5.03
3	78	7.54
4	44	10.05
5	28	12.57

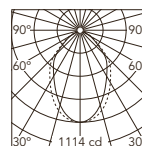

Luminous flux luminaire 1915 lm

Beam Angle: 72°

h(m)	E(lx)	D(m)
1	1114	1.46
2	278	2.92
3	124	4.38
4	70	5.84
5	45	7.30

In-Finity Suspension Down 100 mm

Light Source: Top LED 25,5W/m - 3110 lm/m - 3000K/CRI 80 / 25,5W/m - 3265 lm/m - 4000K/CRI 80

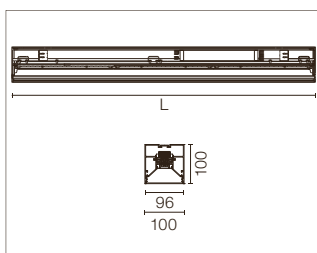

Sistema modulare d'illuminazione a sospensione LED formato da moduli LED, profilo di alluminio e diffusore. Drivers inclusi nei moduli d'illuminazione per il collegamento alla rete elettrica di 220-240V o ad altri moduli di illuminazione. Kit di sospensione non incluso.

LED modular system for suspended installation, including LED luminaires, aluminum installation profile, and diffusers. Drivers included in lighting modules for 220-240V connection to mains or to other lighting modules. Suspension kit not included.

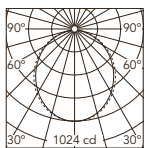

Luminous flux luminaire 2711 lm

Beam Angle: 103°

h(m)	E(lx)	D(m)
1	1024	2.54
2	256	5.07
3	114	7.61
4	64	10.14
5	41	12.68

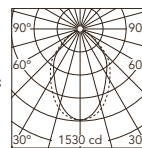

Luminous flux luminaire 2585 lm

Beam Angle: 73°

h(m)	E(lx)	D(m)
1	1530	1.47
2	383	2.95
3	170	4.42
4	96	5.90
5	61	7.37

In-Finity Suspension Up&Down 35 mm

Light Source: Top LED 31,5W/m - 1785 lm/m UP - 2665 lm/m DOWN - 3000K/CRI 80 / 31,5W/m - 1875 lm/m UP - 2800 lm/m DOWN - 4000K/CRI 80

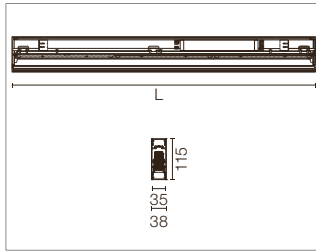

Sistema modulare d'illuminazione a sospensione LED formato da moduli LED, profilo di alluminio e diffusore. Drivers inclusi nei moduli d'illuminazione per il collegamento alla rete elettrica di 220-240V o ad altri moduli di illuminazione. Kit di sospensione incluso.

LED modular system for suspended installation, including LED luminaires, aluminum installation profile, and diffusers. Drivers included in lighting modules for 220-240V connection to mains or to other lighting modules. Suspension kit included.

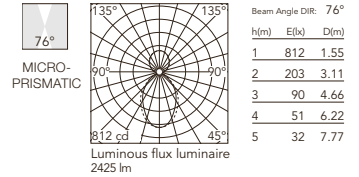
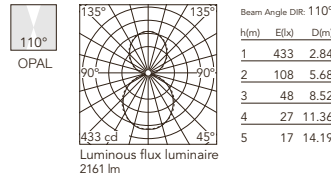

In-Finity Suspension Up&Down 70 mm

Light Source: Top LED 38W/m - 1785 lm/m UP - 2985 lm/m DOWN - 3000K/CRI 80 / 38W/m - 1875 lm/m UP - 3135 lm/m DOWN - 4000K/CRI 80

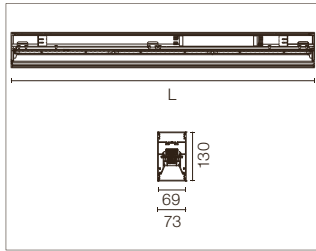

Sistema modulare d'illuminazione a sospensione LED formato da moduli LED, profilo di alluminio e diffusore. Drivers inclusi nei moduli d'illuminazione per il collegamento alla rete elettrica di 220-240V o ad altri moduli di illuminazione. Kit di sospensione incluso.

LED modular system for suspended installation, including LED luminaires, aluminum installation profile, and diffusers. Drivers included in lighting modules for 220-240V connection to mains or to other lighting modules. Suspension kit included.

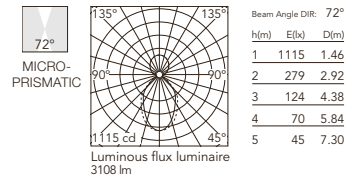
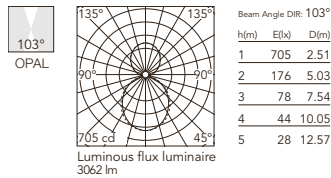

In-Finity Suspension Up&Down 100 mm

Light Source: Top LED 38,5W/m - 1785 lm/m UP - 3110 lm/m DOWN - 3000K/CRI 80 / 38,5W/m - 1875 lm/m UP - 3265 lm/m DOWN - 4000K/CRI 80

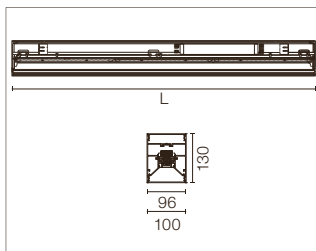

Sistema modulare d'illuminazione a sospensione LED formato da moduli LED, profilo di alluminio e diffusore. Drivers inclusi nei moduli d'illuminazione per il collegamento alla rete elettrica di 220-240V o ad altri moduli di illuminazione. Kit di sospensione incluso.

LED modular system for suspended installation, including LED luminaires, aluminum installation profile, and diffusers. Drivers included in lighting modules for 220-240V connection to mains or to other lighting modules. Suspension kit included.

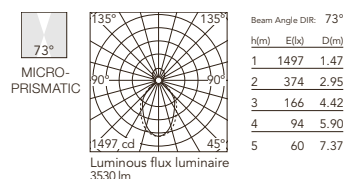
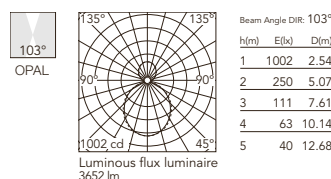

IN - FINITY

Accessori / Accessories

Terminali di chiusura, metallico, per i diversi profili. Kit di 2 unità.

Metal end cap for the different profiles. 2 unit kit.



Contattare Flos Architectural per una configurazione senza terminali di chiusura.

Contact Flos Architectural team for a configuration without end caps.

*La versione Recessed No Trim è disponibile solo nella finitura bianca (40).

*No Trim Recessed version is only available in white finish (40).

Recessed Trim

35 mm	08.9051.40
	08.9051.02
	08.9051.NS
70 mm	08.9053.40
	08.9053.02
	08.9053.NS
100 mm	08.9055.40
	08.9055.02
	08.9055.NS

Recessed No Trim* / Surface / Suspension Down

35 mm	08.9050.40
	08.9050.02
	08.9050.NS
70 mm	08.9052.40
	08.9052.02
	08.9052.NS
100 mm	08.9054.40
	08.9054.02
	08.9054.NS

Suspension Up&Down

35 mm	08.9056.40
	08.9056.02
	08.9056.NS
70 mm	08.9057.40
	08.9057.02
	08.9057.NS
100 mm	08.9058.40
	08.9058.02
	08.9058.NS

Kit di sospensione da una unità (L = 4 m). Distanza massima tra i cavi di sospensione: 2 m.

One unit suspension kit (L = 4 m). Maximum distance between the suspension cables: 2 m.



08.0030

Rosone di alimentazione per l'installazione sospesa di In-Finity. La versione standard viene fornita con cavo a tre poli per l'accensione semplice. La versione Dali viene fornita con cavo a cinque poli, che può essere utilizzato per l'accensione doppia indipendente dell'illuminazione diretta e indiretta nella versione Up&Down standard. Comprende cavo da sospensione di 4 m.

Power supply rose for the hanging installation of the In-finity. The standard version comes with a three-pole cable for basic switching. The Dali version comes with a five-pole cable that can be used for double switching, independent from the direct and indirect lighting in the standard Up&Down version. Includes a 4 m suspension cable.



08.0031.00
Dali Version
08.0031.00.DA

Diffusore opalino da 500 mm. Illuminazione d'ambiente diffusa, uniforme e schermata. Accessorio per completare spazi vuoti in strutture con angoli o lunghezza superiore a 3m.

500 mm opal diffuser. Diffuse, glare free and uniform lighting throughout the room. Accessory to fill gaps in structures with corners or longer than 3 meters.



In-Finity 35
08.0109.00
In-Finity 70
08.0110.00
In-Finity 100
08.0111.00

Diffusore microprismato da 500 mm. Diffusore altamente efficiente per illuminazione schermata di UGR<19, grazie alla sua esclusiva struttura microprismatica multistrato. Accessorio per completare spazi vuoti in strutture con angoli o lunghezza superiore a 3m.

500 mm micro-prismatic diffuser. Highly efficient multilayer diffuser that, thanks to its unique micro-prismatic texture, provides a glare free UGR<19 light beam. Accessory to fill gaps in structures with corners or longer than 3 meters.



In-Finity 35
08.0112.00
In-Finity 70
08.0113.00
In-Finity 100
08.0114.00

LED SQUAD / LED SQUAD MINI

DESIGNED BY FLOS ARCHITECTURAL

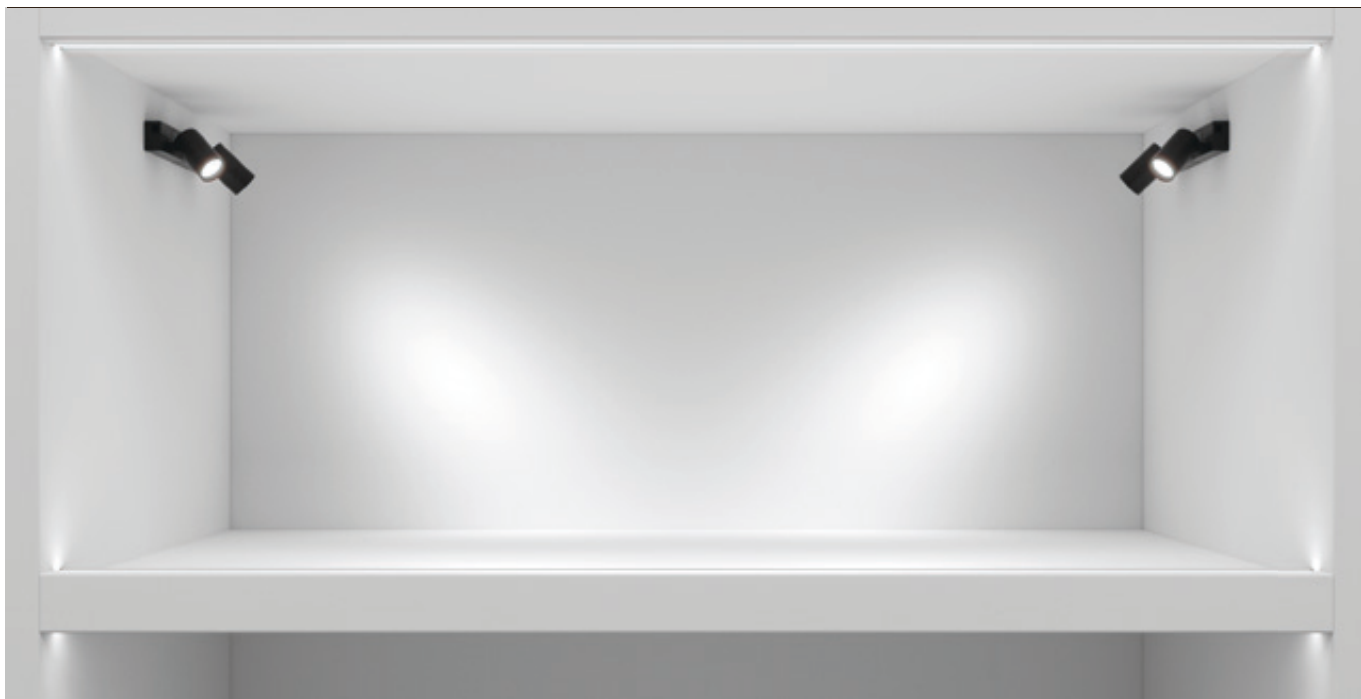

**LED SQUAD
MINI**



LIGHT SOURCE
POWER LED
17W/m
24V
1900 lm/m
3000K/CRI 90

LED SQUAD



LIGHT SOURCE
TOP LED
25W/m
24V
2500 lm/m
3000K/CRI 90

**LED SQUAD
1 SPOT**



LIGHT SOURCE
POWER LED
4W
24V
220 lm
3000K/CRI 80

**LED SQUAD
2 SPOTS**



LIGHT SOURCE
POWER LED
6W
24V
2x220 lm
3000K/CRI 80

LED Squad Mini

29 Alluminio Anodizzato
29 Anodized Aluminium



LED Squad

29 Alluminio Anodizzato
29 Anodized Aluminium

AN Nero Anodizzato
AN Anodized Black



LED Squad Spot

30 Bianco
30 White

02 Grigio
02 Grey

14 Nero
14 Black



LED SQUAD / LED SQUAD MINI

Descrizione

Apparecchio di illuminazione da installare in superficie con fonte luminosa LED. Realizzata mediante un profilo in alluminio estruso in cui sono inseriti moduli LED lineari. Dispone di diffusore opale per ottenere una diffusione ottima della luce e connettori rapidi per poter effettuare unioni tra moduli di diverse lunghezze.

La versione Spot è formata da un corpo ottico in alluminio in cui è inserito un LED di potenza ad alta resa. Il controllo ottico è realizzato tramite lenti, con tre angoli di apertura.

Unità di Alimentazione

Il sistema è alimentato a 24V, per i quali esistono fonti di alimentazione da 20W e 60W.

Lunghezza massima dei moduli LED alimentati da una fonte di alimentazione:

- LED Squad: 2 m (60W).

- LED Squad Mini: 3x1,118 m (60W).

Numero massimo di spot collegati tra loro con una fonte di alimentazione: 6 spot.

Informazioni Aggiuntive

Massima potenza con una fonte di alimentazione da 60W.

Grado di protezione IP20.

Classe di isolamento III.

Conformità e Marchi di Qualità

Apparecchio conforme alla Normativa Tecnica Europea EN60598-1 e relative parti seconde.

Description

Luminaire to be installed on surface with LED light source. Made out of aluminium extrusion profile in which linear LED modules are incorporated. It has an opal diffuser to obtain perfect light diffusion and quick connectors to be able to make joints between different length modules.

The Spot version is made up of an aluminium optical body which includes a high performance power LED. Optical control is made using lenses, with three opening angles.

Power Supply

The system is powered at 24V, and has 20W and 60W power supplies.

Maximum length of LED modules powered from a power supply:

- LED Squad: 2 m (60W).

- LED Squad Mini: 3x1,118 m (60W).

Maximum number of spots connected together with a power supply: 6 spots.

Additional Information

Maximum power with a 60W power supply.

IP20 protection grade.

Insulation class III.

Standard Compliance and Quality Marks

EN60598-1 European Technical Standards and any subsequent additions.



Led Squad



Led Squad Spot

LED SQUAD / LED SQUAD MINI

LED Squad Mini

Light Source: Top LED 17 W/m - 24V - 1900 lm/m - 3000K/CRI 90

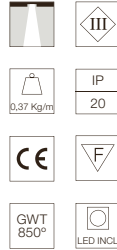
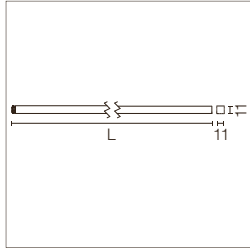

Apparecchio da installare a superficie con sorgente luminosa LED. Formato da un profilo di alluminio estruso su cui si inseriscono moduli lineari LED. Punti invisibili di luce continua. È dotato di un connettore rapido per poter unire moduli di diverse lunghezze senza cablaggio. Presenta un sistema di fissaggio magnetico su superfici metalliche o supporti da avvitare su superfici normali.

Luminaire for surface installation with LED light source. Composed of an extruded aluminum profile to which LED linear modules are incorporated. Invisible dots with continuous light. It has a fast connector in order to join modules of different lengths without wiring. It has a magnetic fixing system on metal surfaces or brackets to screw on conventional surfaces.

Cavi di installazione e driver non compresi. Da ordinare separatamente. Non compatibile con faretti. Non dimmable.

Installation cables and driver not included. To be ordered separately. Not compatible with spots. Non dimmable.

- L: 100 mm**
1,5W - 190 lm
03.4060.29
10 Units Kit
03.4060.29.1Y

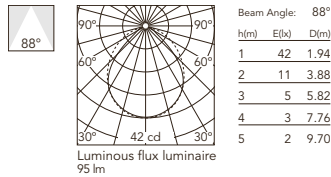

- L: 563 mm**
8,8W - 1070 lm
03.4063.29
10 Units Kit
03.4063.29.1Y

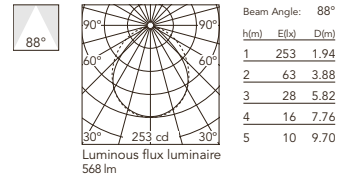

- L: 193 mm**
2,9W - 367 lm
03.4061.29
10 Units Kit
03.4061.29.1Y

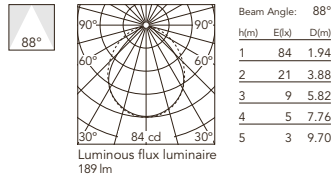

- L: 841 mm**
13,2W - 1598 lm
03.4064.29
10 Units Kit
03.4064.29.1Y

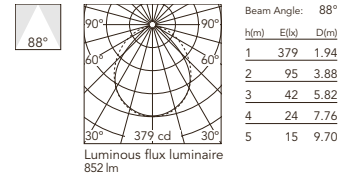

- L: 285 mm**
4,4W - 542 lm
03.4062.29
10 Units Kit
03.4062.29.1Y

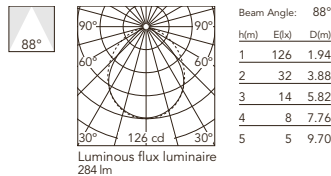

- L: 1118 mm**
17,6W - 2125 lm
03.4065.29
10 Units Kit
03.4065.29.1Y
50 Units Kit
03.4065.29.5Y

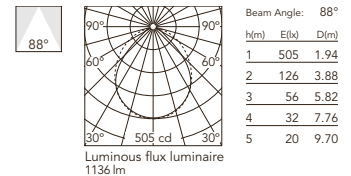

LED Squad

Light Source: Top LED 25 W/m - 24V - 2500 lm/m - 3000K/CRI 90

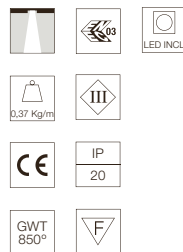
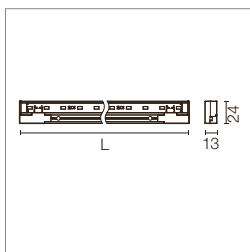

Apparecchio di illuminazione a parete per illuminazione diretta/indiretta con LED. Trasformatore remoto non incluso. Dimmable.

Direct/indirect lighting wall luminaire with LED. Remote transformer not included. Dimmable.

Cavi di installazione compresi: Cavo di alimentazione 500 mm. Cavo di collegamento 60 mm.

Installation cables included: Power cable 500 mm. Connection cable 60 mm.

- L: 125 mm**
3,2W - 313 lm - 7 LEDs
03.3960.29B
03.3960.ANB

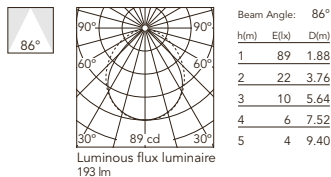

- L: 1000 mm**
25W - 2500 lm - 56 LEDs
03.3963.29B
03.3963.ANB

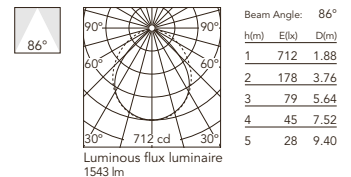

- L: 500 mm**
12,5W - 1250 lm - 28 LEDs
03.3962.29B
03.3962.ANB

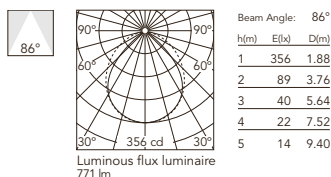

LED SQUAD / LED SQUAD MINI

LED Squad 1 Spot

Light Source: Power LED 4W - 24V - 220 lm - 3000K/CRI 80

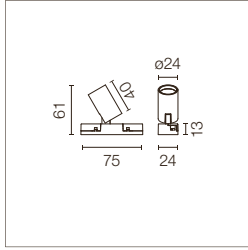

Proiettore da installare in superficie.
Fonte di alimentazione non inclusa.
Dimmable.

Surface mounted spotlight.
Power supply not included.
Dimmable.



Cavi di installazione compresi:
Cavo di alimentazione 500 mm.
Cavo di collegamento 60 mm.

Installation cables included:
Power cable 500 mm.
Connection cable 60 mm.



- 03.3970.30A
- 03.3970.02A
- 03.3970.14A

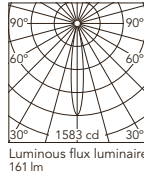

Beam Angle: 15°		
h(m)	E(lx)	D(m)
1	1583	0.27
2	396	0.54
3	176	0.81
4	99	1.08
5	63	1.35

- 03.3972.30A
- 03.3972.02A
- 03.3972.14A

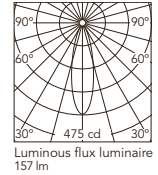

Beam Angle: 28°		
h(m)	E(lx)	D(m)
1	475	0.49
2	119	0.99
3	53	1.48
4	30	1.98
5	19	2.47

- 03.3971.30A
- 03.3971.02A
- 03.3971.14A

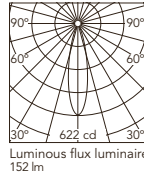

Beam Angle: 24°		
h(m)	E(lx)	D(m)
1	622	0.43
2	156	0.85
3	69	1.28
4	39	1.71
5	25	2.13

LED Squad 2 Spots

Light Source: Power LED 6W - 24V - 2x220 lm - 3000K/CRI 80

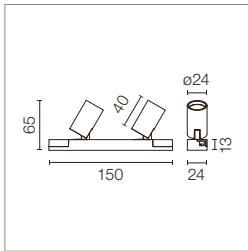

Proiettore da installare in superficie.
Fonte di alimentazione non inclusa.
Non Dimmable.

Surface mounted spotlight.
Power supply not included.
Non Dimmable.



Cavi di installazione compresi:
Cavo di alimentazione 500 mm.
Cavo di collegamento 60 mm.

Installation cables included:
Power cable 500 mm.
Connection cable 60 mm.



- 03.3975.30A
- 03.3975.02A
- 03.3975.14A

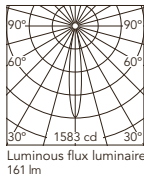

Beam Angle: 15°		
h(m)	E(lx)	D(m)
1	1583	0.27
2	396	0.54
3	176	0.81
4	99	1.08
5	63	1.35

- 03.3977.30A
- 03.3977.02A
- 03.3977.14A

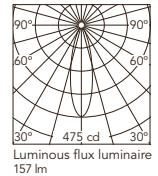

Beam Angle: 28°		
h(m)	E(lx)	D(m)
1	475	0.49
2	119	0.99
3	53	1.48
4	30	1.98
5	19	2.47

- 03.3976.30A
- 03.3976.02A
- 03.3976.14A

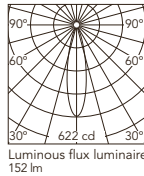

Beam Angle: 24°		
h(m)	E(lx)	D(m)
1	622	0.43
2	156	0.85
3	69	1.28
4	39	1.71
5	25	2.13

LED SQUAD / LED SQUAD MINI

Driver / Drivers

LED Squad / LED Squad Mini

Trasformatore elettronico per LED a tensione costante (24V). 100/240V.

Electronic transformer with constant voltage (24V) for LED. 100/240V.

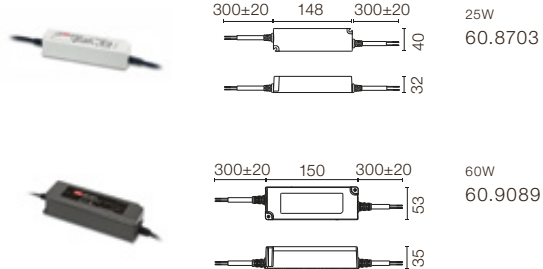

LED Squad: eccetto 2 Spots version / except for 2 Spots version

Unità di controllo per dimmer 1-10V con 1 canale per la regolazione di moduli LED, per drivers di 24V. Alimentatore non incluso. Max. 120W - 5A.

Dimmable 1-10V control unit with 1 channel for 24V LED modules. Power supply not included. Max. 120W - 5A.

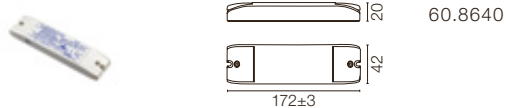

Unità di controllo dimmer DALI con 1 canale per la regolazione di moduli LED, per drivers di 24V. Alimentatore non incluso.

Dimmable Dali control unit with 1 channel for 24V LED modules. Power supply not included.

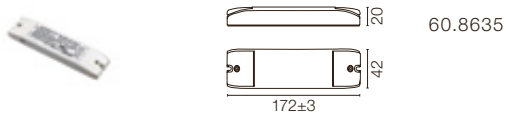

LED Squad Mini

Cavo di alimentazione 2500 mm.

Feed cable 2500 mm.



06.0097.00

Cavo di collegamento 150 mm.

Connection cable 150 mm.



06.0098.00

LIGHT CUT MINI
DESIGNED BY FLOS ARCHITECTURAL





PERIMETRAL

70 mm

140 mm



SPOTS MODULES

				
LIGHT SOURCE LED ARRAY 18W 1850 lm 3000K/CRI 90	LIGHT SOURCE LED ARRAY 14,4W 1780 lm 3000K/CRI 80 14,4W 1440 lm 3000K/CRI 90	LIGHT SOURCE POWER LED 10W 840 lm 3000K/CRI 80	LIGHT SOURCE PHOSPHOR LED 17W 1400 lm 3000K/CRI 98 18W 1870 lm 3000K/CRI 80	LIGHT SOURCE LED QR-CBC 51 GX5.3

30 Bianco Opaco
30 Matt White

14 Nero Opaco
14 Matt Black



LIGHT CUT MINI

Descrizione

Sistema di illuminazione composto da un profilo estruso che si integra perfettamente in soffitti realizzati in cartongesso. È predisposto per integrare in modo semplice l'illuminazione con proiettori LED o alogeni. I proiettori sono predisposti per essere installati direttamente sopra il profilo, con dispositivi remoti di classe II. Inoltre, sono disponibili due misure, a seconda dell'installazione. Dispone di accessori per ottimizzare il comfort visivo e di filtri colorati.

Informazioni Aggiuntive

Installabile esclusivamente su superfici di cartongesso di 12,5 mm di spessore.
È possibile accorciare i profili fino a qualsiasi dimensione.
Grado di protezione IP20.
Adatti ad installazioni su superfici normalmente infiammabili.

Conformità e Marchi di Qualità

Apparecchio conforme alla Normativa Tecnica Europea EN60598-1 e relative parti seconde.

Description

Lighting system comprising an extruded profile which integrates perfectly in plasterboard ceilings. It is prepared for the simple integration of lighting with LED or halogens projectors. The projectors are prepared for installation directly on the profile, with Class II remote equipment. Furthermore, they are available in two sizes depending on the installation. It has accessories for visual comfort optimization and colour filters.

Additional Information

Can only be installed in 12.5 mm thick plaster-board.
It is possible to cut the profiles to any size.
IP20 protection grade.
Suitable for installation on normally inflammable surfaces.

Standard Compliance and Quality Marks

EN60598-1 European Technical Standards and any subsequent additions.



Profiles



Spot Module



Spot Module
Electrical
Connection

LIGHT CUT MINI – PROFILES

Installazione Canale 70 / Canale 140

Struttura realizzata in alluminio, da integrare in soffitti in cartongesso.
Consente di incorporare proiettori. E' composto da profili da 1 o 2 metri per l'installazione all'interno di un canale più angoli interni ed esterni doppi.
È possibile accorciare i profili fino a qualsiasi dimensione.

Channel 70 / Channel 140 Installation

Structural system in aluminium to integrate in plasterboard ceilings. It allows incorporation of projectors. Channel installation consists of 1 or 2 meter profiles, double inside and outside corners. It is possible to cut the profiles to any size.

Profilo in alluminio. Kit da 2 unità. Aluminium profile. 2 unit kit.

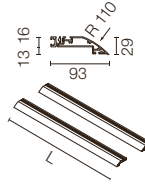

Channel 70 / 140
L: 1000 mm

08.8720.30
08.8720.14
L: 2000 mm
08.8721.30
08.8721.14

Terminale di chiusura. End cap.

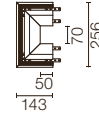
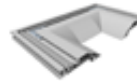

Channel 70
08.8705.30
08.8705.14

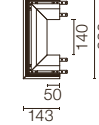

Channel 140
08.8706.30
08.8706.14

Angolo. Corner.

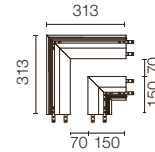
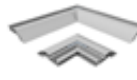

Channel 70
08.8707.30
08.8707.14

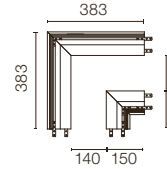

Channel 140
08.8708.30
08.8708.14

Installazione Perimetrale

Struttura realizzata in alluminio, da integrare in soffitti in cartongesso.
Consente di incorporare proiettori. E' composto da profili da 1 o 2 metri per l'installazione perimetrale più angoli interni ed esterni. È possibile accorciare i profili fino a qualsiasi dimensione.

Perimetral Installation

Structural system in aluminium to integrate in plasterboard ceilings. It allows incorporation of projectors. Perimetral installation consists of 1 or 2 meter profiles, inside and outside corners. It is possible to cut the profiles to any size.

Profilo in alluminio. Kit da 1 unità. Aluminium profile. 1 unit kit.

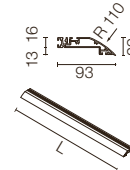

L: 1000 mm

08.8701.30
08.8701.14
L: 2000 mm
08.8702.30
08.8702.14

Angolo interno. Inner corner.



08.8709.30
08.8709.14

Angolo esterno. Outer corner.

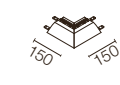

08.8710.30
08.8710.14

Accessorio per angolo verticale. Accessory for vertical corner.



08.8711.00

LIGHT CUT MINI – SPOTS

Spot Module Pro LED Array

Light Source: LED Array / LED Array High Performance DC 500 mA - 18W - 1850 lm - 3000K/CRI 90

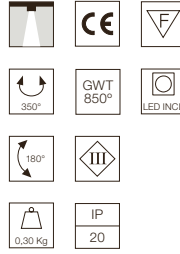
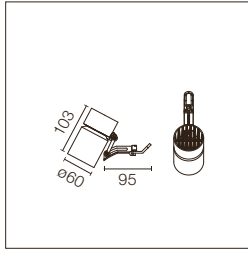

Proiettore per l'installazione nella struttura Light Cut Mini. Fonte di alimentazione a corrente costante remota. I riferimenti "High Performance" comprendono un riflettore ad alto rendimento.

Spotlight to be installed on Light Cut Mini system. Remote continuous current supply source not included. High performance part numbers include high performance reflector.

Alimentazioni raccomandate / Recommended power supply*:

Non Dimmable 220-240V	60.9160
Dimmable 0/1-10V / Push 220-240V	RF27961
Dimmable DALI 1 110-240V	RF26571
Dimmable DALI 2 110-240V	60.9222
Mains Dimming 220-240V	60.9467
Casambi 220-240V	60.9207

* Vedi capitolo Drivers / Refer to the Drivers chapter

09.0360.30
09.0360.14

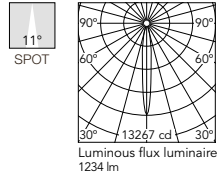

h(m)	E(lx)	D(m)
1	13267	0.19
2	3317	0.39
3	1474	0.58
4	829	0.77
5	531	0.97

High Performance
09.0365.30
09.0365.14

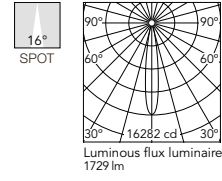

h(m)	E(lx)	D(m)
1	16282	0.28
2	4071	0.56
3	1809	0.83
4	1018	1.11
5	651	1.39

09.0361.30
09.0361.14

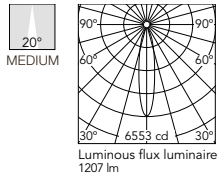

h(m)	E(lx)	D(m)
1	6553	0.35
2	1638	0.71
3	728	1.06
4	410	1.41
5	262	1.77

High Performance
09.0366.30
09.0366.14

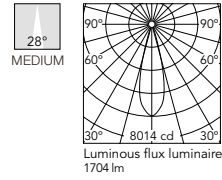

h(m)	E(lx)	D(m)
1	8014	0.50
2	2004	0.99
3	890	1.49
4	501	1.98
5	321	2.48

09.0362.30
09.0362.14

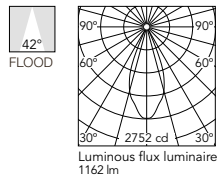

h(m)	E(lx)	D(m)
1	2752	0.76
2	688	1.53
3	306	2.29
4	172	3.05
5	110	3.81

High Performance
09.0367.30
09.0367.14

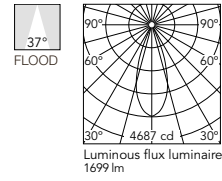

h(m)	E(lx)	D(m)
1	4687	0.67
2	1172	1.34
3	521	2.00
4	293	2.67
5	187	3.34

Spot Module LED Array

Light Source: LED Array DC 450 mA - 14,4W - 1780 lm - 3000K/CRI 80 / 14,4W - 1440 lm - 3000K/CRI 90

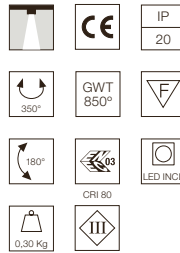
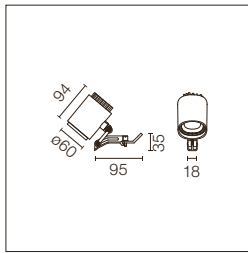

Proiettore per l'installazione nella struttura Light Cut Mini. Fonte di alimentazione a corrente costante remota.

Spotlight to be installed on Light Cut Mini system. Remote continuous current supply source not included.

Alimentazioni raccomandate / Recommended power supply*:

Non Dimmable 220-240V	60.9160
Dimmable 0/1-10V 110-240V	RF27961
Dimmable DALI 1 110-240V	RF26571
Mains Dim. Trailing Edge 220-240V	60.9268
Casambi 220-240V	60.9207

* Vedi capitolo Drivers / Refer to the Drivers chapter

CRI 80
09.0211.30A
09.0211.14A

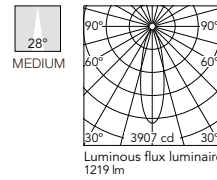

h(m)	E(lx)	D(m)
1	3907	0.49
2	977	0.99
3	434	1.48
4	244	1.98
5	156	2.47

CRI 90
09.0217.30A
09.0217.14A

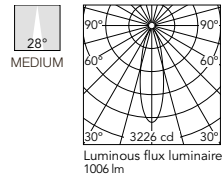

h(m)	E(lx)	D(m)
1	3226	0.49
2	806	0.99
3	358	1.48
4	202	1.98
5	129	2.47

CRI 80
09.0212.30A
09.0212.14A

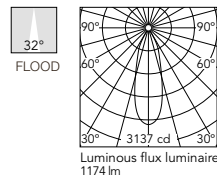

h(m)	E(lx)	D(m)
1	3137	0.57
2	784	1.13
3	349	1.70
4	196	2.26
5	125	2.83

CRI 90
09.0218.30A
09.0218.14A

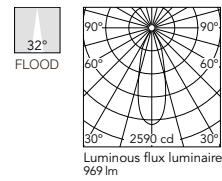

h(m)	E(lx)	D(m)
1	2590	0.57
2	647	1.13
3	288	1.70
4	162	2.26
5	104	2.83

CRI 80
09.0213.30A
09.0213.14A

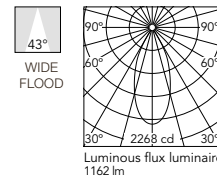

h(m)	E(lx)	D(m)
1	2268	0.78
2	567	1.56
3	252	2.34
4	142	3.12
5	91	3.91

CRI 90
09.0219.30A
09.0219.14A

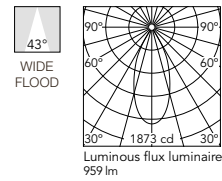

h(m)	E(lx)	D(m)
1	1873	0.78
2	468	1.56
3	208	2.34
4	117	3.12
5	75	3.91

LIGHT CUT MINI – SPOTS

Spot Module Power LED

Light Source: Power LED DC 900 mA - 10W - 840 lm - 3000K/CRI 80

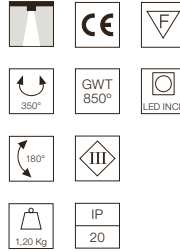
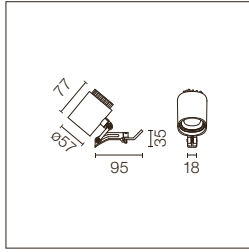

Proiettore per l'installazione nella struttura Light Cut Mini. Fonte di alimentazione a corrente costante remota.

Spotlight to be installed on Light Cut Mini system. Remote continuous current supply source not included.

Alimentazioni raccomandate / Recommended power supply*:

Non Dimmable 220-240V	RF27370
Dimmable 0/1-10V 110-240V	RF27961
Dimmable DALI 2 110-240V	RF30699
Mains Dimming 220-240V	60.9467
Casambi 220-240V	60.9207

* Vedi capitolo Drivers / Refer to the Drivers chapter

09.0220.30A
09.0220.14A

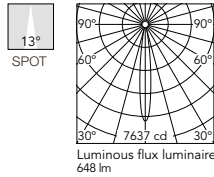

Beam Angle: 13°

h(m)	E(lx)	D(m)
1	7637	0.23
2	1909	0.46
3	849	0.69
4	477	0.92
5	305	1.14

Luminous flux luminaire
648 lm

09.0221.30A
09.0221.14A

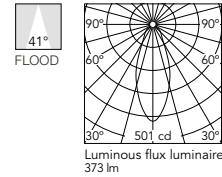

Beam Angle: 41°

h(m)	E(lx)	D(m)
1	501	0.75
2	125	1.50
3	56	2.25
4	31	3.00
5	20	3.75

Luminous flux luminaire
373 lm

Spot Module Phosphor LED

Light Source: Phosphor LED DC 650 mA - 18W - 1870 lm - 3000K/CRI 80 / DC 700 mA - 17W - 1400 lm - 3000K/CRI 98

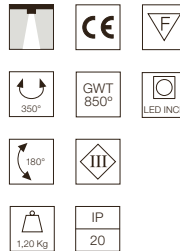
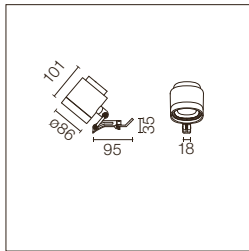

Proiettore per l'installazione nella struttura Light Cut Mini. Fonte di alimentazione a corrente costante remota.

Spotlight to be installed on Light Cut Mini system. Remote continuous current supply source not included.

Solo per installazione in Canale 140.

Only for Channel 140 installation.

Alimentazioni raccomandate / Recommended power supply*:

Non Dimmable 220-240V	RF27370
Dimmable 0/1-10V 110-240V	RF27961
Dimmable DALI 2 110-240V	RF30699
Mains Dimming 220-240V	60.9467
Casambi 220-240V	60.9207

* Vedi capitolo Drivers / Refer to the Drivers chapter

CRI 80
09.0230.30
09.0230.14

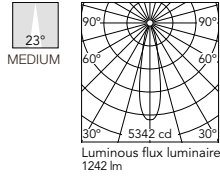

Beam Angle: 23°

h(m)	E(lx)	D(m)
1	5342	0.41
2	1336	0.81
3	594	1.22
4	334	1.63
5	214	2.03

Luminous flux luminaire
1242 lm

CRI 98
09.0232.30
09.0232.14

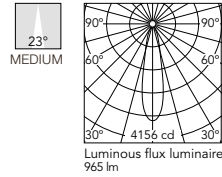

Beam Angle: 23°

h(m)	E(lx)	D(m)
1	4156	0.41
2	1039	0.81
3	462	1.22
4	260	1.63
5	166	2.04

Luminous flux luminaire
965 lm

CRI 80
09.0231.30
09.0231.14

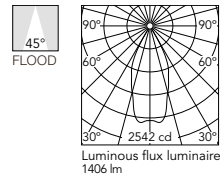

Beam Angle: 45°

h(m)	E(lx)	D(m)
1	2542	0.84
2	636	1.68
3	282	2.52
4	159	3.35
5	102	4.19

Luminous flux luminaire
1406 lm

CRI 98
09.0233.30
09.0233.14

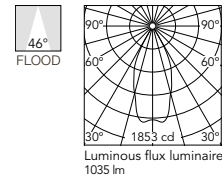

Beam Angle: 46°

h(m)	E(lx)	D(m)
1	1853	0.85
2	463	1.70
3	206	2.54
4	116	3.39
5	74	4.24

Luminous flux luminaire
1035 lm

Spot Module QR-CBC 51

Light Source: LED QR-CBC 51 GX5.3

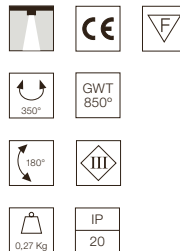
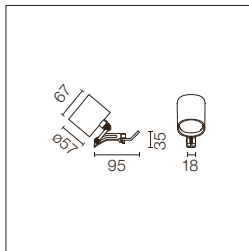

Proiettore per l'installazione nella struttura Light Cut Mini. Trasformatore elettronico remoto non incluso.

Spotlight to be installed on Light Cut Mini system. Electronic transformer remote not included.

09.0203.30
09.0203.14

LIGHT CUT MINI

Accessori / Accessories

Spot module: Power LED / QR-CBC 51

Accessorio di schermatura.
Screening cylinder.



08.8380.30
08.8380.14

Portafiltri realizzati in alluminio
iniettato.



08.8363.30
08.8363.14

Filter-holder made from injected
aluminium.

Honeycomb
Honeycomb



08.8182.14

Filtro blu
Blue filter



08.8230.64.OD

Filtro azzurro
Sky blue filter



08.8230.65.OD

Filtro ambra
Amber filter



08.8230.66.OD

Filtro rosso
Red filter



08.8230.67.OD

Filtro anti U.V.
U.V. filter



08.8230.98.OD

Hot light
Hot light



08.8230.69

Cold light
Cold light



08.8230.CL

Daylight
Daylight



08.8230.DL

Neodimium
Neodimium



08.8230.ND

Spot module: LED Array 14,4W

Honeycomb
Honeycomb



08.8502.14

Filtro blu
Blue filter



08.8501.64.OD

Filtro azzurro
Sky blue filter



08.8501.65.OD

Filtro ambra
Amber filter



08.8501.66.OD

Filtro rosso
Red filter



08.8501.67.OD

Hot light
Hot light



08.8501.69

Cold light
Cold light



08.8501.CL

Daylight
Daylight



08.8501.DL

Neodimium
Neodimium



08.8501.ND

Spot module: LED Array 18W

Honeycomb
Honeycomb



08.3309.14

Lente ellittica
Elliptical lens



08.8627.68

Lente flood
Flood lens



08.3310.19

MOONLINE

DESIGNED BY FRANK SINNAEVE AND STEPHAN GUNST

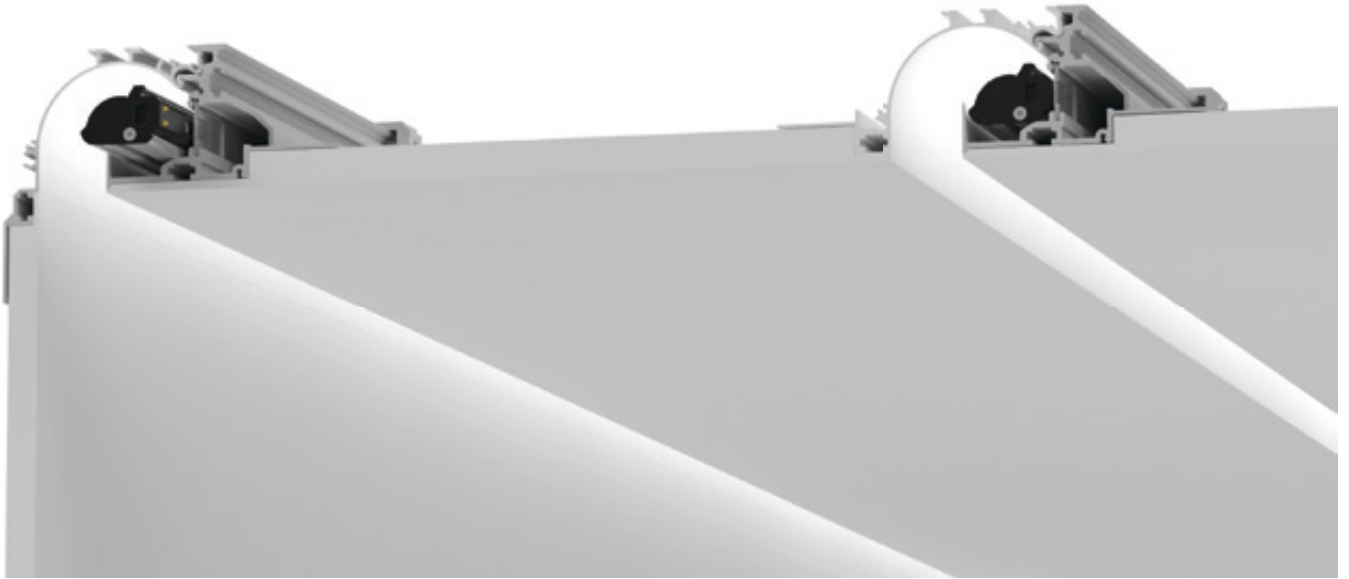

LIGHT STRIPE
125 mm



LIGHT SOURCE
TOP LED
2W
254 lm
3000K/CRI 80

LIGHT STRIPE
500 mm



LIGHT SOURCE
TOP LED
8W
1025 lm
3000K/CRI 80

40 Bianco
40 White



Descrizione

Apparecchio di illuminazione per interni da incassare in pareti/soffitti di cartongesso. Elegante integrazione negli spazi.

Moonline è composto da profili di alluminio estruso con finitura anodizzata naturale su cui si posizionano, mediante un sistema di fissaggio magnetico, moduli di illuminazione con sorgenti luminose LED di ultima generazione.

Grazie al sistema di fissaggio magnetico, i moduli di illuminazione possono essere installati e riposizionati facilmente, senza necessità di attrezzi specifici.

I moduli di illuminazione sono disponibili in 500 mm e 150 mm di lunghezza con diffusore PMMA opalino che garantisce un'illuminazione uniforme.

Unità di Alimentazione

Il prodotto viene fornito precablato per essere collegato a un alimentatore remoto da 24V/240W non compreso.

Accessori

Accessorio per facilitare l'estrazione dei moduli Light Stripe.

Informazioni Aggiuntive

Installabile esclusivamente su superfici di cartongesso di 12,5mm di spessore.

Moonline è un sistema elettrico alimentato a 24V e con una corrente massima di 10A.

Per evitare problemi di sovraccarico, si consiglia di installare un alimentatore indipendente da 240W ogni 12 m di installazione.

Grado di protezione IP20.

Adatto ad installazioni su superfici normalmente infiammabili.

Conformità e Marchi di Qualità

Apparecchio conforme alla Normativa Tecnica Europea EN60598-1 e relative parti seconde.

Description

Recessed luminaire for indoor use, mounted on plasterboard ceiling/wall. Elegant integration with spaces. Moonline is comprised of extruded aluminium profiles with natural anodised finish. It has a magnetic fixture system that houses the lighting modules, with latest generation LED light sources.

Due to this magnetic fixture system, the light modules can be easily installed and repositioned, without the need for specific tools.

The lighting modules are available in lengths of 500 mm and 150 mm with opal PMMA diffuser that guarantees uniform lighting.

Power Supply

The product is supplied pre-wired to be connected to a 24V/240W remote power supply source not included.

Accessories

Accessory to remove the Light Stripe modules much easier.

Additional Information

Can only be installed in 12.5 mm thick plaster-board.

Moonline is an electric system supplied at 24V and limited to a maximum current of 10A.

To avoid overload problems, the installation of an independent 240W power supply source is recommended for every 12 m installed.

IP20 protection grade.

Suitable for installation on normally inflammable surfaces.

Compliance of Standards and Quality Marks

EN60598-1 European Technical Standards and any subsequent additions.



Light Stripe



Profiles

MOONLINE – PROFILES

Profili

Profilo in alluminio estruso da incassare a soffitti/pareti di cartongesso. Comprende pista magnetica per l'installazione diretta dei moduli di illuminazione LED.

Profiles

Profile made of extruded aluminium to recess into plasterboard walls/ceilings. It includes magnetic track to directly install LED lighting modules.

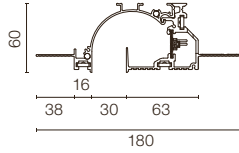
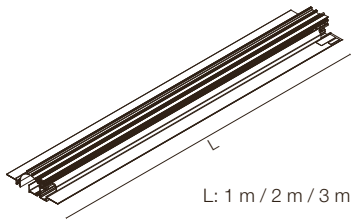

- L: 1000 mm 06.1100.40
- L: 2000 mm 06.1105.40
- L: 3000 mm 06.1110.40

Angolo verticale.

Vertical corner.

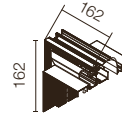

- 06.1133.40

Angolo orizzontale.

Horizontal corner.

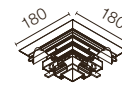

- 06.1134.40

Angolo esterno.

Outer corner.



- 06.1135.40

Profili Perimetrali

Profilo perimetrale in alluminio estruso da incassare a soffitti/pareti di cartongesso. Comprende pista magnetica per l'installazione diretta dei moduli di illuminazione LED.

Perimeter Profile

Perimeter profile made of extruded aluminium to recess into plasterboard walls/ceilings. It includes magnetic track to directly install LED lighting modules.

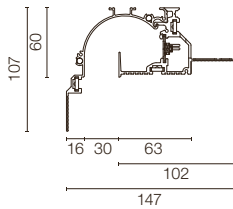
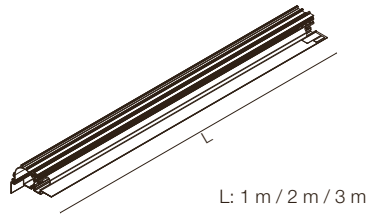

- L: 1000 mm 06.1115.40
- L: 2000 mm 06.1120.40
- L: 3000 mm 06.1125.40

Angolo perimetrale verticale.

Vertical perimeter corner.

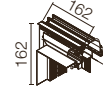

- 06.1130.40

Angolo interno perimetrale.

Inner perimeter corner.



- 06.1131.40

Angolo esterno perimetrale.

Outer perimeter corner.

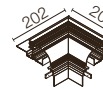

- 06.1132.40

Coperchio metallico per i profili. Kit da 2 unità.

Metal cover for profiles. 2 unit kit.



- 08.8914.40

Cavo di alimentazione. 1 m.

Connection cable. 1 m.



- 06.1140.00

MOONLINE – LIGHT MODULE

Light Stripe 125 / 500 mm

Light Source: Top LED 16W/m - 2050 lm/m - 3000K/CRI 80

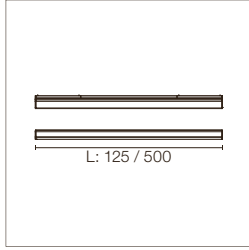

Modulo di illuminazione LED a luce diffusa da installare nel sistema Moonline.

LED lighting module for scattered light, to be installed in Moonline system.

L: 125 mm
2W - 254 lm
06.1141.00B

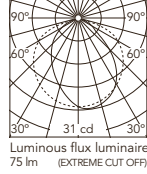

Beam Angle: 82°

h(m)	E(lx)	D(m)
1	31	1.75
2	8	3.50
3	3	5.25
4	2	7.01
5	1	8.76

L: 500 mm
8W - 1025 lm
06.1142.00B

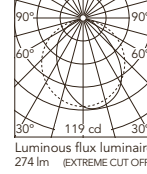

Beam Angle: 81°

h(m)	E(lx)	D(m)
1	119	1.72
2	30	3.44
3	13	5.16
4	7	6.88
5	5	8.60

Accessori / Accessories

Accessorio per facilitare l'estrazione dei moduli Light Stripe.

Accessory to remove the Light Stripe modules much easier.



08.8915.00

Driver / Drivers

Alimentatore LED per installazione remota in quadro elettrico 24V/240W. Per evitare problemi di sovraccarico si consiglia di installare un alimentatore indipendente di 240W ogni 12 m di installazione.

LED power supply source for remote installation in 24V/240W electric control panel. To avoid overload problems, the installation of an independent 240W power supply source is recommended for every 12 m installed.

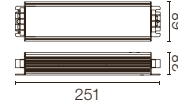

60.8268

HIGH COMFORT

Oblique, Light Shadow, Light Shadow
Pro&Dots, Circle of Light, LED Curtain.

**LIGHT SOURCE**

TOP LED
8W
750 lm
2700K/CRI 90
800 lm
3000K/CRI 90
850 lm
4000K/CRI 90

DY Bianco Opaco
DY Matt White
 AH Grigio Lucido
AH Gloss Grey
 DX Ruggine Opaco
DX Matt Rust
 DW Marrone Opaco
DW Matt Brown
 DR Antracite Opaco
DR Matt Anthracite
 DV Salvia Lucida
DV Gloss Salvia

**Descrizione**

Apparecchio di illuminazione da tavolo a luce diretta, con supporto. Corpo in alluminio pressofuso. Testa in alluminio pressofuso con lente asimmetrica full cut-off integrata in metacrilato stampato ad iniezione. Sorgenti LED totalmente nascoste alla vista per il massimo comfort visivo senza ausilio di diaframmi o accessori anti-abbagliamento che limitino le performance del corpo lampada. Lo speciale gruppo ottico brevettato oltrepassa gli standard di illuminazione consueti per applicazioni in ambiti di lavoro e studio fornendo valori di illuminamento del piano di lavoro superiori a 1000 lux con un'levata protezione dall'abbagliamento e riduzione al minimo del flickering.

La base della lampada è equipaggiata in tutte le versioni con una presa USB-C per la ricarica di dispositivi compatibili.

Le versioni Qi presentano una copertura esterna polimerica della base che consente la ricarica supplementare di dispositivi mobili in modalità wireless. Struttura ottenuta da un tubolare in lega di alluminio estruso lavorato meccanicamente.

L'interruttore dimmer-ON/OFF è integrato nella base e dispone di un temporizzatore.

Unità di Alimentazione

Trasformatore elettronico 100-240V - 50/60Hz.

Informazioni Aggiuntive

Grado di protezione IP20.
Classe di isolamento III.

Conformità e Marchi di Qualità

Apparecchio conforme alla Normativa Tecnica Europea EN60598-1 e relative parti seconde.

Description

Table lamp with direct light and support. Body in die-cast aluminium. Head in die-cast aluminium with integrated full cut-off asymmetric lens in injection moulded methacrylate. LED source completely hidden from view for the best visual comfort without diaphragms or anti-glare accessories that would limit the performance of the lamp. The special patented optics group exceeds regular lighting standards for application in work and study environments, producing lighting values on the work surface greater than 1000 lux with high glare protection and minimum flickering.

All lamp base versions are equipped with a USB-C connection to recharge compatible devices.

The Qi versions have an external polymer covering on the base that allows for supplementary charging of mobile devices via wireless. Structure made of an extruded tubular aluminium alloy produced mechanically.

The ON/OFF-dimmer switch is integrated into the base and features a timer.

Power Supply

100-240 V - 50/60 Hz electronic transformer.

Additional Information

IP20 protection grade.
Insulation class III.

Standard Compliance and Quality Marks

EN60598-1 European Technical Standards and any subsequent additions.

OBLIQUE

Oblique

Light Source: Top LED 8W - 24V - 750 lm - 2700K/CRI 90 / 8W - 24V - 800 lm - 3000K/CRI 90 / 8W - 24V - 850 lm - 4000K/CRI 90

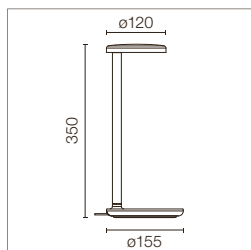

Lampada da tavolo professionale con ottica asimmetrica brevettata. Alimentazione esterna inclusa equipaggiata con cavo di 1500mm. Presa USB-C integrata nella base dell'apparecchio predisposta per la ricarica di dispositivi compatibili.

Professional table lamp with patented asymmetric optics. External power supply included with 1500-mm cable. USB-C connection integrated into the base of the device to recharge compatible devices.

2700K

- 09.8300.DY
- 09.8300.AH
- 09.8300.DX
- 09.8300.DW
- 09.8300.DR
- 09.8300.DV

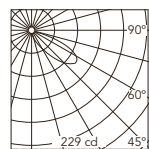

Luminous flux luminaire
479 lm

Beam Angle: 35°

h(m)	E(lx)	D(m)
1	229	2.18
2	57	4.36
3	25	6.54
4	14	8.72
5	9	10.90

4000K

- 09.8302.DY
- 09.8302.AH
- 09.8302.DX
- 09.8302.DW
- 09.8302.DR
- 09.8302.DV

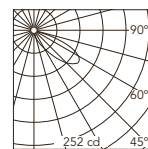

Luminous flux luminaire
525 lm

Beam Angle: 35°

h(m)	E(lx)	D(m)
1	252	2.18
2	63	4.36
3	28	6.54
4	16	8.72
5	10	10.90

3000K

- 09.8301.DY
- 09.8301.AH
- 09.8301.DX
- 09.8301.DW
- 09.8301.DR
- 09.8301.DV

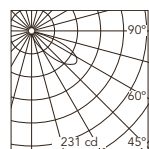

Luminous flux luminaire
482 lm

Beam Angle: 35°

h(m)	E(lx)	D(m)
1	231	2.18
2	58	4.36
3	26	6.54
4	14	8.72
5	9	10.90

Oblique Qi

Light Source: Top LED 8W - 48V - 750 lm - 2700K/CRI 90 / 8W - 48V - 800 lm - 3000K/CRI 90 / 8W - 48V - 850 lm - 4000K/CRI 90

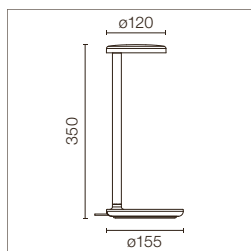

Lampada da tavolo professionale con ottica asimmetrica brevettata. Alimentazione esterna inclusa equipaggiata con cavo di 1500mm. Presa USB-C integrata nella base dell'apparecchio predisposta per la ricarica di dispositivi compatibili. Base con sistema di ricarica wireless compatibile con Qi predisposta per dispositivi mobili e custodie di ricarica wireless per dispositivi compatibili.

Professional table lamp with patented asymmetric optics. External power supply included with 1500-mm cable. USB-C connection integrated into the base of the device to recharge compatible devices. Base with Qi compatible wireless recharging system for mobile devices and wireless recharging cases for compatible devices.

2700K

- 09.8310.DY
- 09.8310.AH
- 09.8310.DX
- 09.8310.DW
- 09.8310.DR
- 09.8310.DV

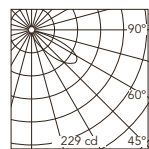

Luminous flux luminaire
479 lm

Beam Angle: 35°

h(m)	E(lx)	D(m)
1	229	2.18
2	57	4.36
3	25	6.54
4	14	8.72
5	9	10.90

4000K

- 09.8312.DY
- 09.8312.AH
- 09.8312.DX
- 09.8312.DW
- 09.8312.DR
- 09.8312.DV

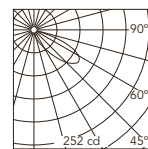

Luminous flux luminaire
525 lm

Beam Angle: 35°

h(m)	E(lx)	D(m)
1	252	2.18
2	63	4.36
3	28	6.54
4	16	8.72
5	10	10.90

3000K

- 09.8311.DY
- 09.8311.AH
- 09.8311.DX
- 09.8311.DW
- 09.8311.DR
- 09.8311.DV

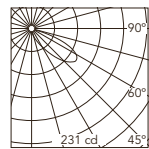

Luminous flux luminaire
482 lm

Beam Angle: 35°

h(m)	E(lx)	D(m)
1	231	2.18
2	58	4.36
3	26	6.54
4	14	8.72
5	9	10.90

FIXED TRIM / NO TRIM 2 SPOTS



ADJUSTABLE TRIM / NO TRIM 2 SPOTS



FIXED TRIM / NO TRIM 4 SPOTS



ADJUSTABLE TRIM / NO TRIM 4 SPOTS



FIXED TRIM / NO TRIM 8 SPOTS



ADJUSTABLE TRIM / NO TRIM 8 SPOTS



FIXED TRIM / NO TRIM 12 SPOTS

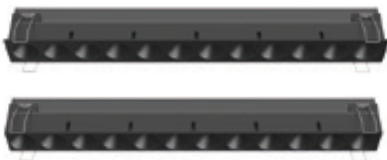

ADJUSTABLE TRIM / NO TRIM 12 SPOTS



WALL-WASHER TRIM / NO TRIM 4 SPOTS



SURFACE 4 SPOTS



LIGHT SHADOW

*compatible module for
The Running Magnet



LIGHT SHADOW
W - W

*compatible module for
The Running Magnet



*Verificare moduli compatibili per la collezione The Running Magnet / See compatible modules for The Running Magnet collection

LIGHT SOURCE
POWER LED
2,7W x Spot
270 lm x Spot
2700K/CRI 90
285 lm x Spot
3000K/CRI 90

LIGHT SHADOW

Light Shadow Fixed / Adjustable / Wall-Washer

Esterno / Outside

40 Bianco
40 White

14 Nero
14 Black

Light Shadow Surface

Esterno / Outside

Interno / Inside



Bianco
White

Cromo
Chrome

Oro Satinato
Matt Gold

Descrizione

Apparecchio di illuminazione per interni, a incasso e a superficie. Grazie alle sue principali caratteristiche (dimensioni ridotte, resa e grande schermatura) si riescono a integrare totalmente negli spazi con grande facilità. La famiglia nasce dalla necessità di un apparecchio di illuminazione compatto e di facile installazione, con lo stile distintivo di Flos, in grado di produrre un'illuminazione ad alta efficienza e rispettando al contempo i più elevati standard di comfort visivo, in versioni con corpi di schermatura neri.

- Versioni a incasso fisse e regolabili: 2/4/8/12 spot (Trim/No Trim).

- Versione fissa a superficie: 4 spots.

- Versione wall-washer: 4 spots (Trim / No Trim).

La famiglia viene offerta con ottiche di super accento, accento e illuminazione generale.

Per trovare soluzioni in ambienti più decorativi, è stata sviluppata la seguente gamma di colori con combinazioni di finiture dipinte interne ed esterne:

- finiture esterne: bianco e nero.

- finiture interne: bianco, oro opaco, cromo e nero (elevato comfort ottico).

- box esterno della versione di superficie: bianco e nero.

Unità di Alimentazione

Attrezzatura remota compresa.

Disponibile in versione DALI regolabile.

Disponibili versioni a 110V su ordinazione.

Accessori

Per la versione No Trim, è necessaria una cornice in alluminio per la preinstallazione nel controsoffitto. Da ordinare separatamente (non necessario per la versione Trim).

Informazioni Aggiuntive

La versione No Trim è stata progettata per installazione su pannelli di cartongesso di spessore 12,5 mm.

Grado di protezione IP20, IP23, IP44, IP55 a seconda delle versioni.

Classe di isolamento II.

Adatti ad installazioni su superfici normalmente infiammabili.

Conformità e Marchi di Qualità

Apparecchio conforme alla Normativa Tecnica Europea EN60598-1 e relative parti seconde.

Description

Indoor, embedded and surface luminaires.

Due to their main qualities (reduced size, high performance and great screening), they facilitate total integration into spaces.

The family was born of the need for a compact, easy-to-install luminaire, with the distinctive Flos style, able to produce high efficiency lighting, while respecting the highest standards of visual comfort, in versions with black screening bodies.

- Fixed and adjustable embedded versions: 2/4/8/12 spots (Trim/No Trim).

- Fixed surface version: 4 spots.

- Wall-washer version: 4 spots (Trim / No Trim).

The family is offered with super accented, accented and general lighting optics.

For solutions in more decorative settings, the following range of colours has been developed, with a combination of interior and exterior painted finishes:

- exterior finishes: black and white.

- interior finishes: white, matte gold, chrome and black (high comfort optics).

- outdoor box surface version: black and white.

Power Supply

Remote equipment included.

DALI Dimmable version available.

Versions with 110V equipment available upon request.

Accessories

For the No Trim version, pre-installation frame in aluminium for false ceiling installation. It needs to be ordered separately (not necessary for Trim version).

Additional Information

No Trim version has been designed for 12.5 mm thick plasterboard installation.

IP20, IP23, IP44, IP55 protection grade depending on the versions.

Insulation class II.

Suitable for installation on normally inflammable surfaces.

Standard Compliance and Quality Marks

EN60598-1 European Technical Standards and any subsequent additions.



Trim



No Trim



Surface



Continuous Line

LIGHT SHADOW

Light Shadow Fixed Trim 2 Spots

Light Source: Power LED 5,4W - 540 lm - 2700K/CRI 90 / 5,4W - 570 lm - 3000K/CRI 90

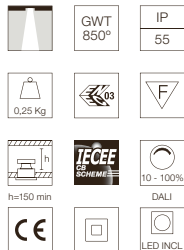
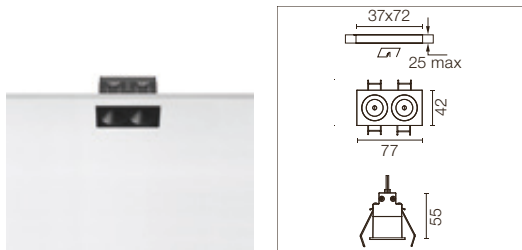

Apparecchio per illuminazione da incasso con 2 spot LED. Alimentazione remota inclusa (220-240V). Non richiede cornice di pre-installazione.

Recessed integrated luminaire with 2 LED lighting spots. Remote power supply included (220-240V). Pre-installation frame not required.

E= Finitura Esterna
I= Finitura Interna

E= External Finish
I= Internal Finish

Optic Spot 2700K

E I	03.8821.40A
E I	03.8821.14A
E I	Dali Version
E I	03.8821.40ADA
E I	03.8821.14ADA

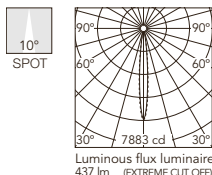

Optic Spot 3000K

E I	03.8825.40A
E I	03.8825.14A
E I	Dali Version
E I	03.8825.40ADA
E I	03.8825.14ADA

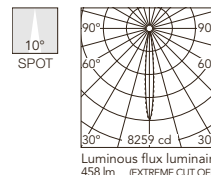

Optic Spot 2700K

E I	03.8820.40A
E I	03.8820.14A
E I	Dali Version
E I	03.8820.40ADA
E I	03.8820.14ADA

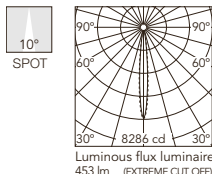

Optic Spot 3000K

E I	03.8824.40A
E I	03.8824.14A
E I	Dali Version
E I	03.8824.40ADA
E I	03.8824.14ADA

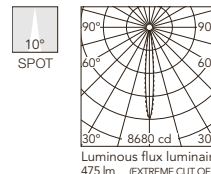

Optic Spot 2700K

E I	03.8822.40A
E I	03.8822.14A
E I	Dali Version
E I	03.8822.40ADA
E I	03.8822.14ADA

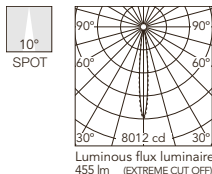

Optic Spot 3000K

E I	03.8826.40A
E I	03.8826.14A
E I	Dali Version
E I	03.8826.40ADA
E I	03.8826.14ADA

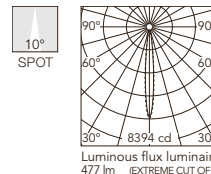

Optic Spot 2700K

E I	03.8823.40A
E I	03.8823.14A
E I	Dali Version
E I	03.8823.40ADA
E I	03.8823.14ADA

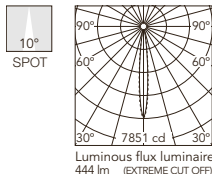

Optic Spot 3000K

E I	03.8827.40A
E I	03.8827.14A
E I	Dali Version
E I	03.8827.40ADA
E I	03.8827.14ADA

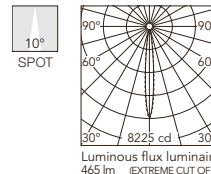

Optic Medium 2700K

E I	03.9101.40A
E I	03.9101.14A
E I	Dali Version
E I	03.9101.40ADA
E I	03.9101.14ADA

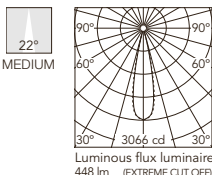

Optic Medium 3000K

E I	03.9111.40A
E I	03.9111.14A
E I	Dali Version
E I	03.9111.40ADA
E I	03.9111.14ADA

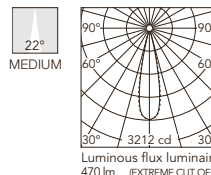

Optic Medium 2700K

E I	03.9100.40A
E I	03.9100.14A
E I	Dali Version
E I	03.9100.40ADA
E I	03.9100.14ADA

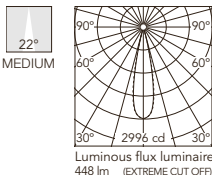

Optic Medium 3000K

E I	03.9110.40A
E I	03.9110.14A
E I	Dali Version
E I	03.9110.40ADA
E I	03.9110.14ADA

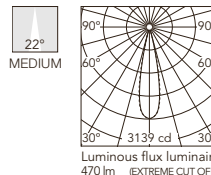

Optic Medium 2700K

E I	03.9102.40A
E I	03.9102.14A
E I	Dali Version
E I	03.9102.40ADA
E I	03.9102.14ADA

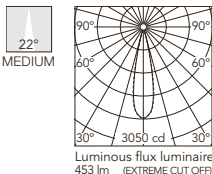

Optic Medium 3000K

E I	03.9112.40A
E I	03.9112.14A
E I	Dali Version
E I	03.9112.40ADA
E I	03.9112.14ADA

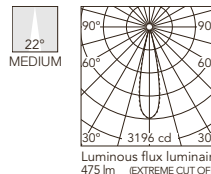

Optic Medium 2700K

E I	03.9103.40A
E I	03.9103.14A
E I	Dali Version
E I	03.9103.40ADA
E I	03.9103.14ADA

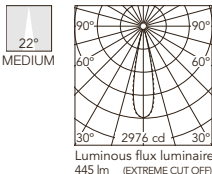

Optic Medium 3000K

E I	03.9113.40A
E I	03.9113.14A
E I	Dali Version
E I	03.9113.40ADA
E I	03.9113.14ADA

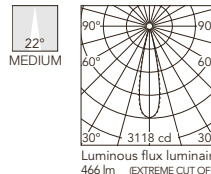

LIGHT SHADOW

Optic Flood

- 2700K**
- E I 03.9106.40A
 - E I 03.9106.14A
 - E I Dali Version
 - 03.9106.40ADA
 - 03.9106.14ADA

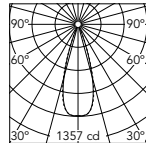

Beam Angle: 33°

h(m)	E(ft)	D(m)
1	1357	0.60
2	339	1.19
3	151	1.79
4	85	2.39
5	54	2.99

Luminous flux luminaire
434 lm (EXTREME CUT OFF)

Optic Flood

- 3000K**
- E I 03.9116.40A
 - E I 03.9116.14A
 - E I Dali Version
 - 03.9116.40ADA
 - 03.9116.14ADA

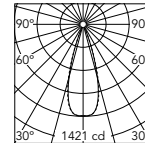

Beam Angle: 33°

h(m)	E(ft)	D(m)
1	1421	0.60
2	355	1.19
3	158	1.79
4	89	2.39
5	57	2.99

Luminous flux luminaire
455 lm (EXTREME CUT OFF)

- 2700K**
- E I 03.9105.40A
 - E I 03.9105.14A
 - E I Dali Version
 - 03.9105.40ADA
 - 03.9105.14ADA

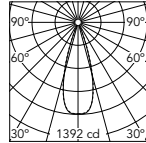

Beam Angle: 33°

h(m)	E(ft)	D(m)
1	1392	0.59
2	348	1.18
3	155	1.78
4	87	2.37
5	56	2.96

Luminous flux luminaire
447 lm (EXTREME CUT OFF)

- 3000K**
- E I 03.9115.40A
 - E I 03.9115.14A
 - E I Dali Version
 - 03.9115.40ADA
 - 03.9115.14ADA

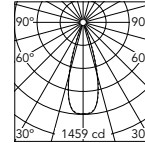

Beam Angle: 33°

h(m)	E(ft)	D(m)
1	1459	0.59
2	365	1.18
3	162	1.78
4	91	2.37
5	58	2.96

Luminous flux luminaire
468 lm (EXTREME CUT OFF)

- 2700K**
- E I 03.9107.40A
 - E I 03.9107.14A
 - E I Dali Version
 - 03.9107.40ADA
 - 03.9107.14ADA

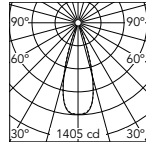

Beam Angle: 33°

h(m)	E(ft)	D(m)
1	1405	0.60
2	351	1.19
3	156	1.79
4	88	2.38
5	56	2.98

Luminous flux luminaire
454 lm (EXTREME CUT OFF)

- 3000K**
- E I 03.9117.40A
 - E I 03.9117.14A
 - E I Dali Version
 - 03.9117.40ADA
 - 03.9117.14ADA

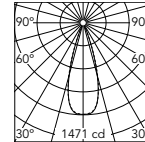

Beam Angle: 33°

h(m)	E(ft)	D(m)
1	1471	0.60
2	368	1.19
3	163	1.79
4	92	2.38
5	59	2.98

Luminous flux luminaire
475 lm (EXTREME CUT OFF)

- 2700K**
- E I 03.9108.40A
 - E I 03.9108.14A
 - E I Dali Version
 - 03.9108.40ADA
 - 03.9108.14ADA

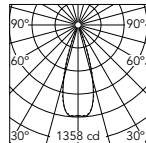

Beam Angle: 33°

h(m)	E(ft)	D(m)
1	1358	0.60
2	340	1.20
3	151	1.79
4	85	2.39
5	54	2.99

Luminous flux luminaire
441 lm (EXTREME CUT OFF)

- 3000K**
- E I 03.9118.40A
 - E I 03.9118.14A
 - E I Dali Version
 - 03.9118.40ADA
 - 03.9118.14ADA

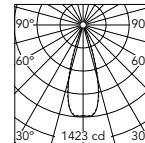

Beam Angle: 33°

h(m)	E(ft)	D(m)
1	1423	0.60
2	356	1.20
3	158	1.79
4	89	2.39
5	57	2.99

Luminous flux luminaire
462 lm (EXTREME CUT OFF)

Optic Wide Flood

- 2700K**
- E I 03.8301.40A
 - E I 03.8301.14A
 - E I Dali Version
 - 03.8301.40ADA
 - 03.8301.14ADA

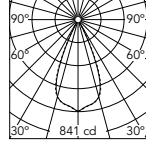

Beam Angle: 46°

h(m)	E(ft)	D(m)
1	841	0.84
2	210	1.69
3	93	2.53
4	53	3.38
5	34	4.22

Luminous flux luminaire
443 lm (EXTREME CUT OFF)

Optic Wide Flood

- 3000K**
- E I 03.8305.40A
 - E I 03.8305.14A
 - E I Dali Version
 - 03.8305.40ADA
 - 03.8305.14ADA

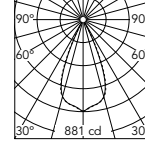

Beam Angle: 46°

h(m)	E(ft)	D(m)
1	881	0.84
2	220	1.69
3	98	2.53
4	55	3.38
5	35	4.22

Luminous flux luminaire
464 lm (EXTREME CUT OFF)

- 2700K**
- E I 03.8300.40A
 - E I 03.8300.14A
 - E I Dali Version
 - 03.8300.40ADA
 - 03.8300.14ADA

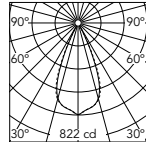

Beam Angle: 45°

h(m)	E(ft)	D(m)
1	822	0.83
2	205	1.67
3	91	2.50
4	51	3.34
5	33	4.17

Luminous flux luminaire
441 lm (EXTREME CUT OFF)

- 3000K**
- E I 03.8304.40A
 - E I 03.8304.14A
 - E I Dali Version
 - 03.8304.40ADA
 - 03.8304.14ADA

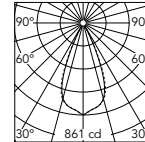

Beam Angle: 45°

h(m)	E(ft)	D(m)
1	861	0.83
2	215	1.67
3	96	2.50
4	54	3.34
5	34	4.17

Luminous flux luminaire
462 lm (EXTREME CUT OFF)

- 2700K**
- E I 03.8302.40A
 - E I 03.8302.14A
 - E I Dali Version
 - 03.8302.40ADA
 - 03.8302.14ADA

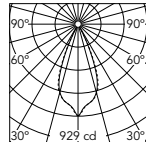

Beam Angle: 44°

h(m)	E(ft)	D(m)
1	929	0.80
2	232	1.60
3	103	2.40
4	58	3.19
5	37	3.99

Luminous flux luminaire
446 lm (EXTREME CUT OFF)

- 3000K**
- E I 03.8306.40A
 - E I 03.8306.14A
 - E I Dali Version
 - 03.8306.40ADA
 - 03.8306.14ADA

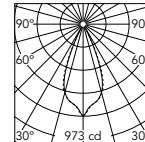

Beam Angle: 44°

h(m)	E(ft)	D(m)
1	973	0.80
2	243	1.60
3	108	2.40
4	61	3.19
5	39	3.99

Luminous flux luminaire
467 lm (EXTREME CUT OFF)

- 2700K**
- E I 03.8303.40A
 - E I 03.8303.14A
 - E I Dali Version
 - 03.8303.40ADA
 - 03.8303.14ADA

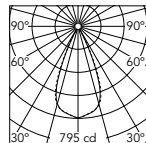

Beam Angle: 46°

h(m)	E(ft)	D(m)
1	795	0.84
2	199	1.69
3	88	2.53
4	50	3.38
5	32	4.22

Luminous flux luminaire
432 lm (EXTREME CUT OFF)

- 3000K**
- E I 03.8307.40A
 - E I 03.8307.14A
 - E I Dali Version
 - 03.8307.40ADA
 - 03.8307.14ADA

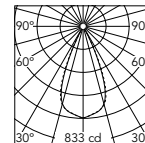

Beam Angle: 46°

h(m)	E(ft)	D(m)
1	833	0.84
2	208	1.69
3	93	2.53
4	52	3.38
5	33	4.22

Luminous flux luminaire
452 lm (EXTREME CUT OFF)

LIGHT SHADOW

Light Shadow Fixed Trim 4 Spots

Light Source: Power LED 10,8W - 1080 lm - 2700K/CRI 90 / 10,8W - 1140lm - 3000K/CRI 90

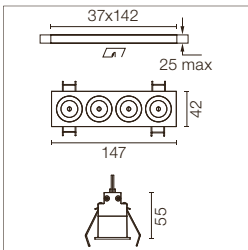

Apparecchio per illuminazione da incasso con 4 spot LED. Alimentazione remota inclusa (220-240V). Non richiede cornice di pre-installazione.

Recessed integrated luminaire with 4 LED lighting spots. Remote power supply included (220-240V). Pre-installation frame not required.

E= Finitura Esterna
I= Finitura Interna

E= External Finish
I= Internal Finish

- Optic Spot 2700K**
- E I 03.8829.40A
 - 03.8829.14A
 - E I Dali Version
 - 03.8829.40ADA
 - 03.8829.14ADA

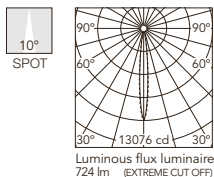

- Optic Spot 3000K**
- E I 03.8833.40A
 - 03.8833.14A
 - E I Dali Version
 - 03.8833.40ADA
 - 03.8833.14ADA

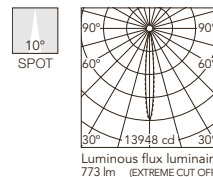

- Optic Spot 2700K**
- E I 03.8828.40A
 - 03.8828.14A
 - E I Dali Version
 - 03.8828.40ADA
 - 03.8828.14ADA

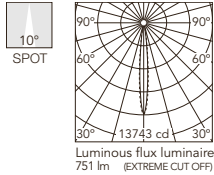

- Optic Spot 3000K**
- E I 03.8832.40A
 - 03.8832.14A
 - E I Dali Version
 - 03.8832.40ADA
 - 03.8832.14ADA

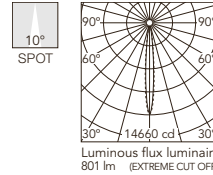

- Optic Spot 2700K**
- E I 03.8830.40A
 - 03.8830.14A
 - E I Dali Version
 - 03.8830.40ADA
 - 03.8830.14ADA

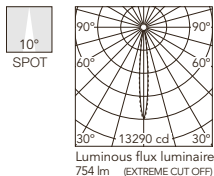

- Optic Spot 3000K**
- E I 03.8834.40A
 - 03.8834.14A
 - E I Dali Version
 - 03.8834.40ADA
 - 03.8834.14ADA

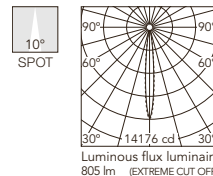

- Optic Spot 2700K**
- E I 03.8831.40A
 - 03.8831.14A
 - E I Dali Version
 - 03.8831.40ADA
 - 03.8831.14ADA

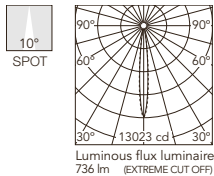

- Optic Spot 3000K**
- E I 03.8835.40A
 - 03.8835.14A
 - E I Dali Version
 - 03.8835.40ADA
 - 03.8835.14ADA

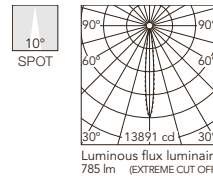

- Optic Medium 2700K**
- E I 03.9121.40A
 - 03.9121.14A
 - E I Dali Version
 - 03.9121.40ADA
 - 03.9121.14ADA

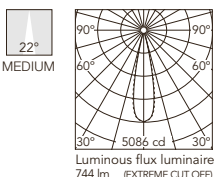

- Optic Medium 3000K**
- E I 03.9131.40A
 - 03.9131.14A
 - E I Dali Version
 - 03.9131.40ADA
 - 03.9131.14ADA

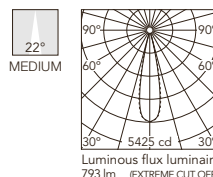

- Optic Medium 2700K**
- E I 03.9120.40A
 - 03.9120.14A
 - E I Dali Version
 - 03.9120.40ADA
 - 03.9120.14ADA

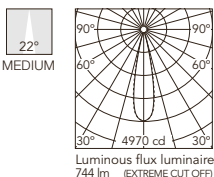

- Optic Medium 3000K**
- E I 03.9130.40A
 - 03.9130.14A
 - E I Dali Version
 - 03.9130.40ADA
 - 03.9130.14ADA

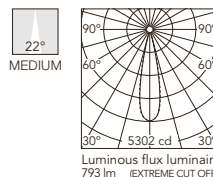

- Optic Medium 2700K**
- E I 03.9122.40A
 - 03.9122.14A
 - E I Dali Version
 - 03.9122.40ADA
 - 03.9122.14ADA

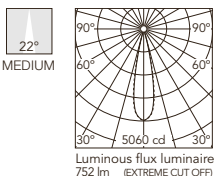

- Optic Medium 3000K**
- E I 03.9132.40A
 - 03.9132.14A
 - E I Dali Version
 - 03.9132.40ADA
 - 03.9132.14ADA

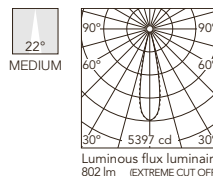

- Optic Medium 2700K**
- E I 03.9123.40A
 - 03.9123.14A
 - E I Dali Version
 - 03.9123.40ADA
 - 03.9123.14ADA

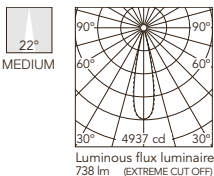

- Optic Medium 3000K**
- E I 03.9133.40A
 - 03.9133.14A
 - E I Dali Version
 - 03.9133.40ADA
 - 03.9133.14ADA

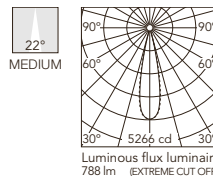

LIGHT SHADOW

Optic Flood

- 2700K**
- E I 03.9126.40A
 - E I 03.9126.14A
 - E I Dali Version
 - 03.9126.40ADA
 - 03.9126.14ADA

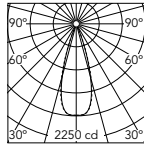

Beam Angle: 33°

h(m)	E(lx)	D(m)
1	2250	0.60
2	563	1.19
3	250	1.79
4	141	2.39
5	90	2.99

Luminous flux luminaire
720 lm (EXTREME CUT OFF)

Optic Flood

- 3000K**
- E I 03.9136.40A
 - E I 03.9136.14A
 - E I Dali Version
 - 03.9136.40ADA
 - 03.9136.14ADA

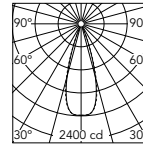

Beam Angle: 33°

h(m)	E(lx)	D(m)
1	2400	0.60
2	600	1.19
3	267	1.79
4	150	2.39
5	96	2.99

Luminous flux luminaire
768 lm (EXTREME CUT OFF)

- 2700K**
- E I 03.9125.40A
 - E I 03.9125.14A
 - E I Dali Version
 - 03.9125.40ADA
 - 03.9125.14ADA

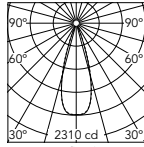

Beam Angle: 33°

h(m)	E(lx)	D(m)
1	2310	0.59
2	577	1.18
3	257	1.78
4	144	2.37
5	92	2.96

Luminous flux luminaire
741 lm (EXTREME CUT OFF)

- 3000K**
- E I 03.9135.40A
 - E I 03.9135.14A
 - E I Dali Version
 - 03.9135.40ADA
 - 03.9135.14ADA

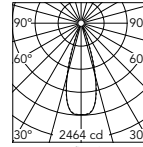

Beam Angle: 33°

h(m)	E(lx)	D(m)
1	2464	0.59
2	616	1.18
3	274	1.78
4	154	2.37
5	99	2.96

Luminous flux luminaire
790 lm (EXTREME CUT OFF)

- 2700K**
- E I 03.9127.40A
 - E I 03.9127.14A
 - E I Dali Version
 - 03.9127.40ADA
 - 03.9127.14ADA

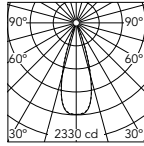

Beam Angle: 33°

h(m)	E(lx)	D(m)
1	2330	0.60
2	582	1.19
3	259	1.79
4	146	2.38
5	93	2.98

Luminous flux luminaire
752 lm (EXTREME CUT OFF)

- 3000K**
- E I 03.9137.40A
 - E I 03.9137.14A
 - E I Dali Version
 - 03.9137.40ADA
 - 03.9137.14ADA

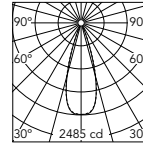

Beam Angle: 33°

h(m)	E(lx)	D(m)
1	2485	0.60
2	621	1.19
3	276	1.79
4	155	2.38
5	99	2.98

Luminous flux luminaire
803 lm (EXTREME CUT OFF)

- 2700K**
- E I 03.9128.40A
 - E I 03.9128.14A
 - E I Dali Version
 - 03.9128.40ADA
 - 03.9128.14ADA

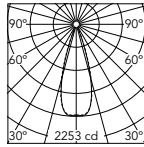

Beam Angle: 33°

h(m)	E(lx)	D(m)
1	2253	0.60
2	563	1.20
3	250	1.79
4	141	2.39
5	90	2.99

Luminous flux luminaire
732 lm (EXTREME CUT OFF)

- 3000K**
- E I 03.9138.40A
 - E I 03.9138.14A
 - E I Dali Version
 - 03.9138.40ADA
 - 03.9138.14ADA

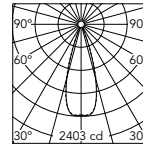

Beam Angle: 33°

h(m)	E(lx)	D(m)
1	2403	0.60
2	601	1.20
3	267	1.79
4	150	2.39
5	96	2.99

Luminous flux luminaire
781 lm (EXTREME CUT OFF)

Optic Wide Flood

- 2700K**
- E I 03.8309.40A
 - E I 03.8309.14A
 - E I Dali Version
 - 03.8309.40ADA
 - 03.8309.14ADA

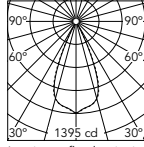

Beam Angle: 46°

h(m)	E(lx)	D(m)
1	1395	0.84
2	349	1.69
3	155	2.53
4	87	3.38
5	56	4.22

Luminous flux luminaire
735 lm (EXTREME CUT OFF)

Optic Wide Flood

- 3000K**
- E I 03.8313.40A
 - E I 03.8313.14A
 - E I Dali Version
 - 03.8313.40ADA
 - 03.8313.14ADA

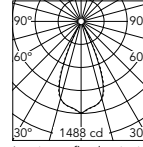

Beam Angle: 46°

h(m)	E(lx)	D(m)
1	1488	0.84
2	372	1.69
3	165	2.53
4	93	3.38
5	60	4.22

Luminous flux luminaire
784 lm (EXTREME CUT OFF)

- 2700K**
- E I 03.8308.40A
 - E I 03.8308.14A
 - E I Dali Version
 - 03.8308.40ADA
 - 03.8308.14ADA

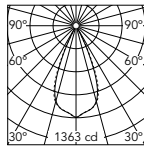

Beam Angle: 45°

h(m)	E(lx)	D(m)
1	1363	0.83
2	341	1.67
3	151	2.50
4	85	3.34
5	55	4.17

Luminous flux luminaire
731 lm (EXTREME CUT OFF)

- 3000K**
- E I 03.8312.40A
 - E I 03.8312.14A
 - E I Dali Version
 - 03.8312.40ADA
 - 03.8312.14ADA

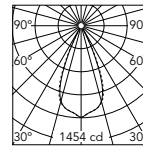

Beam Angle: 45°

h(m)	E(lx)	D(m)
1	1454	0.83
2	363	1.67
3	162	2.50
4	91	3.34
5	58	4.17

Luminous flux luminaire
780 lm (EXTREME CUT OFF)

- 2700K**
- E I 03.8310.40A
 - E I 03.8310.14A
 - E I Dali Version
 - 03.8310.40ADA
 - 03.8310.14ADA

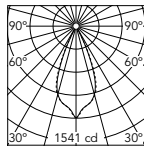

Beam Angle: 44°

h(m)	E(lx)	D(m)
1	1541	0.80
2	385	1.60
3	171	2.40
4	96	3.19
5	62	3.99

Luminous flux luminaire
739 lm (EXTREME CUT OFF)

- 3000K**
- E I 03.8314.40A
 - E I 03.8314.14A
 - E I Dali Version
 - 03.8314.40ADA
 - 03.8314.14ADA

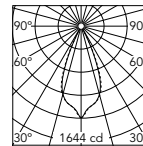

Beam Angle: 44°

h(m)	E(lx)	D(m)
1	1644	0.80
2	411	1.60
3	183	2.40
4	103	3.19
5	66	3.99

Luminous flux luminaire
789 lm (EXTREME CUT OFF)

- 2700K**
- E I 03.8311.40A
 - E I 03.8311.14A
 - E I Dali Version
 - 03.8311.40ADA
 - 03.8311.14ADA

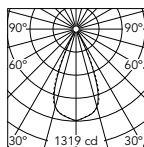

Beam Angle: 46°

h(m)	E(lx)	D(m)
1	1319	0.84
2	330	1.69
3	147	2.53
4	82	3.38
5	53	4.22

Luminous flux luminaire
716 lm (EXTREME CUT OFF)

- 3000K**
- E I 03.8315.40A
 - E I 03.8315.14A
 - E I Dali Version
 - 03.8315.40ADA
 - 03.8315.14ADA

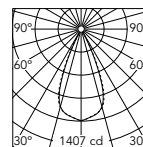

Beam Angle: 46°

h(m)	E(lx)	D(m)
1	1407	0.84
2	352	1.69
3	156	2.53
4	88	3.38
5	56	4.22

Luminous flux luminaire
764 lm (EXTREME CUT OFF)

LIGHT SHADOW

Light Shadow Fixed Trim 8 Spots

Light Source: Power LED 21,6W - 2160 lm - 2700K/CRI 90 / 21,6W - 2280 lm - 3000K/CRI 90

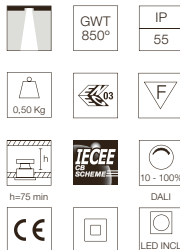
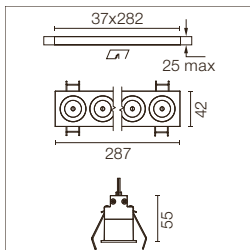

Apparecchio per illuminazione da incasso con 8 spot LED. Alimentazione remota inclusa (220-240V). Non richiede cornice di pre-installazione.

Recessed integrated luminaire with 8 LED lighting spots. Remote power supply included (220-240V). Pre-installation frame not required.

E= Finitura Esterna
I= Finitura Interna

E= External Finish
I= Internal Finish

Optic Spot 2700K

E I	03.8837.40A
E I	03.8837.14A
E I	Dali Version
E I	03.8837.40ADA
E I	03.8837.14ADA

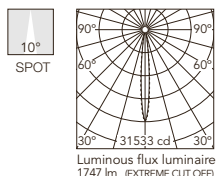

Beam Angle: 10°

h(m)	E(lx)	D(m)
1	31533	0.18
2	7883	0.36
3	3504	0.54
4	1971	0.72
5	1261	0.90

Optic Spot 3000K

E I	03.8841.40A
E I	03.8841.14A
E I	Dali Version
E I	03.8841.40ADA
E I	03.8841.14ADA

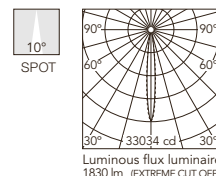

Beam Angle: 10°

h(m)	E(lx)	D(m)
1	33034	0.18
2	8259	0.36
3	3670	0.54
4	2065	0.72
5	1321	0.90

Optic Spot 2700K

E I	03.8836.40A
E I	03.8836.14A
E I	Dali Version
E I	03.8836.40ADA
E I	03.8836.14ADA

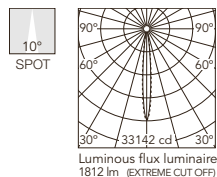

Beam Angle: 10°

h(m)	E(lx)	D(m)
1	33142	0.17
2	8285	0.35
3	3682	0.52
4	2071	0.70
5	1326	0.87

Optic Spot 3000K

E I	03.8840.40A
E I	03.8840.14A
E I	Dali Version
E I	03.8840.40ADA
E I	03.8840.14ADA

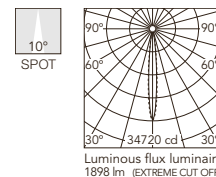

Beam Angle: 10°

h(m)	E(lx)	D(m)
1	34720	0.17
2	8680	0.35
3	3858	0.52
4	2170	0.70
5	1389	0.87

Optic Spot 2700K

E I	03.8838.40A
E I	03.8838.14A
E I	Dali Version
E I	03.8838.40ADA
E I	03.8838.14ADA

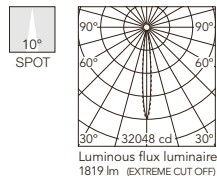

Beam Angle: 10°

h(m)	E(lx)	D(m)
1	32048	0.18
2	8012	0.36
3	3561	0.55
4	2003	0.73
5	1282	0.91

Optic Spot 3000K

E I	03.8842.40A
E I	03.8842.14A
E I	Dali Version
E I	03.8842.40ADA
E I	03.8842.14ADA

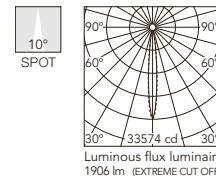

Beam Angle: 10°

h(m)	E(lx)	D(m)
1	33574	0.18
2	8394	0.36
3	3730	0.55
4	2098	0.73
5	1343	0.91

Optic Spot 2700K

E I	03.8839.40A
E I	03.8839.14A
E I	Dali Version
E I	03.8839.40ADA
E I	03.8839.14ADA

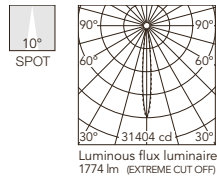

Beam Angle: 10°

h(m)	E(lx)	D(m)
1	31404	0.18
2	7851	0.36
3	3489	0.55
4	1963	0.73
5	1256	0.91

Optic Spot 3000K

E I	03.8843.40A
E I	03.8843.14A
E I	Dali Version
E I	03.8843.40ADA
E I	03.8843.14ADA

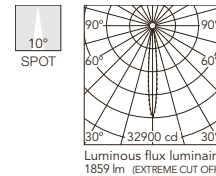

Beam Angle: 10°

h(m)	E(lx)	D(m)
1	32900	0.18
2	8225	0.36
3	3656	0.55
4	2056	0.73
5	1316	0.91

Optic Medium 2700K

E I	03.9141.40A
E I	03.9141.14A
E I	Dali Version
E I	03.9141.40ADA
E I	03.9141.14ADA

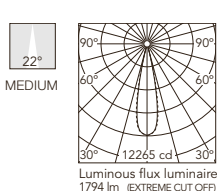

Beam Angle: 22°

h(m)	E(lx)	D(m)
1	12265	0.39
2	3066	0.78
3	1363	1.17
4	767	1.56
5	491	1.95

Optic Medium 3000K

E I	03.9151.40A
E I	03.9151.14A
E I	Dali Version
E I	03.9151.40ADA
E I	03.9151.14ADA

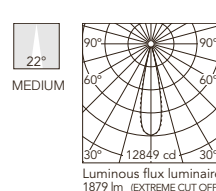

Beam Angle: 22°

h(m)	E(lx)	D(m)
1	12849	0.39
2	3212	0.78
3	1428	1.17
4	803	1.56
5	514	1.95

Optic Medium 2700K

E I	03.9140.40A
E I	03.9140.14A
E I	Dali Version
E I	03.9140.40ADA
E I	03.9140.14ADA

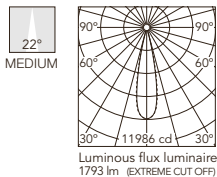

Beam Angle: 22°

h(m)	E(lx)	D(m)
1	11986	0.39
2	2996	0.78
3	1332	1.17
4	749	1.56
5	479	1.95

Optic Medium 3000K

E I	03.9150.40A
E I	03.9150.14A
E I	Dali Version
E I	03.9150.40ADA
E I	03.9150.14ADA

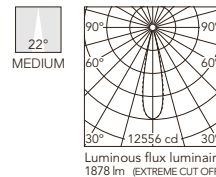

Beam Angle: 22°

h(m)	E(lx)	D(m)
1	12556	0.39
2	3139	0.78
3	1395	1.17
4	785	1.56
5	502	1.95

Optic Medium 2700K

E I	03.9142.40A
E I	03.9142.14A
E I	Dali Version
E I	03.9142.40ADA
E I	03.9142.14ADA

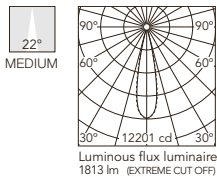

Beam Angle: 22°

h(m)	E(lx)	D(m)
1	12201	0.39
2	3050	0.77
3	1356	1.16
4	763	1.55
5	488	1.94

Optic Medium 3000K

E I	03.9152.40A
E I	03.9152.14A
E I	Dali Version
E I	03.9152.40ADA
E I	03.9152.14ADA

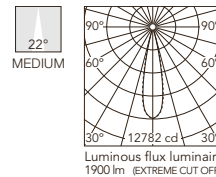

Beam Angle: 22°

h(m)	E(lx)	D(m)
1	12782	0.39
2	3196	0.77
3	1420	1.16
4	799	1.55
5	511	1.94

Optic Medium 2700K

E I	03.9143.40A
E I	03.9143.14A
E I	Dali Version
E I	03.9143.40ADA
E I	03.9143.14ADA

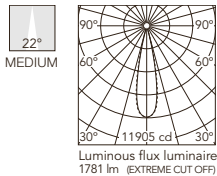

Beam Angle: 22°

h(m)	E(lx)	D(m)
1	11905	0.39
2	2976	0.78
3	1323	1.17
4	744	1.56
5	476	1.95

Optic Medium 3000K

E I	03.9153.40A
E I	03.9153.14A
E I	Dali Version
E I	03.9153.40ADA
E I	03.9153.14ADA

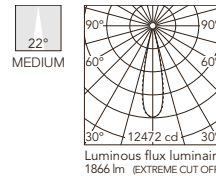

Beam Angle: 22°

h(m)	E(lx)	D(m)
1	12472	0.39
2	3118	0.78
3	1386	1.17
4	779	1.56
5	499	1.95

LIGHT SHADOW

Optic Flood

- 2700K**
- 03.9146.40A
 - 03.9146.14A
 - Dali Version
 - 03.9146.40ADA
 - 03.9146.14ADA

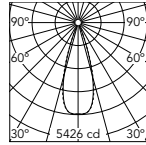

Beam Angle: 33°

h(m)	E(lx)	D(m)
1	5426	0.60
2	1357	1.19
3	603	1.79
4	339	2.39
5	217	2.99

Luminous flux luminaire
1735 lm (EXTREME CUT OFF)

- 2700K**
- 03.9145.40A
 - 03.9145.14A
 - Dali Version
 - 03.9145.40ADA
 - 03.9145.14ADA

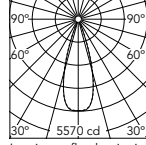

Beam Angle: 33°

h(m)	E(lx)	D(m)
1	5570	0.59
2	1392	1.18
3	619	1.78
4	348	2.37
5	223	2.96

Luminous flux luminaire
1787 lm (EXTREME CUT OFF)

- 2700K**
- 03.9147.40A
 - 03.9147.14A
 - Dali Version
 - 03.9147.40ADA
 - 03.9147.14ADA

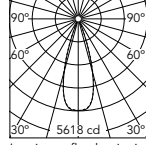

Beam Angle: 33°

h(m)	E(lx)	D(m)
1	5618	0.60
2	1405	1.19
3	624	1.79
4	351	2.38
5	225	2.98

Luminous flux luminaire
1814 lm (EXTREME CUT OFF)

- 2700K**
- 03.9148.40A
 - 03.9148.14A
 - Dali Version
 - 03.9148.40ADA
 - 03.9148.14ADA

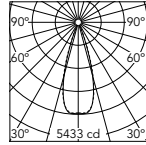

Beam Angle: 33°

h(m)	E(lx)	D(m)
1	5433	0.60
2	1358	1.20
3	604	1.79
4	340	2.39
5	217	2.99

Luminous flux luminaire
1765 lm (EXTREME CUT OFF)

Optic Flood

- 3000K**
- 03.9156.40A
 - 03.9156.14A
 - Dali Version
 - 03.9156.40ADA
 - 03.9156.14ADA

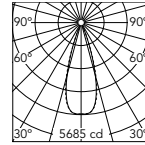

Beam Angle: 33°

h(m)	E(lx)	D(m)
1	5685	0.60
2	1421	1.19
3	632	1.79
4	355	2.39
5	227	2.99

Luminous flux luminaire
1818 lm (EXTREME CUT OFF)

- 3000K**
- 03.9155.40A
 - 03.9155.14A
 - Dali Version
 - 03.9155.40ADA
 - 03.9155.14ADA

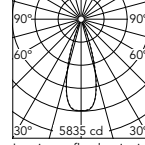

Beam Angle: 33°

h(m)	E(lx)	D(m)
1	5835	0.59
2	1459	1.18
3	648	1.78
4	365	2.37
5	233	2.96

Luminous flux luminaire
1872 lm (EXTREME CUT OFF)

- 3000K**
- 03.9157.40A
 - 03.9157.14A
 - Dali Version
 - 03.9157.40ADA
 - 03.9157.14ADA

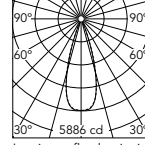

Beam Angle: 33°

h(m)	E(lx)	D(m)
1	5886	0.60
2	1472	1.19
3	654	1.79
4	368	2.38
5	235	2.98

Luminous flux luminaire
1901 lm (EXTREME CUT OFF)

- 3000K**
- 03.9158.40A
 - 03.9158.14A
 - Dali Version
 - 03.9158.40ADA
 - 03.9158.14ADA

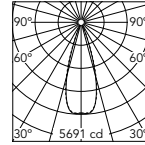

Beam Angle: 33°

h(m)	E(lx)	D(m)
1	5691	0.60
2	1423	1.20
3	632	1.79
4	356	2.39
5	228	2.99

Luminous flux luminaire
1850 lm (EXTREME CUT OFF)

Optic Wide Flood

- 2700K**
- 03.8317.40A
 - 03.8317.14A
 - Dali Version
 - 03.8317.40ADA
 - 03.8317.14ADA

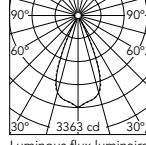

Beam Angle: 46°

h(m)	E(lx)	D(m)
1	3363	0.84
2	841	1.69
3	374	2.53
4	210	3.38
5	135	4.22

Luminous flux luminaire
1773 lm (EXTREME CUT OFF)

- 2700K**
- 03.8316.40A
 - 03.8316.14A
 - Dali Version
 - 03.8316.40ADA
 - 03.8316.14ADA

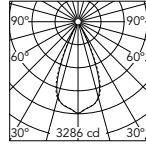

Beam Angle: 45°

h(m)	E(lx)	D(m)
1	3286	0.83
2	822	1.67
3	365	2.50
4	205	3.34
5	131	4.17

Luminous flux luminaire
1763 lm (EXTREME CUT OFF)

- 2700K**
- 03.8318.40A
 - 03.8318.14A
 - Dali Version
 - 03.8318.40ADA
 - 03.8318.14ADA

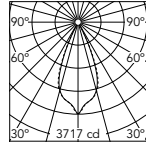

Beam Angle: 44°

h(m)	E(lx)	D(m)
1	3717	0.80
2	929	1.60
3	413	2.40
4	232	3.19
5	149	3.99

Luminous flux luminaire
1783 lm (EXTREME CUT OFF)

- 2700K**
- 03.8319.40A
 - 03.8319.14A
 - Dali Version
 - 03.8319.40ADA
 - 03.8319.14ADA

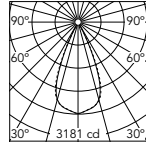

Beam Angle: 46°

h(m)	E(lx)	D(m)
1	3181	0.84
2	795	1.69
3	353	2.53
4	199	3.38
5	127	4.22

Luminous flux luminaire
1727 lm (EXTREME CUT OFF)

Optic Wide Flood

- 3000K**
- 03.8321.40A
 - 03.8321.14A
 - Dali Version
 - 03.8321.40ADA
 - 03.8321.14ADA

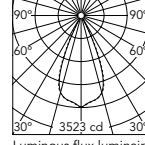

Beam Angle: 46°

h(m)	E(lx)	D(m)
1	3523	0.84
2	881	1.69
3	391	2.53
4	220	3.38
5	141	4.22

Luminous flux luminaire
1858 lm (EXTREME CUT OFF)

- 3000K**
- 03.8320.40A
 - 03.8320.14A
 - Dali Version
 - 03.8320.40ADA
 - 03.8320.14ADA

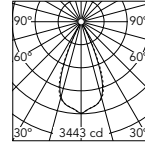

Beam Angle: 45°

h(m)	E(lx)	D(m)
1	3443	0.83
2	861	1.67
3	383	2.50
4	215	3.34
5	138	4.17

Luminous flux luminaire
1847 lm (EXTREME CUT OFF)

- 3000K**
- 03.8322.40A
 - 03.8322.14A
 - Dali Version
 - 03.8322.40ADA
 - 03.8322.14ADA

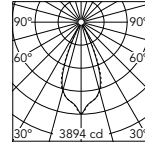

Beam Angle: 44°

h(m)	E(lx)	D(m)
1	3894	0.80
2	973	1.60
3	433	2.40
4	243	3.19
5	156	3.99

Luminous flux luminaire
1868 lm (EXTREME CUT OFF)

- 3000K**
- 03.8323.40A
 - 03.8323.14A
 - Dali Version
 - 03.8323.40ADA
 - 03.8323.14ADA

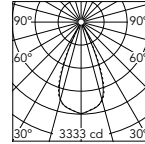

Beam Angle: 46°

h(m)	E(lx)	D(m)
1	3333	0.84
2	833	1.69
3	370	2.53
4	208	3.38
5	133	4.22

Luminous flux luminaire
1809 lm (EXTREME CUT OFF)

LIGHT SHADOW

Light Shadow Fixed Trim 12 Spots

Light Source: Power LED 32,4W - 3240 lm - 2700K/CRI 90 / 32,4W - 3420 lm - 3000K/CRI 90

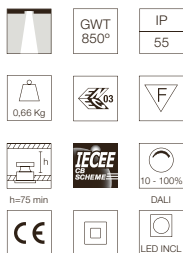
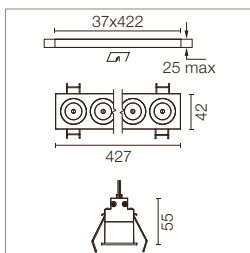

Apparecchio per illuminazione da incasso con 12 spot LED. Alimentazione remota inclusa (220-240V). Non richiede cornice di pre-installazione.

Recessed integrated luminaire with 12 LED lighting spots. Remote power supply included (220-240V). Pre-installation frame not required.

E= Finitura Esterna
I= Finitura Interna

E= External Finish
I= Internal Finish

Optic Spot 2700K

E I 03.8845.40A
03.8845.14A

E I Dali & Push Version

E I 03.8845.40ADA
03.8845.14ADA

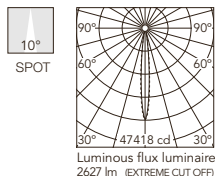

Beam Angle: 10°

h(m)	E(lx)	D(m)
1	47418	0.18
2	11854	0.36
3	5269	0.54
4	2964	0.72
5	1897	0.90

Optic Spot 3000K

E I 03.8849.40A
03.8849.14A

E I Dali & Push Version

E I 03.8849.40ADA
03.8849.14ADA

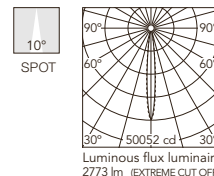

Beam Angle: 10°

h(m)	E(lx)	D(m)
1	50052	0.18
2	12513	0.36
3	5561	0.54
4	3128	0.72
5	2002	0.90

Optic Spot 2700K

E I 03.8844.40A
03.8844.14A

E I Dali & Push Version

E I 03.8844.40ADA
03.8844.14ADA

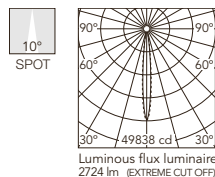

Beam Angle: 10°

h(m)	E(lx)	D(m)
1	49838	0.17
2	12459	0.35
3	5538	0.52
4	3115	0.70
5	1994	0.87

Optic Spot 3000K

E I 03.8848.40A
03.8848.14A

E I Dali & Push Version

E I 03.8848.40ADA
03.8848.14ADA

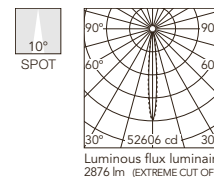

Beam Angle: 10°

h(m)	E(lx)	D(m)
1	52606	0.17
2	13152	0.35
3	5845	0.52
4	3288	0.70
5	2104	0.87

Optic Spot 2700K

E I 03.8846.40A
03.8846.14A

E I Dali & Push Version

E I 03.8846.40ADA
03.8846.14ADA

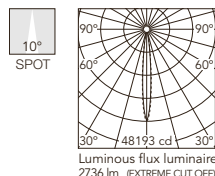

Beam Angle: 10°

h(m)	E(lx)	D(m)
1	48193	0.18
2	12048	0.36
3	5355	0.55
4	3012	0.73
5	1928	0.91

Optic Spot 3000K

E I 03.8850.40A
03.8850.14A

E I Dali & Push Version

E I 03.8850.40ADA
03.8850.14ADA

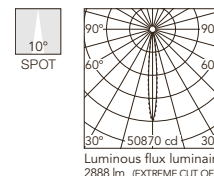

Beam Angle: 10°

h(m)	E(lx)	D(m)
1	50870	0.18
2	12718	0.36
3	5652	0.55
4	3179	0.73
5	2035	0.91

Optic Spot 2700K

E I 03.8847.40A
03.8847.14A

E I Dali & Push Version

E I 03.8847.40ADA
03.8847.14ADA

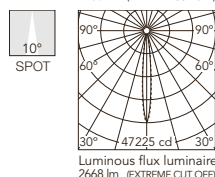

Beam Angle: 10°

h(m)	E(lx)	D(m)
1	47225	0.18
2	11806	0.36
3	5247	0.55
4	2952	0.73
5	1889	0.91

Optic Spot 3000K

E I 03.8851.40A
03.8851.14A

E I Dali & Push Version

E I 03.8851.40ADA
03.8851.14ADA

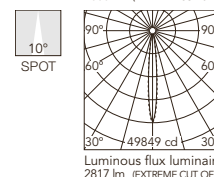

Beam Angle: 10°

h(m)	E(lx)	D(m)
1	49849	0.18
2	12462	0.36
3	5539	0.55
4	3116	0.73
5	1994	0.91

Optic Medium 2700K

E I 03.9161.40A
03.9161.14A

E I Dali & Push Version

E I 03.9161.40ADA
03.9161.14ADA

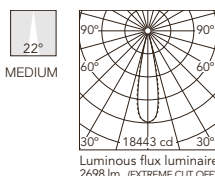

Beam Angle: 22°

h(m)	E(lx)	D(m)
1	18443	0.39
2	4611	0.78
3	2049	1.17
4	1153	1.56
5	738	1.95

Optic Medium 3000K

E I 03.9171.40A
03.9171.14A

E I Dali & Push Version

E I 03.9171.40ADA
03.9171.14ADA

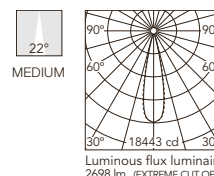

Beam Angle: 22°

h(m)	E(lx)	D(m)
1	18443	0.39
2	4611	0.78
3	2049	1.17
4	1153	1.56
5	738	1.95

Optic Medium 2700K

E I 03.9160.40A
03.9160.14A

E I Dali & Push Version

E I 03.9160.40ADA
03.9160.14ADA

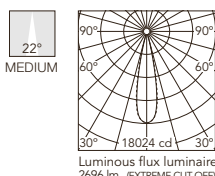

Beam Angle: 22°

h(m)	E(lx)	D(m)
1	18024	0.39
2	4506	0.78
3	2003	1.17
4	1126	1.56
5	721	1.95

Optic Medium 3000K

E I 03.9170.40A
03.9170.14A

E I Dali & Push Version

E I 03.9170.40ADA
03.9170.14ADA

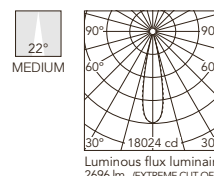

Beam Angle: 22°

h(m)	E(lx)	D(m)
1	18024	0.39
2	4506	0.78
3	2003	1.17
4	1126	1.56
5	721	1.95

Optic Medium 2700K

E I 03.9162.40A
03.9162.14A

E I Dali & Push Version

E I 03.9162.40ADA
03.9162.14ADA

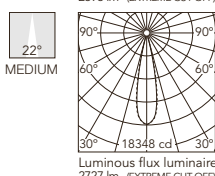

Beam Angle: 22°

h(m)	E(lx)	D(m)
1	18348	0.39
2	4587	0.77
3	2039	1.16
4	1147	1.55
5	734	1.94

Optic Medium 3000K

E I 03.9172.40A
03.9172.14A

E I Dali & Push Version

E I 03.9172.40ADA
03.9172.14ADA

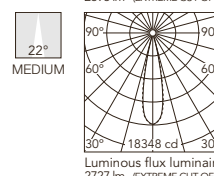

Beam Angle: 22°

h(m)	E(lx)	D(m)
1	18348	0.39
2	4587	0.77
3	2039	1.16
4	1147	1.55
5	734	1.94

Optic Medium 2700K

E I 03.9163.40A
03.9163.14A

E I Dali & Push Version

E I 03.9163.40ADA
03.9163.14ADA

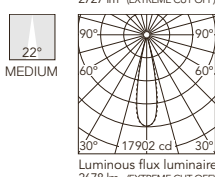

Beam Angle: 22°

h(m)	E(lx)	D(m)
1	17902	0.39
2	4476	0.78
3	1989	1.17
4	1119	1.56
5	716	1.95

Optic Medium 3000K

E I 03.9173.40A
03.9173.14A

E I Dali & Push Version

E I 03.9173.40ADA
03.9173.14ADA

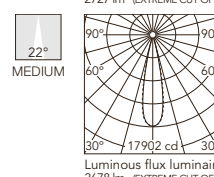

Beam Angle: 22°

h(m)	E(lx)	D(m)
1	17902	0.39
2	4476	0.78
3	1989	1.17
4	1119	1.56
5	716	1.95

LIGHT SHADOW

Optic Flood
2700K
E I 03.9166.40A
03.9166.14A
E I Dali & Push Version
03.9166.40ADA
03.9166.14ADA

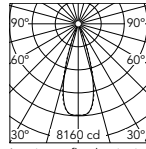

Beam Angle: 33°
h(m) E(lx) D(m)
1 8160 0.60
2 2040 1.19
3 907 1.79
4 510 2.39
5 326 2.99

Luminous flux luminaire
2610 lm (EXTREME CUT OFF)

Optic Flood
3000K
E I 03.9176.40A
03.9176.14A
E I Dali & Push Version
03.9176.40ADA
03.9176.14ADA

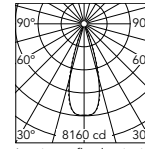

Beam Angle: 33°
h(m) E(lx) D(m)
1 8160 0.60
2 2040 1.19
3 907 1.79
4 510 2.39
5 326 2.99

Luminous flux luminaire
2610 lm (EXTREME CUT OFF)

Optic Flood
2700K
E I 03.9165.40A
03.9165.14A
E I Dali & Push Version
03.9165.40ADA
03.9165.14ADA

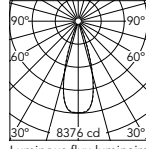

Beam Angle: 33°
h(m) E(lx) D(m)
1 8376 0.59
2 2094 1.18
3 931 1.78
4 523 2.37
5 335 2.96

Luminous flux luminaire
2687 lm (EXTREME CUT OFF)

Optic Flood
3000K
E I 03.9175.40A
03.9175.14A
E I Dali & Push Version
03.9175.40ADA
03.9175.14ADA

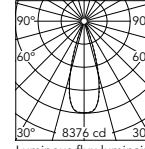

Beam Angle: 33°
h(m) E(lx) D(m)
1 8376 0.59
2 2094 1.18
3 931 1.78
4 523 2.37
5 335 2.96

Luminous flux luminaire
2687 lm (EXTREME CUT OFF)

Optic Flood
2700K
E I 03.9167.40A
03.9167.14A
E I Dali & Push Version
03.9167.40ADA
03.9167.14ADA

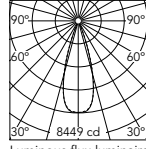

Beam Angle: 33°
h(m) E(lx) D(m)
1 8449 0.60
2 2112 1.19
3 939 1.79
4 528 2.38
5 338 2.98

Luminous flux luminaire
2728 lm (EXTREME CUT OFF)

Optic Flood
3000K
E I 03.9177.40A
03.9177.14A
E I Dali & Push Version
03.9177.40ADA
03.9177.14ADA

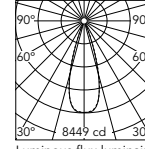

Beam Angle: 33°
h(m) E(lx) D(m)
1 8449 0.60
2 2112 1.19
3 939 1.79
4 528 2.38
5 338 2.98

Luminous flux luminaire
2728 lm (EXTREME CUT OFF)

Optic Flood
2700K
E I 03.9168.40A
03.9168.14A
E I Dali & Push Version
03.9168.40ADA
03.9168.14ADA

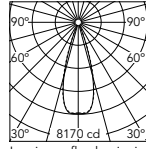

Beam Angle: 33°
h(m) E(lx) D(m)
1 8170 0.60
2 2042 1.20
3 908 1.79
4 511 2.39
5 327 2.99

Luminous flux luminaire
2655 lm (EXTREME CUT OFF)

Optic Flood
3000K
E I 03.9178.40A
03.9178.14A
E I Dali & Push Version
03.9178.40ADA
03.9178.14ADA

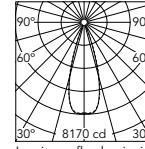

Beam Angle: 33°
h(m) E(lx) D(m)
1 8170 0.60
2 2042 1.20
3 908 1.79
4 511 2.39
5 327 2.99

Luminous flux luminaire
2655 lm (EXTREME CUT OFF)

Optic Wide Flood
2700K
E I 03.8325.40A
03.8325.14A
E I Dali & Push Version
03.8325.40ADA
03.8325.14ADA

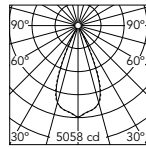

Beam Angle: 46°
h(m) E(lx) D(m)
1 5058 0.84
2 1264 1.69
3 562 2.53
4 316 3.38
5 202 4.22

Luminous flux luminaire
2666 lm (EXTREME CUT OFF)

Optic Wide Flood
3000K
E I 03.8329.40A
03.8329.14A
E I Dali & Push Version
03.8329.40ADA
03.8329.14ADA

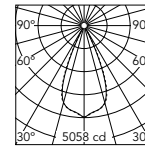

Beam Angle: 46°
h(m) E(lx) D(m)
1 5058 0.84
2 1264 1.69
3 562 2.53
4 316 3.38
5 202 4.22

Luminous flux luminaire
2666 lm (EXTREME CUT OFF)

Optic Wide Flood
2700K
E I 03.8324.40A
03.8324.14A
E I Dali & Push Version
03.8324.40ADA
03.8324.14ADA

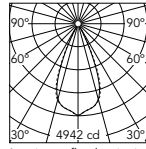

Beam Angle: 45°
h(m) E(lx) D(m)
1 4942 0.83
2 1235 1.67
3 549 2.50
4 309 3.34
5 198 4.17

Luminous flux luminaire
2652 lm (EXTREME CUT OFF)

Optic Wide Flood
3000K
E I 03.8328.40A
03.8328.14A
E I Dali & Push Version
03.8328.40ADA
03.8328.14ADA

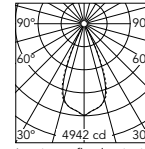

Beam Angle: 45°
h(m) E(lx) D(m)
1 4942 0.83
2 1235 1.67
3 549 2.50
4 309 3.34
5 198 4.17

Luminous flux luminaire
2652 lm (EXTREME CUT OFF)

Optic Wide Flood
2700K
E I 03.8326.40A
03.8326.14A
E I Dali & Push Version
03.8326.40ADA
03.8326.14ADA

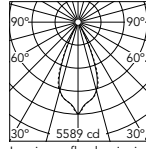

Beam Angle: 44°
h(m) E(lx) D(m)
1 5589 0.80
2 1397 1.60
3 621 2.40
4 349 3.19
5 224 3.99

Luminous flux luminaire
2681 lm (EXTREME CUT OFF)

Optic Wide Flood
3000K
E I 03.8330.40A
03.8330.14A
E I Dali & Push Version
03.8330.40ADA
03.8330.14ADA

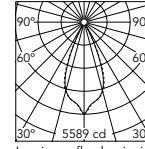

Beam Angle: 44°
h(m) E(lx) D(m)
1 5589 0.80
2 1397 1.60
3 621 2.40
4 349 3.19
5 224 3.99

Luminous flux luminaire
2681 lm (EXTREME CUT OFF)

Optic Wide Flood
2700K
E I 03.8327.40A
03.8327.14A
E I Dali & Push Version
03.8327.40ADA
03.8327.14ADA

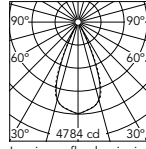

Beam Angle: 46°
h(m) E(lx) D(m)
1 4784 0.84
2 1196 1.69
3 532 2.53
4 299 3.38
5 191 4.22

Luminous flux luminaire
2597 lm (EXTREME CUT OFF)

Optic Wide Flood
3000K
E I 03.8331.40A
03.8331.14A
E I Dali & Push Version
03.8331.40ADA
03.8331.14ADA

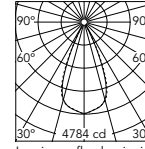

Beam Angle: 46°
h(m) E(lx) D(m)
1 4784 0.84
2 1196 1.69
3 532 2.53
4 299 3.38
5 191 4.22

Luminous flux luminaire
2597 lm (EXTREME CUT OFF)

LIGHT SHADOW

Light Shadow Fixed No Trim 2 Spots

Light Source: Power LED 5,4W - 540 lm - 2700K/CRI 90 / 5,4W - 570 lm - 3000K/CRI 90

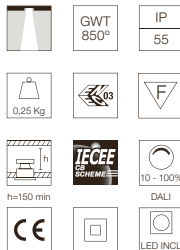
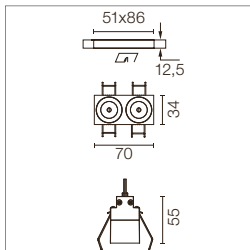

Apparecchio per illuminazione da incasso con 2 spot LED. Alimentazione remota inclusa (220-240V). Necessaria cornice di pre-installazione, da ordinare separatamente.

Recessed integrated luminaire with 2 LED lighting spots. Remote power supply included (220-240V). It requires a pre-installation frame, to be ordered separately.

E= Finitura Esterna
I= Finitura Interna

E= External Finish
I= Internal Finish

Optic Spot 2700K

E I 03.8853.40A
03.8853.14A

E I Dali Version

E I 03.8853.40ADA
03.8853.14ADA

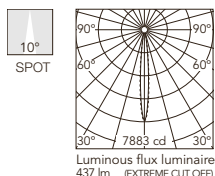

Beam Angle: 10°

h(m)	E(lx)	D(m)
1	7883	0.18
2	1971	0.36
3	876	0.54
4	493	0.72
5	315	0.90

Optic Spot 3000K

E I 03.8857.40A
03.8857.14A

E I Dali Version

E I 03.8857.40ADA
03.8857.14ADA

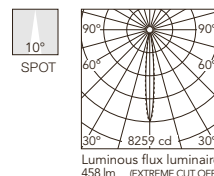

Beam Angle: 10°

h(m)	E(lx)	D(m)
1	8259	0.18
2	2065	0.36
3	918	0.54
4	516	0.72
5	330	0.90

Optic Spot 2700K

E I 03.8852.40A
03.8852.14A

E I Dali Version

E I 03.8852.40ADA
03.8852.14ADA

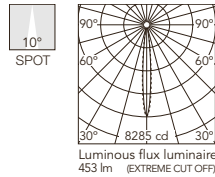

Beam Angle: 10°

h(m)	E(lx)	D(m)
1	8285	0.17
2	2071	0.35
3	921	0.52
4	518	0.70
5	331	0.87

Optic Spot 3000K

E I 03.8856.40A
03.8856.14A

E I Dali Version

E I 03.8856.40ADA
03.8856.14ADA

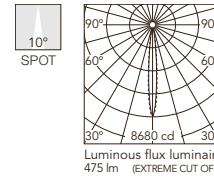

Beam Angle: 10°

h(m)	E(lx)	D(m)
1	8680	0.17
2	2170	0.35
3	964	0.52
4	542	0.70
5	347	0.87

Optic Spot 2700K

E I 03.8854.40A
03.8854.14A

E I Dali Version

E I 03.8854.40ADA
03.8854.14ADA

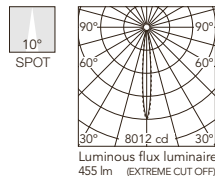

Beam Angle: 10°

h(m)	E(lx)	D(m)
1	8012	0.18
2	2003	0.36
3	890	0.55
4	501	0.73
5	320	0.91

Optic Spot 3000K

E I 03.8858.40A
03.8858.14A

E I Dali Version

E I 03.8858.40ADA
03.8858.14ADA

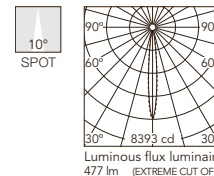

Beam Angle: 10°

h(m)	E(lx)	D(m)
1	8393	0.18
2	2098	0.36
3	933	0.55
4	525	0.73
5	336	0.91

Optic Spot 2700K

E I 03.8855.40A
03.8855.14A

E I Dali Version

E I 03.8855.40ADA
03.8855.14ADA

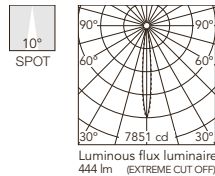

Beam Angle: 10°

h(m)	E(lx)	D(m)
1	7851	0.18
2	1963	0.36
3	872	0.55
4	491	0.73
5	314	0.91

Optic Spot 3000K

E I 03.8859.40A
03.8859.14A

E I Dali Version

E I 03.8859.40ADA
03.8859.14ADA

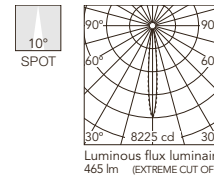

Beam Angle: 10°

h(m)	E(lx)	D(m)
1	8225	0.18
2	2056	0.36
3	914	0.55
4	514	0.73
5	329	0.91

Optic Medium 2700K

E I 03.9201.40A
03.9201.14A

E I Dali Version

E I 03.9201.40ADA
03.9201.14ADA

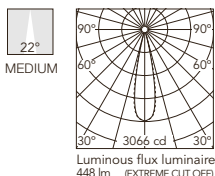

Beam Angle: 22°

h(m)	E(lx)	D(m)
1	3066	0.39
2	767	0.78
3	341	1.17
4	192	1.56
5	123	1.95

Optic Medium 3000K

E I 03.9211.40A
03.9211.14A

E I Dali Version

E I 03.9211.40ADA
03.9211.14ADA

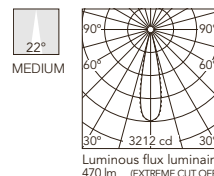

Beam Angle: 22°

h(m)	E(lx)	D(m)
1	3212	0.39
2	803	0.78
3	357	1.17
4	201	1.56
5	128	1.95

Optic Medium 2700K

E I 03.9200.40A
03.9200.14A

E I Dali Version

E I 03.9200.40ADA
03.9200.14ADA

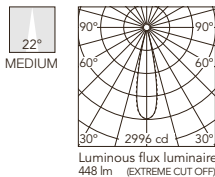

Beam Angle: 22°

h(m)	E(lx)	D(m)
1	2996	0.39
2	749	0.78
3	333	1.17
4	187	1.56
5	120	1.95

Optic Medium 3000K

E I 03.9210.40A
03.9210.14A

E I Dali Version

E I 03.9210.40ADA
03.9210.14ADA

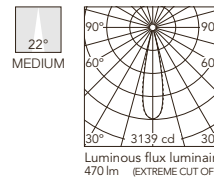

Beam Angle: 22°

h(m)	E(lx)	D(m)
1	3139	0.39
2	785	0.78
3	349	1.17
4	196	1.56
5	126	1.95

Optic Medium 2700K

E I 03.9202.40A
03.9202.14A

E I Dali Version

E I 03.9202.40ADA
03.9202.14ADA

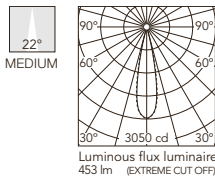

Beam Angle: 22°

h(m)	E(lx)	D(m)
1	3050	0.39
2	763	0.77
3	339	1.16
4	191	1.55
5	122	1.94

Optic Medium 3000K

E I 03.9212.40A
03.9212.14A

E I Dali Version

E I 03.9212.40ADA
03.9212.14ADA

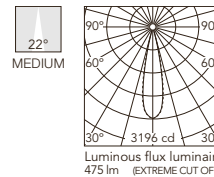

Beam Angle: 22°

h(m)	E(lx)	D(m)
1	3196	0.39
2	799	0.77
3	355	1.16
4	200	1.55
5	128	1.94

Optic Medium 2700K

E I 03.9203.40A
03.9203.14A

E I Dali Version

E I 03.9203.40ADA
03.9203.14ADA

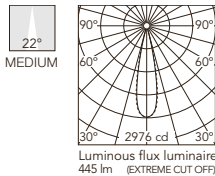

Beam Angle: 22°

h(m)	E(lx)	D(m)
1	2976	0.39
2	744	0.78
3	331	1.17
4	186	1.56
5	119	1.95

Optic Medium 3000K

E I 03.9213.40A
03.9213.14A

E I Dali Version

E I 03.9213.40ADA
03.9213.14ADA

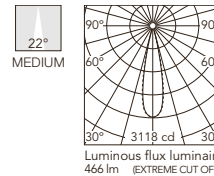

Beam Angle: 22°

h(m)	E(lx)	D(m)
1	3118	0.39
2	779	0.78
3	346	1.17
4	195	1.56
5	125	1.95

LIGHT SHADOW

Optic Flood
2700K
 E I 03.9206.40A
 03.9206.14A
 E I Dali Version
 03.9206.40ADA
 03.9206.14ADA

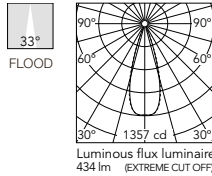

Beam Angle: 33°

h(m)	E(lx)	D(m)
1	1357	0.60
2	339	1.19
3	151	1.79
4	85	2.39
5	54	2.99

Optic Flood
3000K
 E I 03.9216.40A
 03.9216.14A
 E I Dali Version
 03.9216.40ADA
 03.9216.14ADA

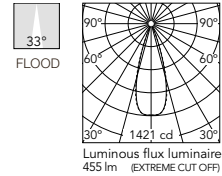

Beam Angle: 33°

h(m)	E(lx)	D(m)
1	1421	0.60
2	355	1.19
3	158	1.79
4	89	2.39
5	57	2.99

Optic Flood
2700K
 E I 03.9205.40A
 03.9205.14A
 E I Dali Version
 03.9205.40ADA
 03.9205.14ADA

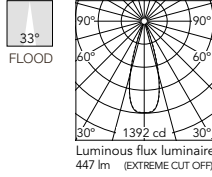

Beam Angle: 33°

h(m)	E(lx)	D(m)
1	1392	0.59
2	348	1.18
3	155	1.78
4	87	2.37
5	56	2.96

Optic Flood
3000K
 E I 03.9215.40A
 03.9215.14A
 E I Dali Version
 03.9215.40ADA
 03.9215.14ADA

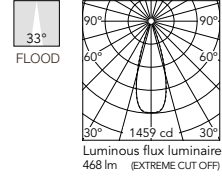

Beam Angle: 33°

h(m)	E(lx)	D(m)
1	1459	0.59
2	365	1.18
3	162	1.78
4	91	2.37
5	58	2.96

Optic Flood
2700K
 E I 03.9207.40A
 03.9207.14A
 E I Dali Version
 03.9207.40ADA
 03.9207.14ADA

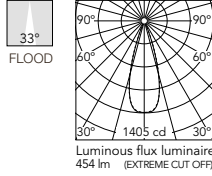

Beam Angle: 33°

h(m)	E(lx)	D(m)
1	1405	0.60
2	351	1.19
3	156	1.79
4	88	2.38
5	56	2.98

Optic Flood
3000K
 E I 03.9217.40A
 03.9217.14A
 E I Dali Version
 03.9217.40ADA
 03.9217.14ADA

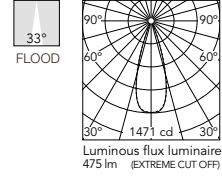

Beam Angle: 33°

h(m)	E(lx)	D(m)
1	1471	0.60
2	368	1.19
3	163	1.79
4	92	2.38
5	59	2.98

Optic Flood
2700K
 E I 03.9208.40A
 03.9208.14A
 E I Dali Version
 03.9208.40ADA
 03.9208.14ADA

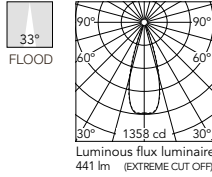

Beam Angle: 33°

h(m)	E(lx)	D(m)
1	1358	0.60
2	340	1.20
3	151	1.79
4	85	2.39
5	54	2.99

Optic Flood
3000K
 E I 03.9218.40A
 03.9218.14A
 E I Dali Version
 03.9218.40ADA
 03.9218.14ADA

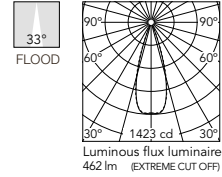

Beam Angle: 33°

h(m)	E(lx)	D(m)
1	1423	0.60
2	356	1.20
3	158	1.79
4	89	2.39
5	57	2.99

Optic Wide Flood
2700K
 E I 03.8351.40A
 03.8351.14A
 E I Dali Version
 03.8351.40ADA
 03.8351.14ADA

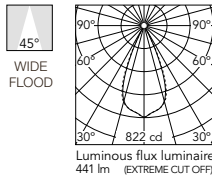

Beam Angle: 45°

h(m)	E(lx)	D(m)
1	822	0.83
2	205	1.67
3	91	2.50
4	51	3.34
5	33	4.17

Optic Wide Flood
3000K
 E I 03.8355.40A
 03.8355.14A
 E I Dali Version
 03.8355.40ADA
 03.8355.14ADA

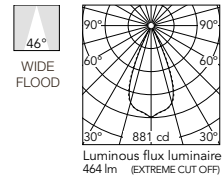

Beam Angle: 46°

h(m)	E(lx)	D(m)
1	881	0.84
2	220	1.69
3	98	2.53
4	55	3.38
5	35	4.22

Optic Wide Flood
2700K
 E I 03.8350.40A
 03.8350.14A
 E I Dali Version
 03.8350.40ADA
 03.8350.14ADA

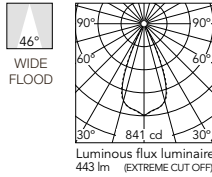

Beam Angle: 46°

h(m)	E(lx)	D(m)
1	841	0.84
2	210	1.69
3	93	2.53
4	53	3.38
5	34	4.22

Optic Wide Flood
3000K
 E I 03.8354.40A
 03.8354.14A
 E I Dali Version
 03.8354.40ADA
 03.8354.14ADA

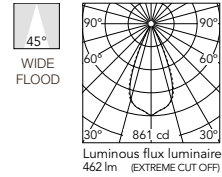

Beam Angle: 45°

h(m)	E(lx)	D(m)
1	861	0.83
2	215	1.67
3	96	2.50
4	54	3.34
5	34	4.17

Optic Wide Flood
2700K
 E I 03.8352.40A
 03.8352.14A
 E I Dali Version
 03.8352.40ADA
 03.8352.14ADA

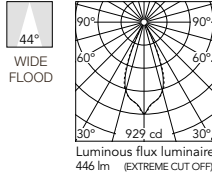

Beam Angle: 44°

h(m)	E(lx)	D(m)
1	929	0.80
2	232	1.60
3	103	2.40
4	58	3.19
5	37	3.99

Optic Wide Flood
3000K
 E I 03.8356.40A
 03.8356.14A
 E I Dali Version
 03.8356.40ADA
 03.8356.14ADA

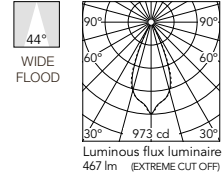

Beam Angle: 44°

h(m)	E(lx)	D(m)
1	973	0.80
2	243	1.60
3	108	2.40
4	61	3.19
5	39	3.99

Optic Wide Flood
2700K
 E I 03.8353.40A
 03.8353.14A
 E I Dali Version
 03.8353.40ADA
 03.8353.14ADA

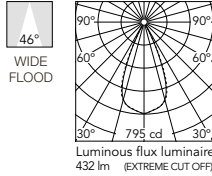

Beam Angle: 46°

h(m)	E(lx)	D(m)
1	795	0.84
2	199	1.69
3	88	2.53
4	50	3.38
5	32	4.22

Optic Wide Flood
3000K
 E I 03.8357.40A
 03.8357.14A
 E I Dali Version
 03.8357.40ADA
 03.8357.14ADA

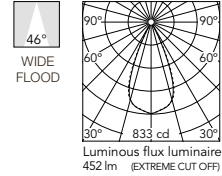

Beam Angle: 46°

h(m)	E(lx)	D(m)
1	833	0.84
2	208	1.69
3	93	2.53
4	52	3.38
5	33	4.22

LIGHT SHADOW

Light Shadow Fixed No Trim 4 Spots

Light Source: Power LED 10,8W - 1080 lm - 2700K/CRI 90 / 10,8W - 1140lm - 3000K/CRI 90

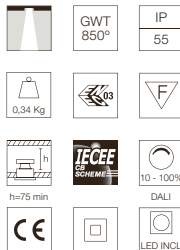
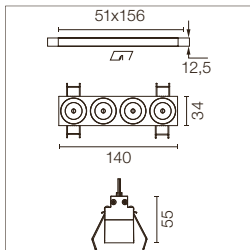

Apparecchio per illuminazione da incasso con 4 spot LED. Alimentazione remota inclusa. Necessaria cornice di installazione, da ordinare separatamente (220-240V). Cornice di pre-installazione da ordinare separatamente.

Recessed integrated luminaire with 4 LED lighting spots. Remote power supply included (220-240V). It requires a pre-installation frame, to be ordered separately.

E= Finitura Esterna
I= Finitura Interna

E= External Finish
I= Internal Finish.

- Optic Spot 2700K**
- E I 03.8861.40A
 - I 03.8861.14A
 - E I Dali Version
 - I 03.8861.40ADA
 - I 03.8861.14ADA

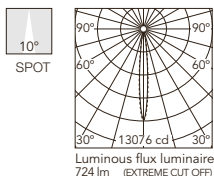

Beam Angle: 10°

h(m)	E(lx)	D(m)
1	13076	0.18
2	3269	0.36
3	1453	0.54
4	817	0.72
5	523	0.90

- Optic Spot 3000K**
- E I 03.8865.40A
 - I 03.8865.14A
 - E I Dali Version
 - I 03.8865.40ADA
 - I 03.8865.14ADA

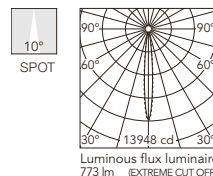

Beam Angle: 10°

h(m)	E(lx)	D(m)
1	13948	0.18
2	3487	0.36
3	1550	0.54
4	872	0.72
5	558	0.90

- Optic Spot 2700K**
- E I 03.8860.40A
 - I 03.8860.14A
 - E I Dali Version
 - I 03.8860.40ADA
 - I 03.8860.14ADA

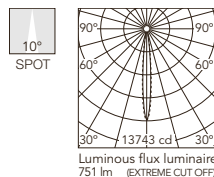

Beam Angle: 10°

h(m)	E(lx)	D(m)
1	13743	0.17
2	3436	0.35
3	1527	0.52
4	859	0.70
5	550	0.87

- Optic Spot 3000K**
- E I 03.8864.40A
 - I 03.8864.14A
 - E I Dali Version
 - I 03.8864.40ADA
 - I 03.8864.14ADA

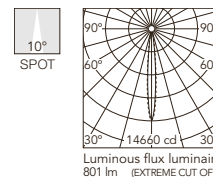

Beam Angle: 10°

h(m)	E(lx)	D(m)
1	14660	0.17
2	3665	0.35
3	1629	0.52
4	916	0.70
5	586	0.87

- Optic Spot 2700K**
- E I 03.8862.40A
 - I 03.8862.14A
 - E I Dali Version
 - I 03.8862.40ADA
 - I 03.8862.14ADA

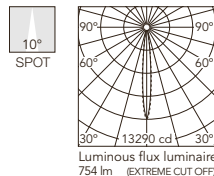

Beam Angle: 10°

h(m)	E(lx)	D(m)
1	13290	0.18
2	3322	0.36
3	1477	0.55
4	831	0.73
5	532	0.91

- Optic Spot 3000K**
- E I 03.8866.40A
 - I 03.8866.14A
 - E I Dali Version
 - I 03.8866.40ADA
 - I 03.8866.14ADA

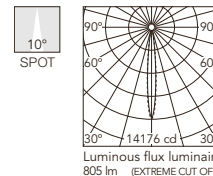

Beam Angle: 10°

h(m)	E(lx)	D(m)
1	14176	0.18
2	3544	0.36
3	1575	0.55
4	886	0.73
5	567	0.91

- Optic Spot 2700K**
- E I 03.8863.40A
 - I 03.8863.14A
 - E I Dali Version
 - I 03.8863.40ADA
 - I 03.8863.14ADA

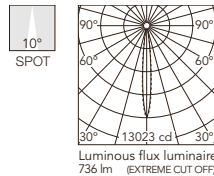

Beam Angle: 10°

h(m)	E(lx)	D(m)
1	13023	0.18
2	3256	0.36
3	1447	0.55
4	814	0.73
5	521	0.91

- Optic Spot 3000K**
- E I 03.8867.40A
 - I 03.8867.14A
 - E I Dali Version
 - I 03.8867.40ADA
 - I 03.8867.14ADA

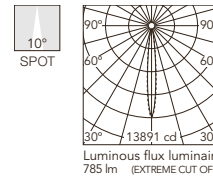

Beam Angle: 10°

h(m)	E(lx)	D(m)
1	13891	0.18
2	3473	0.36
3	1543	0.55
4	868	0.73
5	556	0.91

- Optic Medium 2700K**
- E I 03.9221.40A
 - I 03.9221.14A
 - E I Dali Version
 - I 03.9221.40ADA
 - I 03.9221.14ADA

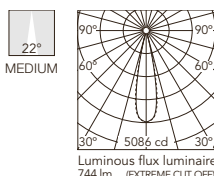

Beam Angle: 22°

h(m)	E(lx)	D(m)
1	5086	0.39
2	1272	0.78
3	565	1.17
4	318	1.56
5	203	1.95

- Optic Medium 3000K**
- E I 03.9231.40A
 - I 03.9231.14A
 - E I Dali Version
 - I 03.9231.40ADA
 - I 03.9231.14ADA

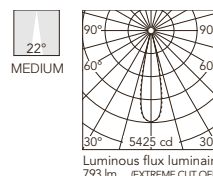

Beam Angle: 22°

h(m)	E(lx)	D(m)
1	5425	0.39
2	1356	0.78
3	603	1.17
4	339	1.56
5	217	1.95

- Optic Medium 2700K**
- E I 03.9220.40A
 - I 03.9220.14A
 - E I Dali Version
 - I 03.9220.40ADA
 - I 03.9220.14ADA

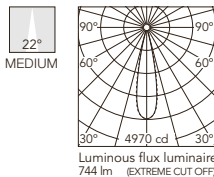

Beam Angle: 22°

h(m)	E(lx)	D(m)
1	4970	0.39
2	1243	0.78
3	552	1.17
4	311	1.56
5	199	1.95

- Optic Medium 3000K**
- E I 03.9230.40A
 - I 03.9230.14A
 - E I Dali Version
 - I 03.9230.40ADA
 - I 03.9230.14ADA

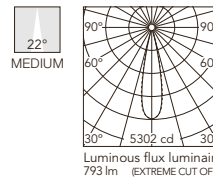

Beam Angle: 22°

h(m)	E(lx)	D(m)
1	5302	0.39
2	1325	0.78
3	589	1.17
4	331	1.56
5	212	1.95

- Optic Medium 2700K**
- E I 03.9222.40A
 - I 03.9222.14A
 - E I Dali Version
 - I 03.9222.40ADA
 - I 03.9222.14ADA

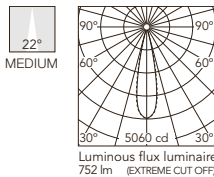

Beam Angle: 22°

h(m)	E(lx)	D(m)
1	5060	0.39
2	1265	0.77
3	562	1.16
4	316	1.55
5	202	1.94

- Optic Medium 3000K**
- E I 03.9232.40A
 - I 03.9232.14A
 - E I Dali Version
 - I 03.9232.40ADA
 - I 03.9232.14ADA

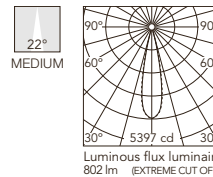

Beam Angle: 22°

h(m)	E(lx)	D(m)
1	5397	0.39
2	1349	0.77
3	600	1.16
4	337	1.55
5	216	1.94

- Optic Medium 2700K**
- E I 03.9223.40A
 - I 03.9223.14A
 - E I Dali Version
 - I 03.9223.40ADA
 - I 03.9223.14ADA

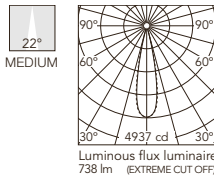

Beam Angle: 22°

h(m)	E(lx)	D(m)
1	4937	0.39
2	1234	0.78
3	549	1.17
4	309	1.56
5	197	1.95

- Optic Medium 3000K**
- E I 03.9233.40A
 - I 03.9233.14A
 - E I Dali Version
 - I 03.9233.40ADA
 - I 03.9233.14ADA

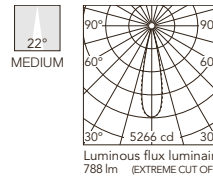

Beam Angle: 22°

h(m)	E(lx)	D(m)
1	5266	0.39
2	1316	0.78
3	585	1.17
4	329	1.56
5	211	1.95

LIGHT SHADOW

Optic Flood
2700K
 E I 03.9226.40A
 03.9226.14A
 E I Dali Version
 03.9226.40ADA
 03.9226.14ADA

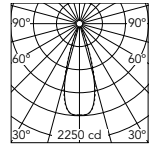

Beam Angle: 33°

h(m)	E(lx)	D(m)
1	2250	0.60
2	563	1.19
3	250	1.79
4	141	2.39
5	90	2.99

Luminous flux luminaire
 720 lm (EXTREME CUT OFF)

Optic Flood
3000K
 E I 03.9236.40A
 03.9236.14A
 E I Dali Version
 03.9236.40ADA
 03.9236.14ADA

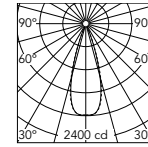

Beam Angle: 33°

h(m)	E(lx)	D(m)
1	2400	0.60
2	600	1.19
3	267	1.79
4	150	2.39
5	96	2.99

Luminous flux luminaire
 768 lm (EXTREME CUT OFF)

Optic Flood
2700K
 E I 03.9225.40A
 03.9225.14A
 E I Dali Version
 03.9225.40ADA
 03.9225.14ADA

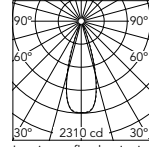

Beam Angle: 33°

h(m)	E(lx)	D(m)
1	2310	0.59
2	577	1.18
3	257	1.78
4	144	2.37
5	92	2.96

Luminous flux luminaire
 741 lm (EXTREME CUT OFF)

Optic Flood
3000K
 E I 03.9235.40A
 03.9235.14A
 E I Dali Version
 03.9235.40ADA
 03.9235.14ADA

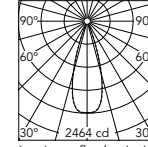

Beam Angle: 33°

h(m)	E(lx)	D(m)
1	2464	0.59
2	616	1.18
3	274	1.78
4	154	2.37
5	99	2.96

Luminous flux luminaire
 790 lm (EXTREME CUT OFF)

Optic Flood
2700K
 E I 03.9227.40A
 03.9227.14A
 E I Dali Version
 03.9227.40ADA
 03.9227.14ADA

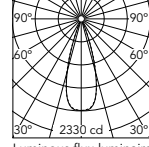

Beam Angle: 33°

h(m)	E(lx)	D(m)
1	2330	0.60
2	582	1.19
3	259	1.79
4	146	2.38
5	93	2.98

Luminous flux luminaire
 752 lm (EXTREME CUT OFF)

Optic Flood
3000K
 E I 03.9237.40A
 03.9237.14A
 E I Dali Version
 03.9237.40ADA
 03.9237.14ADA

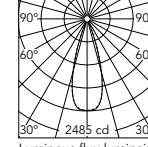

Beam Angle: 33°

h(m)	E(lx)	D(m)
1	2485	0.60
2	621	1.19
3	276	1.79
4	155	2.38
5	99	2.98

Luminous flux luminaire
 803 lm (EXTREME CUT OFF)

Optic Flood
2700K
 E I 03.9228.40A
 03.9228.14A
 E I Dali Version
 03.9228.40ADA
 03.9228.14ADA

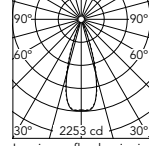

Beam Angle: 33°

h(m)	E(lx)	D(m)
1	2253	0.60
2	563	1.20
3	250	1.79
4	141	2.39
5	90	2.99

Luminous flux luminaire
 732 lm (EXTREME CUT OFF)

Optic Flood
3000K
 E I 03.9238.40A
 03.9238.14A
 E I Dali Version
 03.9238.40ADA
 03.9238.14ADA

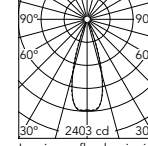

Beam Angle: 33°

h(m)	E(lx)	D(m)
1	2403	0.60
2	601	1.20
3	267	1.79
4	150	2.39
5	96	2.99

Luminous flux luminaire
 781 lm (EXTREME CUT OFF)

Optic Wide Flood
2700K
 E I 03.8359.40A
 03.8359.14A
 E I Dali Version
 03.8359.40ADA
 03.8359.14ADA

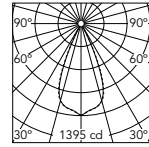

Beam Angle: 46°

h(m)	E(lx)	D(m)
1	1395	0.84
2	349	1.69
3	155	2.53
4	87	3.38
5	56	4.22

Luminous flux luminaire
 735 lm (EXTREME CUT OFF)

Optic Wide Flood
3000K
 E I 03.8363.40A
 03.8363.14A
 E I Dali Version
 03.8363.40ADA
 03.8363.14ADA

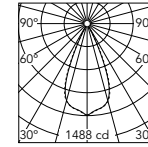

Beam Angle: 46°

h(m)	E(lx)	D(m)
1	1488	0.84
2	372	1.69
3	165	2.53
4	93	3.38
5	60	4.22

Luminous flux luminaire
 784 lm (EXTREME CUT OFF)

Optic Wide Flood
2700K
 E I 03.8358.40A
 03.8358.14A
 E I Dali Version
 03.8358.40ADA
 03.8358.14ADA

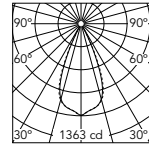

Beam Angle: 45°

h(m)	E(lx)	D(m)
1	1363	0.83
2	341	1.67
3	151	2.50
4	85	3.34
5	55	4.17

Luminous flux luminaire
 731 lm (EXTREME CUT OFF)

Optic Wide Flood
3000K
 E I 03.8362.40A
 03.8362.14A
 E I Dali Version
 03.8362.40ADA
 03.8362.14ADA

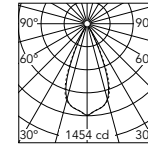

Beam Angle: 45°

h(m)	E(lx)	D(m)
1	1454	0.83
2	363	1.67
3	162	2.50
4	91	3.34
5	58	4.17

Luminous flux luminaire
 780 lm (EXTREME CUT OFF)

Optic Wide Flood
2700K
 E I 03.8360.40A
 03.8360.14A
 E I Dali Version
 03.8360.40ADA
 03.8360.14ADA

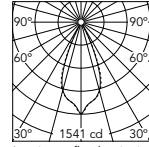

Beam Angle: 44°

h(m)	E(lx)	D(m)
1	1541	0.80
2	385	1.60
3	171	2.40
4	96	3.19
5	62	3.99

Luminous flux luminaire
 739 lm (EXTREME CUT OFF)

Optic Wide Flood
3000K
 E I 03.8364.40A
 03.8364.14A
 E I Dali Version
 03.8364.40ADA
 03.8364.14ADA

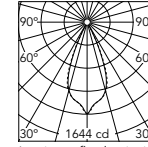

Beam Angle: 44°

h(m)	E(lx)	D(m)
1	1644	0.80
2	411	1.60
3	183	2.40
4	103	3.19
5	66	3.99

Luminous flux luminaire
 789 lm (EXTREME CUT OFF)

Optic Wide Flood
2700K
 E I 03.8361.40A
 03.8361.14A
 E I Dali Version
 03.8361.40ADA
 03.8361.14ADA

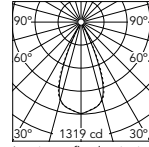

Beam Angle: 46°

h(m)	E(lx)	D(m)
1	1319	0.84
2	330	1.69
3	147	2.53
4	82	3.38
5	53	4.22

Luminous flux luminaire
 716 lm (EXTREME CUT OFF)

Optic Wide Flood
3000K
 E I 03.8365.40A
 03.8365.14A
 E I Dali Version
 03.8365.40ADA
 03.8365.14ADA

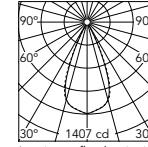

Beam Angle: 46°

h(m)	E(lx)	D(m)
1	1407	0.84
2	352	1.69
3	156	2.53
4	88	3.38
5	56	4.22

Luminous flux luminaire
 764 lm (EXTREME CUT OFF)

LIGHT SHADOW

Light Shadow Fixed No Trim 8 Spots

Light Source: Power LED 21,6W - 2160 lm - 2700K/CRI 90 / 21,6W - 2280 lm - 3000K/CRI 90

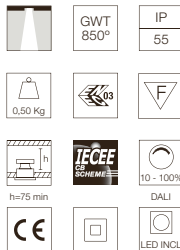
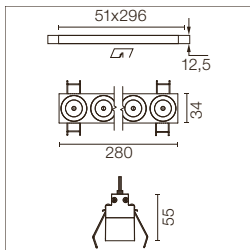

Apparecchio per illuminazione da incasso con 8 spot LED. Alimentazione remota inclusa (220-240V). Necessaria cornice di pre-installazione, da ordinare separatamente.

Recessed integrated luminaire with 8 LED lighting spots. Remote power supply included (220-240V). It requires a pre-installation frame, to be ordered separately.

E= Finitura Esterna
I= Finitura Interna

E= External Finish
I= Internal Finish

- Optic Spot 2700K**
- E I 03.8869.40A
 - I 03.8869.14A
 - E I Dali Version
 - I 03.8869.40ADA
 - I 03.8869.14ADA

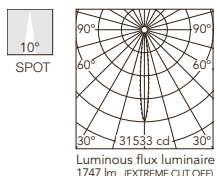

Beam Angle: 10°

h(m)	E(lx)	D(m)
1	31533	0.18
2	7883	0.36
3	3504	0.54
4	1971	0.72
5	1261	0.90

- Optic Spot 3000K**
- E I 03.8873.40A
 - I 03.8873.14A
 - E I Dali Version
 - I 03.8873.40ADA
 - I 03.8873.14ADA

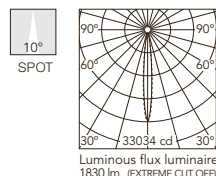

Beam Angle: 10°

h(m)	E(lx)	D(m)
1	33034	0.18
2	8259	0.36
3	3670	0.54
4	2065	0.72
5	1321	0.90

- Optic Spot 2700K**
- E I 03.8868.40A
 - I 03.8868.14A
 - E I Dali Version
 - I 03.8868.40ADA
 - I 03.8868.14ADA

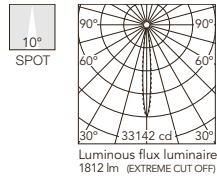

Beam Angle: 10°

h(m)	E(lx)	D(m)
1	33142	0.17
2	8285	0.35
3	3682	0.52
4	2071	0.70
5	1326	0.87

- Optic Spot 3000K**
- E I 03.8872.40A
 - I 03.8872.14A
 - E I Dali Version
 - I 03.8872.40ADA
 - I 03.8872.14ADA

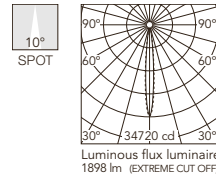

Beam Angle: 10°

h(m)	E(lx)	D(m)
1	34720	0.17
2	8680	0.35
3	3858	0.52
4	2170	0.70
5	1389	0.87

- Optic Spot 2700K**
- E I 03.8870.40A
 - I 03.8870.14A
 - E I Dali Version
 - I 03.8870.40ADA
 - I 03.8870.14ADA

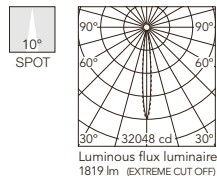

Beam Angle: 10°

h(m)	E(lx)	D(m)
1	32048	0.18
2	8012	0.36
3	3561	0.55
4	2003	0.73
5	1282	0.91

- Optic Spot 3000K**
- E I 03.8874.40A
 - I 03.8874.14A
 - E I Dali Version
 - I 03.8874.40ADA
 - I 03.8874.14ADA

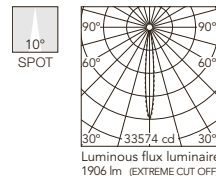

Beam Angle: 10°

h(m)	E(lx)	D(m)
1	32900	0.18
2	8394	0.36
3	3730	0.55
4	2098	0.73
5	1343	0.91

- Optic Spot 2700K**
- E I 03.8871.40A
 - I 03.8871.14A
 - E I Dali Version
 - I 03.8871.40ADA
 - I 03.8871.14ADA

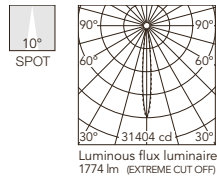

Beam Angle: 10°

h(m)	E(lx)	D(m)
1	31404	0.18
2	7851	0.36
3	3489	0.55
4	1963	0.73
5	1256	0.91

- Optic Spot 3000K**
- E I 03.8875.40A
 - I 03.8875.14A
 - E I Dali Version
 - I 03.8875.40ADA
 - I 03.8875.14ADA

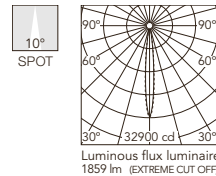

Beam Angle: 10°

h(m)	E(lx)	D(m)
1	32900	0.18
2	8225	0.36
3	3656	0.55
4	2056	0.73
5	1316	0.91

- Optic Medium 2700K**
- E I 03.9241.40A
 - I 03.9241.14A
 - E I Dali Version
 - I 03.9241.40ADA
 - I 03.9241.14ADA

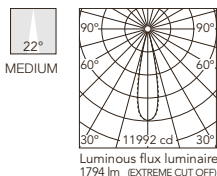

Beam Angle: 22°

h(m)	E(lx)	D(m)
1	11992	0.39
2	2998	0.78
3	1332	1.17
4	750	1.56
5	480	1.95

- Optic Medium 3000K**
- E I 03.9251.40A
 - I 03.9251.14A
 - E I Dali Version
 - I 03.9251.40ADA
 - I 03.9251.14ADA

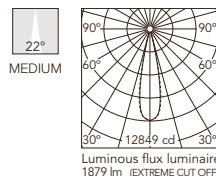

Beam Angle: 22°

h(m)	E(lx)	D(m)
1	12849	0.39
2	3212	0.78
3	1428	1.17
4	803	1.56
5	514	1.95

- Optic Medium 2700K**
- E I 03.9240.40A
 - I 03.9240.14A
 - E I Dali Version
 - I 03.9240.40ADA
 - I 03.9240.14ADA

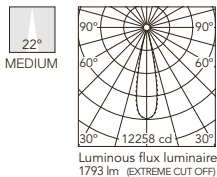

Beam Angle: 22°

h(m)	E(lx)	D(m)
1	12258	0.39
2	3065	0.78
3	1362	1.17
4	766	1.56
5	490	1.95

- Optic Medium 3000K**
- E I 03.9250.40A
 - I 03.9250.14A
 - E I Dali Version
 - I 03.9250.40ADA
 - I 03.9250.14ADA

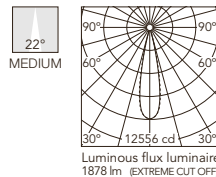

Beam Angle: 22°

h(m)	E(lx)	D(m)
1	12556	0.39
2	3139	0.78
3	1395	1.17
4	785	1.56
5	502	1.95

- Optic Medium 2700K**
- E I 03.9242.40A
 - I 03.9242.14A
 - E I Dali Version
 - I 03.9242.40ADA
 - I 03.9242.14ADA

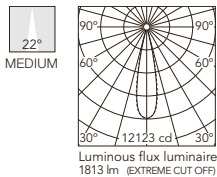

Beam Angle: 22°

h(m)	E(lx)	D(m)
1	12123	0.39
2	3031	0.78
3	1347	1.17
4	758	1.56
5	485	1.95

- Optic Medium 3000K**
- E I 03.9252.40A
 - I 03.9252.14A
 - E I Dali Version
 - I 03.9252.40ADA
 - I 03.9252.14ADA

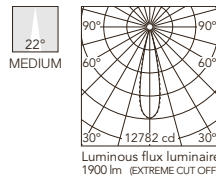

Beam Angle: 22°

h(m)	E(lx)	D(m)
1	12782	0.39
2	3196	0.77
3	1420	1.16
4	799	1.55
5	511	1.94

- Optic Medium 2700K**
- E I 03.9243.40A
 - I 03.9243.14A
 - E I Dali Version
 - I 03.9243.40ADA
 - I 03.9243.14ADA

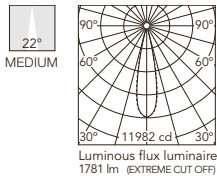

Beam Angle: 22°

h(m)	E(lx)	D(m)
1	11982	0.39
2	2995	0.77
3	1331	1.16
4	749	1.55
5	479	1.94

- Optic Medium 3000K**
- E I 03.9253.40A
 - I 03.9253.14A
 - E I Dali Version
 - I 03.9253.40ADA
 - I 03.9253.14ADA

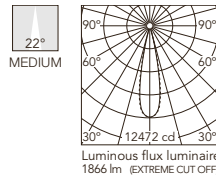

Beam Angle: 22°

h(m)	E(lx)	D(m)
1	12472	0.39
2	3118	0.78
3	1386	1.17
4	779	1.56
5	499	1.95

LIGHT SHADOW

Optic Flood

- 2700K**
- E I 03.9246.40A
 - E I 03.9246.14A
 - E I Dali Version
 - 03.9246.40ADA
 - 03.9246.14ADA

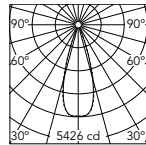

Beam Angle: 33°

h(m)	E(lx)	D(m)
1	5426	0.60
2	1357	1.19
3	603	1.79
4	339	2.39
5	217	2.99

Luminous flux luminaire
1735 lm (EXTREME CUT OFF)

- 2700K**
- 03.9245.40A
 - 03.9245.14A
 - E I Dali Version
 - 03.9245.40ADA
 - 03.9245.14ADA

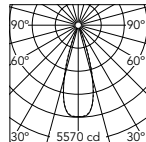

Beam Angle: 33°

h(m)	E(lx)	D(m)
1	5570	0.59
2	1392	1.18
3	619	1.78
4	348	2.37
5	223	2.96

Luminous flux luminaire
1787 lm (EXTREME CUT OFF)

- 2700K**
- 03.9247.40A
 - 03.9247.14A
 - E I Dali Version
 - 03.9247.40ADA
 - 03.9247.14ADA

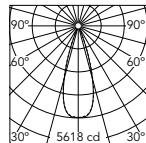

Beam Angle: 33°

h(m)	E(lx)	D(m)
1	5618	0.60
2	1405	1.19
3	624	1.79
4	351	2.38
5	225	2.98

Luminous flux luminaire
1814 lm (EXTREME CUT OFF)

- 2700K**
- 03.9248.40A
 - 03.9248.14A
 - E I Dali Version
 - 03.9248.40ADA
 - 03.9248.14ADA

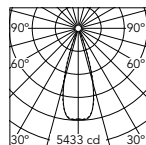

Beam Angle: 33°

h(m)	E(lx)	D(m)
1	5433	0.60
2	1358	1.20
3	604	1.79
4	340	2.39
5	217	2.99

Luminous flux luminaire
1765 lm (EXTREME CUT OFF)

Optic Flood

- 3000K**
- 03.9256.40A
 - 03.9256.14A
 - E I Dali Version
 - 03.9256.40ADA
 - 03.9256.14ADA

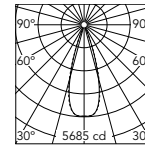

Beam Angle: 33°

h(m)	E(lx)	D(m)
1	5685	0.60
2	1421	1.19
3	632	1.79
4	355	2.39
5	227	2.99

Luminous flux luminaire
1818 lm (EXTREME CUT OFF)

- 3000K**
- 03.9255.40A
 - 03.9255.14A
 - E I Dali Version
 - 03.9255.40ADA
 - 03.9255.14ADA

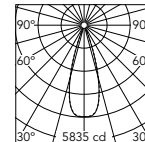

Beam Angle: 33°

h(m)	E(lx)	D(m)
1	5835	0.59
2	1459	1.18
3	648	1.78
4	365	2.37
5	233	2.96

Luminous flux luminaire
1872 lm (EXTREME CUT OFF)

- 3000K**
- 03.9257.40A
 - 03.9257.14A
 - E I Dali Version
 - 03.9257.40ADA
 - 03.9257.14ADA

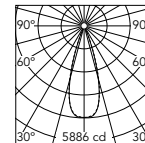

Beam Angle: 33°

h(m)	E(lx)	D(m)
1	5886	0.60
2	1472	1.19
3	654	1.79
4	368	2.38
5	235	2.98

Luminous flux luminaire
1901 lm (EXTREME CUT OFF)

- 3000K**
- 03.9258.40A
 - 03.9258.14A
 - E I Dali Version
 - 03.9258.40ADA
 - 03.9258.14ADA

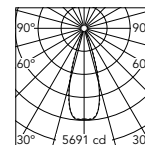

Beam Angle: 33°

h(m)	E(lx)	D(m)
1	5691	0.60
2	1423	1.20
3	632	1.79
4	356	2.39
5	228	2.99

Luminous flux luminaire
1850 lm (EXTREME CUT OFF)

Optic Wide Flood

- 2700K**
- 03.8367.40A
 - 03.8367.14A
 - E I Dali Version
 - 03.8367.40ADA
 - 03.8367.14ADA

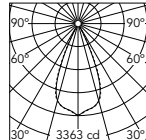

Beam Angle: 46°

h(m)	E(lx)	D(m)
1	3363	0.84
2	841	1.69
3	374	2.53
4	210	3.38
5	135	4.22

Luminous flux luminaire
1773 lm (EXTREME CUT OFF)

- 2700K**
- 03.8366.40A
 - 03.8366.14A
 - E I Dali Version
 - 03.8366.40ADA
 - 03.8366.14ADA

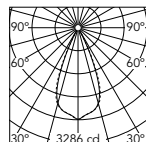

Beam Angle: 45°

h(m)	E(lx)	D(m)
1	3286	0.83
2	822	1.67
3	365	2.50
4	205	3.34
5	131	4.17

Luminous flux luminaire
1763 lm (EXTREME CUT OFF)

- 2700K**
- 03.8368.40A
 - 03.8368.14A
 - E I Dali Version
 - 03.8368.40ADA
 - 03.8368.14ADA

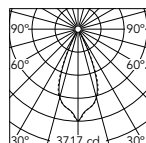

Beam Angle: 44°

h(m)	E(lx)	D(m)
1	3717	0.80
2	929	1.60
3	413	2.40
4	232	3.19
5	149	3.99

Luminous flux luminaire
1783 lm (EXTREME CUT OFF)

- 2700K**
- 03.8369.40A
 - 03.8369.14A
 - E I Dali Version
 - 03.8369.40ADA
 - 03.8369.14ADA

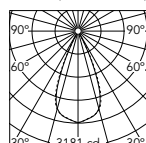

Beam Angle: 46°

h(m)	E(lx)	D(m)
1	3181	0.84
2	795	1.69
3	353	2.53
4	199	3.38
5	127	4.22

Luminous flux luminaire
1727 lm (EXTREME CUT OFF)

Optic Wide Flood

- 3000K**
- 03.8371.40A
 - 03.8371.14A
 - E I Dali Version
 - 03.8371.40ADA
 - 03.8371.14ADA

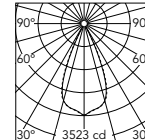

Beam Angle: 46°

h(m)	E(lx)	D(m)
1	3523	0.84
2	881	1.69
3	391	2.53
4	220	3.38
5	141	4.22

Luminous flux luminaire
1858 lm (EXTREME CUT OFF)

- 3000K**
- 03.8370.40A
 - 03.8370.14A
 - E I Dali Version
 - 03.8370.40ADA
 - 03.8370.14ADA

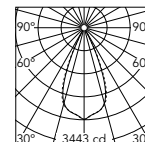

Beam Angle: 45°

h(m)	E(lx)	D(m)
1	3443	0.83
2	861	1.67
3	383	2.50
4	215	3.34
5	138	4.17

Luminous flux luminaire
1847 lm (EXTREME CUT OFF)

- 3000K**
- 03.8372.40A
 - 03.8372.14A
 - E I Dali Version
 - 03.8372.40ADA
 - 03.8372.14ADA

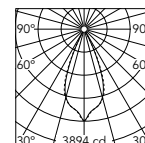

Beam Angle: 44°

h(m)	E(lx)	D(m)
1	3894	0.80
2	973	1.60
3	433	2.40
4	243	3.19
5	156	3.99

Luminous flux luminaire
1868 lm (EXTREME CUT OFF)

- 3000K**
- 03.8373.40A
 - 03.8373.14A
 - E I Dali Version
 - 03.8373.40ADA
 - 03.8373.14ADA

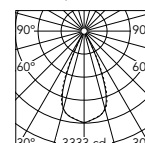

Beam Angle: 46°

h(m)	E(lx)	D(m)
1	3333	0.84
2	833	1.69
3	370	2.53
4	208	3.38
5	133	4.22

Luminous flux luminaire
1809 lm (EXTREME CUT OFF)

LIGHT SHADOW

Light Shadow Fixed No Trim 12 Spots

Light Source: Power LED 32,4W - 3240 lm - 2700K/CRI 90 / 32,4W - 3420 lm - 3000K/CRI 90

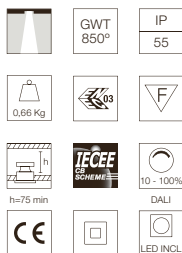
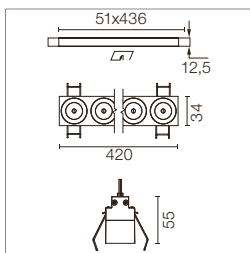

Apparecchio per illuminazione da incasso con 12 spot LED. Alimentazione remota inclusa (220-240V). Necessaria cornice di pre-installazione, da ordinare separatamente.

Recessed integrated luminaire with 12 LED lighting spots. Remote power supply included (220-240V). It requires a pre-installation frame, to be ordered separately.

E= Finitura Esterna
I= Finitura Interna

E= External Finish
I= Internal Finish

Optic Spot 2700K

E I 03.8877.40A
03.8877.14A

E I Dali & Push Version

E I 03.8877.40ADA
03.8877.14ADA

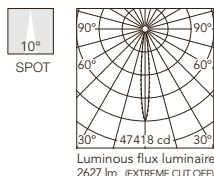

Beam Angle: 10°

h(m)	Et(k)	D(m)
1	47418	0.18
2	11854	0.36
3	5269	0.54
4	2964	0.72
5	1897	0.90

Optic Spot 3000K

E I 03.8881.40A
03.8881.14A

E I Dali & Push Version

E I 03.8881.40ADA
03.8881.14ADA

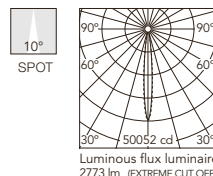

Beam Angle: 10°

h(m)	Et(k)	D(m)
1	50052	0.18
2	12513	0.36
3	5561	0.54
4	3128	0.72
5	2002	0.90

Optic Spot 2700K

E I 03.8876.40A
03.8876.14A

E I Dali & Push Version

E I 03.8876.40ADA
03.8876.14ADA

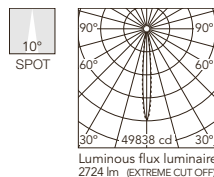

Beam Angle: 10°

h(m)	Et(k)	D(m)
1	49838	0.17
2	12459	0.35
3	5538	0.52
4	3115	0.70
5	1994	0.87

Optic Spot 3000K

E I 03.8880.40A
03.8880.14A

E I Dali & Push Version

E I 03.8880.40ADA
03.8880.14ADA

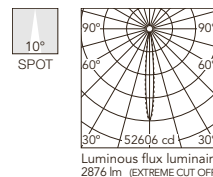

Beam Angle: 10°

h(m)	Et(k)	D(m)
1	52606	0.17
2	13152	0.35
3	5845	0.52
4	3288	0.70
5	2104	0.87

Optic Spot 2700K

E I 03.8878.40A
03.8878.14A

E I Dali & Push Version

E I 03.8878.40ADA
03.8878.14ADA

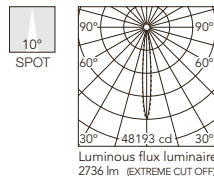

Beam Angle: 10°

h(m)	Et(k)	D(m)
1	48193	0.18
2	12048	0.36
3	5355	0.55
4	3012	0.73
5	1928	0.91

Optic Spot 3000K

E I 03.8882.40A
03.8882.14A

E I Dali & Push Version

E I 03.8882.40ADA
03.8882.14ADA

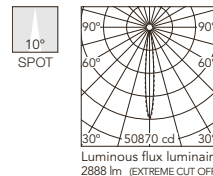

Beam Angle: 10°

h(m)	Et(k)	D(m)
1	50870	0.18
2	12718	0.36
3	5652	0.55
4	3179	0.73
5	2035	0.91

Optic Spot 2700K

E I 03.8879.40A
03.8879.14A

E I Dali & Push Version

E I 03.8879.40ADA
03.8879.14ADA

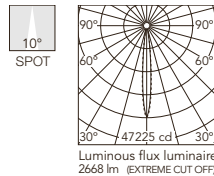

Beam Angle: 10°

h(m)	Et(k)	D(m)
1	47225	0.18
2	11806	0.36
3	5247	0.55
4	2952	0.73
5	1889	0.91

Optic Spot 3000K

E I 03.8883.40A
03.8883.14A

E I Dali & Push Version

E I 03.8883.40ADA
03.8883.14ADA

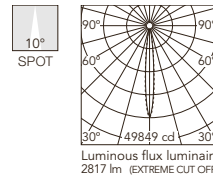

Beam Angle: 10°

h(m)	Et(k)	D(m)
1	49849	0.18
2	12462	0.36
3	5539	0.55
4	3116	0.73
5	1994	0.91

Optic Medium 2700K

E I 03.9261.40A
03.9261.14A

E I Dali & Push Version

E I 03.9261.40ADA
03.9261.14ADA

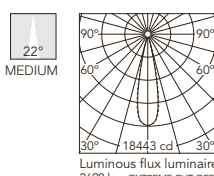

Beam Angle: 22°

h(m)	Et(k)	D(m)
1	18443	0.39
2	4611	0.78
3	2049	1.17
4	1153	1.56
5	738	1.95

Optic Medium 3000K

E I 03.9271.40A
03.9271.14A

E I Dali & Push Version

E I 03.9271.40ADA
03.9271.14ADA

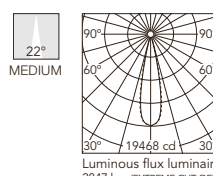

Beam Angle: 22°

h(m)	Et(k)	D(m)
1	19468	0.39
2	4867	0.78
3	2163	1.17
4	1217	1.56
5	779	1.95

Optic Medium 2700K

E I 03.9260.40A
03.9260.14A

E I Dali & Push Version

E I 03.9260.40ADA
03.9260.14ADA

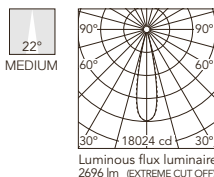

Beam Angle: 22°

h(m)	Et(k)	D(m)
1	18024	0.39
2	4506	0.78
3	2003	1.17
4	1126	1.56
5	721	1.95

Optic Medium 3000K

E I 03.9270.40A
03.9270.14A

E I Dali & Push Version

E I 03.9270.40ADA
03.9270.14ADA

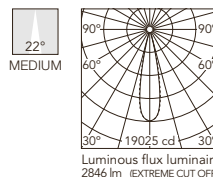

Beam Angle: 22°

h(m)	Et(k)	D(m)
1	19025	0.39
2	4756	0.78
3	2114	1.17
4	1189	1.56
5	761	1.95

Optic Medium 2700K

E I 03.9262.40A
03.9262.14A

E I Dali & Push Version

E I 03.9262.40ADA
03.9262.14ADA

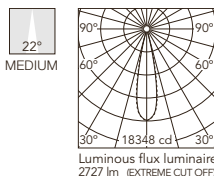

Beam Angle: 22°

h(m)	Et(k)	D(m)
1	18348	0.39
2	4587	0.77
3	2039	1.16
4	1147	1.55
5	734	1.94

Optic Medium 3000K

E I 03.9272.40A
03.9272.14A

E I Dali & Push Version

E I 03.9272.40ADA
03.9272.14ADA

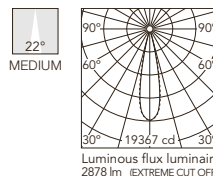

Beam Angle: 22°

h(m)	Et(k)	D(m)
1	19367	0.39
2	4842	0.77
3	2152	1.16
4	1210	1.55
5	775	1.94

Optic Medium 2700K

E I 03.9263.40A
03.9263.14A

E I Dali & Push Version

E I 03.9263.40ADA
03.9263.14ADA

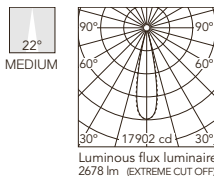

Beam Angle: 22°

h(m)	Et(k)	D(m)
1	17902	0.39
2	4476	0.78
3	1989	1.17
4	1119	1.56
5	716	1.95

Optic Medium 3000K

E I 03.9273.40A
03.9273.14A

E I Dali & Push Version

E I 03.9273.40ADA
03.9273.14ADA

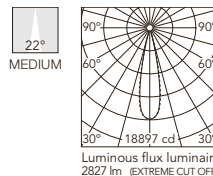

Beam Angle: 22°

h(m)	Et(k)	D(m)
1	18897	0.39
2	4724	0.78
3	2100	1.17
4	1181	1.56
5	756	1.95

LIGHT SHADOW

Optic Flood
2700K
E I 03.9266.40A
03.9266.14A
E I Dali & Push Version
03.9266.40ADA
03.9266.14ADA

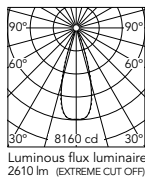

Beam Angle: 33°
h(m) E(lx) D(m)
1 8160 0.60
2 2040 1.19
3 907 1.79
4 510 2.39
5 326 2.99

Luminous flux luminaire
2610 lm (EXTREME CUT OFF)

Optic Flood
3000K
E I 03.9276.40A
03.9276.14A
E I Dali & Push Version
03.9276.40ADA
03.9276.14ADA

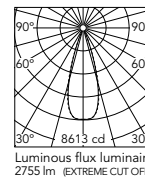

Beam Angle: 33°
h(m) E(lx) D(m)
1 8613 0.60
2 2153 1.19
3 957 1.79
4 538 2.39
5 345 2.99

Luminous flux luminaire
2755 lm (EXTREME CUT OFF)

E I **2700K**
03.9265.40A
03.9265.14A
E I Dali & Push Version
03.9265.40ADA
03.9265.14ADA

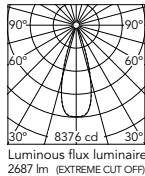

Beam Angle: 33°
h(m) E(lx) D(m)
1 8376 0.59
2 2094 1.18
3 931 1.78
4 523 2.37
5 335 2.96

Luminous flux luminaire
2687 lm (EXTREME CUT OFF)

E I **3000K**
03.9275.40A
03.9275.14A
E I Dali & Push Version
03.9275.40ADA
03.9275.14ADA

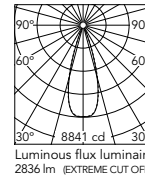

Beam Angle: 33°
h(m) E(lx) D(m)
1 8841 0.59
2 2210 1.18
3 982 1.78
4 553 2.37
5 354 2.96

Luminous flux luminaire
2836 lm (EXTREME CUT OFF)

E I **2700K**
03.9267.40A
03.9267.14A
E I Dali & Push Version
03.9267.40ADA
03.9267.14ADA

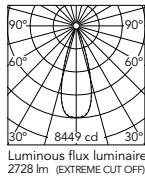

Beam Angle: 33°
h(m) E(lx) D(m)
1 8449 0.60
2 2112 1.19
3 939 1.79
4 528 2.38
5 338 2.98

Luminous flux luminaire
2728 lm (EXTREME CUT OFF)

E I **3000K**
03.9277.40A
03.9277.14A
E I Dali & Push Version
03.9277.40ADA
03.9277.14ADA

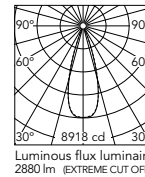

Beam Angle: 33°
h(m) E(lx) D(m)
1 8918 0.60
2 2230 1.19
3 991 1.79
4 557 2.38
5 357 2.98

Luminous flux luminaire
2880 lm (EXTREME CUT OFF)

E I **2700K**
03.9268.40A
03.9268.14A
E I Dali & Push Version
03.9268.40ADA
03.9268.14ADA

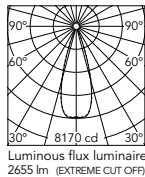

Beam Angle: 33°
h(m) E(lx) D(m)
1 8170 0.60
2 2042 1.20
3 908 1.79
4 511 2.39
5 327 2.99

Luminous flux luminaire
2655 lm (EXTREME CUT OFF)

E I **3000K**
03.9278.40A
03.9278.14A
E I Dali & Push Version
03.9278.40ADA
03.9278.14ADA

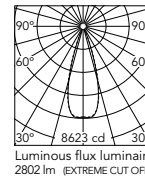

Beam Angle: 33°
h(m) E(lx) D(m)
1 8623 0.60
2 2156 1.20
3 958 1.79
4 539 2.39
5 345 2.99

Luminous flux luminaire
2802 lm (EXTREME CUT OFF)

Optic Wide Flood
2700K
E I 03.8375.40A
03.8375.14A
E I Dali & Push Version
03.8375.40ADA
03.8375.14ADA

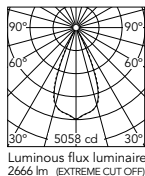

Beam Angle: 46°
h(m) E(lx) D(m)
1 5058 0.84
2 1264 1.69
3 562 2.53
4 316 3.38
5 202 4.22

Luminous flux luminaire
2666 lm (EXTREME CUT OFF)

Optic Wide Flood
3000K
E I 03.8379.40A
03.8379.14A
E I Dali & Push Version
03.8379.40ADA
03.8379.14ADA

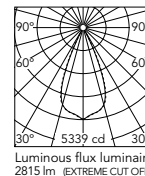

Beam Angle: 46°
h(m) E(lx) D(m)
1 5339 0.84
2 1335 1.69
3 593 2.53
4 334 3.38
5 214 4.22

Luminous flux luminaire
2815 lm (EXTREME CUT OFF)

E I **2700K**
03.8374.40A
03.8374.14A
E I Dali & Push Version
03.8374.40ADA
03.8374.14ADA

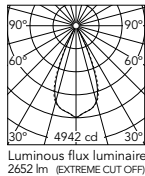

Beam Angle: 45°
h(m) E(lx) D(m)
1 4942 0.83
2 1235 1.67
3 549 2.50
4 309 3.34
5 198 4.17

Luminous flux luminaire
2652 lm (EXTREME CUT OFF)

E I **3000K**
03.8378.40A
03.8378.14A
E I Dali & Push Version
03.8378.40ADA
03.8378.14ADA

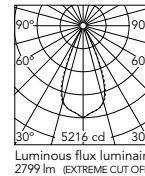

Beam Angle: 45°
h(m) E(lx) D(m)
1 5216 0.83
2 1304 1.67
3 580 2.50
4 326 3.34
5 209 4.17

Luminous flux luminaire
2799 lm (EXTREME CUT OFF)

E I **2700K**
03.8376.40A
03.8376.14A
E I Dali & Push Version
03.8376.40ADA
03.8376.14ADA

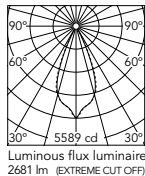

Beam Angle: 44°
h(m) E(lx) D(m)
1 5589 0.80
2 1397 1.60
3 621 2.40
4 349 3.19
5 224 3.99

Luminous flux luminaire
2681 lm (EXTREME CUT OFF)

E I **3000K**
03.8380.40A
03.8380.14A
E I Dali & Push Version
03.8380.40ADA
03.8380.14ADA

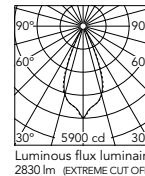

Beam Angle: 44°
h(m) E(lx) D(m)
1 5900 0.80
2 1475 1.60
3 656 2.40
4 369 3.19
5 236 3.99

Luminous flux luminaire
2830 lm (EXTREME CUT OFF)

E I **2700K**
03.8377.40A
03.8377.14A
E I Dali & Push Version
03.8377.40ADA
03.8377.14ADA

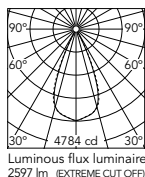

Beam Angle: 46°
h(m) E(lx) D(m)
1 4784 0.84
2 1196 1.69
3 532 2.53
4 299 3.38
5 191 4.22

Luminous flux luminaire
2597 lm (EXTREME CUT OFF)

E I **3000K**
03.8381.40A
03.8381.14A
E I Dali & Push Version
03.8381.40ADA
03.8381.14ADA

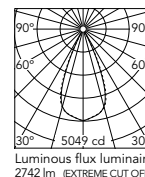

Beam Angle: 46°
h(m) E(lx) D(m)
1 5049 0.84
2 1262 1.69
3 561 2.53
4 316 3.38
5 202 4.22

Luminous flux luminaire
2742 lm (EXTREME CUT OFF)

LIGHT SHADOW

Light Shadow Adjustable Trim 2 Spots

Light Source: Power LED 5,4W - 540 lm - 2700K/CRI 90 / 5,4W - 570 lm - 3000K/CRI 90

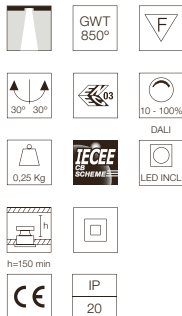
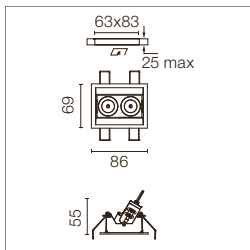

Apparecchio per illuminazione da incasso con 2 spot LED. Alimentazione remota inclusa (220-240V). Non richiede cornice di pre-installazione.

Recessed integrated luminaire with 2 LED lighting spots. Remote power supply included (220-240V). Pre-Installation frame not required.

E= Finitura Esterna
I= Finitura Interna

E= External Finish
I= Internal Finish

- Optic Spot 2700K**
- E I 03.8885.40A
 - I 03.8885.14A
 - E I Dali Version
 - I 03.8885.40ADA
 - I 03.8885.14ADA

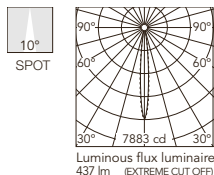

Beam Angle: 10°
h(m) E(lx) D(m)
1 7883 0.18
2 1971 0.36
3 876 0.54
4 493 0.72
5 315 0.90

- Optic Spot 3000K**
- E I 03.8889.40A
 - I 03.8889.14A
 - E I Dali Version
 - I 03.8889.40ADA
 - I 03.8889.14ADA

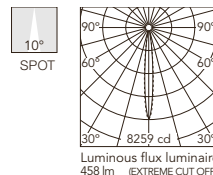

Beam Angle: 10°
h(m) E(lx) D(m)
1 8259 0.18
2 2065 0.36
3 918 0.54
4 516 0.72
5 330 0.90

- 2700K**
- E I 03.8884.40A
 - I 03.8884.14A
 - E I Dali Version
 - I 03.8884.40ADA
 - I 03.8884.14ADA

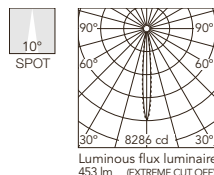

Beam Angle: 10°
h(m) E(lx) D(m)
1 8286 0.17
2 2071 0.35
3 921 0.52
4 518 0.70
5 331 0.87

- 3000K**
- E I 03.8888.40A
 - I 03.8888.14A
 - E I Dali Version
 - I 03.8888.40ADA
 - I 03.8888.14ADA

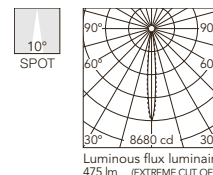

Beam Angle: 10°
h(m) E(lx) D(m)
1 8680 0.17
2 2170 0.35
3 964 0.52
4 543 0.70
5 347 0.87

- 2700K**
- E I 03.8886.40A
 - I 03.8886.14A
 - E I Dali Version
 - I 03.8886.40ADA
 - I 03.8886.14ADA

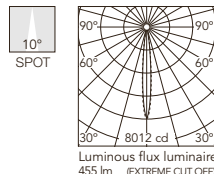

Beam Angle: 10°
h(m) E(lx) D(m)
1 8012 0.18
2 2003 0.36
3 890 0.55
4 501 0.73
5 320 0.91

- 3000K**
- E I 03.8890.40A
 - I 03.8890.14A
 - E I Dali Version
 - I 03.8890.40ADA
 - I 03.8890.14ADA

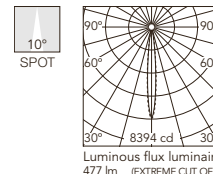

Beam Angle: 10°
h(m) E(lx) D(m)
1 8394 0.18
2 2098 0.36
3 933 0.55
4 525 0.73
5 336 0.91

- 2700K**
- E I 03.8887.40A
 - I 03.8887.14A
 - E I Dali Version
 - I 03.8887.40ADA
 - I 03.8887.14ADA

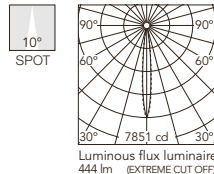

Beam Angle: 10°
h(m) E(lx) D(m)
1 7851 0.18
2 1963 0.36
3 872 0.55
4 491 0.73
5 314 0.91

- 3000K**
- E I 03.8891.40A
 - I 03.8891.14A
 - E I Dali Version
 - I 03.8891.40ADA
 - I 03.8891.14ADA

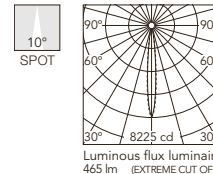

Beam Angle: 10°
h(m) E(lx) D(m)
1 8225 0.18
2 2056 0.36
3 914 0.55
4 514 0.73
5 329 0.91

- Optic Medium 2700K**
- E I 03.9301.40A
 - I 03.9301.14A
 - E I Dali Version
 - I 03.9301.40ADA
 - I 03.9301.14ADA

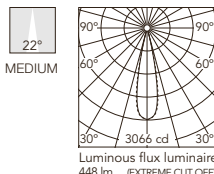

Beam Angle: 22°
h(m) E(lx) D(m)
1 3066 0.39
2 767 0.78
3 341 1.17
4 192 1.56
5 123 1.95

- Optic Medium 3000K**
- E I 03.9311.40A
 - I 03.9311.14A
 - E I Dali Version
 - I 03.9311.40ADA
 - I 03.9311.14ADA

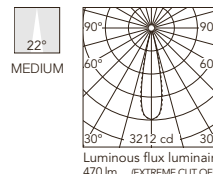

Beam Angle: 22°
h(m) E(lx) D(m)
1 3212 0.39
2 803 0.78
3 357 1.17
4 201 1.56
5 128 1.95

- 2700K**
- E I 03.9300.40A
 - I 03.9300.14A
 - E I Dali Version
 - I 03.9300.40ADA
 - I 03.9300.14ADA

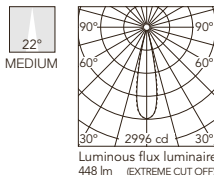

Beam Angle: 22°
h(m) E(lx) D(m)
1 2996 0.39
2 749 0.78
3 333 1.17
4 187 1.56
5 120 1.95

- 3000K**
- E I 03.9310.40A
 - I 03.9310.14A
 - E I Dali Version
 - I 03.9310.40ADA
 - I 03.9310.14ADA

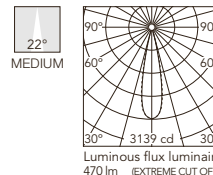

Beam Angle: 22°
h(m) E(lx) D(m)
1 3139 0.39
2 785 0.78
3 349 1.17
4 196 1.56
5 126 1.95

- 2700K**
- E I 03.9302.40A
 - I 03.9302.14A
 - E I Dali Version
 - I 03.9302.40ADA
 - I 03.9302.14ADA

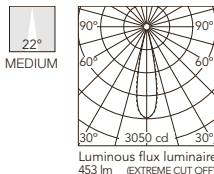

Beam Angle: 22°
h(m) E(lx) D(m)
1 3050 0.39
2 763 0.77
3 339 1.16
4 191 1.55
5 122 1.94

- 3000K**
- E I 03.9312.40A
 - I 03.9312.14A
 - E I Dali Version
 - I 03.9312.40ADA
 - I 03.9312.14ADA

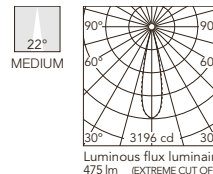

Beam Angle: 22°
h(m) E(lx) D(m)
1 3196 0.39
2 799 0.77
3 355 1.16
4 200 1.55
5 128 1.94

- 2700K**
- E I 03.9303.40A
 - I 03.9303.14A
 - E I Dali Version
 - I 03.9303.40ADA
 - I 03.9303.14ADA

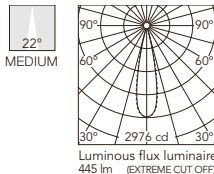

Beam Angle: 22°
h(m) E(lx) D(m)
1 2976 0.39
2 744 0.78
3 331 1.17
4 186 1.56
5 119 1.95

- 3000K**
- E I 03.9313.40A
 - I 03.9313.14A
 - E I Dali Version
 - I 03.9313.40ADA
 - I 03.9313.14ADA

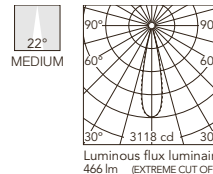

Beam Angle: 22°
h(m) E(lx) D(m)
1 3118 0.39
2 779 0.78
3 346 1.17
4 195 1.56
5 125 1.95

LIGHT SHADOW

Optic Flood 2700K

E I 03.9306.40A
03.9306.14A

E I Dali Version

03.9306.40ADA
03.9306.14ADA

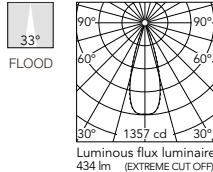

Beam Angle: 33°

h(m)	E(lx)	D(m)
1	1357	0.60
2	339	1.19
3	151	1.79
4	85	2.39
5	54	2.99

Luminous flux luminaire
434 lm (EXTREME CUT OFF)

Optic Flood 3000K

E I 03.9316.40A
03.9316.14A

E I Dali Version

03.9316.40ADA
03.9316.14ADA

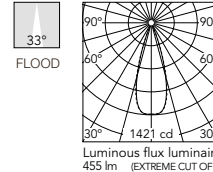

Beam Angle: 33°

h(m)	E(lx)	D(m)
1	1421	0.60
2	355	1.19
3	158	1.79
4	89	2.39
5	57	2.99

Luminous flux luminaire
455 lm (EXTREME CUT OFF)

Optic Flood 2700K

E I 03.9305.40A
03.9305.14A

E I Dali Version

03.9305.40ADA
03.9305.14ADA

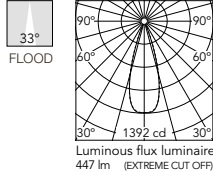

Beam Angle: 33°

h(m)	E(lx)	D(m)
1	1392	0.59
2	348	1.18
3	155	1.78
4	87	2.37
5	56	2.96

Luminous flux luminaire
447 lm (EXTREME CUT OFF)

Optic Flood 3000K

E I 03.9315.40A
03.9315.14A

E I Dali Version

03.9315.40ADA
03.9315.14ADA

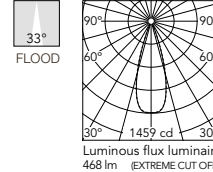

Beam Angle: 33°

h(m)	E(lx)	D(m)
1	1459	0.59
2	365	1.18
3	162	1.78
4	91	2.37
5	58	2.96

Luminous flux luminaire
468 lm (EXTREME CUT OFF)

Optic Flood 2700K

E I 03.9307.40A
03.9307.14A

E I Dali Version

03.9307.40ADA
03.9307.14ADA

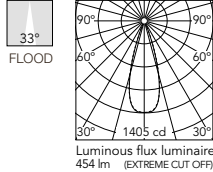

Beam Angle: 33°

h(m)	E(lx)	D(m)
1	1405	0.60
2	351	1.19
3	156	1.79
4	88	2.38
5	56	2.98

Luminous flux luminaire
454 lm (EXTREME CUT OFF)

Optic Flood 3000K

E I 03.9317.40A
03.9317.14A

E I Dali Version

03.9317.40ADA
03.9317.14ADA

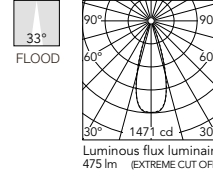

Beam Angle: 33°

h(m)	E(lx)	D(m)
1	1471	0.60
2	368	1.19
3	163	1.79
4	92	2.38
5	59	2.98

Luminous flux luminaire
475 lm (EXTREME CUT OFF)

Optic Flood 2700K

E I 03.9308.40A
03.9308.14A

E I Dali Version

03.9308.40ADA
03.9308.14ADA

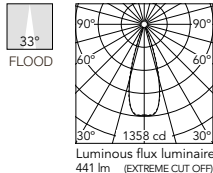

Beam Angle: 33°

h(m)	E(lx)	D(m)
1	1358	0.60
2	340	1.20
3	151	1.79
4	85	2.39
5	54	2.99

Luminous flux luminaire
441 lm (EXTREME CUT OFF)

Optic Flood 3000K

E I 03.9318.40A
03.9318.14A

E I Dali Version

03.9318.40ADA
03.9318.14ADA

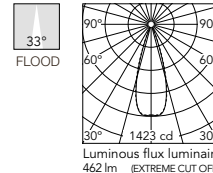

Beam Angle: 33°

h(m)	E(lx)	D(m)
1	1423	0.60
2	356	1.20
3	158	1.79
4	89	2.39
5	57	2.99

Luminous flux luminaire
462 lm (EXTREME CUT OFF)

Optic Wide Flood 2700K

E I 03.7301.40A
03.7301.14A

E I Dali Version

03.7301.40ADA
03.7301.14ADA

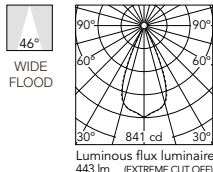

Beam Angle: 46°

h(m)	E(lx)	D(m)
1	841	0.84
2	210	1.69
3	93	2.53
4	53	3.38
5	34	4.22

Luminous flux luminaire
443 lm (EXTREME CUT OFF)

Optic Wide Flood 3000K

E I 03.7305.40A
03.7305.14A

E I Dali Version

03.7305.40ADA
03.7305.14ADA

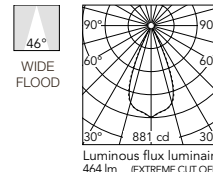

Beam Angle: 46°

h(m)	E(lx)	D(m)
1	881	0.84
2	220	1.69
3	98	2.53
4	55	3.38
5	35	4.22

Luminous flux luminaire
464 lm (EXTREME CUT OFF)

Optic Wide Flood 2700K

E I 03.7300.40A
03.7300.14A

E I Dali Version

03.7300.40ADA
03.7300.14ADA

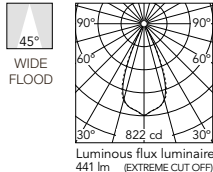

Beam Angle: 45°

h(m)	E(lx)	D(m)
1	822	0.83
2	205	1.67
3	91	2.50
4	51	3.34
5	33	4.17

Luminous flux luminaire
441 lm (EXTREME CUT OFF)

Optic Wide Flood 3000K

E I 03.7304.40A
03.7304.14A

E I Dali Version

03.7304.40ADA
03.7304.14ADA

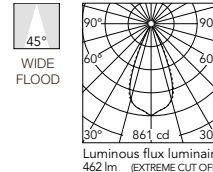

Beam Angle: 45°

h(m)	E(lx)	D(m)
1	861	0.83
2	215	1.67
3	96	2.50
4	54	3.34
5	34	4.17

Luminous flux luminaire
462 lm (EXTREME CUT OFF)

Optic Wide Flood 2700K

E I 03.7302.40A
03.7302.14A

E I Dali Version

03.7302.40ADA
03.7302.14ADA

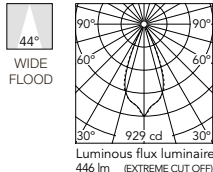

Beam Angle: 44°

h(m)	E(lx)	D(m)
1	929	0.80
2	232	1.60
3	103	2.40
4	58	3.19
5	37	3.99

Luminous flux luminaire
446 lm (EXTREME CUT OFF)

Optic Wide Flood 3000K

E I 03.7306.40A
03.7306.14A

E I Dali Version

03.7306.40ADA
03.7306.14ADA

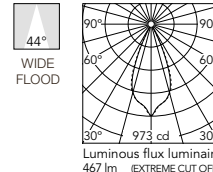

Beam Angle: 44°

h(m)	E(lx)	D(m)
1	973	0.80
2	243	1.60
3	108	2.40
4	61	3.19
5	39	3.99

Luminous flux luminaire
467 lm (EXTREME CUT OFF)

Optic Wide Flood 2700K

E I 03.7303.40A
03.7303.14A

E I Dali Version

03.7303.40ADA
03.7303.14ADA

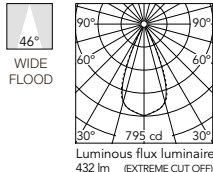

Beam Angle: 46°

h(m)	E(lx)	D(m)
1	795	0.84
2	199	1.69
3	88	2.53
4	50	3.38
5	32	4.22

Luminous flux luminaire
432 lm (EXTREME CUT OFF)

Optic Wide Flood 3000K

E I 03.7307.40A
03.7307.14A

E I Dali Version

03.7307.40ADA
03.7307.14ADA

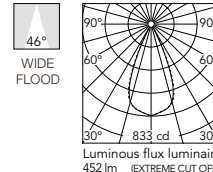

Beam Angle: 46°

h(m)	E(lx)	D(m)
1	833	0.84
2	208	1.69
3	93	2.53
4	52	3.38
5	33	4.22

Luminous flux luminaire
452 lm (EXTREME CUT OFF)

LIGHT SHADOW

Light Shadow Adjustable Trim 4 Spots

Light Source: Power LED 10,8W - 1080 lm - 2700K/CRI 90 / 10,8W - 1140lm - 3000K/CRI 90

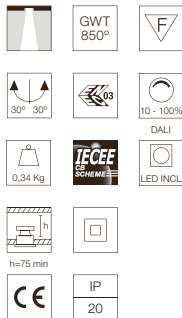
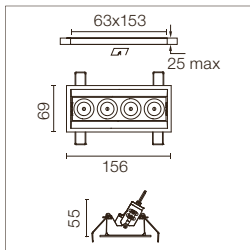

Apparecchio per illuminazione da incasso con 4 spot LED. Alimentazione remota inclusa (220-240V). Non richiede cornice di installa pre-installazione.

Recessed integrated luminaire with 4 LED lighting spots. Remote power supply included (220-240V). Pre-Installation frame not required.

E= Finitura Esterna
I= Finitura Interna

E= External Finish
I= Internal Finish

Optic Spot

- 2700K**
- E I 03.8893.40A
 - I 03.8893.14A
 - E I Dali Version
 - I 03.8893.40ADA
 - I 03.8893.14ADA

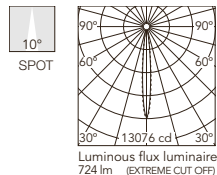

Beam Angle: 10°

h(m)	E(lx)	D(m)
1	1307,6	0,18
2	326,9	0,36
3	145,3	0,54
4	81,7	0,72
5	52,3	0,90

Luminous flux luminaire 724 lm (EXTREME CUT OFF)

Optic Spot

- 3000K**
- E I 03.8897.40A
 - I 03.8897.14A
 - E I Dali Version
 - I 03.8897.40ADA
 - I 03.8897.14ADA

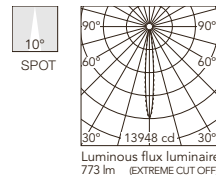

Beam Angle: 10°

h(m)	E(lx)	D(m)
1	1394,8	0,18
2	348,7	0,36
3	155,0	0,54
4	87,2	0,72
5	55,8	0,90

Luminous flux luminaire 773 lm (EXTREME CUT OFF)

- 2700K**
- E I 03.8892.40A
 - I 03.8892.14A
 - E I Dali Version
 - I 03.8892.40ADA
 - I 03.8892.14ADA

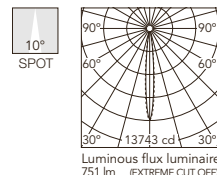

Beam Angle: 10°

h(m)	E(lx)	D(m)
1	1374,3	0,17
2	343,6	0,35
3	152,7	0,52
4	85,9	0,70
5	55,0	0,87

Luminous flux luminaire 751 lm (EXTREME CUT OFF)

- 3000K**
- E I 03.8896.40A
 - I 03.8896.14A
 - E I Dali Version
 - I 03.8896.40ADA
 - I 03.8896.14ADA

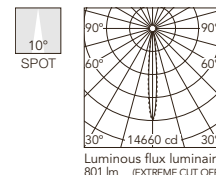

Beam Angle: 10°

h(m)	E(lx)	D(m)
1	1466,0	0,17
2	366,5	0,35
3	162,9	0,52
4	91,6	0,70
5	58,6	0,87

Luminous flux luminaire 801 lm (EXTREME CUT OFF)

- 2700K**
- E I 03.8894.40A
 - I 03.8894.14A
 - E I Dali Version
 - I 03.8894.40ADA
 - I 03.8894.14ADA

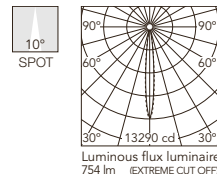

Beam Angle: 10°

h(m)	E(lx)	D(m)
1	1329,0	0,18
2	332,2	0,36
3	147,7	0,55
4	83,1	0,73
5	53,2	0,91

Luminous flux luminaire 754 lm (EXTREME CUT OFF)

- 3000K**
- E I 03.8898.40A
 - I 03.8898.14A
 - E I Dali Version
 - I 03.8898.40ADA
 - I 03.8898.14ADA

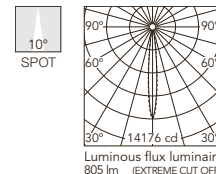

Beam Angle: 10°

h(m)	E(lx)	D(m)
1	1417,6	0,18
2	354,4	0,36
3	157,5	0,55
4	88,6	0,73
5	56,7	0,91

Luminous flux luminaire 805 lm (EXTREME CUT OFF)

- 2700K**
- E I 03.8895.40A
 - I 03.8895.14A
 - E I Dali Version
 - I 03.8895.40ADA
 - I 03.8895.14ADA

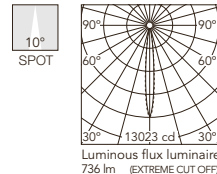

Beam Angle: 10°

h(m)	E(lx)	D(m)
1	1302,3	0,18
2	325,6	0,36
3	144,7	0,55
4	81,4	0,73
5	52,1	0,91

Luminous flux luminaire 736 lm (EXTREME CUT OFF)

- 3000K**
- E I 03.8899.40A
 - I 03.8899.14A
 - E I Dali Version
 - I 03.8899.40ADA
 - I 03.8899.14ADA

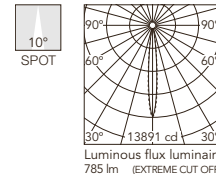

Beam Angle: 10°

h(m)	E(lx)	D(m)
1	1389,1	0,18
2	347,3	0,36
3	154,3	0,55
4	86,8	0,73
5	55,6	0,91

Luminous flux luminaire 785 lm (EXTREME CUT OFF)

Optic Medium

- 2700K**
- E I 03.9321.40A
 - I 03.9321.14A
 - E I Dali Version
 - I 03.9321.40ADA
 - I 03.9321.14ADA

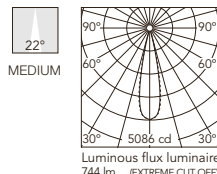

Beam Angle: 22°

h(m)	E(lx)	D(m)
1	508,6	0,39
2	127,2	0,78
3	56,5	1,17
4	31,8	1,56
5	20,3	1,95

Luminous flux luminaire 744 lm (EXTREME CUT OFF)

Optic Medium

- 3000K**
- E I 03.9331.40A
 - I 03.9331.14A
 - E I Dali Version
 - I 03.9331.40ADA
 - I 03.9331.14ADA

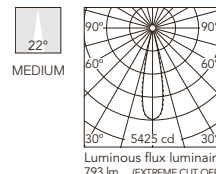

Beam Angle: 22°

h(m)	E(lx)	D(m)
1	542,5	0,39
2	135,6	0,78
3	60,3	1,17
4	33,9	1,56
5	21,7	1,95

Luminous flux luminaire 793 lm (EXTREME CUT OFF)

- 2700K**
- E I 03.9320.40A
 - I 03.9320.14A
 - E I Dali Version
 - I 03.9320.40ADA
 - I 03.9320.14ADA

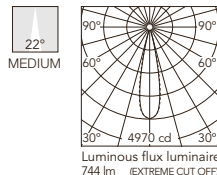

Beam Angle: 22°

h(m)	E(lx)	D(m)
1	497,0	0,39
2	124,3	0,78
3	55,2	1,17
4	31,1	1,56
5	19,9	1,95

Luminous flux luminaire 744 lm (EXTREME CUT OFF)

- 3000K**
- E I 03.9330.40A
 - I 03.9330.14A
 - E I Dali Version
 - I 03.9330.40ADA
 - I 03.9330.14ADA

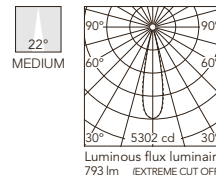

Beam Angle: 22°

h(m)	E(lx)	D(m)
1	530,2	0,39
2	132,5	0,78
3	58,9	1,17
4	33,1	1,56
5	21,2	1,95

Luminous flux luminaire 793 lm (EXTREME CUT OFF)

- 2700K**
- E I 03.9322.40A
 - I 03.9322.14A
 - E I Dali Version
 - I 03.9322.40ADA
 - I 03.9322.14ADA

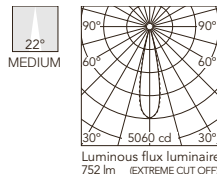

Beam Angle: 22°

h(m)	E(lx)	D(m)
1	506,0	0,39
2	126,5	0,77
3	56,2	1,16
4	31,6	1,55
5	20,2	1,94

Luminous flux luminaire 752 lm (EXTREME CUT OFF)

- 3000K**
- E I 03.9332.40A
 - I 03.9332.14A
 - E I Dali Version
 - I 03.9332.40ADA
 - I 03.9332.14ADA

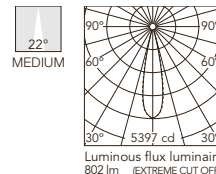

Beam Angle: 22°

h(m)	E(lx)	D(m)
1	539,7	0,39
2	134,9	0,77
3	60,0	1,16
4	33,7	1,55
5	21,6	1,94

Luminous flux luminaire 802 lm (EXTREME CUT OFF)

- 2700K**
- E I 03.9323.40A
 - I 03.9323.14A
 - E I Dali Version
 - I 03.9323.40ADA
 - I 03.9323.14ADA

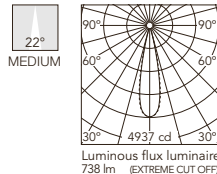

Beam Angle: 22°

h(m)	E(lx)	D(m)
1	493,7	0,39
2	123,4	0,78
3	54,9	1,17
4	30,9	1,56
5	19,7	1,95

Luminous flux luminaire 738 lm (EXTREME CUT OFF)

- 3000K**
- E I 03.9333.40A
 - I 03.9333.14A
 - E I Dali Version
 - I 03.9333.40ADA
 - I 03.9333.14ADA

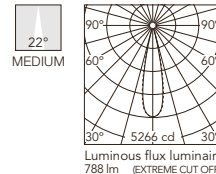

Beam Angle: 22°

h(m)	E(lx)	D(m)
1	526,6	0,39
2	131,6	0,78
3	58,5	1,17
4	32,9	1,56
5	21,1	1,95

Luminous flux luminaire 788 lm (EXTREME CUT OFF)

LIGHT SHADOW

Optic Flood
2700K

E I 03.9326.40A
03.9326.14A

E I Dali Version
03.9326.40ADA
03.9326.14ADA

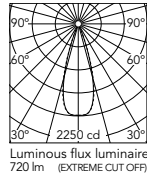

Beam Angle: 33°

h(m)	E(lx)	D(m)
1	2250	0.60
2	563	1.19
3	250	1.79
4	141	2.39
5	90	2.99

Luminous flux luminaire
720 lm (EXTREME CUT OFF)

Optic Flood
3000K

E I 03.9336.40A
03.9336.14A

E I Dali Version
03.9336.40ADA
03.9336.14ADA

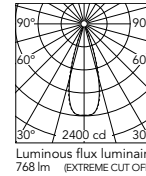

Beam Angle: 33°

h(m)	E(lx)	D(m)
1	2400	0.60
2	600	1.19
3	267	1.79
4	150	2.39
5	96	2.99

Luminous flux luminaire
768 lm (EXTREME CUT OFF)

Optic Flood
2700K

E I 03.9325.40A
03.9325.14A

E I Dali Version
03.9325.40ADA
03.9325.14ADA

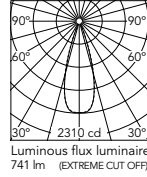

Beam Angle: 33°

h(m)	E(lx)	D(m)
1	2310	0.59
2	577	1.18
3	257	1.78
4	144	2.37
5	92	2.96

Luminous flux luminaire
741 lm (EXTREME CUT OFF)

Optic Flood
3000K

E I 03.9335.40A
03.9335.14A

E I Dali Version
03.9335.40ADA
03.9335.14ADA

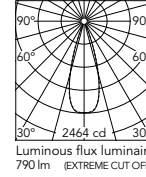

Beam Angle: 33°

h(m)	E(lx)	D(m)
1	2464	0.59
2	616	1.18
3	274	1.78
4	154	2.37
5	99	2.96

Luminous flux luminaire
790 lm (EXTREME CUT OFF)

Optic Flood
2700K

E I 03.9327.40A
03.9327.14A

E I Dali Version
03.9327.40ADA
03.9327.14ADA

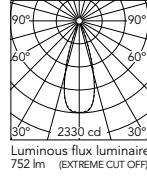

Beam Angle: 33°

h(m)	E(lx)	D(m)
1	2330	0.60
2	582	1.19
3	259	1.79
4	146	2.38
5	93	2.98

Luminous flux luminaire
752 lm (EXTREME CUT OFF)

Optic Flood
3000K

E I 03.9337.40A
03.9337.14A

E I Dali Version
03.9337.40ADA
03.9337.14ADA

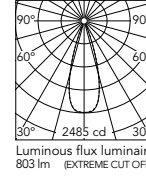

Beam Angle: 33°

h(m)	E(lx)	D(m)
1	2485	0.60
2	621	1.19
3	276	1.79
4	155	2.38
5	99	2.98

Luminous flux luminaire
803 lm (EXTREME CUT OFF)

Optic Flood
2700K

E I 03.9328.40A
03.9328.14A

E I Dali Version
03.9328.40ADA
03.9328.14ADA

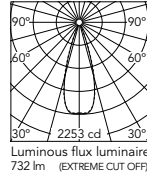

Beam Angle: 33°

h(m)	E(lx)	D(m)
1	2253	0.60
2	563	1.20
3	250	1.79
4	141	2.39
5	90	2.99

Luminous flux luminaire
732 lm (EXTREME CUT OFF)

Optic Flood
3000K

E I 03.9338.40A
03.9338.14A

E I Dali Version
03.9338.40ADA
03.9338.14ADA

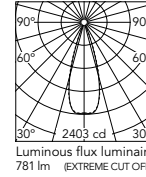

Beam Angle: 33°

h(m)	E(lx)	D(m)
1	2403	0.60
2	601	1.20
3	267	1.79
4	150	2.39
5	96	2.99

Luminous flux luminaire
781 lm (EXTREME CUT OFF)

Optic Wide Flood
2700K

E I 03.7309.40A
03.7309.14A

E I Dali Version
03.7309.40ADA
03.7309.14ADA

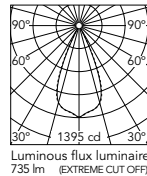

Beam Angle: 46°

h(m)	E(lx)	D(m)
1	1395	0.84
2	349	1.69
3	155	2.53
4	87	3.38
5	56	4.22

Luminous flux luminaire
735 lm (EXTREME CUT OFF)

Optic Wide Flood
3000K

E I 03.7313.40A
03.7313.14A

E I Dali Version
03.7313.40ADA
03.7313.14ADA

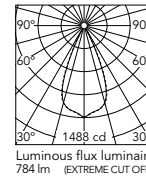

Beam Angle: 46°

h(m)	E(lx)	D(m)
1	1488	0.84
2	372	1.69
3	165	2.53
4	93	3.38
5	60	4.22

Luminous flux luminaire
784 lm (EXTREME CUT OFF)

Optic Wide Flood
2700K

E I 03.7308.40A
03.7308.14A

E I Dali Version
03.7308.40ADA
03.7308.14ADA

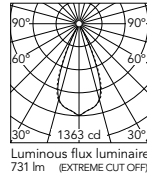

Beam Angle: 45°

h(m)	E(lx)	D(m)
1	1363	0.83
2	341	1.67
3	151	2.50
4	85	3.34
5	55	4.17

Luminous flux luminaire
731 lm (EXTREME CUT OFF)

Optic Wide Flood
3000K

E I 03.7312.40A
03.7312.14A

E I Dali Version
03.7312.40ADA
03.7312.14ADA

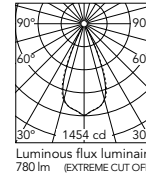

Beam Angle: 45°

h(m)	E(lx)	D(m)
1	1454	0.83
2	363	1.67
3	162	2.50
4	91	3.34
5	58	4.17

Luminous flux luminaire
780 lm (EXTREME CUT OFF)

Optic Wide Flood
2700K

E I 03.7310.40A
03.7310.14A

E I Dali Version
03.7310.40ADA
03.7310.14ADA

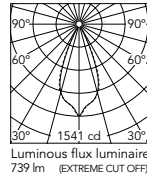

Beam Angle: 44°

h(m)	E(lx)	D(m)
1	1541	0.80
2	385	1.60
3	171	2.40
4	96	3.19
5	62	3.99

Luminous flux luminaire
739 lm (EXTREME CUT OFF)

Optic Wide Flood
3000K

E I 03.7314.40A
03.7314.14A

E I Dali Version
03.7314.40ADA
03.7314.14ADA

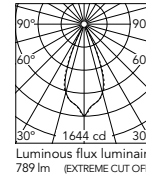

Beam Angle: 44°

h(m)	E(lx)	D(m)
1	1644	0.80
2	411	1.60
3	183	2.40
4	103	3.19
5	66	3.99

Luminous flux luminaire
789 lm (EXTREME CUT OFF)

Optic Wide Flood
2700K

E I 03.7311.40A
03.7311.14A

E I Dali Version
03.7311.40ADA
03.7311.14ADA

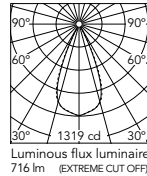

Beam Angle: 46°

h(m)	E(lx)	D(m)
1	1319	0.84
2	330	1.69
3	147	2.53
4	82	3.38
5	53	4.22

Luminous flux luminaire
716 lm (EXTREME CUT OFF)

Optic Wide Flood
3000K

E I 03.7315.40A
03.7315.14A

E I Dali Version
03.7315.40ADA
03.7315.14ADA

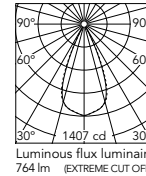

Beam Angle: 46°

h(m)	E(lx)	D(m)
1	1407	0.84
2	352	1.69
3	156	2.53
4	88	3.38
5	56	4.22

Luminous flux luminaire
764 lm (EXTREME CUT OFF)

LIGHT SHADOW

Light Shadow Adjustable Trim 8 Spots

Light Source: Power LED 21,6W - 2160 lm - 2700K/CRI 90 / 21,6W - 2280 lm - 3000K/CRI 90

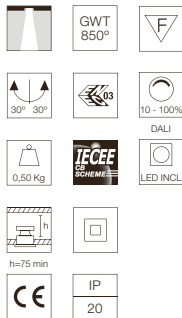
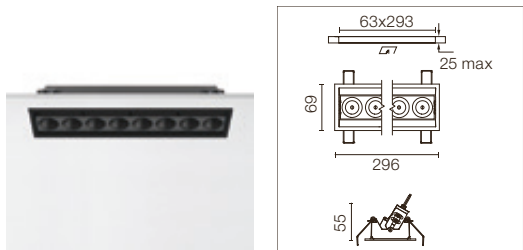

Apparecchio per illuminazione da incasso con 8 spot LED. Alimentazione remota inclusa (220-240V). Non richiede cornice di pre-installazione.

Recessed integrated luminaire with 8 LED lighting spots. Remote power supply included (220-240V). Pre-Installation frame not required.

E= Finitura Esterna
I= Finitura Interna

E= External Finish
I= Internal Finish

Optic Spot

- 2700K**
- E I 03.8901.40A
 - I 03.8901.14A
 - E I Dali Version
 - I 03.8901.40ADA
 - I 03.8901.14ADA

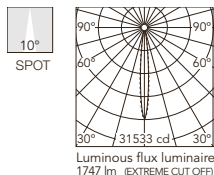

Beam Angle: 10°

h(m)	E(lx)	D(m)
1	31533	0.18
2	7883	0.36
3	3504	0.54
4	1971	0.72
5	1261	0.90

Optic Spot

- 3000K**
- E I 03.8905.40A
 - I 03.8905.14A
 - E I Dali Version
 - I 03.8905.40ADA
 - I 03.8905.14ADA

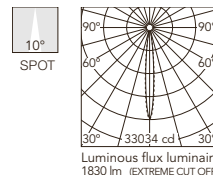

Beam Angle: 10°

h(m)	E(lx)	D(m)
1	33034	0.18
2	8259	0.36
3	3670	0.54
4	2065	0.72
5	1321	0.90

- 2700K**
- E I 03.8900.40A
 - I 03.8900.14A
 - E I Dali Version
 - I 03.8900.40ADA
 - I 03.8900.14ADA

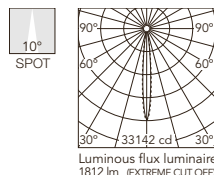

Beam Angle: 10°

h(m)	E(lx)	D(m)
1	33142	0.17
2	8285	0.35
3	3682	0.52
4	2071	0.70
5	1326	0.87

- 3000K**
- E I 03.8904.40A
 - I 03.8904.14A
 - E I Dali Version
 - I 03.8904.40ADA
 - I 03.8904.14ADA

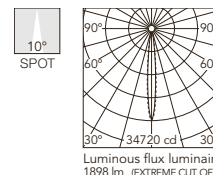

Beam Angle: 10°

h(m)	E(lx)	D(m)
1	34720	0.17
2	8680	0.35
3	3858	0.52
4	2170	0.70
5	1389	0.87

- 2700K**
- E I 03.8902.40A
 - I 03.8902.14A
 - E I Dali Version
 - I 03.8902.40ADA
 - I 03.8902.14ADA

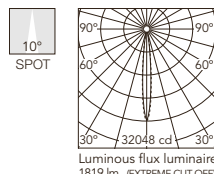

Beam Angle: 10°

h(m)	E(lx)	D(m)
1	32048	0.18
2	8012	0.36
3	3561	0.55
4	2003	0.73
5	1282	0.91

- 3000K**
- E I 03.8906.40A
 - I 03.8906.14A
 - E I Dali Version
 - I 03.8906.40ADA
 - I 03.8906.14ADA

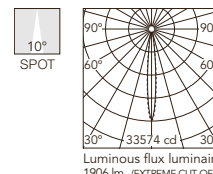

Beam Angle: 10°

h(m)	E(lx)	D(m)
1	33574	0.18
2	8394	0.36
3	3730	0.55
4	2098	0.73
5	1343	0.91

- 2700K**
- E I 03.8903.40A
 - I 03.8903.14A
 - E I Dali Version
 - I 03.8903.40ADA
 - I 03.8903.14ADA

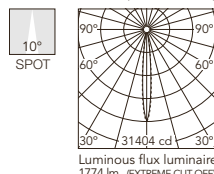

Beam Angle: 10°

h(m)	E(lx)	D(m)
1	31404	0.18
2	7851	0.36
3	3489	0.55
4	1963	0.73
5	1256	0.91

- 3000K**
- E I 03.8907.40A
 - I 03.8907.14A
 - E I Dali Version
 - I 03.8907.40ADA
 - I 03.8907.14ADA

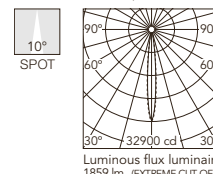

Beam Angle: 10°

h(m)	E(lx)	D(m)
1	32900	0.18
2	8225	0.36
3	3656	0.55
4	2056	0.73
5	1316	0.91

Optic Medium

- 2700K**
- E I 03.9341.40A
 - I 03.9341.14A
 - E I Dali Version
 - I 03.9341.40ADA
 - I 03.9341.14ADA

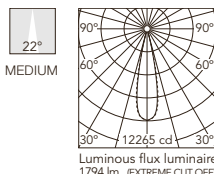

Beam Angle: 22°

h(m)	E(lx)	D(m)
1	12265	0.39
2	3066	0.78
3	1363	1.17
4	767	1.56
5	491	1.95

Optic Medium

- 3000K**
- E I 03.9351.40A
 - I 03.9351.14A
 - E I Dali Version
 - I 03.9351.40ADA
 - I 03.9351.14ADA

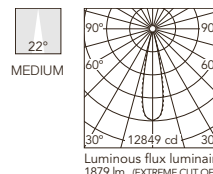

Beam Angle: 22°

h(m)	E(lx)	D(m)
1	12849	0.39
2	3212	0.78
3	1428	1.17
4	803	1.56
5	514	1.95

- 2700K**
- E I 03.9340.40A
 - I 03.9340.14A
 - E I Dali Version
 - I 03.9340.40ADA
 - I 03.9340.14ADA

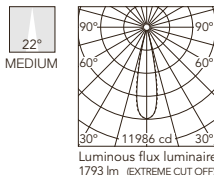

Beam Angle: 22°

h(m)	E(lx)	D(m)
1	11986	0.39
2	2996	0.78
3	1332	1.17
4	749	1.56
5	479	1.95

- 3000K**
- E I 03.9350.40A
 - I 03.9350.14A
 - E I Dali Version
 - I 03.9350.40ADA
 - I 03.9350.14ADA

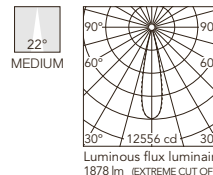

Beam Angle: 22°

h(m)	E(lx)	D(m)
1	12556	0.39
2	3139	0.78
3	1395	1.17
4	785	1.56
5	502	1.95

- 2700K**
- E I 03.9342.40A
 - I 03.9342.14A
 - E I Dali Version
 - I 03.9342.40ADA
 - I 03.9342.14ADA

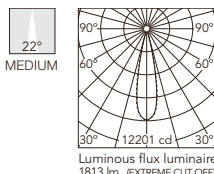

Beam Angle: 22°

h(m)	E(lx)	D(m)
1	12201	0.39
2	3050	0.77
3	1356	1.16
4	763	1.55
5	488	1.94

- 3000K**
- E I 03.9352.40A
 - I 03.9352.14A
 - E I Dali Version
 - I 03.9352.40ADA
 - I 03.9352.14ADA

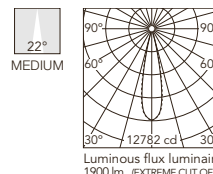

Beam Angle: 22°

h(m)	E(lx)	D(m)
1	12782	0.39
2	3196	0.77
3	1420	1.16
4	799	1.55
5	511	1.94

- 2700K**
- E I 03.9343.40A
 - I 03.9343.14A
 - E I Dali Version
 - I 03.9343.40ADA
 - I 03.9343.14ADA

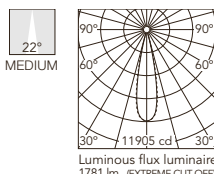

Beam Angle: 22°

h(m)	E(lx)	D(m)
1	11905	0.39
2	2976	0.78
3	1323	1.17
4	744	1.56
5	476	1.95

- 3000K**
- E I 03.9353.40A
 - I 03.9353.14A
 - E I Dali Version
 - I 03.9353.40ADA
 - I 03.9353.14ADA

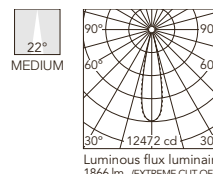

Beam Angle: 22°

h(m)	E(lx)	D(m)
1	12472	0.39
2	3118	0.78
3	1386	1.17
4	779	1.56
5	499	1.95

LIGHT SHADOW

Optic Flood

- 2700K**
- E I 03.9346.40A
 - E I 03.9346.14A
 - E I Dali Version
 - 03.9346.40ADA
 - 03.9346.14ADA

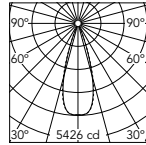

Beam Angle: 33°

h(m)	E(lx)	D(m)
1	5426	0.60
2	1357	1.19
3	603	1.79
4	339	2.39
5	217	2.99

Luminous flux luminaire
1735 lm (EXTREME CUT OFF)

Optic Flood

- 3000K**
- E I 03.9356.40A
 - E I 03.9356.14A
 - E I Dali Version
 - 03.9356.40ADA
 - 03.9356.14ADA

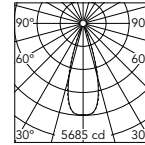

Beam Angle: 33°

h(m)	E(lx)	D(m)
1	5685	0.60
2	1421	1.19
3	632	1.79
4	355	2.39
5	227	2.99

Luminous flux luminaire
1818 lm (EXTREME CUT OFF)

- 2700K**
- 03.9345.40A
 - 03.9345.14A
 - E I Dali Version
 - 03.9345.40ADA
 - 03.9345.14ADA

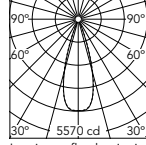

Beam Angle: 33°

h(m)	E(lx)	D(m)
1	5570	0.59
2	1392	1.18
3	619	1.78
4	348	2.37
5	223	2.96

Luminous flux luminaire
1787 lm (EXTREME CUT OFF)

- 3000K**
- 03.9355.40A
 - 03.9355.14A
 - E I Dali Version
 - 03.9355.40ADA
 - 03.9355.14ADA

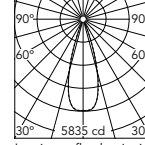

Beam Angle: 33°

h(m)	E(lx)	D(m)
1	5835	0.59
2	1459	1.18
3	648	1.78
4	365	2.37
5	233	2.96

Luminous flux luminaire
1872 lm (EXTREME CUT OFF)

- 2700K**
- 03.9347.40A
 - 03.9347.14A
 - E I Dali Version
 - 03.9347.40ADA
 - 03.9347.14ADA

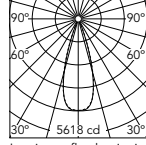

Beam Angle: 33°

h(m)	E(lx)	D(m)
1	5618	0.60
2	1405	1.19
3	624	1.79
4	351	2.38
5	225	2.98

Luminous flux luminaire
1814 lm (EXTREME CUT OFF)

- 3000K**
- 03.9357.40A
 - 03.9357.14A
 - E I Dali Version
 - 03.9357.40ADA
 - 03.9357.14ADA

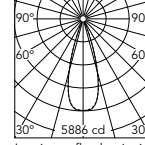

Beam Angle: 33°

h(m)	E(lx)	D(m)
1	5886	0.60
2	1472	1.19
3	654	1.79
4	368	2.38
5	235	2.98

Luminous flux luminaire
1901 lm (EXTREME CUT OFF)

- 2700K**
- 03.9348.40A
 - 03.9348.14A
 - E I Dali Version
 - 03.9348.40ADA
 - 03.9348.14ADA

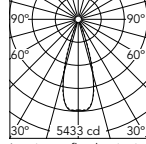

Beam Angle: 33°

h(m)	E(lx)	D(m)
1	5433	0.60
2	1358	1.20
3	604	1.79
4	340	2.39
5	217	2.99

Luminous flux luminaire
1765 lm (EXTREME CUT OFF)

- 3000K**
- 03.9358.40A
 - 03.9358.14A
 - E I Dali Version
 - 03.9358.40ADA
 - 03.9358.14ADA

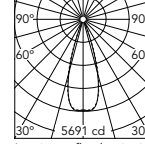

Beam Angle: 33°

h(m)	E(lx)	D(m)
1	5691	0.60
2	1423	1.20
3	632	1.79
4	356	2.39
5	228	2.99

Luminous flux luminaire
1850 lm (EXTREME CUT OFF)

Optic Wide Flood

- 2700K**
- 03.7317.40A
 - 03.7317.14A
 - E I Dali Version
 - 03.7317.40ADA
 - 03.7317.14ADA

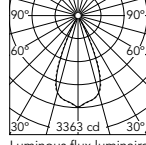

Beam Angle: 46°

h(m)	E(lx)	D(m)
1	3363	0.84
2	841	1.69
3	374	2.53
4	210	3.38
5	135	4.22

Luminous flux luminaire
1773 lm (EXTREME CUT OFF)

Optic Wide Flood

- 3000K**
- 03.7321.40A
 - 03.7321.14A
 - E I Dali Version
 - 03.7321.40ADA
 - 03.7321.14ADA

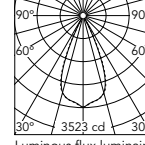

Beam Angle: 46°

h(m)	E(lx)	D(m)
1	3523	0.84
2	881	1.69
3	391	2.53
4	220	3.38
5	141	4.22

Luminous flux luminaire
1858 lm (EXTREME CUT OFF)

- 2700K**
- 03.7316.40A
 - 03.7316.14A
 - E I Dali Version
 - 03.7316.40ADA
 - 03.7316.14ADA

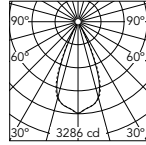

Beam Angle: 45°

h(m)	E(lx)	D(m)
1	3286	0.83
2	822	1.67
3	365	2.50
4	205	3.34
5	131	4.17

Luminous flux luminaire
1763 lm (EXTREME CUT OFF)

- 3000K**
- 03.7320.40A
 - 03.7320.14A
 - E I Dali Version
 - 03.7320.40ADA
 - 03.7320.14ADA

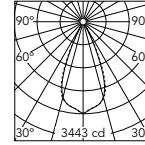

Beam Angle: 45°

h(m)	E(lx)	D(m)
1	3443	0.83
2	861	1.67
3	383	2.50
4	215	3.34
5	138	4.17

Luminous flux luminaire
1847 lm (EXTREME CUT OFF)

- 2700K**
- 03.7318.40A
 - 03.7318.14A
 - E I Dali Version
 - 03.7318.40ADA
 - 03.7318.14ADA

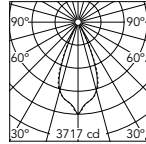

Beam Angle: 44°

h(m)	E(lx)	D(m)
1	3717	0.80
2	929	1.60
3	413	2.40
4	232	3.19
5	149	3.99

Luminous flux luminaire
1783 lm (EXTREME CUT OFF)

- 3000K**
- 03.7322.40A
 - 03.7322.14A
 - E I Dali Version
 - 03.7322.40ADA
 - 03.7322.14ADA

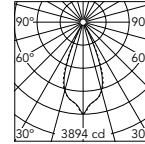

Beam Angle: 44°

h(m)	E(lx)	D(m)
1	3894	0.80
2	973	1.60
3	433	2.40
4	243	3.19
5	156	3.99

Luminous flux luminaire
1868 lm (EXTREME CUT OFF)

- 2700K**
- 03.7319.40A
 - 03.7319.14A
 - E I Dali Version
 - 03.7319.40ADA
 - 03.7319.14ADA

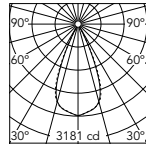

Beam Angle: 46°

h(m)	E(lx)	D(m)
1	3181	0.84
2	795	1.69
3	353	2.53
4	199	3.38
5	127	4.22

Luminous flux luminaire
1727 lm (EXTREME CUT OFF)

- 3000K**
- 03.7323.40A
 - 03.7323.14A
 - E I Dali Version
 - 03.7323.40ADA
 - 03.7323.14ADA

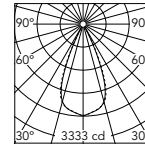

Beam Angle: 46°

h(m)	E(lx)	D(m)
1	3333	0.84
2	833	1.69
3	370	2.53
4	208	3.38
5	133	4.22

Luminous flux luminaire
1809 lm (EXTREME CUT OFF)

LIGHT SHADOW

Light Shadow Adjustable Trim 12 Spots

Light Source: Power LED 32,4W - 3240 lm - 2700K/CRI 90 / 32,4W - 3420 lm - 3000K/CRI 90

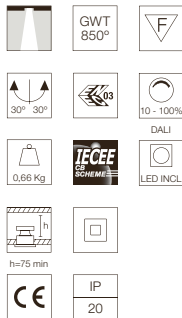
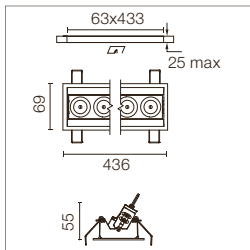

Apparecchio per illuminazione da incasso con 12 spot LED. Alimentazione remota inclusa (220-240V). Non richiede cornice di pre-installazione.

Recessed integrated luminaire with 12 LED lighting spots. Remote power supply included (220-240V). Pre-installation frame not required.

E= Finitura Esterna
I= Finitura Interna

E= External Finish
I= Internal Finish

Optic Spot 2700K

E I 03.8909.40A
03.8909.14A

E I Dali & Push Version

E I 03.8909.40ADA
03.8909.14ADA

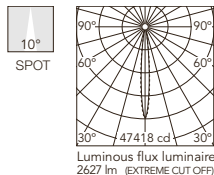

Beam Angle: 10°

h(m)	E(lx)	D(m)
1	47418	0.18
2	11854	0.36
3	5269	0.54
4	2964	0.72
5	1897	0.90

Optic Spot 3000K

E I 03.8913.40A
03.8913.14A

E I Dali & Push Version

E I 03.8913.40ADA
03.8913.14ADA

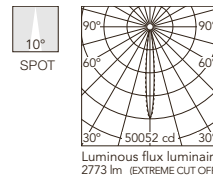

Beam Angle: 10°

h(m)	E(lx)	D(m)
1	50052	0.18
2	12513	0.36
3	5561	0.54
4	3128	0.72
5	2002	0.90

Optic Spot 2700K

E I 03.8908.40A
03.8908.14A

E I Dali & Push Version

E I 03.8908.40ADA
03.8908.14ADA

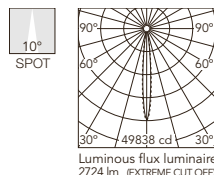

Beam Angle: 10°

h(m)	E(lx)	D(m)
1	49838	0.17
2	12459	0.35
3	5538	0.52
4	3115	0.70
5	1994	0.87

Optic Spot 3000K

E I 03.8912.40A
03.8912.14A

E I Dali & Push Version

E I 03.8912.40ADA
03.8912.14ADA

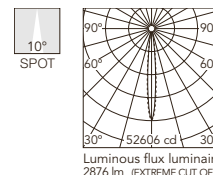

Beam Angle: 10°

h(m)	E(lx)	D(m)
1	52606	0.17
2	13152	0.35
3	5845	0.52
4	3288	0.70
5	2104	0.87

Optic Spot 2700K

E I 03.8910.40A
03.8910.14A

E I Dali & Push Version

E I 03.8910.40ADA
03.8910.14ADA

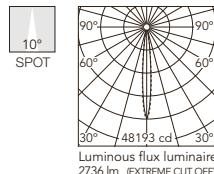

Beam Angle: 10°

h(m)	E(lx)	D(m)
1	48193	0.18
2	12048	0.36
3	5355	0.55
4	3012	0.73
5	1928	0.91

Optic Spot 3000K

E I 03.8914.40A
03.8914.14A

E I Dali & Push Version

E I 03.8914.40ADA
03.8914.14ADA

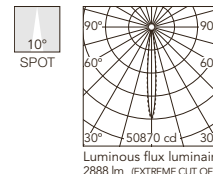

Beam Angle: 10°

h(m)	E(lx)	D(m)
1	50870	0.18
2	12718	0.36
3	5652	0.55
4	3179	0.73
5	2035	0.91

Optic Spot 2700K

E I 03.8911.40A
03.8911.14A

E I Dali & Push Version

E I 03.8911.40ADA
03.8911.14ADA

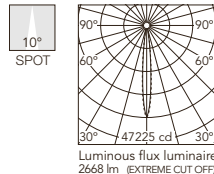

Beam Angle: 10°

h(m)	E(lx)	D(m)
1	47225	0.18
2	11806	0.36
3	5247	0.55
4	2952	0.73
5	1889	0.91

Optic Spot 3000K

E I 03.8915.40A
03.8915.14A

E I Dali & Push Version

E I 03.8915.40ADA
03.8915.14ADA

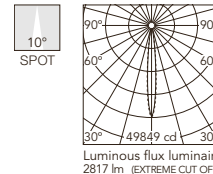

Beam Angle: 10°

h(m)	E(lx)	D(m)
1	49849	0.18
2	12462	0.36
3	5539	0.55
4	3116	0.73
5	1994	0.91

Optic Medium 2700K

E I 03.9361.40A
03.9361.14A

E I Dali & Push Version

E I 03.9361.40ADA
03.9361.14ADA

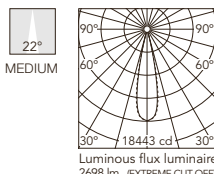

Beam Angle: 22°

h(m)	E(lx)	D(m)
1	18443	0.39
2	4611	0.78
3	2049	1.17
4	1153	1.56
5	738	1.95

Optic Medium 3000K

E I 03.9371.40A
03.9371.14A

E I Dali & Push Version

E I 03.9371.40ADA
03.9371.14ADA

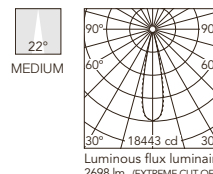

Beam Angle: 22°

h(m)	E(lx)	D(m)
1	18443	0.39
2	4611	0.78
3	2049	1.17
4	1153	1.56
5	738	1.95

Optic Medium 2700K

E I 03.9360.40A
03.9360.14A

E I Dali & Push Version

E I 03.9360.40ADA
03.9360.14ADA

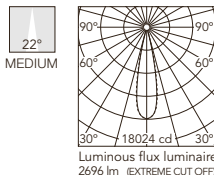

Beam Angle: 22°

h(m)	E(lx)	D(m)
1	18024	0.39
2	4506	0.78
3	2003	1.17
4	1126	1.56
5	721	1.95

Optic Medium 3000K

E I 03.9370.40A
03.9370.14A

E I Dali & Push Version

E I 03.9370.40ADA
03.9370.14ADA

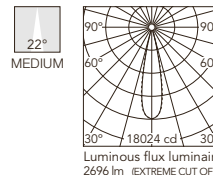

Beam Angle: 22°

h(m)	E(lx)	D(m)
1	18024	0.39
2	4506	0.78
3	2003	1.17
4	1126	1.56
5	721	1.95

Optic Medium 2700K

E I 03.9362.40A
03.9362.14A

E I Dali & Push Version

E I 03.9362.40ADA
03.9362.14ADA

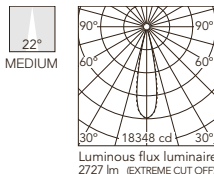

Beam Angle: 22°

h(m)	E(lx)	D(m)
1	18348	0.39
2	4587	0.77
3	2039	1.16
4	1147	1.55
5	734	1.94

Optic Medium 3000K

E I 03.9372.40A
03.9372.14A

E I Dali & Push Version

E I 03.9372.40ADA
03.9372.14ADA

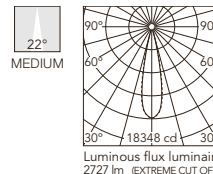

Beam Angle: 22°

h(m)	E(lx)	D(m)
1	18348	0.39
2	4587	0.77
3	2039	1.16
4	1147	1.55
5	734	1.94

Optic Medium 2700K

E I 03.9363.40A
03.9363.14A

E I Dali & Push Version

E I 03.9363.40ADA
03.9363.14ADA

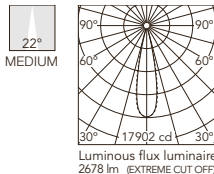

Beam Angle: 22°

h(m)	E(lx)	D(m)
1	17902	0.39
2	4476	0.78
3	1989	1.17
4	1119	1.56
5	716	1.95

Optic Medium 3000K

E I 03.9373.40A
03.9373.14A

E I Dali & Push Version

E I 03.9373.40ADA
03.9373.14ADA

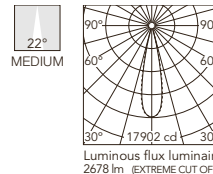

Beam Angle: 22°

h(m)	E(lx)	D(m)
1	17902	0.39
2	4476	0.78
3	1989	1.17
4	1119	1.56
5	716	1.95

LIGHT SHADOW

Optic Flood
2700K
E I 03.9366.40A
03.9366.14A
E I Dali & Push Version
03.9366.40ADA
03.9366.14ADA

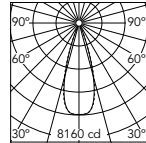

Beam Angle: 33°

h(m)	E(lx)	D(m)
1	8160	0.60
2	2040	1.19
3	907	1.79
4	510	2.39
5	326	2.99

Luminous flux luminaire
2610 lm (EXTREME CUT OFF)

E I **2700K**
03.9365.40A
03.9365.14A
E I Dali & Push Version
03.9365.40ADA
03.9365.14ADA

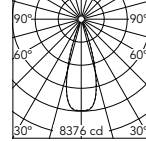

Beam Angle: 33°

h(m)	E(lx)	D(m)
1	8376	0.59
2	2094	1.18
3	931	1.78
4	523	2.37
5	335	2.96

Luminous flux luminaire
2687 lm (EXTREME CUT OFF)

E I **2700K**
03.9367.40A
03.9367.14A
E I Dali & Push Version
03.9367.40ADA
03.9367.14ADA

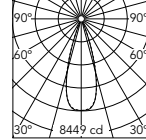

Beam Angle: 33°

h(m)	E(lx)	D(m)
1	8449	0.60
2	2112	1.19
3	939	1.79
4	528	2.38
5	338	2.98

Luminous flux luminaire
2728 lm (EXTREME CUT OFF)

E I **2700K**
03.9368.40A
03.9368.14A
E I Dali & Push Version
03.9368.40ADA
03.9368.14ADA

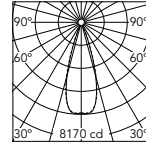

Beam Angle: 33°

h(m)	E(lx)	D(m)
1	8170	0.60
2	2042	1.20
3	908	1.79
4	511	2.39
5	327	2.99

Luminous flux luminaire
2655 lm (EXTREME CUT OFF)

Optic Flood
3000K
E I 03.9376.40A
03.9376.14A
E I Dali & Push Version
03.9376.40ADA
03.9376.14ADA

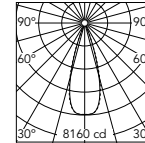

Beam Angle: 33°

h(m)	E(lx)	D(m)
1	8160	0.60
2	2040	1.19
3	907	1.79
4	510	2.39
5	326	2.99

Luminous flux luminaire
2610 lm (EXTREME CUT OFF)

E I **3000K**
03.9375.40A
03.9375.14A
E I Dali & Push Version
03.9375.40ADA
03.9375.14ADA

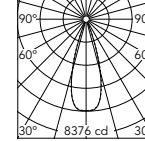

Beam Angle: 33°

h(m)	E(lx)	D(m)
1	8376	0.59
2	2094	1.18
3	931	1.78
4	523	2.37
5	335	2.96

Luminous flux luminaire
2687 lm (EXTREME CUT OFF)

E I **3000K**
03.9377.40A
03.9377.14A
E I Dali & Push Version
03.9377.40ADA
03.9377.14ADA

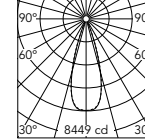

Beam Angle: 33°

h(m)	E(lx)	D(m)
1	8449	0.60
2	2112	1.19
3	939	1.79
4	528	2.38
5	338	2.98

Luminous flux luminaire
2728 lm (EXTREME CUT OFF)

E I **3000K**
03.9378.40A
03.9378.14A
E I Dali & Push Version
03.9378.40ADA
03.9378.14ADA

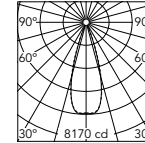

Beam Angle: 33°

h(m)	E(lx)	D(m)
1	8170	0.60
2	2042	1.20
3	908	1.79
4	511	2.39
5	327	2.99

Luminous flux luminaire
2655 lm (EXTREME CUT OFF)

Optic Wide Flood
2700K
E I 03.7325.40A
03.7325.14A
E I Dali & Push Version
03.7325.40ADA
03.7325.14ADA

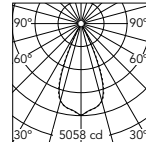

Beam Angle: 46°

h(m)	E(lx)	D(m)
1	5058	0.84
2	1264	1.69
3	562	2.53
4	316	3.38
5	202	4.22

Luminous flux luminaire
2666 lm (EXTREME CUT OFF)

E I **2700K**
03.7324.40A
03.7324.14A
E I Dali & Push Version
03.7324.40ADA
03.7324.14ADA

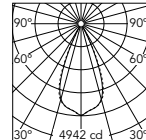

Beam Angle: 45°

h(m)	E(lx)	D(m)
1	4942	0.83
2	1235	1.67
3	549	2.50
4	309	3.34
5	198	4.17

Luminous flux luminaire
2652 lm (EXTREME CUT OFF)

E I **2700K**
03.7326.40A
03.7326.14A
E I Dali & Push Version
03.7326.40ADA
03.7326.14ADA

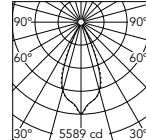

Beam Angle: 44°

h(m)	E(lx)	D(m)
1	5589	0.80
2	1397	1.60
3	621	2.40
4	349	3.19
5	224	3.99

Luminous flux luminaire
2681 lm (EXTREME CUT OFF)

E I **2700K**
03.7327.40A
03.7327.14A
E I Dali & Push Version
03.7327.40ADA
03.7327.14ADA

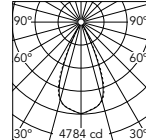

Beam Angle: 46°

h(m)	E(lx)	D(m)
1	4784	0.84
2	1196	1.69
3	532	2.53
4	299	3.38
5	191	4.22

Luminous flux luminaire
2597 lm (EXTREME CUT OFF)

Optic Wide Flood
3000K
E I 03.7329.40A
03.7329.14A
E I Dali & Push Version
03.7329.40ADA
03.7329.14ADA

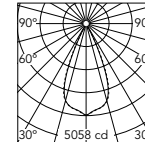

Beam Angle: 46°

h(m)	E(lx)	D(m)
1	5058	0.84
2	1264	1.69
3	562	2.53
4	316	3.38
5	202	4.22

Luminous flux luminaire
2666 lm (EXTREME CUT OFF)

E I **3000K**
03.7328.40A
03.7328.14A
E I Dali & Push Version
03.7328.40ADA
03.7328.14ADA

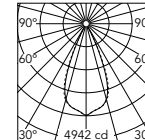

Beam Angle: 45°

h(m)	E(lx)	D(m)
1	4942	0.83
2	1235	1.67
3	549	2.50
4	309	3.34
5	198	4.17

Luminous flux luminaire
2652 lm (EXTREME CUT OFF)

E I **3000K**
03.7330.40A
03.7330.14A
E I Dali & Push Version
03.7330.40ADA
03.7330.14ADA

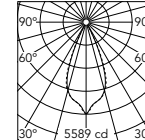

Beam Angle: 44°

h(m)	E(lx)	D(m)
1	5589	0.80
2	1397	1.60
3	621	2.40
4	349	3.19
5	224	3.99

Luminous flux luminaire
2681 lm (EXTREME CUT OFF)

E I **3000K**
03.7331.40A
03.7331.14A
E I Dali & Push Version
03.7331.40ADA
03.7331.14ADA

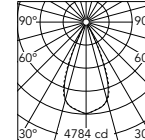

Beam Angle: 46°

h(m)	E(lx)	D(m)
1	4784	0.84
2	1196	1.69
3	532	2.53
4	299	3.38
5	191	4.22

Luminous flux luminaire
2597 lm (EXTREME CUT OFF)

LIGHT SHADOW

Light Shadow Adjustable No Trim 2 Spots

Light Source: Power LED 5,4W - 540 lm - 2700K/CRI 90 / 5,4W - 570 lm - 3000K/CRI 90

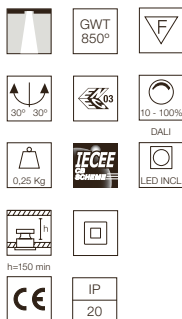
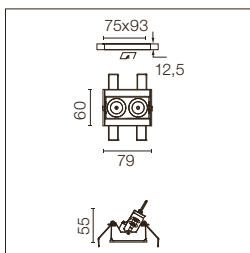

Apparecchio per illuminazione da incasso con 2 spot LED. Alimentazione remota inclusa (220-240V). Necessaria cornice di pre-installazione, da ordinare separatamente.

Recessed integrated luminaire with 2 LED lighting spots. Remote power supply included (220-240V). It requires a pre-installation frame, to be ordered separately.

E= Finitura Esterna
I= Finitura Interna

E= External Finish
I= Internal Finish

Optic Spot

- 2700K**
- E I 03.8917.40A
 - E I 03.8917.14A
 - Dali Version
 - E I 03.8917.40ADA
 - E I 03.8917.14ADA

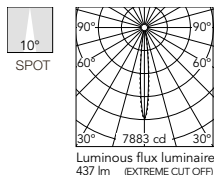

Beam Angle: 10°

h(m)	Ef(k)	D(m)
1	7883	0.18
2	1971	0.36
3	876	0.54
4	493	0.72
5	315	0.90

Optic Spot

- 3000K**
- E I 03.8921.40A
 - E I 03.8921.14A
 - Dali Version
 - E I 03.8921.40ADA
 - E I 03.8921.14ADA

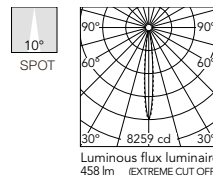

Beam Angle: 10°

h(m)	Ef(k)	D(m)
1	8259	0.18
2	2065	0.36
3	918	0.54
4	516	0.72
5	330	0.90

- 2700K**
- E I 03.8916.40A
 - E I 03.8916.14A
 - Dali Version
 - E I 03.8916.40ADA
 - E I 03.8916.14ADA

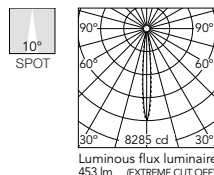

Beam Angle: 10°

h(m)	Ef(k)	D(m)
1	8285	0.17
2	2071	0.35
3	921	0.52
4	518	0.70
5	331	0.87

- 3000K**
- E I 03.8920.40A
 - E I 03.8920.14A
 - Dali Version
 - E I 03.8920.40ADA
 - E I 03.8920.14ADA

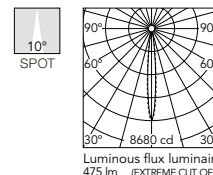

Beam Angle: 10°

h(m)	Ef(k)	D(m)
1	8680	0.17
2	2170	0.35
3	964	0.52
4	542	0.70
5	347	0.87

- 2700K**
- E I 03.8918.40A
 - E I 03.8918.14A
 - Dali Version
 - E I 03.8918.40ADA
 - E I 03.8918.14ADA

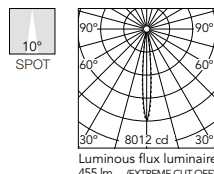

Beam Angle: 10°

h(m)	Ef(k)	D(m)
1	8012	0.18
2	2003	0.36
3	890	0.55
4	501	0.73
5	320	0.91

- 3000K**
- E I 03.8922.40A
 - E I 03.8922.14A
 - Dali Version
 - E I 03.8922.40ADA
 - E I 03.8922.14ADA

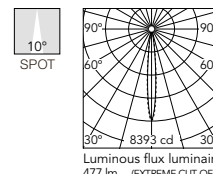

Beam Angle: 10°

h(m)	Ef(k)	D(m)
1	8393	0.18
2	2098	0.36
3	933	0.55
4	525	0.73
5	336	0.91

- 2700K**
- E I 03.8919.40A
 - E I 03.8919.14A
 - Dali Version
 - E I 03.8919.40ADA
 - E I 03.8919.14ADA

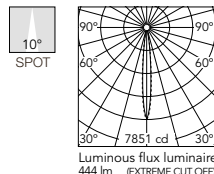

Beam Angle: 10°

h(m)	Ef(k)	D(m)
1	7851	0.18
2	1963	0.36
3	872	0.55
4	491	0.73
5	314	0.91

- 3000K**
- E I 03.8923.40A
 - E I 03.8923.14A
 - Dali Version
 - E I 03.8923.40ADA
 - E I 03.8923.14ADA

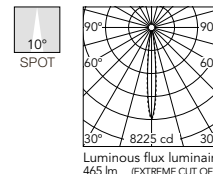

Beam Angle: 10°

h(m)	Ef(k)	D(m)
1	8225	0.18
2	2056	0.36
3	914	0.55
4	514	0.73
5	329	0.91

Optic Medium

- 2700K**
- E I 03.9401.40A
 - E I 03.9401.14A
 - Dali Version
 - E I 03.9401.40ADA
 - E I 03.9401.14ADA

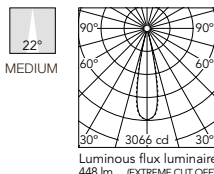

Beam Angle: 22°

h(m)	Ef(k)	D(m)
1	3066	0.39
2	767	0.78
3	341	1.17
4	192	1.56
5	123	1.95

Optic Medium

- 3000K**
- E I 03.9411.40A
 - E I 03.9411.14A
 - Dali Version
 - E I 03.9411.40ADA
 - E I 03.9411.14ADA

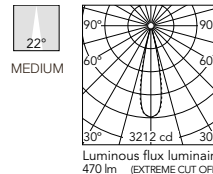

Beam Angle: 22°

h(m)	Ef(k)	D(m)
1	3212	0.39
2	803	0.78
3	357	1.17
4	201	1.56
5	128	1.95

- 2700K**
- E I 03.9400.40A
 - E I 03.9400.14A
 - Dali Version
 - E I 03.9400.40ADA
 - E I 03.9400.14ADA

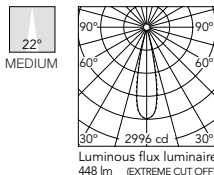

Beam Angle: 22°

h(m)	Ef(k)	D(m)
1	2996	0.39
2	749	0.78
3	333	1.17
4	187	1.56
5	120	1.95

- 3000K**
- E I 03.9410.40A
 - E I 03.9410.14A
 - Dali Version
 - E I 03.9410.40ADA
 - E I 03.9410.14ADA

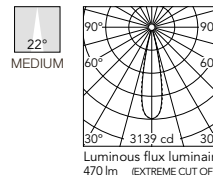

Beam Angle: 22°

h(m)	Ef(k)	D(m)
1	3139	0.39
2	785	0.78
3	349	1.17
4	196	1.56
5	126	1.95

- 2700K**
- E I 03.9402.40A
 - E I 03.9402.14A
 - Dali Version
 - E I 03.9402.40ADA
 - E I 03.9402.14ADA

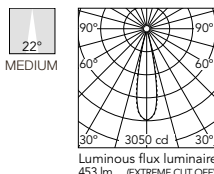

Beam Angle: 22°

h(m)	Ef(k)	D(m)
1	3050	0.39
2	763	0.77
3	339	1.16
4	191	1.55
5	122	1.94

- 3000K**
- E I 03.9412.40A
 - E I 03.9412.14A
 - Dali Version
 - E I 03.9412.40ADA
 - E I 03.9412.14ADA

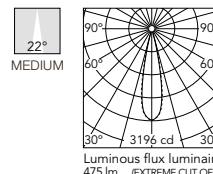

Beam Angle: 22°

h(m)	Ef(k)	D(m)
1	3196	0.39
2	799	0.77
3	355	1.16
4	200	1.55
5	128	1.94

- 2700K**
- E I 03.9403.40A
 - E I 03.9403.14A
 - Dali Version
 - E I 03.9403.40ADA
 - E I 03.9403.14ADA

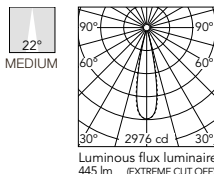

Beam Angle: 22°

h(m)	Ef(k)	D(m)
1	2976	0.39
2	744	0.78
3	331	1.17
4	186	1.56
5	119	1.95

- 3000K**
- E I 03.9413.40A
 - E I 03.9413.14A
 - Dali Version
 - E I 03.9413.40ADA
 - E I 03.9413.14ADA

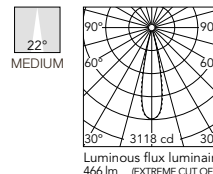

Beam Angle: 22°

h(m)	Ef(k)	D(m)
1	3118	0.39
2	779	0.78
3	346	1.17
4	195	1.56
5	125	1.95

LIGHT SHADOW

Optic Flood
2700K
 E I 03.9406.40A
 03.9406.14A
 E I Dali Version
 03.9406.40ADA
 03.9406.14ADA

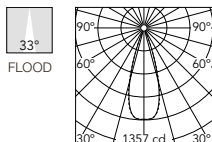

Beam Angle: 33°
 h(m) E(lx) D(m)
 1 1357 0.60
 2 339 1.19
 3 151 1.79
 4 85 2.39
 5 54 2.99

Luminous flux luminaire
 434 lm (EXTREME CUT OFF)

Optic Flood
3000K
 E I 03.9416.40A
 03.9416.14A
 E I Dali Version
 03.9416.40ADA
 03.9416.14ADA

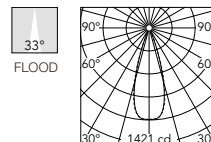

Beam Angle: 33°
 h(m) E(lx) D(m)
 1 1421 0.60
 2 355 1.19
 3 158 1.79
 4 89 2.39
 5 57 2.99

Luminous flux luminaire
 455 lm (EXTREME CUT OFF)

Optic Flood
2700K
 E I 03.9405.40A
 03.9405.14A
 E I Dali Version
 03.9405.40ADA
 03.9405.14ADA

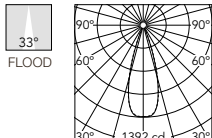

Beam Angle: 33°
 h(m) E(lx) D(m)
 1 1392 0.59
 2 348 1.18
 3 155 1.78
 4 87 2.37
 5 56 2.96

Luminous flux luminaire
 447 lm (EXTREME CUT OFF)

Optic Flood
3000K
 E I 03.9415.40A
 03.9415.14A
 E I Dali Version
 03.9415.40ADA
 03.9415.14ADA

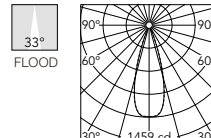

Beam Angle: 33°
 h(m) E(lx) D(m)
 1 1459 0.59
 2 365 1.18
 3 162 1.78
 4 91 2.37
 5 58 2.96

Luminous flux luminaire
 468 lm (EXTREME CUT OFF)

Optic Flood
2700K
 E I 03.9407.40A
 03.9407.14A
 E I Dali Version
 03.9407.40ADA
 03.9407.14ADA

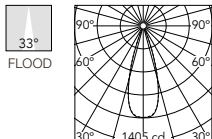

Beam Angle: 33°
 h(m) E(lx) D(m)
 1 1405 0.60
 2 351 1.19
 3 156 1.79
 4 88 2.38
 5 56 2.98

Luminous flux luminaire
 454 lm (EXTREME CUT OFF)

Optic Flood
3000K
 E I 03.9417.40A
 03.9417.14A
 E I Dali Version
 03.9417.40ADA
 03.9417.14ADA

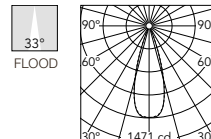

Beam Angle: 33°
 h(m) E(lx) D(m)
 1 1471 0.60
 2 368 1.19
 3 163 1.79
 4 92 2.38
 5 59 2.98

Luminous flux luminaire
 475 lm (EXTREME CUT OFF)

Optic Flood
2700K
 E I 03.9408.40A
 03.9408.14A
 E I Dali Version
 03.9408.40ADA
 03.9408.14ADA

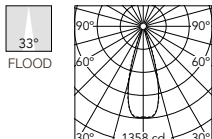

Beam Angle: 33°
 h(m) E(lx) D(m)
 1 1358 0.60
 2 340 1.20
 3 151 1.79
 4 85 2.39
 5 54 2.99

Luminous flux luminaire
 441 lm (EXTREME CUT OFF)

Optic Flood
3000K
 E I 03.9418.40A
 03.9418.14A
 E I Dali Version
 03.9418.40ADA
 03.9418.14ADA

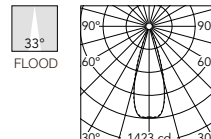

Beam Angle: 33°
 h(m) E(lx) D(m)
 1 1423 0.60
 2 356 1.20
 3 158 1.79
 4 89 2.39
 5 57 2.99

Luminous flux luminaire
 462 lm (EXTREME CUT OFF)

Optic Wide Flood
2700K
 E I 03.7351.40A
 03.7351.14A
 E I Dali Version
 03.7351.40ADA
 03.7351.14ADA

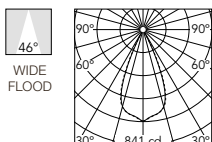

Beam Angle: 46°
 h(m) E(lx) D(m)
 1 841 0.84
 2 210 1.69
 3 93 2.53
 4 53 3.38
 5 34 4.22

Luminous flux luminaire
 443 lm (EXTREME CUT OFF)

Optic Wide Flood
3000K
 E I 03.7355.40A
 03.7355.14A
 E I Dali Version
 03.7355.40ADA
 03.7355.14ADA

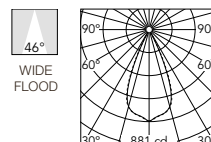

Beam Angle: 46°
 h(m) E(lx) D(m)
 1 881 0.84
 2 220 1.69
 3 98 2.53
 4 55 3.38
 5 35 4.22

Luminous flux luminaire
 464 lm (EXTREME CUT OFF)

Optic Wide Flood
2700K
 E I 03.7350.40A
 03.7350.14A
 E I Dali Version
 03.7350.40ADA
 03.7350.14ADA

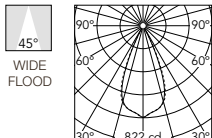

Beam Angle: 45°
 h(m) E(lx) D(m)
 1 822 0.83
 2 205 1.67
 3 91 2.50
 4 51 3.34
 5 33 4.17

Luminous flux luminaire
 441 lm (EXTREME CUT OFF)

Optic Wide Flood
3000K
 E I 03.7354.40A
 03.7354.14A
 E I Dali Version
 03.7354.40ADA
 03.7354.14ADA

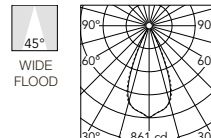

Beam Angle: 45°
 h(m) E(lx) D(m)
 1 861 0.83
 2 215 1.67
 3 96 2.50
 4 54 3.34
 5 34 4.17

Luminous flux luminaire
 462 lm (EXTREME CUT OFF)

Optic Wide Flood
2700K
 E I 03.7352.40A
 03.7352.14A
 E I Dali Version
 03.7352.40ADA
 03.7352.14ADA

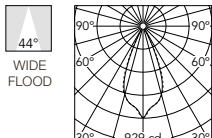

Beam Angle: 44°
 h(m) E(lx) D(m)
 1 929 0.80
 2 232 1.60
 3 103 2.40
 4 58 3.19
 5 37 3.99

Luminous flux luminaire
 446 lm (EXTREME CUT OFF)

Optic Wide Flood
3000K
 E I 03.7356.40A
 03.7356.14A
 E I Dali Version
 03.7356.40ADA
 03.7356.14ADA

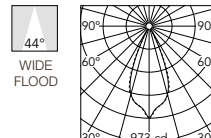

Beam Angle: 44°
 h(m) E(lx) D(m)
 1 973 0.80
 2 243 1.60
 3 108 2.40
 4 61 3.19
 5 39 3.99

Luminous flux luminaire
 467 lm (EXTREME CUT OFF)

Optic Wide Flood
2700K
 E I 03.7353.40A
 03.7353.14A
 E I Dali Version
 03.7353.40ADA
 03.7353.14ADA

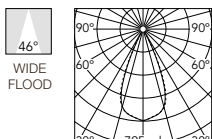

Beam Angle: 46°
 h(m) E(lx) D(m)
 1 795 0.84
 2 199 1.69
 3 88 2.53
 4 50 3.38
 5 32 4.22

Luminous flux luminaire
 432 lm (EXTREME CUT OFF)

Optic Wide Flood
3000K
 E I 03.7357.40A
 03.7357.14A
 E I Dali Version
 03.7357.40ADA
 03.7357.14ADA

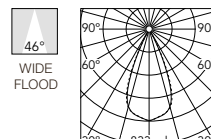

Beam Angle: 46°
 h(m) E(lx) D(m)
 1 833 0.84
 2 208 1.69
 3 93 2.53
 4 52 3.38
 5 33 4.22

Luminous flux luminaire
 452 lm (EXTREME CUT OFF)

LIGHT SHADOW

Light Shadow Adjustable No Trim 4 Spots

Light Source: Power LED 10,8W - 1080 lm - 2700K/CRI 90 / 10,8W - 1140lm - 3000K/CRI 90

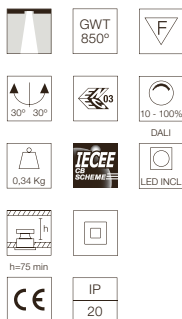
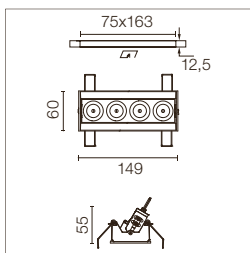

Apparecchio per illuminazione da incasso con 4 spot LED. Alimentazione remota inclusa (220-240V). Cornice di pre-installazione da ordinare separatamente.

Recessed integrated luminaire with 4 LED lighting spots. Remote power supply included (220-240V). It requires a pre-installation frame, to be ordered separately.

E= Finitura Esterna
I= Finitura Interna

E= External Finish
I= Internal Finish.

Optic Spot

2700K

E I	03.8925.40A
E I	03.8925.14A
E I	Dali Version
E I	03.8925.40ADA
E I	03.8925.14ADA

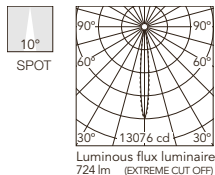

Beam Angle: 10°

h(m)	E(lx)	D(m)
1	13076	0.18
2	3269	0.36
3	1453	0.54
4	817	0.72
5	523	0.90

Optic Spot

3000K

E I	03.8929.40A
E I	03.8929.14A
E I	Dali Version
E I	03.8929.40ADA
E I	03.8929.14ADA

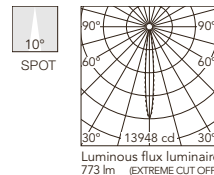

Beam Angle: 10°

h(m)	E(lx)	D(m)
1	13948	0.18
2	3487	0.36
3	1550	0.54
4	872	0.72
5	558	0.90

2700K

E I	03.8924.40A
E I	03.8924.14A
E I	Dali Version
E I	03.8924.40ADA
E I	03.8924.14ADA

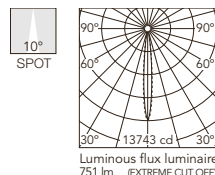

Beam Angle: 10°

h(m)	E(lx)	D(m)
1	13743	0.17
2	3436	0.35
3	1527	0.52
4	859	0.70
5	550	0.87

3000K

E I	03.8928.40A
E I	03.8928.14A
E I	Dali Version
E I	03.8928.40ADA
E I	03.8928.14ADA

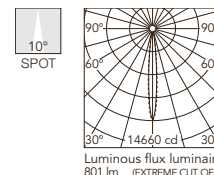

Beam Angle: 10°

h(m)	E(lx)	D(m)
1	14660	0.17
2	3665	0.35
3	1629	0.52
4	916	0.70
5	586	0.87

2700K

E I	03.8926.40A
E I	03.8926.14A
E I	Dali Version
E I	03.8926.40ADA
E I	03.8926.14ADA

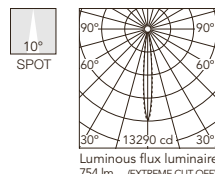

Beam Angle: 10°

h(m)	E(lx)	D(m)
1	13290	0.18
2	3322	0.36
3	1477	0.55
4	831	0.73
5	532	0.91

3000K

E I	03.8930.40A
E I	03.8930.14A
E I	Dali Version
E I	03.8930.40ADA
E I	03.8930.14ADA

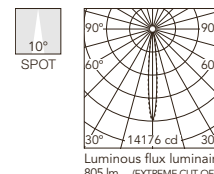

Beam Angle: 10°

h(m)	E(lx)	D(m)
1	14176	0.18
2	3544	0.36
3	1575	0.55
4	886	0.73
5	567	0.91

2700K

E I	03.8927.40A
E I	03.8927.14A
E I	Dali Version
E I	03.8927.40ADA
E I	03.8927.14ADA

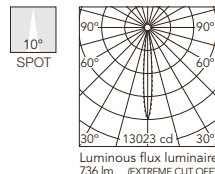

Beam Angle: 10°

h(m)	E(lx)	D(m)
1	13023	0.18
2	3256	0.36
3	1447	0.55
4	814	0.73
5	521	0.91

3000K

E I	03.8931.40A
E I	03.8931.14A
E I	Dali Version
E I	03.8931.40ADA
E I	03.8931.14ADA

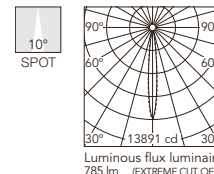

Beam Angle: 10°

h(m)	E(lx)	D(m)
1	13891	0.18
2	3473	0.36
3	1543	0.55
4	868	0.73
5	556	0.91

Optic Medium

2700K

E I	03.9421.40A
E I	03.9421.14A
E I	Dali Version
E I	03.9421.40ADA
E I	03.9421.14ADA

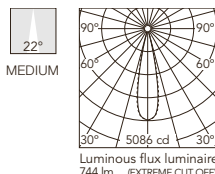

Beam Angle: 22°

h(m)	E(lx)	D(m)
1	5086	0.39
2	1272	0.78
3	565	1.17
4	318	1.56
5	203	1.95

Optic Medium

3000K

E I	03.9431.40A
E I	03.9431.14A
E I	Dali Version
E I	03.9431.40ADA
E I	03.9431.14ADA

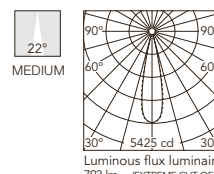

Beam Angle: 22°

h(m)	E(lx)	D(m)
1	5425	0.39
2	1356	0.78
3	603	1.17
4	339	1.56
5	217	1.95

2700K

E I	03.9420.40A
E I	03.9420.14A
E I	Dali Version
E I	03.9420.40ADA
E I	03.9420.14ADA

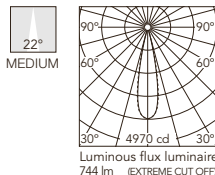

Beam Angle: 22°

h(m)	E(lx)	D(m)
1	4970	0.39
2	1243	0.78
3	552	1.17
4	311	1.56
5	199	1.95

3000K

E I	03.9430.40A
E I	03.9430.14A
E I	Dali Version
E I	03.9430.40ADA
E I	03.9430.14ADA

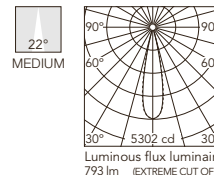

Beam Angle: 22°

h(m)	E(lx)	D(m)
1	5302	0.39
2	1325	0.78
3	589	1.17
4	331	1.56
5	212	1.95

2700K

E I	03.9422.40A
E I	03.9422.14A
E I	Dali Version
E I	03.9422.40ADA
E I	03.9422.14ADA

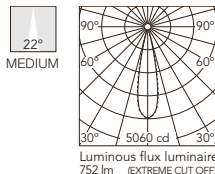

Beam Angle: 22°

h(m)	E(lx)	D(m)
1	5060	0.39
2	1265	0.77
3	562	1.16
4	316	1.55
5	202	1.94

3000K

E I	03.9432.40A
E I	03.9432.14A
E I	Dali Version
E I	03.9432.40ADA
E I	03.9432.14ADA

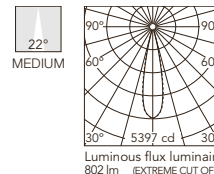

Beam Angle: 22°

h(m)	E(lx)	D(m)
1	5397	0.39
2	1349	0.77
3	600	1.16
4	337	1.55
5	216	1.94

2700K

E I	03.9423.40A
E I	03.9423.14A
E I	Dali Version
E I	03.9423.40ADA
E I	03.9423.14ADA

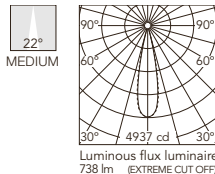

Beam Angle: 22°

h(m)	E(lx)	D(m)
1	4937	0.39
2	1234	0.78
3	549	1.17
4	309	1.56
5	197	1.95

3000K

E I	03.9433.40A
E I	03.9433.14A
E I	Dali Version
E I	03.9433.40ADA
E I	03.9433.14ADA

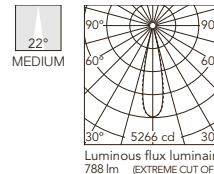

Beam Angle: 22°

h(m)	E(lx)	D(m)
1	5266	0.39
2	1316	0.78
3	585	1.17
4	329	1.56
5	211	1.95

LIGHT SHADOW

Optic Flood
2700K
E I 03.9426.40A
03.9426.14A
E I Dali Version
03.9426.40ADA
03.9426.14ADA

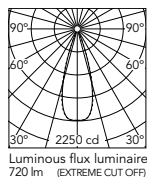

Beam Angle: 33°
h(m) E(lx) D(m)
1 2250 0.60
2 563 1.19
3 250 1.79
4 141 2.39
5 90 2.99

Luminous flux luminaire
720 lm (EXTREME CUT OFF)

2700K
E I 03.9425.40A
03.9425.14A
E I Dali Version
03.9425.40ADA
03.9425.14ADA

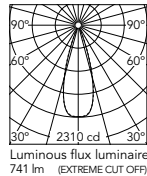

Beam Angle: 33°
h(m) E(lx) D(m)
1 2310 0.59
2 577 1.18
3 257 1.78
4 144 2.37
5 92 2.96

Luminous flux luminaire
741 lm (EXTREME CUT OFF)

2700K
E I 03.9427.40A
03.9427.14A
E I Dali Version
03.9427.40ADA
03.9427.14ADA

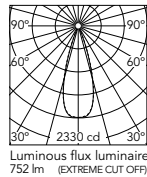

Beam Angle: 33°
h(m) E(lx) D(m)
1 2330 0.60
2 582 1.19
3 259 1.79
4 146 2.38
5 93 2.98

Luminous flux luminaire
752 lm (EXTREME CUT OFF)

2700K
E I 03.9428.40A
03.9428.14A
E I Dali Version
03.9428.40ADA
03.9428.14ADA

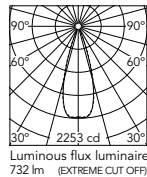

Beam Angle: 33°
h(m) E(lx) D(m)
1 2253 0.60
2 563 1.20
3 250 1.79
4 141 2.39
5 90 2.99

Luminous flux luminaire
732 lm (EXTREME CUT OFF)

Optic Wide Flood
2700K
E I 03.7359.40A
03.7359.14A
E I Dali Version
03.7359.40ADA
03.7359.14ADA

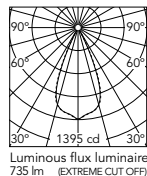

Beam Angle: 46°
h(m) E(lx) D(m)
1 1395 0.84
2 349 1.69
3 155 2.53
4 87 3.38
5 56 4.22

Luminous flux luminaire
735 lm (EXTREME CUT OFF)

2700K
E I 03.7358.40A
03.7358.14A
E I Dali Version
03.7358.40ADA
03.7358.14ADA

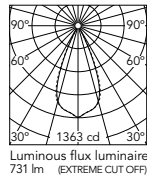

Beam Angle: 45°
h(m) E(lx) D(m)
1 1363 0.83
2 341 1.67
3 151 2.50
4 85 3.34
5 55 4.17

Luminous flux luminaire
731 lm (EXTREME CUT OFF)

2700K
E I 03.7360.40A
03.7360.14A
E I Dali Version
03.7360.40ADA
03.7360.14ADA

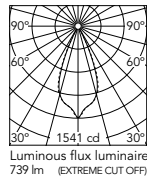

Beam Angle: 44°
h(m) E(lx) D(m)
1 1541 0.80
2 385 1.60
3 171 2.40
4 96 3.19
5 62 3.99

Luminous flux luminaire
739 lm (EXTREME CUT OFF)

2700K
E I 03.7361.40A
03.7361.14A
E I Dali Version
03.7361.40ADA
03.7361.14ADA

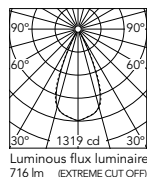

Beam Angle: 46°
h(m) E(lx) D(m)
1 1319 0.84
2 330 1.69
3 147 2.53
4 82 3.38
5 53 4.22

Luminous flux luminaire
716 lm (EXTREME CUT OFF)

Optic Flood
3000K
E I 03.9436.40A
03.9436.14A
E I Dali Version
03.9436.40ADA
03.9436.14ADA

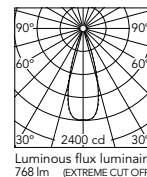

Beam Angle: 33°
h(m) E(lx) D(m)
1 2400 0.60
2 600 1.19
3 267 1.79
4 150 2.39
5 96 2.99

Luminous flux luminaire
768 lm (EXTREME CUT OFF)

3000K
E I 03.9435.40A
03.9435.14A
E I Dali Version
03.9435.40ADA
03.9435.14ADA

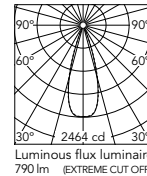

Beam Angle: 33°
h(m) E(lx) D(m)
1 2464 0.59
2 616 1.18
3 274 1.78
4 154 2.37
5 99 2.96

Luminous flux luminaire
790 lm (EXTREME CUT OFF)

3000K
E I 03.9437.40A
03.9437.14A
E I Dali Version
03.9437.40ADA
03.9437.14ADA

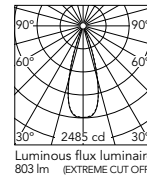

Beam Angle: 33°
h(m) E(lx) D(m)
1 2485 0.60
2 621 1.19
3 276 1.79
4 155 2.38
5 99 2.98

Luminous flux luminaire
803 lm (EXTREME CUT OFF)

3000K
E I 03.9438.40A
03.9438.14A
E I Dali Version
03.9438.40ADA
03.9438.14ADA

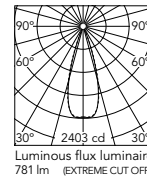

Beam Angle: 33°
h(m) E(lx) D(m)
1 2403 0.60
2 601 1.20
3 267 1.79
4 150 2.39
5 96 2.99

Luminous flux luminaire
781 lm (EXTREME CUT OFF)

Optic Wide Flood
3000K
E I 03.7363.40A
03.7363.14A
E I Dali Version
03.7363.40ADA
03.7363.14ADA

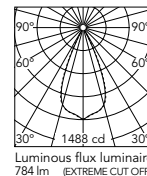

Beam Angle: 46°
h(m) E(lx) D(m)
1 1488 0.84
2 372 1.69
3 165 2.53
4 93 3.38
5 60 4.22

Luminous flux luminaire
784 lm (EXTREME CUT OFF)

3000K
E I 03.7362.40A
03.7362.14A
E I Dali Version
03.7362.40ADA
03.7362.14ADA

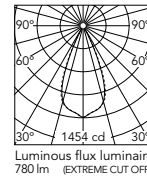

Beam Angle: 45°
h(m) E(lx) D(m)
1 1454 0.83
2 363 1.67
3 162 2.50
4 91 3.34
5 58 4.17

Luminous flux luminaire
780 lm (EXTREME CUT OFF)

3000K
E I 03.7364.40A
03.7364.14A
E I Dali Version
03.7364.40ADA
03.7364.14ADA

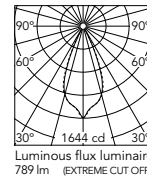

Beam Angle: 44°
h(m) E(lx) D(m)
1 1644 0.80
2 411 1.60
3 183 2.40
4 103 3.19
5 66 3.99

Luminous flux luminaire
789 lm (EXTREME CUT OFF)

3000K
E I 03.7365.40A
03.7365.14A
E I Dali Version
03.7365.40ADA
03.7365.14ADA

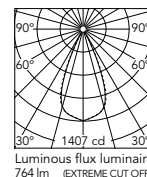

Beam Angle: 46°
h(m) E(lx) D(m)
1 1407 0.84
2 352 1.69
3 156 2.53
4 88 3.38
5 56 4.22

Luminous flux luminaire
764 lm (EXTREME CUT OFF)

LIGHT SHADOW

Light Shadow Adjustable No Trim 8 Spots

Light Source: Power LED 21,6W - 2160 lm - 2700K/CRI 90 / 21,6W - 2280 lm - 3000K/CRI 90

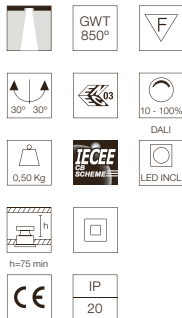
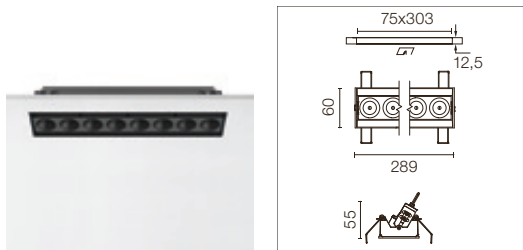

Apparecchio per illuminazione da incasso con 8 spot LED. Alimentazione remota inclusa (220-240V). Necessaria cornice di pre-installazione, da ordinare separatamente.

Recessed integrated luminaire with 8 LED lighting spots. Remote power supply included (220-240V). It requires a pre-installation frame, to be ordered separately.

E= Finitura Esterna
I= Finitura Interna

E= External Finish
I= Internal Finish

Optic Spot

- 2700K**
- E I 03.8933.40A
 - 03.8933.14A
 - E I Dali Version
 - 03.8933.40ADA
 - 03.8933.14ADA

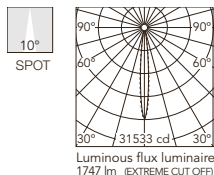

Beam Angle: 10°

h(m)	E(lx)	D(m)
1	31533	0.18
2	7883	0.36
3	3504	0.54
4	1971	0.72
5	1261	0.90

Optic Spot

- 3000K**
- E I 03.8937.40A
 - 03.8937.14A
 - E I Dali Version
 - 03.8937.40ADA
 - 03.8937.14ADA

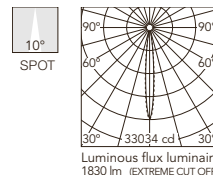

Beam Angle: 10°

h(m)	E(lx)	D(m)
1	33034	0.18
2	8259	0.36
3	3670	0.54
4	2065	0.72
5	1321	0.90

- 2700K**
- E I 03.8932.40A
 - 03.8932.14A
 - E I Dali Version
 - 03.8932.40ADA
 - 03.8932.14ADA

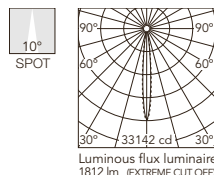

Beam Angle: 10°

h(m)	E(lx)	D(m)
1	33142	0.17
2	8285	0.35
3	3682	0.52
4	2071	0.70
5	1326	0.87

- 3000K**
- E I 03.8936.40A
 - 03.8936.14A
 - E I Dali Version
 - 03.8936.40ADA
 - 03.8936.14ADA

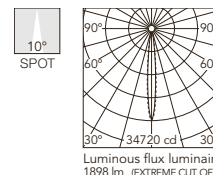

Beam Angle: 10°

h(m)	E(lx)	D(m)
1	34720	0.17
2	8680	0.35
3	3858	0.52
4	2170	0.70
5	1389	0.87

- 2700K**
- E I 03.8934.40A
 - 03.8934.14A
 - E I Dali Version
 - 03.8934.40ADA
 - 03.8934.14ADA

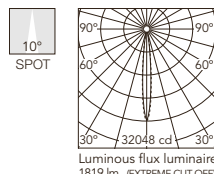

Beam Angle: 10°

h(m)	E(lx)	D(m)
1	32048	0.18
2	8012	0.36
3	3561	0.55
4	2003	0.73
5	1282	0.91

- 3000K**
- E I 03.8938.40A
 - 03.8938.14A
 - E I Dali Version
 - 03.8938.40ADA
 - 03.8938.14ADA

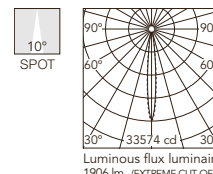

Beam Angle: 10°

h(m)	E(lx)	D(m)
1	33574	0.18
2	8394	0.36
3	3730	0.55
4	2098	0.73
5	1343	0.91

- 2700K**
- E I 03.8935.40A
 - 03.8935.14A
 - E I Dali Version
 - 03.8935.40ADA
 - 03.8935.14ADA

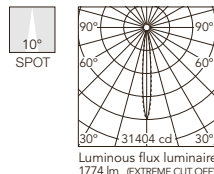

Beam Angle: 10°

h(m)	E(lx)	D(m)
1	31404	0.18
2	7851	0.36
3	3489	0.55
4	1963	0.73
5	1256	0.91

- 3000K**
- E I 03.8939.40A
 - 03.8939.14A
 - E I Dali Version
 - 03.8939.40ADA
 - 03.8939.14ADA

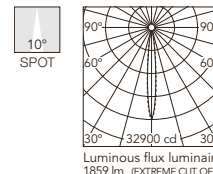

Beam Angle: 10°

h(m)	E(lx)	D(m)
1	32900	0.18
2	8225	0.36
3	3656	0.55
4	2056	0.73
5	1316	0.91

Optic Medium

- 2700K**
- E I 03.9441.40A
 - 03.9441.14A
 - E I Dali Version
 - 03.9441.40ADA
 - 03.9441.14ADA

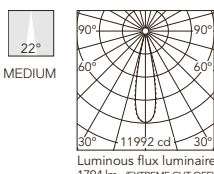

Beam Angle: 22°

h(m)	E(lx)	D(m)
1	11992	0.39
2	2998	0.78
3	1332	1.17
4	750	1.56
5	480	1.95

Optic Medium

- 3000K**
- E I 03.9451.40A
 - 03.9451.14A
 - E I Dali Version
 - 03.9451.40ADA
 - 03.9451.14ADA

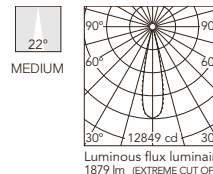

Beam Angle: 22°

h(m)	E(lx)	D(m)
1	12849	0.39
2	3212	0.78
3	1428	1.17
4	803	1.56
5	514	1.95

- 2700K**
- E I 03.9440.40A
 - 03.9440.14A
 - E I Dali Version
 - 03.9440.40ADA
 - 03.9440.14ADA

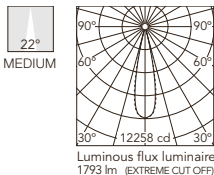

Beam Angle: 22°

h(m)	E(lx)	D(m)
1	12258	0.39
2	3065	0.78
3	1362	1.17
4	766	1.56
5	490	1.95

- 3000K**
- E I 03.9450.40A
 - 03.9450.14A
 - E I Dali Version
 - 03.9450.40ADA
 - 03.9450.14ADA

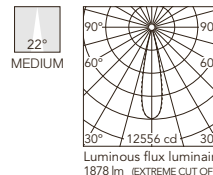

Beam Angle: 22°

h(m)	E(lx)	D(m)
1	12556	0.39
2	3139	0.78
3	1395	1.17
4	785	1.56
5	502	1.95

- 2700K**
- E I 03.9442.40A
 - 03.9442.14A
 - E I Dali Version
 - 03.9442.40ADA
 - 03.9442.14ADA

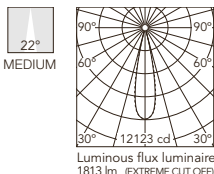

Beam Angle: 22°

h(m)	E(lx)	D(m)
1	12123	0.39
2	3031	0.78
3	1347	1.17
4	758	1.56
5	485	1.95

- 3000K**
- E I 03.9452.40A
 - 03.9452.14A
 - E I Dali Version
 - 03.9452.40ADA
 - 03.9452.14ADA

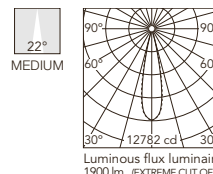

Beam Angle: 22°

h(m)	E(lx)	D(m)
1	12782	0.39
2	3196	0.77
3	1420	1.16
4	799	1.55
5	511	1.94

- 2700K**
- E I 03.9443.40A
 - 03.9443.14A
 - E I Dali Version
 - 03.9443.40ADA
 - 03.9443.14ADA

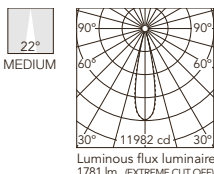

Beam Angle: 22°

h(m)	E(lx)	D(m)
1	11982	0.39
2	2995	0.77
3	1331	1.16
4	749	1.55
5	479	1.94

- 3000K**
- E I 03.9453.40A
 - 03.9453.14A
 - E I Dali Version
 - 03.9453.40ADA
 - 03.9453.14ADA

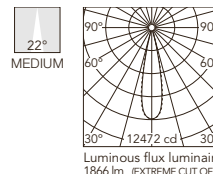

Beam Angle: 22°

h(m)	E(lx)	D(m)
1	12472	0.39
2	3118	0.78
3	1386	1.17
4	779	1.56
5	499	1.95

LIGHT SHADOW

Optic Flood
2700K
E I 03.9446.40A
03.9446.14A
E I Dali Version
03.9446.40ADA
03.9446.14ADA

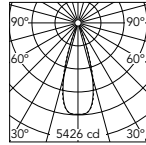

Beam Angle: 33°
h(m) E(lx) D(m)
1 5426 0.60
2 1357 1.19
3 603 1.79
4 339 2.39
5 217 2.99

Luminous flux luminaire
1735 lm (EXTREME CUT OFF)

Optic Flood
3000K
E I 03.9456.40A
03.9456.14A
E I Dali Version
03.9456.40ADA
03.9456.14ADA

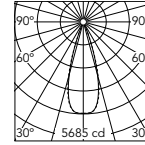

Beam Angle: 33°
h(m) E(lx) D(m)
1 5685 0.60
2 1421 1.19
3 632 1.79
4 355 2.39
5 227 2.99

Luminous flux luminaire
1818 lm (EXTREME CUT OFF)

Optic Flood
2700K
E I 03.9445.40A
03.9445.14A
E I Dali Version
03.9445.40ADA
03.9445.14ADA

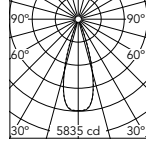

Beam Angle: 33°
h(m) E(lx) D(m)
1 5835 0.59
2 1459 1.18
3 648 1.78
4 365 2.37
5 233 2.96

Luminous flux luminaire
1872 lm (EXTREME CUT OFF)

Optic Flood
3000K
E I 03.9455.40A
03.9455.14A
E I Dali Version
03.9455.40ADA
03.9455.14ADA

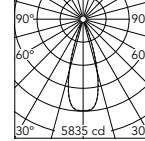

Beam Angle: 33°
h(m) E(lx) D(m)
1 5835 0.59
2 1459 1.18
3 648 1.78
4 365 2.37
5 233 2.96

Luminous flux luminaire
1872 lm (EXTREME CUT OFF)

Optic Flood
2700K
E I 03.9447.40A
03.9447.14A
E I Dali Version
03.9447.40ADA
03.9447.14ADA

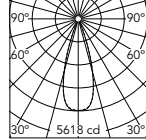

Beam Angle: 33°
h(m) E(lx) D(m)
1 5618 0.60
2 1405 1.19
3 624 1.79
4 351 2.38
5 225 2.98

Luminous flux luminaire
1814 lm (EXTREME CUT OFF)

Optic Flood
3000K
E I 03.9457.40A
03.9457.14A
E I Dali Version
03.9457.40ADA
03.9457.14ADA

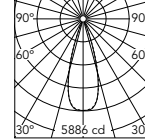

Beam Angle: 33°
h(m) E(lx) D(m)
1 5886 0.60
2 1472 1.19
3 654 1.79
4 368 2.38
5 235 2.98

Luminous flux luminaire
1901 lm (EXTREME CUT OFF)

Optic Flood
2700K
E I 03.9448.40A
03.9448.14A
E I Dali Version
03.9448.40ADA
03.9448.14ADA

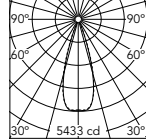

Beam Angle: 33°
h(m) E(lx) D(m)
1 5433 0.60
2 1358 1.20
3 604 1.79
4 340 2.39
5 217 2.99

Luminous flux luminaire
1765 lm (EXTREME CUT OFF)

Optic Flood
3000K
E I 03.9458.40A
03.9458.14A
E I Dali Version
03.9458.40ADA
03.9458.14ADA

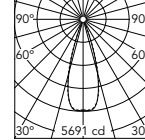

Beam Angle: 33°
h(m) E(lx) D(m)
1 5691 0.60
2 1423 1.20
3 632 1.79
4 356 2.39
5 228 2.99

Luminous flux luminaire
1850 lm (EXTREME CUT OFF)

Optic Wide Flood
2700K
E I 03.7367.40A
03.7367.14A
E I Dali Version
03.7367.40ADA
03.7367.14ADA

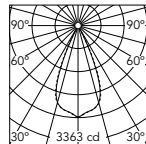

Beam Angle: 46°
h(m) E(lx) D(m)
1 3363 0.84
2 841 1.69
3 374 2.53
4 210 3.38
5 135 4.22

Luminous flux luminaire
1773 lm (EXTREME CUT OFF)

Optic Wide Flood
3000K
E I 03.7371.40A
03.7371.14A
E I Dali Version
03.7371.40ADA
03.7371.14ADA

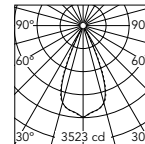

Beam Angle: 46°
h(m) E(lx) D(m)
1 3523 0.84
2 881 1.69
3 391 2.53
4 220 3.38
5 141 4.22

Luminous flux luminaire
1858 lm (EXTREME CUT OFF)

Optic Wide Flood
2700K
E I 03.7366.40A
03.7366.14A
E I Dali Version
03.7366.40ADA
03.7366.14ADA

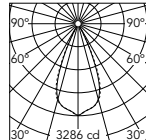

Beam Angle: 45°
h(m) E(lx) D(m)
1 3286 0.83
2 822 1.67
3 365 2.50
4 205 3.34
5 131 4.17

Luminous flux luminaire
1763 lm (EXTREME CUT OFF)

Optic Wide Flood
3000K
E I 03.7370.40A
03.7370.14A
E I Dali Version
03.7370.40ADA
03.7370.14ADA

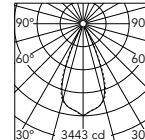

Beam Angle: 45°
h(m) E(lx) D(m)
1 3443 0.83
2 861 1.67
3 383 2.50
4 215 3.34
5 138 4.17

Luminous flux luminaire
1847 lm (EXTREME CUT OFF)

Optic Wide Flood
2700K
E I 03.7368.40A
03.7368.14A
E I Dali Version
03.7368.40ADA
03.7368.14ADA

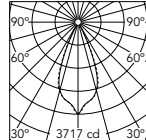

Beam Angle: 44°
h(m) E(lx) D(m)
1 3717 0.80
2 929 1.60
3 413 2.40
4 232 3.19
5 149 3.99

Luminous flux luminaire
1783 lm (EXTREME CUT OFF)

Optic Wide Flood
3000K
E I 03.7372.40A
03.7372.14A
E I Dali Version
03.7372.40ADA
03.7372.14ADA

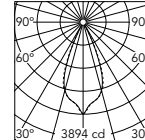

Beam Angle: 44°
h(m) E(lx) D(m)
1 3894 0.80
2 973 1.60
3 433 2.40
4 243 3.19
5 156 3.99

Luminous flux luminaire
1868 lm (EXTREME CUT OFF)

Optic Wide Flood
2700K
E I 03.7369.40A
03.7369.14A
E I Dali Version
03.7369.40ADA
03.7369.14ADA

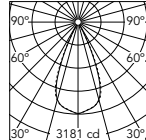

Beam Angle: 46°
h(m) E(lx) D(m)
1 3181 0.84
2 795 1.69
3 353 2.53
4 199 3.38
5 127 4.22

Luminous flux luminaire
1727 lm (EXTREME CUT OFF)

Optic Wide Flood
3000K
E I 03.7373.40A
03.7373.14A
E I Dali Version
03.7373.40ADA
03.7373.14ADA

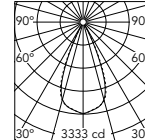

Beam Angle: 46°
h(m) E(lx) D(m)
1 3333 0.84
2 833 1.69
3 370 2.53
4 208 3.38
5 133 4.22

Luminous flux luminaire
1809 lm (EXTREME CUT OFF)

LIGHT SHADOW

Light Shadow Adjustable No Trim 12 Spots

Light Source: Power LED 32,4W - 3240 lm - 2700K/CRI 90 / 32,4W - 3420 lm - 3000K/CRI 90

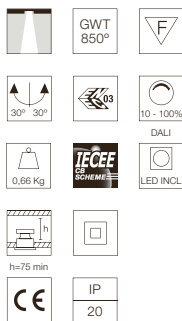
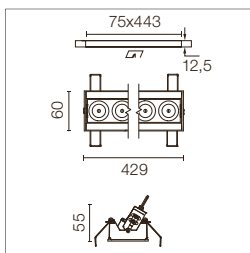

Apparecchio per illuminazione da incasso con 12 spot LED. Alimentazione remota inclusa (220-240V). Necessaria cornice di pre-installazione, da ordinare separatamente.

Recessed integrated luminaire with 12 LED lighting spots. Remote power supply included (220-240V). It requires a pre-installation frame, to be ordered separately.

E= Finitura Esterna
I= Finitura Interna

E= External Finish
I= Internal Finish

Optic Spot 2700K

E I 03.8941.40A
03.8941.14A

E I Dali & Push Version

E I 03.8941.40ADA
03.8941.14ADA

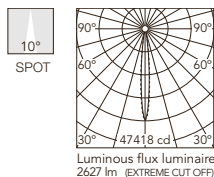

Beam Angle: 10°

h(m)	E(lx)	D(m)
1	47418	0.18
2	11854	0.36
3	5269	0.54
4	2964	0.72
5	1897	0.90

Optic Spot 3000K

E I 03.8945.40A
03.8945.14A

E I Dali & Push Version

E I 03.8945.40ADA
03.8945.14ADA

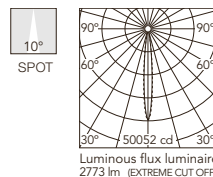

Beam Angle: 10°

h(m)	E(lx)	D(m)
1	50052	0.18
2	12513	0.36
3	5561	0.54
4	3128	0.72
5	2002	0.90

Optic Spot 2700K

E I 03.8940.40A
03.8940.14A

E I Dali & Push Version

E I 03.8940.40ADA
03.8940.14ADA

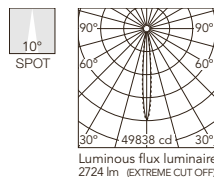

Beam Angle: 10°

h(m)	E(lx)	D(m)
1	49838	0.17
2	12459	0.35
3	5538	0.52
4	3115	0.70
5	1994	0.87

Optic Spot 3000K

E I 03.8944.40A
03.8944.14A

E I Dali & Push Version

E I 03.8944.40ADA
03.8944.14ADA

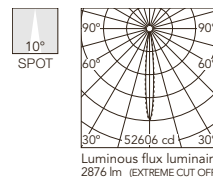

Beam Angle: 10°

h(m)	E(lx)	D(m)
1	52606	0.17
2	13152	0.35
3	5845	0.52
4	3288	0.70
5	2104	0.87

Optic Spot 2700K

E I 03.8942.40A
03.8942.14A

E I Dali & Push Version

E I 03.8942.40ADA
03.8942.14ADA

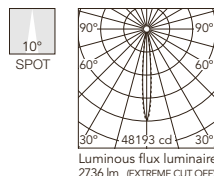

Beam Angle: 10°

h(m)	E(lx)	D(m)
1	48193	0.18
2	12048	0.36
3	5355	0.55
4	3012	0.73
5	1928	0.91

Optic Spot 3000K

E I 03.8946.40A
03.8946.14A

E I Dali & Push Version

E I 03.8946.40ADA
03.8946.14ADA

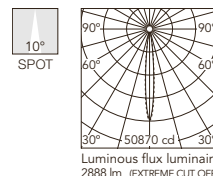

Beam Angle: 10°

h(m)	E(lx)	D(m)
1	50870	0.18
2	12718	0.36
3	5652	0.55
4	3179	0.73
5	2035	0.91

Optic Spot 2700K

E I 03.8943.40A
03.8943.14A

E I Dali & Push Version

E I 03.8943.40ADA
03.8943.14ADA

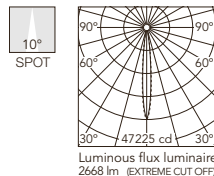

Beam Angle: 10°

h(m)	E(lx)	D(m)
1	47225	0.18
2	11806	0.36
3	5247	0.55
4	2952	0.73
5	1889	0.91

Optic Spot 3000K

E I 03.8947.40A
03.8947.14A

E I Dali & Push Version

E I 03.8947.40ADA
03.8947.14ADA

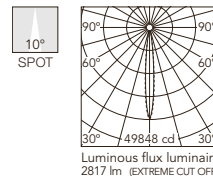

Beam Angle: 10°

h(m)	E(lx)	D(m)
1	49848	0.18
2	12462	0.36
3	5539	0.55
4	3116	0.73
5	1994	0.91

Optic Medium 2700K

E I 03.9461.40A
03.9461.14A

E I Dali & Push Version

E I 03.9461.40ADA
03.9461.14ADA

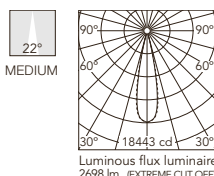

Beam Angle: 22°

h(m)	E(lx)	D(m)
1	18443	0.39
2	4611	0.78
3	2049	1.17
4	1153	1.56
5	738	1.95

Optic Medium 3000K

E I 03.9471.40A
03.9471.14A

E I Dali & Push Version

E I 03.9471.40ADA
03.9471.14ADA

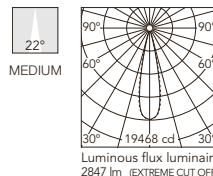

Beam Angle: 22°

h(m)	E(lx)	D(m)
1	19468	0.39
2	4867	0.78
3	2163	1.17
4	1217	1.56
5	779	1.95

Optic Medium 2700K

E I 03.9460.40A
03.9460.14A

E I Dali & Push Version

E I 03.9460.40ADA
03.9460.14ADA

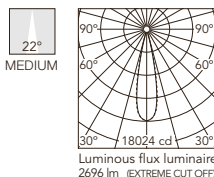

Beam Angle: 22°

h(m)	E(lx)	D(m)
1	18024	0.39
2	4506	0.78
3	2003	1.17
4	1126	1.56
5	721	1.95

Optic Medium 3000K

E I 03.9470.40A
03.9470.14A

E I Dali & Push Version

E I 03.9470.40ADA
03.9470.14ADA

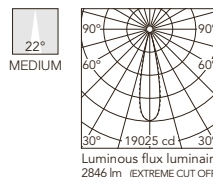

Beam Angle: 22°

h(m)	E(lx)	D(m)
1	19025	0.39
2	4756	0.78
3	2114	1.17
4	1189	1.56
5	761	1.95

Optic Medium 2700K

E I 03.9462.40A
03.9462.14A

E I Dali & Push Version

E I 03.9462.40ADA
03.9462.14ADA

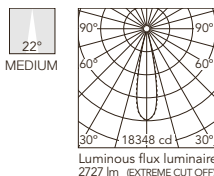

Beam Angle: 22°

h(m)	E(lx)	D(m)
1	18348	0.39
2	4587	0.77
3	2039	1.16
4	1147	1.55
5	734	1.94

Optic Medium 3000K

E I 03.9472.40A
03.9472.14A

E I Dali & Push Version

E I 03.9472.40ADA
03.9472.14ADA

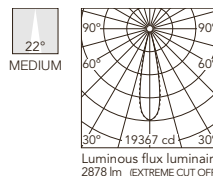

Beam Angle: 22°

h(m)	E(lx)	D(m)
1	19367	0.39
2	4842	0.77
3	2152	1.16
4	1210	1.55
5	775	1.94

Optic Medium 2700K

E I 03.9463.40A
03.9463.14A

E I Dali & Push Version

E I 03.9463.40ADA
03.9463.14ADA

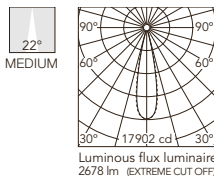

Beam Angle: 22°

h(m)	E(lx)	D(m)
1	17902	0.39
2	4476	0.78
3	1989	1.17
4	1119	1.56
5	716	1.95

Optic Medium 3000K

E I 03.9473.40A
03.9473.14A

E I Dali & Push Version

E I 03.9473.40ADA
03.9473.14ADA

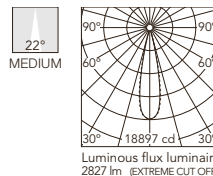

Beam Angle: 22°

h(m)	E(lx)	D(m)
1	18897	0.39
2	4724	0.78
3	2100	1.17
4	1181	1.56
5	756	1.95

LIGHT SHADOW

Optic Flood
2700K
 E I 03.9466.40A
 03.9466.14A
 E I Dali & Push Version
 03.9466.40ADA
 03.9466.14ADA

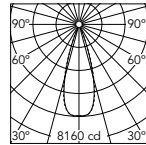

Beam Angle: 33°
 h(m) E(lx) D(m)
 1 8160 0.60
 2 2040 1.19
 3 907 1.79
 4 510 2.39
 5 326 2.99

Luminous flux luminaire
 2610 lm (EXTREME CUT OFF)

E I **2700K**
 03.9465.40A
 03.9465.14A
 E I Dali & Push Version
 03.9465.40ADA
 03.9465.14ADA

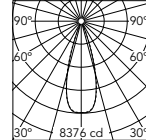

Beam Angle: 33°
 h(m) E(lx) D(m)
 1 8376 0.59
 2 2094 1.18
 3 931 1.78
 4 523 2.37
 5 335 2.96

Luminous flux luminaire
 2687 lm (EXTREME CUT OFF)

E I **2700K**
 03.9467.40A
 03.9467.14A
 E I Dali & Push Version
 03.9467.40ADA
 03.9467.14ADA

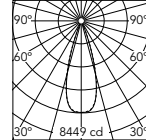

Beam Angle: 33°
 h(m) E(lx) D(m)
 1 8449 0.60
 2 2112 1.19
 3 939 1.79
 4 528 2.38
 5 338 2.98

Luminous flux luminaire
 2728 lm (EXTREME CUT OFF)

E I **2700K**
 03.9468.40A
 03.9468.14A
 E I Dali & Push Version
 03.9468.40ADA
 03.9468.14ADA

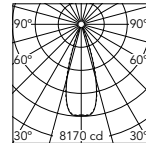

Beam Angle: 33°
 h(m) E(lx) D(m)
 1 8170 0.60
 2 2042 1.20
 3 908 1.79
 4 511 2.39
 5 327 2.99

Luminous flux luminaire
 2655 lm (EXTREME CUT OFF)

Optic Wide Flood
2700K
 E I 03.7375.40A
 03.7375.14A
 E I Dali & Push Version
 03.7375.40ADA
 03.7375.14ADA

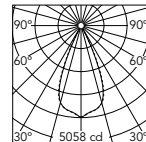

Beam Angle: 46°
 h(m) E(lx) D(m)
 1 5058 0.84
 2 1264 1.69
 3 562 2.53
 4 316 3.38
 5 202 4.22

Luminous flux luminaire
 2666 lm (EXTREME CUT OFF)

E I **2700K**
 03.7374.40A
 03.7374.14A
 E I Dali & Push Version
 03.7374.40ADA
 03.7374.14ADA

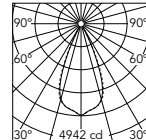

Beam Angle: 45°
 h(m) E(lx) D(m)
 1 4942 0.83
 2 1235 1.67
 3 549 2.50
 4 309 3.34
 5 198 4.17

Luminous flux luminaire
 2652 lm (EXTREME CUT OFF)

E I **2700K**
 03.7376.40A
 03.7376.14A
 E I Dali & Push Version
 03.7376.40ADA
 03.7376.14ADA

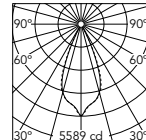

Beam Angle: 44°
 h(m) E(lx) D(m)
 1 5589 0.80
 2 1397 1.60
 3 621 2.40
 4 349 3.19
 5 224 3.99

Luminous flux luminaire
 2681 lm (EXTREME CUT OFF)

E I **2700K**
 03.7377.40A
 03.7377.14A
 E I Dali & Push Version
 03.7377.40ADA
 03.7377.14ADA

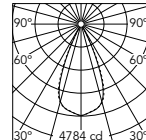

Beam Angle: 46°
 h(m) E(lx) D(m)
 1 4784 0.84
 2 1196 1.69
 3 532 2.53
 4 299 3.38
 5 191 4.22

Luminous flux luminaire
 2597 lm (EXTREME CUT OFF)

Optic Flood
3000K
 E I 03.9476.40A
 03.9476.14A
 E I Dali & Push Version
 03.9476.40ADA
 03.9476.14ADA

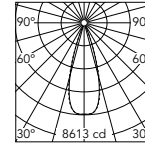

Beam Angle: 33°
 h(m) E(lx) D(m)
 1 8613 0.60
 2 2153 1.19
 3 957 1.79
 4 538 2.39
 5 345 2.99

Luminous flux luminaire
 2755 lm (EXTREME CUT OFF)

E I **3000K**
 03.9475.40A
 03.9475.14A
 E I Dali & Push Version
 03.9475.40ADA
 03.9475.14ADA

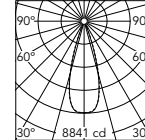

Beam Angle: 33°
 h(m) E(lx) D(m)
 1 8841 0.59
 2 2210 1.18
 3 982 1.78
 4 553 2.37
 5 354 2.96

Luminous flux luminaire
 2836 lm (EXTREME CUT OFF)

E I **3000K**
 03.9477.40A
 03.9477.14A
 E I Dali & Push Version
 03.9477.40ADA
 03.9477.14ADA

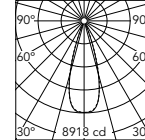

Beam Angle: 33°
 h(m) E(lx) D(m)
 1 8918 0.60
 2 2230 1.19
 3 991 1.79
 4 557 2.38
 5 357 2.98

Luminous flux luminaire
 2880 lm (EXTREME CUT OFF)

E I **3000K**
 03.9478.40A
 03.9478.14A
 E I Dali & Push Version
 03.9478.40ADA
 03.9478.14ADA

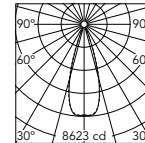

Beam Angle: 33°
 h(m) E(lx) D(m)
 1 8623 0.60
 2 2156 1.20
 3 958 1.79
 4 539 2.39
 5 345 2.99

Luminous flux luminaire
 2802 lm (EXTREME CUT OFF)

Optic Wide Flood
3000K
 E I 03.7379.40A
 03.7379.14A
 E I Dali & Push Version
 03.7379.40ADA
 03.7379.14ADA

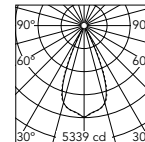

Beam Angle: 46°
 h(m) E(lx) D(m)
 1 5339 0.84
 2 1335 1.69
 3 593 2.53
 4 334 3.38
 5 214 4.22

Luminous flux luminaire
 2815 lm (EXTREME CUT OFF)

E I **3000K**
 03.7378.40A
 03.7378.14A
 E I Dali & Push Version
 03.7378.40ADA
 03.7378.14ADA

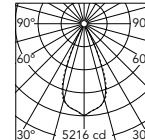

Beam Angle: 45°
 h(m) E(lx) D(m)
 1 5216 0.83
 2 1304 1.67
 3 580 2.50
 4 326 3.34
 5 209 4.17

Luminous flux luminaire
 2799 lm (EXTREME CUT OFF)

E I **3000K**
 03.7380.40A
 03.7380.14A
 E I Dali & Push Version
 03.7380.40ADA
 03.7380.14ADA

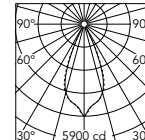

Beam Angle: 44°
 h(m) E(lx) D(m)
 1 5900 0.80
 2 1475 1.60
 3 656 2.40
 4 369 3.19
 5 236 3.99

Luminous flux luminaire
 2830 lm (EXTREME CUT OFF)

E I **3000K**
 03.7381.40A
 03.7381.14A
 E I Dali & Push Version
 03.7381.40ADA
 03.7381.14ADA

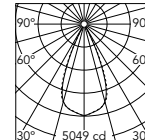

Beam Angle: 46°
 h(m) E(lx) D(m)
 1 5049 0.84
 2 1262 1.69
 3 561 2.53
 4 316 3.38
 5 202 4.22

Luminous flux luminaire
 2742 lm (EXTREME CUT OFF)

LIGHT SHADOW WALL-WASHER

Light Shadow Wall-Washer Trim 4 Spots

Light Source: Power LED 10,8W - 1080 lm - 2700K/CRI 90 / 10,8W - 1140lm - 3000K/CRI 90

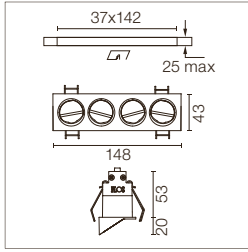

Apparecchio a incasso con 4 faretti LED. Fonte di alimentazione remota inclusa (220-240V).
Cornice di preinstallazione non necessaria.

Recessed integrated luminaire with 4 LED lighting spots. Remote power supply included (220-240V).
Pre-installation frame not required.

2700K

- 03.9901.40A
- 03.9901.14A
- Dali Version
- 03.9901.40ADA
- 03.9901.14ADA

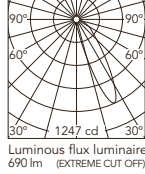

Beam Angle: 22°

h(m)	E(lx)	D(m)
1	1247	0.50
2	312	0.99
3	139	1.49
4	78	1.99
5	50	2.48

Luminous flux luminaire 690 lm (EXTREME CUT OFF)

3000K

- 03.9900.40A
- 03.9900.14A
- Dali Version
- 03.9900.40ADA
- 03.9900.14ADA

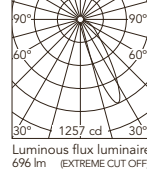

Beam Angle: 22°

h(m)	E(lx)	D(m)
1	1257	0.50
2	314	0.99
3	140	1.49
4	79	1.99
5	50	2.48

Luminous flux luminaire 696 lm (EXTREME CUT OFF)

Light Shadow Wall-Washer No Trim 4 Spots

Light Source: Power LED 10,8W - 1080 lm - 2700K/CRI 90 / 10,8W - 1140lm - 3000K/CRI 90

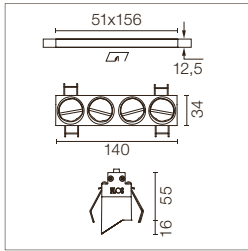

Apparecchio a incasso con 4 faretti LED. Fonte di alimentazione remota inclusa (220-240V).
Cornice di preinstallazione necessaria, da ordinare separatamente (08.0511.00).

Recessed integrated luminaire with 4 LED lighting spots. Remote power supply included (220-240V).
It requires a pre-installation frame, to be ordered separately (08.0511.00).

2700K

- 03.9903.40A
- 03.9903.14A
- Dali Version
- 03.9903.40ADA
- 03.9903.14ADA

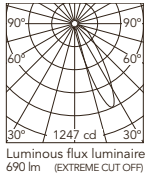

Beam Angle: 22°

h(m)	E(lx)	D(m)
1	1247	0.50
2	312	0.99
3	139	1.49
4	78	1.99
5	50	2.48

Luminous flux luminaire 690 lm (EXTREME CUT OFF)

3000K

- 03.9902.40A
- 03.9902.14A
- Dali Version
- 03.9902.40ADA
- 03.9902.14ADA

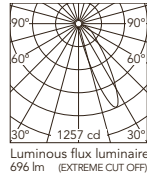

Beam Angle: 22°

h(m)	E(lx)	D(m)
1	1257	0.50
2	314	0.99
3	140	1.49
4	79	1.99
5	50	2.48

Luminous flux luminaire 696 lm (EXTREME CUT OFF)

LIGHT SHADOW

Accessori / Accessories

Light Shadow Fixed No Trim

Cornice di pre-installazione.
Pre-installation frame. 2L 08.0510.00

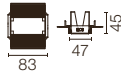

Cornice di pre-installazione.
Pre-installation frame. 4L 08.0511.00

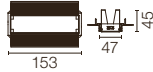

Cornice di pre-installazione.
Pre-installation frame. 8L 08.0512.00



Cornice di pre-installazione.
Pre-installation frame. 12L 08.0513.00



Accessorio per il montaggio No Trim, linea continua.
Ciascun accessorio consente la connessione tra due cornici No Trim per la preinstallazione. 08.0052.90



Accessory for mounting of No Trim continuous line.
Each accessory allows connection between two No Trim pre-installation frames.

Light Shadow Adjustable No Trim

Cornice di pre-installazione.
Pre-installation frame. 2L 08.0515.00

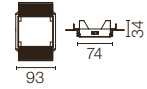

Cornice di pre-installazione.
Pre-installation frame. 4L 08.0516.00

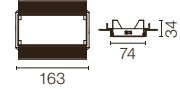

Cornice di pre-installazione.
Pre-installation frame. 8L 08.0517.00



Cornice di pre-installazione.
Pre-installation frame. 12L 08.0518.00



Accessorio per il montaggio No Trim, linea continua.
Ciascun accessorio consente la connessione tra due cornici No Trim per la preinstallazione. 08.0059.90



Accessory for mounting of No Trim continuous line.
Each accessory allows connection between two No Trim pre-installation frames.

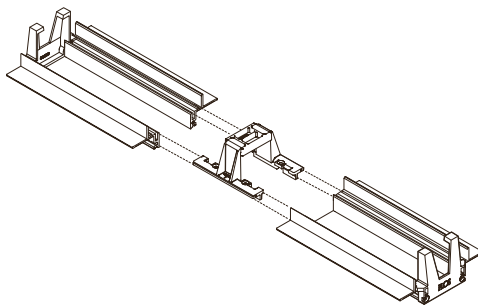

Dettaglio di connessione per costruire una linea continua / Interconnection information to build a continuous line

LIGHT SHADOW

Optic Medium 2700K

B E I
03.9722.40A
03.9722.14A
03.9822.40A
03.9822.14A

B E I
Dali Version
03.9722.40ADA
03.9722.14ADA
03.9822.40ADA
03.9822.14ADA

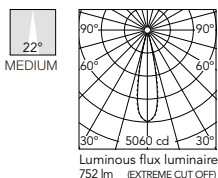

Beam Angle: 22°

h(m)	E(lx)	D(m)
1	5060	0.39
2	1265	0.77
3	562	1.16
4	316	1.55
5	202	1.94

Optic Medium 3000K

B E I
03.9732.40A
03.9732.14A
03.9832.40A
03.9832.14A

B E I
Dali Version
03.9732.40ADA
03.9732.14ADA
03.9832.40ADA
03.9832.14ADA

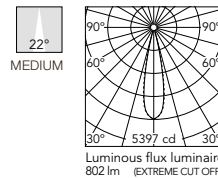

Beam Angle: 22°

h(m)	E(lx)	D(m)
1	5397	0.39
2	1349	0.77
3	600	1.16
4	337	1.55
5	216	1.94

2700K

B E I
03.9723.40A
03.9723.14A
03.9823.40A
03.9823.14A

B E I
Dali Version
03.9723.40ADA
03.9723.14ADA
03.9823.40ADA
03.9823.14ADA

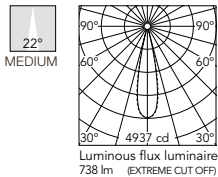

Beam Angle: 22°

h(m)	E(lx)	D(m)
1	4937	0.39
2	1234	0.78
3	549	1.17
4	309	1.56
5	197	1.95

3000K

B E I
03.9733.40A
03.9733.14A
03.9833.40A
03.9833.14A

B E I
Dali Version
03.9733.40ADA
03.9733.14ADA
03.9833.40ADA
03.9833.14ADA

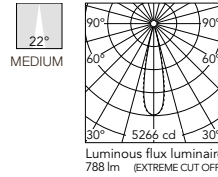

Beam Angle: 22°

h(m)	E(lx)	D(m)
1	5266	0.39
2	1316	0.78
3	585	1.17
4	329	1.56
5	211	1.95

Optic Flood 2700K

B E I
03.9726.40A
03.9726.14A
03.9826.40A
03.9826.14A

B E I
Dali Version
03.9726.40ADA
03.9726.14ADA
03.9826.40ADA
03.9826.14ADA

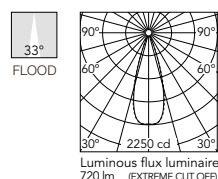

Beam Angle: 33°

h(m)	E(lx)	D(m)
1	2250	0.60
2	563	1.19
3	250	1.79
4	141	2.39
5	90	2.99

Optic Flood 3000K

B E I
03.9736.40A
03.9736.14A
03.9836.40A
03.9836.14A

B E I
Dali Version
03.9736.40ADA
03.9736.14ADA
03.9836.40ADA
03.9836.14ADA

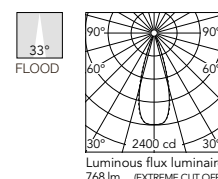

Beam Angle: 33°

h(m)	E(lx)	D(m)
1	2400	0.60
2	600	1.19
3	267	1.79
4	150	2.39
5	96	2.99

2700K

B E I
03.9725.40A
03.9725.14A
03.9825.40A
03.9825.14A

B E I
Dali Version
03.9725.40ADA
03.9725.14ADA
03.9825.40ADA
03.9825.14ADA

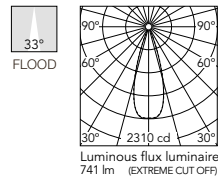

Beam Angle: 33°

h(m)	E(lx)	D(m)
1	2310	0.59
2	577	1.18
3	257	1.78
4	144	2.37
5	92	2.96

3000K

B E I
03.9735.40A
03.9735.14A
03.9835.40A
03.9835.14A

B E I
Dali Version
03.9735.40ADA
03.9735.14ADA
03.9835.40ADA
03.9835.14ADA

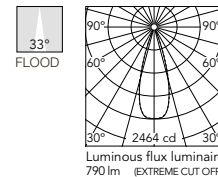

Beam Angle: 33°

h(m)	E(lx)	D(m)
1	2464	0.59
2	616	1.18
3	274	1.78
4	154	2.37
5	99	2.96

2700K

B E I
03.9727.40A
03.9727.14A
03.9827.40A
03.9827.14A

B E I
Dali Version
03.9727.40ADA
03.9727.14ADA
03.9827.40ADA
03.9827.14ADA

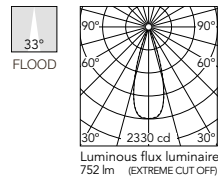

Beam Angle: 33°

h(m)	E(lx)	D(m)
1	2330	0.60
2	582	1.19
3	259	1.79
4	146	2.38
5	93	2.98

3000K

B E I
03.9737.40A
03.9737.14A
03.9837.40A
03.9837.14A

B E I
Dali Version
03.9737.40ADA
03.9737.14ADA
03.9837.40ADA
03.9837.14ADA

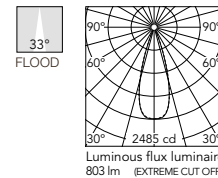

Beam Angle: 33°

h(m)	E(lx)	D(m)
1	2485	0.60
2	621	1.19
3	276	1.79
4	155	2.38
5	99	2.98

2700K

B E I
03.9728.40A
03.9728.14A
03.9828.40A
03.9828.14A

B E I
Dali Version
03.9728.40ADA
03.9728.14ADA
03.9828.40ADA
03.9828.14ADA

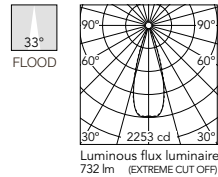

Beam Angle: 33°

h(m)	E(lx)	D(m)
1	2253	0.60
2	563	1.20
3	250	1.79
4	141	2.39
5	90	2.99

3000K

B E I
03.9738.40A
03.9738.14A
03.9838.40A
03.9838.14A

B E I
Dali Version
03.9738.40ADA
03.9738.14ADA
03.9838.40ADA
03.9838.14ADA

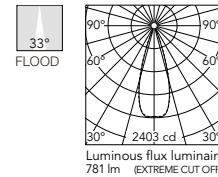

Beam Angle: 33°

h(m)	E(lx)	D(m)
1	2403	0.60
2	601	1.20
3	267	1.79
4	150	2.39
5	96	2.99

LIGHT SHADOW

Light Shadow Surface 4 Spots

Light Source: Power LED 10,8W - 1080 lm - 2700K/CRI 90 / 10,8W - 1140lm - 3000K/CRI 90

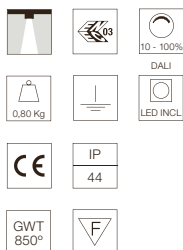
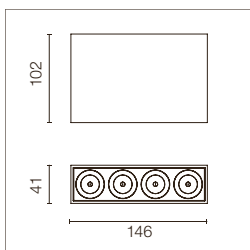

Apparecchio per illuminazione di superficie con 4 spot LED. Fonte di alimentazione 220-240V incorporata.

Surface luminaire with 4 LED lighting spots. Power source 220-240V incorporated.

E= Finitura Esterna
I= Finitura Interna
B= Finitura Box

E= External Finish
I= Internal Finish
B= Box Finish

Optic Wide Flood

2700K

B	E	I
03.9761.40A		
03.9761.14A		
03.9861.40A		
03.9861.14A		
Dali Version		
03.9761.40ADA		
03.9761.14ADA		
03.9861.40ADA		
03.9861.14ADA		

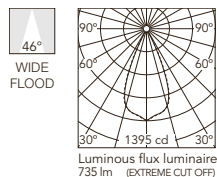

Optic Wide Flood

3000K

B	E	I
03.9765.40A		
03.9765.14A		
03.9865.40A		
03.9865.14A		
Dali Version		
03.9765.40ADA		
03.9765.14ADA		
03.9865.40ADA		
03.9865.14ADA		

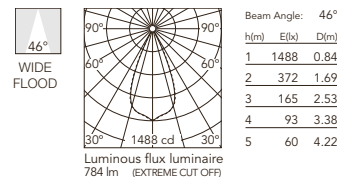

2700K

B	E	I
03.9760.40A		
03.9760.14A		
03.9860.40A		
03.9860.14A		
Dali Version		
03.9760.40ADA		
03.9760.14ADA		
03.9860.40ADA		
03.9860.14ADA		

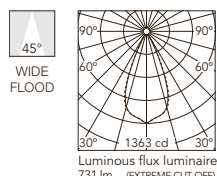

3000K

B	E	I
03.9764.40A		
03.9764.14A		
03.9864.40A		
03.9864.14A		
Dali Version		
03.9764.40ADA		
03.9764.14ADA		
03.9864.40ADA		
03.9864.14ADA		

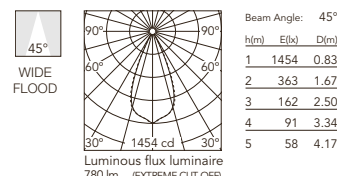

2700K

B	E	I
03.9762.40A		
03.9762.14A		
03.9862.40A		
03.9862.14A		
Dali Version		
03.9762.40ADA		
03.9762.14ADA		
03.9862.40ADA		
03.9862.14ADA		

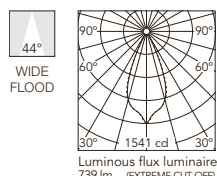

3000K

B	E	I
03.9766.40A		
03.9766.14A		
03.9866.40A		
03.9866.14A		
Dali Version		
03.9766.40ADA		
03.9766.14ADA		
03.9866.40ADA		
03.9866.14ADA		

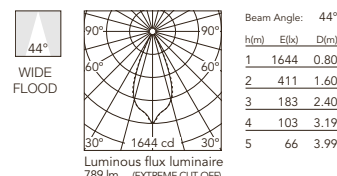

2700K

B	E	I
03.9763.40A		
03.9763.14A		
03.9863.40A		
03.9863.14A		
Dali Version		
03.9763.40ADA		
03.9763.14ADA		
03.9863.40ADA		
03.9863.14ADA		

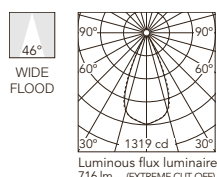

3000K

B	E	I
03.9767.40A		
03.9767.14A		
03.9867.40A		
03.9867.14A		
Dali Version		
03.9767.40ADA		
03.9767.14ADA		
03.9867.40ADA		
03.9867.14ADA		

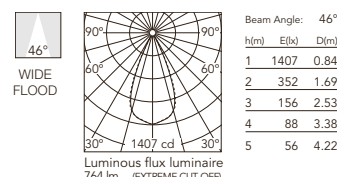

LIGHT SHADOW

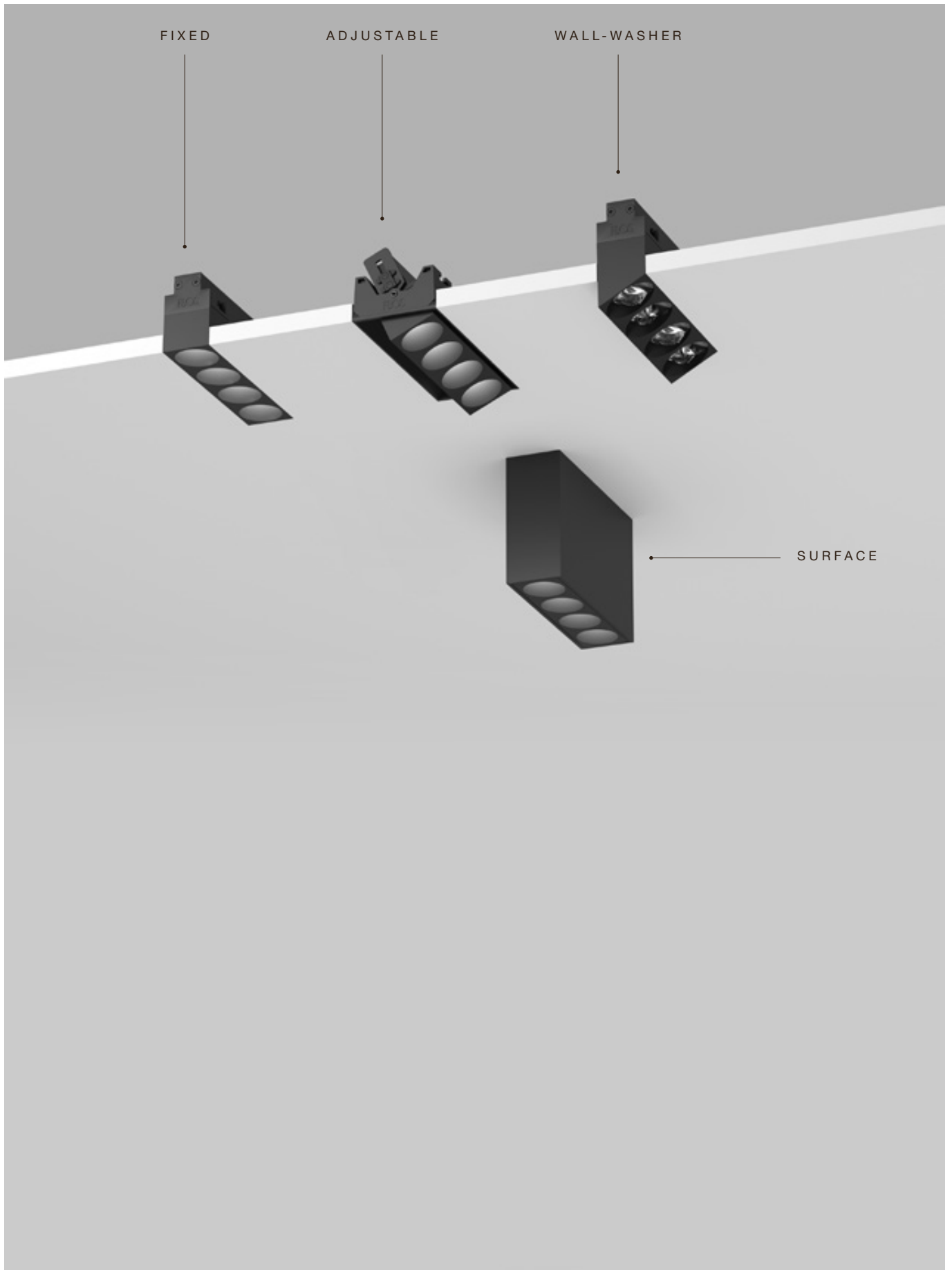

LIGHT SHADOW PRO&DOTS

DESIGNED BY FLOS ARCHITECTURAL

DOTS Ø30
FIXED

LIGHT SOURCE
POWER LED
3W
270 lm
2700K/CRI 90
285 lm
3000K/CRI 90

PRO Ø60
FIXED

LIGHT SOURCE
LED ARRAY
Up to 15W
1325 lm
2700K/CRI 90
1427 lm
3000K/CRI 90
1515 lm
4000K/CRI 90

PRO Ø60
ADJUSTABLE

LIGHT SOURCE
LED ARRAY
10,5W
1035 lm
2700K/CRI 90
1115 lm
3000K/CRI 90
1185 lm
4000K/CRI 90

PRO Ø90
FIXED

LIGHT SOURCE
LED ARRAY
Up to 22W
2324 lm
2700K/CRI 90
2419 lm
3000K/CRI 90
2520 lm
4000K/CRI 90

PRO Ø90
ADJUSTABLE

LIGHT SOURCE
LED ARRAY
Up to 18W
1590 lm
2700K/CRI 90
1710 lm
3000K/CRI 90
1815 lm
4000K/CRI 90

HIGH COMFORT

■ 14 Nero
14 Black



□ 40 Bianco
40 White



■ 06 Cromo
06 Chrome



■ GL Oro Satinato
GL Matt Gold



Descrizione

Apparecchi di illuminazione per interni a incasso. Sono l'evoluzione naturale di Light Shadow, ora disponibile nelle versioni Dots e Pro. Grazie alle loro qualità principali (dimensione ridotta, rendimento ed elevato controllo dell'abbagliamento) si riescono a integrare totalmente negli spazi con grande facilità.

La famiglia nasce dalla necessità di un apparecchio di illuminazione compatto e di facile installazione, con lo stile distintivo di Flos, in grado di produrre un'illuminazione ad alta efficienza e rispettando al contempo i più elevati standard di comfort visivo, in versioni con corpi di schermatura neri.

Le nuove versioni Pro sono il risultato di un'attenta ricerca ottica. Lente a doppio fuoco sviluppata da FLOS appositamente per questi prodotti. Garantisce il massimo controllo ottico e un'omogeneità della luce eccezionale. Light Shadow Pro sfrutta i benefici di un'innovativa lente in silicone micro texturizzata che permette un controllo estremo oltre a raggiungere un'efficienza assoluta, resistenza al calore e massima qualità nella distribuzione della luce. L'apparecchio integra un LED Array abbinato ad un controllo speciale del fascio luminoso che permette di ottenere fasci molto stretti e illuminazione generale diffusa secondo le esigenze. Gruppo ottico cut-off integrato. Il Kit ottico disponibile include 5 aperture di fascio differenziate, ognuna sviluppata per un'applicazione speciale. Sia nel caso di fasci intensivi che di effetti di luce diffusa, il controllo ottico è sempre eccezionale e la luce spuria è totalmente assente.

Sistema ottico

- Light Shadow Dots 1/2/4 spots: Spot, Medium, Flood, Wide Flood. 2700K, 3000K.

- Light Shadow Pro Ø60 Super Spot, Spot, Medium, Flood, Wide Flood. 2700K, 3000K, 4000K.

- Light Shadow Pro Ø90 Super Spot, Spot, Medium, Flood, Wide Flood. 2700K, 3000K, 4000K.

La famiglia viene offerta con ottiche di super accento, accento e illuminazione generale. Per offrire soluzioni in ambienti più decorativi, è stata sviluppata la seguente gamma di colori con le seguenti finiture del gruppo ottico: bianco, oro opaco, cromo e nero.

La finitura nera fornisce il maggior livello di comfort visivo, minimizzando l'abbagliamento e la visibilità diretta della sorgente LED.

Unità di Alimentazione

Driver remoto non incluso.

Versioni dimmerabili disponibili con 0-10V, DALI e Casambi.

Per gestione con il sistema Casambi (Max. 200 apparecchi) è necessario scaricare la app FLOS Control® powered by Casambi (disponibile in Apple Store e Google Play) per dispositivi mobili. Disponibili versioni a 110V su ordinazione.

Accessori

La cornice di installazione realizzata in materiale plastico è sempre necessaria per l'installazione nel controsoffitto. Richiedere separatamente.

La versione Pro è disponibile nelle varianti Trim e No Trim.

La versione Dots è disponibile esclusivamente come No Trim.

La cornice di installazione dev'essere richiesta separatamente e in alcuni casi implica un accesso remoto al driver. Per utilizzare un solo driver per più spot è necessario realizzare una connessione in serie. Il driver dev'essere collegato direttamente alle cornici d'installazione nella versione Dots.

Informazioni Aggiuntive

Le cornici di installazione sono compatibili con controsoffitti di spessore fino a 25mm.

Grado di protezione IP20, IP23, IP54 a seconda delle versioni.

Classe di isolamento III.

Adatti ad installazioni su superfici normalmente infiammabili.

Conformità e Marchi di Qualità

Apparecchio conforme alla Normativa Tecnica Europea EN60598-1 e relative parti seconde.

Description

Recessed indoor luminaires. The natural evolution of Light Shadow, now available in Dots and Pro versions.

Due to their main qualities (reduced size, high performance and great screening), they facilitate total integration into spaces.

The family was born of the need for a compact, easy to- install luminaire, with the distinctive Flos style, able to produce high efficiency lighting, while respecting the highest standards of visual comfort, in versions with black screening bodies.

The new Pro versions are the result of a careful optical research. Dual focus lens specifically developed by FLOS for these products. Ensures maximum optical control and exceptionally even light beams. Light Shadow Pro takes advantage of an innovative micro-textured silicone lens that allows extreme control as well as providing absolute efficiency, heat resistance and maximum quality in light distribution. It incorporates an LED Array with an innovative light projection treatment that allows very narrow optics and general lighting. Integrated full cut-off.

The optical kit available includes 5 differentiated beam openings, each developed for a specific target application. Whether it's intensive beams or diffused light effects, optical control is always exceptional and fall-off is totally absent.

Optical system

- Light Shadow Dots 1/2/4 spots: Spot, Medium, Flood, Wide Flood. 2700K, 3000K.

- Light Shadow Pro Ø60 Super Spot, Spot, Medium, Flood, Wide Flood. 2700K, 3000K, 4000K.

- Light Shadow Pro Ø90 Super Spot, Spot, Medium, Flood, Wide Flood. 2700K, 3000K, 4000K.

The family is offered with super narrow, accent and general lighting optics.

As a solution dedicated to more decorative settings, the following range of colours has been developed for the interior of the luminaire: white, matte gold, chrome and black (high comfort optics).

The black finish brings maximum visual comfort, avoids glare and totally hides the LED source from direct view.

Power Supply

Remote equipment not included.

Dimmable version available with 0-10V, DALI and Casambi.

For Casambi management (Max. 200 luminaires) it is mandatory to use fixtures in the Casambi version.

For managing and controlling the Casambi system, the FLOS Control® app powered by Casambi for mobile devices is necessary (available in the Apple Store and Google Play).

110V units available on request.

Accessories

The pre-installation frame made of plastic material is always required for installation in false ceiling, to be ordered separately.

The Pro version is available in the Trim and No Trim versions.

The Dots version is only available in the No Trim version.

The installation frame must be ordered separately and remote access to the driver is necessary in some cases. To use only one driver for various spots, connect the spots in series. The driver should be connected directly to the recessed frames in the Dots version.

Additional Information

Installation frames are designed for installation on ceilings up to 25mm of thickness.

IP20, IP23, IP54 protection grade depending on the versions.

Insulation class III.

Suitable for installation on normally inflammable surfaces.

Standard Compliance and Quality Marks

EN60598-1 European Technical Standards and any subsequent additions.

FLOS
CONTROL BY CASAMBI



LIGHT SHADOW DOTS

Light Shadow DOTS Ø30 - Single Spot Module

Light Source: Power LED DC 900 mA - 3W - 270 lm - 2700K/CRI 90 / 3W - 285 lm - 3000K/CRI 90

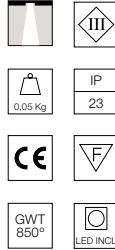
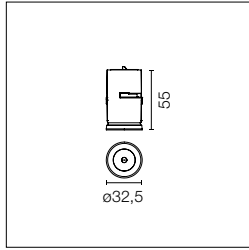

Modulo di illuminazione LED, a basso abbagliamento, da installare su cornici da incasso (non incluse), installazione con sistema a baionetta con faretto scambiabili. Disponibile in versioni con un faretto e gruppi di due e quattro faretto. Driver non compreso, il driver si collega direttamente alle cornici da incasso.

LED lighting module, with low glare, to be inserted in the recessed frames (not included), installation through a bayonet system with interchangeable spots. Available in one-light versions and groups of two and four lights. Driver not included, the driver has to be directly connected to the embedding frames.

2700K

Set of 1 spot

- 03.8600.40A
- 03.8600.14A
- 03.8600.06A
- 03.8600.GLA

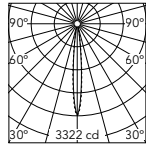

Beam Angle: 10°

h(m)	E(lx)	D(m)
1	3322	0.18
2	831	0.36
3	369	0.55
4	208	0.73
5	133	0.91

Luminous flux luminaire 189 lm (EXTREME CUT OFF)

Set of 2 spots

- 03.8640.40A
- 03.8640.14A
- 03.8640.06A
- 03.8640.GLA

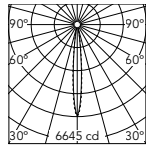

Beam Angle: 10°

h(m)	E(lx)	D(m)
1	6645	0.18
2	1661	0.36
3	738	0.55
4	415	0.73
5	266	0.91

Luminous flux luminaire 377 lm (EXTREME CUT OFF)

Set of 4 spots

- 03.8610.40A
- 03.8610.14A
- 03.8610.06A
- 03.8610.GLA

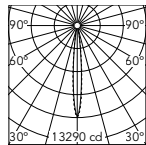

Beam Angle: 10°

h(m)	E(lx)	D(m)
1	13290	0.18
2	3322	0.36
3	1477	0.55
4	831	0.73
5	532	0.91

Luminous flux luminaire 754 lm (EXTREME CUT OFF)

@Chrome (06)

2700K

Set of 1 spot

- 03.8601.40A
- 03.8601.14A
- 03.8601.06A
- 03.8601.GLA

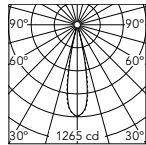

Beam Angle: 22°

h(m)	E(lx)	D(m)
1	1265	0.39
2	316	0.77
3	141	1.16
4	79	1.55
5	51	1.94

Luminous flux luminaire 188 lm (EXTREME CUT OFF)

Set of 2 spots

- 03.8641.40A
- 03.8641.14A
- 03.8641.06A
- 03.8641.GLA

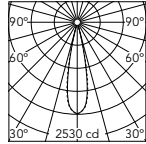

Beam Angle: 22°

h(m)	E(lx)	D(m)
1	2530	0.39
2	632	0.77
3	281	1.16
4	158	1.55
5	101	1.94

Luminous flux luminaire 376 lm (EXTREME CUT OFF)

Set of 4 spots

- 03.8611.40A
- 03.8611.14A
- 03.8611.06A
- 03.8611.GLA

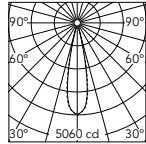

Beam Angle: 22°

h(m)	E(lx)	D(m)
1	5060	0.39
2	1265	0.77
3	562	1.16
4	316	1.55
5	202	1.94

Luminous flux luminaire 752 lm (EXTREME CUT OFF)

@Chrome (06)

3000K

Set of 1 spot

- 03.8603.40A
- 03.8603.14A
- 03.8603.06A
- 03.8603.GLA

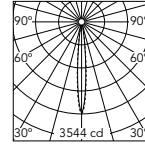

Beam Angle: 10°

h(m)	E(lx)	D(m)
1	3544	0.18
2	886	0.36
3	394	0.55
4	221	0.73
5	142	0.91

Luminous flux luminaire 201 lm (EXTREME CUT OFF)

Set of 2 spots

- 03.8643.40A
- 03.8643.14A
- 03.8643.06A
- 03.8643.GLA

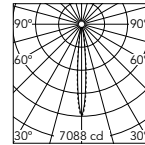

Beam Angle: 10°

h(m)	E(lx)	D(m)
1	7088	0.18
2	1772	0.36
3	788	0.55
4	443	0.73
5	284	0.91

Luminous flux luminaire 402 lm (EXTREME CUT OFF)

Set of 4 spots

- 03.8613.40A
- 03.8613.14A
- 03.8613.06A
- 03.8613.GLA

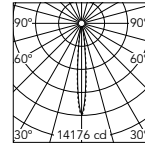

Beam Angle: 10°

h(m)	E(lx)	D(m)
1	14176	0.18
2	3544	0.36
3	1575	0.55
4	886	0.73
5	567	0.91

Luminous flux luminaire 805 lm (EXTREME CUT OFF)

@Chrome (06)

3000K

Set of 1 spot

- 03.8604.40A
- 03.8604.14A
- 03.8604.06A
- 03.8604.GLA

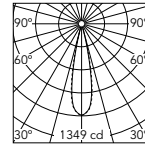

Beam Angle: 22°

h(m)	E(lx)	D(m)
1	1349	0.39
2	337	0.77
3	150	1.16
4	84	1.55
5	54	1.94

Luminous flux luminaire 201 lm (EXTREME CUT OFF)

Set of 2 spots

- 03.8644.40A
- 03.8644.14A
- 03.8644.06A
- 03.8644.GLA

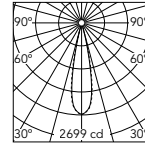

Beam Angle: 22°

h(m)	E(lx)	D(m)
1	2699	0.39
2	675	0.77
3	300	1.16
4	169	1.55
5	108	1.94

Luminous flux luminaire 401 lm (EXTREME CUT OFF)

Set of 4 spots

- 03.8614.40A
- 03.8614.14A
- 03.8614.06A
- 03.8614.GLA

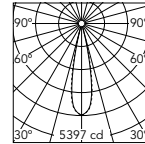

Beam Angle: 22°

h(m)	E(lx)	D(m)
1	5397	0.39
2	1349	0.77
3	600	1.16
4	337	1.55
5	216	1.94

Luminous flux luminaire 802 lm (EXTREME CUT OFF)

@Chrome (06)

2700K

Set of 1 spot

- 03.8602.40A
- 03.8602.14A
- 03.8602.06A
- 03.8602.GLA

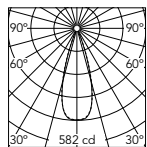

Beam Angle: 33°

h(m)	El(x)	D(m)
1	582	0.60
2	146	1.19
3	65	1.79
4	36	2.38
5	23	2.98

Luminous flux luminaire
188 lm (EXTREME CUT OFF)

Set of 2 spots

- 03.8642.40A
- 03.8642.14A
- 03.8642.06A
- 03.8642.GLA

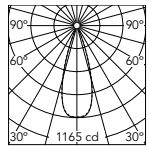

Beam Angle: 33°

h(m)	El(x)	D(m)
1	1165	0.60
2	291	1.19
3	129	1.79
4	73	2.38
5	47	2.98

Luminous flux luminaire
376 lm (EXTREME CUT OFF)

Set of 4 spots

- 03.8612.40A
- 03.8612.14A
- 03.8612.06A
- 03.8612.GLA

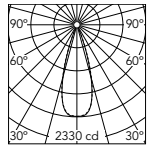

Beam Angle: 33°

h(m)	El(x)	D(m)
1	2330	0.60
2	582	1.19
3	259	1.79
4	146	2.38
5	93	2.98

Luminous flux luminaire
752 lm (EXTREME CUT OFF)
@Chrome (06)

2700K

Set of 1 spot

- 03.8630.40A
- 03.8630.14A
- 03.8630.06A
- 03.8630.GLA

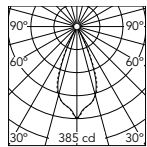

Beam Angle: 44°

h(m)	El(x)	D(m)
1	385	0.80
2	96	1.60
3	43	2.40
4	24	3.19
5	15	3.99

Luminous flux luminaire
185 lm (EXTREME CUT OFF)

Set of 2 spots

- 03.8646.40A
- 03.8646.14A
- 03.8646.06A
- 03.8646.GLA

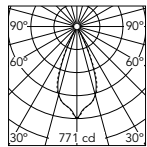

Beam Angle: 44°

h(m)	El(x)	D(m)
1	771	0.80
2	193	1.60
3	86	2.40
4	48	3.19
5	31	3.99

Luminous flux luminaire
370 lm (EXTREME CUT OFF)

Set of 4 spots

- 03.8635.40A
- 03.8635.14A
- 03.8635.06A
- 03.8635.GLA

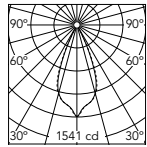

Beam Angle: 44°

h(m)	El(x)	D(m)
1	1541	0.80
2	385	1.60
3	171	2.40
4	96	3.19
5	62	3.99

Luminous flux luminaire
739 lm (EXTREME CUT OFF)
@Chrome (06)

3000K

Set of 1 spot

- 03.8605.40A
- 03.8605.14A
- 03.8605.06A
- 03.8605.GLA

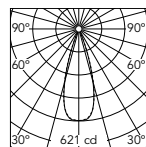

Beam Angle: 33°

h(m)	El(x)	D(m)
1	621	0.60
2	155	1.19
3	69	1.79
4	39	2.38
5	25	2.98

Luminous flux luminaire
201 lm (EXTREME CUT OFF)

Set of 2 spots

- 03.8645.40A
- 03.8645.14A
- 03.8645.06A
- 03.8645.GLA

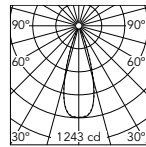

Beam Angle: 33°

h(m)	El(x)	D(m)
1	1243	0.60
2	311	1.19
3	138	1.79
4	78	2.38
5	50	2.98

Luminous flux luminaire
401 lm (EXTREME CUT OFF)

Set of 4 spots

- 03.8615.40A
- 03.8615.14A
- 03.8615.06A
- 03.8615.GLA

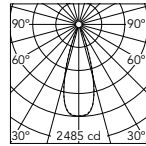

Beam Angle: 33°

h(m)	El(x)	D(m)
1	2485	0.60
2	621	1.19
3	276	1.79
4	155	2.38
5	99	2.98

Luminous flux luminaire
803 lm (EXTREME CUT OFF)
@Chrome (06)

3000K

Set of 1 spot

- 03.8631.40A
- 03.8631.14A
- 03.8631.06A
- 03.8631.GLA

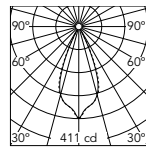

Beam Angle: 44°

h(m)	El(x)	D(m)
1	411	0.80
2	103	1.60
3	46	2.40
4	26	3.19
5	16	3.99

Luminous flux luminaire
197 lm (EXTREME CUT OFF)

Set of 2 spots

- 03.8647.40A
- 03.8647.14A
- 03.8647.06A
- 03.8647.GLA

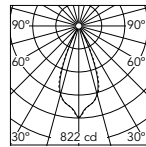

Beam Angle: 44°

h(m)	El(x)	D(m)
1	822	0.80
2	206	1.60
3	91	2.40
4	51	3.19
5	33	3.99

Luminous flux luminaire
394 lm (EXTREME CUT OFF)

Set of 4 spots

- 03.8636.40A
- 03.8636.14A
- 03.8636.06A
- 03.8636.GLA

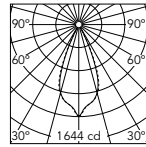

Beam Angle: 44°

h(m)	El(x)	D(m)
1	1644	0.80
2	411	1.60
3	183	2.40
4	103	3.19
5	66	3.99

Luminous flux luminaire
789 lm (EXTREME CUT OFF)
@Chrome (06)

Accessori / Accessories

Cornice di pre-installazione.
Pre-installation frame.

1L
08.0580.00

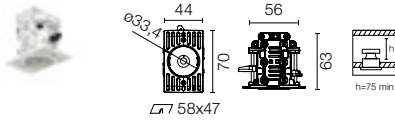

Cornice di pre-installazione.
Pre-installation frame.

2L - Int 70
08.0583.00

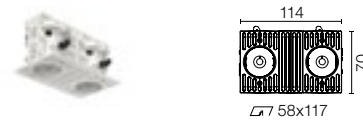

Cornice di pre-installazione.
Pre-installation frame.

2L - Int 43
08.0581.00

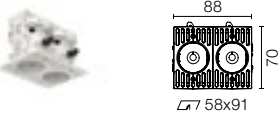

Cornice di pre-installazione.
Pre-installation frame.

4L - Int 70
08.0584.00

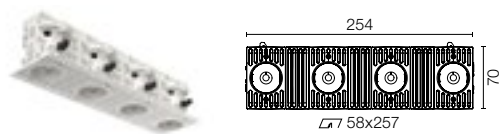

Cornice di pre-installazione.
Pre-installation frame.

4L - Int 43
08.0582.00

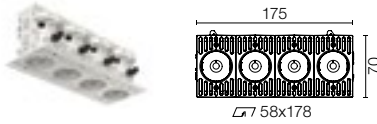

Separatore di 70mm per
mantenere la distanza che si
crea tra i faretti unendo moduli
di 70mm.

08.0586.00

70 mm divider to keep the
spacing between spots when
putting together 70 mm
modules.

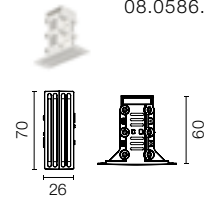

Driver / Drivers

Fonte di alimentazione a corrente
costante 15W (110V) - 20W
(240V) - 50/60Hz, con corrente di
alimentazione selezionabile tramite
switch 900 mA non regolabile.

Non dimmable continuous current
power supply of 15W (110V) - 20W
(240V) - 50/60Hz, with power
current selected through non-
adjustable 900 mA switch.

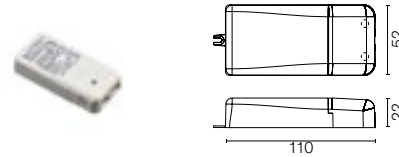

1/2/4L* - No Dim
60.8911

Fonte di alimentazione a corrente
costante 13-38W, 220/240V
- 50/60Hz con corrente di
alimentazione selezionabile tramite
switch 900 mA non regolabile.

Continuous current power supply
of 13-38W, 220/240V - 50/60Hz
with power current selected through
non-adjustable 900 mA switch.

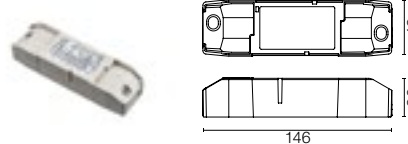

2/4L** - No Dim
RF27370

Fonte di alimentazione a corrente
costante 20W, dimmer 0-10V,
220/240V - 50/60Hz con corrente di
alimentazione 900 mA.

Non dimmable continuous current
power supply of 20W, dimmable
0-10V, 220/240V - 50/60Hz with
power current 900 mA.



1/2/4L* - Dim 0-10V
60.9414

Fonte di alimentazione a corrente
costante 20W, dimmer DALI 2,
220/240V - 50/60Hz con corrente di
alimentazione 900 mA.

Continuous current power supply of
20W, dimmable DALI 2, 220/240V
- 50/60Hz with power current 900
mA.



1/2/4L* - Dim DALI
60.9602

Fonte di alimentazione a corrente
costante, dimmerabile Casambi,
con corrente di alimentazione
selezionabile tramite switch 900 mA
38W, 220/240V - 50/60Hz.

Continuous current power supply,
dimmable Casambi, with power
current selected through 900 mA
38W switch, 220/240V - 50/60Hz.

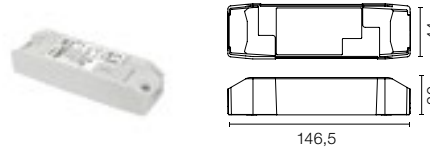

1/2/4L**
60.9207

* È possibile alimentare fino a 6 lampade (spot) con lo stesso driver e con un collegamento in serie / It is possible to feed up to 6 lights (spots) using the same driver and with a serial connection.

** È possibile alimentare fino a 11 lampade (spot) con lo stesso driver e con un collegamento in serie / It is possible to feed up to 11 lights (spots) using the same driver and with a serial connection.

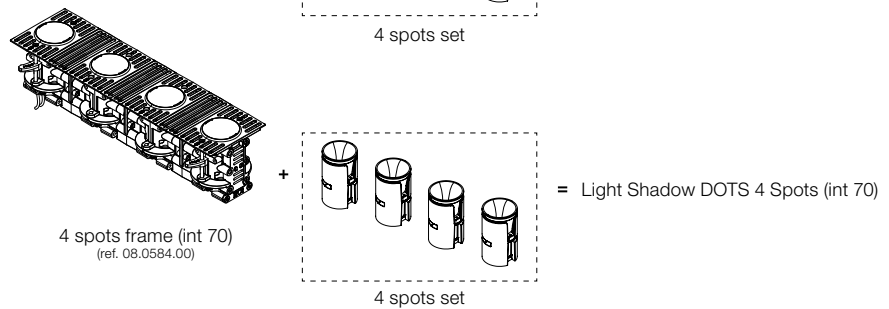
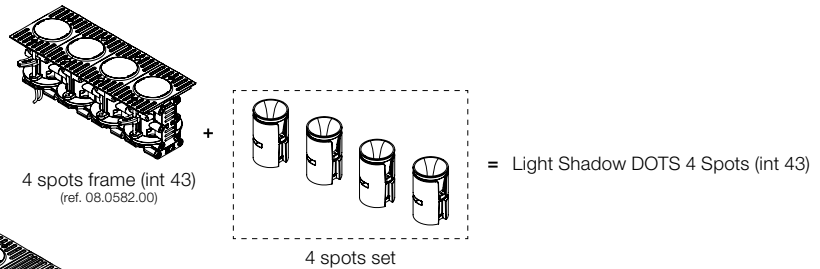
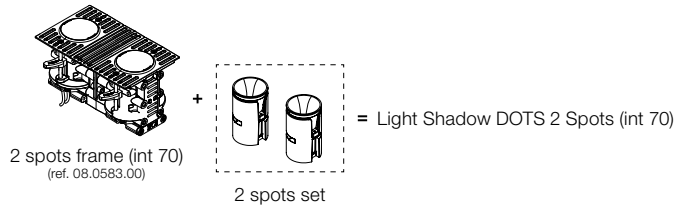
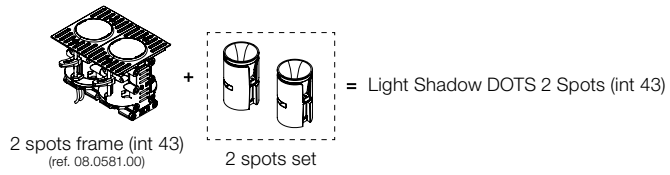
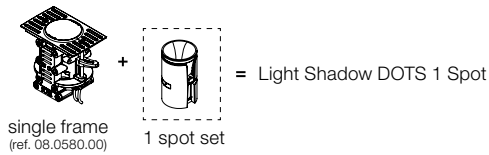
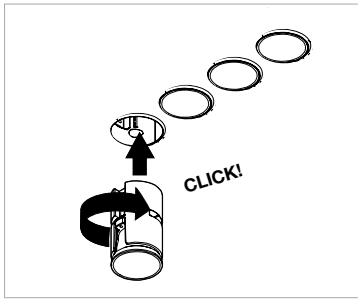

Nella progettazione dell'illuminazione di un ambiente, la linea Light Shadow Dots permette di proiettare linee di luce continue grazie al semplice collegamento tra gli apparecchi (1, 2 e 4 luci) senza essere necessario l'uso di strumenti aggiuntivi. Durante la progettazione, l'utente potrà scegliere una delle due distanze predefinite tra punti di luce, 43 e 70mm; per la versione di 70mm è richiesto il montaggio di un accessorio indipendente (cod. 08.0584.00) tra gli apparecchi.

When planning the lighting of an environment, the Light Shadow Dots family allows to project continuous light lines or random figures thanks to the simple interconnection between its luminaires (1, 2 and 4 lights) without the need for an additional tool. For the lighting designning and planning, the user can choose between two predefined distances of 43 and 70 mm between light points. For the 70 mm version, it is necessary to assemble an independent accessory (reference: 08.0584.00) between the luminaires.

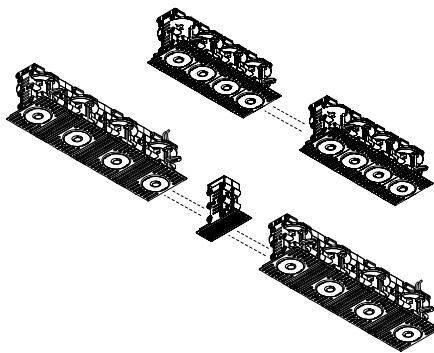

Dettaglio di connessione per costruire una linea continua / Interconnection information to build a continuous line

LIGHT SHADOW PRO

Light Shadow PRO Ø60 Fixed

Light Source: LED Array DC Up to 400 mA 15W - 1325 lm - 2700K/CRI 90 / 15W - 1427 lm - 3000K/CRI 90 / 15W - 1515 lm - 4000K/CRI 90
 LED Array DC 300 mA** 11W - 1037lm - 2700K/CRI 90 / 11W - 1117 lm - 3000K/CRI 90 / 11W - 1185 lm - 4000K/CRI 90

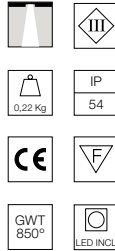
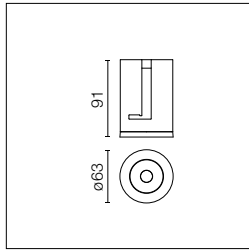

Modulo di illuminazione LED, a basso abbagliamento, da installare su cornici da incasso (non incluse), installazione con sistema a baionetta. Driver remoto non incluso.

LED lighting module, with low glare, to be inserted in the recessed frames (not included), installation through a bayonet system with interchangeable spots. Remote driver not included.

**Selezionare l'impostazione 300 mA nel driver remoto in modo che corrisponda alla potenza della versione "Adjustable".

**Please select 300 mA setting in the remote driver to match the power of the Adjustable version.

Alimentazioni raccomandate / Recommended power supply*:

	300mA	400mA
Non Dimmable 220-240V	60.9160	60.9160
Mains Dimming	60.9467	60.9467
Dim 1-10V 220-240V	60.9439	60.9439
Dim 1-10V/Push 110-240V	RF27961	RF27961
Dim Dali 2 220-240V	RF30699	RF30699
Dim Dali 2 110-240V		60.9222
Dim Casambi	60.9207	60.9207

* Vedi capitolo Drivers / Refer to the Drivers chapter

Optic Spot 2700K

- 03.9950.40
- 03.9950.14
- 03.9950.06
- 03.9950.GL

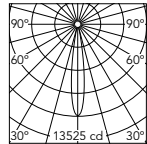

Beam Angle: 16°

h(m)	E(lx)	D(m)
1	13525	0.27
2	3381	0.55
3	1503	0.82
4	845	1.10
5	541	1.37

Luminous flux luminaire 1203 lm

Optic Medium 2700K

- 03.9951.40
- 03.9951.14
- 03.9951.06
- 03.9951.GL

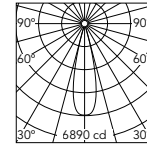

Beam Angle: 25°

h(m)	E(lx)	D(m)
1	6890	0.45
2	1722	0.89
3	766	1.34
4	431	1.78
5	276	2.23

Luminous flux luminaire 1180 lm

3000K

- 03.9954.40
- 03.9954.14
- 03.9954.06
- 03.9954.GL

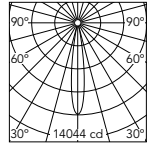

Beam Angle: 16°

h(m)	E(lx)	D(m)
1	14044	0.27
2	3511	0.55
3	1560	0.82
4	878	1.10
5	562	1.37

Luminous flux luminaire 1249 lm

3000K

- 03.9955.40
- 03.9955.14
- 03.9955.06
- 03.9955.GL

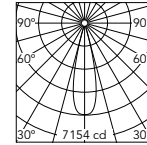

Beam Angle: 25°

h(m)	E(lx)	D(m)
1	7154	0.45
2	1789	0.89
3	795	1.34
4	447	1.78
5	286	2.23

Luminous flux luminaire 1226 lm

4000K

- 03.9910.40
- 03.9910.14
- 03.9910.06
- 03.9910.GL

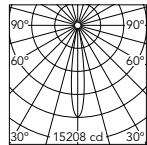

Beam Angle: 16°

h(m)	E(lx)	D(m)
1	15208	0.27
2	3802	0.55
3	1690	0.82
4	951	1.10
5	608	1.37

Luminous flux luminaire 1353 lm

4000K

- 03.9911.40
- 03.9911.14
- 03.9911.06
- 03.9911.GL

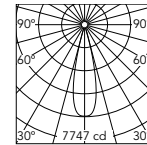

Beam Angle: 25°

h(m)	E(lx)	D(m)
1	7747	0.45
2	1937	0.89
3	861	1.34
4	484	1.78
5	310	2.23

Luminous flux luminaire 1327 lm

Optic Flood 2700K

- 03.9952.40
- 03.9952.14
- 03.9952.06
- 03.9952.GL

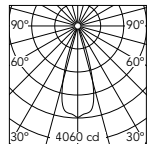

Beam Angle: 34°

h(m)	E(lx)	D(m)
1	4060	0.61
2	1015	1.22
3	451	1.82
4	254	2.43
5	162	3.04

Luminous flux luminaire 1225 lm

Optic Wide Flood 2700K

- 03.9953.40
- 03.9953.14
- 03.9953.06
- 03.9953.GL

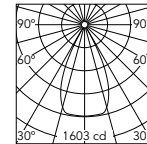

Beam Angle: 51°

h(m)	E(lx)	D(m)
1	1603	0.95
2	401	1.89
3	178	2.84
4	100	3.79
5	64	4.74

Luminous flux luminaire 1194 lm

3000K

- 03.9956.40
- 03.9956.14
- 03.9956.06
- 03.9956.GL

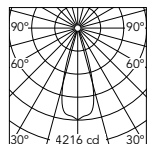

Beam Angle: 34°

h(m)	E(lx)	D(m)
1	4216	0.61
2	1054	1.22
3	468	1.82
4	264	2.43
5	169	3.04

Luminous flux luminaire 1272 lm

3000K

- 03.9957.40
- 03.9957.14
- 03.9957.06
- 03.9957.GL

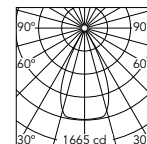

Beam Angle: 51°

h(m)	E(lx)	D(m)
1	1665	0.95
2	416	1.89
3	185	2.84
4	104	3.79
5	67	4.74

Luminous flux luminaire 1240 lm

4000K

- 03.9912.40
- 03.9912.14
- 03.9912.06
- 03.9912.GL

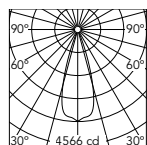

Beam Angle: 34°

h(m)	E(lx)	D(m)
1	4566	0.61
2	1141	1.22
3	507	1.82
4	285	2.43
5	183	3.04

Luminous flux luminaire 1378 lm

4000K

- 03.9913.40
- 03.9913.14
- 03.9913.06
- 03.9913.GL

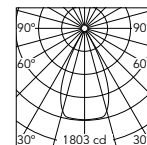

Beam Angle: 51°

h(m)	E(lx)	D(m)
1	1803	0.95
2	451	1.89
3	200	2.84
4	113	3.79
5	72	4.74

Luminous flux luminaire 1343 lm

LIGHT SHADOW PRO

Light Shadow PRO Ø60 Adjustable

Light Source: LED Array DC 300 mA 10,5W - 1035 lm - 2700K/CRI 90 / 10,5W - 1115 lm - 3000K/CRI 90 / 10,5W - 1185 lm - 4000K/CRI 90

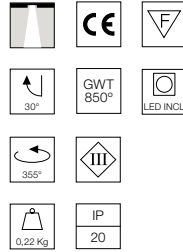
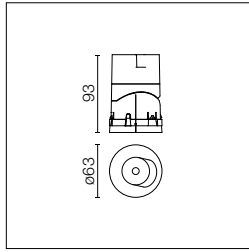

Modulo di illuminazione LED, a basso abbagliamento, da installare su cornici da incasso (non incluse), con spots intercambiabili. Driver remoto non incluso.

LED lighting module, with low glare, to be inserted in the recessed frames (not included), with interchangeable spots. Remote driver not included.

Alimentazioni raccomandate / Recommended power supply*:

Non Dimmable 220-240V	60.9160
Mains Dimming	60.9467
Dim 1-10V 220-240V	60.9439
Dim 1-10V/Push 110-240V	RF27961
Dim Dali 2 220-240V	RF30699
Dim Casambi	60.9207

* Vedi capitolo Drivers / Refer to the Drivers chapter

Optic Spot 2700K

- 03.9971.40A
- 03.9971.14A
- 03.9971.06A
- 03.9971.GLA

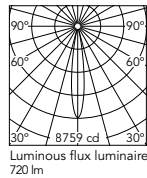

Beam Angle: 15°

h(m)	E(lx)	D(m)
1	8759	0.27
2	2190	0.54
3	973	0.81
4	547	1.08
5	351	1.35

Luminous flux luminaire 720 lm

3000K

- 03.9976.40A
- 03.9976.14A
- 03.9976.06A
- 03.9976.GLA

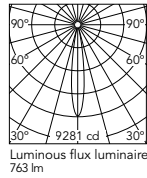

Beam Angle: 15°

h(m)	E(lx)	D(m)
1	9281	0.27
2	2320	0.54
3	1031	0.81
4	580	1.08
5	372	1.35

Luminous flux luminaire 763 lm

4000K

- 03.9931.40A
- 03.9931.14A
- 03.9931.06A
- 03.9931.GLA

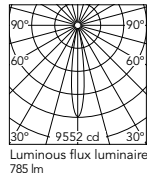

Beam Angle: 15°

h(m)	E(lx)	D(m)
1	9552	0.27
2	2388	0.54
3	1062	0.81
4	597	1.08
5	382	1.35

Luminous flux luminaire 785 lm

@Chrome (06)

Optic Medium 2700K

- 03.9972.40A
- 03.9972.14A
- 03.9972.06A
- 03.9972.GLA

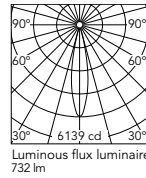

Beam Angle: 20°

h(m)	E(lx)	D(m)
1	6139	0.36
2	1534	0.72
3	682	1.08
4	384	1.44
5	245	1.80

Luminous flux luminaire 732 lm

3000K

- 03.9977.40A
- 03.9977.14A
- 03.9977.06A
- 03.9977.GLA

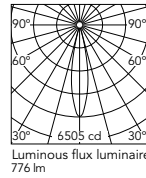

Beam Angle: 20°

h(m)	E(lx)	D(m)
1	6505	0.36
2	1626	0.72
3	723	1.08
4	406	1.44
5	260	1.80

Luminous flux luminaire 776 lm

4000K

- 03.9932.40A
- 03.9932.14A
- 03.9932.06A
- 03.9932.GLA

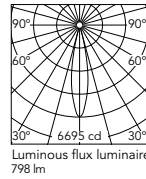

Beam Angle: 20°

h(m)	E(lx)	D(m)
1	6695	0.36
2	1673	0.72
3	744	1.08
4	418	1.44
5	267	1.80

Luminous flux luminaire 798 lm

@Chrome (06)

Optic Flood 2700K

- 03.9973.40A
- 03.9973.14A
- 03.9973.06A
- 03.9973.GLA

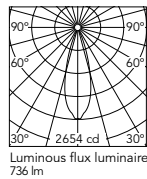

Beam Angle: 31°

h(m)	E(lx)	D(m)
1	2654	0.56
2	664	1.11
3	295	1.67
4	166	2.23
5	106	2.78

Luminous flux luminaire 736 lm

3000K

- 03.9978.40A
- 03.9978.14A
- 03.9978.06A
- 03.9978.GLA

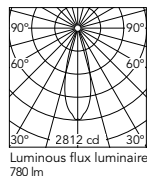

Beam Angle: 31°

h(m)	E(lx)	D(m)
1	2812	0.56
2	703	1.11
3	312	1.67
4	176	2.23
5	112	2.78

Luminous flux luminaire 780 lm

4000K

- 03.9933.40A
- 03.9933.14A
- 03.9933.06A
- 03.9933.GLA

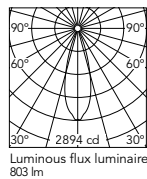

Beam Angle: 31°

h(m)	E(lx)	D(m)
1	2894	0.56
2	724	1.11
3	321	1.67
4	181	2.23
5	116	2.78

Luminous flux luminaire 803 lm

@Chrome (06)

LIGHT SHADOW PRO

Light Shadow PRO Ø90 Fixed

Light Source: Super Spot: LED Array DC 500 mA 18W - 1590 lm - 2700K/CRI 90 / 18W - 1710 lm - 3000K/CRI 90 / 18W - 1815 lm - 4000K/CRI 90
 S/M/F/WF: LED Array DC 600 mA 22W - 2324 lm - 2700K/CRI 90 / 22W - 2419 lm - 3000K/CRI 90 / 22W - 2520 lm - 4000K/CRI 90
 S/M/F/WF: LED Array DC 500 mA** 18W - 1803 lm - 2700K/CRI 90 / 18W - 1921 lm - 3000K/CRI 90 / 18W - 2057 lm - 4000K/CRI 90

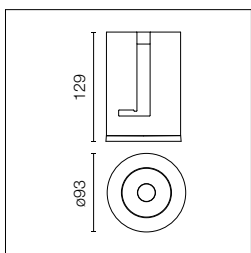

Modulo di illuminazione LED, a basso abbagliamento, da installare su cornici da incasso (non incluse), installazione con sistema a baionetta. Driver remoto non incluso.

LED lighting module, with low glare, to be inserted in the recessed frames (not included), installation through a bayonet system with interchangeable spots. Remote driver not included.

**Selezionare l'impostazione 500 mA nel driver remoto in modo che corrisponda alla potenza della versione "Adjustable".

**Please select 500 mA setting in the remote driver to match the power of the Adjustable version.

Alimentazioni raccomandate / Recommended power supply*:

	500mA	600mA
Non Dimmable 220-240V	RF27370	RF27370
Non Dimmable 110-240V	60.9523	60.9523
Mains Dimming	60.9467	60.9467
Dim 1-10V 220-240V	60.9439	60.9439
Dim 1-10V/Push 110-240V	RF27961	RF21466
Dim Dali 2 220-240V	RF30699	RF30699
Dim Dali 2 110-240V	60.9222	60.9222
Dim Casambi	60.9207	60.9207

* Vedi capitolo Drivers / Refer to the Drivers chapter

Optic Super Spot 2700K

- 03.9968.40
- 03.9968.14
- 03.9968.06
- 03.9968.GL

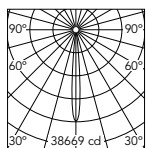

Beam Angle: 10°

h(m)	E(lx)	D(m)
1	38669	0.17
2	9667	0.33
3	4297	0.50
4	2417	0.67
5	1547	0.83

Luminous flux luminaire 1293 lm

3000K

- 03.9969.40
- 03.9969.14
- 03.9969.06
- 03.9969.GL

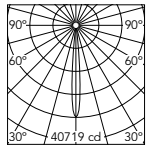

Beam Angle: 10°

h(m)	E(lx)	D(m)
1	40719	0.17
2	10180	0.33
3	4524	0.50
4	2545	0.67
5	1629	0.83

Luminous flux luminaire 1361 lm

4000K

- 03.9924.40
- 03.9924.14
- 03.9924.06
- 03.9924.GL

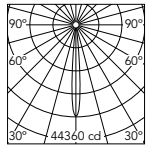

Beam Angle: 10°

h(m)	E(lx)	D(m)
1	44360	0.17
2	11090	0.33
3	4929	0.50
4	2773	0.67
5	1774	0.83

Luminous flux luminaire 1483 lm

@Chrome (06) 500mA

Optic Spot 2700K

- 03.9960.40
- 03.9960.14
- 03.9960.06
- 03.9960.GL

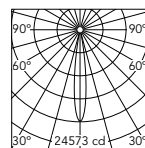

Beam Angle: 14°

h(m)	E(lx)	D(m)
1	24573	0.25
2	6143	0.50
3	2730	0.75
4	1536	1.00
5	983	1.26

Luminous flux luminaire 1834 lm

3000K

- 03.9964.40
- 03.9964.14
- 03.9964.06
- 03.9964.GL

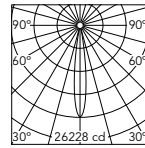

Beam Angle: 14°

h(m)	E(lx)	D(m)
1	26228	0.25
2	6557	0.50
3	2914	0.75
4	1639	1.00
5	1049	1.26

Luminous flux luminaire 1958 lm

4000K

- 03.9920.40
- 03.9920.14
- 03.9920.06
- 03.9920.GL

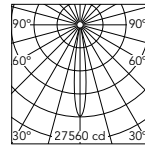

Beam Angle: 14°

h(m)	E(lx)	D(m)
1	27560	0.25
2	6890	0.50
3	3062	0.75
4	1722	1.00
5	1102	1.26

Luminous flux luminaire 2057 lm

@Chrome (06) 600mA

Optic Medium 2700K

- 03.9961.40
- 03.9961.14
- 03.9961.06
- 03.9961.GL

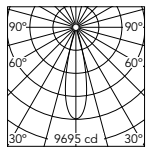

Beam Angle: 25°

h(m)	E(lx)	D(m)
1	9695	0.44
2	2424	0.88
3	1077	1.32
4	606	1.76
5	388	2.20

Luminous flux luminaire 1793 lm

3000K

- 03.9965.40
- 03.9965.14
- 03.9965.06
- 03.9965.GL

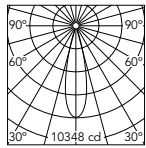

Beam Angle: 25°

h(m)	E(lx)	D(m)
1	10348	0.44
2	2587	0.88
3	1150	1.32
4	647	1.76
5	414	2.20

Luminous flux luminaire 1914 lm

4000K

- 03.9921.40
- 03.9921.14
- 03.9921.06
- 03.9921.GL

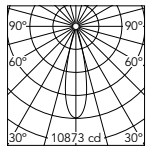

Beam Angle: 25°

h(m)	E(lx)	D(m)
1	10873	0.44
2	2718	0.88
3	1208	1.32
4	680	1.76
5	435	2.20

Luminous flux luminaire 2011 lm

@Chrome (06) 600mA

Optic Flood 2700K

- 03.9962.40
- 03.9962.14
- 03.9962.06
- 03.9962.GL

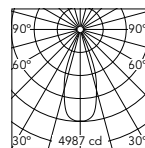

Beam Angle: 39°

h(m)	E(lx)	D(m)
1	4987	0.70
2	1247	1.40
3	554	2.10
4	312	2.81
5	199	3.51

Luminous flux luminaire 1799 lm

3000K

- 03.9966.40
- 03.9966.14
- 03.9966.06
- 03.9966.GL

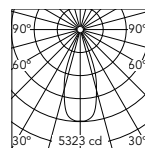

Beam Angle: 39°

h(m)	E(lx)	D(m)
1	5323	0.70
2	1331	1.40
3	591	2.10
4	333	2.81
5	213	3.51

Luminous flux luminaire 1921 lm

4000K

- 03.9922.40
- 03.9922.14
- 03.9922.06
- 03.9922.GL

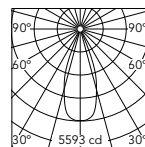





Beam Angle: 39°

h(m)	E(lx)	D(m)
1	5593	0.70
2	1398	1.40
3	621	2.10
4	350	2.81
5	224	3.51

Luminous flux luminaire 2018 lm

@Chrome (06) 600mA

**Optic Wide Flood
2700K**

-  03.9963.40
-  03.9963.14
-  03.9963.06
-  03.9963.GL

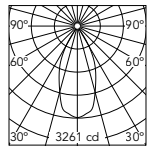





Luminous flux luminaire
1919 lm

Beam Angle: 47°

h(m)	Et(x)	D(m)
1	3261	0.87
2	815	1.73
3	362	2.60
4	204	3.46
5	130	4.33

3000K

-  03.9967.40
-  03.9967.14
-  03.9967.06
-  03.9967.GL

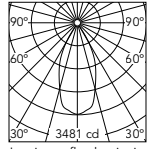





Luminous flux luminaire
2048 lm

Beam Angle: 47°

h(m)	Et(x)	D(m)
1	3481	0.87
2	870	1.73
3	387	2.60
4	218	3.46
5	139	4.33

4000K

-  03.9923.40
-  03.9923.14
-  03.9923.06
-  03.9923.GL

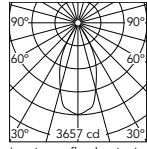

Luminous flux luminaire
2152 lm

@Chrome (06) 600mA

Beam Angle: 47°

h(m)	Et(x)	D(m)
1	3657	0.87
2	914	1.73
3	406	2.60
4	229	3.46
5	146	4.33

LIGHT SHADOW PRO

Light Shadow PRO Ø90 Adjustable

Light Source: Super Spot: LED Array DC 800 mA 10W - 800 lm - 2700K/CRI 90 / 10W - 845 lm - 3000K/CRI 90 / 10W - 915 lm - 4000K/CRI 90
 S/M/F: LED Array DC 500 mA 18W - 1590 lm - 2700K/CRI 90 / 18W - 1710 lm - 3000K/CRI 90 / 18W - 1815 lm - 4000K/CRI 90

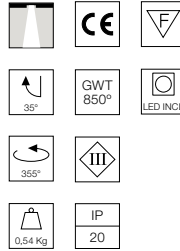
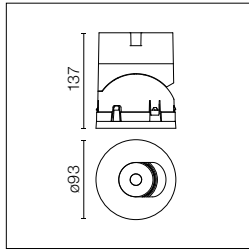

Modulo di illuminazione LED, a basso abbagliamento, da installare su cornici da incasso (non incluse), con spots intercambiabili. Driver remoto non incluso.

LED lighting module, with low glare, to be inserted in the recessed frames (not included), with interchangeable spots. Remote driver not included.

Alimentazioni raccomandate / Recommended power supply*:

	500mA 18W	800mA 10W
Non Dimmable 220-240V	RF27370	RF27370
Mains Dimming	60.9467	60.9467
Dim 1-10V 220-240V	60.9439	60.9439
Dim 1-10V/Push 110-240V	RF27961	RF27961
Dim Dali 2 220-240V	RF30699	RF30699
Dim Dali 2 110-240V	60.9222	60.9222
Dim Casambi	60.9207	60.9207

* Vedi capitolo Drivers / Refer to the Drivers chapter

Optic Super Spot 2700K

- 03.9980.40
- 03.9980.14
- 03.9980.06
- 03.9980.GL

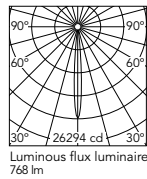

Beam Angle: 9°

h(m)	E(lx)	D(m)
1	26294	0.16
2	6573	0.31
3	2922	0.47
4	1643	0.62
5	1052	0.78

Luminous flux luminaire 768 lm

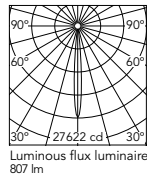

Beam Angle: 9°

h(m)	E(lx)	D(m)
1	27622	0.16
2	6905	0.31
3	3069	0.47
4	1726	0.62
5	1105	0.78

Luminous flux luminaire 807 lm

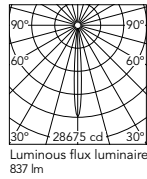

Beam Angle: 9°

h(m)	E(lx)	D(m)
1	28675	0.16
2	7169	0.31
3	3186	0.47
4	1792	0.62
5	1147	0.78

Luminous flux luminaire 837 lm

@Chrome (06)

Optic Medium 2700K

- 03.9982.40
- 03.9982.14
- 03.9982.06
- 03.9982.GL

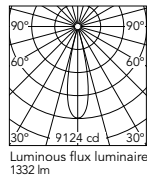

Beam Angle: 24°

h(m)	E(lx)	D(m)
1	9124	0.42
2	2281	0.83
3	1014	1.25
4	570	1.67
5	365	2.09

Luminous flux luminaire 1332 lm

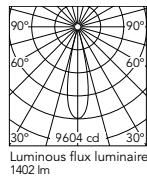

Beam Angle: 24°

h(m)	E(lx)	D(m)
1	9604	0.42
2	2401	0.83
3	1067	1.25
4	600	1.67
5	384	2.09

Luminous flux luminaire 1402 lm

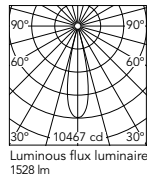

Beam Angle: 24°

h(m)	E(lx)	D(m)
1	10467	0.42
2	2617	0.83
3	1163	1.25
4	654	1.67
5	419	2.09

Luminous flux luminaire 1528 lm

@Chrome (06)

Optic Spot 2700K

- 03.9981.40
- 03.9981.14
- 03.9981.06
- 03.9981.GL

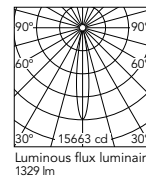

Beam Angle: 15°

h(m)	E(lx)	D(m)
1	15663	0.27
2	3916	0.54
3	1740	0.80
4	979	1.07
5	627	1.34

Luminous flux luminaire 1329 lm

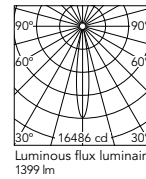

Beam Angle: 15°

h(m)	E(lx)	D(m)
1	16486	0.27
2	4122	0.54
3	1832	0.80
4	1030	1.07
5	659	1.34

Luminous flux luminaire 1399 lm

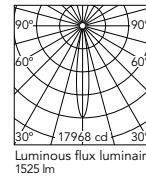

Beam Angle: 15°

h(m)	E(lx)	D(m)
1	17968	0.27
2	4492	0.54
3	1996	0.80
4	1123	1.07
5	719	1.34

Luminous flux luminaire 1525 lm

@Chrome (06)

Optic Flood 2700K

- 03.9983.40
- 03.9983.14
- 03.9983.06
- 03.9983.GL

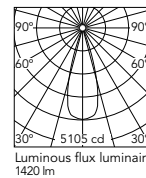

Beam Angle: 33°

h(m)	E(lx)	D(m)
1	5105	0.59
2	1276	1.17
3	567	1.76
4	319	2.35
5	204	2.93

Luminous flux luminaire 1420 lm

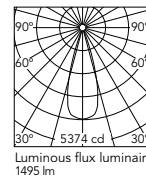

Beam Angle: 33°

h(m)	E(lx)	D(m)
1	5374	0.59
2	1344	1.17
3	597	1.76
4	336	2.35
5	215	2.93

Luminous flux luminaire 1495 lm

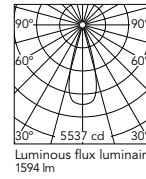

Beam Angle: 33°

h(m)	E(lx)	D(m)
1	5537	0.60
2	1384	1.19
3	615	1.79
4	346	2.39
5	221	2.98

Luminous flux luminaire 1594 lm

@Chrome (06)

Optic Flood 3000K

- 03.9988.40
- 03.9988.14
- 03.9988.06
- 03.9988.GL

Optic Flood 4000K

- 03.9943.40
- 03.9943.14
- 03.9943.06
- 03.9943.GL

LIGHT SHADOW PRO

Accessori / Accessories

Cornice di installazione Trim Ø60.

Frame Trim Ø60.

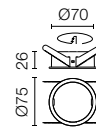

- Fixed
 - 08.0160.40
 - 08.0160.14
- Adjustable
 - 08.0164.40
 - 08.0164.14

Cornice di installazione No Trim Ø60.

Frame No Trim Ø60.



- Fixed
 - 08.0192.00

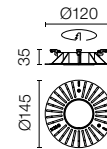

- Adjustable
 - 08.0166.00

Cornice di installazione Trim Ø90.

Frame Trim Ø90.

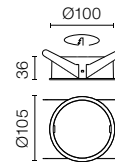

- Fixed
 - 08.0161.40
 - 08.0161.14
- Adjustable
 - 08.0165.40
 - 08.0165.14

Cornice di installazione No Trim Ø90.

Frame No Trim Ø90.

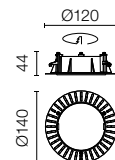

- Fixed
 - 08.0193.00

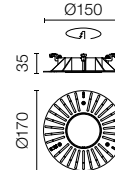

- Adjustable
 - 08.0167.00

HOW TO ORDER LIGHT SHADOW PRO

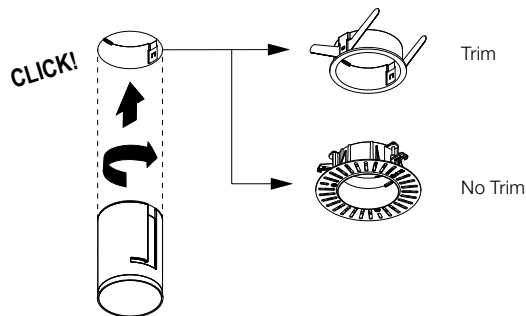

CIRCLE OF LIGHT

DESIGNED BY FLOS ARCHITECTURAL

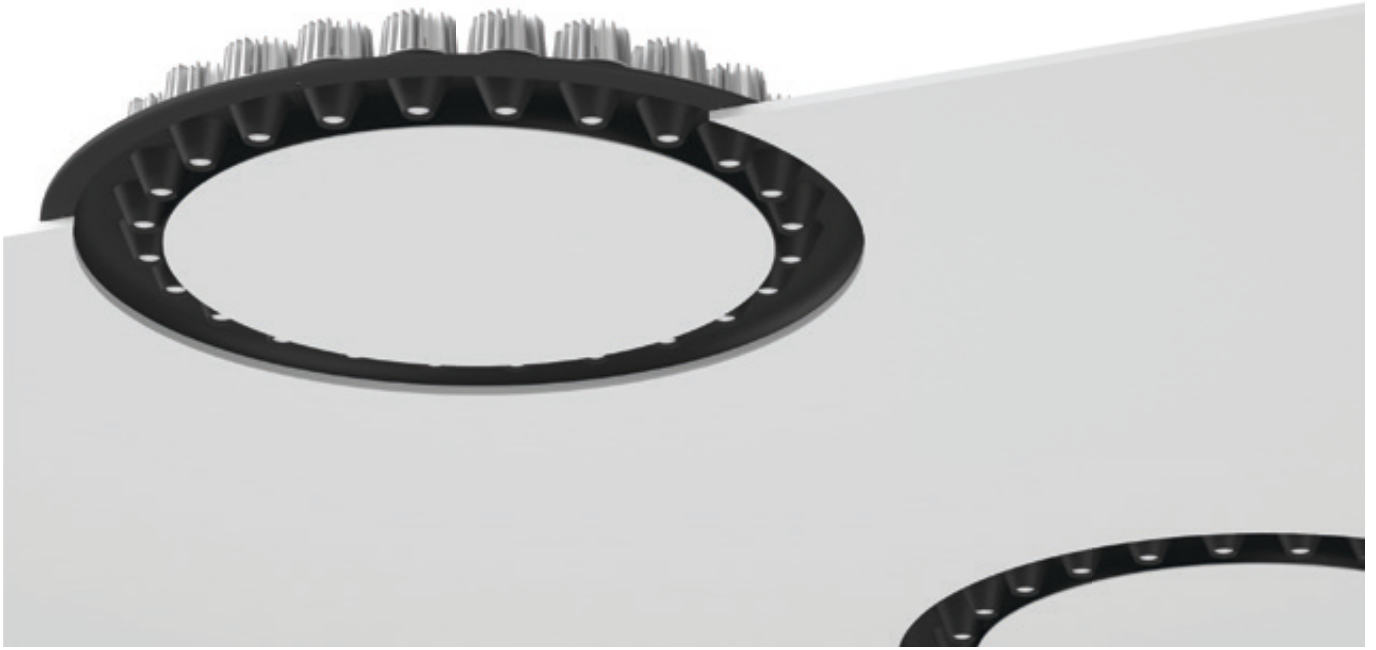

CIRCLE OF LIGHT
300 mm



LIGHT SOURCE
POWER LED
12x3W
12x325 lm
2700K/CRI 90
12x3W
12x370 lm
3000K/CRI 90

CIRCLE OF LIGHT
600 mm



LIGHT SOURCE
POWER LED
24x3W
24x325 lm
2700K/CRI 90
24x3W
24x370 lm
3000K/CRI 90

CIRCLE OF LIGHT
900 mm



LIGHT SOURCE
POWER LED
36x3W
36x325 lm
2700K/CRI 90
36x3W
36x370 lm
3000K/CRI 90

■ 14 Nero
■ 14 Black



reddot design award
winner 2013

CIRCLE OF LIGHT

Descrizione

Apparecchio ad incasso per interni facile da installare in soffitti di cartongesso, formato da una struttura circolare sulla quale si posiziona un modulo di illuminazione LED, riprodotto lungo tutto il suo perimetro. Il prodotto viene fornito pre-assemblato su un profilo tipo "Soft Architecture" per garantire un facile montaggio e una perfetta integrazione nel soffitto. Grazie a un sistema di fissaggio magnetico, i lavori di installazione dei moduli di luce e le eventuali operazioni di manutenzione potranno essere eseguiti senza la necessità di attrezzi specifici. Circle of Light è disponibile in tre diametri: 300, 600 e 900 mm formati rispettivamente da 12, 24 o 36 spot.

Riflettori

L'apparecchio è disponibile in versioni a luce d'accento con ottiche intensive (accent lighting) o a luce ambientale con ottiche estensive (general lighting) che donano al sistema una certa flessibilità per adattarsi alle varie esigenze di illuminazione.

Unità di Alimentazione

Alimentatore remoto a 1050 mA compreso. Driver 1-10V (1V funziona al 10%) per driver passivi (sink system). Compatibile con regolatori di controllo attivi 0,6-10V (source system). La versione 1-10V può essere controllata anche tramite pulsante normalmente aperto senza luce di cortesia. Disponibili cavi di sincronizzazione tra drivers (consultare il dipartimento tecnico per maggiori dettagli sull'installazione).

Informazioni Aggiuntive

L'apparecchio viene fornito con un alimentatore remoto a 24V compreso. Il collegamento al trasformatore di corrente DC-DC avviene mediante un cablaggio dotato di collegamenti rapidi, che ne permette un'installazione corretta senza necessità di attrezzi specifici. L'eventuale accesso all'alimentatore, al trasformatore di corrente DC-DC e al suo cablaggio di interconnessione è garantito dalla possibilità di rimuovere la parte centrale dell'apparecchio per far sì che i lavori di manutenzione possano essere eseguiti in modo comodo e semplice. Grado di protezione IP20. Classe di isolamento II.

Conformità e Marchi di Qualità

Apparecchio conforme alla Normativa Tecnica Europea EN60598-1 e relative parti seconde.

Description

A lighting system for indoor application comprised of a circular metal structure on which individual LED lighting spots are placed. The fitting is pre-wired and comes with a "Soft Architecture" type frame for an easy and seamless installation on the plasterboard ceiling. The LED lighting modules are attached with a magnet for an easy mounting and for the maintenance no special tools are needed. Circle of Light is available in three diameters: 300, 600 or 900 mm comprised of 12, 24 or 36 LED Lighting Spots, according to each size.

Reflectors

The LED spotlight set for the Circle of Light is available for Accent Lighting or General Lighting optic concepts. Herewith this fitting offers a some flexibility to create the desired ambiance.

Power Supply

Remote equipment 1050 mA included. Driver 1-10V (1V means 10%) for passive dimming controls (sink system). Also compatible with active dimming controls 0,6-10V (source system). The 1-10-V version can also be controlled a simple button without courtesy light. Cables available for synchronization between drivers (contact the technical department for more details about installation).

Additional Information

The connection of the power supply to the converter DC-DC is easy by using distribution boxes and a correct connection can be granted without any special tool. The distribution boxes are included. For further access to the power supply and to the connected converters DC-DC during maintenance the Circle of Light has a front cover that can be easily removed and reinstalled. IP20 protection grade. Insulation class II.

Compliance Of Standards And Quality Marks

EN60598-1 European Technical Standards and any subsequent additions.



CIRCLE OF LIGHT

Circle Of Light 300 mm

Light Source: Power LED 12x3W - 12x325 lm - 2700K/CRI 90 / 12x3W - 12x370 lm - 3000K/CRI 90

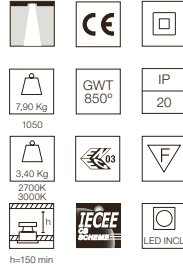
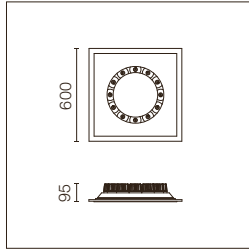

Sistema di illuminazione perfettamente integrato nel soffitto, studiato per alloggiare 12 spot tipo LED. Set di 12 spot completo di box di unione, alimentatore e cavi sono da ordinare separatamente. La versione 1-10V è dimmerabile dal 10% al 100%.

Lighting system, seamless ceiling mounted, for 12 individual LED lighting spots. Set of 12 spots, complete with junction box, power supply and cables, has to be ordered separately. The 1-10V version is dimmable from 10% to 100%.

Luce d'accento e luce generale: è necessario ordinare 1 unità.

Accent lighting and general lighting: 1 unit must be ordered.

Per le versioni Casambi, consultare il Front Office.

For Casambi versions consult the Front Office.

Ø300
Soft Plate
SA.1050.1

2700K
Set of 12 spots
Accent Lighting
08.8662.14C
08.8662.14C1V
08.8662.14CDA

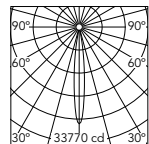

Beam Angle: 12°		
h(m)	E(lx)	D(m)
1	33770	0.22
2	8442	0.43
3	3752	0.65
4	2111	0.87
5	1351	1.08

Luminous flux luminaire
1890 lm

3000K
Set of 12 spots
Accent Lighting
08.8572.14C
08.8572.14C1V
08.8572.14CDA

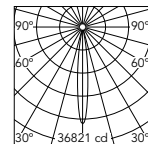

Beam Angle: 12°		
h(m)	E(lx)	D(m)
1	36821	0.22
2	9205	0.43
3	4091	0.65
4	2301	0.87
5	1473	1.08

Luminous flux luminaire
2061 lm

2700K
Set of 12 spots
General Lighting
08.8663.14C
08.8663.14C1V
08.8663.14CDA

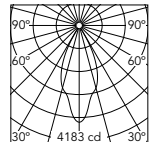

Beam Angle: 44°		
h(m)	E(lx)	D(m)
1	4183	0.81
2	1046	1.61
3	465	2.42
4	261	3.23
5	167	4.03

Luminous flux luminaire
2011 lm

3000K
Set of 12 spots
General Lighting
08.8573.14C
08.8573.14C1V
08.8573.14CDA

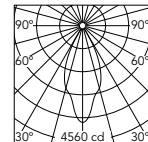

Beam Angle: 44°		
h(m)	E(lx)	D(m)
1	4560	0.81
2	1140	1.61
3	507	2.42
4	285	3.23
5	182	4.03

Luminous flux luminaire
2193 lm

Circle Of Light 600 mm

Light Source: Power LED 24x3W - 24x325 lm - 2700K/CRI 90 / 24x3W - 24x370 lm - 3000K/CRI 90

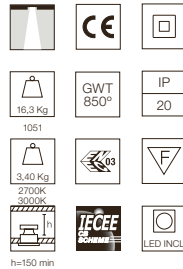
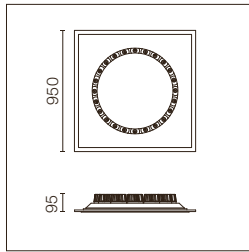

Sistema di illuminazione perfettamente integrato nel soffitto, studiato per alloggiare 24 faretto tipo LED. Set di 12 spot completo di box di unione, alimentatore e cavi sono da ordinare separatamente. La versione 1-10V è dimmerabile dal 10% al 100%.

Lighting system, seamless ceiling mounted, for 24 individual LED lighting spots. Set of 12 spots, complete with junction box, power supply and cables, has to be ordered separately. The 1-10V version is dimmable from 10% to 100%.

Luce d'accento e luce generale: è necessario ordinare 2 unità.

Accent lighting and general lighting: 2 units must be ordered.

Per le versioni Casambi, consultare il Front Office.

For Casambi versions consult the Front Office.

Ø600
Soft Plate
SA.1051.1

2700K
Set of 12 spots
Accent Lighting
08.8662.14C
08.8662.14C1V
08.8662.14CDA

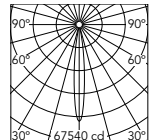

Beam Angle: 12°		
h(m)	E(lx)	D(m)
1	67540	0.22
2	16885	0.43
3	7504	0.65
4	4221	0.87
5	2702	1.08

Luminous flux luminaire
3781 lm

3000K
Set of 12 spots
Accent Lighting
08.8572.14C
08.8572.14C1V
08.8572.14CDA

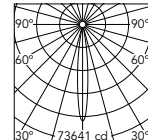

Beam Angle: 12°		
h(m)	E(lx)	D(m)
1	73641	0.22
2	18410	0.43
3	8182	0.65
4	4603	0.87
5	2946	1.08

Luminous flux luminaire
4122 lm

2700K
Set of 12 spots
General Lighting
08.8663.14C
08.8663.14C1V
08.8663.14CDA

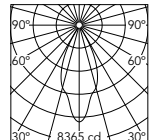

Beam Angle: 44°		
h(m)	E(lx)	D(m)
1	8365	0.81
2	2091	1.61
3	929	2.42
4	523	3.23
5	335	4.03

Luminous flux luminaire
4023 lm

3000K
Set of 12 spots
General Lighting
08.8573.14C
08.8573.14C1V
08.8573.14CDA

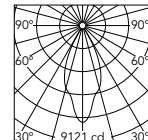

Beam Angle: 44°		
h(m)	E(lx)	D(m)
1	9121	0.81
2	2280	1.61
3	1013	2.42
4	570	3.23
5	365	4.03

Luminous flux luminaire
4386 lm

CIRCLE OF LIGHT

Circle Of Light 900 mm

Light Source: Power LED 36x3W - 36x325 lm - 2700K/CRI 90 / 36x3W - 36x370 lm - 3000K/CRI 90

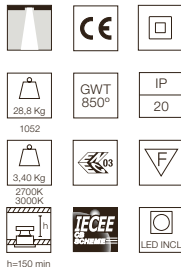
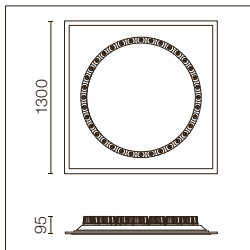

Sistema di illuminazione perfettamente integrato nel soffitto, studiato per alloggiare 36 faretti tipo LED. Set di 12 spot completo di box di unione, alimentatore e cavi sono da ordinare separatamente. La versione 1-10V è dimmerabile dal 10% al 100%.

Luce d'accento e luce generale: è necessario ordinare 3 unità.

Lighting system, seamless ceiling mounted, for 36 individual LED lighting spots. Set of 12 spots, complete with junction box, power supply and cables, has to be ordered separately. The 1-10V version is dimmable from 10% to 100%.

Accent lighting and general lighting: 3 units must be ordered.

Ø900

Soft Plate

SA.1052.1

2700K

Set of 12 spots

Accent Lighting

08.8662.14C

08.8662.14C1V

08.8662.14CDA

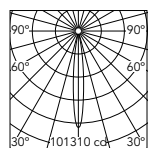

Beam Angle: 12°

h(m)	E(lx)	D(m)
1	101310	0.22
2	25327	0.43
3	11257	0.65
4	6332	0.87
5	4052	1.08

Luminous flux luminaire
5671 lm

3000K

Set of 12 spots

Accent Lighting

08.8572.14C

08.8572.14C1V

08.8572.14CDA

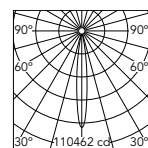

Beam Angle: 12°

h(m)	E(lx)	D(m)
1	110462	0.22
2	27616	0.43
3	12274	0.65
4	6904	0.87
5	4418	1.08

Luminous flux luminaire
6183 lm

2700K

Set of 12 spots

General Lighting

08.8663.14C

08.8663.14C1V

08.8663.14CDA

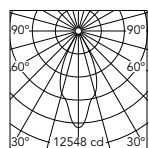

Beam Angle: 44°

h(m)	E(lx)	D(m)
1	12548	0.81
2	3137	1.61
3	1394	2.42
4	784	3.23
5	502	4.03

Luminous flux luminaire
6034 lm

3000K

Set of 12 spots

General Lighting

08.8573.14C

08.8573.14C1V

08.8573.14CDA

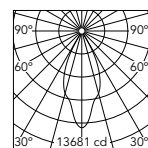

Beam Angle: 44°

h(m)	E(lx)	D(m)
1	13681	0.81
2	3420	1.61
3	1520	2.42
4	855	3.23
5	547	4.03

Luminous flux luminaire
6579 lm

LED CURTAIN

DESIGNED BY FLOS ARCHITECTURAL

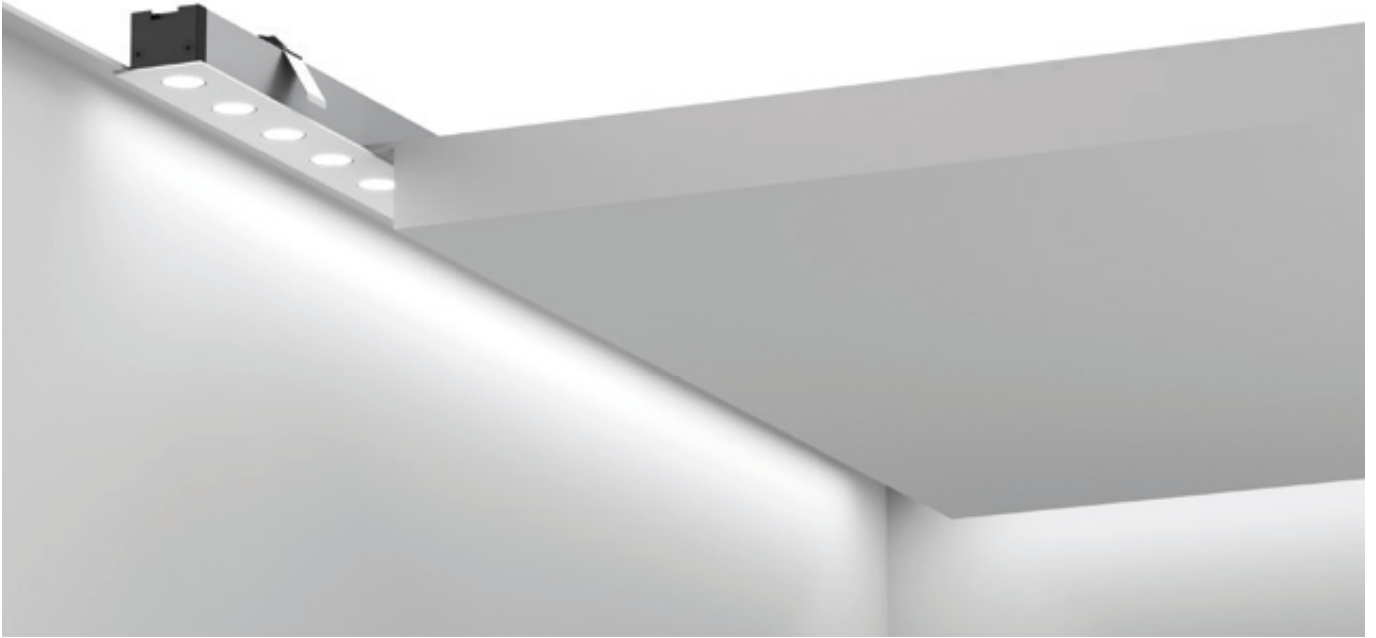

LIGHT SOURCE

POWER LED
29W/m
24V
3500 lm/m
3000K/CRI 90
4000K/CRI 90

30 Bianco
 30 White



LED CURTAIN

Descrizione

Apparecchi di illuminazione ad incasso con fonte luminosa LED. Realizzata tramite due profili in alluminio estruso che fungono da dissipatore di calore per i LED di potenza. È dotato di lenti ellittiche per una perfetta distribuzione della luce. Disponibile in moduli di diverse lunghezze collegabili tra di loro mediante un cavo di unione con connessione rapida tipo Tyco.

Unità di Alimentazione

Fonte di alimentazione di 24V disponibile da 20W fino a 100W di potenza. (massimo 3 metri di lunghezza). Sistema di controllo con dimmer 1-10V o Dali disponibili.

Informazioni Aggiuntive

Modulo LED in diverse lunghezze collegabili fra loro tramite il cavo di unione. L'alimentazione deve essere realizzata con il cavo specifico, disponibile negli accessori, dotato di connettori rapidi tipo Tyco. Massima lunghezza da un punto di alimentazione, 3 metri. Grado di protezione IP20. Classe di isolamento III.

Conformità e Marchi di Qualità

Apparecchio conforme alla Normativa Tecnica Europea EN60598-1 e relative parti seconde.

Description

Embedded light fixtures for LED light source. Made of two extruded aluminium sections used to dissipate the heat from the power LEDs. With elliptical lenses for perfect light distribution. Available in modules of different lengths which can be interconnected by a Tyco-type fast-connection cable.

Power Supply

24V power supplies available with a power of between 20W and 100W (maximum 3 metres in length). Control system with 1-10V dimmer or Dali available.

Additional Information

LED modules of different lengths, inter-connectable using the connection cable. With fast Tyco-type connectors, for power supply with the cable provided for this purpose, available with accessories. Maximum length from a connection point 3 metres. IP20 protection grade. Insulation class III.

Standard Compliance and Quality Marks

EN60598-1 European Technical Standards and any subsequent additions.



LED CURTAIN

LED Curtain

Light Source: Power LED 29W/m - 24V - 3500 lm/m - 3000K/CRI 90 / 29W/m - 24V - 3500 lm/m - 4000K/CRI 90

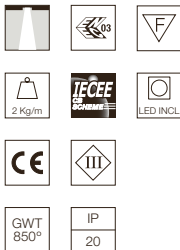
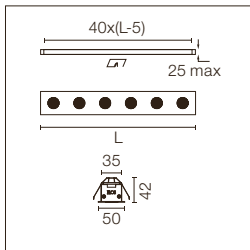

Apparecchio di illuminazione ad incasso per illuminazione diretta a LED. Completo di lente ellittica 12°x52°. Driver remoto non incluso.

Recessed luminaire for direct lighting with LED. Elliptical lens 12°x52° incorporated. Remote transformer not included.

3000K

L: 600 mm
17,3W - 2000 lm - 12 LEDs

03.3902.30C

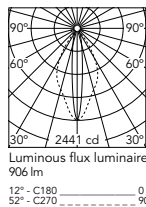

Beam Angle: 12°

4000K

L: 600 mm
17,3W - 2100 lm - 12 LEDs

03.3922.30C

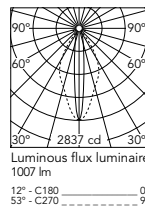

Beam Angle: 12°

L: 900 mm

26W - 3000 lm - 18 LEDs

03.3903.30C

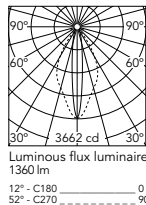

Beam Angle: 12°

L: 900 mm

26W - 3150 lm - 18 LEDs

03.3923.30C

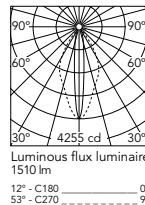

Beam Angle: 12°

L: 1200 mm

34,7W - 4000 lm - 24 LEDs

03.3904.30C

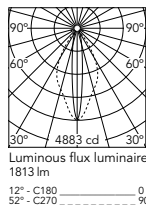

Beam Angle: 12°

L: 1200 mm

34,7W - 4200 lm - 24 LEDs

03.3924.30C

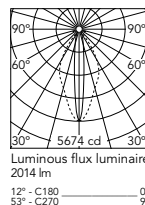

Beam Angle: 12°

LED CURTAIN

Driver / Drivers

Trasformatore elettronico per LED a tensione costante (24V). 100/240V.

Electronic transformer with constant voltage (24V) for LED. 100/240V.

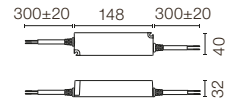

25W
60.8703

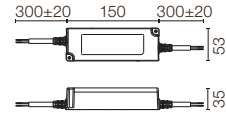

60W
60.9089

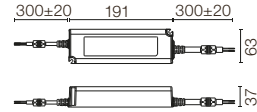

120W
RF28688

Trasformatore elettronico per LED a tensione costante (24V). 60W. 100/240V. Per uso indipendente.

Electronic transformer with constant voltage (24V) for LED. 60W. 100/240V. For independent use.

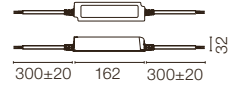

60.8515

Unità di controllo per dimmer 1-10V con 1 canale per la regolazione di moduli LED, per drivers di 24V. Alimentatore non incluso. Max. 120W - 5A.

Dimmable 1-10V control unit with 1 channel for 24V LED modules. Power supply not included. Max. 120W - 5A.

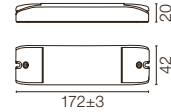

60.8640

Unità di controllo per dimmer DALI con 3 canale per la regolazione di moduli LED, per drivers di 24V. Alimentatore non incluso. Max. 120W - 5A.

Dimmable DALI control unit with 3 channel for 24V LED modules. Power supply not included. Max. 120W - 5A.

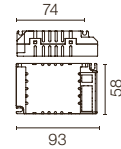

60.8407

Cavo di unione tra moduli con connessione rapida tipo Tyco.

Connection cable between modules with Tyco fast connection cable.



L: 100 mm
06.1032.00
L: 500 mm
06.1033.00

Cavo di alimentazione con connessione rapida tipo Tyco. Lunghezza massima da alimentare 3 metri.

Power cable with Tyco fast connection cable. Maximum supply length 3 metres.



L: 500 mm
06.1034.00

DOWNLIGHTS

Kap, Bon Jour, Light Shooter,
Light Sniper, UT Downlight, Light Supply,
Pure Downlight, Compass, Anthony Downlight,
Wan Downlight, Light Soldier, Decofix,
Johnny, Compass Box Recessed,
Battery, Micro Battery.

KAP Ø50
FIXEDKAP Ø50
ADJUSTABLE

LIGHT SOURCE
LED ARRAY
7,5W
595 lm
2700K/CRI 90
635 lm
3000K/CRI 90

KAP 80/
KAP 80 PLUS
FIXEDKAP 80/
KAP 80 PLUS
WALL-WASHERKAP 80/
KAP 80 PLUS
ADJUSTABLE

LIGHT SOURCE
LED ARRAY
max 13W
1370 lm
2700K/CRI 90
1460 lm
3000K/CRI 90

LIGHT SOURCE
LED ARRAY
13W
1800K-2850K
CRI 95
Dim To Warm*
*Only for KAP 80

LIGHT SOURCE
LED
QR-CBC 51
GX5.3

LIGHT SOURCE
LED
PAR 16
GZ10

LIGHT SOURCE
LED ARRAY
max 13W
1370 lm
2700K/CRI 90
1460 lm
3000K/CRI 90

LIGHT SOURCE
LED ARRAY
13W
1800K-2850K
CRI 95
Dim To Warm*
*Only for KAP 80

LIGHT SOURCE
LED
QR-CBC 51
GX5.3

LIGHT SOURCE
LED
PAR 16
GZ10

KAP Ø105
FIXEDKAP Ø105
WALL-WASHERKAP Ø105
ADJUSTABLEKAP Ø105
DEEPKAP 105
SQUARE
FIXED

LIGHT SOURCE
LED ARRAY
23W
2690 lm
2700K/CRI 90
2870 lm
3000K/CRI 90

LIGHT SOURCE
LED
QR-CBC 51
GX5.3

LED
PAR 16
GZ10

LIGHT SOURCE
LED
QR-CBC 51
GX5.3

LIGHT SOURCE
LED ARRAY
23W
2690 lm
2700K/CRI 90
2870 lm
3000K/CRI 90

LIGHT SOURCE
PHOSPHOR
LED
17W
1400 lm
2700K/CRI 98
3000K/CRI 98

LIGHT SOURCE
LED ARRAY
17W
1800 lm
2700K/CRI 90
2000 lm
3000K/CRI 90

LIGHT SOURCE
LED
QR-CBC 51
GX5.3

LED
PAR 16
GZ10

KAP Ø145
FIXEDKAP Ø145
WALL-WASHERKAP Ø145
DEEP

LIGHT SOURCE
PHOSPHOR
LED
17W
1400 lm
2700K/CRI 98
3000K/CRI 98

LIGHT SOURCE
LED ARRAY
17W
1800 lm
2700K/CRI 90
2000 lm
3000K/CRI 90

EASY KAP Ø50
FIXED



EASY KAP Ø50
ADJUSTABLE



LIGHT SOURCE
LED ARRAY
7,5W
595 lm
2700K/CRI 90
635 lm
3000K/CRI 90

EASY KAP 80/
EASY KAP 80 PLUS
FIXED



LIGHT SOURCE
LED ARRAY
max 13W
1370 lm
2700K/CRI 90
1460 lm
3000K/CRI 90

EASY KAP 80/
EASY KAP 80 PLUS
WALL-WASHER



LIGHT SOURCE
LED ARRAY
13W
1800K-2850K
CRI 95
Dim To Warm*
*Only for KAP 80

EASY KAP 80/
EASY KAP 80
PLUS ADJUSTABLE



LIGHT SOURCE
LED
QR-CBC 51
GX5.3

LIGHT SOURCE
LED
PAR 16
GZ10

EASY KAP Ø105
FIXED



LIGHT SOURCE
LED ARRAY
23W
2690 lm
2700K/CRI 90
2870 lm
3000K/CRI 90

EASY KAP Ø105
WALL-WASHER



LIGHT SOURCE
LED
QR-CBC 51
GX5.3

EASY KAP Ø105
ADJUSTABLE



LIGHT SOURCE
LED
PAR 16
GZ10

□ B1 Bianco
B1 White



■ GL Oro Opaco
GL Matt Gold



■ BU Blu
BU Blue



■ 74 Nero
74 Black



■ CU Rame
CU Copper



Descrizione

Apparecchio di illuminazione per l'installazione a incasso per lampade alogene, ad alogenuro metallico e LED.

La versione Easy Kap ha un corpo iniettato in alluminio per le versioni da 50, 80 e 105 mm, con finiture in vernice liquida, polvere e/o rame metallizzato con diffusore realizzato in vetro o plastica, a seconda della versione.

Non richiede cornice di installazione.

La versione Kap dispone di un corpo in alluminio con finitura in vernice liquida e rame metallizzato. È disponibile in tre diametri: 50 mm, 80 mm, 105 mm e 145 mm.

Ottica principale realizzata in alluminio anodizzato lucido, con elemento diffusore in vetro o plastica a seconda della versione.

Porta lampada con elemento dissipatore in alluminio e anello di incasso del corpo ottico in materiale termoplastico.

Unità di Alimentazione

Easy Kap 50/80/105 LED e Kap 50 e 80: dispositivo remoto non incluso.

Kap 105/145 LED/Kap 80 e Easy Kap 80 Dim To Warm: dispositivo remoto 10-10V incluso. Il voltaggio di uscita del dispositivo deve essere sempre inferiore a 60Vdc.

Accessori

Cornice di pre installazione per le versioni Kap 50 e 80 round e square, e 105 round.

Disponibile can per installazione nel cemento.

Informazioni Aggiuntive

Grado di protezione IP20, IP23, IP43, IP44, IP54 a seconda delle versioni.

Classe di isolamento I, II, III, a seconda delle versioni.

- KAP 50 / 80 / 105 / 145:

Grazie alla remote-phosphor technology, i moduli LED che montano le versioni Phosphor LED offrono la massima qualità luminosa possibile e una percezione degli oggetti e degli spazi, che raggiungono indici di riproduzione cromatica pari a 98, a seconda delle versioni.

I moduli LED installati nelle versioni LED Array dispongono dell'ultima generazione tecnologica grazie alla quale si ottiene la minore temperatura media durante il funzionamento dell'elettronica. Grazie a questa caratteristica, l'apparecchio di illuminazione può funzionare all'interno dei parametri di sicurezza a una maggior potenza, offrendo un aumento del 20% del flusso luminoso.

La nuova tecnologia di regolazione "Dim To Warm" riproduce l'effetto di luce calda delle vecchie lampade alogene grazie alla riduzione dell'intensità luminosa. Gli apparecchi "Dim To Warm" vanno regolati con protocollo 1-10V.

Conformità e Marchi di Qualità

Apparecchio conforme alla Normativa Tecnica Europea EN60598-1 e relative parti seconde.

Description

Luminaire for embedded installation in ceilings for LEDs lamps.

The Easy Kap version has an aluminium injected body for the 50, 80 and 105 mm versions, with a liquid paint, dust and/or metallic copper finish with a glass or plastic diffuser depending on the version. It does not need a pre-installation frame.

The Kap version has an aluminium-injected body with a liquid paint and metallic copper finish. Available in three diameters: 50 mm, 80 mm, 105 mm and 145 mm.

Main optics in shiny anodised aluminium with a glass or plastic diffuser element, depending on the version. Lamp holder with a dissipating element in injected aluminium and a thermoplastic embedding ring for the optic body.

Power Supply

Easy Kap 50/80/105 LED and Kap 50 and 80: Remote equipment not included.

Kap 105/145 LED/Kap 80 and Easy Kap 80 Dim To Warm: 1-10V remote equipment included. The output voltage of the equipment must always be less than 60Vdc.

Accessories

Pre-installation frame for the round and square Kap 50 and 80 and 105 version.

Available for installation on cement.

Additional Information

IP20, IP23, IP43, IP44, IP54 protection grade depending on the versions.

Insulation class I, II, III depending on the versions.

- KAP 50 / 80 / 105 / 145:

Thanks to remote-phosphor technology, the LED modules of the Phosphor LED version offer maximum quality light, the perception of objects and spaces, reaching chromatic reproduction indices of 98, depending on the version.

The LED modules installed on the LED Array versions have cutting-edge technology that permits a lower average temperature in the electronics. Thanks to this feature, the luminaire can operate at a higher power inside the safety parameters yet still offer 20% added luminous flux.

The new "Dim To Warm" technology reproduces the effect of a traditional lamp, offering a warmer light by reducing the light intensity.

The "Dim To Warm" luminaires are dimmed through the 1-10V protocol.

Standard Compliance and Quality Marks

EN60598-1 European Technical Standards and any subsequent additions.



Easy Kap



Kap

Kap Ø50 Fixed - Optic Spot

Light Source: LED Array DC 200 mA - 7,5W - 595 lm - 2700K/CRI 90 / 7,5W - 635 lm - 3000K/CRI 90

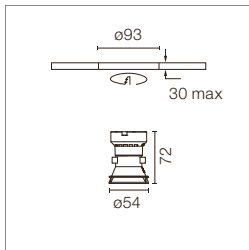

GWT 850°
 IP 54
 0,14 Kg
 F
 LED INCL
 CE
 III
 IPCEEF SCHNEIDER
 h=100 mm

Incasso a LED. Fonte di alimentazione esclusa. Fonte di alimentazione remota da installare in un luogo accessibile. Cornice di pre-installazione da ordinare separatamente.

Recessed luminaire with LED light source. Power supply not included. Remote power supply to be installed in an accessible place. Pre-installation frame. To be ordered separately.

Alimentazioni raccomandate / Recommended power supply*:

- Non Dimmable 60.9160
- Dimmable 0-10V 60.9483
- Dimmable Dali 2 60.9604
- Mains Dimming 60.9421
- Casambi 60.9392 + DALI/1-10V Driver

* Vedi capitolo Drivers / Refer to the Drivers chapter

2700K
□ 05.7300.B1

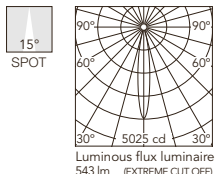

Beam Angle: 15°

h(m)	E(lx)	D(m)
1	5025	0.27
2	1256	0.53
3	558	0.80
4	314	1.07
5	201	1.33

Luminous flux luminaire 543 lm (EXTREME CUT OFF)

3000K
□ 05.7305.B1

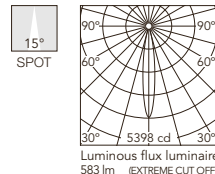

Beam Angle: 15°

h(m)	E(lx)	D(m)
1	5398	0.27
2	1349	0.53
3	600	0.80
4	337	1.07
5	216	1.33

Luminous flux luminaire 583 lm (EXTREME CUT OFF)

■ 05.7300.GL

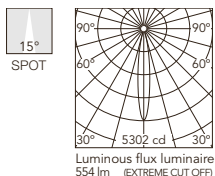

Beam Angle: 15°

h(m)	E(lx)	D(m)
1	5302	0.26
2	1325	0.53
3	589	0.79
4	331	1.06
5	212	1.32

Luminous flux luminaire 554 lm (EXTREME CUT OFF)

■ 05.7305.GL

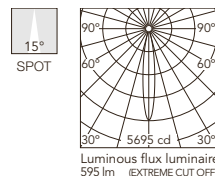

Beam Angle: 15°

h(m)	E(lx)	D(m)
1	5695	0.26
2	1424	0.53
3	633	0.79
4	356	1.06
5	228	1.32

Luminous flux luminaire 595 lm (EXTREME CUT OFF)

■ 05.7300.BU

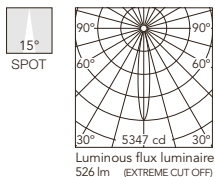

Beam Angle: 15°

h(m)	E(lx)	D(m)
1	5347	0.26
2	1337	0.52
3	594	0.78
4	334	1.04
5	214	1.30

Luminous flux luminaire 526 lm (EXTREME CUT OFF)

■ 05.7305.BU

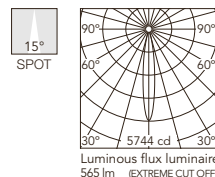

Beam Angle: 15°

h(m)	E(lx)	D(m)
1	5744	0.26
2	1436	0.52
3	638	0.78
4	359	1.04
5	230	1.30

Luminous flux luminaire 565 lm (EXTREME CUT OFF)

■ 05.7300.74

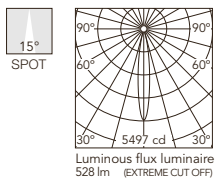

Beam Angle: 15°

h(m)	E(lx)	D(m)
1	5497	0.26
2	1374	0.52
3	611	0.77
4	344	1.03
5	220	1.29

Luminous flux luminaire 528 lm (EXTREME CUT OFF)

■ 05.7305.74

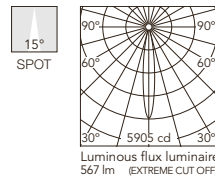

Beam Angle: 15°

h(m)	E(lx)	D(m)
1	5905	0.26
2	1476	0.52
3	656	0.77
4	369	1.03
5	236	1.29

Luminous flux luminaire 567 lm (EXTREME CUT OFF)

■ 05.7300.CU

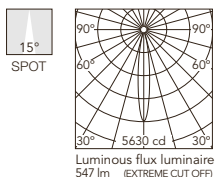

Beam Angle: 15°

h(m)	E(lx)	D(m)
1	5630	0.26
2	1408	0.51
3	626	0.77
4	352	1.03
5	225	1.29

Luminous flux luminaire 547 lm (EXTREME CUT OFF)

■ 05.7305.CU

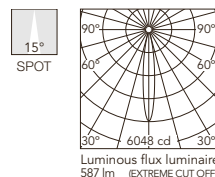

Beam Angle: 15°

h(m)	E(lx)	D(m)
1	6048	0.26
2	1512	0.51
3	672	0.77
4	378	1.03
5	242	1.29

Luminous flux luminaire 587 lm (EXTREME CUT OFF)

Kap Ø50 Fixed - Optic Medium

Light Source: LED Array DC 200 mA - 7,5W - 595 lm - 2700K/CRI 90 / 7,5W - 635 lm - 3000K/CRI 90

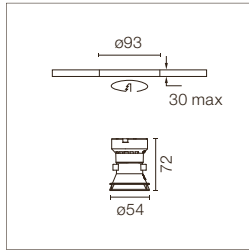

GWT 850°
 IP 54
 0,14 Kg
 LED INCL
 CE
 III
 IECEP SCHEMELITE
 h=100 min

Incasso a LED. Fonte di alimentazione esclusa. Fonte di alimentazione remota da installare in un luogo accessibile. Cornice di pre-installazione da ordinare separatamente.

Recessed luminaire with LED light source. Power supply not included. Remote power supply to be installed in an accessible place. Pre-installation frame. To be ordered separately.

Alimentazioni raccomandate / Recommended power supply*:

- Non Dimmable 60.9160
- Dimmable 0-10V 60.9483
- Dimmable Dali 2 60.9604
- Mains Dimming 60.9421
- Casambi 60.9392 + DALI/1-10V Driver

* Vedi capitolo Drivers / Refer to the Drivers chapter

2700K
□ 05.7301.B1

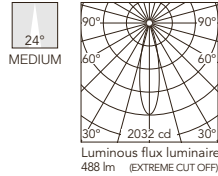

Beam Angle: 24°

h(m)	E(lx)	D(m)
1	2032	0.43
2	508	0.86
3	226	1.30
4	127	1.73
5	81	2.16

3000K
□ 05.7306.B1

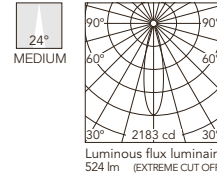

Beam Angle: 24°

h(m)	E(lx)	D(m)
1	2183	0.43
2	546	0.86
3	243	1.30
4	136	1.73
5	87	2.16

■ 05.7301.GL

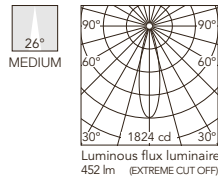

Beam Angle: 26°

h(m)	E(lx)	D(m)
1	1824	0.45
2	456	0.91
3	203	1.36
4	114	1.82
5	73	2.27

■ 05.7306.GL

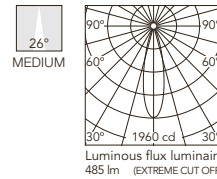

Beam Angle: 26°

h(m)	E(lx)	D(m)
1	1960	0.45
2	490	0.91
3	218	1.36
4	122	1.82
5	78	2.27

■ 05.7301.BU

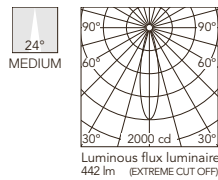

Beam Angle: 24°

h(m)	E(lx)	D(m)
1	2000	0.42
2	500	0.84
3	222	1.26
4	125	1.67
5	80	2.09

■ 05.7306.BU

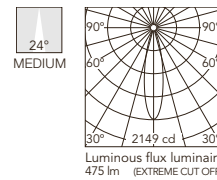

Beam Angle: 24°

h(m)	E(lx)	D(m)
1	2149	0.42
2	537	0.84
3	239	1.26
4	134	1.67
5	86	2.09

■ 05.7301.74

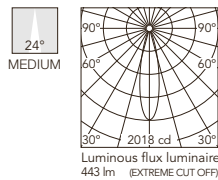

Beam Angle: 24°

h(m)	E(lx)	D(m)
1	2018	0.43
2	504	0.85
3	224	1.28
4	126	1.71
5	81	2.13

■ 05.7306.74

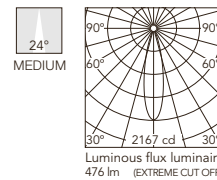

Beam Angle: 24°

h(m)	E(lx)	D(m)
1	2167	0.43
2	542	0.85
3	241	1.28
4	135	1.71
5	87	2.13

■ 05.7301.CU

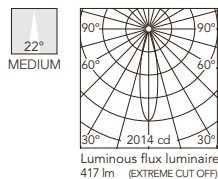

Beam Angle: 22°

h(m)	E(lx)	D(m)
1	2014	0.40
2	503	0.79
3	224	1.19
4	126	1.59
5	81	1.99

■ 05.7306.CU

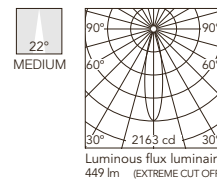

Beam Angle: 22°

h(m)	E(lx)	D(m)
1	2163	0.40
2	541	0.79
3	240	1.19
4	135	1.59
5	87	1.99

Kap Ø50 Fixed - Optic Flood

Light Source: LED Array DC 200 mA - 7,5W - 595 lm - 2700K/CRI 90 / 7,5W - 635 lm - 3000K/CRI 90

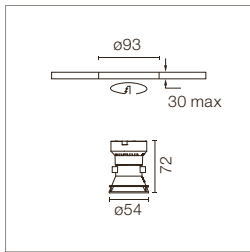

GWT 850°
 IP 54
 0,14 Kg
 LED INCL
 CE
 III
 IPCC SCHEMATIC
 h=100 mm

Incasto a LED. Fonte di alimentazione esclusa. Fonte di alimentazione remota da installare in un luogo accessibile. Cornice di pre-installazione da ordinare separatamente.

Recessed luminaire with LED light source. Power supply not included. Remote power supply to be installed in an accessible place. Pre-installation frame. To be ordered separately.

Alimentazioni raccomandate / Recommended power supply*:

- Non Dimmable 60.9160
- Dimmable 0-10V 60.9483
- Dimmable Dali 60.9604
- Mains Dimming 60.9421
- Casambi 60.9392 + DALI/1-10V Driver

* Vedi capitolo Drivers / Refer to the Drivers chapter

2700K
□ 05.7302.B1

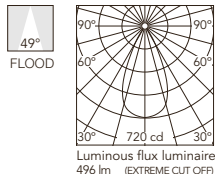

Beam Angle: 49°

h(m)	E(lx)	D(m)
1	720	0.91
2	180	1.83
3	80	2.74
4	45	3.66
5	29	4.57

3000K
□ 05.7307.B1

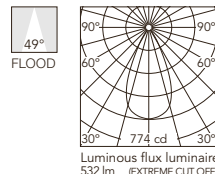

Beam Angle: 49°

h(m)	E(lx)	D(m)
1	774	0.91
2	193	1.83
3	86	2.74
4	48	3.66
5	31	4.57

■ 05.7302.GL

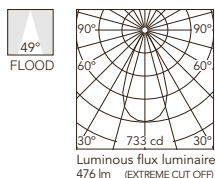

Beam Angle: 49°

h(m)	E(lx)	D(m)
1	733	0.90
2	183	1.81
3	81	2.71
4	46	3.61
5	29	4.52

■ 05.7307.GL

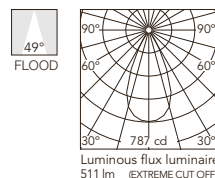

Beam Angle: 49°

h(m)	E(lx)	D(m)
1	787	0.90
2	197	1.81
3	87	2.71
4	49	3.61
5	31	4.52

■ 05.7302.BU

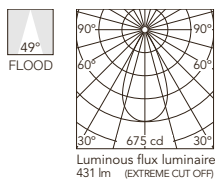

Beam Angle: 49°

h(m)	E(lx)	D(m)
1	675	0.91
2	169	1.81
3	75	2.72
4	42	3.63
5	27	4.53

■ 05.7307.BU

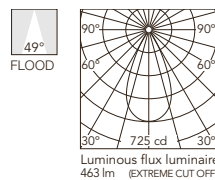

Beam Angle: 49°

h(m)	E(lx)	D(m)
1	725	0.91
2	181	1.81
3	81	2.72
4	45	3.63
5	29	4.53

■ 05.7302.74

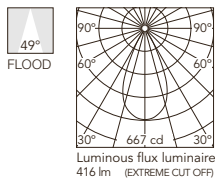

Beam Angle: 49°

h(m)	E(lx)	D(m)
1	667	0.91
2	167	1.82
3	74	2.72
4	42	3.63
5	27	4.54

■ 05.7307.74

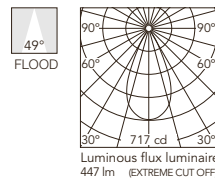

Beam Angle: 49°

h(m)	E(lx)	D(m)
1	717	0.91
2	179	1.82
3	80	2.72
4	45	3.63
5	29	4.54

■ 05.7302.CU

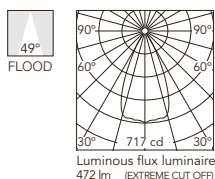

Beam Angle: 49°

h(m)	E(lx)	D(m)
1	717	0.91
2	179	1.83
3	80	2.74
4	45	3.66
5	29	4.57

■ 05.7307.CU

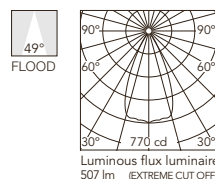

Beam Angle: 49°

h(m)	E(lx)	D(m)
1	770	0.91
2	193	1.83
3	86	2.74
4	48	3.66
5	31	4.57

Kap Ø50 Adjustable - Optic Spot

Light Source: LED Array DC 200 mA - 7,5W - 595 lm - 2700K/CRI 90 / 7,5W - 635 lm - 3000K/CRI 90

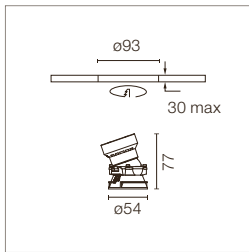

Incasto a LED. Fonte di alimentazione esclusa. Fonte di alimentazione remota da installare in un luogo accessibile. Cornice di pre-installazione da ordinare separatamente.

Recessed luminaire with LED light source. Power supply not included. Remote power supply to be installed in an accessible place. Pre-installation frame. To be ordered separately.

Alimentazioni raccomandate / Recommended power supply*:

- Non Dimmable 60.9160
- Dimmable 0-10V 60.9483
- Dimmable Dali 60.9604
- Mains Dimming 60.9421
- Casambi 60.9392 + DALI/1-10V Driver

* Vedi capitolo Drivers / Refer to the Drivers chapter

2700K
□ 05.7310.B1

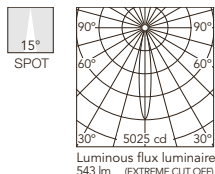

Beam Angle: 15°

h(m)	E(lx)	D(m)
1	5025	0.27
2	1256	0.53
3	558	0.80
4	314	1.07
5	201	1.33

Luminous flux luminaire 543 lm (EXTREME CUT OFF)

3000K
□ 05.7315.B1

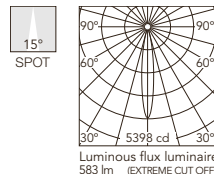

Beam Angle: 15°

h(m)	E(lx)	D(m)
1	5398	0.27
2	1349	0.53
3	600	0.80
4	337	1.07
5	216	1.33

Luminous flux luminaire 583 lm (EXTREME CUT OFF)

■ 05.7310.GL

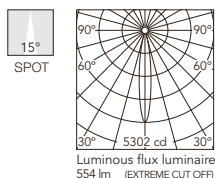

Beam Angle: 15°

h(m)	E(lx)	D(m)
1	5302	0.26
2	1325	0.53
3	589	0.79
4	331	1.06
5	212	1.32

Luminous flux luminaire 554 lm (EXTREME CUT OFF)

■ 05.7315.GL

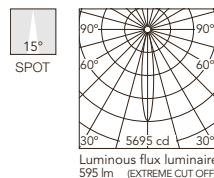

Beam Angle: 15°

h(m)	E(lx)	D(m)
1	5695	0.26
2	1424	0.53
3	633	0.79
4	356	1.06
5	228	1.32

Luminous flux luminaire 595 lm (EXTREME CUT OFF)

■ 05.7310.BU

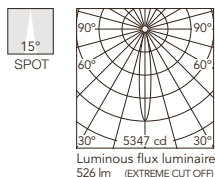

Beam Angle: 15°

h(m)	E(lx)	D(m)
1	5347	0.26
2	1337	0.52
3	594	0.78
4	334	1.04
5	214	1.30

Luminous flux luminaire 526 lm (EXTREME CUT OFF)

■ 05.7315.BU

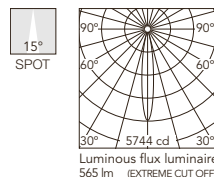

Beam Angle: 15°

h(m)	E(lx)	D(m)
1	5744	0.26
2	1436	0.52
3	638	0.78
4	359	1.04
5	230	1.30

Luminous flux luminaire 565 lm (EXTREME CUT OFF)

■ 05.7310.74

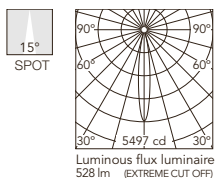

Beam Angle: 15°

h(m)	E(lx)	D(m)
1	5497	0.26
2	1374	0.52
3	611	0.77
4	344	1.03
5	220	1.29

Luminous flux luminaire 528 lm (EXTREME CUT OFF)

■ 05.7315.74

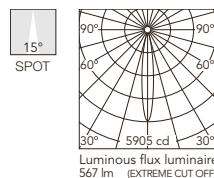

Beam Angle: 15°

h(m)	E(lx)	D(m)
1	5905	0.26
2	1476	0.52
3	656	0.77
4	369	1.03
5	236	1.29

Luminous flux luminaire 567 lm (EXTREME CUT OFF)

■ 05.7310.CU

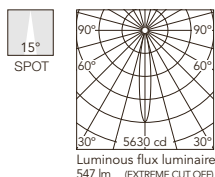

Beam Angle: 15°

h(m)	E(lx)	D(m)
1	5630	0.26
2	1408	0.51
3	626	0.77
4	352	1.03
5	225	1.29

Luminous flux luminaire 547 lm (EXTREME CUT OFF)

■ 05.7315.CU

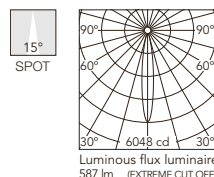

Beam Angle: 15°

h(m)	E(lx)	D(m)
1	6048	0.26
2	1512	0.51
3	672	0.77
4	378	1.03
5	242	1.29

Luminous flux luminaire 587 lm (EXTREME CUT OFF)

Kap Ø50 Adjustable - Optic Medium

Light Source: LED Array DC 200 mA - 7,5W - 595 lm - 2700K/CRI 90 / 7,5W - 635 lm - 3000K/CRI 90

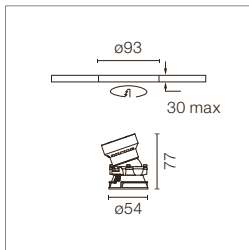

Incasso a LED. Fonte di alimentazione esclusa. Fonte di alimentazione remota da installare in un luogo accessibile. Cornice di pre-installazione da ordinare separatamente.

Recessed luminaire with LED light source. Power supply not included. Remote power supply to be installed in an accessible place. Pre-installation frame. To be ordered separately.

Alimentazioni raccomandate / Recommended power supply*:

- Non Dimmable 60.9160
- Dimmable 0-10V 60.9483
- Dimmable Dali 60.9604
- Mains Dimming 60.9421
- Casambi 60.9392 + DALI/1-10V Driver

* Vedi capitolo Drivers / Refer to the Drivers chapter

2700K
□ 05.7311.B1

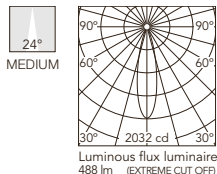

h(m)	E(lx)	D(m)
1	2032	0.43
2	508	0.86
3	226	1.30
4	127	1.73
5	81	2.16

3000K
□ 05.7316.B1

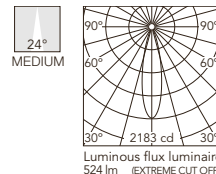

h(m)	E(lx)	D(m)
1	2183	0.43
2	546	0.86
3	243	1.30
4	136	1.73
5	87	2.16

■ 05.7311.GL

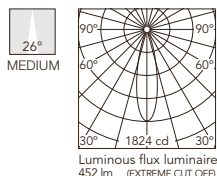

h(m)	E(lx)	D(m)
1	1824	0.45
2	456	0.91
3	203	1.36
4	114	1.82
5	73	2.27

■ 05.7316.GL

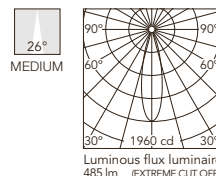

h(m)	E(lx)	D(m)
1	1960	0.45
2	490	0.91
3	218	1.36
4	122	1.82
5	78	2.27

■ 05.7311.BU

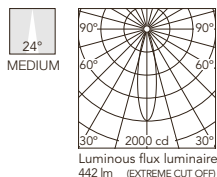

h(m)	E(lx)	D(m)
1	2000	0.42
2	500	0.84
3	222	1.26
4	125	1.67
5	80	2.09

■ 05.7316.BU

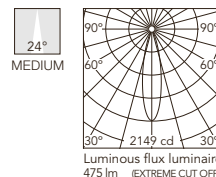

h(m)	E(lx)	D(m)
1	2149	0.42
2	537	0.84
3	239	1.26
4	134	1.67
5	86	2.09

■ 05.7311.74

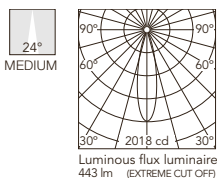

h(m)	E(lx)	D(m)
1	2018	0.43
2	504	0.85
3	224	1.28
4	126	1.71
5	81	2.13

■ 05.7316.74

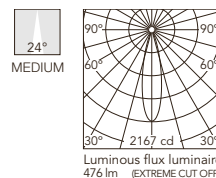

h(m)	E(lx)	D(m)
1	2167	0.43
2	542	0.85
3	241	1.28
4	135	1.71
5	87	2.13

■ 05.7311.CU

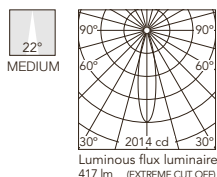

h(m)	E(lx)	D(m)
1	2014	0.40
2	503	0.79
3	224	1.19
4	126	1.59
5	81	1.99

■ 05.7316.CU

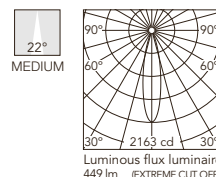

h(m)	E(lx)	D(m)
1	2163	0.40
2	541	0.79
3	240	1.19
4	135	1.59
5	87	1.99

Kap Ø50 Adjustable - Optic Flood

Light Source: LED Array DC 200 mA - 7,5W - 595 lm - 2700K/CRI 90 / 7,5W - 635 lm - 3000K/CRI 90

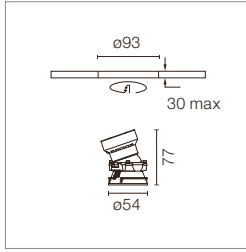

Incasto a LED. Fonte di alimentazione esclusa. Fonte di alimentazione remota da installare in un luogo accessibile. Cornice di pre-installazione da ordinare separatamente.

Recessed luminaire with LED light source. Power supply not included. Remote power supply to be installed in an accessible place. Pre-installation frame. To be ordered separately.

Alimentazioni raccomandate / Recommended power supply*:

Non Dimmable	60.9160
Dimmable 0-10V	60.9483
Dimmable Dali	60.9604
Mains Dimming	60.9421
Casambi	60.9392 + DALI/1-10V Driver

* Vedi capitolo Drivers / Refer to the Drivers chapter

2700K
□ 05.7312.B1

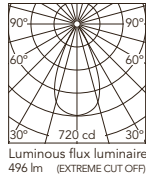

Beam Angle: 49°

h(m)	E(lx)	D(m)
1	720	0.91
2	180	1.83
3	80	2.74
4	45	3.66
5	29	4.57

Luminous flux luminaire
496 lm (EXTREME CUT OFF)

3000K
□ 05.7317.B1

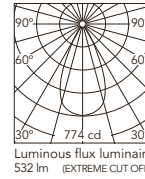

Beam Angle: 49°

h(m)	E(lx)	D(m)
1	774	0.91
2	193	1.83
3	86	2.74
4	48	3.66
5	31	4.57

Luminous flux luminaire
532 lm (EXTREME CUT OFF)

■ 05.7312.GL

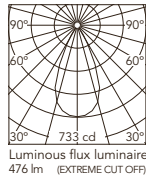

Beam Angle: 49°

h(m)	E(lx)	D(m)
1	733	0.90
2	183	1.81
3	81	2.71
4	46	3.61
5	29	4.52

Luminous flux luminaire
476 lm (EXTREME CUT OFF)

■ 05.7317.GL

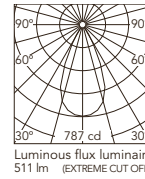

Beam Angle: 49°

h(m)	E(lx)	D(m)
1	787	0.90
2	197	1.81
3	87	2.71
4	49	3.61
5	31	4.52

Luminous flux luminaire
511 lm (EXTREME CUT OFF)

■ 05.7312.BU

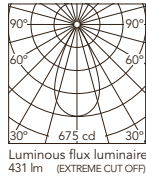

Beam Angle: 49°

h(m)	E(lx)	D(m)
1	675	0.91
2	169	1.81
3	75	2.72
4	42	3.63
5	27	4.53

Luminous flux luminaire
431 lm (EXTREME CUT OFF)

■ 05.7317.BU

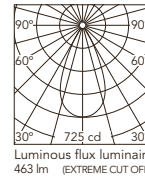

Beam Angle: 49°

h(m)	E(lx)	D(m)
1	725	0.91
2	181	1.81
3	81	2.72
4	45	3.63
5	29	4.53

Luminous flux luminaire
463 lm (EXTREME CUT OFF)

■ 05.7312.74

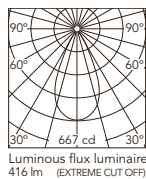

Beam Angle: 49°

h(m)	E(lx)	D(m)
1	667	0.91
2	167	1.82
3	74	2.72
4	42	3.63
5	27	4.54

Luminous flux luminaire
416 lm (EXTREME CUT OFF)

■ 05.7317.74

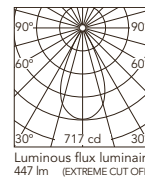

Beam Angle: 49°

h(m)	E(lx)	D(m)
1	717	0.91
2	179	1.82
3	80	2.72
4	45	3.63
5	29	4.54

Luminous flux luminaire
447 lm (EXTREME CUT OFF)

■ 05.7312.CU

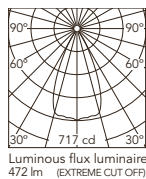

Beam Angle: 49°

h(m)	E(lx)	D(m)
1	717	0.91
2	179	1.83
3	80	2.74
4	45	3.66
5	29	4.57

Luminous flux luminaire
472 lm (EXTREME CUT OFF)

■ 05.7317.CU

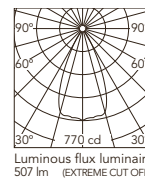

Beam Angle: 49°

h(m)	E(lx)	D(m)
1	770	0.91
2	193	1.83
3	86	2.74
4	48	3.66
5	31	4.57

Luminous flux luminaire
507 lm (EXTREME CUT OFF)

KAP

Kap Ø80/Kap Ø80 Plus - Fixed - Optic Spot

Light Source: Kap Ø80: LED Array DC 500 mA - 9,2W - 935 lm - 2700K/CRI 90 / 9,2W - 974 lm - 3000K/CRI 90
Kap Ø80 Plus: LED Array DC 700 mA - 13W - 1370 lm - 2700K/CRI 90 / 13W - 1460 lm - 3000K/CRI 90

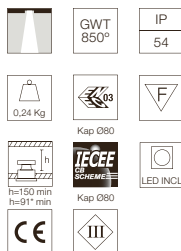
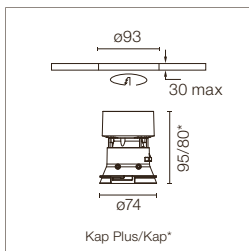

Incasso a LED. Fonte di alimentazione esclusa.
 Lente diffusore incluso.
 Cornice di pre-installazione da ordinare separatamente.

Recessed luminaire with LED light source. Power supply not included.
 Diffusing lens included.
 Pre-installation frame. To be ordered separately.

Alimentazioni raccomandate / Recommended power supply*:

	Kap Ø80	Kap Ø80 Plus
Non Dimmable	60.9160	60.9592
Dimmable 0/1-10V	RF27961	RF27961
Dimmable Dali 1	RF26571	RF26571
Dimmable Dali 2	60.9222	60.9222
Mains Dimming	60.9411	60.9467
Casambi	60.9207	60.9207

* Vedi capitolo Drivers / Refer to the Drivers chapter

2700K

Kap Ø80

- 03.4531.B1
- Kap Ø80 Plus
- 05.7451.B1

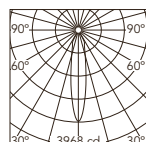

Beam Angle: 19°

h(m)	E(lx)	D(m)
1	3968	0.34
2	992	0.68
3	441	1.02
4	248	1.36
5	159	1.70

Luminous flux luminaire 1050 lm (EXTREME CUT OFF)

3000K

Kap Ø80

- 03.4530.B1
- Kap Ø80 Plus
- 05.7450.B1

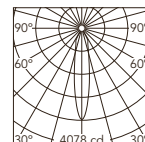

Beam Angle: 19°

h(m)	E(lx)	D(m)
1	4078	0.34
2	1019	0.68
3	453	1.02
4	255	1.36
5	163	1.70

Luminous flux luminaire 1079 lm (EXTREME CUT OFF)

Kap Ø80

- 03.4531.GL
- Kap Ø80 Plus
- 05.7451.GL

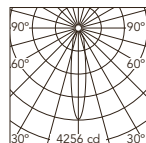

Beam Angle: 19°

h(m)	E(lx)	D(m)
1	4256	0.33
2	1064	0.67
3	473	1.00
4	266	1.33
5	170	1.66

Luminous flux luminaire 1011 lm (EXTREME CUT OFF)

Kap Ø80

- 03.4530.GL
- Kap Ø80 Plus
- 05.7450.GL

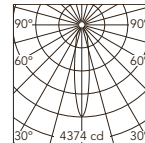

Beam Angle: 19°

h(m)	E(lx)	D(m)
1	4374	0.33
2	1093	0.67
3	486	1.00
4	273	1.33
5	175	1.66

Luminous flux luminaire 1039 lm (EXTREME CUT OFF)

Kap Ø80

- 03.4531.BU
- Kap Ø80 Plus
- 05.7451.BU

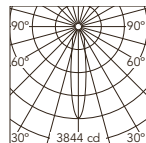

Beam Angle: 19°

h(m)	E(lx)	D(m)
1	3844	0.34
2	961	0.68
3	427	1.02
4	240	1.36
5	154	1.70

Luminous flux luminaire 948 lm (EXTREME CUT OFF)

Kap Ø80

- 03.4530.BU
- Kap Ø80 Plus
- 05.7450.BU

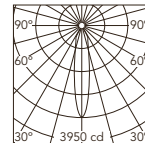

Beam Angle: 19°

h(m)	E(lx)	D(m)
1	3950	0.34
2	988	0.68
3	439	1.02
4	247	1.36
5	158	1.70

Luminous flux luminaire 974 lm (EXTREME CUT OFF)

Kap Ø80

- 03.4531.74
- Kap Ø80 Plus
- 05.7451.74

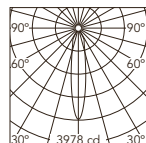

Beam Angle: 19°

h(m)	E(lx)	D(m)
1	3978	0.33
2	994	0.66
3	442	0.99
4	249	1.31
5	159	1.64

Luminous flux luminaire 929 lm (EXTREME CUT OFF)

Kap Ø80

- 03.4530.74
- Kap Ø80 Plus
- 05.7450.74

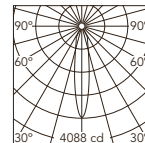

Beam Angle: 19°

h(m)	E(lx)	D(m)
1	4088	0.33
2	1022	0.66
3	454	0.99
4	255	1.31
5	164	1.64

Luminous flux luminaire 955 lm (EXTREME CUT OFF)

Kap Ø80

- 03.4531.CU
- Kap Ø80 Plus
- 05.7451.CU

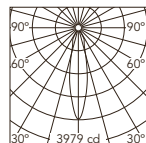

Beam Angle: 22°

h(m)	E(lx)	D(m)
1	3979	0.40
2	995	0.79
3	442	1.19
4	249	1.58
5	159	1.98

Luminous flux luminaire 1000 lm (EXTREME CUT OFF)
 @Kap 80 Plus

Kap Ø80

- 03.4530.CU
- Kap Ø80 Plus
- 05.7450.CU

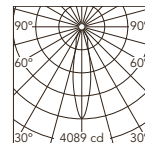

Beam Angle: 22°

h(m)	E(lx)	D(m)
1	4089	0.40
2	1022	0.79
3	454	1.19
4	256	1.58
5	164	1.98

Luminous flux luminaire 1027 lm (EXTREME CUT OFF)
 @Kap 80 Plus

Kap Ø80 Fixed - Optic Spot - Dim To Warm

Light Source: LED Array DC 300mA - 13W - max 940lm - 1800K - 2850K/CRI 95 - Dim To Warm

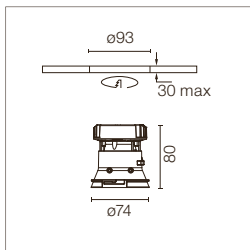

GWT 850°
 IP 54
 0.24 Kg
 20°
 LED INCL
 CE

Incasso a LED. Fonte di alimentazione 220-240V e dimmerabile 1-10V inclusa. Per versioni con apparecchi a 110V, contattare il Front office. Lente diffusore incluso. Cornice di pre-installazione da ordinare separatamente.

Recessed luminaire with LED light source. 220-240V & dimmable 1-10V power supply included. For 110V PSU versions, please consult with the front office. Diffusing lens included. Pre-installation frame. To be ordered separately.

1800K-2850K
 03.4530.B1.LE

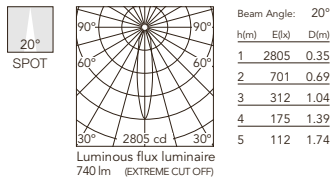

03.4530.GL.LE

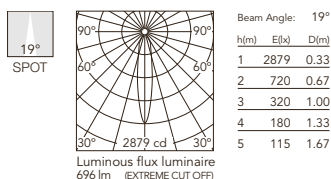

03.4530.BU.LE

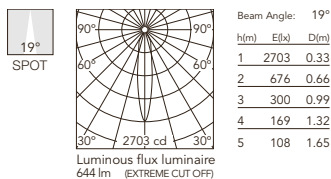

03.4530.74.LE

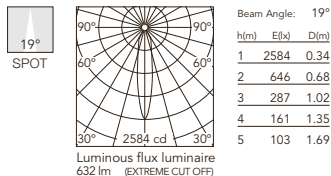

03.4530.CU.LE

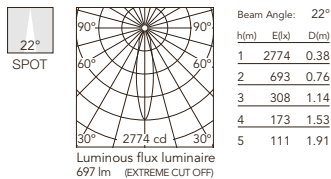

KAP

Kap Ø80/Kap Ø80 Plus - Fixed - Optic Medium

Light Source: Kap Ø80: LED Array DC 500 mA - 9,2W - 935 lm - 2700K/CRI 90 / 9,2W - 974 lm - 3000K/CRI 90
Kap Ø80 Plus: LED Array DC 700 mA - 13W - 1370 lm - 2700K/CRI 90 / 13W - 1460 lm - 3000K/CRI 90

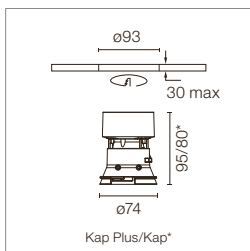

GWT 850°
 IP 54
 0,24 Kg
 Kap Ø80
 LED INCL
 CE
 III
 ICFEE
 h=150 mm h=91 mm
 Kap Ø80 Plus

Incasto a LED. Fonte di alimentazione esclusa.
 Lente diffusore incluso.
 Cornice di pre-installazione da ordinare separatamente.

Recessed luminaire with LED light source. Power supply not included.
 Diffusing lens included.
 Pre-installation frame. To be ordered separately.

Alimentazioni raccomandate / Recommended power supply*:

	Kap Ø80	Kap Ø80 Plus
Non Dimmable	60.9160	60.9592
Dimmable 0/1-10V	RF27961	RF27961
Dimmable Dali 1	RF26571	RF26571
Dimmable Dali 2	60.9222	60.9222
Mains Dimming	60.9411	60.9467
Casambi	60.9207	60.9207

* Vedi capitolo Drivers / Refer to the Drivers chapter

2700K

- 03.4181.B1
Kap Ø80 Plus
- 05.7411.B1

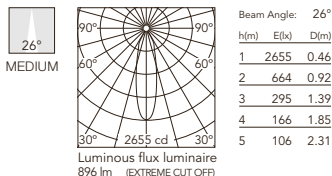

3000K

- 03.4180.B1
Kap Ø80 Plus
- 05.7410.B1

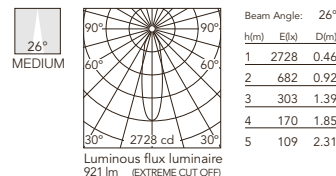

- 03.4181.GL
Kap Ø80 Plus
- 05.7411.GL

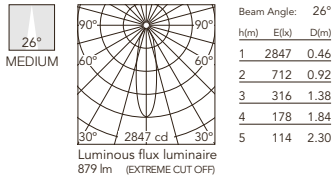

- 03.4180.GL
Kap Ø80 Plus
- 05.7410.GL

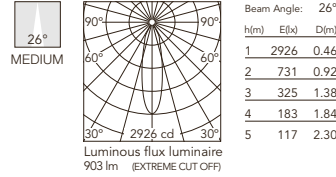

- 03.4181.BU
Kap Ø80 Plus
- 05.7411.BU

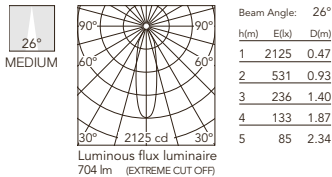

- 03.4180.BU
Kap Ø80 Plus
- 05.7410.BU

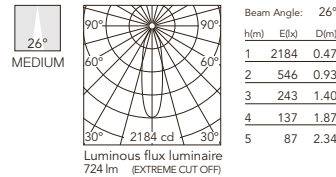

- 03.4181.74
Kap Ø80 Plus
- 05.7411.74

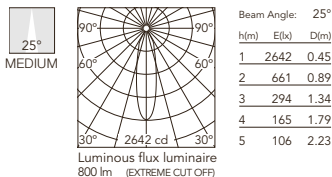

- 03.4180.74
Kap Ø80 Plus
- 05.7410.74

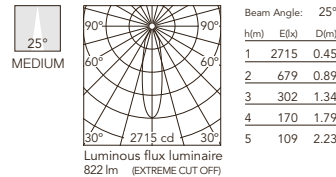

- 03.4181.CU
Kap Ø80 Plus
- 05.7411.CU

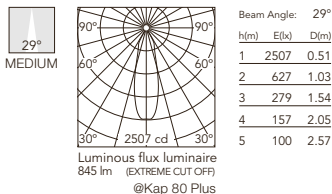

- 03.4180.CU
Kap Ø80 Plus
- 05.7410.CU

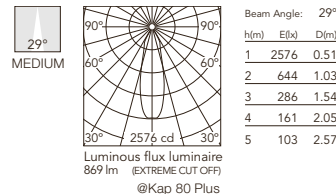

Kap Ø80 Fixed - Optic Medium - Dim To Warm

Light Source: LED Array DC 300mA - 13W - max 940lm - 1800K - 2850K/CRI 95 - Dim To Warm

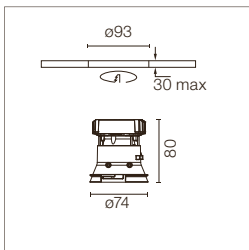

GWT 850°
 IP 54
 0.24 Kg
 0.3
 F
 h
 h=91 min
 LED INCL
 CE
 □

Incasso a LED. Fonte di alimentazione 220-240V e dimmerabile 1-10V inclusa. Per versioni con apparecchi a 110V, contattare il Front office. Lente diffusore incluso. Cornice di pre-installazione da ordinare separatamente.

Recessed luminaire with LED light source. 220-240V & dimmable 1-10V power supply included. For 110V PSU versions, please consult with the front office. Diffusing lens included. Pre-installation frame. To be ordered separately.

1800K-2850K
 03.4180.B1.LE

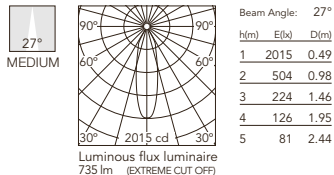

03.4180.GL.LE

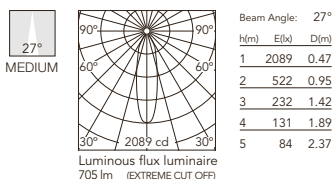

03.4180.BU.LE

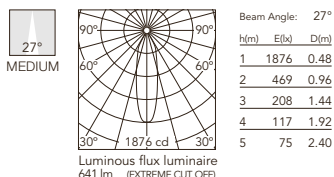

03.4180.74.LE

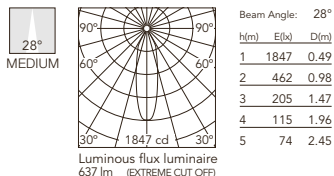

03.4180.CU.LE

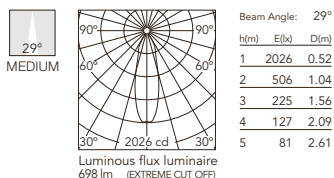

KAP

Kap Ø80/Kap Ø80 Plus - Fixed - Optic Flood

Light Source: Kap Ø80: LED Array DC 500 mA - 9,2W - 935 lm - 2700K/CRI 90 / 9,2W - 974 lm - 3000K/CRI 90
Kap Ø80 Plus: LED Array DC 700 mA - 13W - 1370 lm - 2700K/CRI 90 / 13W - 1460 lm - 3000K/CRI 90

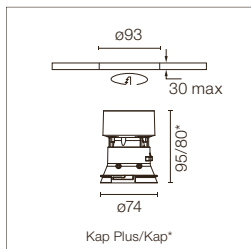

GWT 850°
 IP 54
 0,24 Kg
 Kap Ø80
 TECEE
 LED INCL
 CE

Incasso a LED. Fonte di alimentazione esclusa.
 Lente diffusore incluso.
 Cornice di pre-installazione da ordinare separatamente.

Recessed luminaire with LED light source. Power supply not included.
 Diffusing lens included.
 Pre-installation frame. To be ordered separately.

Alimentazioni raccomandate / Recommended power supply*:

	Kap Ø80	Kap Ø80 Plus
Non Dimmable	60.9160	60.9592
Dimmable 0/1-10V	RF27961	RF27961
Dimmable Dali 1	RF26571	RF26571
Dimmable Dali 2	60.9222	60.9222
Mains Dimming	60.9411	60.9467
Casambi	60.9207	60.9207

* Vedi capitolo Drivers / Refer to the Drivers chapter

- 2700K**
 Kap Ø80
 03.4533.B1
 Kap Ø80 Plus
 05.7453.B1

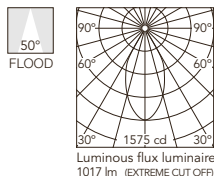

Beam Angle: 50°

h(m)	E(lx)	D(m)
1	1575	0.93
2	394	1.86
3	175	2.79
4	98	3.72
5	63	4.65

Luminous flux luminaire 1017 lm (EXTREME CUT OFF)

- 3000K**
 Kap Ø80
 03.4532.B1
 Kap Ø80 Plus
 05.7452.B1

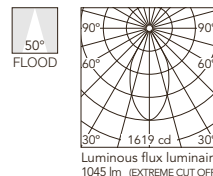

Beam Angle: 50°

h(m)	E(lx)	D(m)
1	1619	0.93
2	405	1.86
3	180	2.79
4	101	3.72
5	65	4.65

Luminous flux luminaire 1045 lm (EXTREME CUT OFF)

- Kap Ø80
 03.4533.GL
 Kap Ø80 Plus
 05.7453.GL

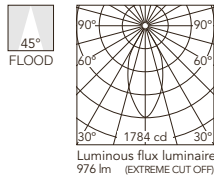

Beam Angle: 45°

h(m)	E(lx)	D(m)
1	1784	0.83
2	446	1.66
3	198	2.48
4	111	3.31
5	71	4.14

Luminous flux luminaire 976 lm (EXTREME CUT OFF)

- Kap Ø80
 03.4532.GL
 Kap Ø80 Plus
 05.7452.GL

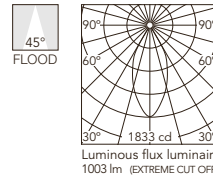

Beam Angle: 45°

h(m)	E(lx)	D(m)
1	1833	0.83
2	458	1.66
3	204	2.48
4	115	3.31
5	73	4.14

Luminous flux luminaire 1003 lm (EXTREME CUT OFF)

- Kap Ø80
 03.4533.BU
 Kap Ø80 Plus
 05.7453.BU

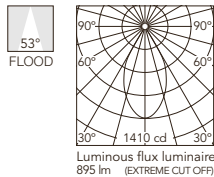

Beam Angle: 53°

h(m)	E(lx)	D(m)
1	1410	1.00
2	352	2.01
3	157	3.01
4	88	4.02
5	56	5.02

Luminous flux luminaire 895 lm (EXTREME CUT OFF)

- Kap Ø80
 03.4532.BU
 Kap Ø80 Plus
 05.7452.BU

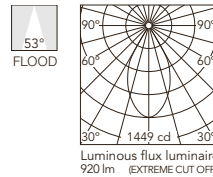

Beam Angle: 53°

h(m)	E(lx)	D(m)
1	1449	1.00
2	362	2.01
3	161	3.01
4	91	4.02
5	58	5.02

Luminous flux luminaire 920 lm (EXTREME CUT OFF)

- Kap Ø80
 03.4533.74
 Kap Ø80 Plus
 05.7453.74

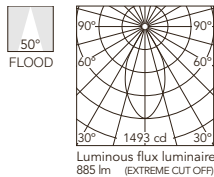

Beam Angle: 50°

h(m)	E(lx)	D(m)
1	1493	0.94
2	373	1.89
3	166	2.83
4	93	3.77
5	60	4.72

Luminous flux luminaire 885 lm (EXTREME CUT OFF)

- Kap Ø80
 03.4532.74
 Kap Ø80 Plus
 05.7452.74

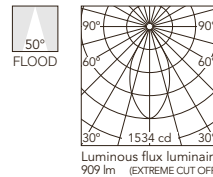

Beam Angle: 50°

h(m)	E(lx)	D(m)
1	1534	0.94
2	384	1.89
3	170	2.83
4	96	3.77
5	61	4.72

Luminous flux luminaire 909 lm (EXTREME CUT OFF)

- Kap Ø80
 03.4533.CU
 Kap Ø80 Plus
 05.7453.CU

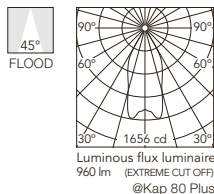

Beam Angle: 45°

h(m)	E(lx)	D(m)
1	1656	0.83
2	414	1.66
3	184	2.49
4	103	3.32
5	66	4.14

Luminous flux luminaire 960 lm (EXTREME CUT OFF)
 @Kap 80 Plus

- Kap Ø80
 03.4532.CU
 Kap Ø80 Plus
 05.7452.CU

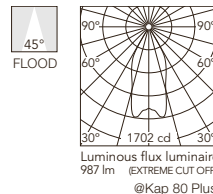

Beam Angle: 45°

h(m)	E(lx)	D(m)
1	1702	0.83
2	425	1.66
3	189	2.49
4	106	3.32
5	68	4.14

Luminous flux luminaire 987 lm (EXTREME CUT OFF)
 @Kap 80 Plus

Kap Ø80 Fixed - Optic Flood - Dim To Warm

Light Source: LED Array DC 300mA - 13W - max 940lm - 1800K - 2850K/CRI 95 - Dim To Warm

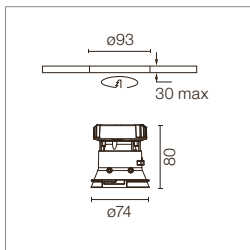

	GWT 850°	IP 54
	0,24 Kg	
	h=91 min	

Incasso a LED. Fonte di alimentazione 220-240V e dimmerabile 1-10V inclusa. Per versioni con apparecchi a 110V, contattare il Front office. Lente diffusore incluso. Cornice di pre-installazione da ordinare separatamente.

Recessed luminaire with LED light source. 220-240V & dimmable 1-10V power supply included. For 110V PSU versions, please consult with the front office. Diffusing lens included. Pre-installation frame. To be ordered separately.

1800K-2850K
03.4532.B1.LE

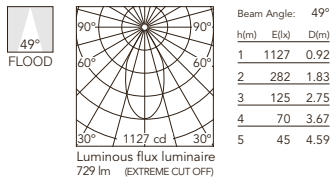

03.4532.GL.LE

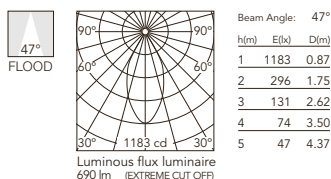

03.4532.BU.LE

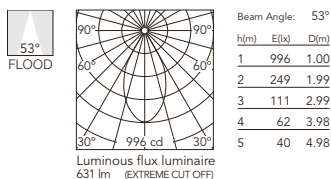

03.4532.74.LE

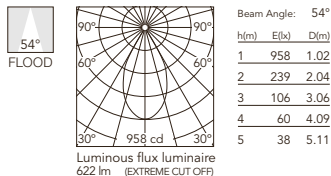

03.4532.CU.LE

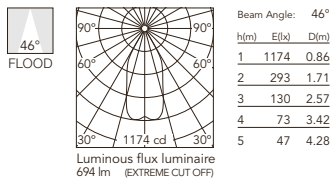

KAP

Kap 80/Kap 80 Plus Square - Fixed - Optic Spot

Light Source: Kap 80: LED Array DC 500 mA - 9,2W - 935 lm - 2700K/CRI 90 / 9,2W - 974 lm - 3000K/CRI 90
Kap 80 Plus: LED Array DC 700 mA - 13W - 1370 lm - 2700K/CRI 90 / 13W - 1460 lm - 3000K/CRI 90

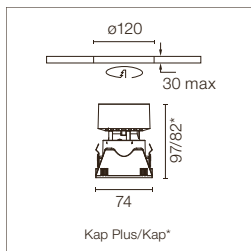

	GWT 850°		IP 54
	0,24 Kg		0,03
	Kap 80		F
	h=150 mm h=93° mm		LED INCL
	CE		III

Incasso a LED. Fonte di alimentazione esclusa.
 Lente diffusore incluso.
 Cornice di pre-installazione da ordinare separatamente.

Recessed luminaire with LED light source. Power supply not included.
 Diffusing lens included.
 Pre-installation frame. To be ordered separately.

Alimentazioni raccomandate / Recommended power supply*:

	Kap 80	Kap 80 Plus
Non Dimmable	60.9160	60.9592
Dimmable 0/1-10V	RF27961	RF27961
Dimmable Dali 1	RF26571	RF26571
Dimmable Dali 2	60.9222	60.9222
Mains Dimming	60.9411	60.9467
Casambi	60.9207	60.9207

* Vedi capitolo Drivers / Refer to the Drivers chapter

- 2700K**
 Kap 80
 03.4535.B1
 Kap 80 Plus
 05.7455.B1

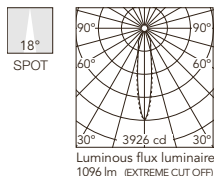

Beam Angle: 18°

h(m)	E(lx)	D(m)
1	3926	0.31
2	981	0.62
3	436	0.94
4	245	1.25
5	157	1.56

Luminous flux luminaire
1096 lm (EXTREME CUT OFF)

- 3000K**
 Kap 80
 03.4534.B1
 Kap 80 Plus
 05.7454.B1

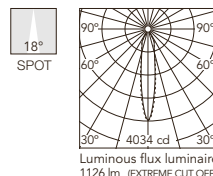

Beam Angle: 18°

h(m)	E(lx)	D(m)
1	4034	0.31
2	1009	0.62
3	448	0.94
4	252	1.25
5	161	1.56

Luminous flux luminaire
1126 lm (EXTREME CUT OFF)

- Kap 80
 03.4535.GL
 Kap 80 Plus
 05.7455.GL

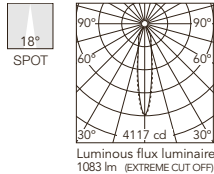

Beam Angle: 18°

h(m)	E(lx)	D(m)
1	4117	0.31
2	1029	0.63
3	457	0.94
4	257	1.26
5	165	1.57

Luminous flux luminaire
1083 lm (EXTREME CUT OFF)

- Kap 80
 03.4534.GL
 Kap 80 Plus
 05.7454.GL

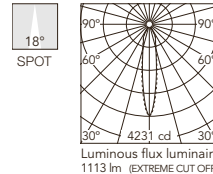

Beam Angle: 18°

h(m)	E(lx)	D(m)
1	4231	0.31
2	1058	0.63
3	470	0.94
4	264	1.26
5	169	1.57

Luminous flux luminaire
1113 lm (EXTREME CUT OFF)

- Kap 80
 03.4535.BU
 Kap 80 Plus
 05.7455.BU

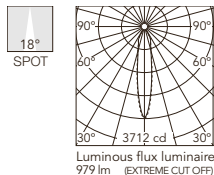

Beam Angle: 18°

h(m)	E(lx)	D(m)
1	3712	0.32
2	928	0.64
3	412	0.96
4	232	1.28
5	148	1.60

Luminous flux luminaire
979 lm (EXTREME CUT OFF)

- Kap 80
 03.4534.BU
 Kap 80 Plus
 05.7454.BU

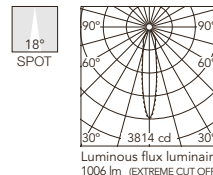

Beam Angle: 18°

h(m)	E(lx)	D(m)
1	3814	0.32
2	954	0.64
3	424	0.96
4	238	1.28
5	153	1.60

Luminous flux luminaire
1006 lm (EXTREME CUT OFF)

- Kap 80
 03.4535.74
 Kap 80 Plus
 05.7455.74

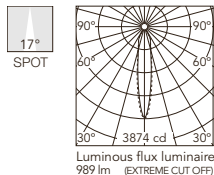

Beam Angle: 17°

h(m)	E(lx)	D(m)
1	3874	0.30
2	969	0.60
3	430	0.90
4	242	1.20
5	155	1.50

Luminous flux luminaire
989 lm (EXTREME CUT OFF)

- Kap 80
 03.4534.74
 Kap 80 Plus
 05.7454.74

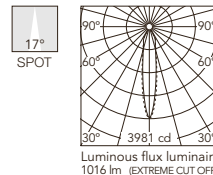

Beam Angle: 17°

h(m)	E(lx)	D(m)
1	3981	0.30
2	995	0.60
3	442	0.90
4	249	1.20
5	159	1.50

Luminous flux luminaire
1016 lm (EXTREME CUT OFF)

- Kap 80
 03.4535.CU
 Kap 80 Plus
 05.7455.CU

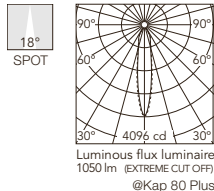

Beam Angle: 18°

h(m)	E(lx)	D(m)
1	4096	0.31
2	1024	0.62
3	455	0.94
4	256	1.25
5	164	1.56

Luminous flux luminaire
1050 lm (EXTREME CUT OFF)
 @Kap 80 Plus

- Kap 80
 03.4534.CU
 Kap 80 Plus
 05.7454.CU

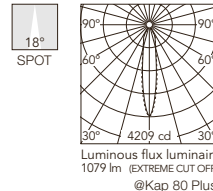

Beam Angle: 18°

h(m)	E(lx)	D(m)
1	4209	0.31
2	1052	0.62
3	468	0.94
4	263	1.25
5	168	1.56

Luminous flux luminaire
1079 lm (EXTREME CUT OFF)
 @Kap 80 Plus

Kap 80 Square Fixed - Optic Spot - Dim To Warm

Light Source: LED Array DC 300mA - 13W - max 940lm - 1800K - 2850K/CRI 95 - Dim To Warm

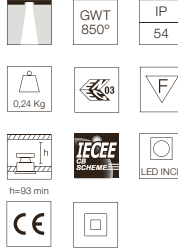
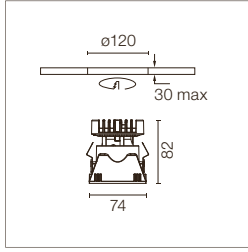

Incasso a LED. Fonte di alimentazione 220-240V e dimmerabile 1-10V inclusa. Per versioni con apparecchi a 110V, contattare il Front office. Lente diffusore incluso. Cornice di pre-installazione da ordinare separatamente.

Recessed luminaire with LED light source. 220-240V & dimmable 1-10V power supply included. For 110V PSU versions, please consult with the front office. Diffusing lens included. Pre-installation frame. To be ordered separately.

1800K-2850K
03.4534.B1.LE

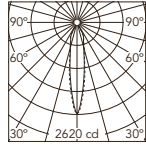

Luminous flux luminaire
753 lm (EXTREME CUT OFF)

Beam Angle: 18°

h(m)	E(lx)	D(m)
1	2620	0.32
2	655	0.64
3	291	0.96
4	164	1.28
5	105	1.60

03.4534.GL.LE

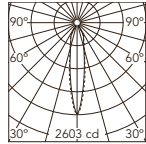

Luminous flux luminaire
719 lm (EXTREME CUT OFF)

Beam Angle: 18°

h(m)	E(lx)	D(m)
1	2603	0.32
2	651	0.64
3	289	0.96
4	163	1.28
5	104	1.60

03.4534.BU.LE

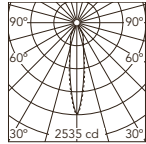

Luminous flux luminaire
676 lm (EXTREME CUT OFF)

Beam Angle: 18°

h(m)	E(lx)	D(m)
1	2535	0.31
2	634	0.63
3	282	0.94
4	158	1.26
5	101	1.57

03.4534.74.LE

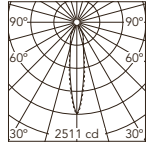

Luminous flux luminaire
667 lm (EXTREME CUT OFF)

Beam Angle: 18°

h(m)	E(lx)	D(m)
1	2511	0.31
2	628	0.63
3	279	0.94
4	157	1.25
5	100	1.57

03.4534.CU.LE

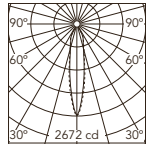

Luminous flux luminaire
715 lm (EXTREME CUT OFF)

Beam Angle: 18°

h(m)	E(lx)	D(m)
1	2672	0.32
2	668	0.64
3	297	0.96
4	167	1.29
5	107	1.61

KAP

Kap 80/Kap 80 Plus Square - Fixed - Optic Medium

Light Source: Kap 80: LED Array DC 500 mA - 9,2W - 935 lm - 2700K/CRI 90 / 9,2W - 974 lm - 3000K/CRI 90
Kap 80 Plus: LED Array DC 700 mA - 13W - 1370 lm - 2700K/CRI 90 / 13W - 1460 lm - 3000K/CRI 90

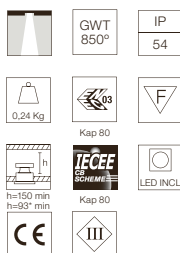
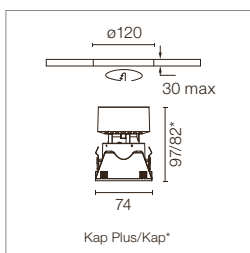

Incasso a LED. Fonte di alimentazione esclusa.
 Lente diffusore incluso.
 Cornice di pre-installazione da ordinare separatamente.

Recessed luminaire with LED light source. Power supply not included.
 Diffusing lens included.
 Pre-installation frame. To be ordered separately.

Alimentazioni raccomandate / Recommended power supply*:

	Kap 80	Kap 80 Plus
Non Dimmable	60.9160	60.9592
Dimmable 0/1-10V	RF27961	RF27961
Dimmable Dali 1	RF26571	RF26571
Dimmable Dali 2	60.9222	60.9222
Mains Dimming	60.9411	60.9467
Casambi	60.9207	60.9207

* Vedi capitolo Drivers / Refer to the Drivers chapter

- 2700K**
 Kap 80
 03.4183.B1
 Kap 80 Plus
 05.7413.B1

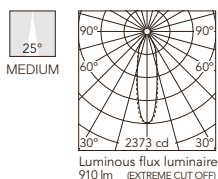

Beam Angle: 25°

h(m)	E(lx)	D(m)
1	2373	0.45
2	593	0.90
3	264	1.34
4	148	1.79
5	95	2.24

Luminous flux luminaire 910 lm (EXTREME CUT OFF)

- 3000K**
 Kap 80
 03.4182.B1
 Kap 80 Plus
 05.7412.B1

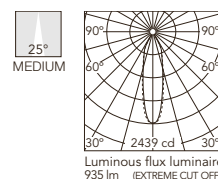

Beam Angle: 25°

h(m)	E(lx)	D(m)
1	2439	0.45
2	610	0.90
3	271	1.34
4	152	1.79
5	98	2.24

Luminous flux luminaire 935 lm (EXTREME CUT OFF)

- Kap 80
 03.4183.GL
 Kap 80 Plus
 05.7413.GL

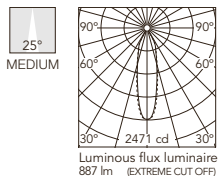

Beam Angle: 25°

h(m)	E(lx)	D(m)
1	2471	0.45
2	618	0.90
3	275	1.34
4	154	1.79
5	99	2.24

Luminous flux luminaire 887 lm (EXTREME CUT OFF)

- Kap 80
 03.4182.GL
 Kap 80 Plus
 05.7412.GL

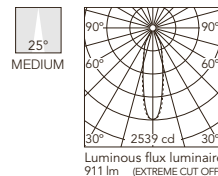

Beam Angle: 25°

h(m)	E(lx)	D(m)
1	2539	0.45
2	635	0.90
3	282	1.34
4	159	1.79
5	102	2.24

Luminous flux luminaire 911 lm (EXTREME CUT OFF)

- Kap 80
 03.4183.BU
 Kap 80 Plus
 05.7413.BU

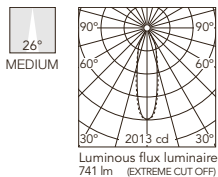

Beam Angle: 26°

h(m)	E(lx)	D(m)
1	2013	0.45
2	503	0.91
3	224	1.36
4	126	1.82
5	81	2.27

Luminous flux luminaire 741 lm (EXTREME CUT OFF)

- Kap 80
 03.4182.BU
 Kap 80 Plus
 05.7412.BU

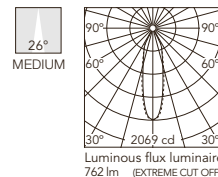

Beam Angle: 26°

h(m)	E(lx)	D(m)
1	2069	0.45
2	517	0.91
3	230	1.36
4	129	1.82
5	83	2.27

Luminous flux luminaire 762 lm (EXTREME CUT OFF)

- Kap 80
 03.4183.74
 Kap 80 Plus
 05.7413.74

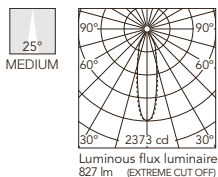

Beam Angle: 25°

h(m)	E(lx)	D(m)
1	2373	0.44
2	593	0.88
3	264	1.32
4	148	1.76
5	95	2.20

Luminous flux luminaire 827 lm (EXTREME CUT OFF)

- Kap 80
 03.4182.74
 Kap 80 Plus
 05.7412.74

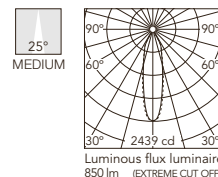

Beam Angle: 25°

h(m)	E(lx)	D(m)
1	2439	0.44
2	610	0.88
3	271	1.32
4	152	1.76
5	98	2.20

Luminous flux luminaire 850 lm (EXTREME CUT OFF)

- Kap 80
 03.4183.CU
 Kap 80 Plus
 05.7413.CU

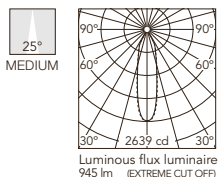

Beam Angle: 25°

h(m)	E(lx)	D(m)
1	2639	0.44
2	660	0.88
3	293	1.32
4	165	1.75
5	106	2.19

Luminous flux luminaire 945 lm (EXTREME CUT OFF)
 @Kap 80 Plus

- Kap 80
 03.4182.CU
 Kap 80 Plus
 05.7412.CU

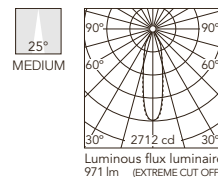

Beam Angle: 25°

h(m)	E(lx)	D(m)
1	2712	0.44
2	678	0.88
3	301	1.32
4	169	1.75
5	108	2.19

Luminous flux luminaire 971 lm (EXTREME CUT OFF)
 @Kap 80 Plus

Kap 80 Square Fixed - Optic Medium - Dim To Warm

Light Source: LED Array DC 300mA - 13W - max 940lm - 1800K - 2850K/CRI 95 - Dim To Warm

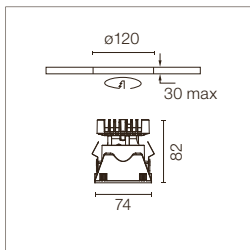

GWT 850°
 IP 54
 0.24 Kg
 03
 F
 h=93 min
 LED INCL
 CE
 □

Incasso a LED. Fonte di alimentazione 220-240V e dimmerabile 1-10V inclusa. Per versioni con apparecchi a 110V, contattare il Front office. Lente diffusore incluso. Cornice di pre-installazione da ordinare separatamente.

Recessed luminaire with LED light source. 220-240V & dimmable 1-10V power supply included. For 110V PSU versions, please consult with the front office. Diffusing lens included. Pre-installation frame. To be ordered separately.

1800K-2850K
 □ 03.4182.B1.LE

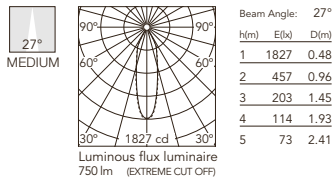

■ 03.4182.GL.LE

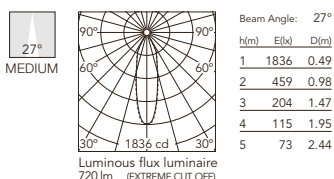

■ 03.4182.BU.LE

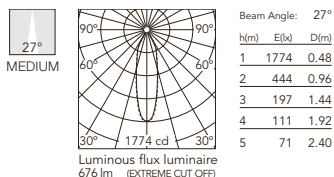

■ 03.4182.74.LE

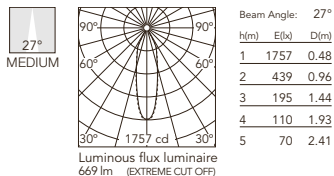

■ 03.4182.CU.LE

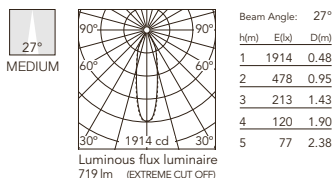

KAP

Kap 80/Kap 80 Plus Square - Fixed - Optic Flood

Light Source: Kap 80: LED Array DC 500 mA - 9,2W - 935 lm - 2700K/CRI 90 / 9,2W - 974 lm - 3000K/CRI 90
Kap 80 Plus: LED Array DC 700 mA - 13W - 1370 lm - 2700K/CRI 90 / 13W - 1460 lm - 3000K/CRI 90

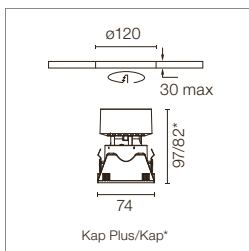

- GWT 850°
- IP 54
- 0,24 Kg
- 03
- F
- Kap 80
- IECEE SCHEDULE I
- Kap 80
- LED INCL
- h=150 min h=93° min
- CE
- III

Incasso a LED. Fonte di alimentazione esclusa.
 Lente diffusore incluso.
 Cornice di pre-installazione da ordinare separatamente.

Recessed luminaire with LED light source. Power supply not included.
 Diffusing lens included.
 Pre-installation frame. To be ordered separately.

Alimentazioni raccomandate / Recommended power supply*:

	Kap 80	Kap 80 Plus
Non Dimmable	60.9160	60.9592
Dimmable 0/1-10V	RF27961	RF27961
Dimmable Dali 1	RF26571	RF26571
Dimmable Dali 2	60.9222	60.9222
Mains Dimming	60.9411	60.9467
Casambi	60.9207	60.9207

* Vedi capitolo Drivers / Refer to the Drivers chapter

- 2700K**
 Kap 80
 03.4537.B1
 Kap 80 Plus
 05.7457.B1

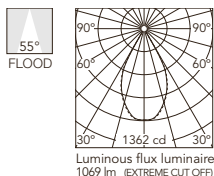

Beam Angle: 55°

h(m)	E(lx)	D(m)
1	1362	1.03
2	340	2.07
3	151	3.10
4	85	4.14
5	54	5.17

- 3000K**
 Kap 80
 03.4536.B1
 Kap 80 Plus
 05.7456.B1

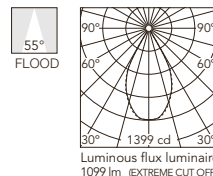

Beam Angle: 55°

h(m)	E(lx)	D(m)
1	1399	1.03
2	350	2.07
3	155	3.10
4	87	4.14
5	56	5.17

- Kap 80
 03.4537.GL
 Kap 80 Plus
 05.7457.GL

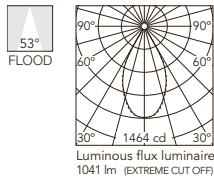

Beam Angle: 53°

h(m)	E(lx)	D(m)
1	1464	1.00
2	366	2.00
3	163	3.00
4	92	4.00
5	59	5.01

- Kap 80
 03.4536.GL
 Kap 80 Plus
 05.7456.GL

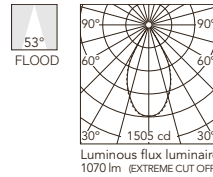

Beam Angle: 53°

h(m)	E(lx)	D(m)
1	1505	1.00
2	376	2.00
3	167	3.00
4	94	4.00
5	60	5.01

- Kap 80
 03.4537.BU
 Kap 80 Plus
 05.7457.BU

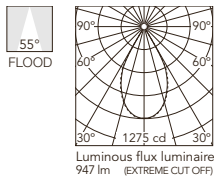

Beam Angle: 55°

h(m)	E(lx)	D(m)
1	1275	1.04
2	319	2.09
3	142	3.13
4	80	4.18
5	51	5.22

- Kap 80
 03.4536.BU
 Kap 80 Plus
 05.7456.BU

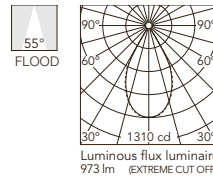

Beam Angle: 55°

h(m)	E(lx)	D(m)
1	1310	1.04
2	327	2.09
3	146	3.13
4	82	4.18
5	52	5.22

- Kap 80
 03.4537.74
 Kap 80 Plus
 05.7457.74

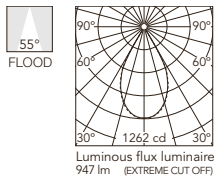

Beam Angle: 55°

h(m)	E(lx)	D(m)
1	1262	1.05
2	315	2.10
3	140	3.16
4	79	4.21
5	50	5.26

- Kap 80
 03.4536.74
 Kap 80 Plus
 05.7456.74

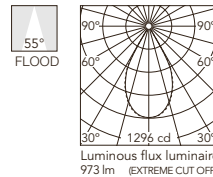

Beam Angle: 55°

h(m)	E(lx)	D(m)
1	1296	1.05
2	324	2.10
3	144	3.16
4	81	4.21
5	52	5.26

- Kap 80
 03.4537.CU
 Kap 80 Plus
 05.7457.CU

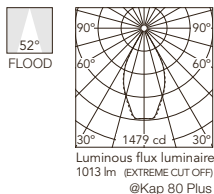

Beam Angle: 52°

h(m)	E(lx)	D(m)
1	1479	0.97
2	370	1.93
3	164	2.90
4	92	3.87
5	59	4.84

- Kap 80
 03.4536.CU
 Kap 80 Plus
 05.7456.CU

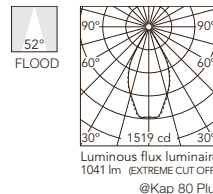

Beam Angle: 52°

h(m)	E(lx)	D(m)
1	1519	0.97
2	380	1.93
3	169	2.90
4	95	3.87
5	61	4.84

Kap 80 Square Fixed - Optic Flood - Dim To Warm

Light Source: LED Array DC 300mA - 13W - max 940lm - 1800K - 2850K/CRI 95 - Dim To Warm

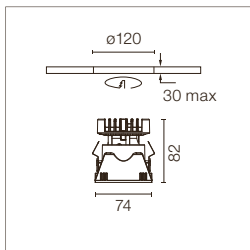

GWT 850°
 IP 54
 0,24 Kg
 0.3
 F
 TFCCE SCHEME
 LED INCL
 CE

Incasso a LED. Fonte di alimentazione 220-240V e dimmerabile 1-10V inclusa. Per versioni con apparecchi a 110V, contattare il Front office. Lente diffusore incluso. Cornice di pre-installazione da ordinare separatamente.

Recessed luminaire with LED light source. 220-240V & dimmable 1-10V power supply included. For 110V PSU versions, please consult with the front office. Diffusing lens included. Pre-installation frame. To be ordered separately.

1800K-2850K
 03.4536.B1.LE

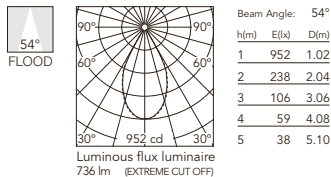

03.4536.GL.LE

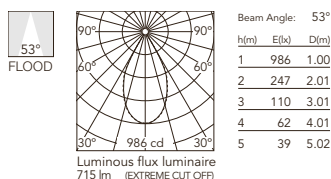

03.4536.BU.LE

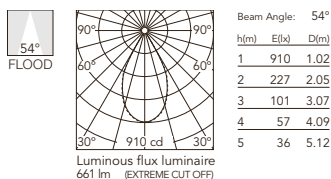

03.4536.74.LE

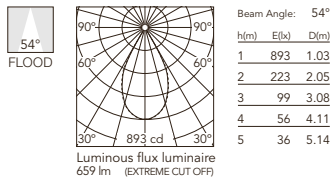

03.4536.CU.LE

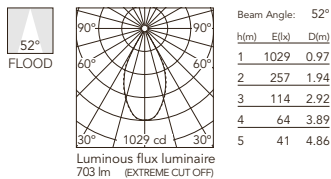

Kap Ø80 Fixed

Light Source: LED QR-CBC 51 GX5.3

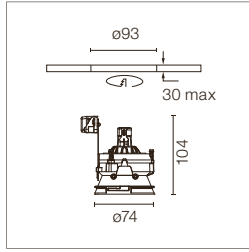

GWT 850°
 0,12 Kg

 IP 23
 h=130 min

Incasso per lampada di 12V.
 Trasformatore remoto non incluso.
 Accessori per lenti non disponibili.
 Cornice di pre-installazione da ordinare separatamente.

Recessed 12V lamp luminaire.
 Remote transformer not included.
 Not suitable for lens accessories.
 Pre-installation frame. To be ordered separately.

- 03.4228.B1
- 03.4228.GL
- 03.4228.BU
- 03.4228.74
- 03.4228.CU

Kap 80 Square Fixed

Light Source: LED QR-CBC 51 GX5.3

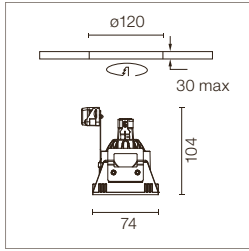

GWT 850°
 0,12 Kg

 IP 23
 h=130 min

Incasso per lampada di 12V.
 Trasformatore remoto non incluso.
 Accessori per lenti non disponibili.
 Cornice di pre-installazione da ordinare separatamente.

Recessed 12V lamp luminaire.
 Remote transformer not included.
 Not suitable for lens accessories.
 Pre-installation frame. To be ordered separately.

- 03.4226.B1
- 03.4226.GL
- 03.4226.BU
- 03.4226.74
- 03.4226.CU

Kap Ø80 Fixed

Light Source: LED PAR 16 GZ10

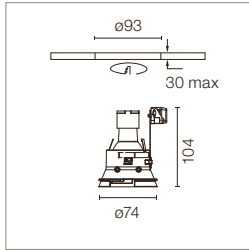

GWT 850°
 0,12 Kg

 IP 23
 h=155 min

Incasso con alimentazione in tensione di rete.
 Accessori per lenti non disponibili.
 Cornice di pre-installazione da ordinare separatamente.

Recessed luminaire with main voltage source.
 Not suitable for lens accessories.
 Pre-installation frame. To be ordered separately.

- 03.4229.B1
- 03.4229.GL
- 03.4229.BU
- 03.4229.74
- 03.4229.CU

Kap 80 Square Fixed

Light Source: LED PAR 16 GZ10

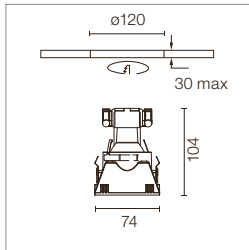

GWT 850°
 0,12 Kg

 IP 23
 h=155 min

Incasso con alimentazione in tensione di rete.
 Accessori per lenti non disponibili.
 Cornice di pre-installazione da ordinare separatamente.

Recessed luminaire with main voltage source.
 Not suitable for lens accessories.
 Pre-installation frame. To be ordered separately.

- 03.4227.B1
- 03.4227.GL
- 03.4227.BU
- 03.4227.74
- 03.4227.CU

Kap Ø80/Kap Ø80 Plus - Adjustable - Optic Spot

Light Source: Kap Ø80: LED Array DC 500 mA - 9,2W - 935 lm - 2700K/CRI 90 / 9,2W - 974 lm - 3000K/CRI 90
Kap Ø80 Plus: LED Array DC 700 mA - 13W - 1370 lm - 2700K/CRI 90 / 13W - 1460 lm - 3000K/CRI 90

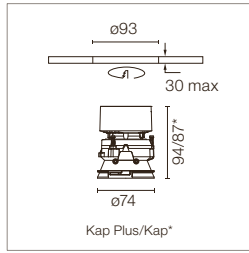

IP 54
 GWT 850°
 360°
 LED INCL
 Kap Ø80
 TEGEE CONFORME
 Kap Ø80
 0,24 Kg
 h=150 mm h=91 mm
 III

Incasto a LED. Fonte di alimentazione esclusa.
 Lente diffusore incluso.
 Cornice di pre-installazione da ordinare separatamente.

Recessed luminaire with LED light source. Power supply not included.
 Diffusing lens included.
 Pre-installation frame. To be ordered separately.

Alimentazioni raccomandate / Recommended power supply*:

	Kap Ø80	Kap Ø80 Plus
Non Dimmable	60.9160	60.9592
Dimmable 0/1-10V	RF27961	RF27961
Dimmable Dali 1	RF26571	RF26571
Dimmable Dali 2	60.9222	60.9222
Mains Dimming	60.9411	60.9467
Casambi	60.9207	60.9207

* Vedi capitolo Drivers / Refer to the Drivers chapter

- 2700K**
 Kap Ø80
 03.4539.B1
 Kap Ø80 Plus
 05.7459.B1

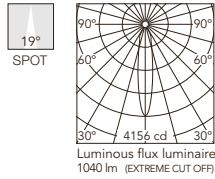

Beam Angle: 19°

h(m)	E(lx)	D(m)
1	4156	0.33
2	1039	0.66
3	462	0.99
4	260	1.33
5	166	1.66

- 3000K**
 Kap Ø80
 03.4538.B1
 Kap Ø80 Plus
 05.7458.B1

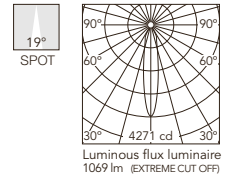

Beam Angle: 19°

h(m)	E(lx)	D(m)
1	4271	0.33
2	1068	0.66
3	475	0.99
4	267	1.33
5	171	1.66

- Kap Ø80
 03.4539.GL
 Kap Ø80 Plus
 05.7459.GL

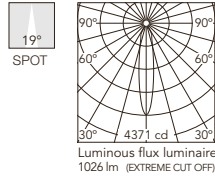

Beam Angle: 19°

h(m)	E(lx)	D(m)
1	4371	0.33
2	1093	0.66
3	486	0.99
4	273	1.32
5	175	1.65

- Kap Ø80
 03.4538.GL
 Kap Ø80 Plus
 05.7458.GL

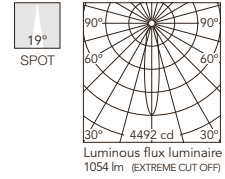

Beam Angle: 19°

h(m)	E(lx)	D(m)
1	4492	0.33
2	1123	0.66
3	499	0.99
4	281	1.32
5	180	1.65

- Kap Ø80
 03.4539.BU
 Kap Ø80 Plus
 05.7459.BU

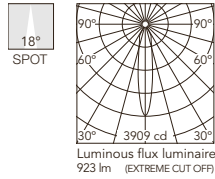

Beam Angle: 18°

h(m)	E(lx)	D(m)
1	3909	0.32
2	977	0.65
3	434	0.97
4	244	1.30
5	156	1.62

- Kap Ø80
 03.4538.BU
 Kap Ø80 Plus
 05.7458.BU

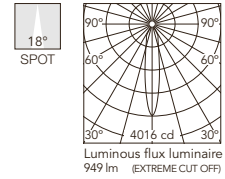

Beam Angle: 18°

h(m)	E(lx)	D(m)
1	4016	0.32
2	1004	0.65
3	446	0.97
4	251	1.30
5	161	1.62

- Kap Ø80
 03.4539.74
 Kap Ø80 Plus
 05.7459.74

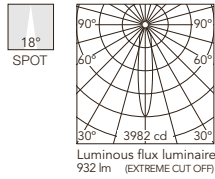

Beam Angle: 18°

h(m)	E(lx)	D(m)
1	3982	0.32
2	996	0.65
3	442	0.97
4	249	1.30
5	159	1.62

- Kap Ø80
 03.4538.74
 Kap Ø80 Plus
 05.7458.74

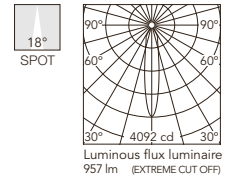

Beam Angle: 18°

h(m)	E(lx)	D(m)
1	4092	0.32
2	1023	0.65
3	455	0.97
4	256	1.30
5	164	1.62

- Kap Ø80
 03.4539.CU
 Kap Ø80 Plus
 05.7459.CU

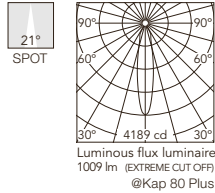

Beam Angle: 21°

h(m)	E(lx)	D(m)
1	4189	0.36
2	1047	0.72
3	465	1.09
4	262	1.45
5	168	1.81

- Kap Ø80
 03.4538.CU
 Kap Ø80 Plus
 05.7458.CU

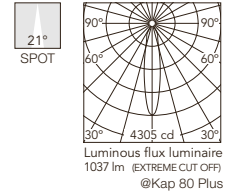

Beam Angle: 21°

h(m)	E(lx)	D(m)
1	4305	0.36
2	1076	0.72
3	478	1.09
4	269	1.45
5	172	1.81

Kap Ø80 Adjustable - Optic Spot - Dim To Warm

Light Source: LED Array DC 300mA - 13W - max 940lm - 1800K - 2850K/CRI 95 - Dim To Warm

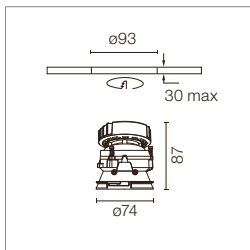

Incasto a LED. Fonte di alimentazione 220-240V e dimmerabile 1-10V inclusa. Per versioni con apparecchi a 110V, contattare il Front office. Lente diffusore incluso. Cornice di pre-installazione da ordinare separatamente.

Recessed luminaire with LED light source. 220-240V & dimmable 1-10V power supply included. For 110V PSU versions, please consult with the front office. Diffusing lens included. Pre-installation frame. To be ordered separately.

1800K-2850K
 03.4538.B1.LE

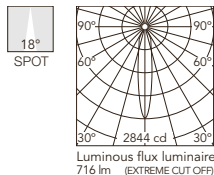

h(m)	E(lx)	D(m)
1	2844	0.31
2	711	0.63
3	316	0.94
4	178	1.25
5	114	1.56

03.4538.GL.LE

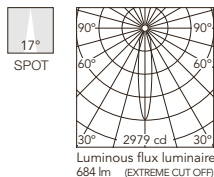

h(m)	E(lx)	D(m)
1	2979	0.30
2	745	0.61
3	331	0.91
4	186	1.21
5	119	1.52

03.4538.BU.LE

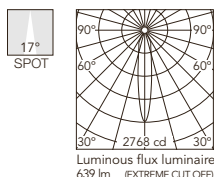

h(m)	E(lx)	D(m)
1	2768	0.31
2	692	0.61
3	308	0.92
4	173	1.22
5	111	1.53

03.4538.74.LE

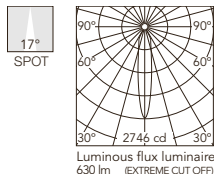

h(m)	E(lx)	D(m)
1	2746	0.31
2	687	0.61
3	305	0.92
4	172	1.22
5	110	1.53

03.4538.CU.LE

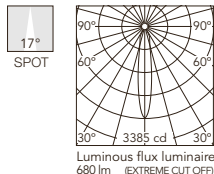

h(m)	E(lx)	D(m)
1	3385	0.30
2	846	0.60
3	376	0.90
4	212	1.20
5	135	1.50

Kap Ø80/Kap Ø80 Plus - Adjustable - Optic Medium

Light Source: Kap Ø80: LED Array DC 500 mA - 9,2W - 935 lm - 2700K/CRI 90 / 9,2W - 974 lm - 3000K/CRI 90
Kap Ø80 Plus: LED Array DC 700 mA - 13W - 1370 lm - 2700K/CRI 90 / 13W - 1460 lm - 3000K/CRI 90

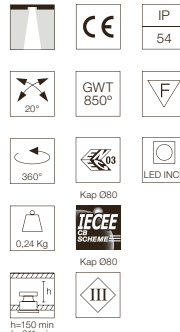
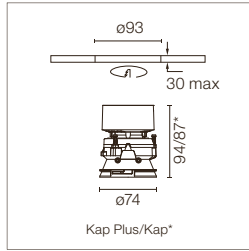

Incasto a LED. Fonte di alimentazione esclusa. Lente diffusore incluso. Cornice di pre-installazione da ordinare separatamente.

Recessed luminaire with LED light source. Power supply not included. Diffusing lens included. Pre-installation frame. To be ordered separately.

Alimentazioni raccomandate / Recommended power supply*:

	Kap Ø80	Kap Ø80 Plus
Non Dimmable	60.9160	60.9592
Dimmable 0/1-10V	RF27961	RF27961
Dimmable Dali 1	RF26571	RF26571
Dimmable Dali 2	60.9222	60.9222
Mains Dimming	60.9411	60.9467
Casambi	60.9207	60.9207

* Vedi capitolo Drivers / Refer to the Drivers chapter

- 2700K**
 Kap Ø80
 03.4185.B1
 Kap Ø80 Plus
 05.7415.B1

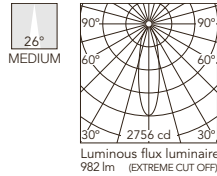

Beam Angle: 26°

h(m)	E(lx)	D(m)
1	2756	0.47
2	689	0.93
3	306	1.40
4	172	1.87
5	110	2.33

Luminous flux luminaire 982 lm (EXTREME CUT OFF)

- 3000K**
 Kap Ø80
 03.4184.B1
 Kap Ø80 Plus
 05.7414.B1

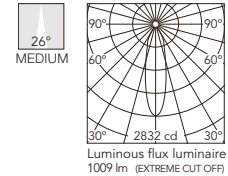

Beam Angle: 26°

h(m)	E(lx)	D(m)
1	2832	0.47
2	708	0.93
3	315	1.40
4	177	1.87
5	113	2.33

Luminous flux luminaire 1009 lm (EXTREME CUT OFF)

- Kap Ø80
 03.4185.GL
 Kap Ø80 Plus
 05.7415.GL

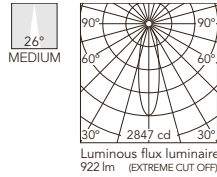

Beam Angle: 26°

h(m)	E(lx)	D(m)
1	2847	0.46
2	712	0.93
3	316	1.39
4	178	1.85
5	114	2.32

Luminous flux luminaire 922 lm (EXTREME CUT OFF)

- Kap Ø80
 03.4184.GL
 Kap Ø80 Plus
 05.7414.GL

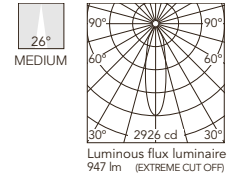

Beam Angle: 26°

h(m)	E(lx)	D(m)
1	2926	0.46
2	731	0.93
3	325	1.39
4	183	1.85
5	117	2.32

Luminous flux luminaire 947 lm (EXTREME CUT OFF)

- Kap Ø80
 03.4185.BU
 Kap Ø80 Plus
 05.7415.BU

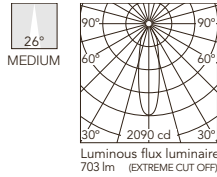

Beam Angle: 26°

h(m)	E(lx)	D(m)
1	2090	0.47
2	522	0.94
3	232	1.40
4	131	1.87
5	84	2.34

Luminous flux luminaire 703 lm (EXTREME CUT OFF)

- Kap Ø80
 03.4184.BU
 Kap Ø80 Plus
 05.7414.BU

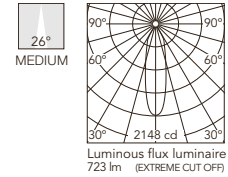

Beam Angle: 26°

h(m)	E(lx)	D(m)
1	2148	0.47
2	537	0.94
3	239	1.40
4	134	1.87
5	86	2.34

Luminous flux luminaire 723 lm (EXTREME CUT OFF)

- Kap Ø80
 03.4185.74
 Kap Ø80 Plus
 05.7415.74

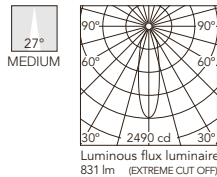

Beam Angle: 27°

h(m)	E(lx)	D(m)
1	2490	0.47
2	622	0.95
3	277	1.42
4	156	1.89
5	100	2.37

Luminous flux luminaire 831 lm (EXTREME CUT OFF)

- Kap Ø80
 03.4184.74
 Kap Ø80 Plus
 05.7414.74

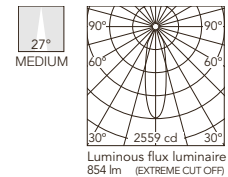

Beam Angle: 27°

h(m)	E(lx)	D(m)
1	2559	0.47
2	640	0.95
3	284	1.42
4	160	1.89
5	102	2.37

Luminous flux luminaire 854 lm (EXTREME CUT OFF)

- Kap Ø80
 03.4185.CU
 Kap Ø80 Plus
 05.7415.CU

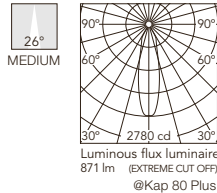

Beam Angle: 26°

h(m)	E(lx)	D(m)
1	2780	0.47
2	695	0.93
3	309	1.40
4	174	1.86
5	111	2.33

Luminous flux luminaire 871 lm (EXTREME CUT OFF) @Kap 80 Plus

- Kap Ø80
 03.4184.CU
 Kap Ø80 Plus
 05.7414.CU

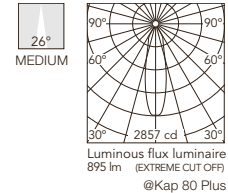

Beam Angle: 26°

h(m)	E(lx)	D(m)
1	2857	0.47
2	714	0.93
3	317	1.40
4	179	1.86
5	114	2.33

Luminous flux luminaire 895 lm (EXTREME CUT OFF) @Kap 80 Plus

KAP

Kap Ø80 Adjustable - Optic Medium - Dim To Warm

Light Source: LED Array DC 300mA - 13W - max 940lm - 1800K - 2850K/CRI 95 - Dim To Warm

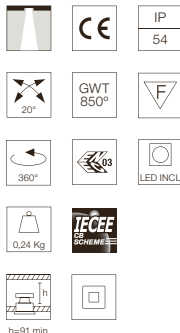
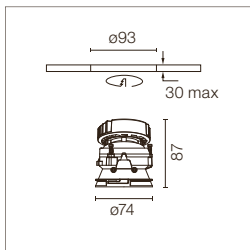

Incasso a LED. Fonte di alimentazione 220-240V e dimmerabile 1-10V inclusa. Per versioni con apparecchi a 110V, contattare il Front office. Lente diffusore incluso. Cornice di pre-installazione da ordinare separatamente.

Recessed luminaire with LED light source. 220-240V & dimmable 1-10V power supply included. For 110V PSU versions, please consult with the front office. Diffusing lens included. Pre-installation frame. To be ordered separately.

1800K-2850K
03.4184.B1.LE

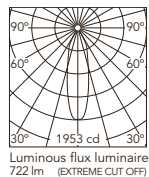

Beam Angle: 27°

h(m)	E(lx)	D(m)
1	1953	0.48
2	488	0.97
3	217	1.45
4	122	1.94
5	78	2.42

03.4184.GL.LE

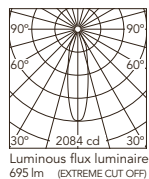

Beam Angle: 26°

h(m)	E(lx)	D(m)
1	2084	0.46
2	521	0.92
3	232	1.38
4	130	1.85
5	83	2.31

03.4184.BU.LE

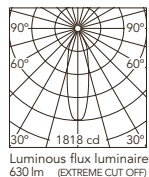

Beam Angle: 28°

h(m)	E(lx)	D(m)
1	1818	0.49
2	454	0.98
3	202	1.47
4	114	1.96
5	73	2.45

03.4184.74.LE

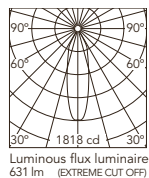

Beam Angle: 28°

h(m)	E(lx)	D(m)
1	1818	0.49
2	455	0.99
3	202	1.48
4	114	1.97
5	73	2.46

03.4184.CU.LE

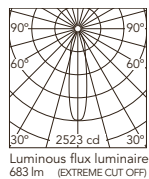

Beam Angle: 22°

h(m)	E(lx)	D(m)
1	2523	0.39
2	631	0.78
3	280	1.17
4	158	1.56
5	101	1.95

Kap Ø80/Kap Ø80 Plus - Adjustable - Optic Flood

Light Source: Kap Ø80: LED Array DC 500 mA - 9,2W - 935 lm - 2700K/CRI 90 / 9,2W - 974 lm - 3000K/CRI 90
Kap Ø80 Plus: LED Array DC 700 mA - 13W - 1370 lm - 2700K/CRI 90 / 13W - 1460 lm - 3000K/CRI 90

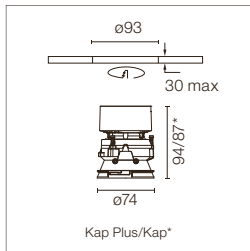

IP 54
 GWT 850°
 360°
 LED INCL
 CE
 Kap Ø80 Plus
 Kap Ø80
 0,24 Kg
 h=150 mm h=91 mm
 III

Incasso a LED. Fonte di alimentazione esclusa.
 Lente diffusore incluso.
 Cornice di pre-installazione da ordinare separatamente.

Recessed luminaire with LED light source. Power supply not included.
 Diffusing lens included.
 Pre-installation frame. To be ordered separately.

Alimentazioni raccomandate / Recommended power supply*:

	Kap Ø80	Kap Ø80 Plus
Non Dimmable	60.9160	60.9592
Dimmable 0/1-10V	RF27961	RF27961
Dimmable Dali 1	RF26571	RF26571
Dimmable Dali 2	60.9222	60.9222
Mains Dimming	60.9411	60.9467
Casambi	60.9207	60.9207

* Vedi capitolo Drivers / Refer to the Drivers chapter

- 2700K**
 Kap Ø80
 03.4541.B1
 Kap Ø80 Plus
 05.7461.B1

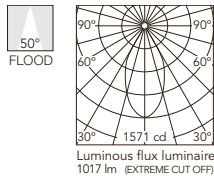

Beam Angle: 50°

h(m)	E(lx)	D(m)
1	1571	0.94
2	393	1.89
3	175	2.83
4	98	3.77
5	63	4.71

Luminous flux luminaire 1017 lm (EXTREME CUT OFF)

- 3000K**
 Kap Ø80
 03.4540.B1
 Kap Ø80 Plus
 05.7460.B1

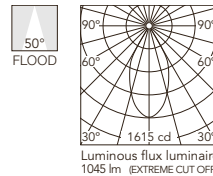

Beam Angle: 50°

h(m)	E(lx)	D(m)
1	1615	0.94
2	404	1.89
3	179	2.83
4	101	3.77
5	65	4.71

Luminous flux luminaire 1045 lm (EXTREME CUT OFF)

- Kap Ø80
 03.4541.GL
 Kap Ø80 Plus
 05.7461.GL

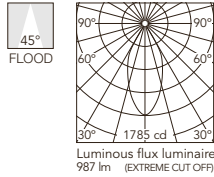

Beam Angle: 45°

h(m)	E(lx)	D(m)
1	1785	0.83
2	446	1.67
3	198	2.50
4	112	3.34
5	71	4.17

Luminous flux luminaire 987 lm (EXTREME CUT OFF)

- Kap Ø80
 03.4540.GL
 Kap Ø80 Plus
 05.7460.GL

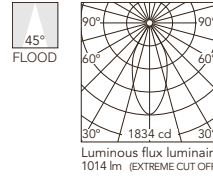

Beam Angle: 45°

h(m)	E(lx)	D(m)
1	1834	0.83
2	458	1.67
3	204	2.50
4	115	3.34
5	73	4.17

Luminous flux luminaire 1014 lm (EXTREME CUT OFF)

- Kap Ø80
 03.4541.BU
 Kap Ø80 Plus
 05.7461.BU

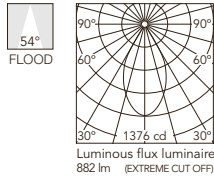

Beam Angle: 54°

h(m)	E(lx)	D(m)
1	1376	1.01
2	344	2.03
3	153	3.04
4	86	4.05
5	55	5.07

Luminous flux luminaire 882 lm (EXTREME CUT OFF)

- Kap Ø80
 03.4540.BU
 Kap Ø80 Plus
 05.7460.BU

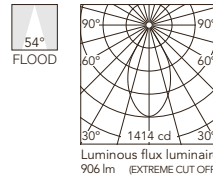

Beam Angle: 54°

h(m)	E(lx)	D(m)
1	1414	1.01
2	353	2.03
3	157	3.04
4	88	4.05
5	57	5.07

Luminous flux luminaire 906 lm (EXTREME CUT OFF)

- Kap Ø80
 03.4541.74
 Kap Ø80 Plus
 05.7461.74

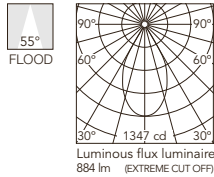

Beam Angle: 55°

h(m)	E(lx)	D(m)
1	1347	1.04
2	337	2.08
3	150	3.12
4	84	4.16
5	54	5.20

Luminous flux luminaire 884 lm (EXTREME CUT OFF)

- Kap Ø80
 03.4540.74
 Kap Ø80 Plus
 05.7460.74

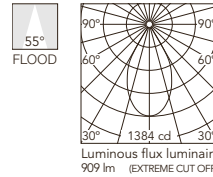

Beam Angle: 55°

h(m)	E(lx)	D(m)
1	1384	1.04
2	346	2.08
3	154	3.12
4	87	4.16
5	55	5.20

Luminous flux luminaire 909 lm (EXTREME CUT OFF)

- Kap Ø80
 03.4541.CU
 Kap Ø80 Plus
 05.7461.CU

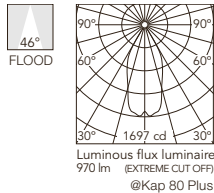

Beam Angle: 46°

h(m)	E(lx)	D(m)
1	1697	0.85
2	424	1.70
3	189	2.55
4	106	3.40
5	68	4.26

Luminous flux luminaire 970 lm (EXTREME CUT OFF) @Kap 80 Plus

- Kap Ø80
 03.4540.CU
 Kap Ø80 Plus
 05.7460.CU

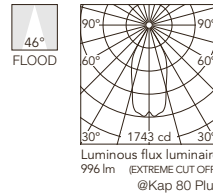

Beam Angle: 46°

h(m)	E(lx)	D(m)
1	1743	0.85
2	436	1.70
3	194	2.55
4	109	3.40
5	70	4.26

Luminous flux luminaire 996 lm (EXTREME CUT OFF) @Kap 80 Plus

Kap Ø80 Adjustable - Optic Flood - Dim To Warm

Light Source: LED Array DC 300mA - 13W - max 940lm - 1800K - 2850K/CRI 95 - Dim To Warm

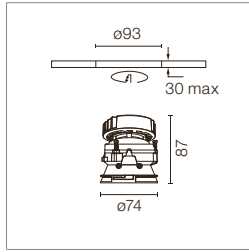

Incasso a LED. Fonte di alimentazione 220-240V e dimmerabile 1-10V inclusa. Per versioni con apparecchi a 110V, contattare il Front office. Lente diffusore incluso. Cornice di pre-installazione da ordinare separatamente.

Recessed luminaire with LED light source. 220-240V & dimmable 1-10V power supply included. For 110V PSU versions, please consult with the front office. Diffusing lens included. Pre-installation frame. To be ordered separately.

1800K-2850K
03.4540.B1.LE

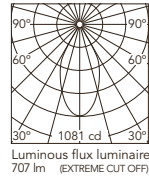

Beam Angle: 51°

h(m)	E(lx)	D(m)
1	1081	0.94
2	270	1.89
3	120	2.83
4	68	3.78
5	43	4.72

03.4540.GL.LE

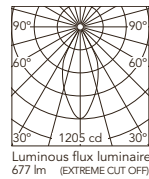

Beam Angle: 46°

h(m)	E(lx)	D(m)
1	1205	0.85
2	301	1.71
3	134	2.56
4	75	3.41
5	48	4.26

03.4540.BU.LE

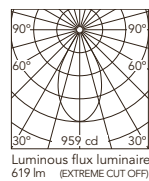

Beam Angle: 54°

h(m)	E(lx)	D(m)
1	959	1.01
2	240	2.02
3	107	3.03
4	60	4.04
5	38	5.05

03.4540.74.LE

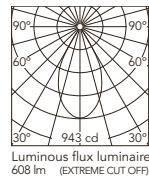

Beam Angle: 54°

h(m)	E(lx)	D(m)
1	943	1.01
2	236	2.03
3	105	3.04
4	59	4.06
5	38	5.07

03.4540.CU.LE

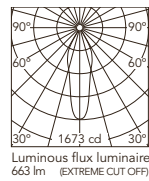

Beam Angle: 27°

h(m)	E(lx)	D(m)
1	1673	0.49
2	418	0.97
3	186	1.46
4	105	1.94
5	67	2.43

Kap 80/Kap 80 Plus Square - Adjustable - Optic Spot

Light Source: Kap 80: LED Array DC 500 mA - 9,2W - 935 lm - 2700K/CRI 90 / 9,2W - 974 lm - 3000K/CRI 90
Kap 80 Plus: LED Array DC 700 mA - 13W - 1370 lm - 2700K/CRI 90 / 13W - 1460 lm - 3000K/CRI 90

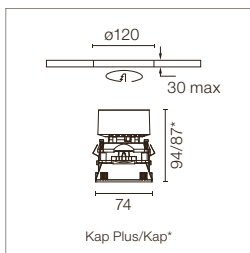

IP 54
 GWT 850°
 F
 360°
 Kap 80
 LED INCL
 TEGEE
 Kap 80 Plus
 h=150 mm h=91 mm
 III

Incasto a LED. Fonte di alimentazione esclusa.
 Lente diffusore incluso.
 Cornice di pre-installazione da ordinare separatamente.

Recessed luminaire with LED light source. Power supply not included.
 Diffusing lens included.
 Pre-installation frame. To be ordered separately.

Alimentazioni raccomandate / Recommended power supply*:

	Kap 80	Kap 80 Plus
Non Dimmable	60.9160	60.9592
Dimmable 0/1-10V	RF27961	RF27961
Dimmable Dali 1	RF26571	RF26571
Dimmable Dali 2	60.9222	60.9222
Mains Dimming	60.9411	60.9467
Casambi	60.9207	60.9207

* Vedi capitolo Drivers / Refer to the Drivers chapter

- 2700K**
 Kap 80
 03.4543.B1
 Kap 80 Plus
 05.7463.B1

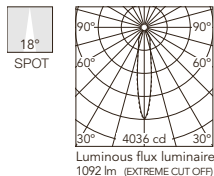

- 3000K**
 Kap 80
 03.4542.B1
 Kap 80 Plus
 05.7462.B1

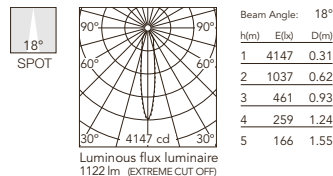

- Kap 80
 03.4543.GL
 Kap 80 Plus
 05.7463.GL

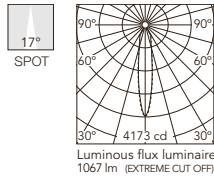

- Kap 80
 03.4542.GL
 Kap 80 Plus
 05.7462.GL

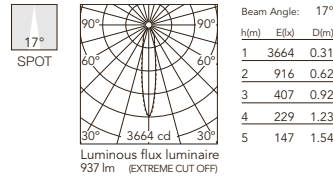

- Kap 80
 03.4543.BU
 Kap 80 Plus
 05.7463.BU

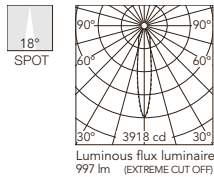

- Kap 80
 03.4542.BU
 Kap 80 Plus
 05.7462.BU

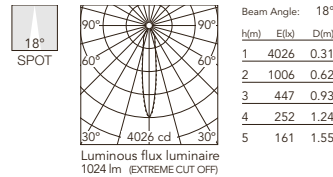

- Kap 80
 03.4543.74
 Kap 80 Plus
 05.7463.74

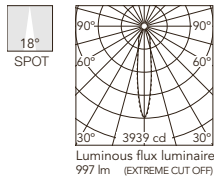

- Kap 80
 03.4542.74
 Kap 80 Plus
 05.7462.74

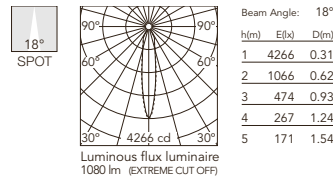

- Kap 80
 03.4543.CU
 Kap 80 Plus
 05.7463.CU

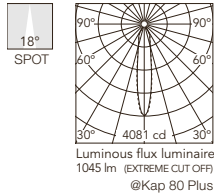

- Kap 80
 03.4542.CU
 Kap 80 Plus
 05.7462.CU

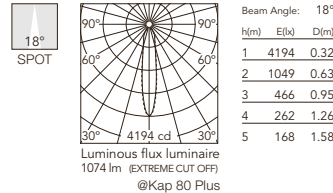

Kap 80 Square Adjustable - Optic Spot - Dim To Warm

Light Source: LED Array DC 300mA - 13W - max 940lm - 1800K - 2850K/CRI 95 - Dim To Warm

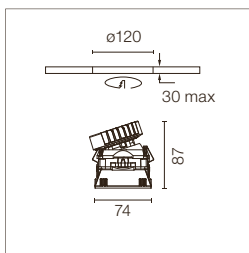

Incasso a LED. Fonte di alimentazione 220-240V e dimmerabile 1-10V inclusa. Per versioni con apparecchi a 110V, contattare il Front office. Lente diffusore incluso. Cornice di pre-installazione da ordinare separatamente.

Recessed luminaire with LED light source. 220-240V & dimmable 1-10V power supply included. For 110V PSU versions, please consult with the front office. Diffusing lens included. Pre-installation frame. To be ordered separately.

1800K-2850K
 03.4542.B1.LE

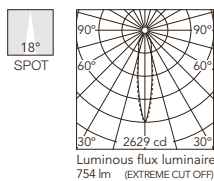

Beam Angle: 18°

h(m)	E(lx)	D(m)
1	2629	0.31
2	657	0.63
3	292	0.94
4	164	1.26
5	105	1.57

03.4542.GL.LE

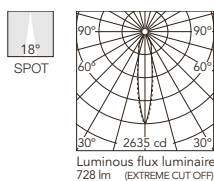

Beam Angle: 18°

h(m)	E(lx)	D(m)
1	2635	0.32
2	659	0.63
3	293	0.95
4	165	1.26
5	105	1.58

03.4542.BU.LE

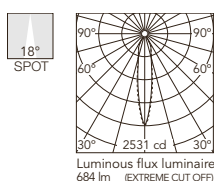

Beam Angle: 18°

h(m)	E(lx)	D(m)
1	2531	0.31
2	633	0.63
3	281	0.94
4	158	1.26
5	101	1.57

03.4542.74.LE

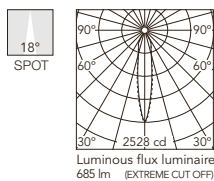

Beam Angle: 18°

h(m)	E(lx)	D(m)
1	2528	0.31
2	632	0.63
3	281	0.94
4	158	1.25
5	101	1.57

03.4542.CU.LE

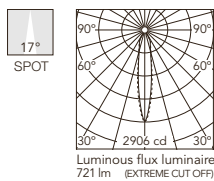

Beam Angle: 17°

h(m)	E(lx)	D(m)
1	2906	0.30
2	726	0.59
3	323	0.89
4	182	1.18
5	116	1.48

Kap 80/Kap 80 Plus Square - Adjustable - Optic Medium

Light Source: Kap 80: LED Array DC 500 mA - 9,2W - 935 lm - 2700K/CRI 90 / 9,2W - 974 lm - 3000K/CRI 90
Kap 80 Plus: LED Array DC 700 mA - 13W - 1370 lm - 2700K/CRI 90 / 13W - 1460 lm - 3000K/CRI 90

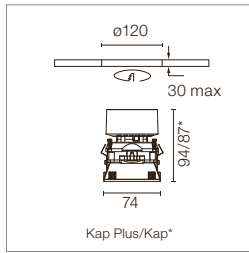

Incasto a LED. Fonte di alimentazione esclusa.
 Lente diffusore incluso.
 Cornice di pre-installazione da ordinare separatamente.

Recessed luminaire with LED light source. Power supply not included.
 Diffusing lens included.
 Pre-installation frame. To be ordered separately.

Alimentazioni raccomandate / Recommended power supply*:

	Kap 80	Kap 80 Plus
Non Dimmable	60.9160	60.9592
Dimmable 0/1-10V	RF27961	RF27961
Dimmable Dali 1	RF26571	RF26571
Dimmable Dali 2	60.9222	60.9222
Mains Dimming	60.9411	60.9467
Casambi	60.9207	60.9207

* Vedi capitolo Drivers / Refer to the Drivers chapter

- 2700K**
 Kap 80
 03.4187.B1
 Kap 80 Plus
 05.7417.B1

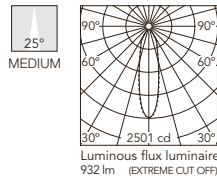

Beam Angle: 25°

h(m)	E(lx)	D(m)
1	2501	0.44
2	625	0.88
3	278	1.32
4	156	1.76
5	100	2.20

- 3000K**
 Kap 80
 03.4186.B1
 Kap 80 Plus
 05.7416.B1

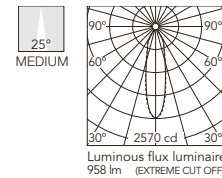

Beam Angle: 25°

h(m)	E(lx)	D(m)
1	2570	0.44
2	643	0.88
3	286	1.32
4	161	1.76
5	103	2.20

- Kap 80
 03.4187.GL
 Kap 80 Plus
 05.7417.GL

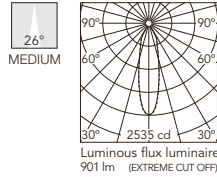

Beam Angle: 26°

h(m)	E(lx)	D(m)
1	2535	0.46
2	634	0.91
3	282	1.37
4	158	1.83
5	101	2.28

- Kap 80
 03.4186.GL
 Kap 80 Plus
 05.7416.GL

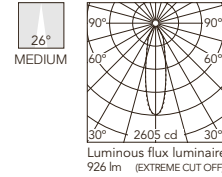

Beam Angle: 26°

h(m)	E(lx)	D(m)
1	2605	0.46
2	651	0.91
3	289	1.37
4	163	1.83
5	104	2.28

- Kap 80
 03.4187.BU
 Kap 80 Plus
 05.7417.BU

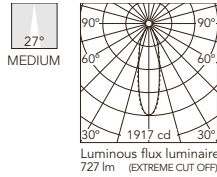

Beam Angle: 27°

h(m)	E(lx)	D(m)
1	1917	0.47
2	479	0.94
3	213	1.41
4	120	1.88
5	77	2.36

- Kap 80
 03.4186.BU
 Kap 80 Plus
 05.7416.BU

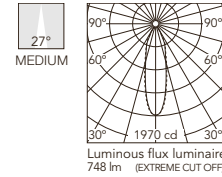

Beam Angle: 27°

h(m)	E(lx)	D(m)
1	1970	0.47
2	492	0.94
3	219	1.41
4	123	1.88
5	79	2.36

- Kap 80
 03.4187.74
 Kap 80 Plus
 05.7417.74

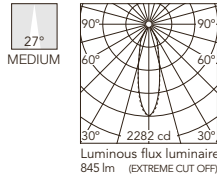

Beam Angle: 27°

h(m)	E(lx)	D(m)
1	2282	0.49
2	570	0.97
3	254	1.46
4	143	1.94
5	91	2.43

- Kap 80
 03.4186.74
 Kap 80 Plus
 05.7416.74

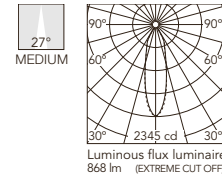

Beam Angle: 27°

h(m)	E(lx)	D(m)
1	2345	0.49
2	586	0.97
3	261	1.46
4	147	1.94
5	94	2.43

- Kap 80
 03.4187.CU
 Kap 80 Plus
 05.7417.CU

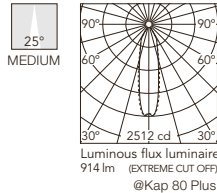

Beam Angle: 25°

h(m)	E(lx)	D(m)
1	2512	0.44
2	628	0.87
3	279	1.31
4	157	1.75
5	100	2.18

- Kap 80
 03.4186.CU
 Kap 80 Plus
 05.7416.CU

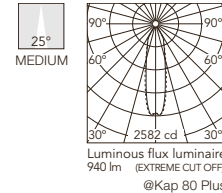

Beam Angle: 25°

h(m)	E(lx)	D(m)
1	2582	0.44
2	645	0.87
3	287	1.31
4	161	1.75
5	103	2.18

Kap 80 Square Adjustable - Optic Medium - Dim To Warm

Light Source: LED Array DC 300mA - 13W - max 940lm - 1800K - 2850K/CRI 95 - Dim To Warm

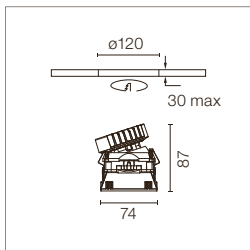

Incasso a LED. Fonte di alimentazione 220-240V e dimmerabile 1-10V inclusa. Per versioni con apparecchi a 110V, contattare il Front office. Lente diffusore incluso. Cornice di pre-installazione da ordinare separatamente.

Recessed luminaire with LED light source. 220-240V & dimmable 1-10V power supply included. For 110V PSU versions, please consult with the front office. Diffusing lens included. Pre-installation frame. To be ordered separately.

1800K-2850K
03.4186.B1.LE

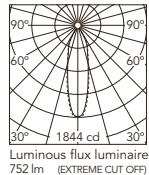

Beam Angle: 26°

h(m)	E(lx)	D(m)
1	1844	0.47
2	461	0.94
3	205	1.41
4	115	1.88
5	74	2.35

03.4186.GL.LE

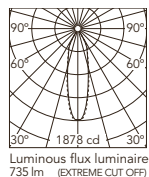

Beam Angle: 27°

h(m)	E(lx)	D(m)
1	1878	0.47
2	470	0.95
3	209	1.42
4	117	1.89
5	75	2.37

03.4186.BU.LE

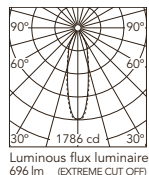

Beam Angle: 27°

h(m)	E(lx)	D(m)
1	1786	0.47
2	447	0.95
3	198	1.42
4	112	1.89
5	71	2.37

03.4186.74.LE

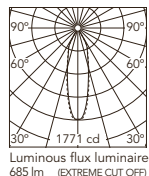

Beam Angle: 27°

h(m)	E(lx)	D(m)
1	1771	0.48
2	443	0.96
3	197	1.44
4	111	1.93
5	71	2.41

03.4186.CU.LE

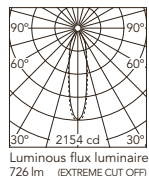

Beam Angle: 22°

h(m)	E(lx)	D(m)
1	2154	0.40
2	538	0.79
3	239	1.19
4	135	1.59
5	86	1.98

Kap 80/Kap 80 Plus Square - Adjustable - Optic Flood

Light Source: Kap 80: LED Array DC 500 mA - 9,2W - 935 lm - 2700K/CRI 90 / 9,2W - 974 lm - 3000K/CRI 90
Kap 80 Plus: LED Array DC 700 mA - 13W - 1370 lm - 2700K/CRI 90 / 13W - 1460 lm - 3000K/CRI 90

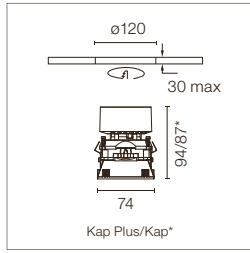

IP 54
 GWT 850°
 20°
 360°
 LED INCL
 Kap 80
 TEGEE
 Kap 80 Plus
 0,24 Kg
 h=150 mm
 h=92 mm
 III

Incasto a LED. Fonte di alimentazione esclusa. Lente diffusore incluso. Cornice di pre-installazione da ordinare separatamente.

Recessed luminaire with LED light source. Power supply not included. Diffusing lens included. Pre-installation frame. To be ordered separately.

Alimentazioni raccomandate / Recommended power supply*:

	Kap 80	Kap 80 Plus
Non Dimmable	60.9160	60.9592
Dimmable 0/1-10V	RF27961	RF27961
Dimmable Dali 1	RF26571	RF26571
Dimmable Dali 2	60.9222	60.9222
Mains Dimming	60.9411	60.9467
Casambi	60.9207	60.9207

* Vedi capitolo Drivers / Refer to the Drivers chapter

- 2700K**
 Kap 80
 03.4545.B1
 Kap 80 Plus
 05.7465.B1

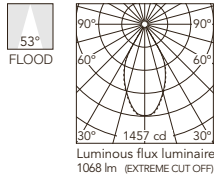

Beam Angle: 53°

h(m)	E(lx)	D(m)
1	1457	0.99
2	364	1.98
3	162	2.98
4	91	3.97
5	58	4.96

- 3000K**
 Kap 80
 03.4544.B1
 PlusPro
 05.7464.B1

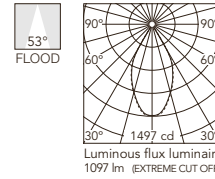

Beam Angle: 53°

h(m)	E(lx)	D(m)
1	1497	0.99
2	374	1.98
3	166	2.98
4	94	3.97
5	60	4.96

- Kap 80
 03.4545.GL
 Kap 80 Plus
 05.7465.GL

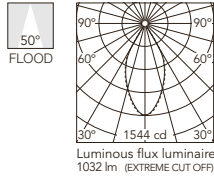

Beam Angle: 50°

h(m)	E(lx)	D(m)
1	1544	0.93
2	386	1.86
3	172	2.79
4	96	3.72
5	62	4.65

- Kap 80
 03.4544.GL
 Kap 80 Plus
 05.7464.GL

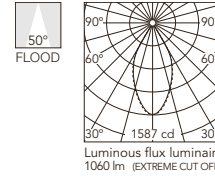

Beam Angle: 50°

h(m)	E(lx)	D(m)
1	1587	0.93
2	397	1.86
3	176	2.79
4	99	3.72
5	63	4.65

- Kap 80
 03.4545.BU
 Kap 80 Plus
 05.7465.BU

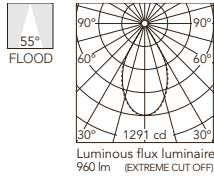

Beam Angle: 55°

h(m)	E(lx)	D(m)
1	1291	1.05
2	323	2.09
3	143	3.14
4	81	4.19
5	52	5.23

- Kap 80
 03.4544.BU
 Kap 80 Plus
 05.7464.BU

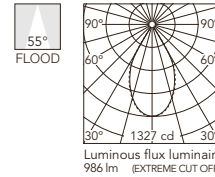

Beam Angle: 55°

h(m)	E(lx)	D(m)
1	1327	1.05
2	332	2.09
3	147	3.14
4	83	4.19
5	53	5.23

- Kap 80
 03.4545.74
 Kap 80 Plus
 05.7465.74

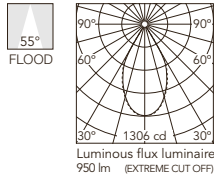

Beam Angle: 55°

h(m)	E(lx)	D(m)
1	1306	1.04
2	326	2.08
3	145	3.11
4	82	4.15
5	52	5.19

- Kap 80
 03.4544.74
 Kap 80 Plus
 05.7464.74

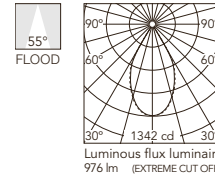

Beam Angle: 55°

h(m)	E(lx)	D(m)
1	1342	1.04
2	335	2.08
3	149	3.11
4	84	4.15
5	54	5.19

- Kap 80
 03.4545.CU
 Kap 80 Plus
 05.7465.CU

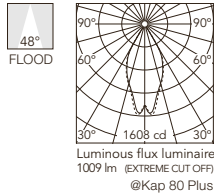

Beam Angle: 48°

h(m)	E(lx)	D(m)
1	1608	0.88
2	402	1.77
3	179	2.65
4	101	3.53
5	64	4.42

- Kap 80
 03.4544.CU
 Kap 80 Plus
 05.7464.CU

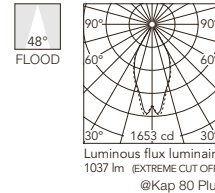

Beam Angle: 48°

h(m)	E(lx)	D(m)
1	1653	0.88
2	413	1.77
3	184	2.65
4	103	3.53
5	66	4.42

Kap Ø80 Adjustable

Light Source: LED QR-CBC 51 GX5.3

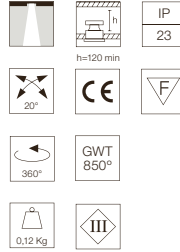
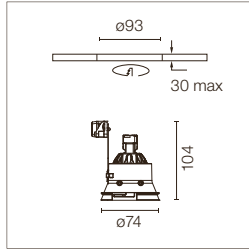

Incasso per lampada di 12V.
Trasformatore remoto non incluso.
Accessori per lenti non disponibili.
Cornice di pre-installazione da ordinare separatamente.

Recessed 12V lamp luminaire.
Remote transformer not included.
Not suitable for lens accessories.
Pre-installation frame. To be ordered separately.

- 03.4236.B1
- 03.4236.GL
- 03.4236.BU
- 03.4236.74
- 03.4236.CU

Kap 80 Square Adjustable

Light Source: LED QR-CBC 51 GX5.3

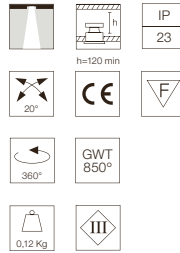
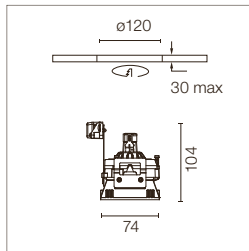

Incasso per lampada di 12V.
Trasformatore remoto non incluso.
Accessori per lenti non disponibili.
Cornice di pre-installazione da ordinare separatamente.

Recessed 12V lamp luminaire.
Remote transformer not included.
Not suitable for lens accessories.
Pre-installation frame. To be ordered separately.

- 03.4234.B1
- 03.4234.GL
- 03.4234.BU
- 03.4234.74
- 03.4234.CU

Kap Ø80 Adjustable

Light Source: LED PAR 16 GZ10

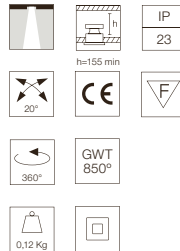
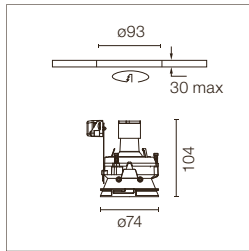

Incasso con alimentazione in tensione di rete.
Accessori per lenti non disponibili.
Cornice di pre-installazione da ordinare separatamente.

Recessed luminaire with main voltage source.
Not suitable for lens accessories.
Pre-installation frame. To be ordered separately.

- 03.4237.B1
- 03.4237.GL
- 03.4237.BU
- 03.4237.74
- 03.4237.CU

Kap 80 Square Adjustable

Light Source: LED PAR 16 GZ10

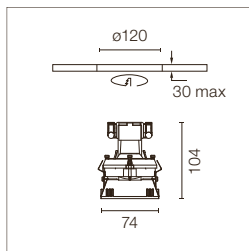

Incasso con alimentazione in tensione di rete.
Accessori per lenti non disponibili.
Cornice di pre-installazione da ordinare separatamente.

Recessed luminaire with main voltage source.
Not suitable for lens accessories.
Pre-installation frame. To be ordered separately.

- 03.4235.B1
- 03.4235.GL
- 03.4235.BU
- 03.4235.74
- 03.4235.CU

KAP

Kap Ø80/Kap Ø80 Plus - Wall-Washer

Light Source: Kap Ø80: LED Array DC 500 mA - 9,2W - 935 lm - 2700K/CRI 90 / 9,2W - 974 lm - 3000K/CRI 90
Kap Ø80 Plus: LED Array DC 700 mA - 13W - 1370 lm - 2700K/CRI 90 / 13W - 1460 lm - 3000K/CRI 90

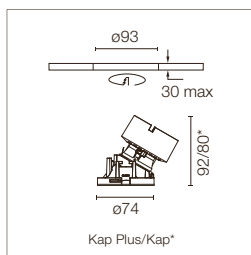

-
-
-
-
-
-
-
-
-
-
-
-

Incasto a LED. Fonte di alimentazione esclusa.
 Lente ellittica inclusa.
 Cornice di pre-installazione da ordinare separatamente.

Recessed luminaire with LED light source. Power supply not included.
 Elliptical lens included.
 Pre-installation frame. To be ordered separately.

Alimentazioni raccomandate / Recommended power supply*:

	Kap Ø80	Kap Ø80 Plus
Non Dimmable	60.9160	60.9592
Dimmable 0/1-10V	RF27961	RF27961
Dimmable Dali 1	RF26571	RF26571
Dimmable Dali 2	60.9222	60.9222
Mains Dimming	60.9411	60.9467
Casambi	60.9207	60.9207

* Vedi capitolo Drivers / Refer to the Drivers chapter

- 2700K**
- 03.4189.B1
Kap Ø80 Plus
 - 05.7421.B1

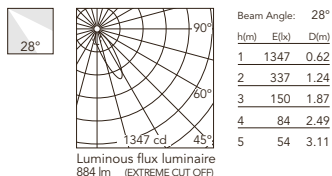

- 3000K**
- 03.4188.B1
Kap Ø80 Plus
 - 05.7420.B1

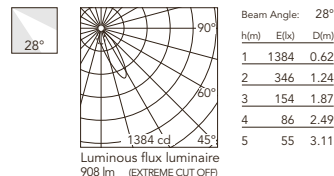

- Kap Ø80
- 03.4189.GL
Kap Ø80 Plus
 - 05.7421.GL

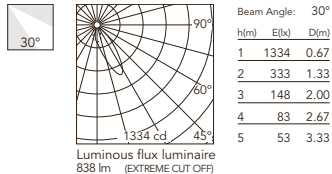

- Kap Ø80
- 03.4188.GL
Kap Ø80 Plus
 - 05.7420.GL

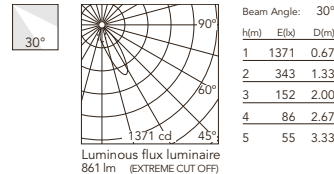

- Kap Ø80
- 03.4189.BU
Kap Ø80 Plus
 - 05.7421.BU

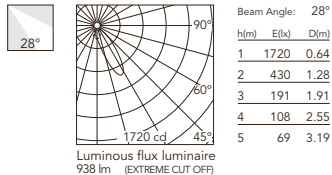

- Kap Ø80
- 03.4188.BU
Kap Ø80 Plus
 - 05.7420.BU

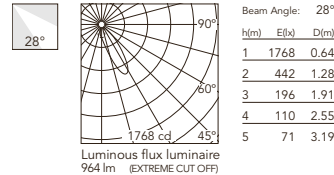

- Kap Ø80
- 03.4189.74
Kap Ø80 Plus
 - 05.7421.74

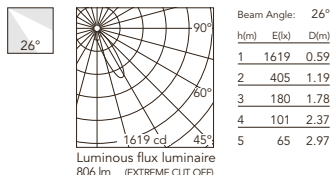

- Kap Ø80
- 03.4188.74
Kap Ø80 Plus
 - 05.7420.74

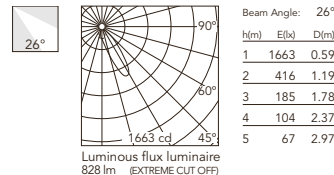

- Kap Ø80
- 03.4189.CU
Kap Ø80 Plus
 - 05.7421.CU

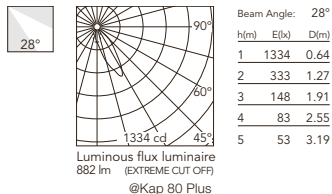

- Kap Ø80
- 03.4188.CU
Kap Ø80 Plus
 - 05.7420.CU

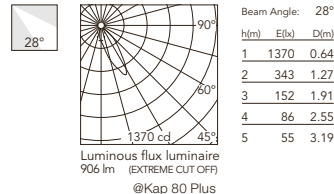

Kap Ø80 Wall-Washer - Dim To Warm

Light Source: LED Array DC 300mA - 13W - max 940lm - 1800K - 2850K/CRI 95 - Dim To Warm

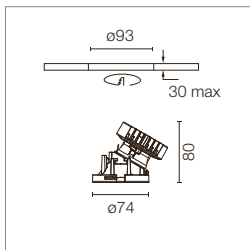

Incasso a LED. Fonte di alimentazione 220-240V e dimmerabile 1-10V inclusa. Per versioni con apparecchi a 110V, contattare il Front office. Lente diffusore incluso. Cornice di pre-installazione da ordinare separatamente.

Recessed luminaire with LED light source. 220-240V & dimmable 1-10V power supply included. For 110V PSU versions, please consult with the front office. Diffusing lens included. Pre-installation frame. To be ordered separately.

1800K-2850K
03.4188.B1.LE

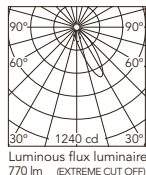

Beam Angle: 28°

h(m)	E(lx)	D(m)
1	1240	0.64
2	310	1.29
3	138	1.93
4	78	2.58
5	50	3.22

03.4188.GL.LE

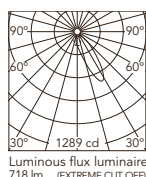

Beam Angle: 27°

h(m)	E(lx)	D(m)
1	1289	0.63
2	322	1.25
3	143	1.88
4	81	2.50
5	52	3.13

03.4188.BU.LE

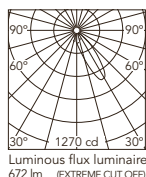

Beam Angle: 28°

h(m)	E(lx)	D(m)
1	1270	0.65
2	317	1.30
3	141	1.96
4	79	2.61
5	51	3.26

03.4188.74.LE

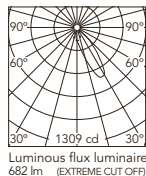

Beam Angle: 28°

h(m)	E(lx)	D(m)
1	1309	0.64
2	327	1.28
3	145	1.92
4	82	2.56
5	52	3.20

03.4188.CU.LE

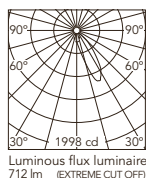

Beam Angle: 27°

h(m)	E(lx)	D(m)
1	1998	0.60
2	500	1.20
3	222	1.80
4	125	2.40
5	80	3.00

KAP

Kap 80/Kap 80 Plus - Square Wall-Washer

Light Source: Kap 80: LED Array DC 500 mA - 9,2W - 935 lm - 2700K/CRI 90 / 9,2W - 974 lm - 3000K/CRI 90
Kap 80 Plus: LED Array DC 700 mA - 13W - 1370 lm - 2700K/CRI 90 / 13W - 1460 lm - 3000K/CRI 90

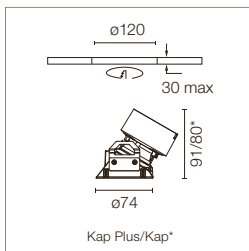

Technical specifications and certifications:

- 0,24 Kg
- GWT 850°
- IP 54
- h=150 min, h=81* min
- CE
- TCFEE
- LED INCL

Incasto a LED. Fonte di alimentazione esclusa. Lente ellittica inclusa. Cornice di pre-installazione da ordinare separatamente.

Recessed luminaire with LED light source. Power supply not included. Elliptical lens included. Pre-installation frame. To be ordered separately.

Alimentazioni raccomandate / Recommended power supply*:

	Kap 80	Kap 80 Plus
Non Dimmable	60.9160	60.9592
Dimmable 0/1-10V	RF27961	RF27961
Dimmable Dali 1	RF26571	RF26571
Dimmable Dali 2	60.9222	60.9222
Mains Dimming	60.9411	60.9467
Casambi	60.9207	60.9207

* Vedi capitolo Drivers / Refer to the Drivers chapter

- 2700K**
 Kap 80
 03.4191.B1
 Kap 80 Plus
 05.7423.B1

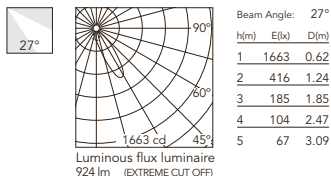

- 3000K**
 Kap 80
 03.4190.B1
 Kap 80 Plus
 05.7422.B1

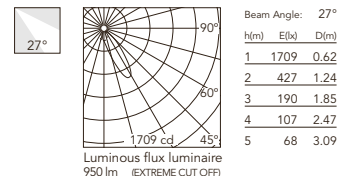

- Kap 80
 03.4191.GL
 Kap 80 Plus
 05.7423.GL

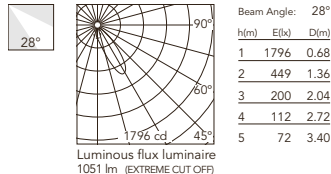

- Kap 80
 03.4190.GL
 Kap 80 Plus
 05.7422.GL

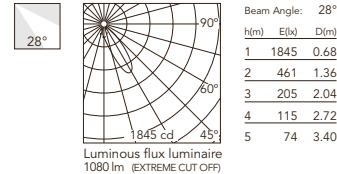

- Kap 80
 03.4191.BU
 Kap 80 Plus
 05.7423.BU

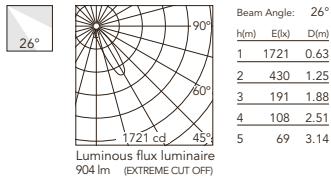

- Kap 80
 03.4190.BU
 Kap 80 Plus
 05.7422.BU

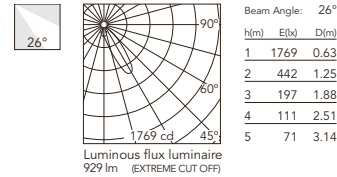

- Kap 80
 03.4191.74
 Kap 80 Plus
 05.7423.74

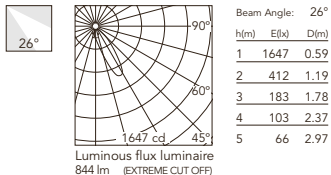

- Kap 80
 03.4190.74
 Kap 80 Plus
 05.7422.74

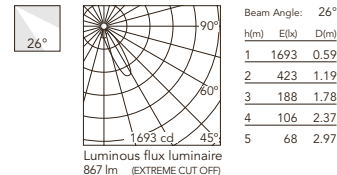

- Kap 80
 03.4191.CU
 Kap 80 Plus
 05.7423.CU

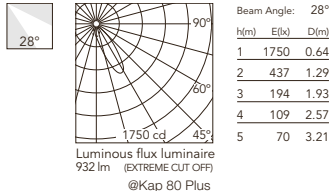

- Kap 80
 03.4190.CU
 Kap 80 Plus
 05.7422.CU

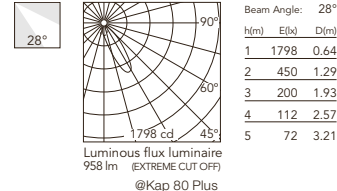

Kap 80 Square Wall-Washer - Dim To Warm

Light Source: LED Array DC 300mA - 13W - max 940lm - 1800K - 2850K/CRI 95 - Dim To Warm

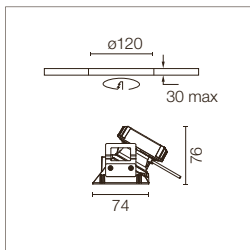

Incasso a LED. Fonte di alimentazione 220-240V e dimmerabile 1-10V inclusa. Per versioni con apparecchi a 110V, contattare il Front office. Lente diffusore incluso. Cornice di pre-installazione da ordinare separatamente.

Recessed luminaire with LED light source. 220-240V & dimmable 1-10V power supply included. For 110V PSU versions, please consult with the front office. Diffusing lens included. Pre-installation frame. To be ordered separately.

1800K-2850K
03.4190.B1.LE

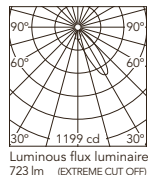

Beam Angle: 28°

h(m)	E(lx)	D(m)
1	1199	0.68
2	300	1.37
3	133	2.05
4	75	2.74
5	48	3.42

03.4190.GL.LE

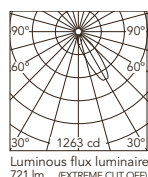

Beam Angle: 28°

h(m)	E(lx)	D(m)
1	1263	0.69
2	316	1.38
3	140	2.07
4	79	2.75
5	51	3.44

03.4190.BU.LE

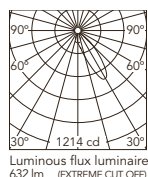

Beam Angle: 28°

h(m)	E(lx)	D(m)
1	1214	0.68
2	304	1.35
3	135	2.03
4	76	2.71
5	49	3.39

03.4190.74.LE

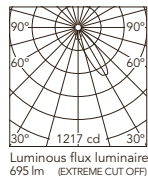

Beam Angle: 27°

h(m)	E(lx)	D(m)
1	1217	0.66
2	304	1.33
3	135	1.99
4	76	2.66
5	49	3.32

03.4190.CU.LE

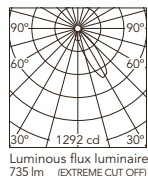

Beam Angle: 29°

h(m)	E(lx)	D(m)
1	1292	0.70
2	323	1.40
3	144	2.10
4	81	2.80
5	52	3.50

Kap Ø80 Wall-Washer

Light Source: LED QR-CBC 51 GX5.3

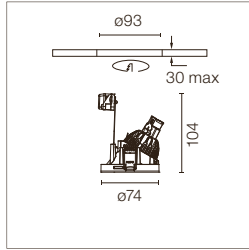
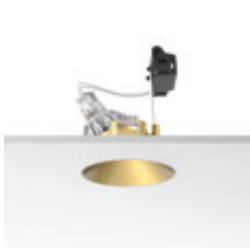

Incasso per lampada di 12V.
Trasformatore remoto non incluso.
Accessori per lenti non disponibili.
Cornice di pre-installazione da ordinare separatamente.

Recessed 12V lamp luminaire.
Remote transformer not included.
Not suitable for lens accessories.
Pre-installation frame. To be ordered separately.

- 03.4244.B1
- 03.4244.GL
- 03.4244.BU
- 03.4244.74
- 03.4244.CU

Kap 80 Square Wall-Washer

Light Source: LED QR-CBC 51 GX5.3

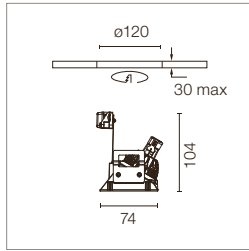

Incasso per lampada di 12V.
Trasformatore remoto non incluso.
Accessori per lenti non disponibili.
Cornice di pre-installazione da ordinare separatamente.

Recessed 12V lamp luminaire.
Remote transformer not included.
Not suitable for lens accessories.
Pre-installation frame. To be ordered separately.

- 03.4242.B1
- 03.4242.GL
- 03.4242.BU
- 03.4242.74
- 03.4242.CU

Kap Ø80 Wall-Washer

Light Source: LED PAR 16 GZ10

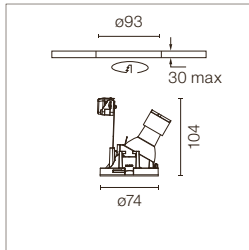

Incasso con alimentazione in tensione di rete.
Accessori per lenti non disponibili.
Cornice di pre-installazione da ordinare separatamente.

Recessed luminaire with main voltage source.
Not suitable for lens accessories.
Pre-installation frame. To be ordered separately.

- 03.4245.B1
- 03.4245.GL
- 03.4245.BU
- 03.4245.74
- 03.4245.CU

Kap 80 Square Wall-Washer

Light Source: LED PAR 16 GZ10

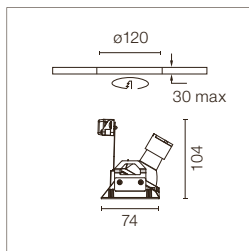

Incasso con alimentazione in tensione di rete.
Accessori per lenti non disponibili.
Cornice di pre-installazione da ordinare separatamente.

Recessed luminaire with main voltage source.
Not suitable for lens accessories.
Pre-installation frame. To be ordered separately.

- 03.4243.B1
- 03.4243.GL
- 03.4243.BU
- 03.4243.74
- 03.4243.CU

Kap 105 Square

Light Source: Phosphor LED 17W - 1400 lm - 2700K/CRI 98 / 17W - 1400 lm - 3000K/CRI 98

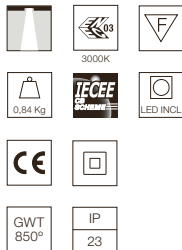
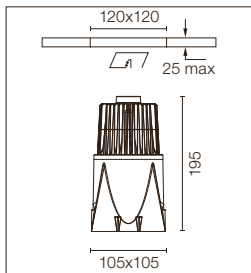

Incasso a LED. Trasformatore elettronico remoto 220/240V incluso.
Cornice di pre-installazione da ordinare separatamente.

Recessed luminaire with LED light source. Remote electronic transformer 220/240V included.
Pre-installation frame. To be ordered separately.

2700K

Non Dimmable

- 03.4595.B1C
Dali Version
- 03.4595.B1CDA
1-10V
- 03.4595.B1C1V

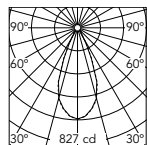

Beam Angle: 45°

h(m)	E(lx)	D(m)
1	827	0.82
2	207	1.64
3	92	2.46
4	52	3.28
5	33	4.11

Luminous flux luminaire 592 lm (EXTREME CUT OFF)

3000K

Non Dimmable

- 03.4570.B1C
Dali Version
- 03.4570.B1CDA
1-10V
- 03.4570.B1C1V

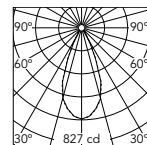

Beam Angle: 45°

h(m)	E(lx)	D(m)
1	827	0.82
2	207	1.64
3	92	2.46
4	52	3.28
5	33	4.11

Luminous flux luminaire 592 lm (EXTREME CUT OFF)

Non Dimmable

- 03.4595.GLC
Dali Version
- 03.4595.GLCDA
1-10V
- 03.4595.GLC1V

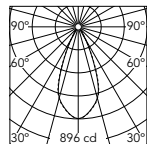

Beam Angle: 45°

h(m)	E(lx)	D(m)
1	896	0.82
2	224	1.64
3	100	2.47
4	56	3.29
5	36	4.11

Luminous flux luminaire 581 lm (EXTREME CUT OFF)

Non Dimmable

- 03.4570.GLC
Dali Version
- 03.4570.GLCDA
1-10V
- 03.4570.GLC1V

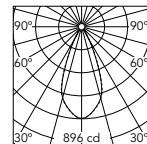

Beam Angle: 45°

h(m)	E(lx)	D(m)
1	896	0.82
2	224	1.64
3	100	2.47
4	56	3.29
5	36	4.11

Luminous flux luminaire 581 lm (EXTREME CUT OFF)

Non Dimmable

- 03.4595.BUC
Dali Version
- 03.4595.BUCDA
1-10V
- 03.4595.BUC1V

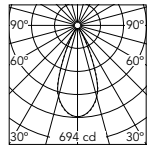

Beam Angle: 44°

h(m)	E(lx)	D(m)
1	694	0.80
2	174	1.61
3	77	2.41
4	43	3.21
5	28	4.02

Luminous flux luminaire 388 lm (EXTREME CUT OFF)

Non Dimmable

- 03.4570.BUC
Dali Version
- 03.4570.BUCDA
1-10V
- 03.4570.BUC1V

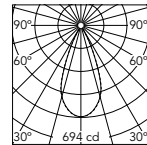

Beam Angle: 44°

h(m)	E(lx)	D(m)
1	694	0.80
2	174	1.61
3	77	2.41
4	43	3.21
5	28	4.02

Luminous flux luminaire 388 lm (EXTREME CUT OFF)

Non Dimmable

- 03.4595.74C
Dali Version
- 03.4595.74CDA
1-10V
- 03.4595.74C1V

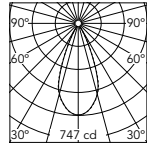

Beam Angle: 44°

h(m)	E(lx)	D(m)
1	747	0.80
2	187	1.60
3	83	2.40
4	47	3.19
5	30	3.99

Luminous flux luminaire 410 lm (EXTREME CUT OFF)

Non Dimmable

- 03.4570.74C
Dali Version
- 03.4570.74CDA
1-10V
- 03.4570.74C1V

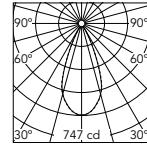

Beam Angle: 44°

h(m)	E(lx)	D(m)
1	747	0.80
2	187	1.60
3	83	2.40
4	47	3.19
5	30	3.99

Luminous flux luminaire 410 lm (EXTREME CUT OFF)

Non Dimmable

- 03.4595.CUC
Dali Version
- 03.4595.CUCDA
1-10V
- 03.4595.CUC1V

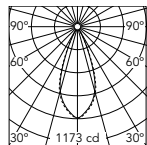

Beam Angle: 41°

h(m)	E(lx)	D(m)
1	1173	0.74
2	293	1.48
3	130	2.22
4	73	2.96
5	47	3.69

Luminous flux luminaire 585 lm (EXTREME CUT OFF)

Non Dimmable

- 03.4570.CUC
Dali Version
- 03.4570.CUCDA
1-10V
- 03.4570.CUC1V

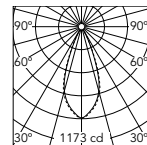

Beam Angle: 41°

h(m)	E(lx)	D(m)
1	1173	0.74
2	293	1.48
3	130	2.22
4	73	2.96
5	47	3.69

Luminous flux luminaire 585 lm (EXTREME CUT OFF)

Kap Ø105 Fixed - Optic Spot

Light Source: LED Array DC 650 mA - 23W - 2690 lm - 2700K/CRI 90 / 23W - 2870 lm - 3000K/CRI 90

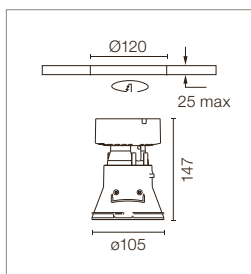

GWT 850°
 LED INCL
 0,48 Kg
 III
 IP 54
 h=150 min
 CE
 F

Incasso a LED. Trasformatore remoto non incluso. Lente diffusore incluso. Cornice di pre-installazione da ordinare separatamente.

Recessed luminaire with LED light source. Remote transformer not included. Diffusing lens included. Pre-installation frame. To be ordered separately.

Alimentazioni raccomandate / Recommended power supply*:

- Non Dimmable 60.9592
- Dimmable 1-10V 60.9439
- Dimmable Dali 2 RF30699
- Casambi 60.9207

* Vedi capitolo Drivers / Refer to the Drivers chapter

2700K
□ 05.7100.B1

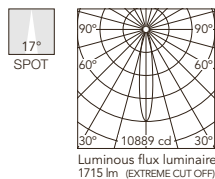

Beam Angle: 17°

h(m)	E(lx)	D(m)
1	10889	0.30
2	2722	0.59
3	1210	0.89
4	681	1.18
5	436	1.48

3000K
□ 05.7105.B1

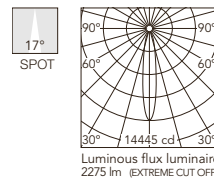

Beam Angle: 17°

h(m)	E(lx)	D(m)
1	14445	0.30
2	3611	0.59
3	1605	0.89
4	903	1.18
5	578	1.48

■ 05.7100.GL

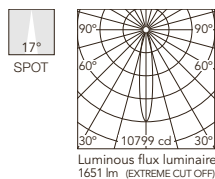

Beam Angle: 17°

h(m)	E(lx)	D(m)
1	10799	0.29
2	2700	0.59
3	1200	0.88
4	675	1.17
5	432	1.47

■ 05.7105.GL

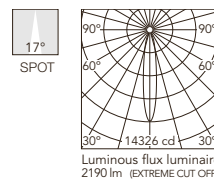

Beam Angle: 17°

h(m)	E(lx)	D(m)
1	14326	0.29
2	3581	0.59
3	1592	0.88
4	895	1.17
5	573	1.47

■ 05.7100.BU

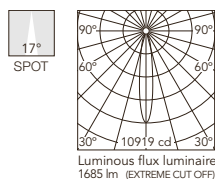

Beam Angle: 17°

h(m)	E(lx)	D(m)
1	10919	0.29
2	2730	0.59
3	1213	0.88
4	682	1.18
5	437	1.47

■ 05.7105.BU

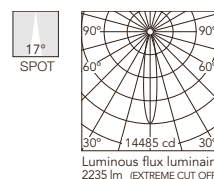

Beam Angle: 17°

h(m)	E(lx)	D(m)
1	14485	0.29
2	3621	0.59
3	1609	0.88
4	905	1.18
5	579	1.47

■ 05.7100.74

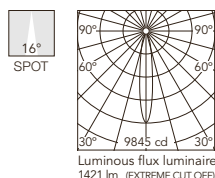

Beam Angle: 16°

h(m)	E(lx)	D(m)
1	9845	0.29
2	2461	0.57
3	1094	0.86
4	615	1.14
5	394	1.43

■ 05.7105.74

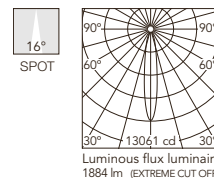

Beam Angle: 16°

h(m)	E(lx)	D(m)
1	13061	0.29
2	3265	0.57
3	1451	0.86
4	816	1.14
5	522	1.43

■ 05.7100.CU

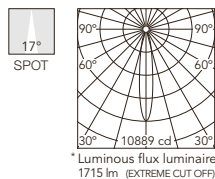

Beam Angle: 17°

h(m)	E(lx)	D(m)
1	10889	0.30
2	2722	0.59
3	1210	0.89
4	681	1.18
5	436	1.48

■ 05.7105.CU

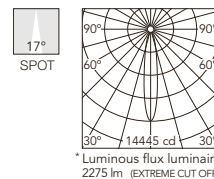

Beam Angle: 17°

h(m)	E(lx)	D(m)
1	14445	0.30
2	3611	0.59
3	1605	0.89
4	903	1.18
5	578	1.48

* Fotometrie preliminari. Consultare la nostra pagina web per informazioni aggiornate / Preliminary photometries. Visit our website for updated information.

Kap Ø105 Fixed - Optic Medium

Light Source: LED Array DC 650 mA - 23W - 2690 lm - 2700K/CRI 90 / 23W - 2870 lm - 3000K/CRI 90

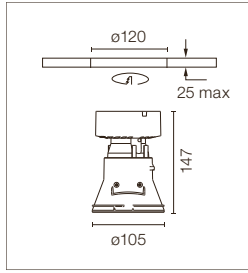
GWT
850°

LED INCL



0.48 Kg



III

IP
54

CE



F

Incasso a LED. Trasformatore remoto non incluso.
Lente diffusore incluso.
Cornice di pre-installazione da ordinare separatamente.

Recessed luminaire with LED light source. Remote transformer not included.
Diffusing lens included.
Pre-installation frame. To be ordered separately.

Alimentazioni raccomandate / Recommended power supply*:

Non Dimmable
Dimmable 1-10V
Dimmable Dali 2
Casambi

60.9592
60.9439
RF30699
60.9207

* Vedi capitolo Drivers / Refer to the Drivers chapter

2700K

□ 05.7101.B1

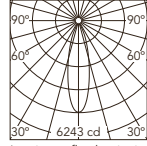

MEDIUM

Luminous flux luminaire
1675 lm (EXTREME CUT OFF)

Beam Angle: 27°

h(m)	E(lx)	D(m)
1	6243	0.48
2	1561	0.97
3	694	1.45
4	390	1.93
5	250	2.41

3000K

□ 05.7106.B1

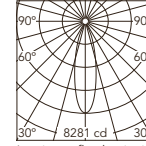

MEDIUM

Luminous flux luminaire
2222 lm (EXTREME CUT OFF)

Beam Angle: 27°

h(m)	E(lx)	D(m)
1	8281	0.48
2	2070	0.97
3	920	1.45
4	518	1.93
5	331	2.41

05.7101.GL

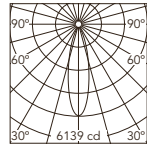

MEDIUM

Luminous flux luminaire
1528 lm (EXTREME CUT OFF)

Beam Angle: 26°

h(m)	E(lx)	D(m)
1	6139	0.46
2	1535	0.93
3	682	1.39
4	384	1.86
5	246	2.32

05.7106.GL

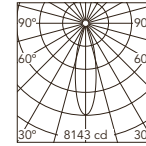

MEDIUM

Luminous flux luminaire
2026 lm (EXTREME CUT OFF)

Beam Angle: 26°

h(m)	E(lx)	D(m)
1	8143	0.46
2	2036	0.93
3	905	1.39
4	509	1.86
5	326	2.32

05.7101.BU

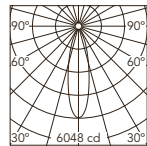

MEDIUM

Luminous flux luminaire
1596 lm (EXTREME CUT OFF)

Beam Angle: 27°

h(m)	E(lx)	D(m)
1	6048	0.47
2	1512	0.94
3	672	1.41
4	378	1.89
5	242	2.36

05.7106.BU

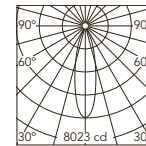

MEDIUM

Luminous flux luminaire
2118 lm (EXTREME CUT OFF)

Beam Angle: 27°

h(m)	E(lx)	D(m)
1	8023	0.47
2	2006	0.94
3	891	1.41
4	501	1.89
5	321	2.36

05.7101.74

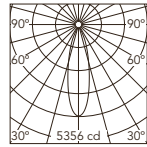

MEDIUM

Luminous flux luminaire
1376 lm (EXTREME CUT OFF)

Beam Angle: 27°

h(m)	E(lx)	D(m)
1	5356	0.48
2	1339	0.96
3	595	1.44
4	335	1.92
5	214	2.40

05.7106.74

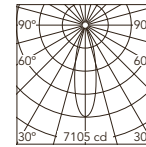

MEDIUM

Luminous flux luminaire
1825 lm (EXTREME CUT OFF)

Beam Angle: 27°

h(m)	E(lx)	D(m)
1	7105	0.48
2	1776	0.96
3	789	1.44
4	444	1.92
5	284	2.40

05.7101.CU

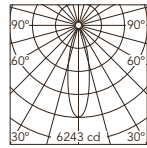

MEDIUM

Luminous flux luminaire
1675 lm (EXTREME CUT OFF)

Beam Angle: 27°

h(m)	E(lx)	D(m)
1	6243	0.48
2	1561	0.97
3	694	1.45
4	390	1.93
5	250	2.41

05.7106.CU

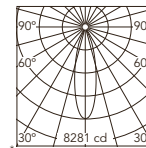

MEDIUM

Luminous flux luminaire
2222 lm (EXTREME CUT OFF)

Beam Angle: 27°

h(m)	E(lx)	D(m)
1	8281	0.48
2	2070	0.97
3	920	1.45
4	518	1.93
5	331	2.41

Kap Ø105 Fixed - Optic Flood

Light Source: LED Array DC 650 mA - 23W - 2690 lm - 2700K/CRI 90 / 23W - 2870 lm - 3000K/CRI 90

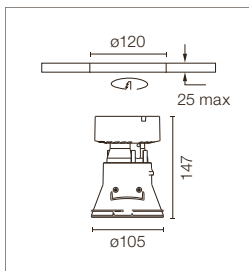

GWT 850°
 LED INCL
 0,48 Kg
 III
 IP 54
 h=150 mm
 CE
 F

Incasto a LED. Trasformatore remoto non incluso. Lente diffusore incluso. Cornice di pre-installazione da ordinare separatamente.

Recessed luminaire with LED light source. Remote transformer not included. Diffusing lens included. Pre-installation frame. To be ordered separately.

Alimentazioni raccomandate / Recommended power supply*:

- Non Dimmable 60.9592
- Dimmable 1-10V 60.9439
- Dimmable Dali 2 RF30699
- Casambi 60.9207

* Vedi capitolo Drivers / Refer to the Drivers chapter

2700K
□ 05.7102.B1

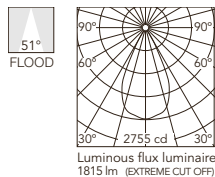

Beam Angle: 51°

h(m)	E(lx)	D(m)
1	2755	0.96
2	689	1.91
3	306	2.87
4	172	3.82
5	110	4.78

3000K
□ 05.7107.B1

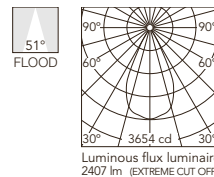

Beam Angle: 51°

h(m)	E(lx)	D(m)
1	3654	0.96
2	914	1.91
3	406	2.87
4	228	3.82
5	146	4.78

■ 05.7102.GL

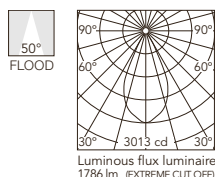

Beam Angle: 50°

h(m)	E(lx)	D(m)
1	3013	0.93
2	753	1.86
3	335	2.79
4	188	3.72
5	121	4.65

■ 05.7107.GL

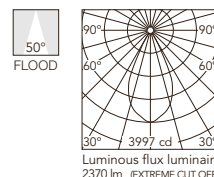

Beam Angle: 50°

h(m)	E(lx)	D(m)
1	3997	0.93
2	999	1.86
3	444	2.79
4	250	3.72
5	160	4.65

■ 05.7102.BU

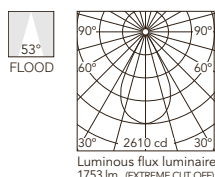

Beam Angle: 53°

h(m)	E(lx)	D(m)
1	2610	1.01
2	652	2.01
3	290	3.02
4	163	4.03
5	104	5.04

■ 05.7107.BU

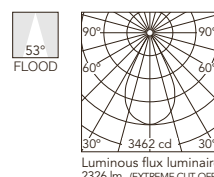

Beam Angle: 53°

h(m)	E(lx)	D(m)
1	3462	1.01
2	866	2.01
3	385	3.02
4	216	4.03
5	138	5.04

■ 05.7102.74

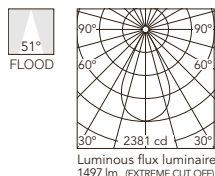

Beam Angle: 51°

h(m)	E(lx)	D(m)
1	2381	0.95
2	595	1.91
3	265	2.86
4	149	3.82
5	95	4.77

■ 05.7107.74

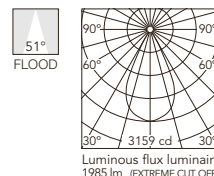

Beam Angle: 51°

h(m)	E(lx)	D(m)
1	3159	0.95
2	790	1.91
3	351	2.86
4	197	3.82
5	126	4.77

■ 05.7102.CU

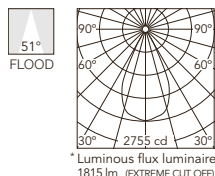

Beam Angle: 51°

h(m)	E(lx)	D(m)
1	2755	0.96
2	689	1.91
3	306	2.87
4	172	3.82
5	110	4.78

■ 05.7107.CU

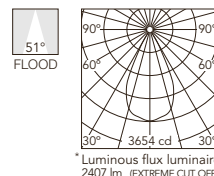

Beam Angle: 51°

h(m)	E(lx)	D(m)
1	3654	0.96
2	914	1.91
3	406	2.87
4	228	3.82
5	146	4.78

* Fotometrie preliminari. Consultare la nostra pagina web per informazioni aggiornate / Preliminary photometries. Visit our website for updated information.

Kap 105 Square

Light Source: LED Array 17W - 1800 lm - 2700K/CRI 90 / 17W - 2000 lm - 3000K/CRI 90

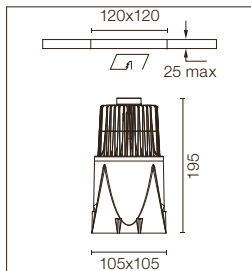

Incasto a LED. Trasformatore elettronico remoto 220/240V incluso.
Cornice di pre-installazione da ordinare separatamente.

Recessed luminaire with LED light source. Remote electronic transformer 220/240V included.
Pre-installation frame. To be ordered separately.

2700K

Non Dimmable

- 03.4583.B1
- Dali Version
- 03.4583.B1.DA
- 1-10V
- 03.4583.B1.1V

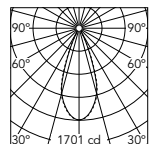

Beam Angle: 40°

h(m)	E(lx)	D(m)
1	1701	0.72
2	425	1.44
3	189	2.16
4	106	2.87
5	68	3.59

Luminous flux luminaire 946 lm (EXTREME CUT OFF)

3000K

Non Dimmable

- 03.4582.B1
- Dali Version
- 03.4582.B1.DA
- 1-10V
- 03.4582.B1.1V

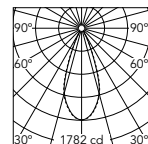

Beam Angle: 40°

h(m)	E(lx)	D(m)
1	1782	0.72
2	446	1.44
3	198	2.16
4	111	2.87
5	71	3.59

Luminous flux luminaire 992 lm (EXTREME CUT OFF)

Non Dimmable

- 03.4583.GL
- Dali Version
- 03.4583.GL.DA
- 1-10V
- 03.4583.GL.1V

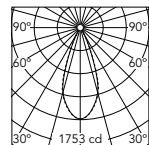

Beam Angle: 40°

h(m)	E(lx)	D(m)
1	1753	0.73
2	438	1.46
3	195	2.18
4	110	2.91
5	70	3.64

Luminous flux luminaire 921 lm (EXTREME CUT OFF)

Non Dimmable

- 03.4582.GL
- Dali Version
- 03.4582.GL.DA
- 1-10V
- 03.4582.GL.1V

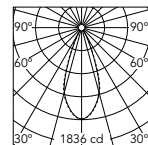

Beam Angle: 40°

h(m)	E(lx)	D(m)
1	1836	0.73
2	459	1.46
3	204	2.18
4	115	2.91
5	73	3.64

Luminous flux luminaire 965 lm (EXTREME CUT OFF)

Non Dimmable

- 03.4583.BU
- Dali Version
- 03.4583.BU.DA
- 1-10V
- 03.4583.BU.1V

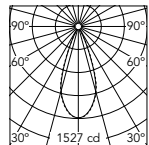

Beam Angle: 40°

h(m)	E(lx)	D(m)
1	1527	0.72
2	382	1.44
3	170	2.16
4	95	2.88
5	61	3.60

Luminous flux luminaire 708 lm (EXTREME CUT OFF)

Non Dimmable

- 03.4582.BU
- Dali Version
- 03.4582.BU.DA
- 1-10V
- 03.4582.BU.1V

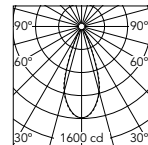

Beam Angle: 40°

h(m)	E(lx)	D(m)
1	1600	0.72
2	400	1.44
3	178	2.16
4	100	2.88
5	64	3.60

Luminous flux luminaire 742 lm (EXTREME CUT OFF)

Non Dimmable

- 03.4583.74
- Dali Version
- 03.4583.74.DA
- 1-10V
- 03.4583.74.1V

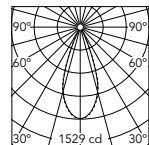

Beam Angle: 40°

h(m)	E(lx)	D(m)
1	1529	0.72
2	382	1.44
3	170	2.16
4	96	2.88
5	61	3.60

Luminous flux luminaire 703 lm (EXTREME CUT OFF)

Non Dimmable

- 03.4582.74
- Dali Version
- 03.4582.74.DA
- 1-10V
- 03.4582.74.1V

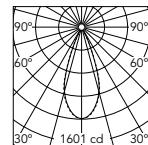

Beam Angle: 40°

h(m)	E(lx)	D(m)
1	1601	0.72
2	400	1.44
3	178	2.16
4	100	2.88
5	64	3.60

Luminous flux luminaire 736 lm (EXTREME CUT OFF)

Non Dimmable

- 03.4583.CU
- Dali Version
- 03.4583.CU.DA
- 1-10V
- 03.4583.CU.1V

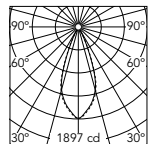

Beam Angle: 40°

h(m)	E(lx)	D(m)
1	1897	0.72
2	474	1.44
3	211	2.16
4	119	2.88
5	76	3.60

Luminous flux luminaire 882 lm (EXTREME CUT OFF)

Non Dimmable

- 03.4582.CU
- Dali Version
- 03.4582.CU.DA
- 1-10V
- 03.4582.CU.1V

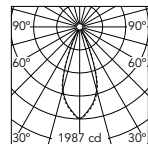

Beam Angle: 40°

h(m)	E(lx)	D(m)
1	1987	0.72
2	497	1.44
3	221	2.16
4	124	2.88
5	79	3.60

Luminous flux luminaire 924 lm (EXTREME CUT OFF)

Kap 105 Square

Light Source: LED QR-CBC 51 GX5.3

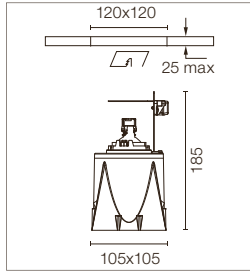

Incasso per lampada di 12V.
Trasformatore remoto non incluso.
Accessori per lenti non disponibili.
Cornice di pre-installazione da
ordinare separatamente.

Recessed 12V lamp luminaire.
Remote transformer not included.
Not suitable for lens accessories.
Pre-installation frame. To be ordered
separately.

- 03.4572.B1
- 03.4572.GL
- 03.4572.BU
- 03.4572.74
- 03.4572.CU

Kap Ø105 Fixed

Light Source: LED QR-CBC 51 GX5.3

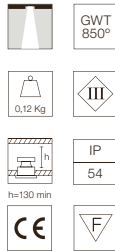
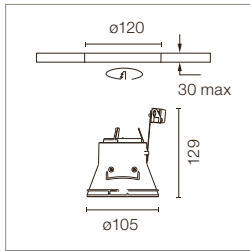

Incasso per lampada di 12V.
Trasformatore remoto non incluso.
Accessori per lenti non disponibili.
Cornice di pre-installazione da
ordinare separatamente.

Recessed 12V lamp luminaire.
Remote transformer not included.
Not suitable for lens accessories.
Pre-installation frame. To be ordered
separately.

- 05.7130.B1
- 05.7130.GL
- 05.7130.BU
- 05.7130.74
- 05.7130.CU

Kap Ø105 Fixed

Light Source: LED PAR 16 GZ10

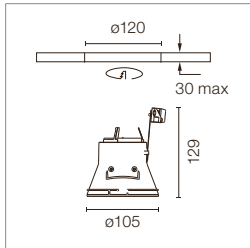

Incasso con alimentazione in
tensione di rete.
Accessori per lenti non disponibili.
Cornice di pre-installazione da
ordinare separatamente.

Recessed luminaire with main
voltage source.
Not suitable for lens accessories.
Pre-installation frame. To be ordered
separately.

- 05.7131.B1
- 05.7131.GL
- 05.7131.BU
- 05.7131.74
- 05.7131.CU

Kap Ø105 Adjustable - Optic Spot

Light Source: LED Array DC 650 mA - 23W - 2690 lm - 2700K/CRI 90 / 23W - 2870 lm - 3000K/CRI 90

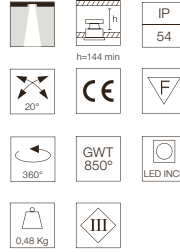
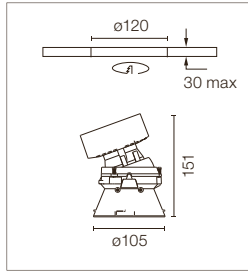

Incasto a LED. Trasformatore remoto non incluso.
Lente diffusore incluso.
Cornice di pre-installazione da ordinare separatamente.

Recessed luminaire with LED light source. Remote transformer not included.
Diffusing lens included.
Pre-installation frame. To be ordered separately.

Alimentazioni raccomandate / Recommended power supply*:

Non Dimmable
Dimmable 1-10V
Dimmable Dali 2
Casambi

60.9592
60.9439
RF30699
60.9207

* Vedi capitolo Drivers / Refer to the Drivers chapter

2700K
05.7110.B1

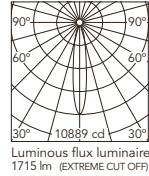

Beam Angle: 17°		
h(m)	E(lx)	D(m)
1	10889	0.30
2	2722	0.59
3	1210	0.89
4	681	1.18
5	436	1.48

3000K
05.7115.B1

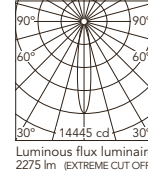

Beam Angle: 17°		
h(m)	E(lx)	D(m)
1	14445	0.30
2	3611	0.59
3	1605	0.89
4	903	1.18
5	578	1.48

05.7110.GL

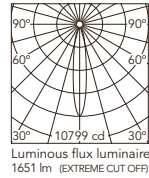

Beam Angle: 17°		
h(m)	E(lx)	D(m)
1	10799	0.29
2	2700	0.59
3	1200	0.88
4	675	1.17
5	432	1.47

05.7115.GL

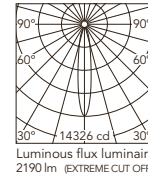

Beam Angle: 17°		
h(m)	E(lx)	D(m)
1	14326	0.29
2	3581	0.59
3	1592	0.88
4	895	1.17
5	573	1.47

05.7110.BU

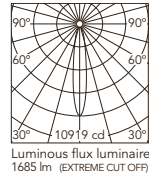

Beam Angle: 17°		
h(m)	E(lx)	D(m)
1	10919	0.29
2	2730	0.59
3	1213	0.88
4	682	1.18
5	437	1.47

05.7115.BU

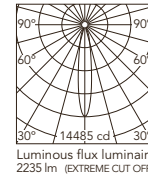

Beam Angle: 17°		
h(m)	E(lx)	D(m)
1	14485	0.29
2	3621	0.59
3	1609	0.88
4	905	1.18
5	579	1.47

05.7110.74

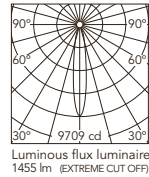

Beam Angle: 16°		
h(m)	E(lx)	D(m)
1	9709	0.29
2	2427	0.57
3	1079	0.86
4	607	1.15
5	388	1.43

05.7115.74

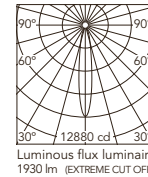

Beam Angle: 16°		
h(m)	E(lx)	D(m)
1	12880	0.29
2	3220	0.57
3	1431	0.86
4	805	1.15
5	515	1.43

05.7110.CU

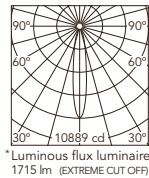

Beam Angle: 17°		
h(m)	E(lx)	D(m)
1	10889	0.30
2	2722	0.59
3	1210	0.89
4	681	1.18
5	436	1.48

05.7115.CU

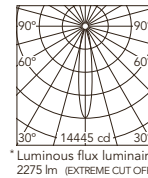

Beam Angle: 17°		
h(m)	E(lx)	D(m)
1	14445	0.30
2	3611	0.59
3	1605	0.89
4	903	1.18
5	578	1.48

KAP

Kap Ø105 Adjustable - Optic Medium

Light Source: LED Array DC 650 mA - 23W - 2690 lm - 2700K/CRI 90 / 23W - 2870 lm - 3000K/CRI 90

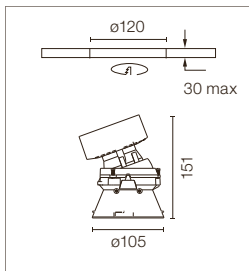

		IP 54
		CE F
		GWT 850°
		LED INCL III

Incasso a LED. Trasformatore remoto non incluso. Lente diffusore incluso. Cornice di pre-installazione da ordinare separatamente.

Recessed luminaire with LED light source. Remote transformer not included. Diffusing lens included. Pre-installation frame. To be ordered separately.

Alimentazioni raccomandate / Recommended power supply*:

- Non Dimmable 60.9592
- Dimmable 1-10V 60.9439
- Dimmable Dali 2 RF30699
- Casambi 60.9207

* Vedi capitolo Drivers / Refer to the Drivers chapter

2700K
05.7111.B1

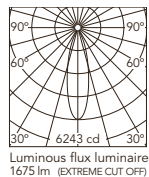

Beam Angle: 27°

h(m)	E(lx)	D(m)
1	6243	0.48
2	1561	0.97
3	694	1.45
4	390	1.93
5	250	2.41

3000K
05.7116.B1

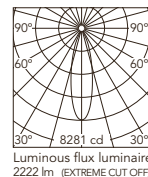

Beam Angle: 27°

h(m)	E(lx)	D(m)
1	8281	0.48
2	2070	0.97
3	920	1.45
4	518	1.93
5	331	2.41

05.7111.GL

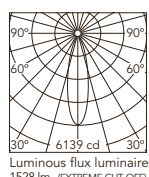

Beam Angle: 26°

h(m)	E(lx)	D(m)
1	6139	0.46
2	1535	0.93
3	682	1.39
4	384	1.86
5	246	2.32

05.7116.GL

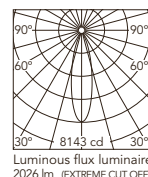

Beam Angle: 26°

h(m)	E(lx)	D(m)
1	8143	0.46
2	2036	0.93
3	905	1.39
4	509	1.86
5	326	2.32

05.7111.BU

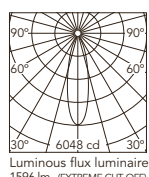

Beam Angle: 27°

h(m)	E(lx)	D(m)
1	6048	0.47
2	1512	0.94
3	672	1.41
4	378	1.89
5	242	2.36

05.7116.BU

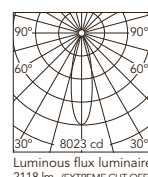

Beam Angle: 27°

h(m)	E(lx)	D(m)
1	8023	0.47
2	2006	0.94
3	891	1.41
4	501	1.89
5	321	2.36

05.7111.74

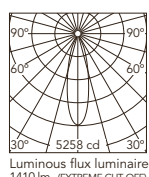

Beam Angle: 27°

h(m)	E(lx)	D(m)
1	5258	0.48
2	1314	0.96
3	584	1.44
4	329	1.92
5	210	2.40

05.7116.74

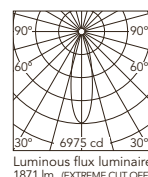

Beam Angle: 27°

h(m)	E(lx)	D(m)
1	6975	0.48
2	1744	0.96
3	775	1.44
4	436	1.92
5	279	2.40

05.7111.CU

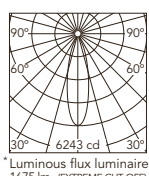

Beam Angle: 27°

h(m)	E(lx)	D(m)
1	6243	0.48
2	1561	0.97
3	694	1.45
4	390	1.93
5	250	2.41

05.7116.CU

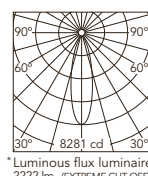

Beam Angle: 27°

h(m)	E(lx)	D(m)
1	8281	0.48
2	2070	0.97
3	920	1.45
4	518	1.93
5	331	2.41

* Fotometrie preliminari. Consultare la nostra pagina web per informazioni aggiornate / Preliminary photometries. Visit our website for updated information.

Kap Ø105 Adjustable - Optic Flood

Light Source: LED Array DC 650 mA - 23W - 2690 lm - 2700K/CRI 90 / 23W - 2870 lm - 3000K/CRI 90

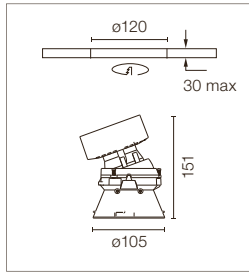

IP 54
 h=144 min
 20°
 CE
 F
 360°
 GWT 850°
 LED INCL
 0,48 Kg
 III

Incasso a LED. Trasformatore remoto non incluso. Lente diffusore incluso. Cornice di pre-installazione da ordinare separatamente.

Recessed luminaire with LED light source. Remote transformer not included. Diffusing lens included. Pre-installation frame. To be ordered separately.

Alimentazioni raccomandate / Recommended power supply*:
 Non Dimmable 60.9592
 Dimmable 1-10V 60.9439
 Dimmable Dali 2 RF30699
 Casambi 60.9207

* Vedi capitolo Drivers / Refer to the Drivers chapter

2700K
 05.7112.B1

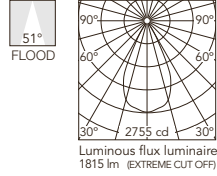

3000K
 05.7117.B1

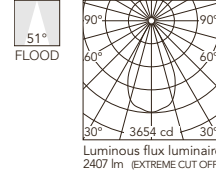

05.7112.GL

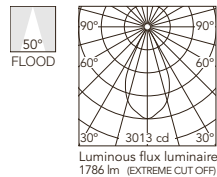

05.7117.GL

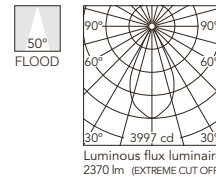

05.7112.BU

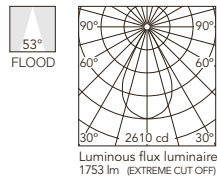

05.7117.BU

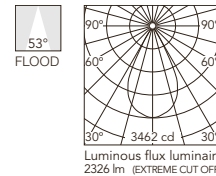

05.7112.74

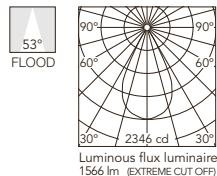

05.7117.74

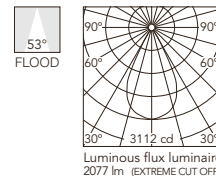

05.7112.CU

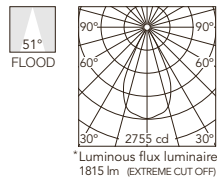

05.7117.CU

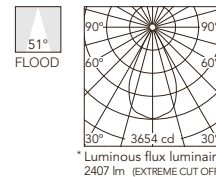

* Fotometrie preliminari. Consultare la nostra pagina web per informazioni aggiornate / Preliminary photometries. Visit our website for updated information.

Kap Ø105 Adjustable

Light Source: LED QR-CBC 51 GX5.3

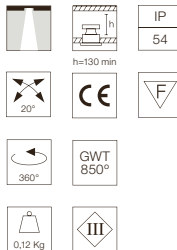
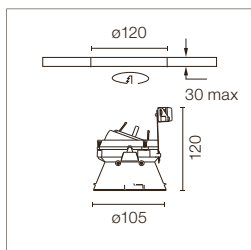

Incasso per lampada di 12V.
Trasformatore remoto non incluso.
Accessori per lenti non disponibili.
Cornice di pre-installazione da
ordinare separatamente.

Recessed 12V lamp luminaire.
Remote transformer not included.
Not suitable for lens accessories.
Pre-installation frame. To be ordered
separately.

05.7135.B1
05.7135.GL
05.7135.BU
05.7135.74
05.7135.CU

Kap Ø105 Adjustable

Light Source: LED PAR 16 GZ10

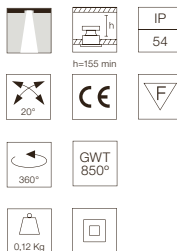
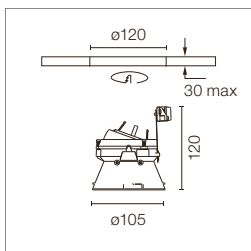

Incasso con alimentazione in
tensione di rete.
Accessori per lenti non disponibili.
Cornice di pre-installazione da
ordinare separatamente.

Recessed luminaire with main
voltage source.
Not suitable for lens accessories.
Pre-installation frame. To be ordered
separately.

05.7136.B1
05.7136.GL
05.7136.BU
05.7136.74
05.7136.CU

Kap Ø105 Wall-Washer

Light Source: LED Array DC 650 mA - 23W - 2690 lm - 2700K/CRI 90 / 23W - 2870 lm - 3000K/CRI 90

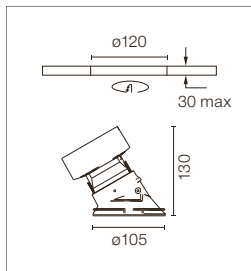

GWT 850°
 LED INCL
 0.48 Kg
 III
 IP 54
 h=134 min
 CE
 F

Incasso a LED. Trasformatore elettronico remoto 220/240V non incluso.
 Cornice di pre-installazione da ordinare separatamente.

Recessed luminaire with LED light source. Remote electronic transformer 220/240V not included.
 Pre-installation frame. To be ordered separately.

Alimentazioni raccomandate / Recommended power supply*:

- Non Dimmable 60.9592
- Dimmable 1-10V 60.9439
- Dimmable Dali 2 RF30699
- Casambi 60.9207

* Vedi capitolo Drivers / Refer to the Drivers chapter

2700K
 05.7120.B1

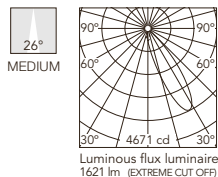

3000K
 05.7121.B1

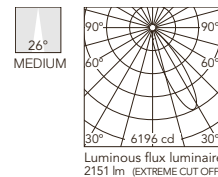

05.7120.GL

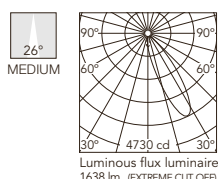

05.7121.GL

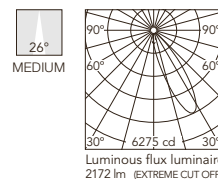

05.7120.BU

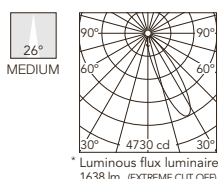

05.7121.BU

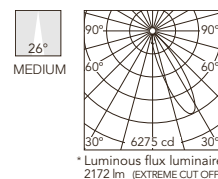

05.7120.74

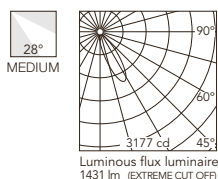

05.7121.74

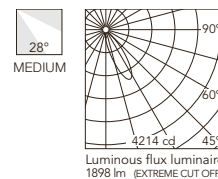

05.7120.CU

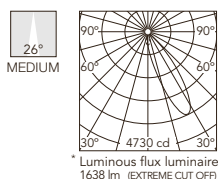

05.7121.CU

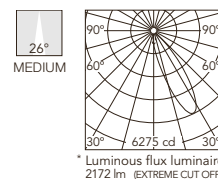

* Fotometrie preliminari. Consultare la nostra pagina web per informazioni aggiornate / Preliminary photometries. Visit our website for updated information.

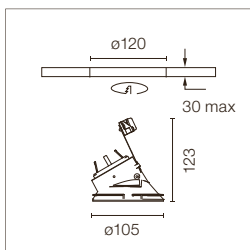
Kap Ø105 Wall-Washer**Light Source:** LED QR-CBC 51 GX5.3GWT
850°

0,12 Kg

IP
54

h=130 min



Incasso per lampada LED di 12V.
Trasformatore remoto non incluso.
Accessori per lenti non disponibili.
Cornice di pre-installazione da
ordinare separatamente.

Recessed 12V LED lamp luminaire.
Remote transformer not included.
Not suitable for lens accessories.
Pre-installation frame. To be ordered
separately.

05.7140.B1
05.7140.GL
05.7140.BU
05.7140.74
05.7140.CU

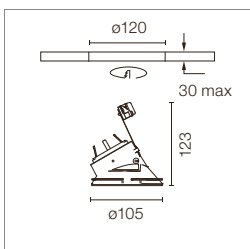
Kap Ø105 Wall-Washer**Light Source:** LED PAR 16 GZ10GWT
850°

0,12 Kg

IP
54

h=155 min



Incasso con alimentazione in
tensione di rete.
Accessori per lenti non disponibili.
Cornice di pre-installazione da
ordinare separatamente.

Recessed luminaire with main
voltage source.
Not suitable for lens accessories.
Pre-installation frame. To be ordered
separately.

05.7141.B1
05.7141.GL
05.7141.BU
05.7141.74
05.7141.CU

Kap Ø105 Deep - Optic Spot

Light Source: LED Array DC 650 mA - 23W - 2690 lm - 2700K/CRI 90 / 23W - 2870 lm - 3000K/CRI 90

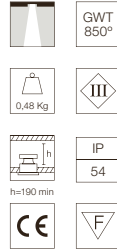
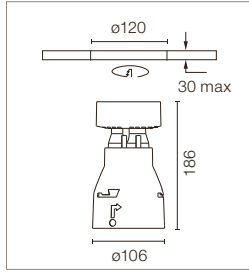

Incasso a LED. Trasformatore elettronico remoto 220/240V non incluso.
Cornice di pre-installazione da ordinare separatamente.

Recessed luminaire with LED light source. Remote electronic transformer 220/240V not included.
Pre-installation frame. To be ordered separately.

Alimentazioni raccomandate / Recommended power supply*:
Non Dimmable 60.9592
Dimmable 1-10V 60.9439
Dimmable Dali 2 RF30699
Casambi 60.9207

* Vedi capitolo Drivers / Refer to the Drivers chapter

2700K
□ 05.7150.B1

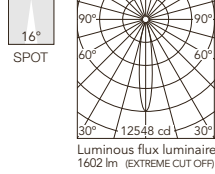

Beam Angle: 16°

h(m)	E(lx)	D(m)
1	12548	0.29
2	3137	0.57
3	1394	0.86
4	784	1.14
5	502	1.43

3000K
□ 05.7155.B1

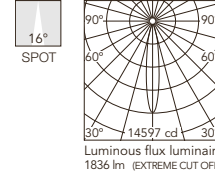

Beam Angle: 16°

h(m)	E(lx)	D(m)
1	14597	0.28
2	3649	0.56
3	1622	0.84
4	912	1.13
5	584	1.41

■ 05.7150.GL

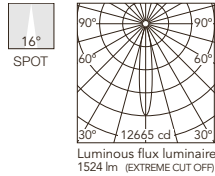

Beam Angle: 16°

h(m)	E(lx)	D(m)
1	12665	0.28
2	3166	0.57
3	1407	0.85
4	792	1.13
5	507	1.42

■ 05.7155.GL

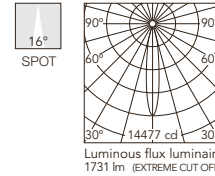

Beam Angle: 16°

h(m)	E(lx)	D(m)
1	14477	0.28
2	3619	0.57
3	1609	0.85
4	905	1.13
5	579	1.41

■ 05.7150.BU

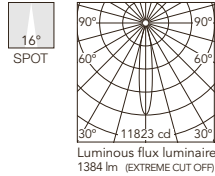

Beam Angle: 16°

h(m)	E(lx)	D(m)
1	11823	0.29
2	2956	0.58
3	1314	0.87
4	739	1.16
5	473	1.45

■ 05.7155.BU

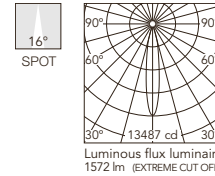

Beam Angle: 16°

h(m)	E(lx)	D(m)
1	13487	0.29
2	3372	0.58
3	1499	0.87
4	843	1.16
5	539	1.44

■ 05.7150.74

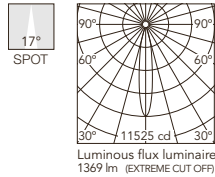

Beam Angle: 17°

h(m)	E(lx)	D(m)
1	11525	0.29
2	2881	0.59
3	1281	0.88
4	720	1.18
5	461	1.47

■ 05.7155.74

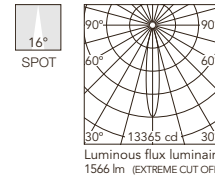

Beam Angle: 16°

h(m)	E(lx)	D(m)
1	13365	0.29
2	3341	0.58
3	1485	0.87
4	835	1.16
5	535	1.45

■ 05.7150.CU

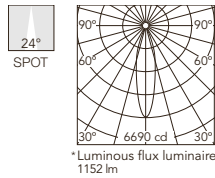

Beam Angle: 24°

h(m)	E(lx)	D(m)
1	6690	0.43
2	1673	0.86
3	743	1.29
4	418	1.72
5	268	2.15

■ 05.7155.CU

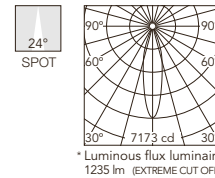

Beam Angle: 24°

h(m)	E(lx)	D(m)
1	7173	0.43
2	1793	0.86
3	797	1.29
4	448	1.72
5	287	2.15

* Fotometrie preliminari. Consultare la nostra pagina web per informazioni aggiornate / Preliminary photometries. Visit our website for updated information.

KAP

Kap Ø105 Deep - Optic Medium

Light Source: LED Array DC 650 mA - 23W - 2690 lm - 2700K/CRI 90 / 23W - 2870 lm - 3000K/CRI 90

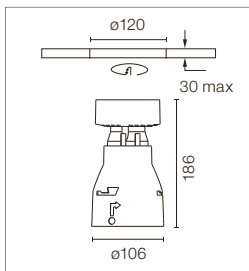

GWT 850°
 LED INCL
 0,48 Kg
 III
 IP 54
 h=190 min
 CE
 F

Incasso a LED. Trasformatore elettronico remoto 220/240V non incluso.
Cornice di pre-installazione da ordinare separatamente.

Recessed luminaire with LED light source. Remote electronic transformer 220/240V not included.
Pre-installation frame. To be ordered separately.

Alimentazioni raccomandate / Recommended power supply*:

- Non Dimmable 60.9592
- Dimmable 1-10V 60.9439
- Dimmable Dali 2 RF30699
- Casambi 60.9207

* Vedi capitolo Drivers / Refer to the Drivers chapter

2700K
□ 05.7151.B1

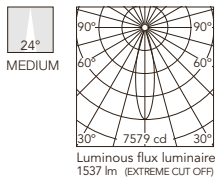

Beam Angle: 24°

h(m)	E(lx)	D(m)
1	7579	0.42
2	1895	0.84
3	842	1.26
4	474	1.69
5	303	2.11

3000K
□ 05.7156.B1

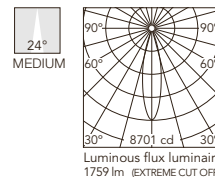

Beam Angle: 24°

h(m)	E(lx)	D(m)
1	8701	0.42
2	2175	0.84
3	967	1.26
4	544	1.68
5	348	2.10

■ 05.7151.GL

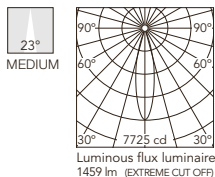

Beam Angle: 23°

h(m)	E(lx)	D(m)
1	7725	0.42
2	1931	0.83
3	858	1.25
4	483	1.66
5	309	2.08

■ 05.7156.GL

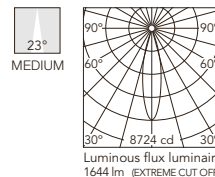

Beam Angle: 23°

h(m)	E(lx)	D(m)
1	8724	0.42
2	2181	0.83
3	969	1.25
4	545	1.66
5	349	2.08

■ 05.7151.BU

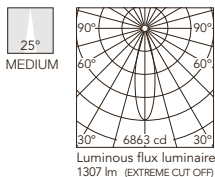

Beam Angle: 25°

h(m)	E(lx)	D(m)
1	6863	0.45
2	1716	0.90
3	763	1.35
4	429	1.79
5	275	2.24

■ 05.7156.BU

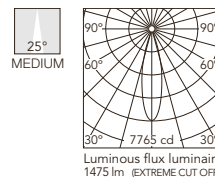

Beam Angle: 25°

h(m)	E(lx)	D(m)
1	7765	0.45
2	1941	0.89
3	863	1.34
4	485	1.79
5	311	2.23

■ 05.7151.74

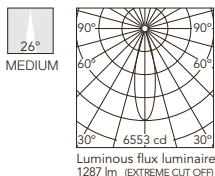

Beam Angle: 26°

h(m)	E(lx)	D(m)
1	6553	0.46
2	1638	0.93
3	728	1.39
4	410	1.85
5	262	2.31

■ 05.7156.74

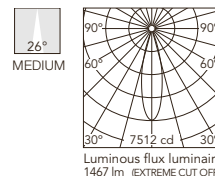

Beam Angle: 26°

h(m)	E(lx)	D(m)
1	7512	0.46
2	1878	0.92
3	835	1.38
4	469	1.85
5	300	2.31

■ 05.7151.CU

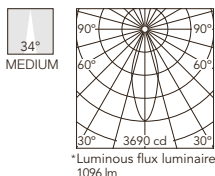

Beam Angle: 34°

h(m)	E(lx)	D(m)
1	3690	0.61
2	923	1.23
3	410	1.84
4	231	2.45
5	148	3.06

■ 05.7156.CU

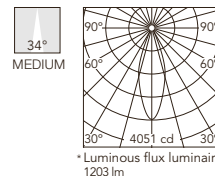

Beam Angle: 34°

h(m)	E(lx)	D(m)
1	4051	0.61
2	1013	1.23
3	450	1.84
4	253	2.45
5	162	3.06

* Fotometrie preliminari. Consultare la nostra pagina web per informazioni aggiornate / Preliminary photometries. Visit our website for updated information.

Kap Ø105 Deep - Optic Flood

Light Source: LED Array DC 650 mA - 23W - 2690 lm - 2700K/CRI 90 / 23W - 2870 lm - 3000K/CRI 90

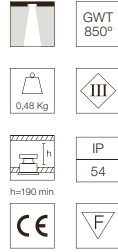
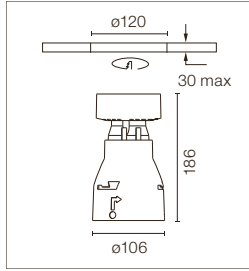

Incasso a LED. Trasformatore elettronico remoto 220/240V non incluso.
Cornice di pre-installazione da ordinare separatamente.

Recessed luminaire with LED light source. Remote electronic transformer 220/240V not included.
Pre-installation frame. To be ordered separately.

Alimentazioni raccomandate / Recommended power supply*:
Non Dimmable 60.9592
Dimmable 1-10V 60.9439
Dimmable Dali 2 RF30699
Casambi 60.9207

* Vedi capitolo Drivers / Refer to the Drivers chapter

2700K
□ 05.7152.B1

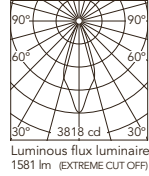

Beam Angle: 37°

h(m)	E(lx)	D(m)
1	3818	0.68
2	954	1.36
3	424	2.03
4	239	2.71
5	153	3.39

Luminous flux luminaire 1581 lm (EXTREME CUT OFF)

3000K
□ 05.7157.B1

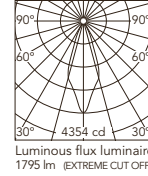

Beam Angle: 37°

h(m)	E(lx)	D(m)
1	4354	0.68
2	1089	1.35
3	484	2.03
4	272	2.71
5	174	3.38

Luminous flux luminaire 1795 lm (EXTREME CUT OFF)

■ 05.7152.GL

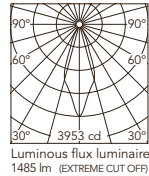

Beam Angle: 37°

h(m)	E(lx)	D(m)
1	3953	0.67
2	988	1.34
3	439	2.01
4	247	2.68
5	158	3.35

Luminous flux luminaire 1485 lm (EXTREME CUT OFF)

■ 05.7157.GL

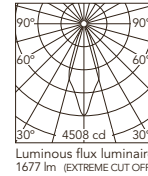

Beam Angle: 37°

h(m)	E(lx)	D(m)
1	4508	0.67
2	1127	1.33
3	501	2.00
4	282	2.67
5	180	3.34

Luminous flux luminaire 1677 lm (EXTREME CUT OFF)

■ 05.7152.BU

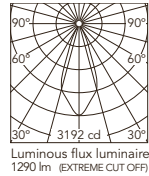

Beam Angle: 39°

h(m)	E(lx)	D(m)
1	3192	0.71
2	798	1.42
3	355	2.13
4	199	2.84
5	128	3.55

Luminous flux luminaire 1290 lm (EXTREME CUT OFF)

■ 05.7157.BU

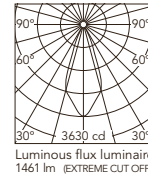

Beam Angle: 39°

h(m)	E(lx)	D(m)
1	3630	0.71
2	907	1.42
3	403	2.13
4	227	2.84
5	145	3.55

Luminous flux luminaire 1461 lm (EXTREME CUT OFF)

■ 05.7152.74

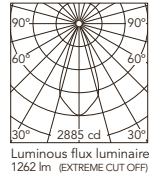

Beam Angle: 40°

h(m)	E(lx)	D(m)
1	2885	0.73
2	721	1.46
3	321	2.19
4	180	2.92
5	115	3.65

Luminous flux luminaire 1262 lm (EXTREME CUT OFF)

■ 05.7157.74

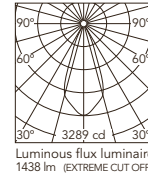

Beam Angle: 40°

h(m)	E(lx)	D(m)
1	3289	0.73
2	822	1.46
3	365	2.19
4	206	2.92
5	132	3.65

Luminous flux luminaire 1438 lm (EXTREME CUT OFF)

■ 05.7152.CU

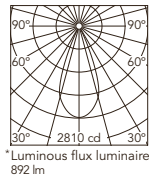

Beam Angle: 42°

h(m)	E(lx)	D(m)
1	2810	0.77
2	702	1.53
3	312	2.30
4	176	3.07
5	112	3.83

Luminous flux luminaire 892 lm

■ 05.7157.CU

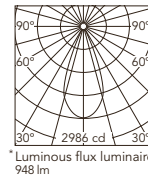

Beam Angle: 42°

h(m)	E(lx)	D(m)
1	2986	0.77
2	747	1.53
3	332	2.30
4	187	3.07
5	119	3.83

Luminous flux luminaire 948 lm

* Fotometrie preliminari. Consultare la nostra pagina web per informazioni aggiornate / Preliminary photometries. Visit our website for updated information.

KAP

Kap Ø145

Light Source: Phosphor LED 17W - 1400 lm - 2700K/CRI 98 / 17W - 1400 lm - 3000K/CRI 98

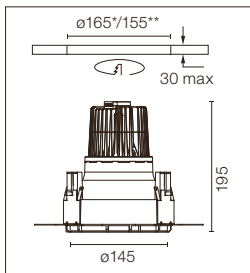

* No Trim | ** Trim

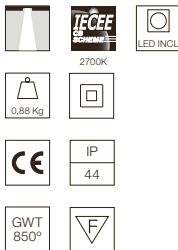

Incasso a LED. Trasformatore elettronico remoto 220/240V incluso.
Cornice di pre-installazione da ordinare separatamente.

Recessed luminaire with LED light source. Remote electronic transformer 220/240V included.
Pre-installation frame. To be ordered separately.

2700K

Non Dimmable

- 03.4496.B1B
Dali Version
- 03.4496.B1BDA
1-10V
- 03.4496.B1B1V

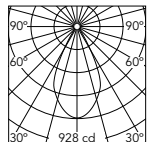

Beam Angle: 53°

h(m)	E(lx)	D(m)
1	928	1.00
2	232	2.00
3	103	3.00
4	58	4.01
5	37	5.01

Luminous flux luminaire
775 lm (EXTREME CUT OFF)

3000K

Non Dimmable

- 03.4420.B1C
Dali Version
- 03.4420.B1CDA
1-10V
- 03.4420.B1C1V

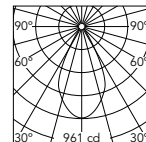

Beam Angle: 53°

h(m)	E(lx)	D(m)
1	961	1.00
2	240	2.00
3	107	3.00
4	60	4.01
5	38	5.01

Luminous flux luminaire
803 lm (EXTREME CUT OFF)

Non Dimmable

- 03.4496.GLB
Dali Version
- 03.4496.GLBDA
1-10V
- 03.4496.GLB1V

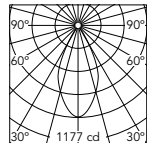

Beam Angle: 49°

h(m)	E(lx)	D(m)
1	1177	0.92
2	294	1.84
3	131	2.76
4	74	3.68
5	47	4.60

Luminous flux luminaire
760 lm (EXTREME CUT OFF)

Non Dimmable

- 03.4420.GLC
Dali Version
- 03.4420.GLCDA
1-10V
- 03.4420.GLC1V

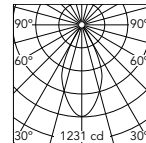

Beam Angle: 49°

h(m)	E(lx)	D(m)
1	1231	0.92
2	308	1.84
3	137	2.76
4	77	3.68
5	49	4.60

Luminous flux luminaire
796 lm (EXTREME CUT OFF)

Non Dimmable

- 03.4496.BUB
Dali Version
- 03.4496.BUBDA
1-10V
- 03.4496.BUB1V

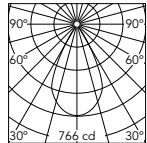

Beam Angle: 54°

h(m)	E(lx)	D(m)
1	766	1.02
2	191	2.04
3	85	3.06
4	48	4.08
5	31	5.11

Luminous flux luminaire
550 lm (EXTREME CUT OFF)

Non Dimmable

- 03.4420.BUC
Dali Version
- 03.4420.BUCDA
1-10V
- 03.4420.BUC1V

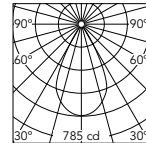

Beam Angle: 54°

h(m)	E(lx)	D(m)
1	785	1.02
2	196	2.04
3	87	3.06
4	49	4.08
5	31	5.11

Luminous flux luminaire
563 lm (EXTREME CUT OFF)

Non Dimmable

- 03.4496.74B
Dali Version
- 03.4496.74BDA
1-10V
- 03.4496.74B1V

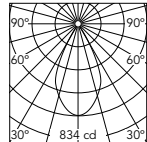

Beam Angle: 52°

h(m)	E(lx)	D(m)
1	834	0.97
2	208	1.95
3	93	2.92
4	52	3.90
5	33	4.87

Luminous flux luminaire
541 lm (EXTREME CUT OFF)

Non Dimmable

- 03.4420.74C
Dali Version
- 03.4420.74CDA
1-10V
- 03.4420.74C1V

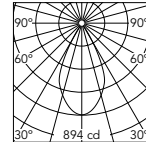

Beam Angle: 52°

h(m)	E(lx)	D(m)
1	894	0.97
2	224	1.95
3	99	2.92
4	56	3.90
5	36	4.87

Luminous flux luminaire
580 lm (EXTREME CUT OFF)

Non Dimmable

- 03.4496.CUB
Dali Version
- 03.4496.CUBDA
1-10V
- 03.4496.CUB1V

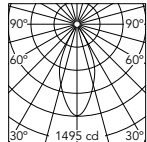

Beam Angle: 45°

h(m)	E(lx)	D(m)
1	1495	0.83
2	374	1.66
3	166	2.49
4	93	3.33
5	60	4.16

Luminous flux luminaire
796 lm (EXTREME CUT OFF)

Non Dimmable

- 03.4420.CUC
Dali Version
- 03.4420.CUCDA
1-10V
- 03.4420.CUC1V

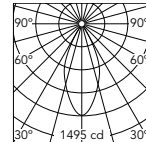

Beam Angle: 45°

h(m)	E(lx)	D(m)
1	1495	0.83
2	374	1.66
3	166	2.49
4	93	3.33
5	60	4.16

Luminous flux luminaire
796 lm (EXTREME CUT OFF)

KAP

Kap Ø145

Light Source: LED Array 17W - 1800 lm - 2700K/CRI 90 / 17W - 2000 lm - 3000K/CRI 90

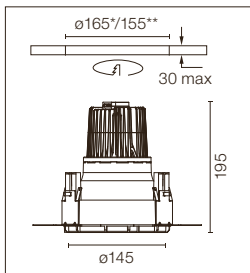

* No Trim | ** Trim

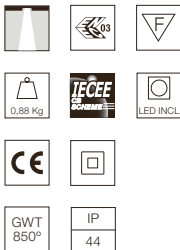

Incasso a LED. Trasformatore elettronico remoto 220/240V incluso.
Cornice di pre-installazione da ordinare separatamente.

Recessed luminaire with LED light source. Remote electronic transformer 220/240V included.
Pre-installation frame. To be ordered separately.

2700K

Non Dimmable

- 03.4585.B1
- Dali Version
- 03.4585.B1.DA
- 1-10V
- 03.4585.B1.1V

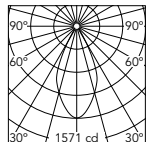

Beam Angle: 49°

h(m)	E(lx)	D(m)
1	1571	0.91
2	393	1.82
3	175	2.73
4	98	3.64
5	63	4.55

Luminous flux luminaire 1110 lm (EXTREME CUT OFF)

3000K

Non Dimmable

- 03.4584.B1
- Dali Version
- 03.4584.B1.DA
- 1-10V
- 03.4584.B1.1V

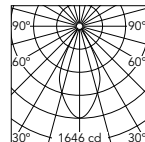

Beam Angle: 49°

h(m)	E(lx)	D(m)
1	1646	0.91
2	411	1.82
3	183	2.73
4	103	3.64
5	66	4.55

Luminous flux luminaire 1163 lm (EXTREME CUT OFF)

Non Dimmable

- 03.4585.GL
- Dali Version
- 03.4585.GL.DA
- 1-10V
- 03.4585.GL.1V

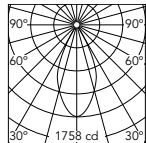

Beam Angle: 48°

h(m)	E(lx)	D(m)
1	1758	0.88
2	439	1.77
3	195	2.65
4	110	3.54
5	70	4.42

Luminous flux luminaire 1059 lm (EXTREME CUT OFF)

Non Dimmable

- 03.4584.GL
- Dali Version
- 03.4584.GL.DA
- 1-10V
- 03.4584.GL.1V

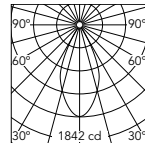

Beam Angle: 48°

h(m)	E(lx)	D(m)
1	1842	0.88
2	460	1.77
3	205	2.65
4	115	3.54
5	74	4.42

Luminous flux luminaire 1109 lm (EXTREME CUT OFF)

Non Dimmable

- 03.4585.BU
- Dali Version
- 03.4585.BU.DA
- 1-10V
- 03.4585.BU.1V

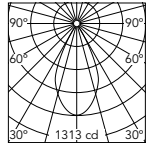

Beam Angle: 50°

h(m)	E(lx)	D(m)
1	1313	0.93
2	328	1.86
3	146	2.79
4	82	3.72
5	53	4.65

Luminous flux luminaire 791 lm (EXTREME CUT OFF)

Non Dimmable

- 03.4584.BU
- Dali Version
- 03.4584.BU.DA
- 1-10V
- 03.4584.BU.1V

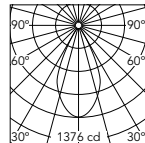

Beam Angle: 50°

h(m)	E(lx)	D(m)
1	1376	0.93
2	344	1.86
3	153	2.79
4	86	3.72
5	55	4.65

Luminous flux luminaire 829 lm (EXTREME CUT OFF)

Non Dimmable

- 03.4585.74
- Dali Version
- 03.4585.74.DA
- 1-10V
- 03.4585.74.1V

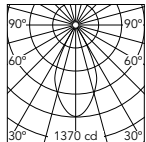

Beam Angle: 50°

h(m)	E(lx)	D(m)
1	1370	0.93
2	343	1.86
3	152	2.79
4	86	3.72
5	55	4.65

Luminous flux luminaire 815 lm (EXTREME CUT OFF)

Non Dimmable

- 03.4584.74
- Dali Version
- 03.4584.74.DA
- 1-10V
- 03.4584.74.1V

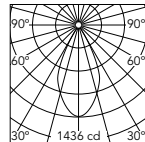

Beam Angle: 50°

h(m)	E(lx)	D(m)
1	1436	0.93
2	359	1.86
3	160	2.79
4	90	3.72
5	57	4.65

Luminous flux luminaire 854 lm (EXTREME CUT OFF)

Non Dimmable

- 03.4585.CU
- Dali Version
- 03.4585.CU.DA
- 1-10V
- 03.4585.CU.1V

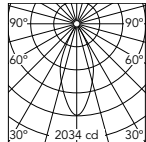

Beam Angle: 43°

h(m)	E(lx)	D(m)
1	2034	0.78
2	509	1.57
3	226	2.35
4	127	3.14
5	81	3.92

Luminous flux luminaire 977 lm (EXTREME CUT OFF)

Non Dimmable

- 03.4584.CU
- Dali Version
- 03.4584.CU.DA
- 1-10V
- 03.4584.CU.1V

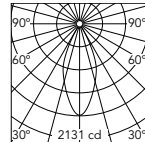

Beam Angle: 43°

h(m)	E(lx)	D(m)
1	2131	0.78
2	533	1.57
3	237	2.35
4	133	3.14
5	85	3.92

Luminous flux luminaire 1023 lm (EXTREME CUT OFF)

KAP

Kap Ø145 Deep

Light Source: Phosphor LED 17W - 1400 lm - 2700K/CRI 98 / 17W - 1400 lm - 3000K/CRI 98

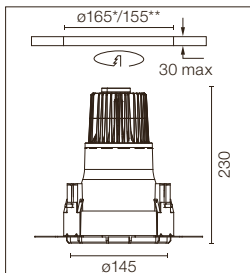

* No Trim | ** Trim

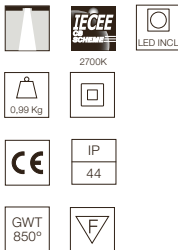

Incasso a LED. Trasformatore elettronico remoto 220/240V incluso.
Cornice di pre-installazione da ordinare separatamente.

Recessed luminaire with LED light source. Remote electronic transformer 220/240V included.
Pre-installation frame. To be ordered separately.

2700K

Non Dimmable

- 03.4497.B1B
Dali Version
- 03.4497.B1BDA
1-10V
- 03.4497.B1B1V

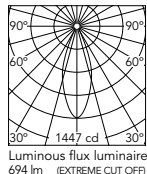

Beam Angle: 37°

h(m)	E(lx)	D(m)
1	1447	0.67
2	362	1.34
3	161	2.01
4	90	2.69
5	58	3.36

Luminous flux luminaire
694 lm (EXTREME CUT OFF)

3000K

Non Dimmable

- 03.4482.B1C
Dali Version
- 03.4482.B1CDA
1-10V
- 03.4482.B1C1V

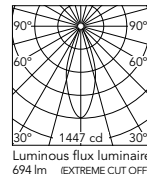

Beam Angle: 37°

h(m)	E(lx)	D(m)
1	1447	0.67
2	362	1.34
3	161	2.01
4	90	2.69
5	58	3.36

Luminous flux luminaire
694 lm (EXTREME CUT OFF)

Non Dimmable

- 03.4497.GLB
Dali Version
- 03.4497.GLBDA
1-10V
- 03.4497.GLB1V

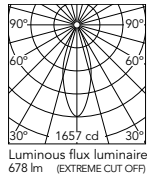

Beam Angle: 36°

h(m)	E(lx)	D(m)
1	1657	0.65
2	414	1.30
3	184	1.96
4	104	2.61
5	66	3.26

Luminous flux luminaire
678 lm (EXTREME CUT OFF)

Non Dimmable

- 03.4482.GLC
Dali Version
- 03.4482.GLCDA
1-10V
- 03.4482.GLC1V

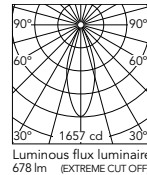

Beam Angle: 36°

h(m)	E(lx)	D(m)
1	1657	0.65
2	414	1.30
3	184	1.96
4	104	2.61
5	66	3.26

Luminous flux luminaire
678 lm (EXTREME CUT OFF)

Non Dimmable

- 03.4497.BUB
Dali Version
- 03.4497.BUBDA
1-10V
- 03.4497.BUB1V

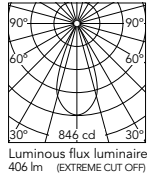

Beam Angle: 44°

h(m)	E(lx)	D(m)
1	846	0.80
2	211	1.60
3	94	2.39
4	53	3.19
5	34	3.99

Luminous flux luminaire
406 lm (EXTREME CUT OFF)

Non Dimmable

- 03.4482.BUC
Dali Version
- 03.4482.BUCDA
1-10V
- 03.4482.BUC1V

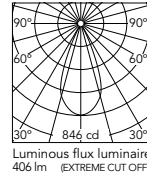

Beam Angle: 44°

h(m)	E(lx)	D(m)
1	846	0.80
2	211	1.60
3	94	2.39
4	53	3.19
5	34	3.99

Luminous flux luminaire
406 lm (EXTREME CUT OFF)

Non Dimmable

- 03.4497.74B
Dali Version
- 03.4497.74BDA
1-10V
- 03.4497.74B1V

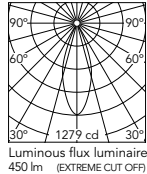

Beam Angle: 37°

h(m)	E(lx)	D(m)
1	1279	0.66
2	320	1.32
3	142	1.98
4	80	2.64
5	51	3.30

Luminous flux luminaire
450 lm (EXTREME CUT OFF)

Non Dimmable

- 03.4482.74C
Dali Version
- 03.4482.74CDA
1-10V
- 03.4482.74C1V

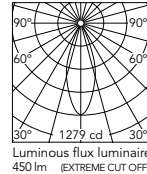

Beam Angle: 37°

h(m)	E(lx)	D(m)
1	1279	0.66
2	320	1.32
3	142	1.98
4	80	2.64
5	51	3.30

Luminous flux luminaire
450 lm (EXTREME CUT OFF)

Non Dimmable

- 03.4497.CUB
Dali Version
- 03.4497.CUBDA
1-10V
- 03.4497.CUB1V

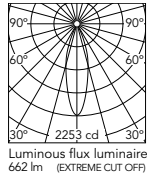

Beam Angle: 28°

h(m)	E(lx)	D(m)
1	2253	0.50
2	563	1.01
3	250	1.51
4	141	2.02
5	90	2.52

Luminous flux luminaire
662 lm (EXTREME CUT OFF)

Non Dimmable

- 03.4482.CUC
Dali Version
- 03.4482.CUCDA
1-10V
- 03.4482.CUC1V

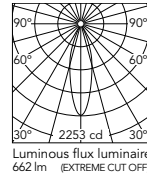

Beam Angle: 28°

h(m)	E(lx)	D(m)
1	2253	0.50
2	563	1.01
3	250	1.51
4	141	2.02
5	90	2.52

Luminous flux luminaire
662 lm (EXTREME CUT OFF)

KAP

Kap Ø145 Deep

Light Source: LED Array 17W - 1800 lm - 2700K/CRI 90 / 17W - 2000 lm - 3000K/CRI 90

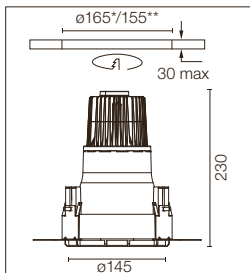

* No Trim | ** Trim

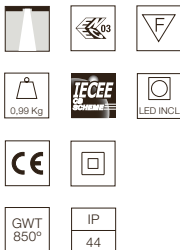

Incasso a LED. Trasformatore elettronico remoto 220/240V incluso.
Cornice di pre-installazione da ordinare separatamente.

Recessed luminaire with LED light source. Remote electronic transformer 220/240V included.
Pre-installation frame. To be ordered separately.

2700K

Non Dimmable

- 03.4587.B1
- Dali Version
- 03.4587.B1.DA
- 1-10V
- 03.4587.B1.1V

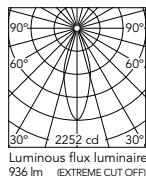

Beam Angle: 34°

h(m)	E(lx)	D(m)
1	2252	0.61
2	563	1.23
3	250	1.84
4	141	2.45
5	90	3.06

Luminous flux luminaire 2252 cd
936 lm (EXTREME CUT OFF)

3000K

Non Dimmable

- 03.4586.B1
- Dali Version
- 03.4586.B1.DA
- 1-10V
- 03.4586.B1.1V

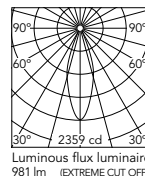

Beam Angle: 34°

h(m)	E(lx)	D(m)
1	2359	0.61
2	590	1.23
3	262	1.84
4	147	2.45
5	94	3.06

Luminous flux luminaire 2359 cd
981 lm (EXTREME CUT OFF)

Non Dimmable

- 03.4587.GL
- Dali Version
- 03.4587.GL.DA
- 1-10V
- 03.4587.GL.1V

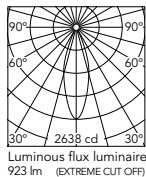

Beam Angle: 32°

h(m)	E(lx)	D(m)
1	2638	0.58
2	660	1.16
3	293	1.74
4	165	2.31
5	106	2.89

Luminous flux luminaire 2638 cd
923 lm (EXTREME CUT OFF)

Non Dimmable

- 03.4586.GL
- Dali Version
- 03.4586.GL.DA
- 1-10V
- 03.4586.GL.1V

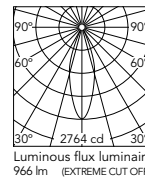

Beam Angle: 32°

h(m)	E(lx)	D(m)
1	2764	0.58
2	691	1.16
3	307	1.74
4	173	2.31
5	111	2.89

Luminous flux luminaire 2764 cd
966 lm (EXTREME CUT OFF)

Non Dimmable

- 03.4587.BU
- Dali Version
- 03.4587.BU.DA
- 1-10V
- 03.4587.BU.1V

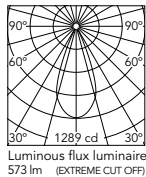

Beam Angle: 42°

h(m)	E(lx)	D(m)
1	1289	0.77
2	322	1.53
3	143	2.30
4	81	3.07
5	52	3.83

Luminous flux luminaire 1289 cd
573 lm (EXTREME CUT OFF)

Non Dimmable

- 03.4586.BU
- Dali Version
- 03.4586.BU.DA
- 1-10V
- 03.4586.BU.1V

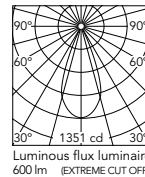

Beam Angle: 42°

h(m)	E(lx)	D(m)
1	1351	0.77
2	338	1.53
3	150	2.30
4	84	3.07
5	54	3.83

Luminous flux luminaire 1351 cd
600 lm (EXTREME CUT OFF)

Non Dimmable

- 03.4587.74
- Dali Version
- 03.4587.74.DA
- 1-10V
- 03.4587.74.1V

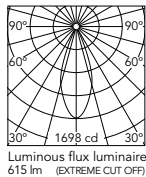

Beam Angle: 38°

h(m)	E(lx)	D(m)
1	1698	0.69
2	424	1.38
3	189	2.07
4	106	2.76
5	68	3.45

Luminous flux luminaire 1698 cd
615 lm (EXTREME CUT OFF)

Non Dimmable

- 03.4586.74
- Dali Version
- 03.4586.74.DA
- 1-10V
- 03.4586.74.1V

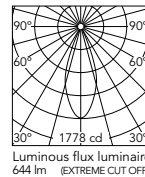

Beam Angle: 38°

h(m)	E(lx)	D(m)
1	1778	0.69
2	445	1.38
3	198	2.07
4	111	2.76
5	71	3.45

Luminous flux luminaire 1778 cd
644 lm (EXTREME CUT OFF)

Non Dimmable

- 03.4587.CU
- Dali Version
- 03.4587.CU.DA
- 1-10V
- 03.4587.CU.1V

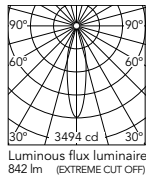

Beam Angle: 24°

h(m)	E(lx)	D(m)
1	3494	0.43
2	873	0.86
3	388	1.29
4	218	1.72
5	140	2.15

Luminous flux luminaire 3494 cd
842 lm (EXTREME CUT OFF)

Non Dimmable

- 03.4586.CU
- Dali Version
- 03.4586.CU.DA
- 1-10V
- 03.4586.CU.1V

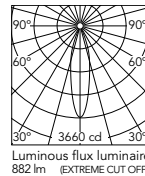

Beam Angle: 24°

h(m)	E(lx)	D(m)
1	3660	0.43
2	915	0.86
3	407	1.29
4	229	1.72
5	146	2.15

Luminous flux luminaire 3660 cd
882 lm (EXTREME CUT OFF)

Kap Ø145 Wall-Washer

Light Source: Phosphor LED 17W - 1400 lm - 2700K/CRI 98 / 17W - 1400 lm - 3000K/CRI 98

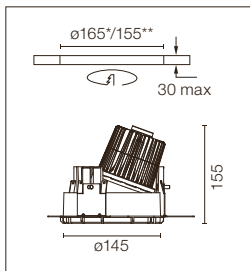

* No Trim | ** Trim

- GWT 850°
- TFC EE
- LED INCL
- CE
- IP 44
- 0.04 Kg
- 2700K
- 30°

Incasso a LED. Trasformatore elettronico remoto 220/240V incluso.
Cornice di pre-installazione da ordinare separatamente.

Recessed luminaire with LED light source. Remote electronic transformer 220/240V included.
Pre-installation frame. To be ordered separately.

2700K

Non Dimmable

- 03.4498.B1B
- Dali Version
- 03.4498.B1BDA
- 1-10V
- 03.4498.B1B1V

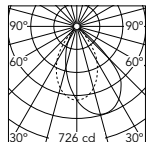

Luminous flux luminaire 872 lm (EXTREME CUT OFF)

Beam Angle: 59°

h(m)	E(lx)	D(m)
1	726	1.26
2	181	2.53
3	81	3.79
4	45	5.05
5	29	6.32

3000K

Non Dimmable

- 03.4475.B1C
- Dali Version
- 03.4475.B1CDA
- 1-10V
- 03.4475.B1C1V

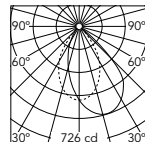

Luminous flux luminaire 872 lm (EXTREME CUT OFF)

Beam Angle: 59°

h(m)	E(lx)	D(m)
1	726	1.26
2	181	2.53
3	81	3.79
4	45	5.05
5	29	6.32

Non Dimmable

- 03.4498.GLB
- Dali Version
- 03.4498.GLBDA
- 1-10V
- 03.4498.GLB1V

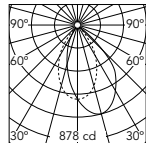

Luminous flux luminaire 871 lm (EXTREME CUT OFF)

Beam Angle: 56°

h(m)	E(lx)	D(m)
1	878	1.18
2	219	2.37
3	98	3.55
4	55	4.73
5	35	5.92

Non Dimmable

- 03.4475.GLC
- Dali Version
- 03.4475.GLCDA
- 1-10V
- 03.4475.GLC1V

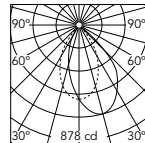

Luminous flux luminaire 871 lm (EXTREME CUT OFF)

Beam Angle: 56°

h(m)	E(lx)	D(m)
1	878	1.18
2	219	2.37
3	98	3.55
4	55	4.73
5	35	5.92

Non Dimmable

- 03.4498.BUB
- Dali Version
- 03.4498.BUBDA
- 1-10V
- 03.4498.BUB1V

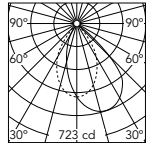

Luminous flux luminaire 736 lm (EXTREME CUT OFF)

Beam Angle: 58°

h(m)	E(lx)	D(m)
1	723	1.25
2	181	2.51
3	80	3.76
4	45	5.01
5	29	6.26

Non Dimmable

- 03.4475.BUC
- Dali Version
- 03.4475.BUCDA
- 1-10V
- 03.4475.BUC1V

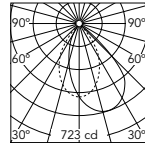

Luminous flux luminaire 736 lm (EXTREME CUT OFF)

Beam Angle: 58°

h(m)	E(lx)	D(m)
1	723	1.25
2	181	2.51
3	80	3.76
4	45	5.01
5	29	6.26

Non Dimmable

- 03.4498.74B
- Dali Version
- 03.4498.74BDA
- 1-10V
- 03.4498.74B1V

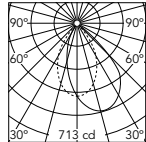

Luminous flux luminaire 747 lm (EXTREME CUT OFF)

Beam Angle: 58°

h(m)	E(lx)	D(m)
1	713	1.24
2	178	2.48
3	79	3.72
4	45	4.96
5	29	6.20

Non Dimmable

- 03.4475.74C
- Dali Version
- 03.4475.74CDA
- 1-10V
- 03.4475.74C1V

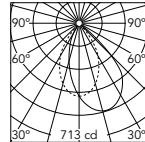

Luminous flux luminaire 747 lm (EXTREME CUT OFF)

Beam Angle: 58°

h(m)	E(lx)	D(m)
1	713	1.24
2	178	2.48
3	79	3.72
4	45	4.96
5	29	6.20

Non Dimmable

- 03.4498.CUB
- Dali Version
- 03.4498.CUBDA
- 1-10V
- 03.4498.CUB1V

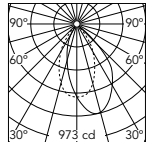

Luminous flux luminaire 879 lm (EXTREME CUT OFF)

Beam Angle: 54°

h(m)	E(lx)	D(m)
1	973	1.10
2	243	2.21
3	108	3.31
4	61	4.42
5	39	5.52

Non Dimmable

- 03.4475.CUC
- Dali Version
- 03.4475.CUCDA
- 1-10V
- 03.4475.CUC1V

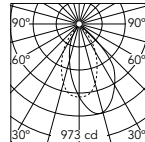

Luminous flux luminaire 879 lm (EXTREME CUT OFF)

Beam Angle: 54°

h(m)	E(lx)	D(m)
1	973	1.10
2	243	2.21
3	108	3.31
4	61	4.42
5	39	5.52

Kap Ø145 Wall-Washer

Light Source: LED Array 17W - 1800 lm - 2700K/CRI 90 / 17W - 2000 lm - 3000K/CRI 90

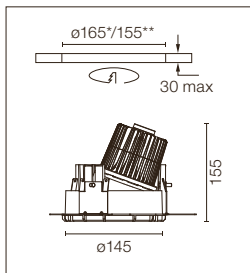

* No Trim | ** Trim



Incasto a LED. Trasformatore elettronico remoto 220/240V incluso.
Cornice di pre-installazione da ordinare separatamente.

Recessed luminaire with LED light source. Remote electronic transformer 220/240V included.
Pre-installation frame. To be ordered separately.

2700K

Non Dimmable

- 03.4589.B1
- Dali Version
- 03.4589.B1.DA
- 1-10V
- 03.4589.B1.1V

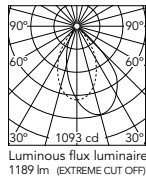

Beam Angle: 56°

h(m)	E(lx)	D(m)
1	1093	1.17
2	273	2.34
3	121	3.52
4	68	4.69
5	44	5.86

3000K

Non Dimmable

- 03.4588.B1
- Dali Version
- 03.4588.B1.DA
- 1-10V
- 03.4588.B1.1V

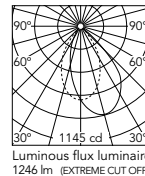

Beam Angle: 56°

h(m)	E(lx)	D(m)
1	1145	1.17
2	286	2.34
3	127	3.52
4	72	4.69
5	46	5.86

Non Dimmable

- 03.4589.GL
- Dali Version
- 03.4589.GL.DA
- 1-10V
- 03.4589.GL.1V

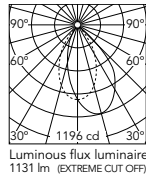

Beam Angle: 55°

h(m)	E(lx)	D(m)
1	1196	1.13
2	299	2.26
3	133	3.39
4	75	4.52
5	48	5.65

Non Dimmable

- 03.4588.GL
- Dali Version
- 03.4588.GL.DA
- 1-10V
- 03.4588.GL.1V

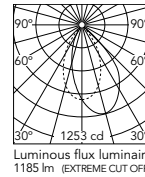

Beam Angle: 55°

h(m)	E(lx)	D(m)
1	1253	1.13
2	313	2.26
3	139	3.39
4	78	4.52
5	50	5.65

Non Dimmable

- 03.4589.BU
- Dali Version
- 03.4589.BU.DA
- 1-10V
- 03.4589.BU.1V

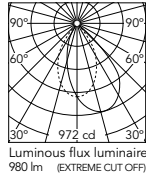

Beam Angle: 56°

h(m)	E(lx)	D(m)
1	972	1.17
2	243	2.34
3	108	3.51
4	61	4.68
5	39	5.85

Non Dimmable

- 03.4588.BU
- Dali Version
- 03.4588.BU.DA
- 1-10V
- 03.4588.BU.1V

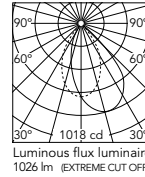

Beam Angle: 56°

h(m)	E(lx)	D(m)
1	1018	1.17
2	254	2.34
3	113	3.51
4	64	4.68
5	41	5.85

Non Dimmable

- 03.4589.74
- Dali Version
- 03.4589.74.DA
- 1-10V
- 03.4589.74.1V

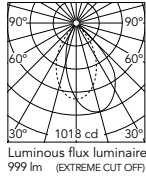

Beam Angle: 55°

h(m)	E(lx)	D(m)
1	1018	1.14
2	254	2.29
3	113	3.43
4	64	4.57
5	41	5.72

Non Dimmable

- 03.4588.74
- Dali Version
- 03.4588.74.DA
- 1-10V
- 03.4588.74.1V

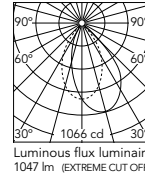

Beam Angle: 55°

h(m)	E(lx)	D(m)
1	1066	1.14
2	267	2.29
3	118	3.43
4	67	4.57
5	43	5.72

Non Dimmable

- 03.4589.CU
- Dali Version
- 03.4589.CU.DA
- 1-10V
- 03.4589.CU.1V

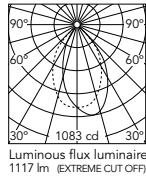

Beam Angle: 56°

h(m)	E(lx)	D(m)
1	1083	1.09
2	271	2.18
3	120	3.27
4	68	4.36
5	43	5.45

Non Dimmable

- 03.4588.CU
- Dali Version
- 03.4588.CU.DA
- 1-10V
- 03.4588.CU.1V

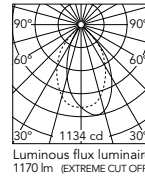

Beam Angle: 56°

h(m)	E(lx)	D(m)
1	1134	1.09
2	284	2.18
3	126	3.27
4	71	4.36
5	45	5.45

Easy Kap Ø50 Fixed - Optic Spot

Light Source: LED Array DC 200 mA - 7,5W - 595 lm - 2700K/CRI 90 / 7,5W - 635 lm - 3000K/CRI 90

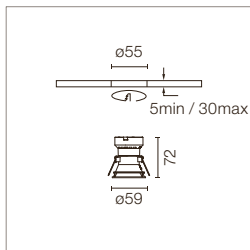

GWT 850°
 IP 54
 0,14 Kg
 03
 F
 h=100 min
 LED INCL
 CE
 III

Incasso a LED. Fonte di alimentazione esclusa. Cornice di installazione non necessaria.

Recessed luminaire with LED light source. Power supply not included. Installation frame not necessary.

Alimentazioni raccomandate / Recommended power supply*:

- Non Dimmable 60.9160
- Dimmable 0-10V 60.9483
- Dimmable Dali 60.9604
- Mains Dimming 60.9421
- Casambi 60.9392 + DALI/1-10V Driver

* Vedi capitolo Drivers / Refer to the Drivers chapter

2700K
□ 05.7200.B1

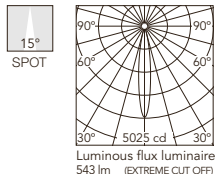

3000K
□ 05.7205.B1

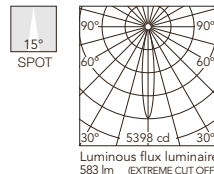

■ 05.7200.GL

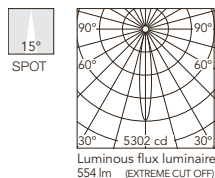

■ 05.7205.GL

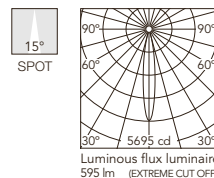

■ 05.7200.BU

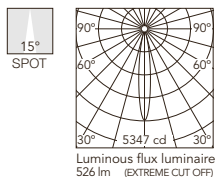

■ 05.7205.BU

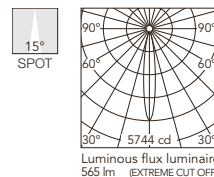

■ 05.7200.74

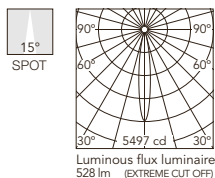

■ 05.7205.74

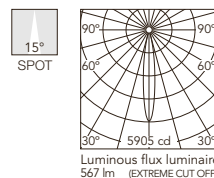

■ 05.7200.CU

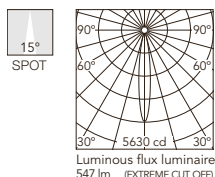

■ 05.7205.CU

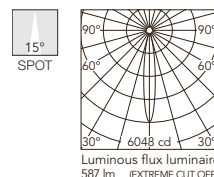

Easy Kap Ø50 Fixed - Optic Medium

Light Source: LED Array DC 200 mA - 7,5W - 595 lm - 2700K/CRI 90 / 7,5W - 635 lm - 3000K/CRI 90

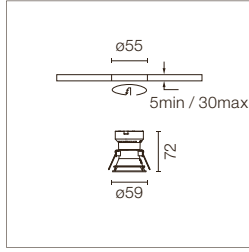

Incasso a LED. Fonte di alimentazione esclusa. Cornice di installazione non necessaria.

Recessed luminaire with LED light source. Power supply not included. Installation frame not necessary.

Alimentazioni raccomandate / Recommended power supply*:

- Non Dimmable 60.9160
- Dimmable 0-10V 60.9483
- Dimmable Dali 60.9604
- Mains Dimming 60.9421
- Casambi 60.9392 + DALI/1-10V Driver

* Vedi capitolo Drivers / Refer to the Drivers chapter

2700K
□ 05.7201.B1

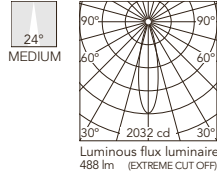

Beam Angle: 24°

h(m)	E(lx)	D(m)
1	2032	0.43
2	508	0.86
3	226	1.30
4	127	1.73
5	81	2.16

3000K
□ 05.7206.B1

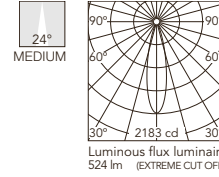

Beam Angle: 24°

h(m)	E(lx)	D(m)
1	2183	0.43
2	546	0.86
3	243	1.30
4	136	1.73
5	87	2.16

■ 05.7201.GL

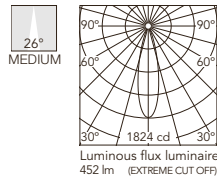

Beam Angle: 26°

h(m)	E(lx)	D(m)
1	1824	0.45
2	456	0.91
3	203	1.36
4	114	1.82
5	73	2.27

■ 05.7206.GL

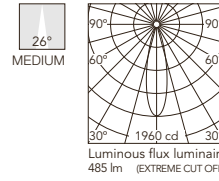

Beam Angle: 26°

h(m)	E(lx)	D(m)
1	1960	0.45
2	490	0.91
3	218	1.36
4	122	1.82
5	78	2.27

■ 05.7201.BU

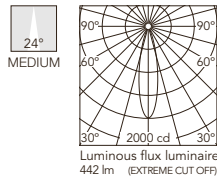

Beam Angle: 24°

h(m)	E(lx)	D(m)
1	2000	0.42
2	500	0.84
3	222	1.26
4	125	1.67
5	80	2.09

■ 05.7206.BU

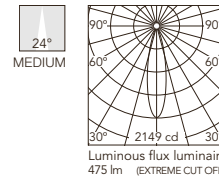

Beam Angle: 24°

h(m)	E(lx)	D(m)
1	2149	0.42
2	537	0.84
3	239	1.26
4	134	1.67
5	86	2.09

■ 05.7201.74

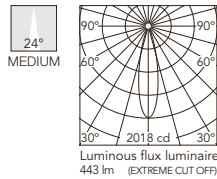

Beam Angle: 24°

h(m)	E(lx)	D(m)
1	2018	0.43
2	504	0.85
3	224	1.28
4	126	1.71
5	81	2.13

■ 05.7206.74

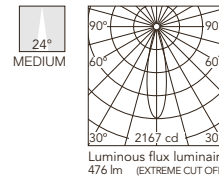

Beam Angle: 24°

h(m)	E(lx)	D(m)
1	2167	0.43
2	542	0.85
3	241	1.28
4	135	1.71
5	87	2.13

■ 05.7201.CU

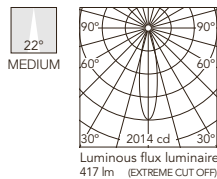

Beam Angle: 22°

h(m)	E(lx)	D(m)
1	2014	0.40
2	503	0.79
3	224	1.19
4	126	1.59
5	81	1.99

■ 05.7206.CU

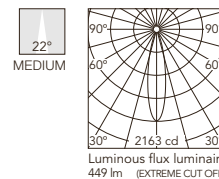

Beam Angle: 22°

h(m)	E(lx)	D(m)
1	2163	0.40
2	541	0.79
3	240	1.19
4	135	1.59
5	87	1.99

Easy Kap Ø50 Fixed - Optic Flood

Light Source: LED Array DC 200 mA - 7,5W - 595 lm - 2700K/CRI 90 / 7,5W - 635 lm - 3000K/CRI 90

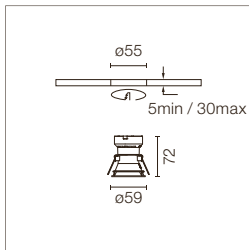

	GWT 850°		IP 54
	0,14 Kg		
	LED INCL		
	IPCEEE SCHIEVATO		
	h=100 mm		

Incasto a LED. Fonte di alimentazione esclusa. Cornice di installazione non necessaria.

Recessed luminaire with LED light source. Power supply not included. Installation frame not necessary.

Alimentazioni raccomandate / Recommended power supply*:

- Non Dimmable 60.9160
- Dimmable 0-10V 60.9483
- Dimmable Dali 60.9604
- Mains Dimming 60.9421
- Casambi 60.9392 + DALI/1-10V Driver

* Vedi capitolo Drivers / Refer to the Drivers chapter

2700K
□ 05.7202.B1

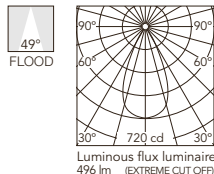

h(m)	E(lx)	D(m)
1	720	0.91
2	180	1.83
3	80	2.74
4	45	3.66
5	29	4.57

3000K
□ 05.7207.B1

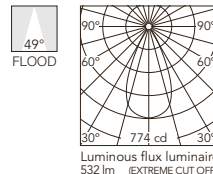

h(m)	E(lx)	D(m)
1	774	0.91
2	193	1.83
3	86	2.74
4	48	3.66
5	31	4.57

■ 05.7202.GL

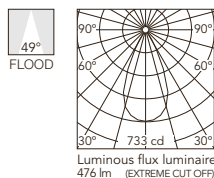

h(m)	E(lx)	D(m)
1	733	0.90
2	183	1.81
3	81	2.71
4	46	3.61
5	29	4.52

■ 05.7207.GL

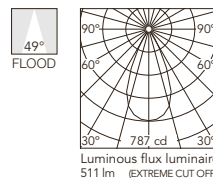

h(m)	E(lx)	D(m)
1	787	0.90
2	197	1.81
3	87	2.71
4	49	3.61
5	31	4.52

■ 05.7202.BU

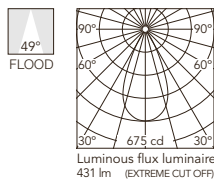

h(m)	E(lx)	D(m)
1	675	0.91
2	169	1.81
3	75	2.72
4	42	3.63
5	27	4.53

■ 05.7207.BU

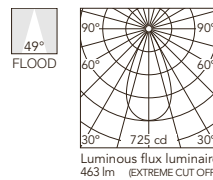

h(m)	E(lx)	D(m)
1	725	0.91
2	181	1.81
3	81	2.72
4	45	3.63
5	29	4.53

■ 05.7202.74

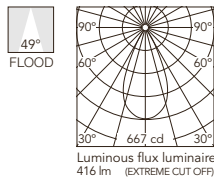

h(m)	E(lx)	D(m)
1	667	0.91
2	167	1.82
3	74	2.72
4	42	3.63
5	27	4.54

■ 05.7207.74

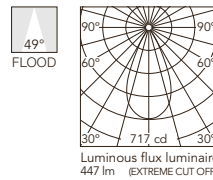

h(m)	E(lx)	D(m)
1	717	0.91
2	179	1.82
3	80	2.72
4	45	3.63
5	29	4.54

■ 05.7202.CU

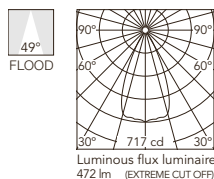

h(m)	E(lx)	D(m)
1	717	0.91
2	179	1.83
3	80	2.74
4	45	3.66
5	29	4.57

■ 05.7207.CU

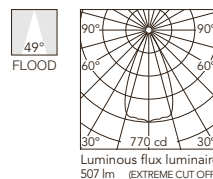

h(m)	E(lx)	D(m)
1	770	0.91
2	193	1.83
3	86	2.74
4	48	3.66
5	31	4.57

Easy Kap Ø50 Adjustable - Optic Spot

Light Source: LED Array DC 200 mA - 7,5W - 595 lm - 2700K/CRI 90 / 7,5W - 635 lm - 3000K/CRI 90

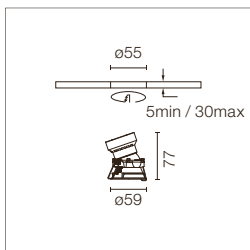

0,16 Kg

h=91 min

Incasso a LED. Fonte di alimentazione esclusa. Cornice di installazione non necessaria.

Recessed luminaire with LED light source. Power supply not included. Installation frame not necessary.

Alimentazioni raccomandate / Recommended power supply*:

- Non Dimmable 60.9160
- Dimmable 0-10V 60.9483
- Dimmable Dali 60.9604
- Mains Dimming 60.9421
- Casambi 60.9392 + DALI/1-10V Driver

* Vedi capitolo Drivers / Refer to the Drivers chapter

2700K
05.7210.B1

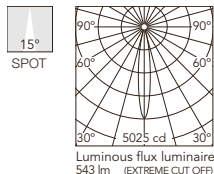

Beam Angle: 15°

h(m)	E(lx)	D(m)
1	5025	0.27
2	1256	0.53
3	558	0.80
4	314	1.07
5	201	1.33

Luminous flux luminaire 543 lm (EXTREME CUT OFF)

3000K
05.7215.B1

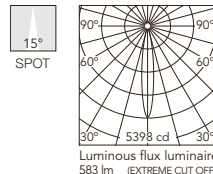

Beam Angle: 15°

h(m)	E(lx)	D(m)
1	5398	0.27
2	1349	0.53
3	600	0.80
4	337	1.07
5	216	1.33

Luminous flux luminaire 583 lm (EXTREME CUT OFF)

05.7210.GL

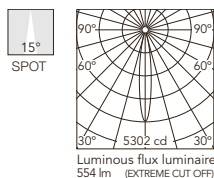

Beam Angle: 15°

h(m)	E(lx)	D(m)
1	5302	0.26
2	1325	0.53
3	589	0.79
4	331	1.06
5	212	1.32

Luminous flux luminaire 554 lm (EXTREME CUT OFF)

05.7215.GL

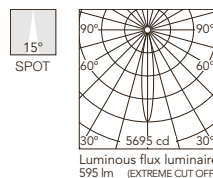

Beam Angle: 15°

h(m)	E(lx)	D(m)
1	5695	0.26
2	1424	0.53
3	633	0.79
4	356	1.06
5	228	1.32

Luminous flux luminaire 595 lm (EXTREME CUT OFF)

05.7210.BU

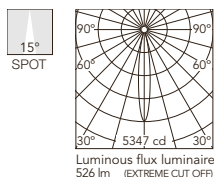

Beam Angle: 15°

h(m)	E(lx)	D(m)
1	5347	0.26
2	1337	0.52
3	594	0.78
4	334	1.04
5	214	1.30

Luminous flux luminaire 526 lm (EXTREME CUT OFF)

05.7215.BU

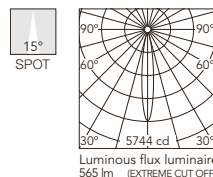

Beam Angle: 15°

h(m)	E(lx)	D(m)
1	5744	0.26
2	1436	0.52
3	638	0.78
4	359	1.04
5	230	1.30

Luminous flux luminaire 565 lm (EXTREME CUT OFF)

05.7210.74

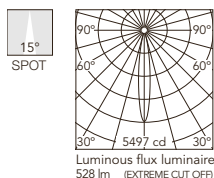

Beam Angle: 15°

h(m)	E(lx)	D(m)
1	5497	0.26
2	1374	0.52
3	611	0.77
4	344	1.03
5	220	1.29

Luminous flux luminaire 528 lm (EXTREME CUT OFF)

05.7215.74

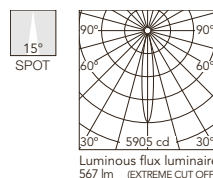

Beam Angle: 15°

h(m)	E(lx)	D(m)
1	5905	0.26
2	1476	0.52
3	656	0.77
4	369	1.03
5	236	1.29

Luminous flux luminaire 567 lm (EXTREME CUT OFF)

05.7210.CU

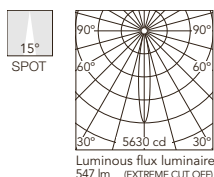

Beam Angle: 15°

h(m)	E(lx)	D(m)
1	5630	0.26
2	1408	0.51
3	626	0.77
4	352	1.03
5	225	1.29

Luminous flux luminaire 547 lm (EXTREME CUT OFF)

05.7215.CU

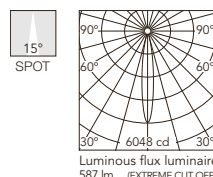

Beam Angle: 15°

h(m)	E(lx)	D(m)
1	6048	0.26
2	1512	0.51
3	672	0.77
4	378	1.03
5	242	1.29

Luminous flux luminaire 587 lm (EXTREME CUT OFF)

Easy Kap Ø50 Adjustable - Optic Medium

Light Source: LED Array DC 200 mA - 7,5W - 595 lm - 2700K/CRI 90 / 7,5W - 635 lm - 3000K/CRI 90

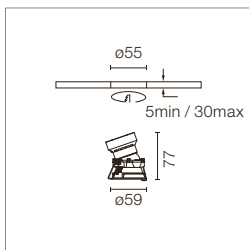

Incasso a LED. Fonte di alimentazione esclusa. Cornice di installazione non necessaria.

Recessed luminaire with LED light source. Power supply not included. Installation frame not necessary.

Alimentazioni raccomandate / Recommended power supply*:

- Non Dimmable 60.9160
- Dimmable 0-10V 60.9483
- Dimmable Dali 60.9604
- Mains Dimming 60.9421
- Casambi 60.9392 + DALI/1-10V Driver

* Vedi capitolo Drivers / Refer to the Drivers chapter

2700K
□ 05.7211.B1

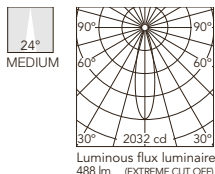

h(m)	E(lx)	D(m)
1	2032	0.43
2	508	0.86
3	226	1.30
4	127	1.73
5	81	2.16

3000K
□ 05.7216.B1

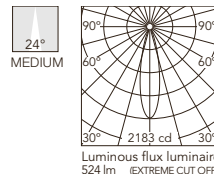

h(m)	E(lx)	D(m)
1	2183	0.43
2	546	0.86
3	243	1.30
4	136	1.73
5	87	2.16

■ 05.7211.GL

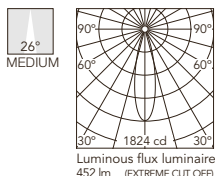

h(m)	E(lx)	D(m)
1	1824	0.45
2	456	0.91
3	203	1.36
4	114	1.82
5	73	2.27

■ 05.7216.GL

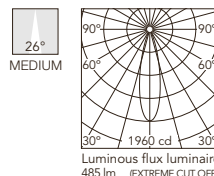

h(m)	E(lx)	D(m)
1	1960	0.45
2	490	0.91
3	218	1.36
4	122	1.82
5	78	2.27

■ 05.7211.BU

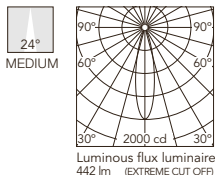

h(m)	E(lx)	D(m)
1	2000	0.42
2	500	0.84
3	222	1.26
4	125	1.67
5	80	2.09

■ 05.7216.BU

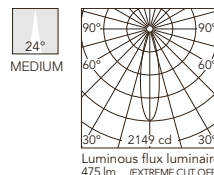

h(m)	E(lx)	D(m)
1	2149	0.42
2	537	0.84
3	239	1.26
4	134	1.67
5	86	2.09

■ 05.7211.74

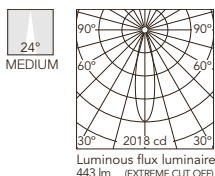

h(m)	E(lx)	D(m)
1	2018	0.43
2	504	0.85
3	224	1.28
4	126	1.71
5	81	2.13

■ 05.7216.74

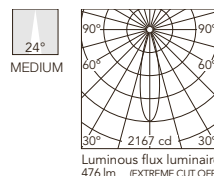

h(m)	E(lx)	D(m)
1	2167	0.43
2	542	0.85
3	241	1.28
4	135	1.71
5	87	2.13

■ 05.7211.CU

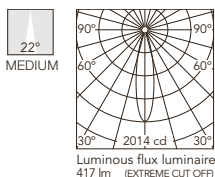

h(m)	E(lx)	D(m)
1	2014	0.40
2	503	0.79
3	224	1.19
4	126	1.59
5	81	1.99

■ 05.7216.CU

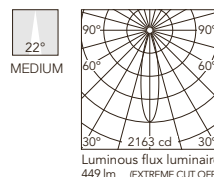

h(m)	E(lx)	D(m)
1	2163	0.40
2	541	0.79
3	240	1.19
4	135	1.59
5	87	1.99

Easy Kap Ø50 Adjustable - Optic Flood

Light Source: LED Array DC 200 mA - 7,5W - 595 lm - 2700K/CRI 90 / 7,5W - 635 lm - 3000K/CRI 90

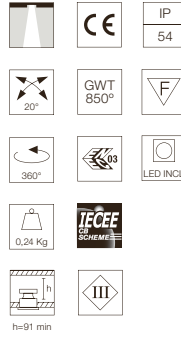
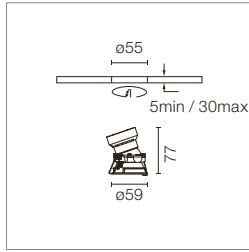

Incasso a LED. Fonte di alimentazione esclusa. Cornice di installazione non necessaria.

Recessed luminaire with LED light source. Power supply not included. Installation frame not necessary.

Alimentazioni raccomandate / Recommended power supply*:

- Non Dimmable 60.9160
- Dimmable 0-10V 60.9483
- Dimmable Dali 60.9604
- Mains Dimming 60.9421
- Casambi 60.9392 + DALI/1-10V Driver

* Vedi capitolo Drivers / Refer to the Drivers chapter

2700K
□ 05.7212.B1

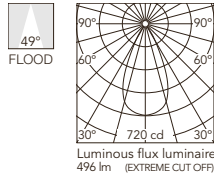

Beam Angle: 49°

h(m)	E(lx)	D(m)
1	720	0.91
2	180	1.83
3	80	2.74
4	45	3.66
5	29	4.57

Luminous flux luminaire 496 lm (EXTREME CUT OFF)

3000K
□ 05.7217.B1

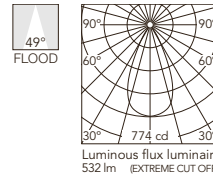

Beam Angle: 49°

h(m)	E(lx)	D(m)
1	774	0.91
2	193	1.83
3	86	2.74
4	48	3.66
5	31	4.57

Luminous flux luminaire 532 lm (EXTREME CUT OFF)

■ 05.7212.GL

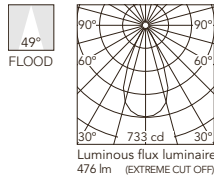

Beam Angle: 49°

h(m)	E(lx)	D(m)
1	733	0.90
2	183	1.81
3	81	2.71
4	46	3.61
5	29	4.52

Luminous flux luminaire 476 lm (EXTREME CUT OFF)

■ 05.7217.GL

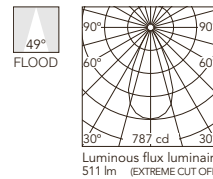

Beam Angle: 49°

h(m)	E(lx)	D(m)
1	787	0.90
2	197	1.81
3	87	2.71
4	49	3.61
5	31	4.52

Luminous flux luminaire 511 lm (EXTREME CUT OFF)

■ 05.7212.BU

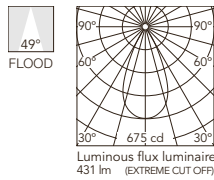

Beam Angle: 49°

h(m)	E(lx)	D(m)
1	675	0.91
2	169	1.81
3	75	2.72
4	42	3.63
5	27	4.53

Luminous flux luminaire 431 lm (EXTREME CUT OFF)

■ 05.7217.BU

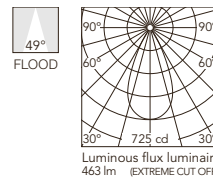

Beam Angle: 49°

h(m)	E(lx)	D(m)
1	725	0.91
2	181	1.81
3	81	2.72
4	45	3.63
5	29	4.53

Luminous flux luminaire 463 lm (EXTREME CUT OFF)

■ 05.7212.74

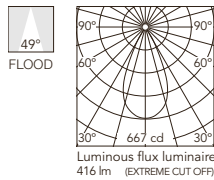

Beam Angle: 49°

h(m)	E(lx)	D(m)
1	667	0.91
2	167	1.82
3	74	2.72
4	42	3.63
5	27	4.54

Luminous flux luminaire 416 lm (EXTREME CUT OFF)

■ 05.7217.74

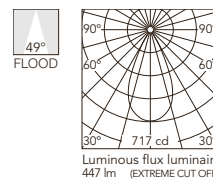

Beam Angle: 49°

h(m)	E(lx)	D(m)
1	717	0.91
2	179	1.82
3	80	2.72
4	45	3.63
5	29	4.54

Luminous flux luminaire 447 lm (EXTREME CUT OFF)

■ 05.7212.CU

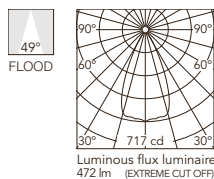

Beam Angle: 49°

h(m)	E(lx)	D(m)
1	717	0.91
2	179	1.83
3	80	2.74
4	45	3.66
5	29	4.57

Luminous flux luminaire 472 lm (EXTREME CUT OFF)

■ 05.7217.CU

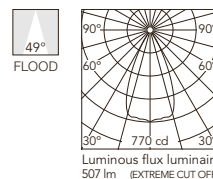

Beam Angle: 49°

h(m)	E(lx)	D(m)
1	770	0.91
2	193	1.83
3	86	2.74
4	48	3.66
5	31	4.57

Luminous flux luminaire 507 lm (EXTREME CUT OFF)

KAP

Easy Kap Ø80/Easy Kap Ø80 Plus - Fixed - Optic Spot

Light Source: Easy Kap Ø80: LED Array DC 500 mA - 9,2W - 935 lm - 2700K/CRI 90 / 9,2W - 974 lm - 3000K/CRI 90

Easy Kap Ø80 Plus: LED Array DC 700 mA - 13W - 1370 lm - 2700K/CRI 90 / 13W - 1460 lm - 3000K/CRI 90

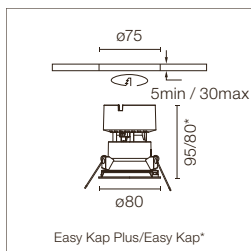

- GWT 850°
- IP 54
- 0,24 Kg
- Easy Kap Ø80
- Easy Kap Ø80 Plus
- LED INCL
- CE
- III

Incasso a LED. Fonte di alimentazione esclusa. Cornice di installazione non necessaria. Lente diffusore incluso.

Recessed luminaire with LED light source. Power supply not included. Installation frame not necessary. Diffusing lens included.

Alimentazioni raccomandate / Recommended power supply*:

	Easy Kap Ø80	Easy Kap Ø80 Plus
Non Dimmable	60.9160	60.9592
Dimmable 0/1-10V	RF27961	RF27961
Dimmable Dali 1	RF26571	RF26571
Dimmable Dali 2	60.9222	60.9222
Mains Dimming	60.9411	60.9467
Casambi	60.9207	60.9207

* Vedi capitolo Drivers / Refer to the Drivers chapter

- 2700K**
 Easy Kap Ø80
 03.4288.B1
 Easy Kap Ø80 Plus
 05.7441.B1

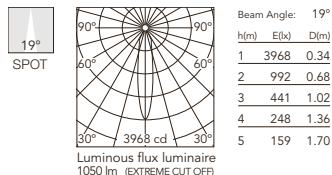

- 3000K**
 Easy Kap Ø80
 03.4287.B1
 Easy Kap Ø80 Plus
 05.7440.B1

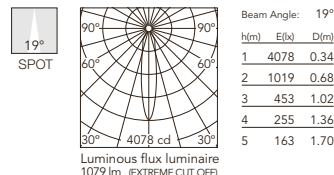

- Easy Kap Ø80
 03.4288.GL
 Easy Kap Ø80 Plus
 05.7441.GL

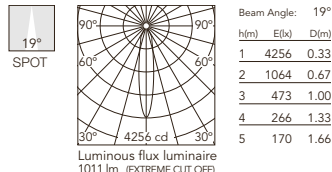

- Easy Kap Ø80
 03.4287.GL
 Easy Kap Ø80 Plus
 05.7440.GL

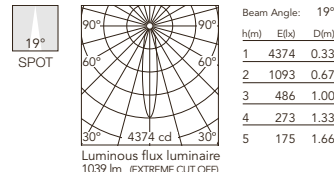

- Easy Kap Ø80
 03.4288.BU
 Easy Kap Ø80 Plus
 05.7441.BU

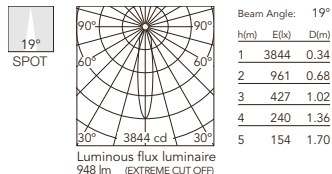

- Easy Kap Ø80
 03.4287.BU
 Easy Kap Ø80 Plus
 05.7440.BU

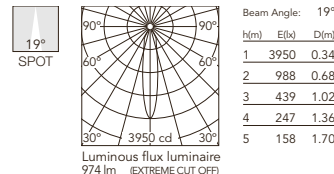

- Easy Kap Ø80
 03.4288.74
 Easy Kap Ø80 Plus
 05.7441.74

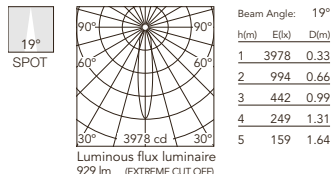

- Easy Kap Ø80
 03.4287.74
 Easy Kap Ø80 Plus
 05.7440.74

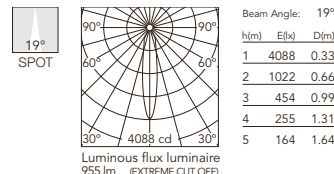

- Easy Kap Ø80
 03.4288.CU
 Easy Kap Ø80 Plus
 05.7441.CU

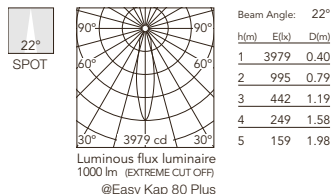

- Easy Kap Ø80
 03.4287.CU
 Easy Kap Ø80 Plus
 05.7440.CU

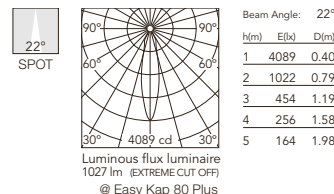

Easy Kap Ø80 Fixed - Optic Spot - Dim To Warm

Light Source: LED Array 13W - 1800K - 2850K/CRI 95 - Dim To Warm

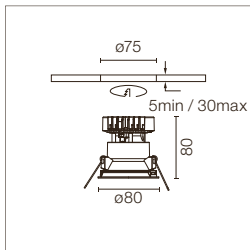

	GWT 850°	IP 54
	0,24 Kg	
	h=91 min	

Incasso a LED. Fonte di alimentazione 220-240V e dimmerabile 1-10V inclusa. Per versioni con apparecchi a 110V, contattare il Front office. Cornice di installazione non necessaria. Lente diffusore incluso.

Recessed luminaire with LED light source. 220-240V & dimmable 1-10V power supply included. For 110V PSU versions, please consult with the front office. Installation frame not necessary. Diffusing lens included.

1800K-2850K
03.4287.B1.LE

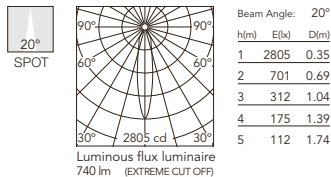

03.4287.GL.LE

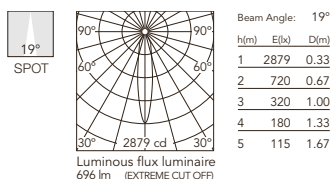

03.4287.BU.LE

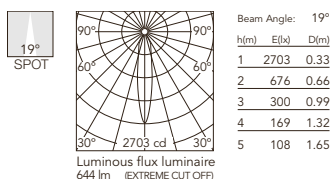

03.4287.74.LE

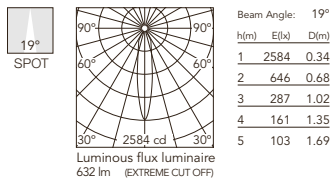

03.4287.CU.LE

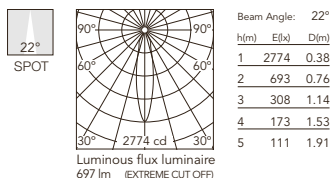

KAP

Easy Kap Ø80/Easy Kap Ø80 Plus - Fixed - Optic Medium

Light Source: Easy Kap Ø80: LED Array DC 500 mA - 9,2W - 935 lm - 2700K/CRI 90 / 9,2W - 974 lm - 3000K/CRI 90

Easy Kap Ø80 Plus: LED Array DC 700 mA - 13W - 1370 lm - 2700K/CRI 90 / 13W - 1460 lm - 3000K/CRI 90

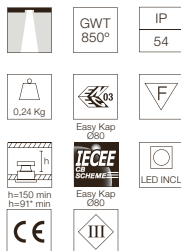
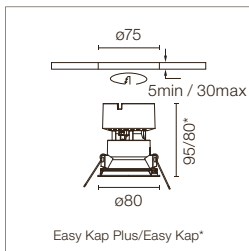

Incasso a LED. Fonte di alimentazione esclusa. Cornice di installazione non necessaria. Lente diffusore incluso.

Recessed luminaire with LED light source. Power supply not included. Installation frame not necessary. Diffusing lens included.

Alimentazioni raccomandate / Recommended power supply*:

	Easy Kap Ø80	Easy Kap Ø80 Plus
Non Dimmable	60.9160	60.9592
Dimmable 0/1-10V	RF27961	RF27961
Dimmable Dali 1	RF26571	RF26571
Dimmable Dali 2	60.9222	60.9222
Mains Dimming	60.9411	60.9467
Casambi	60.9207	60.9207

* Vedi capitolo Drivers / Refer to the Drivers chapter

- 2700K**
Easy Kap Ø80
□ 03.4193.B1
Easy Kap Ø80 Plus
□ 05.7431.B1

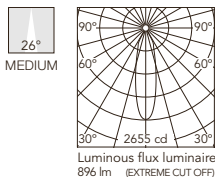

Beam Angle: 26°

h(m)	E(lx)	D(m)
1	2655	0.46
2	664	0.92
3	295	1.39
4	166	1.85
5	106	2.31

- 3000K**
Easy Kap Ø80
□ 03.4192.B1
Easy Kap Ø80 Plus
□ 05.7430.B1

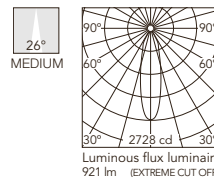

Beam Angle: 26°

h(m)	E(lx)	D(m)
1	2728	0.46
2	682	0.92
3	303	1.39
4	170	1.85
5	109	2.31

- Easy Kap Ø80
■ 03.4193.GL
Easy Kap Ø80 Plus
■ 05.7431.GL

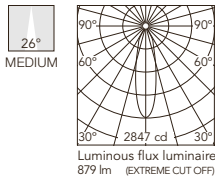

Beam Angle: 26°

h(m)	E(lx)	D(m)
1	2847	0.46
2	712	0.92
3	316	1.38
4	178	1.84
5	114	2.30

- Easy Kap Ø80
■ 03.4192.GL
Easy Kap Ø80 Plus
■ 05.7430.GL

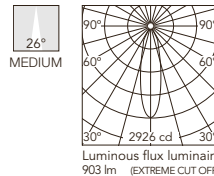

Beam Angle: 26°

h(m)	E(lx)	D(m)
1	2926	0.46
2	731	0.92
3	325	1.38
4	183	1.84
5	117	2.30

- Easy Kap Ø80
■ 03.4193.BU
Easy Kap Ø80 Plus
■ 05.7431.BU

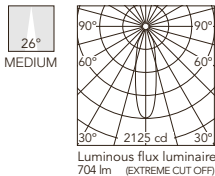

Beam Angle: 26°

h(m)	E(lx)	D(m)
1	2125	0.47
2	531	0.93
3	236	1.40
4	133	1.87
5	85	2.34

- Easy Kap Ø80
■ 03.4192.BU
Easy Kap Ø80 Plus
■ 05.7430.BU

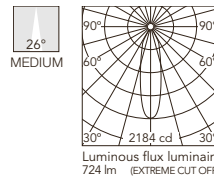

Beam Angle: 26°

h(m)	E(lx)	D(m)
1	2184	0.47
2	546	0.93
3	243	1.40
4	137	1.87
5	87	2.34

- Easy Kap Ø80
■ 03.4193.74
Easy Kap Ø80 Plus
■ 05.7431.74

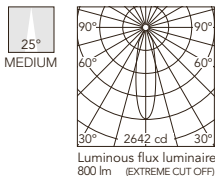

Beam Angle: 25°

h(m)	E(lx)	D(m)
1	2642	0.45
2	661	0.89
3	294	1.34
4	165	1.79
5	106	2.23

- Easy Kap Ø80
■ 03.4192.74
Easy Kap Ø80 Plus
■ 05.7430.74

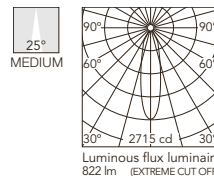

Beam Angle: 25°

h(m)	E(lx)	D(m)
1	2715	0.45
2	679	0.89
3	302	1.34
4	170	1.79
5	109	2.23

- Easy Kap Ø80
■ 03.4193.CU
Easy Kap Ø80 Plus
■ 05.7431.CU

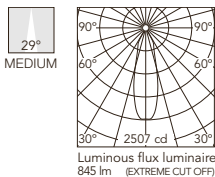

Beam Angle: 29°

h(m)	E(lx)	D(m)
1	2507	0.51
2	627	1.03
3	279	1.54
4	157	2.05
5	100	2.57

- Easy Kap Ø80
■ 03.4192.CU
Easy Kap Ø80 Plus
■ 05.7430.CU

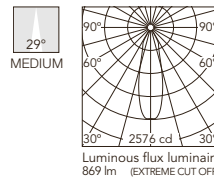

Beam Angle: 29°

h(m)	E(lx)	D(m)
1	2576	0.51
2	644	1.03
3	286	1.54
4	161	2.05
5	103	2.57

Easy Kap Ø80 Fixed - Optic Medium - Dim To Warm

Light Source: LED Array 13W - 1800K - 2850K/CRI 95 - Dim To Warm

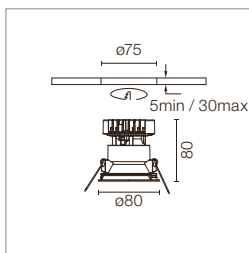

GWT 850°
 IP 54
 0,24 Kg
 0,03
 LED INCL
 CE
 h=91 min
 ICFEE SCHIEMER

Incasso a LED. Fonte di alimentazione 220-240V e dimmerabile 1-10V inclusa. Per versioni con apparecchi a 110V, contattare il Front office. Cornice di installazione non necessaria. Lente diffusore incluso.

Recessed luminaire with LED light source. 220-240V & dimmable 1-10V power supply included. For 110V PSU versions, please consult with the front office. Installation frame not necessary. Diffusing lens included.

1800K-2850K
 03.4192.B1.LE

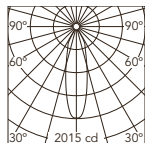

Beam Angle: 27°

h(m)	E(lx)	D(m)
1	2015	0.49
2	504	0.98
3	224	1.46
4	126	1.95
5	81	2.44

Luminous flux luminaire
 735 lm (EXTREME CUT OFF)

03.4192.GL.LE

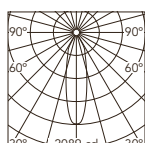

Beam Angle: 27°

h(m)	E(lx)	D(m)
1	2089	0.47
2	522	0.95
3	232	1.42
4	131	1.89
5	84	2.37

Luminous flux luminaire
 705 lm (EXTREME CUT OFF)

03.4192.BU.LE

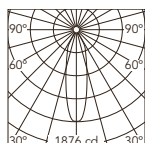

Beam Angle: 27°

h(m)	E(lx)	D(m)
1	1876	0.48
2	469	0.96
3	208	1.44
4	117	1.92
5	75	2.40

Luminous flux luminaire
 641 lm (EXTREME CUT OFF)

03.4192.74.LE

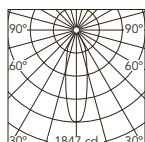

Beam Angle: 28°

h(m)	E(lx)	D(m)
1	1847	0.49
2	462	0.98
3	205	1.47
4	115	1.96
5	74	2.45

Luminous flux luminaire
 637 lm (EXTREME CUT OFF)

03.4192.CU.LE

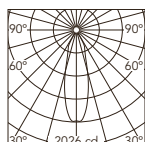

Beam Angle: 29°

h(m)	E(lx)	D(m)
1	2026	0.52
2	506	1.04
3	225	1.56
4	127	2.09
5	81	2.61

Luminous flux luminaire
 698 lm (EXTREME CUT OFF)

KAP

Easy Kap Ø80/Easy Kap Ø80 Plus - Fixed - Optic Flood

Light Source: Easy Kap Ø80: LED Array DC 500 mA - 9,2W - 935 lm - 2700K/CRI 90 / 9,2W - 974 lm - 3000K/CRI 90

Easy Kap Ø80 Plus: LED Array DC 700 mA - 13W - 1370 lm - 2700K/CRI 90 / 13W - 1460 lm - 3000K/CRI 90

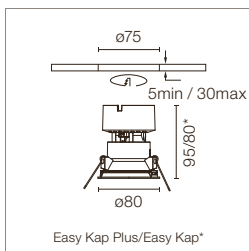

- GWT 850°
- IP 54
- 0,24 Kg
-
-
-
-

Incasto a LED. Fonte di alimentazione esclusa. Cornice di installazione non necessaria. Lente diffusore incluso.

Recessed luminaire with LED light source. Power supply not included. Installation frame not necessary. Diffusing lens included.

Alimentazioni raccomandate / Recommended power supply*:

	Easy Kap Ø80	Easy Kap Ø80 Plus
Non Dimmable	60.9160	60.9592
Dimmable 0/1-10V	RF27961	RF27961
Dimmable Dali 2	RF26571	RF26571
Dimmable Dali 2	60.9222	60.9222
Mains Dimming	60.9411	60.9467
Casambi	60.9207	60.9207

* Vedi capitolo Drivers / Refer to the Drivers chapter

2700K

- Easy Kap Ø80
- 03.4298.B1
- Easy Kap Ø80 Plus
- 05.7447.B1

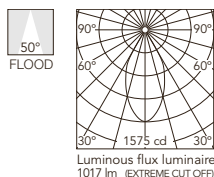

Beam Angle: 50°

h(m)	E(lx)	D(m)
1	1575	0.93
2	394	1.86
3	175	2.79
4	98	3.72
5	63	4.65

3000K

- Easy Kap Ø80
- 03.4297.B1
- Easy Kap Ø80 Plus
- 05.7446.B1

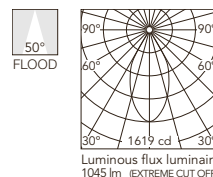

Beam Angle: 50°

h(m)	E(lx)	D(m)
1	1619	0.93
2	405	1.86
3	180	2.79
4	101	3.72
5	65	4.65

- Easy Kap Ø80
- 03.4298.GL
- Easy Kap Ø80 Plus
- 05.7447.GL

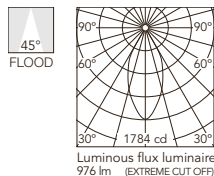

Beam Angle: 45°

h(m)	E(lx)	D(m)
1	1784	0.83
2	446	1.66
3	198	2.48
4	111	3.31
5	71	4.14

- Easy Kap Ø80
- 03.4297.GL
- Easy Kap Ø80 Plus
- 05.7446.GL

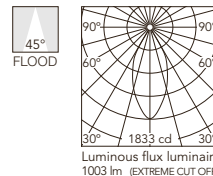

Beam Angle: 45°

h(m)	E(lx)	D(m)
1	1833	0.83
2	458	1.66
3	204	2.48
4	115	3.31
5	73	4.14

- Easy Kap Ø80
- 03.4298.BU
- Easy Kap Ø80 Plus
- 05.7447.BU

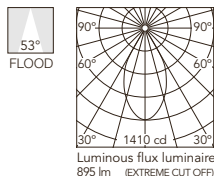

Beam Angle: 53°

h(m)	E(lx)	D(m)
1	1410	1.00
2	352	2.01
3	157	3.01
4	88	4.02
5	56	5.02

- Easy Kap Ø80
- 03.4297.BU
- Easy Kap Ø80 Plus
- 05.7446.BU

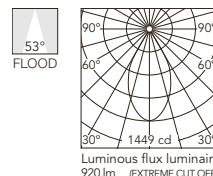

Beam Angle: 53°

h(m)	E(lx)	D(m)
1	1449	1.00
2	362	2.01
3	161	3.01
4	91	4.02
5	58	5.02

- Easy Kap Ø80
- 03.4298.74
- Easy Kap Ø80 Plus
- 05.7447.74

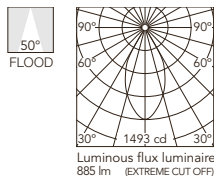

Beam Angle: 50°

h(m)	E(lx)	D(m)
1	1493	0.94
2	373	1.89
3	166	2.83
4	93	3.77
5	60	4.72

- Easy Kap Ø80
- 03.4297.74
- Easy Kap Ø80 Plus
- 05.7446.74

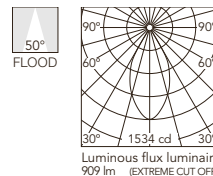

Beam Angle: 50°

h(m)	E(lx)	D(m)
1	1534	0.94
2	384	1.89
3	170	2.83
4	96	3.77
5	61	4.72

- Easy Kap Ø80
- 03.4298.CU
- Easy Kap Ø80 Plus
- 05.7447.CU

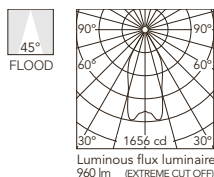

Beam Angle: 45°

h(m)	E(lx)	D(m)
1	1656	0.83
2	414	1.66
3	184	2.49
4	103	3.32
5	66	4.14

- Easy Kap Ø80
- 03.4297.CU
- Easy Kap Ø80 Plus
- 05.7446.CU

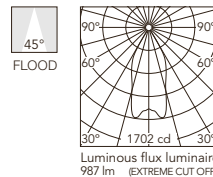

Beam Angle: 45°

h(m)	E(lx)	D(m)
1	1702	0.83
2	425	1.66
3	189	2.49
4	106	3.32
5	68	4.14

Easy Kap Ø80 Fixed - Optic Flood - Dim To Warm

Light Source: LED Array 13W - 1800K - 2850K/CRI 95 - Dim To Warm

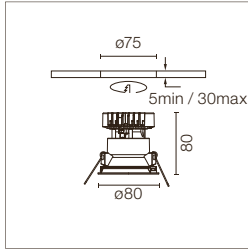

	GWT 850°	IP 54
	0,24 Kg	
	h=91 min	

Incasso a LED. Fonte di alimentazione 220-240V e dimmerabile 1-10V inclusa. Per versioni con apparecchi a 110V, contattare il Front office. Cornice di installazione non necessaria. Lente diffusore incluso.

Recessed luminaire with LED light source. 220-240V & dimmable 1-10V power supply included. For 110V PSU versions, please consult with the front office. Installation frame not necessary. Diffusing lens included.

1800K-2850K
03.4297.B1.LE

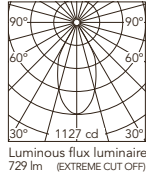

Beam Angle: 49°

h(m)	E(lx)	D(m)
1	1127	0.92
2	282	1.83
3	125	2.75
4	70	3.67
5	45	4.59

03.4297.GL.LE

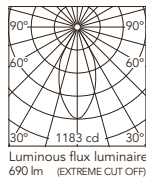

Beam Angle: 47°

h(m)	E(lx)	D(m)
1	1183	0.87
2	296	1.75
3	131	2.62
4	74	3.50
5	47	4.37

03.4297.BU.LE

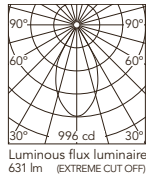

Beam Angle: 53°

h(m)	E(lx)	D(m)
1	996	1.00
2	249	1.99
3	111	2.99
4	62	3.98
5	40	4.98

03.4297.74.LE

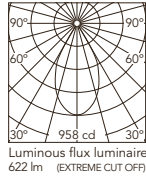

Beam Angle: 54°

h(m)	E(lx)	D(m)
1	958	1.02
2	239	2.04
3	106	3.06
4	60	4.09
5	38	5.11

03.4297.CU.LE

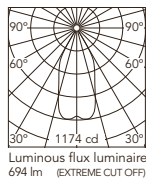

Beam Angle: 46°

h(m)	E(lx)	D(m)
1	1174	0.86
2	293	1.71
3	130	2.57
4	73	3.42
5	47	4.28

KAP

Easy Kap 80 Square/Easy Kap 80 Square Plus - Fixed - Optic Spot

Light Source: Easy Kap 80 Square: LED Array DC 500 mA - 9,2W - 935 lm - 2700K/CRI 90 / 9,2W - 974 lm - 3000K/CRI 90

Easy Kap 80 Square Plus: LED Array DC 700 mA - 13W - 1370 lm - 2700K/CRI 90 / 13W - 1460 lm - 3000K/CRI 90

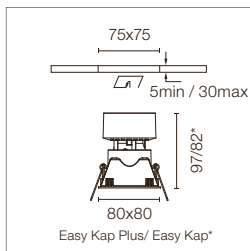

- GWT 850°
- IP 54
- 0,24 Kg
- Easy Kap 80
- Easy Kap 80 Plus
- LED INCL
- CE
- III

Incasso a LED. Fonte di alimentazione esclusa. Cornice di installazione non necessaria. Lente diffusore incluso.

Recessed luminaire with LED light source. Power supply not included. Installation frame not necessary. Diffusing lens included.

Alimentazioni raccomandate / Recommended power supply*:

	Easy Kap 80	Easy Kap 80 Plus
Non Dimmable	60.9160	60.9592
Dimmable 0/1-10V	RF27961	RF27961
Dimmable Dali 1	RF26571	RF26571
Dimmable Dali 2	60.9222	60.9222
Mains Dimming	60.9411	60.9467
Casambi	60.9207	60.9207

* Vedi capitolo Drivers / Refer to the Drivers chapter

- 2700K**
- Easy Kap 80 Square
 - 03.4177.B1
 - Easy Kap 80 Plus Square
 - 05.7407.B1

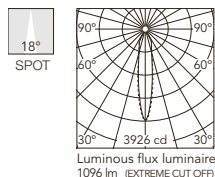

Beam Angle: 18°

h(m)	E(lx)	D(m)
1	3926	0.31
2	981	0.62
3	436	0.94
4	245	1.25
5	157	1.56

- 3000K**
- Easy Kap 80 Square
 - 03.4176.B1
 - Easy Kap 80 Plus Square
 - 05.7406.B1

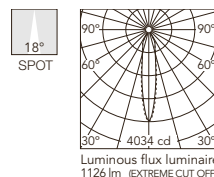

Beam Angle: 18°

h(m)	E(lx)	D(m)
1	4034	0.31
2	1009	0.62
3	448	0.94
4	252	1.25
5	161	1.56

- Easy Kap 80 Square
- 03.4177.GL
- Easy Kap 80 Plus Square
- 05.7407.GL

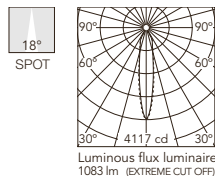

Beam Angle: 18°

h(m)	E(lx)	D(m)
1	4117	0.31
2	1029	0.63
3	457	0.94
4	257	1.26
5	165	1.57

- Easy Kap 80 Square
- 03.4176.GL
- Easy Kap 80 Plus Square
- 05.7406.GL

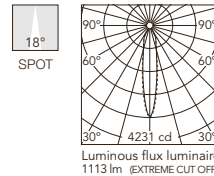

Beam Angle: 18°

h(m)	E(lx)	D(m)
1	4231	0.31
2	1058	0.63
3	470	0.94
4	264	1.26
5	169	1.57

- Easy Kap 80 Square
- 03.4177.BU
- Easy Kap 80 Plus Square
- 05.7407.BU

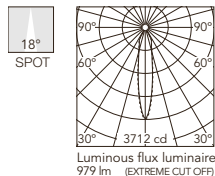

Beam Angle: 18°

h(m)	E(lx)	D(m)
1	3712	0.32
2	928	0.64
3	412	0.96
4	232	1.28
5	148	1.60

- Easy Kap 80 Square
- 03.4176.BU
- Easy Kap 80 Plus Square
- 05.7406.BU

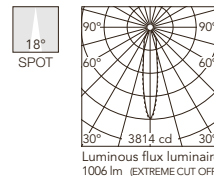

Beam Angle: 18°

h(m)	E(lx)	D(m)
1	3814	0.32
2	954	0.64
3	424	0.96
4	238	1.28
5	153	1.60

- Easy Kap 80 Square
- 03.4177.74
- Easy Kap 80 Plus Square
- 05.7407.74

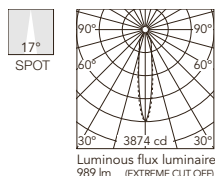

Beam Angle: 17°

h(m)	E(lx)	D(m)
1	3874	0.30
2	969	0.60
3	430	0.90
4	242	1.20
5	155	1.50

- Easy Kap 80 Square
- 03.4176.74
- Easy Kap 80 Plus Square
- 05.7406.74

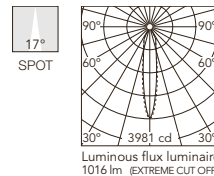

Beam Angle: 17°

h(m)	E(lx)	D(m)
1	3981	0.30
2	995	0.60
3	442	0.90
4	249	1.20
5	159	1.50

- Easy Kap 80 Square
- 03.4177.CU
- Easy Kap 80 Plus Square
- 05.7407.CU

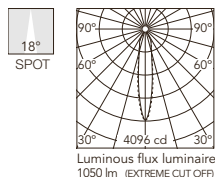

Beam Angle: 18°

h(m)	E(lx)	D(m)
1	4096	0.31
2	1024	0.62
3	455	0.94
4	256	1.25
5	164	1.56

- Easy Kap 80 Square
- 03.4176.CU
- Easy Kap 80 Plus Square
- 05.7406.CU

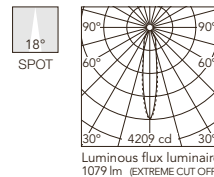

Beam Angle: 18°

h(m)	E(lx)	D(m)
1	4209	0.31
2	1052	0.62
3	468	0.94
4	263	1.25
5	168	1.56

Easy Kap 80 Square Fixed - Optic Spot - Dim To Warm

Light Source: LED Array 13W - 1800K - 2850K/CRI 95 - Dim To Warm

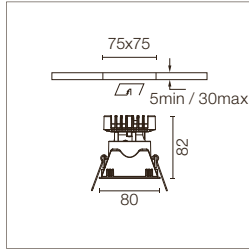

	GWT 850°		IP 54
	0,24 Kg		E03
	h=93 min		LED INCL
	CE		ICFEE SCHIEMER

Incasso a LED. Fonte di alimentazione 220-240V e dimmerabile 1-10V inclusa.
Per versioni con apparecchi a 110V, contattare il Front office.
Cornice di installazione non necessaria.
Lente diffusore incluso.

Recessed luminaire with LED light source. 220-240V & dimmable 1-10V power supply included.
For 110V PSU versions, please consult with the front office.
Installation frame not necessary.
Diffusing lens included.

1800K-2850K
03.4176.B1.LE

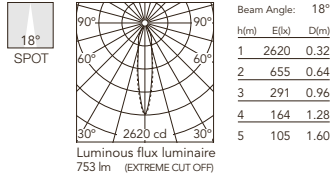

03.4176.GL.LE

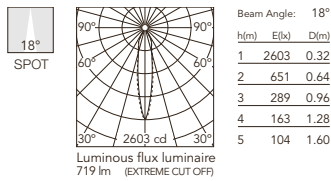

03.4176.BU.LE

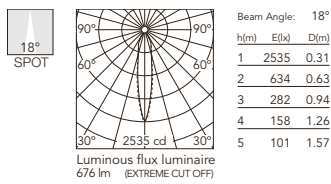

03.4176.74.LE

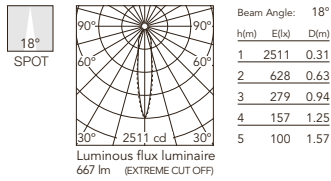

03.4176.CU.LE

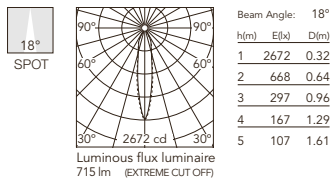

KAP

Easy Kap 80 Square/Easy Kap 80 Square Plus - Fixed - Optic Medium

Light Source: **Easy Kap 80 Square** LED Array DC 500 mA - 9,2W - 935 lm - 2700K/CRI 90 / 9,2W - 974 lm - 3000K/CRI 90

Easy Kap 80 Square Plus: LED Array DC 700 mA - 13W - 1370 lm - 2700K/CRI 90 / 13W - 1460 lm - 3000K/CRI 90

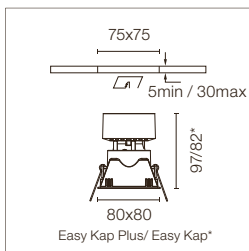

Incasso a LED. Fonte di alimentazione esclusa. Cornice di installazione non necessaria. Lente diffusore incluso.

Recessed luminaire with LED light source. Power supply not included. Installation frame not necessary. Diffusing lens included.

Alimentazioni raccomandate / Recommended power supply*:

	Easy Kap 80	Easy Kap 80 Plus
Non Dimmable	60.9160	60.9592
Dimmable 0/1-10V	RF27961	RF27961
Dimmable Dali 1	RF26571	RF26571
Dimmable Dali 2	60.9222	60.9222
Mains Dimming	60.9411	60.9467
Casambi	60.9207	60.9207

* Vedi capitolo Drivers / Refer to the Drivers chapter

- 2700K**
- Easy Kap 80 Square
 - 03.4195.B1
 - Easy Kap 80 Plus Square
 - 05.7433.B1

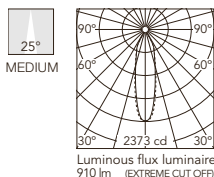

Beam Angle: 25°

h(m)	E(lx)	D(m)
1	2373	0.45
2	593	0.90
3	264	1.34
4	148	1.79
5	95	2.24

Luminous flux luminaire 910 lm (EXTREME CUT OFF)

- 3000K**
- Easy Kap 80 Square
 - 03.4194.B1
 - Easy Kap 80 Plus Square
 - 05.7432.B1

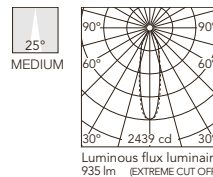

Beam Angle: 25°

h(m)	E(lx)	D(m)
1	2439	0.45
2	610	0.90
3	271	1.34
4	152	1.79
5	98	2.24

Luminous flux luminaire 935 lm (EXTREME CUT OFF)

- Easy Kap 80 Square
- 03.4195.GL
- Easy Kap 80 Plus Square
- 05.7433.GL

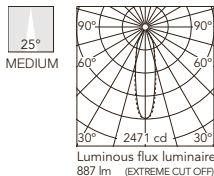

Beam Angle: 25°

h(m)	E(lx)	D(m)
1	2471	0.45
2	618	0.90
3	275	1.34
4	154	1.79
5	99	2.24

Luminous flux luminaire 887 lm (EXTREME CUT OFF)

- Easy Kap 80 Square
- 03.4194.GL
- Easy Kap 80 Plus Square
- 05.7432.GL

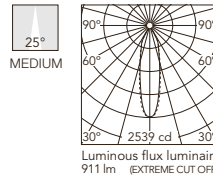

Beam Angle: 25°

h(m)	E(lx)	D(m)
1	2539	0.45
2	635	0.90
3	282	1.34
4	159	1.79
5	102	2.24

Luminous flux luminaire 911 lm (EXTREME CUT OFF)

- Easy Kap 80 Square
- 03.4195.BU
- Easy Kap 80 Plus Square
- 05.7433.BU

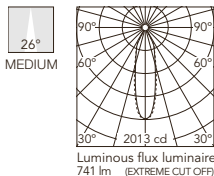

Beam Angle: 26°

h(m)	E(lx)	D(m)
1	2013	0.45
2	503	0.91
3	224	1.36
4	126	1.82
5	81	2.27

Luminous flux luminaire 741 lm (EXTREME CUT OFF)

- Easy Kap 80 Square
- 03.4194.BU
- Easy Kap 80 Plus Square
- 05.7432.BU

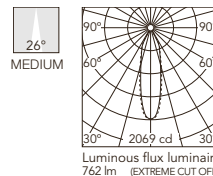

Beam Angle: 26°

h(m)	E(lx)	D(m)
1	2069	0.45
2	517	0.91
3	230	1.36
4	129	1.82
5	83	2.27

Luminous flux luminaire 762 lm (EXTREME CUT OFF)

- Easy Kap 80 Square
- 03.4195.74
- Easy Kap 80 Plus Square
- 05.7433.74

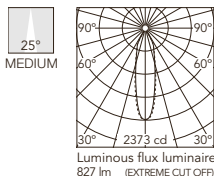

Beam Angle: 25°

h(m)	E(lx)	D(m)
1	2373	0.44
2	593	0.88
3	264	1.32
4	148	1.76
5	95	2.20

Luminous flux luminaire 827 lm (EXTREME CUT OFF)

- Easy Kap 80 Square
- 03.4194.74
- Easy Kap 80 Plus Square
- 05.7432.74

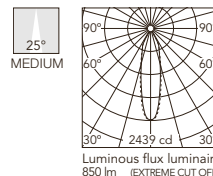

Beam Angle: 25°

h(m)	E(lx)	D(m)
1	2439	0.44
2	610	0.88
3	271	1.32
4	152	1.76
5	98	2.20

Luminous flux luminaire 850 lm (EXTREME CUT OFF)

- Easy Kap 80 Square
- 03.4195.CU
- Easy Kap 80 Plus Square
- 05.7433.CU

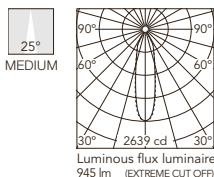

Beam Angle: 25°

h(m)	E(lx)	D(m)
1	2639	0.44
2	660	0.88
3	293	1.32
4	165	1.75
5	106	2.19

Luminous flux luminaire 945 lm (EXTREME CUT OFF)
@Easy Kap 80 Plus

- Easy Kap 80 Square
- 03.4194.CU
- Easy Kap 80 Plus Square
- 05.7432.CU

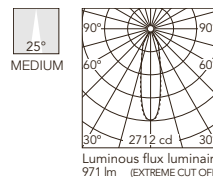

Beam Angle: 25°

h(m)	E(lx)	D(m)
1	2712	0.44
2	678	0.88
3	301	1.32
4	169	1.75
5	108	2.19

Luminous flux luminaire 971 lm (EXTREME CUT OFF)
@ Easy Kap 80 Plus

Easy Kap 80 Square Fixed - Optic Medium - Dim To Warm

Light Source: LED Array 13W - 1800K - 2850K/CRI 95 - Dim To Warm

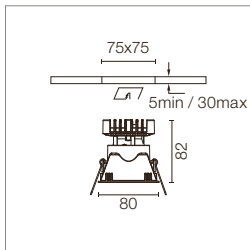

GWT 850°
 IP 54
 0.24 Kg
 0.03
 h=93 min
 CE
 LED INCL
 ICFEE SCHIEME

Incasso a LED. Fonte di alimentazione 220-240V e dimmerabile 1-10V inclusa. Per versioni con apparecchi a 110V, contattare il Front office. Cornice di installazione non necessaria. Lente diffusore incluso.

Recessed luminaire with LED light source. 220-240V & dimmable 1-10V power supply included. For 110V PSU versions, please consult with the front office. Installation frame not necessary. Diffusing lens included.

1800K-2850K
 03.4194.B1.LE

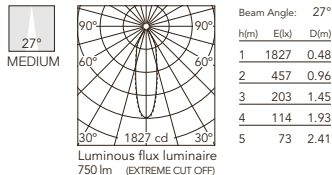

03.4194.GL.LE

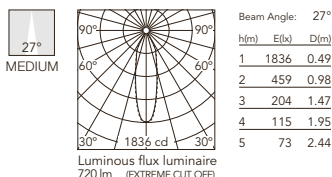

03.4194.BU.LE

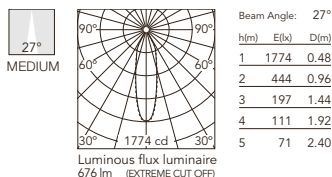

03.4194.74.LE

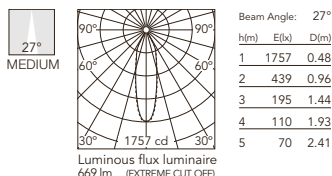

03.4194.CU.LE

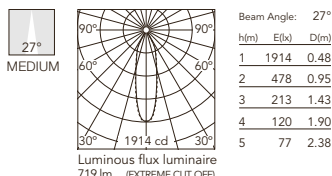

KAP

Easy Kap 80 Square/Easy Kap 80 Square Plus - Fixed - Optic Flood

Light Source: Easy Kap 80 Square: LED Array DC 500 mA - 9,2W - 935 lm - 2700K/CRI 90 / 9,2W - 974 lm - 3000K/CRI 90

Easy Kap 80 Square Plus: LED Array DC 700 mA - 13W - 1370 lm - 2700K/CRI 90 / 13W - 1460 lm - 3000K/CRI 90

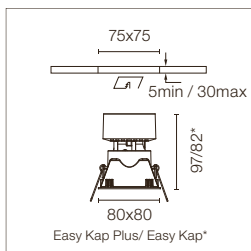

Incasso a LED. Fonte di alimentazione esclusa. Cornice di installazione non necessaria. Lente diffusore incluso.

Recessed luminaire with LED light source. Power supply not included. Installation frame not necessary. Diffusing lens included.

Alimentazioni raccomandate / Recommended power supply*:

	Easy Kap 80	Easy Kap 80 Plus
Non Dimmable	60.9160	60.9592
Dimmable 0/1-10V	RF27961	RF27961
Dimmable Dali 1	RF26571	RF26571
Dimmable Dali 2	60.9222	60.9222
Mains Dimming	60.9411	60.9467
Casambi	60.9207	60.9207

* Vedi capitolo Drivers / Refer to the Drivers chapter

2700K

- Easy Kap 80 Square
- 03.4179.B1
- Easy Kap 80 Plus Square
- 05.7409.B1

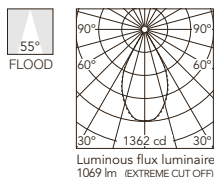

Beam Angle: 55°

h(m)	E(lx)	D(m)
1	1362	1.03
2	340	2.07
3	151	3.10
4	85	4.14
5	54	5.17

3000K

- Easy Kap 80 Square
- 03.4178.B1
- Easy Kap 80 Plus Square
- 05.7408.B1

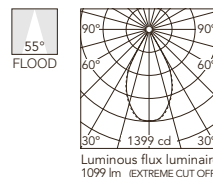

Beam Angle: 55°

h(m)	E(lx)	D(m)
1	1399	1.03
2	350	2.07
3	155	3.10
4	87	4.14
5	56	5.17

- Easy Kap 80 Square
- 03.4179.GL
- Easy Kap 80 Plus Square
- 05.7409.GL

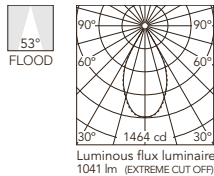

Beam Angle: 53°

h(m)	E(lx)	D(m)
1	1464	1.00
2	366	2.00
3	163	3.00
4	92	4.00
5	59	5.01

- Easy Kap 80 Square
- 03.4178.GL
- Easy Kap 80 Plus Square
- 05.7408.GL

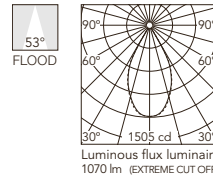

Beam Angle: 53°

h(m)	E(lx)	D(m)
1	1505	1.00
2	376	2.00
3	167	3.00
4	94	4.00
5	60	5.01

- Easy Kap 80 Square
- 03.4179.BU
- Easy Kap 80 Plus Square
- 05.7409.BU

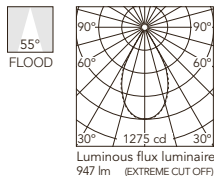

Beam Angle: 55°

h(m)	E(lx)	D(m)
1	1275	1.04
2	319	2.09
3	142	3.13
4	80	4.18
5	51	5.22

- Easy Kap 80 Square
- 03.4178.BU
- Easy Kap 80 Plus Square
- 05.7408.BU

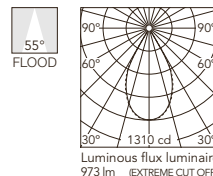

Beam Angle: 55°

h(m)	E(lx)	D(m)
1	1310	1.04
2	327	2.09
3	146	3.13
4	82	4.18
5	52	5.22

- Easy Kap 80 Square
- 03.4179.74
- Easy Kap 80 Plus Square
- 05.7409.74

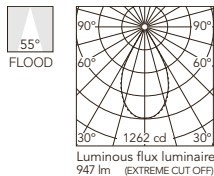

Beam Angle: 55°

h(m)	E(lx)	D(m)
1	1262	1.05
2	315	2.10
3	140	3.16
4	79	4.21
5	50	5.26

- Easy Kap 80 Square
- 03.4178.74
- Easy Kap 80 Plus Square
- 05.7408.74

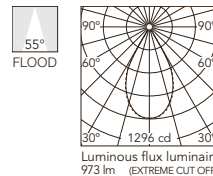

Beam Angle: 55°

h(m)	E(lx)	D(m)
1	1296	1.05
2	324	2.10
3	144	3.16
4	81	4.21
5	52	5.26

- Easy Kap 80 Square
- 03.4179.CU
- Easy Kap 80 Plus Square
- 05.7409.CU

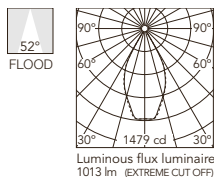

Beam Angle: 52°

h(m)	E(lx)	D(m)
1	1479	0.97
2	370	1.93
3	164	2.90
4	92	3.87
5	59	4.84

- Easy Kap 80 Square
- 03.4178.CU
- Easy Kap 80 Plus Square
- 05.7408.CU

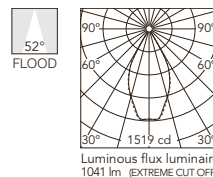

Beam Angle: 52°

h(m)	E(lx)	D(m)
1	1519	0.97
2	380	1.93
3	169	2.90
4	95	3.87
5	61	4.84

Easy Kap 80 Square Fixed - Optic Flood - Dim To Warm

Light Source: LED Array 13W - 1800K - 2850K/CRI 95 - Dim To Warm

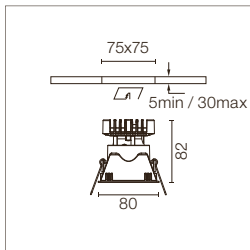

	GWT 850°		IP 54
	0,24 Kg		30°
	ICCF SCHIEMER		LED INCL
	CE		

Incasso a LED. Fonte di alimentazione 220-240V e dimmerabile 1-10V inclusa. Per versioni con apparecchi a 110V, contattare il Front office. Cornice di installazione non necessaria. Lente diffusore incluso.

Recessed luminaire with LED light source. 220-240V & dimmable 1-10V power supply included. For 110V PSU versions, please consult with the front office. Installation frame not necessary. Diffusing lens included.

1800K-2850K
03.4178.B1.LE

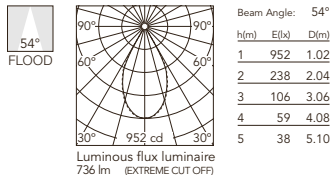

03.4178.GL.LE

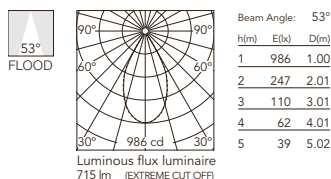

03.4178.BU.LE

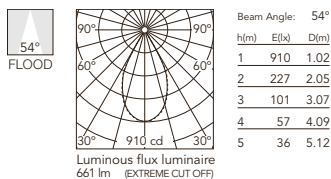

03.4178.74.LE

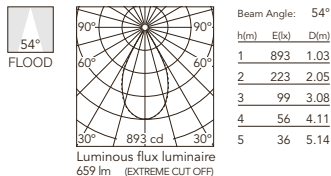

03.4178.CU.LE

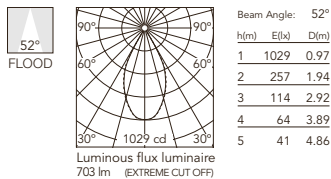

Easy Kap Ø80 Fixed

Light Source: LED QR-CBC 51 GX5.3

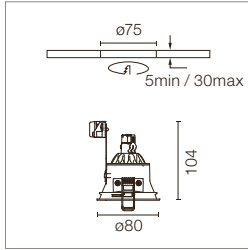

GWT 850°
 0,12 Kg

 IP 23
 h=130 min

Incasto per lampada di 12V.
 Trasformatore remoto non incluso.
 Cornice di installazione non necessaria.
 Accessori per lenti non disponibili.

Recessed 12V lamp luminaire.
 Remote transformer not included.
 Installation frame not necessary.
 Not suitable for lens accessories.

- 03.4210.B1
- 03.4210.GL
- 03.4210.BU
- 03.4210.74
- 03.4210.CU

Easy Kap 80 Square Fixed

Light Source: LED QR-CBC 51 GX5.3

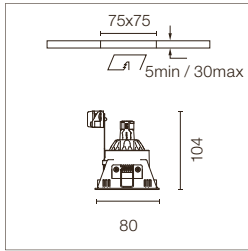

GWT 850°
 0,12 Kg

 IP 23
 h=130 min

Incasto per lampada di 12V.
 Trasformatore remoto non incluso.
 Cornice di installazione non necessaria.
 Accessori per lenti non disponibili.

Recessed 12V lamp luminaire.
 Remote transformer not included.
 Installation frame not necessary.
 Not suitable for lens accessories.

- 03.4208.B1
- 03.4208.GL
- 03.4208.BU
- 03.4208.74
- 03.4208.CU

Easy Kap Ø80 Fixed

Light Source: LED PAR 16 GZ10

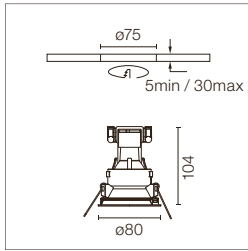

GWT 850°
 0,12 Kg
 IP 23
 h=155 min

Incasto con alimentazione in tensione di rete.
 Cornice di installazione non necessaria.
 Accessori per lenti non disponibili.

Recessed luminaire with main voltage source.
 Installation frame not necessary.
 Not suitable for lens accessories.

- 03.4211.B1
- 03.4211.GL
- 03.4211.BU
- 03.4211.74
- 03.4211.CU

Easy Kap 80 Square Fixed

Light Source: LED PAR 16 GZ10

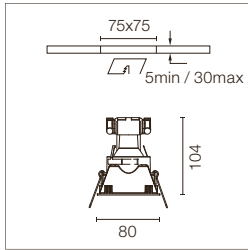

GWT 850°
 0,12 Kg
 IP 23
 h=155 min

Incasto con alimentazione in tensione di rete.
 Cornice di installazione non necessaria.
 Accessori per lenti non disponibili.

Recessed luminaire with main voltage source.
 Installation frame not necessary.
 Not suitable for lens accessories.

- 03.4209.B1
- 03.4209.GL
- 03.4209.BU
- 03.4209.74
- 03.4209.CU

Easy Kap Ø80/Easy Kap Ø80 Plus - Adjustable - Optic Spot

Light Source: Easy Kap Ø80: LED Array DC 500 mA - 9,2W - 935 lm - 2700K/CRI 90 / 9,2W - 974 lm - 3000K/CRI 90
Easy Kap Ø80 Plus: LED Array DC 700 mA - 13W - 1370 lm - 2700K/CRI 90 / 13W - 1460 lm - 3000K/CRI 90

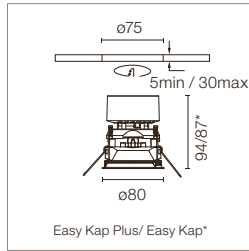

IP 54
 GWT 850°
 360°
 0,24 Kg
 h=150 min
 h=91 min
 LED INCL

Incasso a LED. Fonte di alimentazione esclusa. Cornice di installazione non necessaria. Lente diffusore incluso.

Recessed luminaire with LED light source. Power supply not included. Installation frame not necessary. Diffusing lens included.

Alimentazioni raccomandate / Recommended power supply*:

	Easy Kap Ø80	Easy Kap Ø80 Plus
Non Dimmable	60.9160	60.9592
Dimmable 0/1-10V	RF27961	RF27961
Dimmable Dali 1	RF26571	RF26571
Dimmable Dali 2	60.9222	60.9222
Mains Dimming	60.9411	60.9467
Casambi	60.9207	60.9207

* Vedi capitolo Drivers / Refer to the Drivers chapter

- 2700K**
 Easy Kap Ø80
 03.4153.B1
 Easy Kap Ø80 Plus
 05.7400.B1

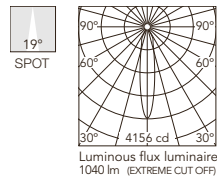

Beam Angle: 19°

h(m)	E(lx)	D(m)
1	4156	0.33
2	1039	0.66
3	462	0.99
4	260	1.33
5	166	1.66

- 3000K**
 Easy Kap Ø80
 03.4170.B1
 Easy Kap Ø80 Plus
 05.7403.B1

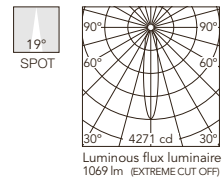

Beam Angle: 19°

h(m)	E(lx)	D(m)
1	4271	0.33
2	1068	0.66
3	475	0.99
4	267	1.33
5	171	1.66

- Easy Kap Ø80
 03.4153.GL
 Easy Kap Ø80 Plus
 05.7400.GL

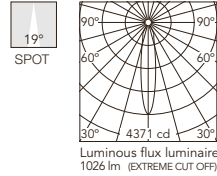

Beam Angle: 19°

h(m)	E(lx)	D(m)
1	4371	0.33
2	1093	0.66
3	486	0.99
4	273	1.32
5	175	1.65

- Easy Kap Ø80
 03.4170.GL
 Easy Kap Ø80 Plus
 05.7403.GL

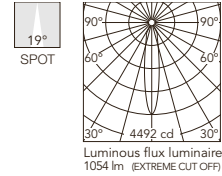

Beam Angle: 19°

h(m)	E(lx)	D(m)
1	4492	0.33
2	1123	0.66
3	499	0.99
4	281	1.32
5	180	1.65

- Easy Kap Ø80
 03.4153.BU
 Easy Kap Ø80 Plus
 05.7400.BU

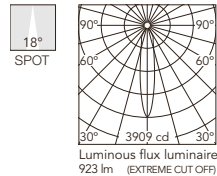

Beam Angle: 18°

h(m)	E(lx)	D(m)
1	3909	0.32
2	977	0.65
3	434	0.97
4	244	1.30
5	156	1.62

- Easy Kap Ø80
 03.4170.BU
 Easy Kap Ø80 Plus
 05.7403.BU

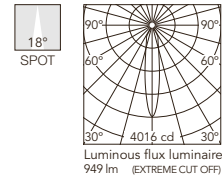

Beam Angle: 18°

h(m)	E(lx)	D(m)
1	4016	0.32
2	1024	0.65
3	446	0.97
4	251	1.30
5	161	1.62

- Easy Kap Ø80
 03.4153.74
 Easy Kap Ø80 Plus
 05.7400.74

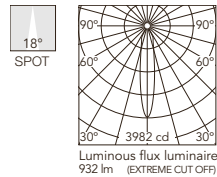

Beam Angle: 18°

h(m)	E(lx)	D(m)
1	3982	0.32
2	996	0.65
3	442	0.97
4	249	1.30
5	159	1.62

- Easy Kap Ø80
 03.4170.74
 Easy Kap Ø80 Plus
 05.7403.74

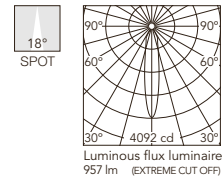

Beam Angle: 18°

h(m)	E(lx)	D(m)
1	4092	0.32
2	1023	0.65
3	455	0.97
4	256	1.30
5	164	1.62

- Easy Kap Ø80
 03.4153.CU
 Easy Kap Ø80 Plus
 05.7400.CU

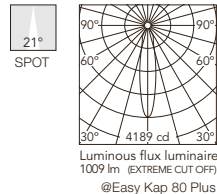

Beam Angle: 21°

h(m)	E(lx)	D(m)
1	4189	0.36
2	1047	0.72
3	465	1.09
4	262	1.45
5	168	1.81

- Easy Kap Ø80
 03.4170.CU
 Easy Kap Ø80 Plus
 05.7403.CU

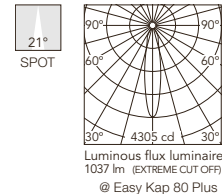

Beam Angle: 21°

h(m)	E(lx)	D(m)
1	4305	0.36
2	1076	0.72
3	478	1.09
4	269	1.45
5	172	1.81

Easy Kap Ø80 Adjustable - Optic Spot - Dim To Warm

Light Source: LED Array 13W - 1800K - 2850K/CRI 95 - Dim To Warm

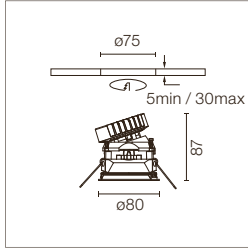

Incasso a LED. Fonte di alimentazione 220-240V e dimmerabile 1-10V inclusa. Per versioni con apparecchi a 110V, contattare il Front office. Cornice di installazione non necessaria. Lente diffusore incluso.

Recessed luminaire with LED light source. 220-240V & dimmable 1-10V power supply included. For 110V PSU versions, please consult with the front office. Installation frame not necessary. Diffusing lens included.

1800K-2850K
03.4170.B1.LE

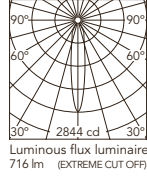

Beam Angle: 18°

h(m)	E(lx)	D(m)
1	2844	0.31
2	711	0.63
3	316	0.94
4	178	1.25
5	114	1.56

03.4170.GL.LE

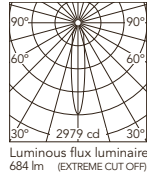

Beam Angle: 17°

h(m)	E(lx)	D(m)
1	2979	0.30
2	745	0.61
3	331	0.91
4	186	1.21
5	119	1.52

03.4170.BU.LE

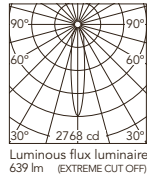

Beam Angle: 17°

h(m)	E(lx)	D(m)
1	2768	0.31
2	692	0.61
3	308	0.92
4	173	1.22
5	111	1.53

03.4170.74.LE

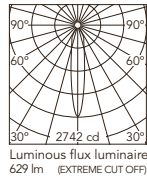

Beam Angle: 17°

h(m)	E(lx)	D(m)
1	2742	0.31
2	686	0.61
3	305	0.92
4	171	1.22
5	110	1.53

03.4170.CU.LE

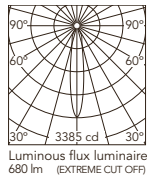

Beam Angle: 17°

h(m)	E(lx)	D(m)
1	3385	0.30
2	846	0.60
3	376	0.90
4	212	1.20
5	135	1.50

Easy Kap Ø80 Adjustable - Optic Medium - Dim To Warm

Light Source: LED Array 13W - 1800K - 2850K/CRI 95 - Dim To Warm

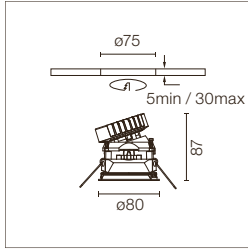

Incasso a LED. Fonte di alimentazione 220-240V e dimmerabile 1-10V inclusa. Per versioni con apparecchi a 110V, contattare il Front office. Cornice di installazione non necessaria. Lente diffusore incluso.

Recessed luminaire with LED light source. 220-240V & dimmable 1-10V power supply included. For 110V PSU versions, please consult with the front office. Installation frame not necessary. Diffusing lens included.

1800K-2850K
 03.4171.B1.LE

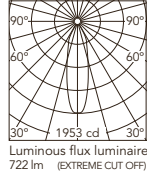

Beam Angle: 27°

h(m)	E(lx)	D(m)
1	1953	0.48
2	488	0.97
3	217	1.45
4	122	1.94
5	78	2.42

03.4171.GL.LE

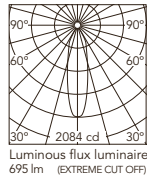

Beam Angle: 26°

h(m)	E(lx)	D(m)
1	2084	0.46
2	521	0.92
3	232	1.38
4	130	1.85
5	83	2.31

03.4171.BU.LE

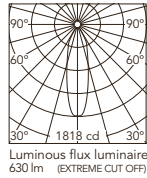

Beam Angle: 28°

h(m)	E(lx)	D(m)
1	1818	0.49
2	454	0.98
3	202	1.47
4	114	1.96
5	73	2.45

03.4171.74.LE

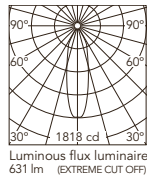

Beam Angle: 28°

h(m)	E(lx)	D(m)
1	1818	0.49
2	455	0.99
3	202	1.48
4	114	1.97
5	73	2.46

03.4171.CU.LE

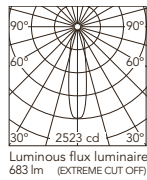

Beam Angle: 22°

h(m)	E(lx)	D(m)
1	2523	0.39
2	631	0.78
3	280	1.17
4	158	1.56
5	101	1.95

Easy Kap Ø80/Easy Kap Ø80 Plus - Adjustable - Optic Flood

Light Source: **Easy Kap Ø80:** LED Array DC 500 mA - 9,2W - 935 lm - 2700K/CRI 90 / 9,2W - 974 lm - 3000K/CRI 90

Easy Kap Ø80 Plus: LED Array DC 700 mA - 13W - 1370 lm - 2700K/CRI 90 / 13W - 1460 lm - 3000K/CRI 90

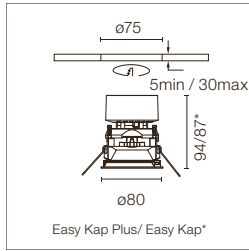

Incasto a LED. Fonte di alimentazione esclusa. Cornice di installazione non necessaria. Lente diffusore incluso.

Recessed luminaire with LED light source. Power supply not included. Installation frame not necessary. Diffusing lens included.

Alimentazioni raccomandate / Recommended power supply*:

	Easy Kap Ø80	Easy Kap Ø80 Plus
Non Dimmable	60.9160	60.9592
Dimmable 0/1-10V	RF27961	RF27961
Dimmable Dali 1	RF26571	RF26571
Dimmable Dali 2	60.9222	60.9222
Mains Dimming	60.9411	60.9467
Casambi	60.9207	60.9207

* Vedi capitolo Drivers / Refer to the Drivers chapter

- 2700K**
Easy Kap Ø80
03.4157.B1
Easy Kap Ø80 Plus
05.7402.B1

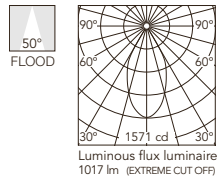

- 3000K**
Easy Kap Ø80
03.4172.B1
Easy Kap Ø80 Plus
05.7405.B1

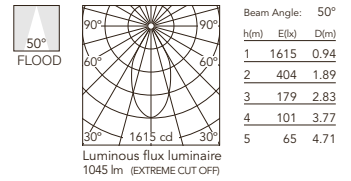

- Easy Kap Ø80
03.4157.GL
Easy Kap Ø80 Plus
05.7402.GL

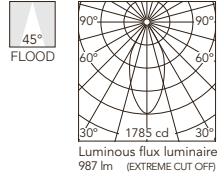

- Easy Kap Ø80
03.4172.GL
Easy Kap Ø80 Plus
05.7405.GL

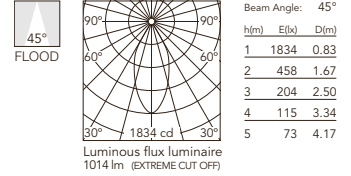

- Easy Kap Ø80
03.4157.BU
Easy Kap Ø80 Plus
05.7402.BU

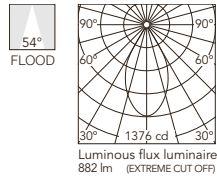

- Easy Kap Ø80
03.4172.BU
Easy Kap Ø80 Plus
05.7405.BU

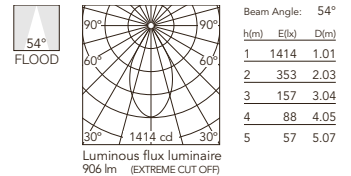

- Easy Kap Ø80
03.4157.74
Easy Kap Ø80 Plus
05.7402.74

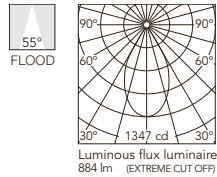

- Easy Kap Ø80
03.4172.74
Easy Kap Ø80 Plus
05.7405.74

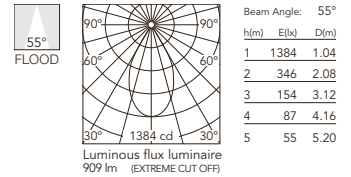

- Easy Kap Ø80
03.4157.CU
Easy Kap Ø80 Plus
05.7402.CU

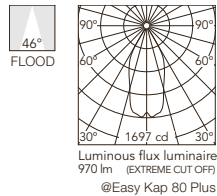

- Easy Kap Ø80
03.4172.CU
Easy Kap Ø80 Plus
05.7405.CU

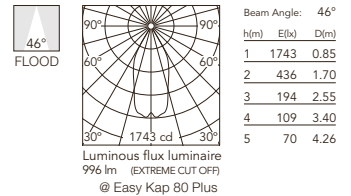

Easy Kap Ø80 Adjustable - Optic Flood - Dim To Warm

Light Source: LED Array 13W - 1800K - 2850K/CRI 95 - Dim To Warm

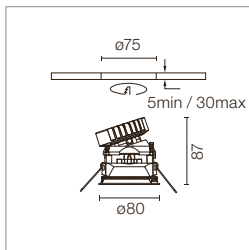

Incasso a LED. Fonte di alimentazione 220-240V e dimmerabile 1-10V inclusa. Per versioni con apparecchi a 110V, contattare il Front office. Cornice di installazione non necessaria. Lente diffusore incluso.

Recessed luminaire with LED light source. 220-240V & dimmable 1-10V power supply included. For 110V PSU versions, please consult with the front office. Installation frame not necessary. Diffusing lens included.

1800K-2850K
03.4172.B1.LE

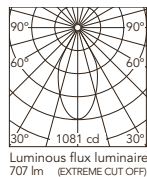

Beam Angle: 51°

h(m)	E(lx)	D(m)
1	1081	0.94
2	270	1.89
3	120	2.83
4	68	3.78
5	43	4.72

Luminous flux luminaire
707 lm (EXTREME CUT OFF)

03.4172.GL.LE

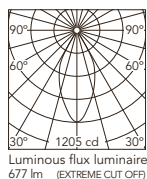

Beam Angle: 46°

h(m)	E(lx)	D(m)
1	1205	0.85
2	301	1.71
3	134	2.56
4	75	3.41
5	48	4.26

Luminous flux luminaire
677 lm (EXTREME CUT OFF)

03.4172.BU.LE

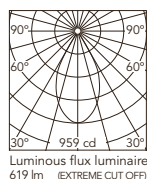

Beam Angle: 54°

h(m)	E(lx)	D(m)
1	959	1.01
2	240	2.02
3	107	3.03
4	60	4.04
5	38	5.05

Luminous flux luminaire
619 lm (EXTREME CUT OFF)

03.4172.74.LE

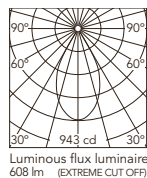

Beam Angle: 54°

h(m)	E(lx)	D(m)
1	943	1.01
2	236	2.03
3	105	3.04
4	59	4.06
5	38	5.07

Luminous flux luminaire
608 lm (EXTREME CUT OFF)

03.4172.CU.LE

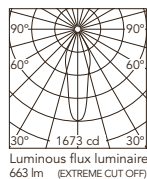

Beam Angle: 27°

h(m)	E(lx)	D(m)
1	1673	0.49
2	418	0.97
3	186	1.46
4	105	1.94
5	67	2.43

Luminous flux luminaire
663 lm (EXTREME CUT OFF)

Easy Kap 80 Square/Easy Kap 80 Square Plus - Adjustable - Optic Spot

Light Source: Easy Kap 80 Square: LED Array DC 500 mA - 9,2W - 935 lm - 2700K/CRI 90 / 9,2W - 974 lm - 3000K/CRI 90

Easy Kap 80 Square Plus: LED Array DC 700 mA - 13W - 1370 lm - 2700K/CRI 90 / 13W - 1460 lm - 3000K/CRI 90

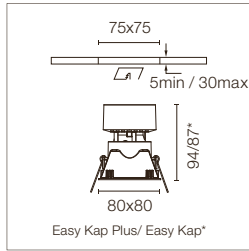

0,24 Kg

h=150 mm
h=91 mm

Incasso a LED. Fonte di alimentazione esclusa. Cornice di installazione non necessaria. Lente diffusore incluso.

Recessed luminaire with LED light source. Power supply not included. Installation frame not necessary. Diffusing lens included.

Alimentazioni raccomandate / Recommended power supply*:

	Easy Kap 80	Easy Kap 80 Plus
Non Dimmable	60.9160	60.9592
Dimmable 0/1-10V	RF27961	RF27961
Dimmable Dali 1	RF26571	RF26571
Dimmable Dali 2	60.9222	60.9222
Mains Dimming	60.9411	60.9467
Casambi	60.9207	60.9207

* Vedi capitolo Drivers / Refer to the Drivers chapter

- 2700K**
- Easy Kap 80 Square
 - 03.4294.B1
 - Easy Kap 80 Plus Square
 - 05.7443.B1

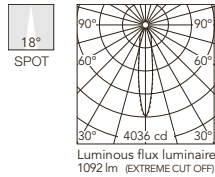

- 3000K**
- Easy Kap 80 Square
 - 03.4293.B1
 - Easy Kap 80 Plus Square
 - 05.7442.B1

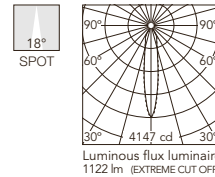

- Easy Kap 80 Square
- 03.4294.GL
- Easy Kap 80 Plus Square
- 05.7443.GL

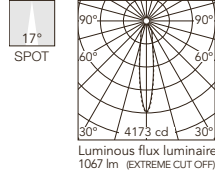

- Easy Kap 80 Square
- 03.4293.GL
- Easy Kap 80 Plus Square
- 05.7442.GL

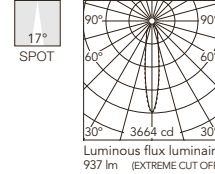

- Easy Kap 80 Square
- 03.4294.BU
- Easy Kap 80 Plus Square
- 05.7443.BU

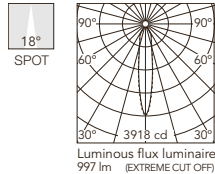

- Easy Kap 80 Square
- 03.4293.BU
- Easy Kap 80 Plus Square
- 05.7442.BU

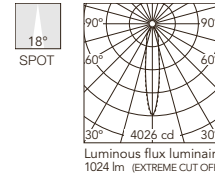

- Easy Kap 80 Square
- 03.4294.74
- Easy Kap 80 Plus Square
- 05.7443.74

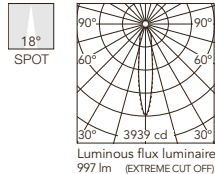

- Easy Kap 80 Square
- 03.4293.74
- Easy Kap 80 Plus Square
- 05.7442.74

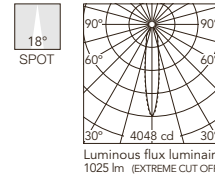

- Easy Kap 80 Square
- 03.4294.CU
- Easy Kap 80 Plus Square
- 05.7443.CU

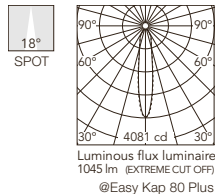

- Easy Kap 80 Square
- 03.4293.CU
- Easy Kap 80 Plus Square
- 05.7442.CU

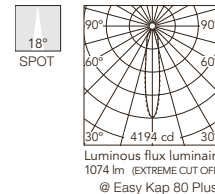

Easy Kap 80 Square Adjustable - Optic Spot - Dim To Warm

Light Source: LED Array 13W - 1800K - 2850K/CRI 95 - Dim To Warm

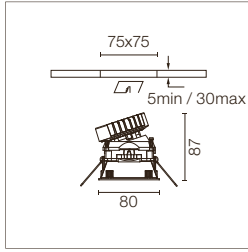

Incasso a LED. Fonte di alimentazione 220-240V e dimmerabile 1-10V inclusa. Per versioni con apparecchi a 110V, contattare il Front office. Cornice di installazione non necessaria. Lente diffusore incluso.

Recessed luminaire with LED light source. 220-240V & dimmable 1-10V power supply included. For 110V PSU versions, please consult with the front office. Installation frame not necessary. Diffusing lens included.

1800K-2850K
03.4293.B1.LE

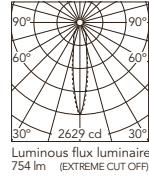

Beam Angle: 18°

h(m)	E(lx)	D(m)
1	2629	0.31
2	657	0.63
3	292	0.94
4	164	1.26
5	105	1.57

Luminous flux luminaire
754 lm (EXTREME CUT OFF)

03.4293.GL.LE

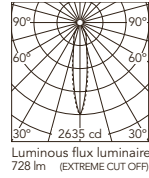

Beam Angle: 18°

h(m)	E(lx)	D(m)
1	2635	0.32
2	659	0.63
3	293	0.95
4	165	1.26
5	105	1.58

Luminous flux luminaire
728 lm (EXTREME CUT OFF)

03.4293.BU.LE

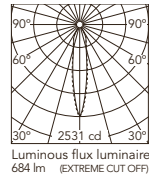

Beam Angle: 18°

h(m)	E(lx)	D(m)
1	2531	0.31
2	633	0.63
3	281	0.94
4	158	1.26
5	101	1.57

Luminous flux luminaire
684 lm (EXTREME CUT OFF)

03.4293.74.LE

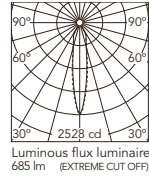

Beam Angle: 18°

h(m)	E(lx)	D(m)
1	2528	0.31
2	632	0.63
3	281	0.94
4	158	1.25
5	101	1.57

Luminous flux luminaire
685 lm (EXTREME CUT OFF)

03.4293.CU.LE

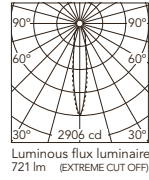

Beam Angle: 17°

h(m)	E(lx)	D(m)
1	2906	0.30
2	726	0.59
3	323	0.89
4	182	1.18
5	116	1.48

Luminous flux luminaire
721 lm (EXTREME CUT OFF)

Easy Kap 80 Square/Easy Kap 80 Square Plus - Adjustable - Optic Medium

Light Source: Easy Kap 80 Square: LED Array DC 500 mA - 9,2W - 935 lm - 2700K/CRI 90 / 9,2W - 974 lm - 3000K/CRI 90

Easy Kap 80 Square Plus: LED Array DC 700 mA - 13W - 1370 lm - 2700K/CRI 90 / 13W - 1460 lm - 3000K/CRI 90

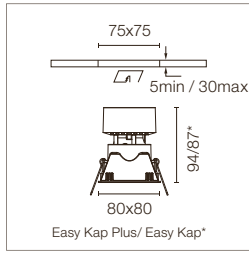

Incasto a LED. Fonte di alimentazione esclusa. Cornice di installazione non necessaria. Lente diffusore incluso.

Recessed luminaire with LED light source. Power supply not included. Installation frame not necessary. Diffusing lens included.

Alimentazioni raccomandate / Recommended power supply*:

	Easy Kap 80	Easy Kap 80 Plus
Non Dimmable	60.9160	60.9592
Dimmable 0/1-10V	RF27961	RF27961
Dimmable Dali 1	RF26571	RF26571
Dimmable Dali 2	60.9222	60.9222
Mains Dimming	60.9411	60.9467
Casambi	60.9207	60.9207

* Vedi capitolo Drivers / Refer to the Drivers chapter

- 2700K**
 Easy Kap 80 Square
 03.4201.B1
 Easy Kap 80 Plus Square
 05.7439.B1

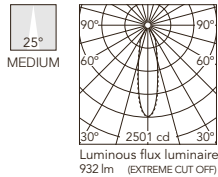

Beam Angle: 25°

h(m)	E(lx)	D(m)
1	2501	0.44
2	625	0.88
3	278	1.32
4	156	1.76
5	100	2.20

- 3000K**
 Easy Kap 80 Square
 03.4200.B1
 Easy Kap 80 Plus Square
 05.7438.B1

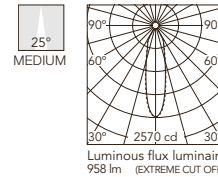

Beam Angle: 25°

h(m)	E(lx)	D(m)
1	2570	0.44
2	643	0.88
3	286	1.32
4	161	1.76
5	103	2.20

- Easy Kap 80 Square
 03.4201.GL
 Easy Kap 80 Plus Square
 05.7439.GL

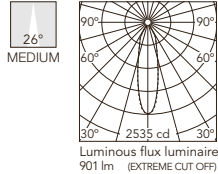

Beam Angle: 26°

h(m)	E(lx)	D(m)
1	2535	0.46
2	634	0.91
3	282	1.37
4	158	1.83
5	101	2.28

- Easy Kap 80 Square
 03.4200.GL
 Easy Kap 80 Plus Square
 05.7438.GL

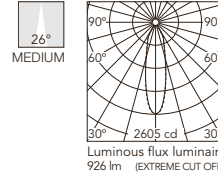

Beam Angle: 26°

h(m)	E(lx)	D(m)
1	2605	0.46
2	651	0.91
3	289	1.37
4	163	1.83
5	104	2.28

- Easy Kap 80 Square
 03.4201.BU
 Easy Kap 80 Plus Square
 05.7439.BU

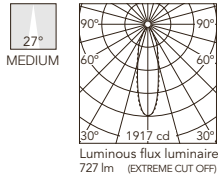

Beam Angle: 27°

h(m)	E(lx)	D(m)
1	1917	0.47
2	479	0.94
3	213	1.41
4	120	1.88
5	77	2.36

- Easy Kap 80 Square
 03.4200.BU
 Easy Kap 80 Plus Square
 05.7438.BU

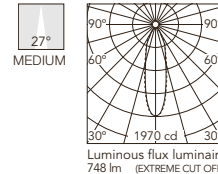

Beam Angle: 27°

h(m)	E(lx)	D(m)
1	1970	0.47
2	492	0.94
3	219	1.41
4	123	1.88
5	79	2.36

- Easy Kap 80 Square
 03.4201.74
 Easy Kap 80 Plus Square
 05.7439.74

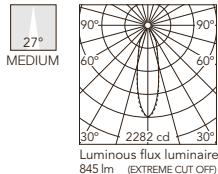

Beam Angle: 27°

h(m)	E(lx)	D(m)
1	2282	0.49
2	570	0.97
3	254	1.46
4	143	1.94
5	91	2.43

- Easy Kap 80 Square
 03.4200.74
 Easy Kap 80 Plus Square
 05.7438.74

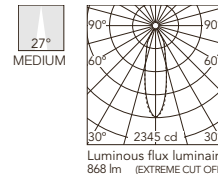

Beam Angle: 27°

h(m)	E(lx)	D(m)
1	2345	0.49
2	586	0.97
3	261	1.46
4	147	1.94
5	94	2.43

- Easy Kap 80 Square
 03.4201.CU
 Easy Kap 80 Plus Square
 05.7439.CU

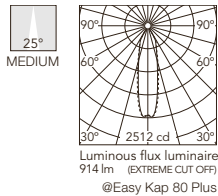

Beam Angle: 25°

h(m)	E(lx)	D(m)
1	2512	0.44
2	628	0.87
3	279	1.31
4	157	1.75
5	100	2.18

- Easy Kap 80 Square
 03.4200.CU
 Easy Kap 80 Plus Square
 05.7438.CU

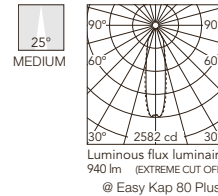

Beam Angle: 25°

h(m)	E(lx)	D(m)
1	2582	0.44
2	645	0.87
3	287	1.31
4	161	1.75
5	103	2.18

Easy Kap 80 Square Adjustable - Optic Medium - Dim To Warm

Light Source: LED Array 13W - 1800K - 2850K/CRI 95 - Dim To Warm

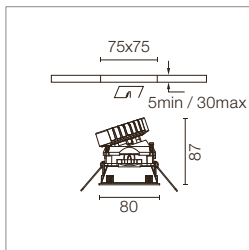

Incasso a LED. Fonte di alimentazione 220-240V e dimmerabile 1-10V inclusa. Per versioni con apparecchi a 110V, contattare il Front office. Cornice di installazione non necessaria. Lente diffusore incluso.

Recessed luminaire with LED light source. 220-240V & dimmable 1-10V power supply included. For 110V PSU versions, please consult with the front office. Installation frame not necessary. Diffusing lens included.

1800K-2850K
03.4200.B1.LE

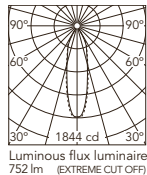

Beam Angle: 26°

h(m)	E(lx)	D(m)
1	1844	0.47
2	461	0.94
3	205	1.41
4	115	1.88
5	74	2.35

03.4200.GL.LE

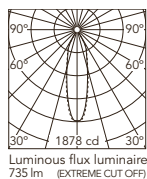

Beam Angle: 27°

h(m)	E(lx)	D(m)
1	1878	0.47
2	470	0.95
3	209	1.42
4	117	1.89
5	75	2.37

03.4200.BU.LE

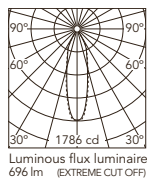

Beam Angle: 27°

h(m)	E(lx)	D(m)
1	1786	0.47
2	447	0.95
3	198	1.42
4	112	1.89
5	71	2.37

03.4200.74.LE

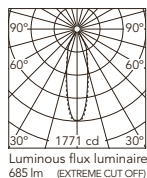

Beam Angle: 27°

h(m)	E(lx)	D(m)
1	1771	0.48
2	443	0.96
3	197	1.44
4	111	1.93
5	71	2.41

03.4200.CU.LE

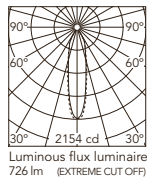

Beam Angle: 22°

h(m)	E(lx)	D(m)
1	2154	0.40
2	538	0.79
3	239	1.19
4	135	1.59
5	86	1.98

Easy Kap 80 Square/Easy Kap 80 Square Plus - Adjustable - Optic Flood

Light Source: Easy Kap 80 Square: LED Array DC 500 mA - 9,2W - 935 lm - 2700K/CRI 90 / 9,2W - 974 lm - 3000K/CRI 90

Easy Kap 80 Square Plus: LED Array DC 700 mA - 13W - 1370 lm - 2700K/CRI 90 / 13W - 1460 lm - 3000K/CRI 90

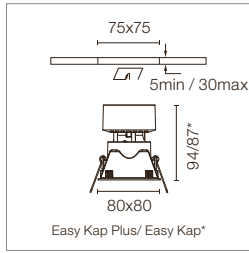

Incasso a LED. Fonte di alimentazione esclusa. Cornice di installazione non necessaria. Lente diffusore incluso.

Recessed luminaire with LED light source. Power supply not included. Installation frame not necessary. Diffusing lens included.

Alimentazioni raccomandate / Recommended power supply*:

	Easy Kap 80	Easy Kap 80 Plus
Non Dimmable	60.9160	60.9592
Dimmable 0/1-10V	RF27961	RF27961
Dimmable Dali 2	60.9222	60.9222
Mains Dimming	60.9411	60.9467
Casambi	60.9207	60.9207

* Vedi capitolo Drivers / Refer to the Drivers chapter

2700K

- Easy Kap 80 Square
- 03.4296.B1
- Easy Kap 80 Plus Square
- 05.7445.B1

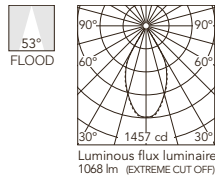

Beam Angle: 53°

h(m)	E(lx)	D(m)
1	1457	0.99
2	364	1.98
3	162	2.98
4	91	3.97
5	58	4.96

3000K

- Easy Kap 80 Square
- 03.4295.B1
- Easy Kap 80 Plus Square
- 05.7444.B1

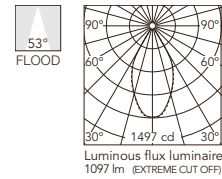

Beam Angle: 53°

h(m)	E(lx)	D(m)
1	1497	0.99
2	374	1.98
3	166	2.98
4	94	3.97
5	60	4.96

- Easy Kap 80 Square
- 03.4296.GL
- Easy Kap 80 Plus Square
- 05.7445.GL

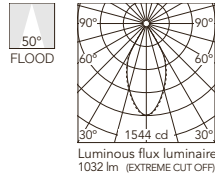

Beam Angle: 50°

h(m)	E(lx)	D(m)
1	1544	0.93
2	386	1.86
3	172	2.79
4	96	3.72
5	62	4.65

- Easy Kap 80 Square
- 03.4295.GL
- Easy Kap 80 Plus Square
- 05.7444.GL

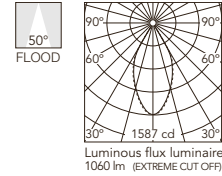

Beam Angle: 50°

h(m)	E(lx)	D(m)
1	1587	0.93
2	397	1.86
3	176	2.79
4	99	3.72
5	63	4.65

- Easy Kap 80 Square
- 03.4296.BU
- Easy Kap 80 Plus Square
- 05.7445.BU

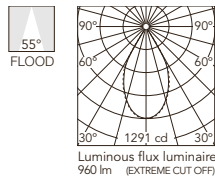

Beam Angle: 55°

h(m)	E(lx)	D(m)
1	1291	1.05
2	323	2.09
3	143	3.14
4	81	4.19
5	52	5.23

- Easy Kap 80 Square
- 03.4295.BU
- Easy Kap 80 Plus Square
- 05.7444.BU

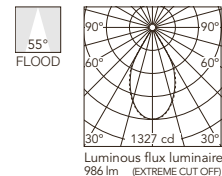

Beam Angle: 55°

h(m)	E(lx)	D(m)
1	1327	1.05
2	332	2.09
3	147	3.14
4	83	4.19
5	53	5.23

- Easy Kap 80 Square
- 03.4296.74
- Easy Kap 80 Plus Square
- 05.7445.74

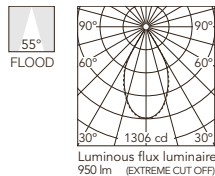

Beam Angle: 55°

h(m)	E(lx)	D(m)
1	1306	1.04
2	326	2.08
3	145	3.11
4	82	4.15
5	52	5.19

- Easy Kap 80 Square
- 03.4295.74
- Easy Kap 80 Plus Square
- 05.7444.74

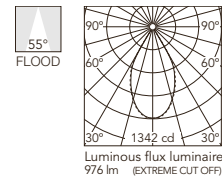

Beam Angle: 55°

h(m)	E(lx)	D(m)
1	1342	1.04
2	335	2.08
3	149	3.11
4	84	4.15
5	54	5.19

- Easy Kap 80 Square
- 03.4296.CU
- Easy Kap 80 Plus Square
- 05.7445.CU

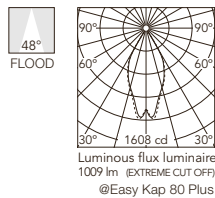

Beam Angle: 48°

h(m)	E(lx)	D(m)
1	1608	0.88
2	402	1.77
3	179	2.65
4	101	3.53
5	64	4.42

- Easy Kap 80 Square
- 03.4295.CU
- Easy Kap 80 Plus Square
- 05.7444.CU

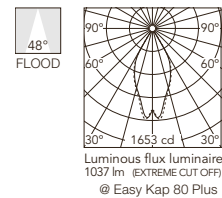

Beam Angle: 48°

h(m)	E(lx)	D(m)
1	1653	0.88
2	413	1.77
3	184	2.65
4	103	3.53
5	66	4.42

Easy Kap 80 Square Adjustable - Optic Flood - Dim To Warm

Light Source: LED Array 13W - 1800K - 2850K/CRI 95 - Dim To Warm

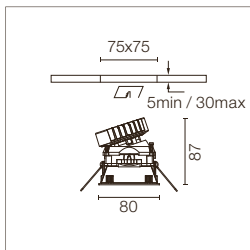

Incasso a LED. Fonte di alimentazione 220-240V e dimmerabile 1-10V inclusa. Per versioni con apparecchi a 110V, contattare il Front office. Cornice di installazione non necessaria. Lente diffusore incluso.

Recessed luminaire with LED light source. 220-240V & dimmable 1-10V power supply included. For 110V PSU versions, please consult with the front office. Installation frame not necessary. Diffusing lens included.

1800K-2850K
03.4295.B1.LE

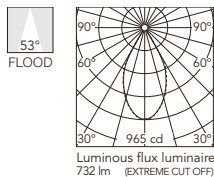

Beam Angle: 53°

h(m)	E(lx)	D(m)
1	965	1.01
2	241	2.01
3	107	3.02
4	60	4.03
5	39	5.03

03.4295.GL.LE

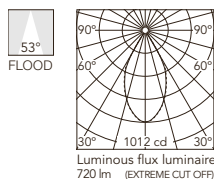

Beam Angle: 53°

h(m)	E(lx)	D(m)
1	1012	0.99
2	253	1.98
3	112	2.97
4	63	3.96
5	40	4.95

03.4295.BU.LE

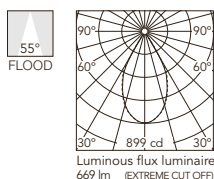

Beam Angle: 55°

h(m)	E(lx)	D(m)
1	899	1.04
2	225	2.08
3	100	3.12
4	56	4.16
5	36	5.21

03.4295.74.LE

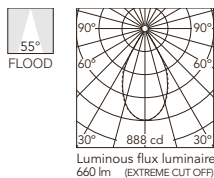

Beam Angle: 55°

h(m)	E(lx)	D(m)
1	888	1.04
2	222	2.07
3	99	3.11
4	55	4.15
5	36	5.18

03.4295.CU.LE

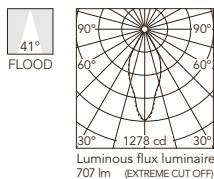

Beam Angle: 41°

h(m)	E(lx)	D(m)
1	1278	0.75
2	319	1.50
3	142	2.25
4	80	3.00
5	51	3.75

Easy Kap Ø80 Adjustable

Light Source: LED QR-CBC 51 GX5.3

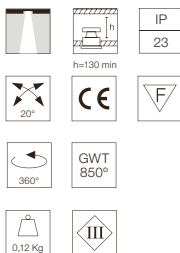
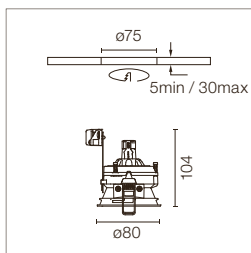

Incasso per lampada di 12V.
Trasformatore remoto non incluso.
Cornice di installazione non necessaria.
Accessori per lenti non disponibili.

Recessed 12V lamp luminaire.
Remote transformer not included.
Installation frame not necessary.
Not suitable for lens accessories.

- 03.4160.B1
- 03.4160.GL
- 03.4160.BU
- 03.4160.74
- 03.4160.CU

Easy Kap 80 Square Adjustable

Light Source: LED QR-CBC 51 GX5.3

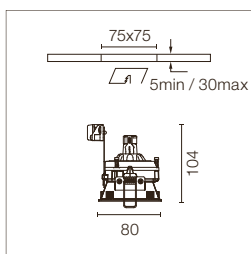

Incasso per lampada di 12V.
Trasformatore remoto non incluso.
Cornice di installazione non necessaria.
Accessori per lenti non disponibili.

Recessed 12V lamp luminaire.
Remote transformer not included.
Installation frame not necessary.
Not suitable for lens accessories.

- 03.4212.B1
- 03.4212.GL
- 03.4212.BU
- 03.4212.74
- 03.4212.CU

Easy Kap Ø80 Adjustable

Light Source: LED PAR 16 GZ10

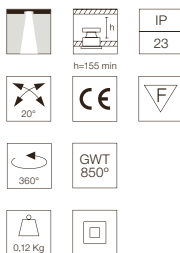
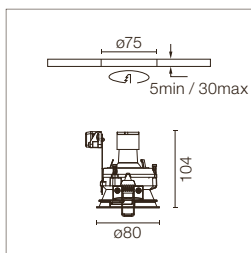

Incasso con alimentazione in tensione di rete. Cornice di installazione non necessaria.
Accessori per lenti non disponibili.

Recessed luminaire with main voltage source. Installation frame not necessary.
Not suitable for lens accessories.

- 03.4162.B1
- 03.4162.GL
- 03.4162.BU
- 03.4162.74
- 03.4162.CU

Easy Kap 80 Square Adjustable

Light Source: LED PAR 16 GZ10

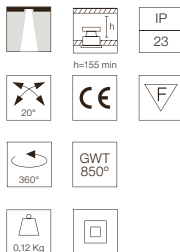
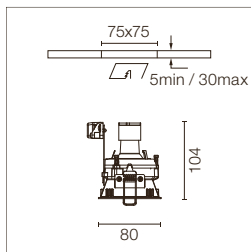

Incasso con alimentazione in tensione di rete. Cornice di installazione non necessaria.
Accessori per lenti non disponibili.

Recessed luminaire with main voltage source. Installation frame not necessary.
Not suitable for lens accessories.

- 03.4213.B1
- 03.4213.GL
- 03.4213.BU
- 03.4213.74
- 03.4213.CU

KAP

Easy Kap Ø80/Easy Kap Ø80 Plus - Wall-Washer

Light Source: Easy Kap Ø80: LED Array DC 500 mA - 9,2W - 935 lm - 2700K/CRI 90 / 9,2W - 974 lm - 3000K/CRI 90

Easy Kap Ø80 Plus: LED Array DC 700 mA - 13W - 1370 lm - 2700K/CRI 90 / 13W - 1460 lm - 3000K/CRI 90

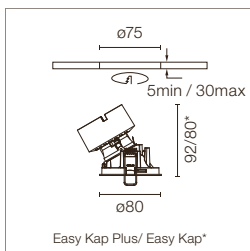

Incasso a LED. Fonte di alimentazione esclusa. Cornice di installazione non necessaria. Lente ellittica inclusa.

Recessed luminaire with LED light source. Power supply not included. Installation frame not necessary. Elliptical lens included.

Alimentazioni raccomandate / Recommended power supply*:

	Easy Kap Ø80	Easy Kap Ø80 Plus
Non Dimmable	60.9160	60.9592
Dimmable 0/1-10V	RF27961	RF27961
Dimmable Dali 1	RF26571	RF26571
Dimmable Dali 2	60.9222	60.9222
Mains Dimming	60.9411	60.9467
Casambi	60.9207	60.9207

* Vedi capitolo Drivers / Refer to the Drivers chapter

- 2700K**
 Easy Kap Ø80
 03.4197.B1
 Easy Kap Ø80 Plus
 05.7435.B1

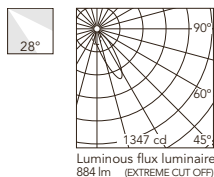

Beam Angle: 28°

h(m)	E(lx)	D(m)
1	1347	0.62
2	337	1.24
3	150	1.87
4	84	2.49
5	54	3.11

- 3000K**
 Easy Kap Ø80
 03.4196.B1
 Easy Kap Ø80 Plus
 05.7434.B1

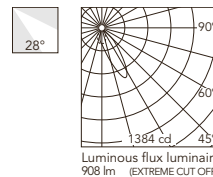

Beam Angle: 28°

h(m)	E(lx)	D(m)
1	1384	0.62
2	346	1.24
3	154	1.87
4	86	2.49
5	55	3.11

- Easy Kap Ø80
 03.4197.GL
 Easy Kap Ø80 Plus
 05.7435.GL

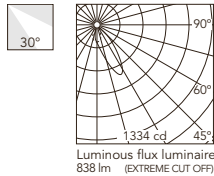

Beam Angle: 30°

h(m)	E(lx)	D(m)
1	1334	0.67
2	333	1.33
3	148	2.00
4	83	2.67
5	53	3.33

- Easy Kap Ø80
 03.4196.GL
 Easy Kap Ø80 Plus
 05.7434.GL

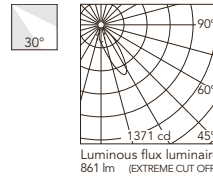

Beam Angle: 30°

h(m)	E(lx)	D(m)
1	1371	0.67
2	343	1.33
3	152	2.00
4	86	2.67
5	55	3.33

- Easy Kap Ø80
 03.4197.BU
 Easy Kap Ø80 Plus
 05.7435.BU

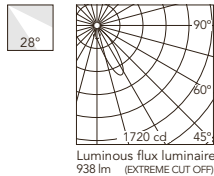

Beam Angle: 28°

h(m)	E(lx)	D(m)
1	1720	0.64
2	430	1.28
3	191	1.91
4	108	2.55
5	69	3.19

- Easy Kap Ø80
 03.4196.BU
 Easy Kap Ø80 Plus
 05.7434.BU

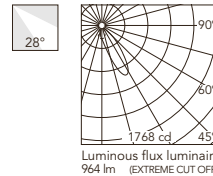

Beam Angle: 28°

h(m)	E(lx)	D(m)
1	1768	0.64
2	442	1.28
3	196	1.91
4	110	2.55
5	71	3.19

- Easy Kap Ø80
 03.4197.74
 Easy Kap Ø80 Plus
 05.7435.74

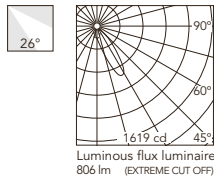

Beam Angle: 26°

h(m)	E(lx)	D(m)
1	1619	0.59
2	405	1.19
3	180	1.78
4	101	2.37
5	65	2.97

- Easy Kap Ø80
 03.4196.74
 Easy Kap Ø80 Plus
 05.7434.74

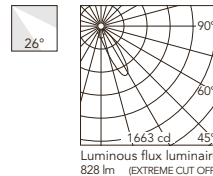

Beam Angle: 26°

h(m)	E(lx)	D(m)
1	1663	0.59
2	416	1.19
3	185	1.78
4	104	2.37
5	67	2.97

- Easy Kap Ø80
 03.4197.CU
 Easy Kap Ø80 Plus
 05.7435.CU

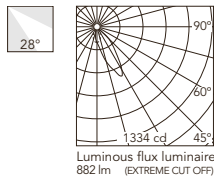

Beam Angle: 28°

h(m)	E(lx)	D(m)
1	1334	0.64
2	333	1.27
3	148	1.91
4	83	2.55
5	53	3.19

- Easy Kap Ø80
 03.4196.CU
 Easy Kap Ø80 Plus
 05.7434.CU

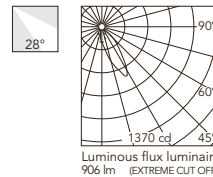

Beam Angle: 28°

h(m)	E(lx)	D(m)
1	1370	0.64
2	343	1.27
3	152	1.91
4	86	2.55
5	55	3.19

Easy Kap Ø80 Wall-Washer - Dim To Warm

Light Source: LED Array 13W - 1800K - 2850K/CRI 95 - Dim To Warm

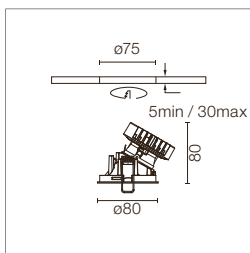

Incasso a LED. Fonte di alimentazione 220-240V e dimmerabile 1-10V inclusa. Per versioni con apparecchi a 110V, contattare il Front office. Cornice di installazione non necessaria. Lente diffusore incluso.

Recessed luminaire with LED light source. 220-240V & dimmable 1-10V power supply included. For 110V PSU versions, please consult with the front office. Installation frame not necessary. Diffusing lens included.

1800K-2850K
 03.4196.B1.LE

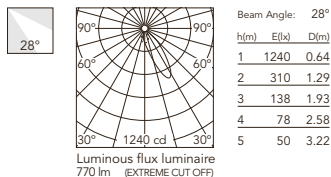

03.4196.GL.LE

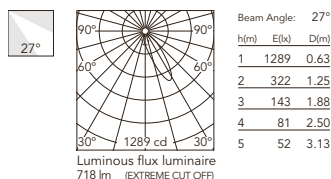

03.4196.BU.LE

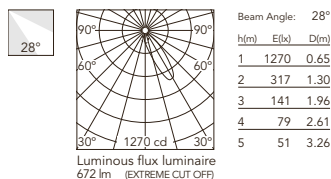

03.4196.74.LE

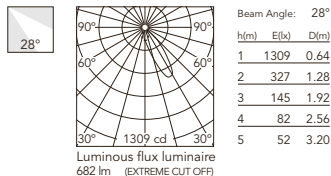

03.4196.CU.LE

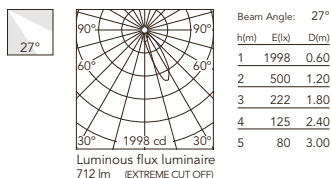

KAP

Easy Kap 80 Square/Easy Kap 80 Square Plus - Wall-Washer

Light Source: Easy Kap 80 Square: LED Array DC 500 mA - 9,2W - 935 lm - 2700K/CRI 90 / 9,2W - 974 lm - 3000K/CRI 90

Easy Kap 80 Square Plus: LED Array DC 700 mA - 13W - 1370 lm - 2700K/CRI 90 / 13W - 1460 lm - 3000K/CRI 90

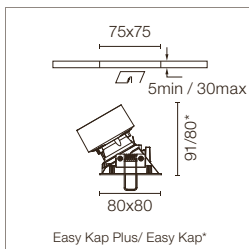

Incasso a LED. Fonte di alimentazione esclusa. Cornice di installazione non necessaria. Lente ellittica inclusa.

Recessed luminaire with LED light source. Power supply not included. Installation frame not necessary. Elliptical lens included.

Alimentazioni raccomandate / Recommended power supply*:

	Easy Kap 80	Easy Kap 80 Plus
Non Dimmable	60.9160	60.9592
Dimmable 0/1-10V	RF27961	RF27961
Dimmable Dali 1	RF26571	RF26571
Dimmable Dali 2	60.9222	60.9222
Mains Dimming	60.9411	60.9467
Casambi	60.9207	60.9207

* Vedi capitolo Drivers / Refer to the Drivers chapter

2700K

- Easy Kap Ø80
- 03.4199.B1
- Easy Kap Ø80 Plus
- 05.7437.B1

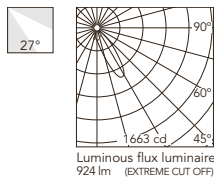

Beam Angle: 27°

h(m)	E(lx)	D(m)
1	1663	0.62
2	416	1.24
3	185	1.85
4	104	2.47
5	67	3.09

3000K

- Easy Kap Ø80
- 03.4198.B1
- Easy Kap Ø80 Plus
- 05.7436.B1

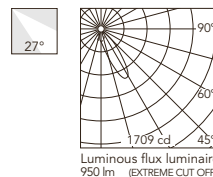

Beam Angle: 27°

h(m)	E(lx)	D(m)
1	1709	0.62
2	427	1.24
3	190	1.85
4	107	2.47
5	68	3.09

- Easy Kap Ø80
- 03.4199.GL
- Easy Kap Ø80 Plus
- 05.7437.GL

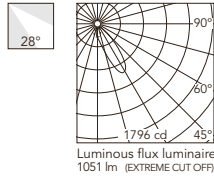

Beam Angle: 28°

h(m)	E(lx)	D(m)
1	1796	0.68
2	449	1.36
3	200	2.04
4	112	2.72
5	72	3.40

- Easy Kap Ø80
- 03.4198.GL
- Easy Kap Ø80 Plus
- 05.7436.GL

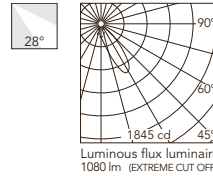

Beam Angle: 28°

h(m)	E(lx)	D(m)
1	1845	0.68
2	461	1.36
3	205	2.04
4	115	2.72
5	74	3.40

- Easy Kap Ø80
- 03.4199.BU
- Easy Kap Ø80 Plus
- 05.7437.BU

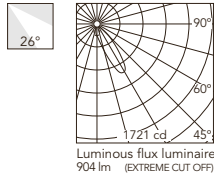

Beam Angle: 26°

h(m)	E(lx)	D(m)
1	1721	0.63
2	430	1.25
3	191	1.88
4	108	2.51
5	69	3.14

- Easy Kap Ø80
- 03.4198.BU
- Easy Kap Ø80 Plus
- 05.7436.BU

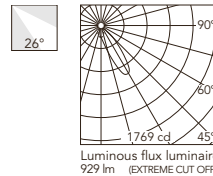

Beam Angle: 26°

h(m)	E(lx)	D(m)
1	1769	0.63
2	442	1.25
3	197	1.88
4	111	2.51
5	71	3.14

- Easy Kap Ø80
- 03.4199.74
- Easy Kap Ø80 Plus
- 05.7437.74

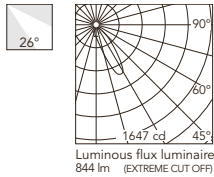

Beam Angle: 26°

h(m)	E(lx)	D(m)
1	1647	0.59
2	412	1.19
3	183	1.78
4	103	2.37
5	66	2.97

- Easy Kap Ø80
- 03.4198.74
- Easy Kap Ø80 Plus
- 05.7436.74

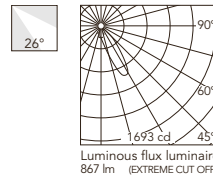

Beam Angle: 26°

h(m)	E(lx)	D(m)
1	1693	0.59
2	423	1.19
3	188	1.78
4	106	2.37
5	68	2.97

- Easy Kap Ø80
- 03.4199.CU
- Easy Kap Ø80 Plus
- 05.7437.CU

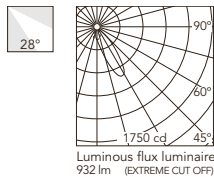

Beam Angle: 28°

h(m)	E(lx)	D(m)
1	1750	0.64
2	437	1.29
3	194	1.93
4	109	2.57
5	70	3.21

- Easy Kap Ø80
- 03.4198.CU
- Easy Kap Ø80 Plus
- 05.7436.CU

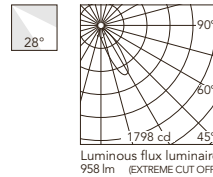

Beam Angle: 28°

h(m)	E(lx)	D(m)
1	1798	0.64
2	450	1.29
3	200	1.93
4	112	2.57
5	72	3.21

Easy Kap 80 Square Wall-Washer - Dim To Warm

Light Source: LED Array 13W - 1800K - 2850K/CRI 95 - Dim To Warm

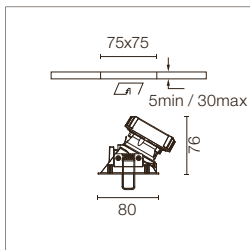

0.24 Kg

h=91 min

Incasso a LED. Fonte di alimentazione 220-240V e dimmerabile 1-10V inclusa. Per versioni con apparecchi a 110V, contattare il Front office. Cornice di installazione non necessaria. Lente diffusore incluso.

Recessed luminaire with LED light source. 220-240V & dimmable 1-10V power supply included. For 110V PSU versions, please consult with the front office. Installation frame not necessary. Diffusing lens included.

1800K-2850K
 03.4198.B1.LE

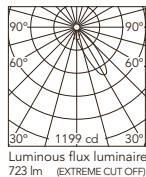

Beam Angle: 28°

h(m)	E(lx)	D(m)
1	1199	0.68
2	300	1.37
3	133	2.05
4	75	2.74
5	48	3.42

03.4198.GL.LE

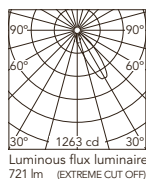

Beam Angle: 28°

h(m)	E(lx)	D(m)
1	1263	0.69
2	316	1.38
3	140	2.07
4	79	2.75
5	51	3.44

03.4198.BU.LE

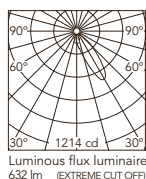

Beam Angle: 28°

h(m)	E(lx)	D(m)
1	1214	0.68
2	304	1.35
3	135	2.03
4	76	2.71
5	49	3.39

03.4198.74.LE

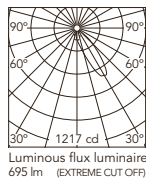

Beam Angle: 27°

h(m)	E(lx)	D(m)
1	1217	0.66
2	304	1.33
3	135	1.99
4	76	2.66
5	49	3.32

03.4198.CU.LE

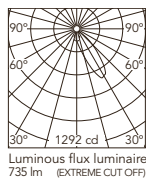

Beam Angle: 29°

h(m)	E(lx)	D(m)
1	1292	0.70
2	323	1.40
3	144	2.10
4	81	2.80
5	52	3.50

Easy Kap Ø80 Wall-Washer

Light Source: LED QR-CBC 51 GX5.3

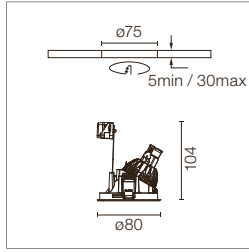

Incasso per lampada di 12V.
Trasformatore remoto non incluso.
Cornice di installazione non necessaria.
Accessori per lenti non disponibili.

Recessed 12V lamp luminaire.
Remote transformer not included.
Installation frame not necessary.
Not suitable for lens accessories.

- 03.4220.B1
- 03.4220.GL
- 03.4220.BU
- 03.4220.74
- 03.4220.CU

Easy Kap 80 Square Wall-Washer

Light Source: LED QR-CBC 51 GX5.3

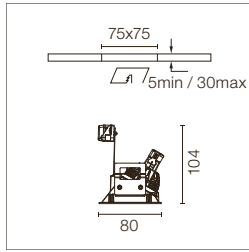

Incasso per lampada di 12V.
Trasformatore remoto non incluso.
Cornice di installazione non necessaria.
Accessori per lenti non disponibili.

Recessed 12V lamp luminaire.
Remote transformer not included.
Installation frame not necessary.
Not suitable for lens accessories.

- 03.4218.B1
- 03.4218.GL
- 03.4218.BU
- 03.4218.74
- 03.4218.CU

Easy Kap Ø80 Wall-Washer

Light Source: LED PAR 16 GZ10

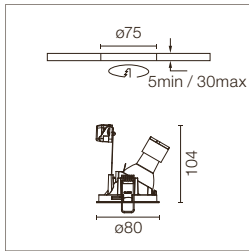

Incasso con alimentazione in tensione di rete. Cornice di installazione non necessaria.
Accessori per lenti non disponibili.

Recessed luminaire with main voltage source. Installation frame not necessary.
Not suitable for lens accessories.

- 03.4221.B1
- 03.4221.GL
- 03.4221.BU
- 03.4221.74
- 03.4221.CU

Easy Kap 80 Square Wall-Washer

Light Source: LED PAR 16 GZ10

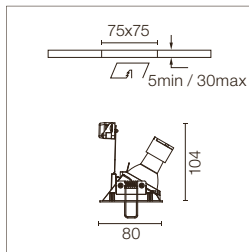

Incasso con alimentazione in tensione di rete. Cornice di installazione non necessaria.
Accessori per lenti non disponibili.

Recessed luminaire with main voltage source. Installation frame not necessary.
Not suitable for lens accessories.

- 03.4219.B1
- 03.4219.GL
- 03.4219.BU
- 03.4219.74
- 03.4219.CU

Easy Kap Ø105 Fixed - Optic Spot

Light Source: LED Array DC 650 mA - 23W - 2690 lm - 2700K/CRI 90 / 23W - 2870 lm - 3000K/CRI 90

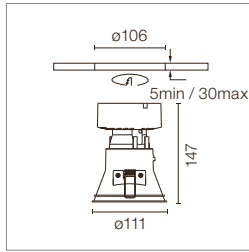

GWT
850°



LED INCL



0.55 Kg



III



IP
54



Incasso a LED. Trasformatore remoto non incluso. Cornice di installazione non necessaria.

Recessed luminaire with LED light source. Remote transformer not included. Installation frame not necessary.

Alimentazioni raccomandate / Recommended power supply*:

- Non Dimmable 60.9592
- Dimmable 1-10V 60.9439
- Dimmable Dali 2 RF30699
- Casambi 60.9207

* Vedi capitolo Drivers / Refer to the Drivers chapter

2700K
□ 05.7000.B1

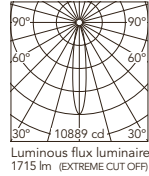

Beam Angle: 17°

h(m)	E(lx)	D(m)
1	10889	0.30
2	2722	0.59
3	1210	0.89
4	681	1.18
5	436	1.48

■ 05.7000.GL

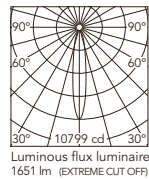

Beam Angle: 17°

h(m)	E(lx)	D(m)
1	10799	0.29
2	2700	0.59
3	1200	0.88
4	675	1.17
5	432	1.47

■ 05.7000.BU

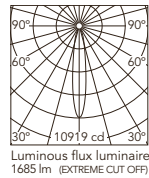

Beam Angle: 17°

h(m)	E(lx)	D(m)
1	10919	0.29
2	2730	0.59
3	1213	0.88
4	682	1.18
5	437	1.47

■ 05.7000.74

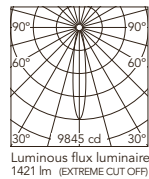

Beam Angle: 16°

h(m)	E(lx)	D(m)
1	9845	0.29
2	2461	0.57
3	1094	0.86
4	615	1.14
5	394	1.43

■ 05.7000.CU

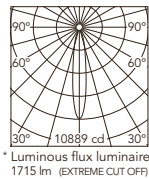

Beam Angle: 17°

h(m)	E(lx)	D(m)
1	10889	0.30
2	2722	0.59
3	1210	0.89
4	681	1.18
5	436	1.48

3000K
□ 05.7005.B1

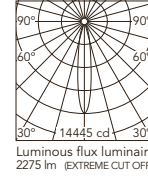

Beam Angle: 17°

h(m)	E(lx)	D(m)
1	14445	0.30
2	3611	0.59
3	1605	0.89
4	903	1.18
5	578	1.48

■ 05.7005.GL

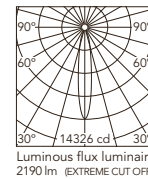

Beam Angle: 17°

h(m)	E(lx)	D(m)
1	14326	0.29
2	3581	0.59
3	1592	0.88
4	895	1.17
5	573	1.47

■ 05.7005.BU

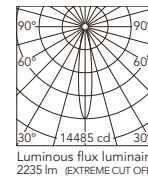

Beam Angle: 17°

h(m)	E(lx)	D(m)
1	14485	0.29
2	3621	0.59
3	1609	0.88
4	905	1.18
5	579	1.47

■ 05.7005.74

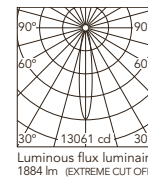

Beam Angle: 16°

h(m)	E(lx)	D(m)
1	13061	0.29
2	3265	0.57
3	1451	0.86
4	816	1.14
5	522	1.43

■ 05.7005.CU

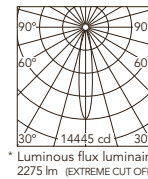

Beam Angle: 17°

h(m)	E(lx)	D(m)
1	14445	0.30
2	3611	0.59
3	1605	0.89
4	903	1.18
5	578	1.48

* Fotometrie preliminari. Consultare la nostra pagina web per informazioni aggiornate / Preliminary photometries. Visit our website for updated information.

Easy Kap Ø105 Fixed - Optic Medium

Light Source: LED Array DC 650 mA - 23W - 2690 lm - 2700K/CRI 90 / 23W - 2870 lm - 3000K/CRI 90

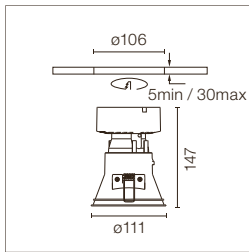

GWT 850°
 LED INCL
 0,55 Kg
 III
 IP 54
 h=150 min
 CE
 F

Incasto a LED. Trasformatore remoto non incluso. Cornice di installazione non necessaria.

Recessed luminaire with LED light source. Remote transformer not included. Installation frame not necessary.

Alimentazioni raccomandate / Recommended power supply*:

- Non Dimmable 60.9592
- Dimmable 1-10V 60.9439
- Dimmable Dali 2 RF30699
- Casambi 60.9207

* Vedi capitolo Drivers / Refer to the Drivers chapter

2700K
□ 05.7001.B1

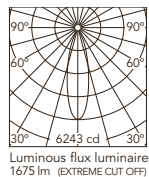

Beam Angle: 27°

h(m)	E(lx)	D(m)
1	6243	0.48
2	1561	0.97
3	694	1.45
4	390	1.93
5	250	2.41

Luminous flux luminaire 1675 lm (EXTREME CUT OFF)

3000K
□ 05.7006.B1

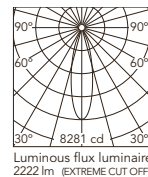

Beam Angle: 27°

h(m)	E(lx)	D(m)
1	8281	0.48
2	2070	0.97
3	920	1.45
4	518	1.93
5	331	2.41

Luminous flux luminaire 2222 lm (EXTREME CUT OFF)

■ 05.7001.GL

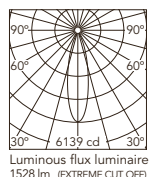

Beam Angle: 26°

h(m)	E(lx)	D(m)
1	6139	0.46
2	1535	0.93
3	682	1.39
4	384	1.86
5	246	2.32

Luminous flux luminaire 1528 lm (EXTREME CUT OFF)

■ 05.7006.GL

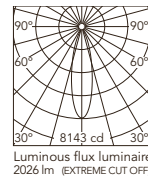

Beam Angle: 26°

h(m)	E(lx)	D(m)
1	8143	0.46
2	2036	0.93
3	905	1.39
4	509	1.86
5	326	2.32

Luminous flux luminaire 2026 lm (EXTREME CUT OFF)

■ 05.7001.BU

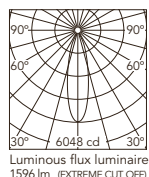

Beam Angle: 27°

h(m)	E(lx)	D(m)
1	6048	0.47
2	1512	0.94
3	672	1.41
4	378	1.89
5	242	2.36

Luminous flux luminaire 1596 lm (EXTREME CUT OFF)

■ 05.7006.BU

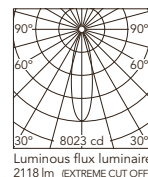

Beam Angle: 27°

h(m)	E(lx)	D(m)
1	8023	0.47
2	2006	0.94
3	891	1.41
4	501	1.89
5	321	2.36

Luminous flux luminaire 2118 lm (EXTREME CUT OFF)

■ 05.7001.74

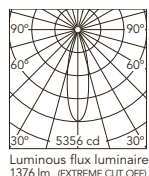

Beam Angle: 27°

h(m)	E(lx)	D(m)
1	5356	0.48
2	1339	0.96
3	595	1.44
4	335	1.92
5	214	2.40

Luminous flux luminaire 1376 lm (EXTREME CUT OFF)

■ 05.7006.74

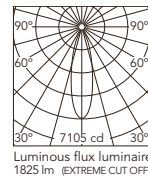

Beam Angle: 27°

h(m)	E(lx)	D(m)
1	7105	0.48
2	1776	0.96
3	789	1.44
4	444	1.92
5	284	2.40

Luminous flux luminaire 1825 lm (EXTREME CUT OFF)

■ 05.7001.CU

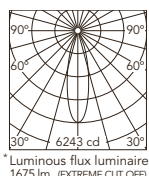

Beam Angle: 27°

h(m)	E(lx)	D(m)
1	6243	0.48
2	1561	0.97
3	694	1.45
4	390	1.93
5	250	2.41

Luminous flux luminaire 1675 lm (EXTREME CUT OFF)

■ 05.7006.CU

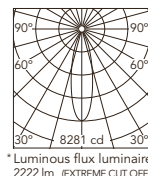

Beam Angle: 27°

h(m)	E(lx)	D(m)
1	8281	0.48
2	2070	0.97
3	920	1.45
4	518	1.93
5	331	2.41

Luminous flux luminaire 2222 lm (EXTREME CUT OFF)

* Fotometrie preliminari. Consultare la nostra pagina web per informazioni aggiornate / Preliminary photometries. Visit our website for updated information.

Easy Kap Ø105 Fixed - Optic Flood

Light Source: LED Array DC 650 mA - 23W - 2690 lm - 2700K/CRI 90 / 23W - 2870 lm - 3000K/CRI 90

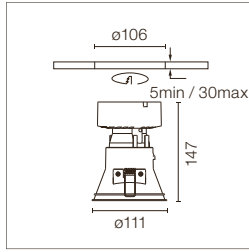
GWT
850°

LED INCL



0.55 Kg



III

IP
54

CE



F

Incasto a LED. Trasformatore remoto non incluso.
Cornice di installazione non necessaria.

Recessed luminaire with LED light source. Remote transformer not included.
Installation frame not necessary.

Alimentazioni raccomandate / Recommended power supply*:

Non Dimmable
Dimmable 1-10V
Dimmable Dali 2
Casambi

60.9592
60.9439
RF30699
60.9207

* Vedi capitolo Drivers / Refer to the Drivers chapter

2700K

□ 05.7002.B1

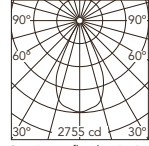

Luminous flux luminaire
1815 lm (EXTREME CUT OFF)

Beam Angle: 51°

h(m)	E(lx)	D(m)
1	2755	0.96
2	689	1.91
3	306	2.87
4	172	3.82
5	110	4.78

3000K

□ 05.7007.B1

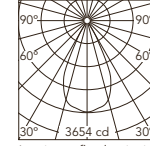

Luminous flux luminaire
2407 lm (EXTREME CUT OFF)

Beam Angle: 51°

h(m)	E(lx)	D(m)
1	3654	0.96
2	914	1.91
3	406	2.87
4	228	3.82
5	146	4.78

■ 05.7002.GL

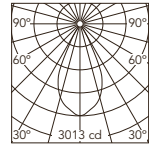

Luminous flux luminaire
1786 lm (EXTREME CUT OFF)

Beam Angle: 50°

h(m)	E(lx)	D(m)
1	3013	0.93
2	753	1.86
3	335	2.79
4	188	3.72
5	121	4.65

■ 05.7007.GL

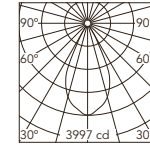

Luminous flux luminaire
2370 lm (EXTREME CUT OFF)

Beam Angle: 50°

h(m)	E(lx)	D(m)
1	3997	0.93
2	999	1.86
3	444	2.79
4	250	3.72
5	160	4.65

■ 05.7002.BU

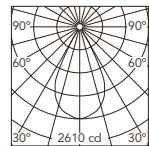

Luminous flux luminaire
1753 lm (EXTREME CUT OFF)

Beam Angle: 53°

h(m)	E(lx)	D(m)
1	2610	1.01
2	652	2.01
3	290	3.02
4	163	4.03
5	104	5.04

■ 05.7007.BU

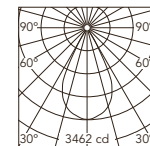

Luminous flux luminaire
2326 lm (EXTREME CUT OFF)

Beam Angle: 53°

h(m)	E(lx)	D(m)
1	3462	1.01
2	866	2.01
3	385	3.02
4	216	4.03
5	138	5.04

■ 05.7002.74

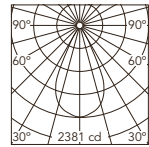

Luminous flux luminaire
1497 lm (EXTREME CUT OFF)

Beam Angle: 51°

h(m)	E(lx)	D(m)
1	2381	0.95
2	595	1.91
3	265	2.86
4	149	3.82
5	95	4.77

■ 05.7007.74

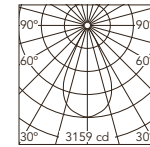

Luminous flux luminaire
1985 lm (EXTREME CUT OFF)

Beam Angle: 51°

h(m)	E(lx)	D(m)
1	3159	0.95
2	790	1.91
3	351	2.86
4	197	3.82
5	126	4.77

■ 05.7002.CU

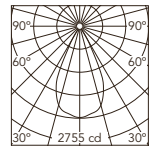

Luminous flux luminaire
1815 lm (EXTREME CUT OFF)

Beam Angle: 51°

h(m)	E(lx)	D(m)
1	2755	0.96
2	689	1.91
3	306	2.87
4	172	3.82
5	110	4.78

■ 05.7007.CU

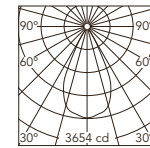

Luminous flux luminaire
2407 lm (EXTREME CUT OFF)

Beam Angle: 51°

h(m)	E(lx)	D(m)
1	3654	0.96
2	914	1.91
3	406	2.87
4	228	3.82
5	146	4.78

Easy Kap Ø105 Fixed EVO

Light Source: LED QR-CBC 51 GX5.3

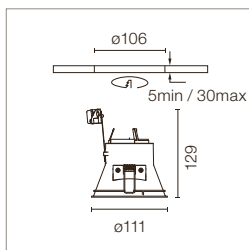

GWT
850°



0.23 Kg



IP
54



Incasso per lampada di 12V.
Trasformatore remoto non incluso.
Per sostituire la lampadina,
l'apparecchio deve essere tirato
fuori.
Cornice di installazione non
necessaria.
Accessori per lenti non disponibili.

Recessed 12V lamp luminaire.
Remote transformer not included.
To replace the bulb, the luminaire
must be removed.
Installation frame not necessary.
Not suitable for lens accessories.

05.7030.B1
 05.7030.GL
 05.7030.BU
 05.7030.74
 05.7030.CU

Easy Kap Ø105 Fixed EVO

Light Source: LED PAR 16 GZ10

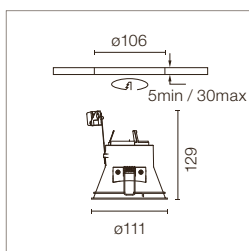

GWT
850°



0.23 Kg



IP
54



Incasso con alimentazione in
tensione di rete.
Per sostituire la lampadina,
l'apparecchio deve essere tirato
fuori.
Cornice di installazione non
necessaria.
Accessori per lenti non disponibili.

Recessed luminaire with main
voltage source.
To replace the bulb, the luminaire
must be removed.
Installation frame not necessary.
Not suitable for lens accessories.

05.7031.B1
 05.7031.GL
 05.7031.BU
 05.7031.74
 05.7031.CU

Easy Kap Ø105 Adjustable - Optic Spot

Light Source: LED Array DC 650 mA - 23W - 2690 lm - 2700K/CRI 90 / 23W - 2870 lm - 3000K/CRI 90

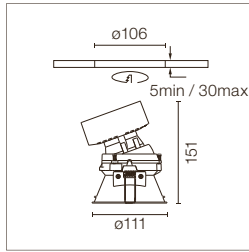

		IP 54
		h=161 min
		GWT 850°
		LED INCL
		0,77 Kg

Incasso a LED. Trasformatore remoto non incluso. Cornice di installazione non necessaria.

Recessed luminaire with LED light source. Remote transformer not included. Installation frame not necessary.

Alimentazioni raccomandate / Recommended power supply*:

- | | |
|-----------------|---------|
| Non Dimmable | 60.9592 |
| Dimmable 1-10V | 60.9439 |
| Dimmable Dali 2 | RF30699 |
| Casambi | 60.9207 |

* Vedi capitolo Drivers / Refer to the Drivers chapter

2700K
□ 05.7010.B1

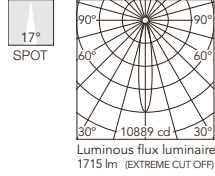

3000K
□ 05.7015.B1

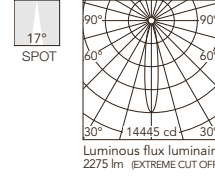

■ 05.7010.GL

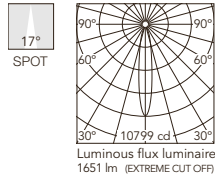

■ 05.7015.GL

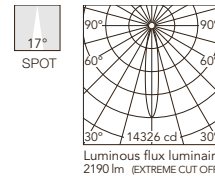

■ 05.7010.BU

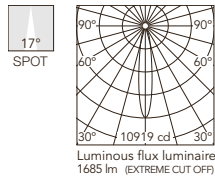

■ 05.7015.BU

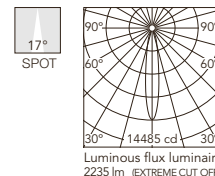

■ 05.7010.74

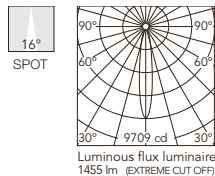

■ 05.7015.74

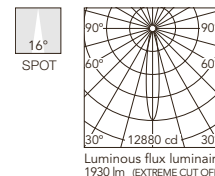

■ 05.7010.CU

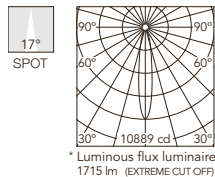

■ 05.7015.CU

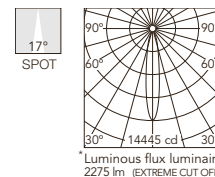

* Fotometrie preliminari. Consultare la nostra pagina web per informazioni aggiornate / Preliminary photometries. Visit our website for updated information.

Easy Kap Ø105 Adjustable - Optic Medium

Light Source: LED Array DC 650 mA - 23W - 2690 lm - 2700K/CRI 90 / 23W - 2870 lm - 3000K/CRI 90

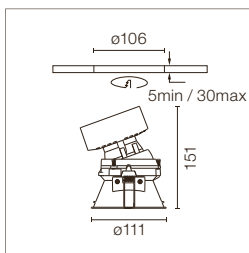

27°
 IP 54
 CE
 GWT 850°
 LED INCL
 0,77 Kg
 III

Incasso a LED. Trasformatore remoto non incluso. Cornice di installazione non necessaria.

Recessed luminaire with LED light source. Remote transformer not included. Installation frame not necessary.

Alimentazioni raccomandate / Recommended power supply*:

- Non Dimmable 60.9592
- Dimmable 1-10V 60.9439
- Dimmable Dali 2 RF30699
- Casambi 60.9207

* Vedi capitolo Drivers / Refer to the Drivers chapter

2700K
□ 05.7011.B1

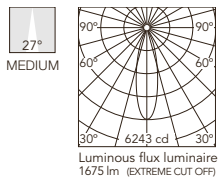

3000K
□ 05.7016.B1

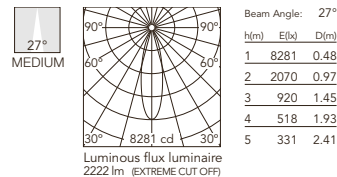

■ 05.7011.GL

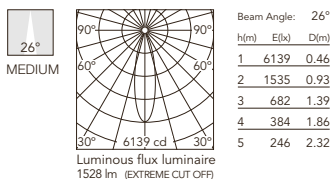

■ 05.7016.GL

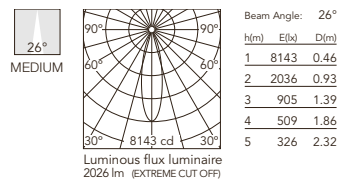

■ 05.7011.BU

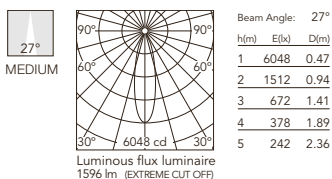

■ 05.7016.BU

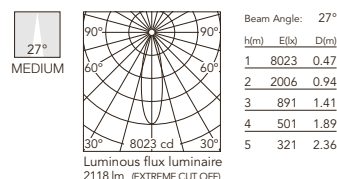

■ 05.7011.74

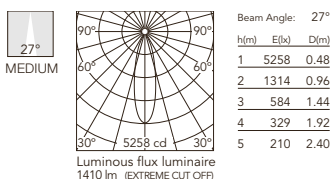

■ 05.7016.74

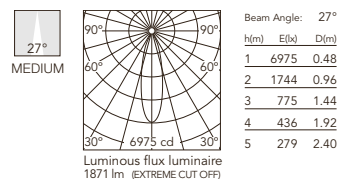

■ 05.7011.CU

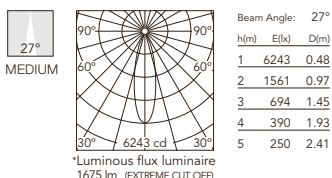

■ 05.7016.CU

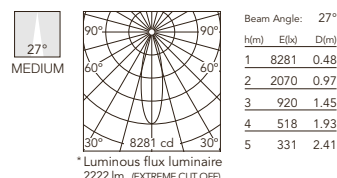

* Fotometrie preliminari. Consultare la nostra pagina web per informazioni aggiornate / Preliminary photometries. Visit our website for updated information.

Easy Kap Ø105 Adjustable - Optic Flood

Light Source: LED Array DC 650 mA - 23W - 2690 lm - 2700K/CRI 90 / 23W - 2870 lm - 3000K/CRI 90

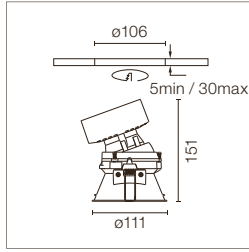

51°
 IP 54
 CE
 F
 GWT 850°
 LED INCL
 0,77 Kg
 III

Incasso a LED. Trasformatore remoto non incluso. Cornice di installazione non necessaria.

Recessed luminaire with LED light source. Remote transformer not included. Installation frame not necessary.

Alimentazioni raccomandate / Recommended power supply*:

- Non Dimmable 60.9592
- Dimmable 1-10V 60.9439
- Dimmable Dali 2 RF30699
- Casambi 60.9207

* Vedi capitolo Drivers / Refer to the Drivers chapter

2700K
□ 05.7012.B1

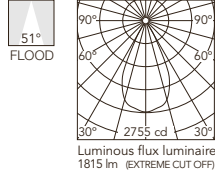

3000K
□ 05.7017.B1

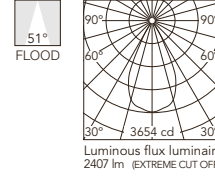

■ 05.7012.GL

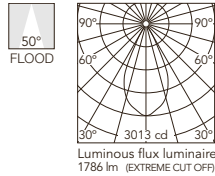

■ 05.7017.GL

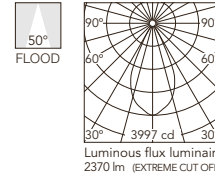

■ 05.7012.BU

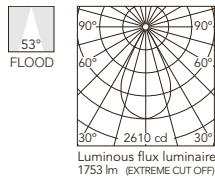

■ 05.7017.BU

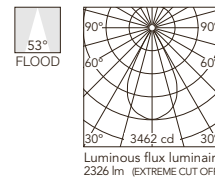

■ 05.7012.74

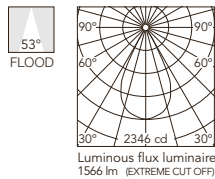

■ 05.7017.74

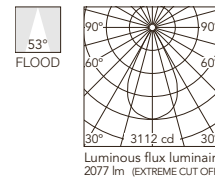

■ 05.7012.CU

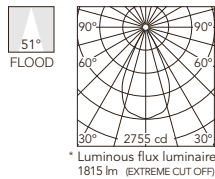

■ 05.7017.CU

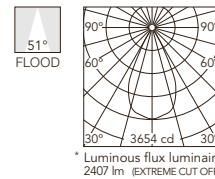

* Fotometrie preliminari. Consultare la nostra pagina web per informazioni aggiornate / Preliminary photometries. Visit our website for updated information.

Easy Kap Ø105 Adjustable

Light Source: LED QR-CBC 51 GX5.3

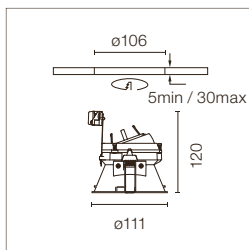

Incasso per lampada di 12V.
Trasformatore remoto non incluso.
Cornice di installazione non necessaria.
Accessori per lenti non disponibili.

Recessed 12V lamp luminaire.
Remote transformer not included.
Installation frame not necessary.
Not suitable for lens accessories.

05.7035.B1
05.7035.GL
05.7035.BU
05.7035.74
05.7035.CU

Easy Kap Ø105 Adjustable

Light Source: LED PAR 16 GZ10

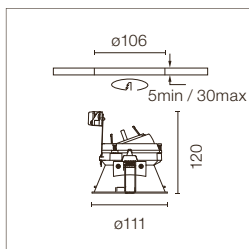

Incasso con alimentazione in tensione di rete.
Cornice di installazione non necessaria.
Accessori per lenti non disponibili.

Recessed luminaire with main voltage source.
Installation frame not necessary.
Not suitable for lens accessories.

05.7036.B1
05.7036.GL
05.7036.BU
05.7036.74
05.7036.CU

Easy Kap Ø105 Wall-Washer

Light Source: LED Array DC 650 mA - 23W - 2690 lm - 2700K/CRI 90 / 23W - 2870 lm - 3000K/CRI 90

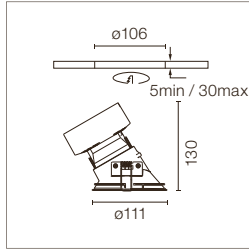

0.53 Kg GWT 850° LED INCL

 IP 54

Incasto a LED. Trasformatore elettronico remoto 220/240V non incluso.
Cornice di installazione non necessaria.

Recessed luminaire with LED light source. Remote electronic transformer 220/240V not included. Installation frame not necessary.

Alimentazioni raccomandate / Recommended power supply*:
 Non Dimmable 60.9592
 Dimmable 1-10V 60.9439
 Dimmable Dali 2 RF30699
 Casambi 60.9207

* Vedi capitolo Drivers / Refer to the Drivers chapter

2700K
05.7020.B1

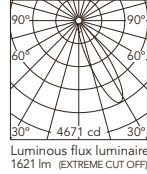

Beam Angle: 26°

h(m)	E(lx)	D(m)
1	4671	0.58
2	1168	1.15
3	519	1.73
4	292	2.31
5	187	2.89

3000K
05.7021.B1

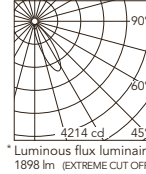

Beam Angle: 28°

h(m)	E(lx)	D(m)
1	4214	0.63
2	1054	1.26
3	468	1.89
4	263	2.52
5	169	3.16

05.7020.GL

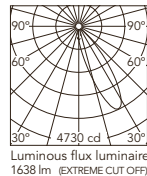

Beam Angle: 26°

h(m)	E(lx)	D(m)
1	4730	0.58
2	1183	1.15
3	526	1.73
4	296	2.31
5	189	2.89

05.7021.GL

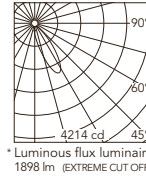

Beam Angle: 28°

h(m)	E(lx)	D(m)
1	4214	0.63
2	1054	1.26
3	468	1.89
4	263	2.52
5	169	3.16

05.7020.BU

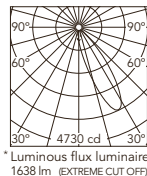

Beam Angle: 26°

h(m)	E(lx)	D(m)
1	4730	0.58
2	1183	1.15
3	526	1.73
4	296	2.31
5	189	2.89

05.7021.BU

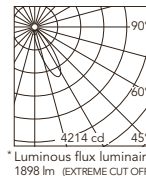

Beam Angle: 28°

h(m)	E(lx)	D(m)
1	4214	0.63
2	1054	1.26
3	468	1.89
4	263	2.52
5	169	3.16

05.7020.74

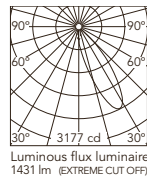

Beam Angle: 28°

h(m)	E(lx)	D(m)
1	3177	0.63
2	794	1.26
3	353	1.89
4	199	2.52
5	127	3.16

05.7021.74

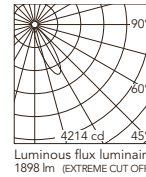

Beam Angle: 28°

h(m)	E(lx)	D(m)
1	4214	0.63
2	1054	1.26
3	468	1.89
4	263	2.52
5	169	3.16

05.7020.CU

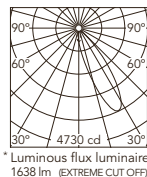

Beam Angle: 26°

h(m)	E(lx)	D(m)
1	4730	0.58
2	1183	1.15
3	526	1.73
4	296	2.31
5	189	2.89

05.7021.CU

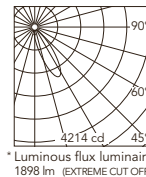

Beam Angle: 28°

h(m)	E(lx)	D(m)
1	4214	0.63
2	1054	1.26
3	468	1.89
4	263	2.52
5	169	3.16

* Fotometrie preliminari. Consultare la nostra pagina web per informazioni aggiornate / Preliminary photometries. Visit our website for updated information.

Easy Kap Ø105 Wall-Washer

Light Source: LED QR-CBC 51 GX5.3

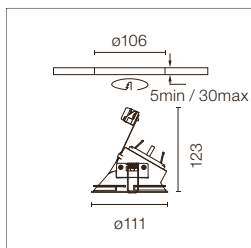

Incasso per lampada di 12V.
Trasformatore remoto non incluso.
Cornice di installazione non necessaria.
Accessori per lenti non disponibili.

Recessed 12V lamp luminaire.
Remote transformer not included.
Installation frame not necessary.
Not suitable for lens accessories.



05.7040.B1
05.7040.GL
05.7040.BU
05.7040.74
05.7040.CU

Easy Kap Ø105 Wall-Washer

Light Source: LED PAR 16 GZ10

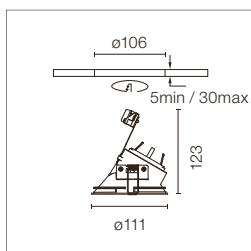

Incasso con alimentazione in tensione di rete.
Cornice di installazione non necessaria.
Accessori per lenti non disponibili.

Recessed luminaire with main voltage source.
Installation frame not necessary.
Not suitable for lens accessories.



05.7041.B1
05.7041.GL
05.7041.BU
05.7041.74
05.7041.CU

KAP

Accessori / Accessories

Cornice di installazione No Trim.
Kap ø50. Installation frame No Trim.
Kap ø50.  Kap ø50 Round
 08.9114.00



Cornice di installazione No Trim.
Kap ø80/ø80 Plus. Installation frame No Trim.
Kap ø80/ø80 Plus.  Kap ø80 Round
 08.9102.00

Cornice di installazione No Trim.
Kap 80 Square/80 Plus Square. Installation frame No Trim.
Kap 80 Square/80 Plus Square.  Kap 80 Square
 08.9103.00

Cornice di installazione No Trim.
Kap ø105 Deep. Installation frame No Trim.
Kap ø105 Deep.  Kap ø105 Deep
 08.9104.00

Cornice di installazione No Trim.
Kap ø105. Installation frame No Trim.
Kap ø105.  Kap ø105
 08.0132.00

Cornice di installazione No Trim.
Kap 105 Square. Installation frame No Trim.
Kap 105 Square.  Kap 105 Square
 08.8479.00

Cornice di installazione No Trim.
Kap ø145/ø145 Wall-Washer. Installation frame No Trim.
Kap ø145/ø145 Wall-Washer.  Kap ø145
ø165
 Kap ø145 W-W
 08.8156.00
 08.8251.00

Cornice di installazione Trim.
Kap ø145/ø145 Wall-Washer. Installation frame Trim.
Kap 145/ø145 Wall-Washer.  Kap ø145/Kap ø145 W-W
ø155
 08.8491.30
 08.8491.GL
 08.8491.BU
 08.8491.14

Can di installazione per cemento.
Kap ø105 Deep/ø145. Installation can for concrete.
Kap ø105 Deep/ø145.  Kap ø105 Deep
 08.8420.00
Kap ø145
 08.8421.00

BON JOUR

DESIGNED BY PHILIPPE STARCK

BON JOUR Ø45	BON JOUR Ø90	BON JOUR Ø145
		
LIGHT SOURCE POWER LED 6W 575 lm 2700K/CRI 90 615 lm 3000K/CRI 90	LIGHT SOURCE LED ARRAY 13,5W 1500 lm 2700K/CRI 90 1600 lm 3000K/CRI 90	LIGHT SOURCE LED ARRAY 27W 2600 lm 2700K/CRI 90 2720 lm 3000K/CRI 90

01 Bianco
01 White

CU Rame
CU Copper

14 Nero
14 Black



Descrizione

Apparecchio per illuminazione per il montaggio in controsoffitti.
Una volta installato, il bordo dell'apparecchio sporge dal soffitto di 10 mm creando un effetto estetico originale e molto raffinato. Il corpo dell'apparecchio per illuminazione è in alluminio a iniezione.
È disponibile in tre dimensioni: Ø45 mm, Ø90 mm e Ø145 mm.
Riflettore in alluminio anodizzato lucido con elemento diffusore in policarbonato.

Unità di Alimentazione

Cablaggio incluso, pronto per collegamento ad apparecchiatura remota.
Disponibile versione Dali dimmerabile.
Versioni senza driver e con driver da 110V disponibili su richiesta.

Accessori

- Cornice di installazione in materiale termoplastico per l'installazione in controsoffitti necessario per le versioni da Ø90 mm e Ø145 mm (non necessario per la versione da Ø45 mm).
- Nido d'ape e cilindro di schermatura a croce (inclusi nella versione da Ø45 mm).
- Accessori di schermatura disponibili per la versione Ø145, con le stesse finiture dell'apparecchio di illuminazione Bon Jour decorativo. Vedere il catalogo Flos "The Home Collection" per maggiori dettagli.

Informazioni Aggiuntive

Grado di protezione IP44.
Classe di isolamento II.

Conformità e Marchi di Qualità

Apparecchio conforme alla Normativa Tecnica Europea EN60598-1 e relative parti seconde.

Description

LED luminaire for recessed mounting on plasterboard ceilings.
Once installed, the luminaire edge sticks out of the ceiling 10 mm creating a unique and very refined aesthetic effect. The luminaire's body is injected with aluminium. It is available in three sizes: Ø45 mm, Ø90 mm and Ø145 mm. Reflector made of anodized gloss aluminium with diffuser element made of polycarbonate.

Power Supply

Cabling included, ready to be powered by included remote driver.
Dali dimmable version available.
Versions without driver and 110V driver available on request.

Accessories

- Installation frame made from thermoplastic material for installation in suspended ceilings required for the Ø90 mm and Ø145 mm versions (not necessary for Ø45 mm version).
- Honeycomb and cross screening cylinder (included for Ø45 mm version).
- Screening accessories available for the Ø145 version, with the same finishes as the decorative Bon Jour luminaire. See the Flos "The Home Collection" catalogue for more information.

Additional Information

IP44 protection grade.
Insulation class II.

Standard Compliance and Quality Marks

EN60598-1 European Technical Standards and any subsequent additions.



Ø45



Ø90 / Ø145

BON JOUR

Bon Jour Ø45

Light Source: Power LED DC 500 mA - 6W - 575 lm - 2700K/CRI 90 / 6W - 615 lm - 3000K/CRI 90

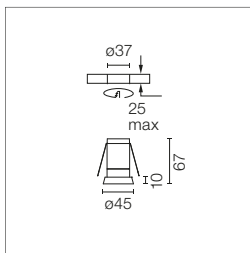

Apparecchio di illuminazione da incasso a LED. Fonte di alimentazione remota 220/240V inclusa. Accesso al driver attraverso lo spazio di incasso.

Recessed luminaire with LED light source. Remote 220/240V power supply included. It is necessary to anticipate a space for accessing the driver.

Accessori inclusi (honeycomb e filtro a croce antiabbagliamento).

Accessories included (honeycomb and screening crosspiece).

2700K

Non Dimmable

- 03.2001.01
- Dali Version
- 03.2001.01.DA

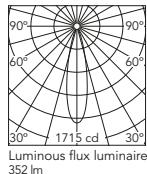

Beam Angle: 24°	h(m)	E(lx)	D(m)
1	1715	0.42	
2	429	0.84	
3	191	1.27	
4	107	1.69	
5	69	2.11	

Luminous flux luminaire 352 lm

3000K

Non Dimmable

- 03.2006.01
- Dali Version
- 03.2006.01.DA

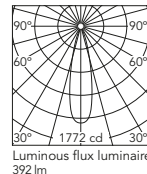

Beam Angle: 25°	h(m)	E(lx)	D(m)
1	1772	0.45	
2	443	0.89	
3	197	1.34	
4	111	1.79	
5	71	2.23	

Luminous flux luminaire 392 lm

2700K

Non Dimmable

- 03.2001.CU
- Dali Version
- 03.2001.CU.DA

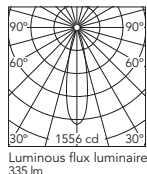

Beam Angle: 24°	h(m)	E(lx)	D(m)
1	1556	0.43	
2	389	0.85	
3	173	1.28	
4	97	1.71	
5	62	2.14	

Luminous flux luminaire 335 lm

3000K

Non Dimmable

- 03.2006.CU
- Dali Version
- 03.2006.CU.DA

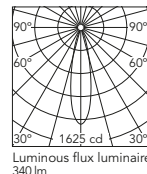

Beam Angle: 24°	h(m)	E(lx)	D(m)
1	1625	0.42	
2	406	0.83	
3	181	1.25	
4	102	1.67	
5	65	2.09	

Luminous flux luminaire 340 lm

2700K

Non Dimmable

- 03.2001.14
- Dali Version
- 03.2001.14.DA

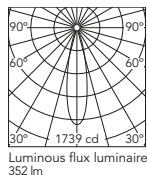

Beam Angle: 23°	h(m)	E(lx)	D(m)
1	1739	0.41	
2	435	0.83	
3	193	1.24	
4	109	1.66	
5	70	2.07	

Luminous flux luminaire 352 lm

3000K

Non Dimmable

- 03.2006.14
- Dali Version
- 03.2006.14.DA

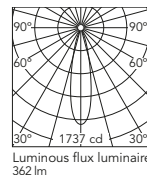

Beam Angle: 24°	h(m)	E(lx)	D(m)
1	1737	0.42	
2	434	0.84	
3	193	1.26	
4	109	1.68	
5	69	2.10	

Luminous flux luminaire 362 lm

Bon Jour Ø90

Light Source: LED Array DC 500 mA - 13,5W - 1500 lm - 2700K/CRI 90 / 13,5W - 1600 lm - 3000K/CRI 90

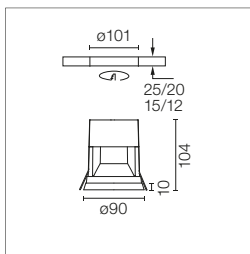

Apparecchio di illuminazione da incasso a LED. Fonte di alimentazione remota 220/240V inclusa.

Recessed luminaire with LED light source. Remote 220/240V power supply included.

Cornice di pre-installazione da ordinare separatamente.

Pre-installation frame must be ordered separately.

2700K

Non Dimmable

- 03.2003.01
- Dali Version
- 03.2003.01.DA

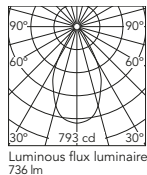

Beam Angle: 56°	h(m)	E(lx)	D(m)
1	793	1.07	
2	198	2.14	
3	88	3.21	
4	50	4.28	
5	32	5.35	

Luminous flux luminaire 736 lm

3000K

Non Dimmable

- 03.2007.01
- Dali Version
- 03.2007.01.DA

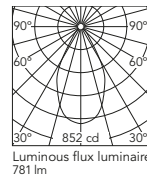

Beam Angle: 56°	h(m)	E(lx)	D(m)
1	852	1.06	
2	213	2.13	
3	95	3.19	
4	53	4.25	
5	34	5.32	

Luminous flux luminaire 781 lm

2700K

Non Dimmable

- 03.2003.CU
- Dali Version
- 03.2003.CU.DA

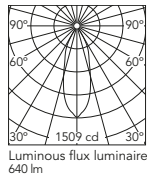

Beam Angle: 34°	h(m)	E(lx)	D(m)
1	1509	0.60	
2	377	1.21	
3	168	1.81	
4	94	2.42	
5	60	3.02	

Luminous flux luminaire 640 lm

3000K

Non Dimmable

- 03.2007.CU
- Dali Version
- 03.2007.CU.DA

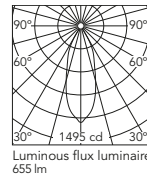

Beam Angle: 35°	h(m)	E(lx)	D(m)
1	1495	0.63	
2	374	1.26	
3	166	1.89	
4	93	2.52	
5	60	3.14	

Luminous flux luminaire 655 lm

2700K

Non Dimmable

- 03.2003.14
- Dali Version
- 03.2003.14.DA

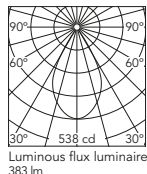

Beam Angle: 56°	h(m)	E(lx)	D(m)
1	538	1.07	
2	135	2.15	
3	60	3.22	
4	34	4.29	
5	22	5.37	

Luminous flux luminaire 383 lm

3000K

Non Dimmable

- 03.2007.14
- Dali Version
- 03.2007.14.DA

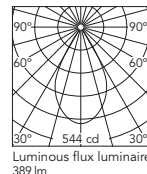

Beam Angle: 57°	h(m)	E(lx)	D(m)
1	544	1.08	
2	136	2.15	
3	60	3.23	
4	34	4.30	
5	22	5.38	

Luminous flux luminaire 389 lm

BON JOUR

Bon Jour Ø145

Light Source: LED Array DC 900 mA - 27W - 2600 lm - 2700K/CRI 90 / 27W - 2720 lm - 3000K/CRI 90

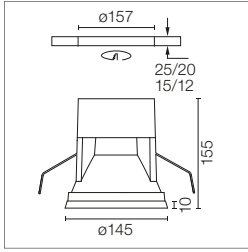

Apparecchio di illuminazione da incasso a LED. Fonte di alimentazione remota 220/240V inclusa.

Cornice di pre-installazione da ordinare separatamente.

Recessed luminaire with LED light source. Remote 220/240V power supply included.

Pre-installation frame must be ordered separately.

2700K

Non Dimmable

03.2005.01

Dali Version

03.2005.01.DA

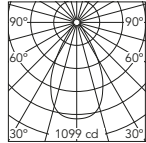

Beam Angle: 57°

h(m)	E(lx)	D(m)
1	1099	1.10
2	275	2.19
3	122	3.29
4	69	4.38
5	44	5.48

Luminous flux luminaire 1099 cd

Luminous flux luminaire 1085 lm

2700K

Non Dimmable

03.2005.CU

Dali Version

03.2005.CU.DA

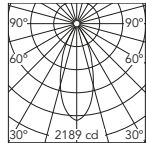

Beam Angle: 39°

h(m)	E(lx)	D(m)
1	2189	0.71
2	547	1.42
3	243	2.13
4	137	2.83
5	88	3.54

Luminous flux luminaire 2189 cd

Luminous flux luminaire 1063 lm

2700K

Non Dimmable

03.2005.14

Dali Version

03.2005.14.DA

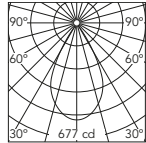

Beam Angle: 56°

h(m)	E(lx)	D(m)
1	677	1.05
2	169	2.11
3	75	3.16
4	42	4.21
5	27	5.27

Luminous flux luminaire 677 cd

Luminous flux luminaire 484 lm

3000K

Non Dimmable

03.2008.01

Dali Version

03.2008.01.DA

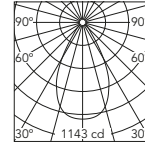

Beam Angle: 58°

h(m)	E(lx)	D(m)
1	1143	1.10
2	286	2.20
3	127	3.31
4	71	4.41
5	46	5.51

Luminous flux luminaire 1143 cd

Luminous flux luminaire 1135 lm

3000K

Non Dimmable

03.2008.CU

Dali Version

03.2008.CU.DA

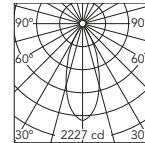

Beam Angle: 39°

h(m)	E(lx)	D(m)
1	2227	0.71
2	557	1.42
3	247	2.13
4	139	2.84
5	89	3.55

Luminous flux luminaire 2227 cd

Luminous flux luminaire 1085 lm

3000K

Non Dimmable

03.2008.14

Dali Version

03.2008.14.DA

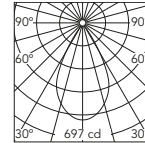

Beam Angle: 56°

h(m)	E(lx)	D(m)
1	697	1.06
2	174	2.11
3	77	3.17
4	44	4.23
5	28	5.28

Luminous flux luminaire 697 cd

Luminous flux luminaire 501 lm

Accessori / Accessories

Bon Jour Ø90

Cornice di pre-installazione.  08.8974.00
Pre-installation frame.

Honeycomb e filtro a croce antiabbagliamento.  08.8976.14

Honeycomb and screening crosspiece. 

Bon Jour Ø145

Cornice di pre-installazione.  08.8975.00
Pre-installation frame.

Honeycomb e filtro a croce antiabbagliamento.  08.8980.14

Honeycomb and screening crosspiece. 

Accessori decorativi di schermatura.  08.8977.00

Decorative screening accessory.  08.8978.00

 08.8979.00

LIGHT SHOOTER

DESIGNED BY FLOS ARCHITECTURAL

FIXED
TRIM / NO TRIM



ADJUSTABLE
TRIM / NO TRIM



WALL-WASHER
TRIM / NO TRIM



LIGHT SOURCE
POWER LED
10W
850 lm
2700K/CRI 90
910 lm
3000K/CRI 90

LIGHT SOURCE
HIGH
POWER LED
11W
910 lm
2700K/CRI 90
1060 lm
3000K/CRI 90

□ 40 Bianco
40 White

■ 14 Nero
14 Black



Può essere ruotato di 360° e orientato di 40°.
Can be rotated 360° and swivelled 40°.

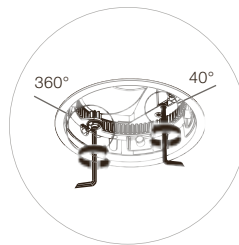
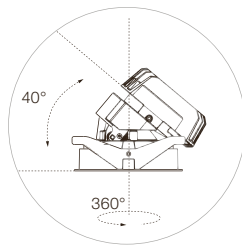

IP54

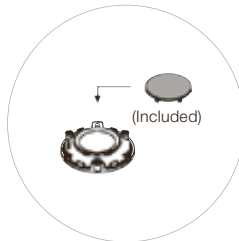

LIGHT SHOOTER

Descrizione

Apparecchi d'illuminazione a incasso tipo LED e dicroico LED ad alte prestazioni. Apparecchio d'illuminazione che abbina l'ultima tecnologia LED a un sistema conico estremamente efficiente, progettato per combinare un'elevata resa e un'alta protezione dall'abbagliamento. Disponibile con potenze fino a 11W in LED. Disponibile per installazioni Trim e No Trim e versioni fissa, regolabile e Wall-Washer.

La versione regolabile ha un goniometro integrato che aiuta a ottenere il fascio di luce desiderato con un meccanismo preciso e facile da usare che ne agevola la manipolazione e fa risparmiare tempo durante l'installazione. Il meccanismo di bloccaggio torx garantisce l'angolazione desiderata del fascio di luce.

Le versioni fissa e regolabile LED sono disponibili con ottiche chiuse e aperte (spot e flood).

Per garantire una perfetta coerenza all'interno dello stesso impianto, è disponibile anche la versione Wall-Washer con le medesime alternative LED delle versioni fissa e regolabile.

Riflettori

Le versioni fissa e regolabile LED sono disponibili con ottiche chiuse e aperte (spot e flood).

Unità di Alimentazione

Cablaggio incluso, pronto per collegamento ad apparecchiatura remota.

Versioni senza apparecchiatura e regolabili 1-10 V disponibili su richiesta.

Accessori

Tutti i modelli dispongono di accessorio integrato per renderli IP54.

- Lente di distribuzione ellittica.
- Honeycomb.

Informazioni Aggiuntive

Nelle versioni orientabili, possibilità di orientamento di 40° e di rotazione di 360°.

Grado di protezione IP44.

Classe di isolamento II.

Conformità e Marchi di Qualità

Apparecchio conforme alla Normativa Tecnica Europea EN60598-1 e relative parti seconde.

Description

High performance LED and LED dichroic recessed luminaires. Combines the latest LED technology and a very efficient conical system designed to combine high performance with excellent glare protection.

Available in wattages up to 11W in LED. Available for Trim and No Trim installations and fixed, adjustable and Wall-Washer versions.

The adjustable version has an integrated goniometer to achieve the desired beam and its easy-to-use precision mechanism makes it easy to handle and quick to install. Its Torx block mechanism ensures the desired beam angle.

The fixed and adjustable LED versions are available with enclosed and open optics (spot and flood).

To ensure complete coherency in the same installation, the Wall-Washer version is available with the same LED options as the fixed and adjustable versions.

Reflectors

The fixed and adjustable LED versions are available with enclosed and open optics (spot and flood).

Power Supply

Cabling included, ready to be powered by included remote driver.

Versions without driver and 1-10V dimmable available on request.

Accessories

All the models include an accessory for IP54.

- Elliptical distribution lens.
- Honeycomb.

Additional Information

In the adjustable versions, 40° tilting and 360° rotation.

IP44 protection grade.

Insulation class II.

Standard Compliance and Quality Marks

EN60598-1 European Technical Standards and any subsequent additions.



Trim



No Trim

LIGHT SHOOTER

Light Shooter Fixed Trim

Light Source: Power LED 10W - 850 lm - 2700K/CRI 90 / 10W - 910 lm - 3000K/CRI 90

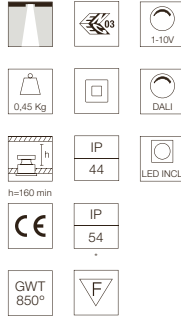
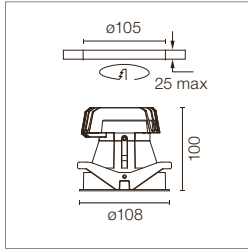

Apparecchio di illuminazione da incasso a LED ad alte prestazioni. Fonte di alimentazione remota 220-240V inclusa.
* Incorpora un accessorio per raggiungere il livello di IP54.

High-performance recessed luminaire with LED light source. Remote 220-240V power supply included.
* Accessory to reach IP54 incorporated.

Light Shooter Fixed No Trim

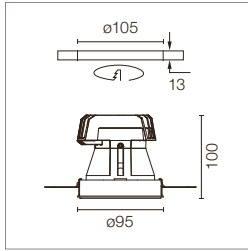

Cornice di pre-installazione inclusa nelle versioni No Trim.

Pre-installation frame included in No Trim versions.

2700K - Trim

Non Dimmable

- 03.6509.40A
- 03.6509.14A
- Dali Version/1-10V
- 03.6509.40ADA
- 03.6509.14ADA

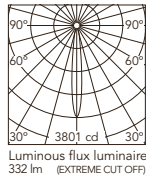

Beam Angle: 12°

h(m)	E(lx)	D(m)
1	3801	0.22
2	950	0.43
3	422	0.65
4	238	0.86
5	152	1.08

Luminous flux luminaire 332 lm (EXTREME CUT OFF)

3000K - Trim

Non Dimmable

- 03.6506.40A
- 03.6506.14A
- Dali Version/1-10V
- 03.6506.40ADA
- 03.6506.14ADA

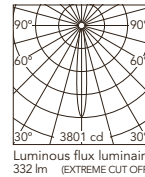

Beam Angle: 12°

h(m)	E(lx)	D(m)
1	3801	0.22
2	950	0.43
3	422	0.65
4	238	0.86
5	152	1.08

Luminous flux luminaire 332 lm (EXTREME CUT OFF)

2700K - No Trim

Non Dimmable

- 03.6529.40A
- 03.6529.14A
- Dali Version/1-10V
- 03.6529.40ADA
- 03.6529.14ADA

3000K - No Trim

Non Dimmable

- 03.6526.40A
- 03.6526.14A
- Dali Version/1-10V
- 03.6526.40ADA
- 03.6526.14ADA

2700K - Trim

Non Dimmable

- 03.6510.40A
- 03.6510.14A
- Dali Version/1-10V
- 03.6510.40ADA
- 03.6510.14ADA

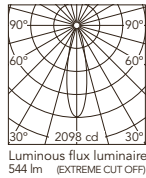

Beam Angle: 25°

h(m)	E(lx)	D(m)
1	2098	0.44
2	524	0.88
3	233	1.33
4	131	1.77
5	84	2.21

Luminous flux luminaire 544 lm (EXTREME CUT OFF)

3000K - Trim

Non Dimmable

- 03.6507.40A
- 03.6507.14A
- Dali Version/1-10V
- 03.6507.40ADA
- 03.6507.14ADA

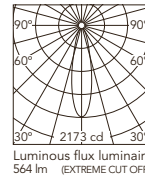

Beam Angle: 25°

h(m)	E(lx)	D(m)
1	2173	0.44
2	543	0.88
3	241	1.33
4	136	1.77
5	87	2.21

Luminous flux luminaire 564 lm (EXTREME CUT OFF)

2700K - No Trim

Non Dimmable

- 03.6530.40A
- 03.6530.14A
- Dali Version/1-10V
- 03.6530.40ADA
- 03.6530.14ADA

3000K - No Trim

Non Dimmable

- 03.6527.40A
- 03.6527.14A
- Dali Version/1-10V
- 03.6527.40ADA
- 03.6527.14ADA

LIGHT SHOOTER

Light Shooter Adjustable Trim

Light Source: Power LED 10W - 850 lm - 2700K/CRI 90 / 10W - 910 lm - 3000K/CRI 90

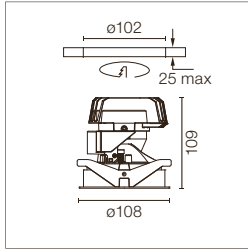

Apparecchio di illuminazione da incasso a LED ad alte prestazioni. Fonte di alimentazione remota 220-240V inclusa.
* Incorpora un accessorio per raggiungere il livello di IP54.

High-performance recessed luminaire with LED light source. Remote 220-240V power supply included.
* Accessory to reach IP54 incorporated.

Light Shooter Adjustable No Trim

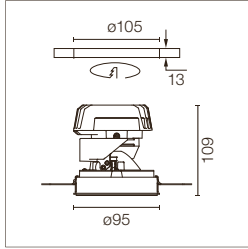

Cornice di pre-installazione inclusa nelle versioni No Trim.

Pre-installation frame included in No Trim versions.

2700K - Trim

Non Dimmable

- 03.6503.40A
- 03.6503.14A
- Dali Version/1-10V
- 03.6503.40ADA
- 03.6503.14ADA

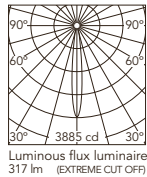

Beam Angle: 13°			
h(m)	E(lx)	D(m)	
1	3885	0.22	
2	971	0.44	
3	432	0.66	
4	243	0.88	
5	155	1.10	

3000K - Trim

Non Dimmable

- 03.6500.40A
- 03.6500.14A
- Dali Version/1-10V
- 03.6500.40ADA
- 03.6500.14ADA

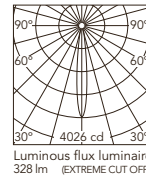

Beam Angle: 13°			
h(m)	E(lx)	D(m)	
1	4026	0.22	
2	1006	0.44	
3	447	0.66	
4	252	0.88	
5	161	1.10	

2700K - No Trim

Non Dimmable

- 03.6523.40A
- 03.6523.14A
- Dali Version/1-10V
- 03.6523.40ADA
- 03.6523.14ADA

3000K - No Trim

Non Dimmable

- 03.6520.40A
- 03.6520.14A
- Dali Version/1-10V
- 03.6520.40ADA
- 03.6520.14ADA

2700K - Trim

Non Dimmable

- 03.6504.40A
- 03.6504.14A
- Dali Version/1-10V
- 03.6504.40ADA
- 03.6504.14ADA

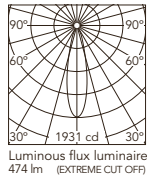

Beam Angle: 25°			
h(m)	E(lx)	D(m)	
1	1931	0.44	
2	483	0.88	
3	215	1.32	
4	121	1.75	
5	77	2.19	

3000K - Trim

Non Dimmable

- 03.6501.40A
- 03.6501.14A
- Dali Version/1-10V
- 03.6501.40ADA
- 03.6501.14ADA

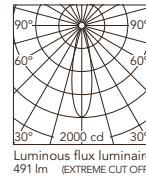

Beam Angle: 25°			
h(m)	E(lx)	D(m)	
1	2000	0.44	
2	500	0.88	
3	222	1.32	
4	125	1.75	
5	80	2.19	

2700K - No Trim

Non Dimmable

- 03.6524.40A
- 03.6524.14A
- Dali Version/1-10V
- 03.6524.40ADA
- 03.6524.14ADA

3000K - No Trim

Non Dimmable

- 03.6521.40A
- 03.6521.14A
- Dali Version/1-10V
- 03.6521.40ADA
- 03.6521.14ADA

LIGHT SHOOTER

Light Shooter Wall-Washer Trim

Light Source: Power LED 10W - 850 lm - 2700K/CRI 90 / 10W - 910 lm - 3000K/CRI 90

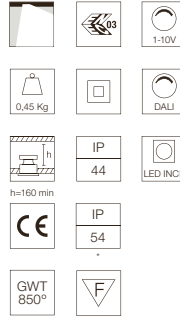
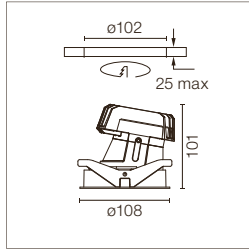

Apparecchio di illuminazione da incasso a LED ad alte prestazioni. Fonte di alimentazione remota 220-240V inclusa.
* Incorpora un accessorio per raggiungere il livello di IP54.

High-performance recessed luminaire with LED light source. Remote 220-240V power supply included.
* Accessory to reach IP54 incorporated.

Light Shooter Wall-Washer No Trim

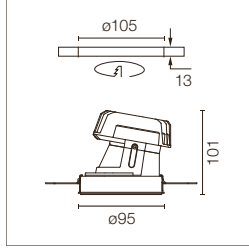

Cornice di pre-installazione inclusa nelle versioni No Trim.

Pre-installation frame included in No Trim versions.

2700K - Trim

Non Dimmable
03.6514.40A
03.6514.14A

Dali Version/1-10V
03.6514.40ADA
03.6514.14ADA

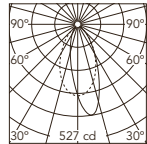

Luminous flux luminaire
407 lm (EXTREME CUT OFF)

Beam Angle: 34°

h(m)	E(lx)	D(m)
1	527	0.62
2	132	1.24
3	59	1.85
4	33	2.47
5	21	3.09

3000K - Trim

Non Dimmable
03.6512.40A
03.6512.14A

Dali Version/1-10V
03.6512.40ADA
03.6512.14ADA

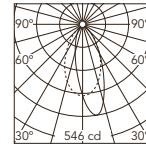

Luminous flux luminaire
421 lm (EXTREME CUT OFF)

Beam Angle: 34°

h(m)	E(lx)	D(m)
1	546	0.62
2	136	1.24
3	61	1.85
4	34	2.47
5	22	3.09

2700K - No Trim

Non Dimmable
03.6534.40A
03.6534.14A

Dali Version/1-10V
03.6534.40ADA
03.6534.14ADA

3000K - No Trim

Non Dimmable
03.6532.40A
03.6532.14A

Dali Version/1-10V
03.6532.40ADA
03.6532.14ADA

LIGHT SHOOTER

Light Shooter HP Fixed Trim

Light Source: High Power LED 11W - 910 lm - 2700K/CRI 90 / 11W - 1060 lm - 3000K/CRI 90

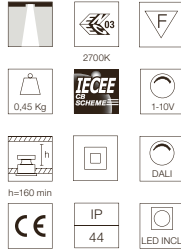
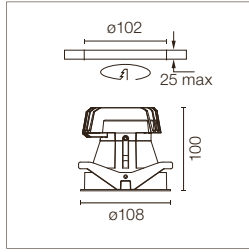

Apparecchio di illuminazione da incasso a LED ad alte prestazioni. Fonte di alimentazione remota 220-240V inclusa.
* Incorpora un accessorio per raggiungere il livello di IP54.

High-performance recessed luminaire with LED light source. Remote 220-240V power supply included.
* Accessory to reach IP54 incorporated.

Light Shooter HP Fixed No Trim

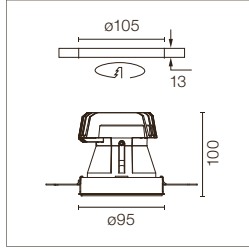

Cornice di pre-installazione inclusa nelle versioni No Trim.

Pre-installation frame included in No Trim versions.

2700K - Trim

Non Dimmable

- 03.6566.40
- 03.6566.14
- Dali Version/1-10V
- 03.6566.40.DA
- 03.6566.14.DA

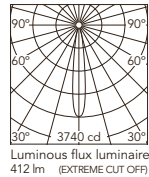

Beam Angle: 15°	h(m)	E(lx)	D(m)
1	3740	0.26	
2	935	0.53	
3	416	0.79	
4	234	1.05	
5	150	1.31	

3000K - Trim

Non Dimmable

- 03.6564.40A
- 03.6564.14A
- Dali Version/1-10V
- 03.6564.40ADA
- 03.6564.14ADA

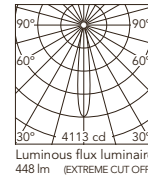

Beam Angle: 15°	h(m)	E(lx)	D(m)
1	4113	0.26	
2	1028	0.52	
3	457	0.78	
4	257	1.04	
5	165	1.30	

2700K - No Trim

Non Dimmable

- 03.6576.40
- 03.6576.14
- Dali Version/1-10V
- 03.6576.40.DA
- 03.6576.14.DA

3000K - No Trim

Non Dimmable

- 03.6574.40A
- 03.6574.14A
- Dali Version/1-10V
- 03.6574.40ADA
- 03.6574.14ADA

2700K - Trim

Non Dimmable

- 03.6567.40
- 03.6567.14
- Dali Version/1-10V
- 03.6567.40.DA
- 03.6567.14.DA

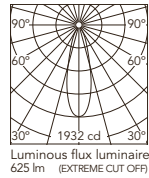

Beam Angle: 29°	h(m)	E(lx)	D(m)
1	1932	0.52	
2	483	1.04	
3	215	1.56	
4	121	2.08	
5	77	2.60	

3000K - Trim

Non Dimmable

- 03.6565.40A
- 03.6565.14A
- Dali Version/1-10V
- 03.6565.40ADA
- 03.6565.14ADA

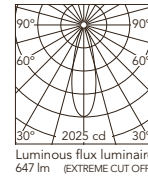

Beam Angle: 29°	h(m)	E(lx)	D(m)
1	2025	0.52	
2	506	1.04	
3	225	1.56	
4	127	2.08	
5	81	2.60	

2700K - No Trim

Non Dimmable

- 03.6577.40
- 03.6577.14
- Dali Version/1-10V
- 03.6577.40.DA
- 03.6577.14.DA

3000K - No Trim

Non Dimmable

- 03.6575.40A
- 03.6575.14A
- Dali Version/1-10V
- 03.6575.40ADA
- 03.6575.14ADA

LIGHT SHOOTER

Light Shooter HP Adjustable Trim

Light Source: High Power LED 11W - 910 lm - 2700K/CRI 90 / 11W - 1060 lm - 3000K/CRI 90

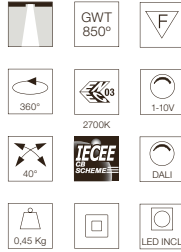
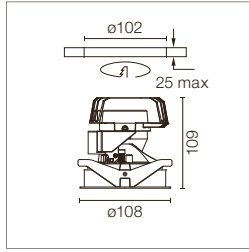

Apparecchio di illuminazione da incasso a LED ad alte prestazioni. Fonte di alimentazione remota 220-240V inclusa.
* Incorpora un accessorio per raggiungere il livello di IP54.

High-performance recessed luminaire with LED light source. Remote 220-240V power supply included.
* Accessory to reach IP54 incorporated.

Light Shooter HP Adjustable No Trim

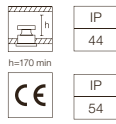
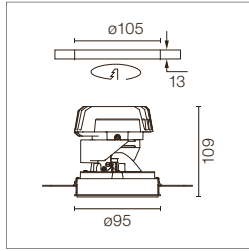

Cornice di pre-installazione inclusa nelle versioni No Trim.

Pre-installation frame included in No Trim versions.

2700K - Trim

Non Dimmable
03.6562.40
03.6562.14
Dali Version/1-10V
03.6562.40.DA
03.6562.14.DA

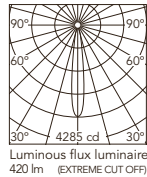

Beam Angle: 14°			
h(m)	E(lx)	D(m)	
1	4285	0.25	
2	1071	0.51	
3	476	0.76	
4	268	1.02	
5	171	1.27	

Luminous flux luminaire 420 lm (EXTREME CUT OFF)

3000K - Trim

Non Dimmable
03.6560.40A
03.6560.14A
Dali Version/1-10V
03.6560.40ADA
03.6560.14ADA

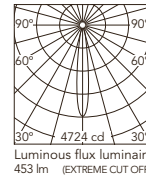

Beam Angle: 14°			
h(m)	E(lx)	D(m)	
1	4724	0.25	
2	1181	0.50	
3	525	0.75	
4	295	0.99	
5	189	1.24	

Luminous flux luminaire 453 lm (EXTREME CUT OFF)

2700K - No Trim

Non Dimmable
03.6572.40
03.6572.14
Dali Version/1-10V
03.6572.40.DA
03.6572.14.DA

3000K - No Trim

Non Dimmable
03.6570.40A
03.6570.14A
Dali Version/1-10V
03.6570.40ADA
03.6570.14ADA

2700K - Trim

Non Dimmable
03.6563.40
03.6563.14
Dali Version/1-10V
03.6563.40.DA
03.6563.14.DA

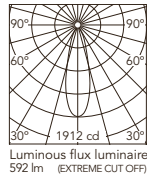

Beam Angle: 29°			
h(m)	E(lx)	D(m)	
1	1912	0.51	
2	478	1.03	
3	212	1.54	
4	119	2.05	
5	76	2.56	

Luminous flux luminaire 592 lm (EXTREME CUT OFF)

3000K - Trim

Non Dimmable
03.6561.40A
03.6561.14A
Dali Version/1-10V
03.6561.40ADA
03.6561.14ADA

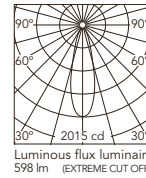

Beam Angle: 28°			
h(m)	E(lx)	D(m)	
1	2015	0.50	
2	504	1.01	
3	224	1.51	
4	126	2.02	
5	81	2.52	

Luminous flux luminaire 598 lm (EXTREME CUT OFF)

2700K - No Trim

Non Dimmable
03.6573.40
03.6573.14
Dali Version/1-10V
03.6573.40.DA
03.6573.14.DA

3000K - No Trim

Non Dimmable
03.6571.40A
03.6571.14A
Dali Version/1-10V
03.6571.40ADA
03.6571.14ADA

LIGHT SHOOTER

Light Shooter HP Wall-Washer Trim

Light Source: High Power LED 11W - 910 lm - 2700K/CRI 90 / 11W - 1060 lm - 3000K/CRI 90

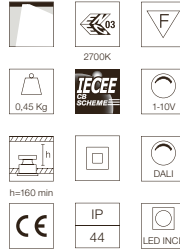
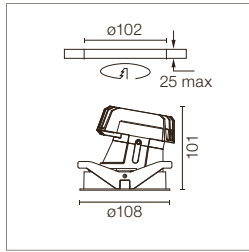

Apparecchio di illuminazione da incasso a LED ad alte prestazioni. Fonte di alimentazione remota 220-240V inclusa.
* Incorpora un accessorio per raggiungere il livello di IP54.

High-performance recessed luminaire with LED light source. Remote 220-240V power supply included.
* Accessory to reach IP54 incorporated.

Light Shooter HP Wall-Washer No Trim

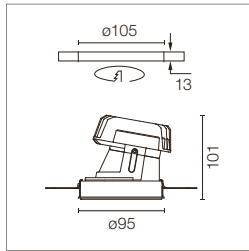

Cornice di pre-installazione inclusa nelle versioni No Trim.

Pre-installation frame included in No Trim versions.

2700K - Trim

Non Dimmable

- 03.6569.40
- 03.6569.14
- Dali Version/1-10V
- 03.6569.40.DA
- 03.6569.14.DA

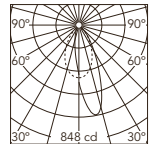

Luminous flux luminaire
529 lm (EXTREME CUT OFF)

Beam Angle: 26°

h(m)	E lx	D(m)
1	848	0.49
2	212	0.98
3	94	1.47
4	53	1.96
5	34	2.45

3000K - Trim

Non Dimmable

- 03.6568.40A
- 03.6568.14A
- Dali Version/1-10V
- 03.6568.40ADA
- 03.6568.14ADA

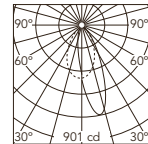

Luminous flux luminaire
577 lm (EXTREME CUT OFF)

Beam Angle: 27°

h(m)	E lx	D(m)
1	901	0.51
2	225	1.02
3	100	1.53
4	56	2.04
5	36	2.55

2700K - No Trim

Non Dimmable

- 03.6579.40
- 03.6579.14
- Dali Version/1-10V
- 03.6579.40.DA
- 03.6579.14.DA

3000K - No Trim

Non Dimmable

- 03.6578.40A
- 03.6578.14A
- Dali Version/1-10V
- 03.6578.40ADA
- 03.6578.14ADA

Accessori / Accessories

Lente ellittica.

Elliptical lens.



08.8041.68

Honeycomb.

Honeycomb.



08.8412.14

LIGHT SNIPER

DESIGNED BY FLOS ARCHITECTURAL

FIXED ADJUSTABLE WALL-
WASHER



LIGHT SOURCE
POWER LED
11W
910 lm
2700K/CRI 90
1060 lm
3000K/CRI 90

06 Cromo
06 Chrome

GL Oro Satinato
GL Matt Gold

14 Nero Opaco
14 Matt Black

Light Sniper
Round / Square



Può essere ruotato di 360° e orientato di 35°.
Can be rotated 360° and swivelled 35°.

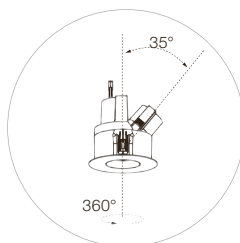

LIGHT SNIPER

Descrizione

Apparecchi di illuminazione ad incasso ad alto rendimento per lampade LED. Offrono un elevato comfort dovuto alla posizione arretrata della fonte di luce visiva.

Corpo dell'apparecchio realizzato in due parti di alluminio pressofuso. Cornice frontale, rotonda o quadrata, in lamiera di acciaio di 1 mm di spessore, finitura bianco opaco (RAL 9001). Schermo a forma di cono realizzato ad iniezione di zama in tre finiture: nero, oro opaco e cromo. Versioni fisse, basculanti e wall-washer.

Nelle versioni wall-washer la lente di distribuzione è in borosilicato.

Unità di Alimentazione

Precablaggio incluso, pronto per essere alimentato da dispositivi remoti.

Alimentatore compreso 220-240V.

Accessori

- Accessorio di protezione per soffitto. Consigliato per installazione nei soffitti fragili.
- Accessorio flush. Permette l'installazione a filo su parete o soffitto.
- Accessorio CAN facilita l'installazione in soffitti di calcestruzzo. È necessario disporre dell'accessorio da installare prima di realizzare il soffitto in calcestruzzo.
- Honeycomb.
- Filtri cromatici.

Informazioni Aggiuntive

Nelle versioni orientabili, possibilità di orientamento di 40° e di rotazione di 360°.

Grado di protezione IP23, IP44, a seconda delle versioni. Classe di isolamento I, II, III, a seconda delle versioni.

Adatti ad installazioni su superfici normalmente incombustibili.

Conformità e Marchi di Qualità

Apparecchio conforme alla Normativa Tecnica Europea EN60598-1 e relative parti seconde.

Description

High performance recessed luminaires for LED version. They offer a high comfort due to the back visual position of light source.

Body of the luminaire made of two bodies of injected aluminium. Round or square front ring made of steel sheet 1 mm thick with white matt finish (RAL 9001). It incorporates shielded cones made in zamak injection in three sets: black, matt gold and chrome. Fixed, tilt and wall-washers versions.

In wall-washer versions a distribution lens made of borosilicate is incorporated.

Power Supply

Cabling included, ready to be powered by remote devices. Remote 220-240V power supply included.

Accessories

- Accessory for ceiling protection. Recommended for delicate ceiling installation.
- Accessory flush. Allows flush installation to ceiling or wall.
- CAN accessory for installation in concrete. Facilitates installation on concrete ceilings. It is necessary to install fixture prior to the concrete ceiling.
- Honeycomb.
- Chromatic filters.

Additional Information

In the adjustable versions, the possibility of tilting of 40° and 360° rotation.

IP23, IP44 protection grade depending on the versions.

Insulation class I, II, III depending on the versions.

Suitable for installation on normally inflammable surfaces.

Standard Compliance and Quality Marks

EN60598-1 European Technical Standards and any subsequent additions.



Fixed



Adjustable

LIGHT SNIPER

Light Sniper Fixed Round

Light Source: Power LED 11W - 910 lm - 2700K/CRI 90 / 11W - 1060 lm - 3000K/CRI 90

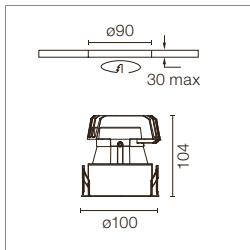

	GWT 850°	IP 44
	0,49 Kg	
	h=165 min	03.4981

Apparecchio di illuminazione da incasso a LED ad alte prestazioni. Fonte di alimentazione remota 220-240V inclusa.

High-performance recessed luminaire with LED light source. Remote 220-240V power supply included.

2700K

Non Dimmable

- 03.4981.06
- 03.4981.GL
- 03.4981.14
- Dali Version / 1-10V / Push
- 03.4981.06.DA
- 03.4981.GL.DA
- 03.4981.14.DA

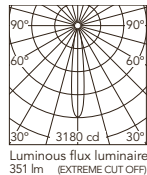

Beam Angle: 15°

3000K

Non Dimmable

- 03.4980.06A
- 03.4980.GLA
- 03.4980.14A
- Dali Version / 1-10V / Push
- 03.4980.06ADA
- 03.4980.GLADA
- 03.4980.14ADA

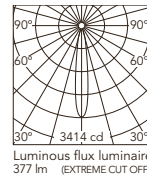

Beam Angle: 15°

2700K

Non Dimmable

- 03.4993.06
- 03.4993.GL
- 03.4993.14
- Dali Version / 1-10V / Push
- 03.4993.06.DA
- 03.4993.GL.DA
- 03.4993.14.DA

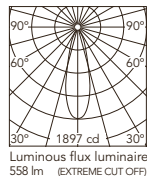

Beam Angle: 28°

3000K

Non Dimmable

- 03.4992.06A
- 03.4992.GLA
- 03.4992.14A
- Dali Version / 1-10V / Push
- 03.4992.06ADA
- 03.4992.GLADA
- 03.4992.14ADA

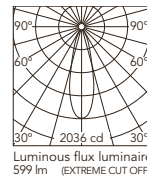

Beam Angle: 28°

Light Sniper Fixed Square

Light Source: Power LED 11W - 910 lm - 2700K/CRI 90 / 11W - 1060 lm - 3000K/CRI 90

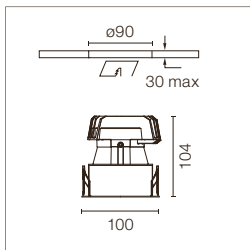

	GWT 850°	IP 44
	0,49 Kg	
	h=165 min	03.4983

Apparecchio di illuminazione da incasso a LED ad alte prestazioni. Fonte di alimentazione remota 220-240V inclusa.

High-performance recessed luminaire with LED light source. Remote 220-240V power supply included.

2700K

Non Dimmable

- 03.4983.06
- 03.4983.GL
- 03.4983.14
- Dali Version / 1-10V / Push
- 03.4983.06.DA
- 03.4983.GL.DA
- 03.4983.14.DA

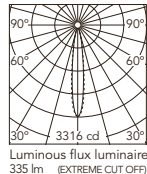

Beam Angle: 14°

3000K

Non Dimmable

- 03.4982.06A
- 03.4982.GLA
- 03.4982.14A
- Dali Version / 1-10V / Push
- 03.4982.06ADA
- 03.4982.GLADA
- 03.4982.14ADA

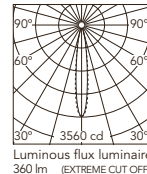

Beam Angle: 14°

2700K

Non Dimmable

- 03.4995.06
- 03.4995.GL
- 03.4995.14
- Dali Version / 1-10V / Push
- 03.4995.06.DA
- 03.4995.GL.DA
- 03.4995.14.DA

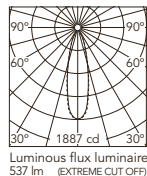

Beam Angle: 26°

3000K

Non Dimmable

- 03.4994.06A
- 03.4994.GLA
- 03.4994.14A
- Dali Version / 1-10V / Push
- 03.4994.06ADA
- 03.4994.GLADA
- 03.4994.14ADA

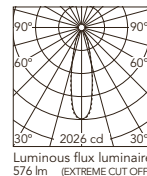

Beam Angle: 26°

LIGHT SNIPER

Light Sniper Adjustable Round

Light Source: Power LED 11W - 910 lm - 2700K/CRI 90 / 11W - 1060 lm - 3000K/CRI 90

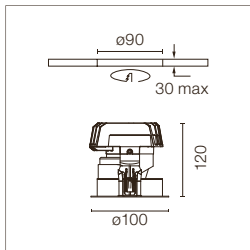

IP 44
 0,65 Kg 850° DALI
 360° 03.4985 LED INCL
 35° h=155 mm

Apparecchio di illuminazione da incasso a LED ad alte prestazioni. Fonte di alimentazione remota 220-240V inclusa.

High-performance recessed luminaire with LED light source. Remote 220-240V power supply included.

2700K

Non Dimmable

- 03.4985.06
- 03.4985.GL
- 03.4985.14
- Dali Version / 1-10V / Push
- 03.4985.06.DA
- 03.4985.GL.DA
- 03.4985.14.DA

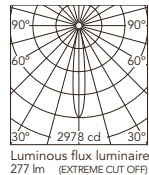

Beam Angle: 15°

h(m)	E(lx)	D(m)
1	2978	0.26
2	744	0.52
3	331	0.78
4	186	1.04
5	119	1.30

3000K

Non Dimmable

- 03.4984.06A
- 03.4984.GLA
- 03.4984.14A
- Dali Version / 1-10V / Push
- 03.4984.06ADA
- 03.4984.GLADA
- 03.4984.14ADA

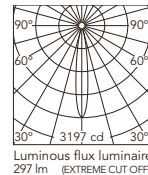

Beam Angle: 15°

h(m)	E(lx)	D(m)
1	3197	0.26
2	799	0.52
3	355	0.78
4	200	1.04
5	128	1.30

2700K

Non Dimmable

- 03.4997.06
- 03.4997.GL
- 03.4997.14
- Dali Version / 1-10V / Push
- 03.4997.06.DA
- 03.4997.GL.DA
- 03.4997.14.DA

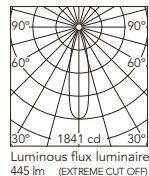

Beam Angle: 25°

h(m)	E(lx)	D(m)
1	1841	0.44
2	460	0.88
3	205	1.32
4	115	1.76
5	74	2.19

3000K

Non Dimmable

- 03.4996.06A
- 03.4996.GLA
- 03.4996.14A
- Dali Version / 1-10V / Push
- 03.4996.06ADA
- 03.4996.GLADA
- 03.4996.14ADA

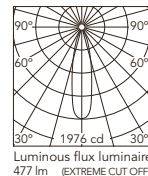

Beam Angle: 25°

h(m)	E(lx)	D(m)
1	1976	0.44
2	494	0.88
3	220	1.32
4	124	1.76
5	79	2.19

Light Sniper Adjustable Square

Light Source: Power LED 11W - 910 lm - 2700K/CRI 90 / 11W - 1060 lm - 3000K/CRI 90

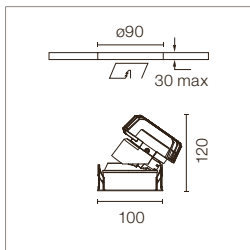

IP 44
 0,65 Kg 850° DALI
 360° 03.4987 LED INCL
 35° h=155 mm

Apparecchio di illuminazione da incasso a LED ad alte prestazioni. Fonte di alimentazione remota 220-240V inclusa.

High-performance recessed luminaire with LED light source. Remote 220-240V power supply included.

2700K

Non Dimmable

- 03.4987.06
- 03.4987.GL
- 03.4987.14
- Dali Version / 1-10V / Push
- 03.4987.06.DA
- 03.4987.GL.DA
- 03.4987.14.DA

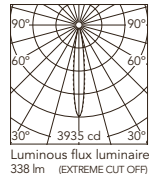

Beam Angle: 13°

h(m)	E(lx)	D(m)
1	3935	0.23
2	984	0.47
3	437	0.70
4	246	0.94
5	157	1.17

3000K

Non Dimmable

- 03.4986.06A
- 03.4986.GLA
- 03.4986.14A
- Dali Version / 1-10V / Push
- 03.4986.06ADA
- 03.4986.GLADA
- 03.4986.14ADA

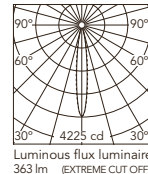

Beam Angle: 13°

h(m)	E(lx)	D(m)
1	4225	0.23
2	1056	0.47
3	469	0.70
4	264	0.94
5	169	1.17

2700K

Non Dimmable

- 03.4999.06
- 03.4999.GL
- 03.4999.14
- Dali Version / 1-10V / Push
- 03.4999.06.DA
- 03.4999.GL.DA
- 03.4999.14.DA

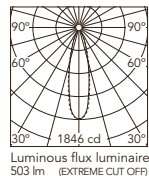

Beam Angle: 25°

h(m)	E(lx)	D(m)
1	1846	0.45
2	462	0.89
3	205	1.34
4	115	1.79
5	74	2.24

3000K

Non Dimmable

- 03.4998.06A
- 03.4998.GLA
- 03.4998.14A
- Dali Version / 1-10V / Push
- 03.4998.06ADA
- 03.4998.GLADA
- 03.4998.14ADA

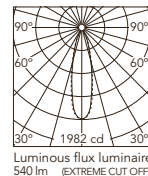

Beam Angle: 25°

h(m)	E(lx)	D(m)
1	1982	0.45
2	495	0.89
3	220	1.34
4	124	1.79
5	79	2.24

LIGHT SNIPER

Light Sniper Wall-Washer Round

Light Source: Power LED 11W - 910 lm - 2700K/CRI 90 / 11W - 1060 lm - 3000K/CRI 90

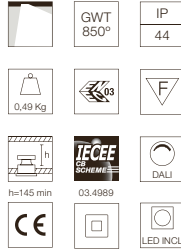
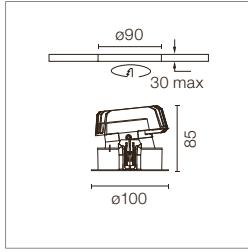

Apparecchio di illuminazione da incasso a LED ad alte prestazioni. Fonte di alimentazione remota 220-240V inclusa.

High-performance recessed luminaire with LED light source. Remote 220-240V power supply included.

2700K

Non Dimmable
03.4989.06

Dali Version / 1-10V / Push
03.4989.06.DA

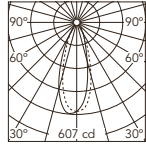

Luminous flux luminaire
322 lm (EXTREME CUT OFF)

Beam Angle: 35°

h(m)	E(lx)	D(m)
1	607	0.63
2	152	1.26
3	67	1.90
4	38	2.53
5	24	3.16

3000K

Non Dimmable
03.4988.06A

Dali Version / 1-10V / Push
03.4988.06ADA

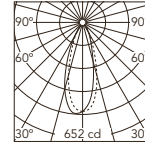

Luminous flux luminaire
346 lm (EXTREME CUT OFF)

Beam Angle: 35°

h(m)	E(lx)	D(m)
1	652	0.63
2	163	1.26
3	72	1.90
4	41	2.53
5	26	3.16

Light Sniper Wall-Washer Square

Light Source: Power LED 11W - 910 lm - 2700K/CRI 90 / 11W - 1060 lm - 3000K/CRI 90

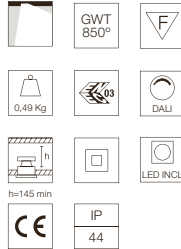
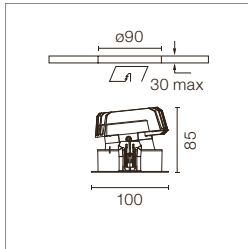

Apparecchio di illuminazione da incasso a LED ad alte prestazioni. Fonte di alimentazione remota 220-240V inclusa.

High-performance recessed luminaire with LED light source. Remote 220-240V power supply included.

2700K

Non Dimmable
03.4991.06

Dali Version / 1-10V / Push
03.4991.06.DA

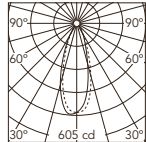

Luminous flux luminaire
316 lm (EXTREME CUT OFF)

Beam Angle: 34°

h(m)	E(lx)	D(m)
1	605	0.61
2	151	1.23
3	67	1.84
4	38	2.46
5	24	3.07

3000K

Non Dimmable
03.4990.06A

Dali Version / 1-10V / Push
03.4990.06ADA

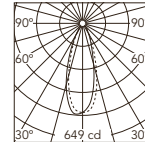

Luminous flux luminaire
339 lm (EXTREME CUT OFF)

Beam Angle: 34°

h(m)	E(lx)	D(m)
1	649	0.61
2	162	1.23
3	72	1.84
4	41	2.46
5	26	3.07

LIGHT SNIPER

Accessori / Accessories

Per aumentare le prestazioni degli apparecchi della famiglia Light Sniper sono disponibili i seguenti accessori:

- Accessorio di protezione per soffitto. Consigliato per installazioni nei soffitti fragili.
 - Accessorio "flush" che permette l'installazione a filo su parete o soffitto.
 - Accessorio "CAN" che facilita l'installazione in soffitti di calcestruzzo.
- È necessario disporre dell'accessorio da installare prima di realizzare il soffitto in calcestruzzo.
- Filtri colorati.

Cornice rotonda per installazioni a soffitto a filo.



08.8239.00B

Flush ceiling round frame accessory.

Cornice quadrata per installazioni a soffitto a filo.



08.8240.00B

Flush ceiling square frame accessory.

Accessorio di protezione per soffitto.



1 Unit

08.8243.00

10 Units

08.8243.00.1U

50 Units

08.8243.00.5U

Ceiling protector accessory.

Corpo a incasso in calcestruzzo.



08.8250.00

Concrete instalation can.

Accessorio di protezione per soffitto.



Round

08.8229.30A

Ceiling protector accessory.



Square

08.8222.30A

In order to increase the performances of the Light Sniper family, the following accessories are available:

- Accessory for ceiling protection. Recommended for delicate ceiling installation.
- "Flush" accessory, which allows a flush installation with the ceiling or wall.
- CAN accessory for installation in concrete. It facilitates installation on concrete ceilings. It is necessary to obtain and to install the accessory prior to the concrete ceiling.
- Color filters.

Lente ellittica
Elliptical lens



08.8041.68

Honeycomb
Honeycomb



08.8412.14

UT DOWNLIGHT

DESIGNED BY FLOS ARCHITECTURAL

TRIM / NO TRIM
Ø 57



LIGHT SOURCE

LED ARRAY
18W
2000 lm
3000K/CRI 80
1600 lm
3000K/CRI 90
4000K/CRI 90

TRIM / NO TRIM
Ø 86



LIGHT SOURCE

LED ARRAY
HIGH
PERFORMANCES
27W
3214 lm
3000K/CRI 80
2656 lm
3000K/CRI 90
2767 lm
4000K/CRI 90

□ 30 Bianco
30 White

■ 14 Nero
14 Black



Può essere ruotato di 360° e orientato di 90°.
Can be rotated 360° and swivelled 90°.

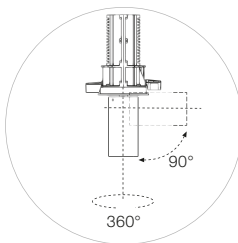

UT DOWNLIGHT

Descrizione

Apparecchio di illuminazione per installazione a incasso con sorgenti luminose a tecnologia LED di alta potenza e inversione Dali e No Dali.

La famiglia è disponibile in due misure (Ø57 e Ø86).

In posizione superiore funziona come downlight e in posizione inferiore funziona come proiettore orientabile. Il corpo ottico dell'apparecchio di illuminazione è fabbricato in alluminio iniettato ad alta pressione, rifinito con vernice a polvere di colore bianco e nero.

Apparecchiatura di alimentazione remota inclusa.

Unità di Alimentazione

Alimentatore a corrente continua non regolabile o regolabile Dali 220-240V compreso.

Accessori

- Disponibili filtro a croce antiabbagliamento, lente ellittica, lente Flood e Honeycomb.
- Cornice di installazione No Trim.

Informazioni Aggiuntive

Grado di protezione IP20.

Classe di isolamento II.

Adatti ad installazioni su superfici normalmente

Conformità e Marchi di Qualità

Apparecchio conforme alla Normativa Tecnica Europea EN60598-1 e relative parti seconde.

Description

Interior lighting for embedded installation with high power LED technology light sources, in Dali and Non Dali versions.

The family is available in two sizes (Ø57 and Ø86).

In an upper position it functions as a downlight, and in a lower position it functions as a swivelling projector.

The optical body of the luminaire is manufactured in high-pressure die-cast aluminium, finished in black or white powder paint.

Remote power kit included.

Power Supply

Not dimmable or dimmable Dali 220-240V, constant current, power supply included.

Accessories

- Screening crosspiece, elliptical lens, flood lens and Honeycomb.
- No Trim installation frame.

Additional Information

IP20 protection grade.

Insulation class II.

Suitable for installation on normally inflammable surfaces.

Standard Compliance and Quality Marks

EN60598-1 European Technical Standards and any subsequent additions.



Trim



No Trim

UT DOWNLIGHT

Ut Downlight Trim Ø57

Light Source: LED Array 18W - 2000 lm - 3000K/CRI 80 / 18W - 1600 lm - 3000K/CRI 90 / 18W - 1600 lm - 4000K/CRI 90

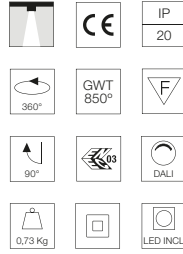
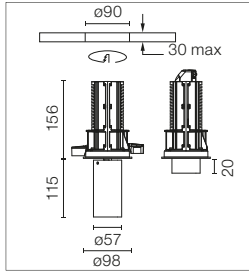

Apparecchio di illuminazione da incasso a LED. Fonte di alimentazione remota 220-240V, 50-60Hz inclusa.

Recessed luminaire with LED light source. 220-240V, 50-60Hz remote power supply included.

3000K - CRI 80

Non Dimmable

- 09.4510.30A
- 09.4510.14A
- Dali Version
- 09.4510.30ADA
- 09.4510.14ADA

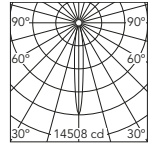

Beam Angle: 11°

h(m)	E(lx)	D(m)
1	14508	0.19
2	3627	0.39
3	1612	0.58
4	907	0.77
5	580	0.97

Luminous flux luminaire 1295 lm

4000K - CRI 90

Non Dimmable

- 09.4516.30A
- 09.4516.14A
- Dali Version
- 09.4516.30ADA
- 09.4516.14ADA

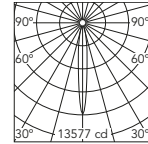

Beam Angle: 11°

h(m)	E(lx)	D(m)
1	13577	0.19
2	3394	0.39
3	1509	0.58
4	849	0.77
5	543	0.97

Luminous flux luminaire 1212 lm

3000K - CRI 90

Non Dimmable

- 09.4513.30A
- 09.4513.14A
- Dali Version
- 09.4513.30ADA
- 09.4513.14ADA

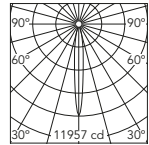

Beam Angle: 11°

h(m)	E(lx)	D(m)
1	11957	0.19
2	2989	0.39
3	1329	0.58
4	747	0.77
5	478	0.97

Luminous flux luminaire 1067 lm

3000K - CRI 80

Non Dimmable

- 09.4511.30A
- 09.4511.14A
- Dali Version
- 09.4511.30ADA
- 09.4511.14ADA

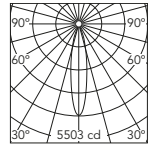

Beam Angle: 21°

h(m)	E(lx)	D(m)
1	5503	0.36
2	1376	0.72
3	611	1.09
4	344	1.45
5	220	1.81

Luminous flux luminaire 981 lm

4000K - CRI 90

Non Dimmable

- 09.4517.30A
- 09.4517.14A
- Dali Version
- 09.4517.30ADA
- 09.4517.14ADA

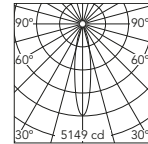

Beam Angle: 21°

h(m)	E(lx)	D(m)
1	5149	0.36
2	1287	0.72
3	572	1.09
4	322	1.45
5	206	1.81

Luminous flux luminaire 918 lm

3000K - CRI 90

Non Dimmable

- 09.4514.30A
- 09.4514.14A
- Dali Version
- 09.4514.30ADA
- 09.4514.14ADA

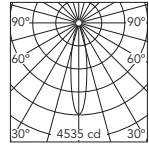

Beam Angle: 21°

h(m)	E(lx)	D(m)
1	4535	0.36
2	1134	0.72
3	504	1.09
4	283	1.45
5	181	1.81

Luminous flux luminaire 808 lm

3000K - CRI 80

Non Dimmable

- 09.4512.30A
- 09.4512.14A
- Dali Version
- 09.4512.30ADA
- 09.4512.14ADA

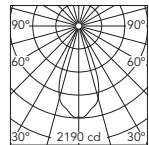

Beam Angle: 43°

h(m)	E(lx)	D(m)
1	2190	0.79
2	548	1.58
3	243	2.37
4	137	3.16
5	88	3.95

Luminous flux luminaire 995 lm

4000K - CRI 90

Non Dimmable

- 09.4518.30A
- 09.4518.14A
- Dali Version
- 09.4518.30ADA
- 09.4518.14ADA

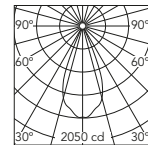

Beam Angle: 43°

h(m)	E(lx)	D(m)
1	2050	0.79
2	512	1.58
3	228	2.37
4	128	3.16
5	82	3.95

Luminous flux luminaire 932 lm

3000K - CRI 90

Non Dimmable

- 09.4515.30A
- 09.4515.14A
- Dali Version
- 09.4515.30ADA
- 09.4515.14ADA

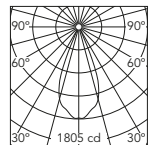

Beam Angle: 43°

h(m)	E(lx)	D(m)
1	1805	0.79
2	451	1.58
3	201	2.37
4	113	3.16
5	72	3.95

Luminous flux luminaire 820 lm

UT DOWNLIGHT

Ut Downlight No Trim Ø57

Light Source: LED Array 18W - 2000 lm - 3000K/CRI 80 / 18W - 1600 lm - 3000K/CRI 90 / 18W - 1600 lm - 4000K/CRI 90

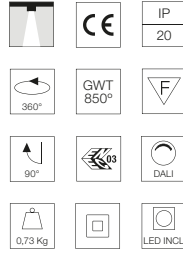
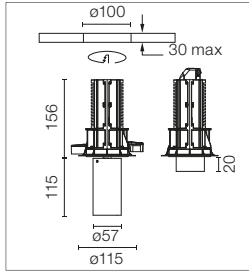

Apparecchio di illuminazione da incasso a LED. Fonte di alimentazione remota 220-240V, 50-60Hz inclusa.

Cornice di pre-installazione da ordinare separatamente.

Recessed luminaire with LED light source. 220-240V, 50-60Hz remote power supply included.

Pre-installation frame must be ordered separately.

3000K - CRI 80

Non Dimmable

- 09.4519.30A
- 09.4519.14A
- Dali Version
- 09.4519.30ADA
- 09.4519.14ADA

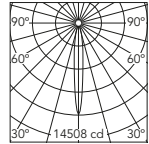

Beam Angle: 11°

h(m)	E(lx)	D(m)
1	14508	0.19
2	3627	0.39
3	1612	0.58
4	907	0.77
5	580	0.97

Luminous flux luminaire 1295 lm

4000K - CRI 90

Non Dimmable

- 09.4525.30A
- 09.4525.14A
- Dali Version
- 09.4525.30ADA
- 09.4525.14ADA

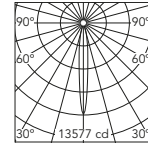

Beam Angle: 11°

h(m)	E(lx)	D(m)
1	13577	0.19
2	3394	0.39
3	1509	0.58
4	849	0.77
5	543	0.97

Luminous flux luminaire 1212 lm

3000K - CRI 90

Non Dimmable

- 09.4522.30A
- 09.4522.14A
- Dali Version
- 09.4522.30ADA
- 09.4522.14ADA

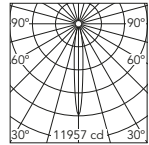

Beam Angle: 11°

h(m)	E(lx)	D(m)
1	11957	0.19
2	2989	0.39
3	1329	0.58
4	747	0.77
5	478	0.97

Luminous flux luminaire 1067 lm

3000K - CRI 80

Non Dimmable

- 09.4520.30A
- 09.4520.14A
- Dali Version
- 09.4520.30ADA
- 09.4520.14ADA

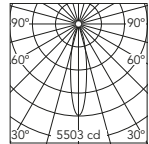

Beam Angle: 21°

h(m)	E(lx)	D(m)
1	5503	0.36
2	1376	0.72
3	611	1.09
4	344	1.45
5	220	1.81

Luminous flux luminaire 981 lm

4000K - CRI 90

Non Dimmable

- 09.4526.30A
- 09.4526.14A
- Dali Version
- 09.4526.30ADA
- 09.4526.14ADA

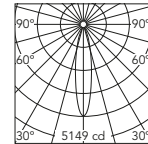

Beam Angle: 21°

h(m)	E(lx)	D(m)
1	5149	0.36
2	1287	0.72
3	572	1.09
4	322	1.45
5	206	1.81

Luminous flux luminaire 918 lm

3000K - CRI 90

Non Dimmable

- 09.4523.30A
- 09.4523.14A
- Dali Version
- 09.4523.30ADA
- 09.4523.14ADA

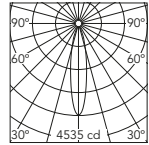

Beam Angle: 21°

h(m)	E(lx)	D(m)
1	4535	0.36
2	1134	0.72
3	504	1.09
4	283	1.45
5	181	1.81

Luminous flux luminaire 808 lm

3000K - CRI 80

Non Dimmable

- 09.4521.30A
- 09.4521.14A
- Dali Version
- 09.4521.30ADA
- 09.4521.14ADA

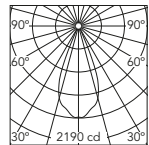

Beam Angle: 43°

h(m)	E(lx)	D(m)
1	2190	0.79
2	548	1.58
3	243	2.37
4	137	3.16
5	88	3.95

Luminous flux luminaire 995 lm

4000K - CRI 90

Non Dimmable

- 09.4527.30A
- 09.4527.14A
- Dali Version
- 09.4527.30ADA
- 09.4527.14ADA

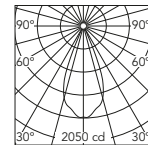

Beam Angle: 43°

h(m)	E(lx)	D(m)
1	2050	0.79
2	512	1.58
3	228	2.37
4	128	3.16
5	82	3.95

Luminous flux luminaire 932 lm

3000K - CRI 90

Non Dimmable

- 09.4524.30A
- 09.4524.14A
- Dali Version
- 09.4524.30ADA
- 09.4524.14ADA

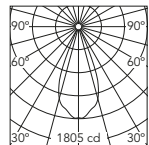

Beam Angle: 43°

h(m)	E(lx)	D(m)
1	1805	0.79
2	451	1.58
3	201	2.37
4	113	3.16
5	72	3.95

Luminous flux luminaire 820 lm

UT DOWNLIGHT

Ut Downlight Trim Ø86

Light Source: LED Array High Performances 27W - 3214 lm - 3000K/CRI 80 / 27W - 2656 lm - 3000K/CRI 90 / 27W - 2767 lm - 4000K/CRI 90

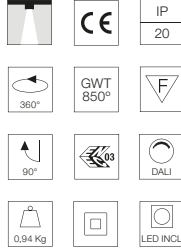
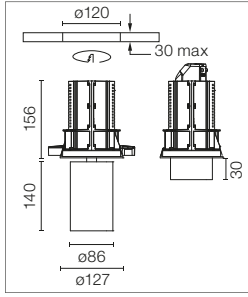

Apparecchio di illuminazione da incasso a LED. Fonte di alimentazione remota 220-240V, 50-60Hz inclusa.

Recessed luminaire with LED light source. 220-240V, 50-60Hz remote power supply included.

3000K - CRI 80

Non Dimmable

09.4910.30A
09.4910.14A

Dali Version

09.4910.30ADA
09.4910.14ADA

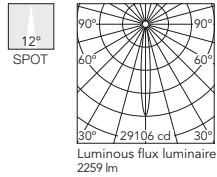

Beam Angle: 12°

h(m)	E(lx)	D(m)
1	29106	0.21
2	7277	0.41
3	3234	0.62
4	1819	0.82
5	1164	1.03

4000K - CRI 90

Non Dimmable

09.4916.30A
09.4916.14A

Dali Version

09.4916.30ADA
09.4916.14ADA

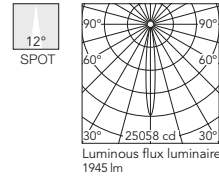

Beam Angle: 12°

h(m)	E(lx)	D(m)
1	25058	0.21
2	6265	0.41
3	2784	0.62
4	1566	0.82
5	1002	1.03

3000K - CRI 90

Non Dimmable

09.4913.30A
09.4913.14A

Dali Version

09.4913.30ADA
09.4913.14ADA

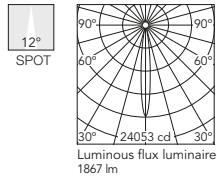

Beam Angle: 12°

h(m)	E(lx)	D(m)
1	24053	0.21
2	6013	0.41
3	2673	0.62
4	1503	0.82
5	962	1.03

3000K - CRI 80

Non Dimmable

09.4911.30A
09.4911.14A

Dali Version

09.4911.30ADA
09.4911.14ADA

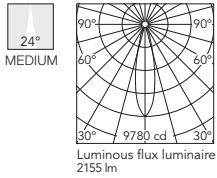

Beam Angle: 24°

h(m)	E(lx)	D(m)
1	9780	0.43
2	2445	0.86
3	1087	1.28
4	611	1.71
5	391	2.14

4000K - CRI 90

Non Dimmable

09.4917.30A
09.4917.14A

Dali Version

09.4917.30ADA
09.4917.14ADA

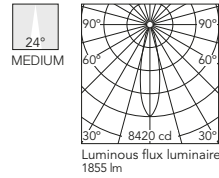

Beam Angle: 24°

h(m)	E(lx)	D(m)
1	8420	0.43
2	2105	0.86
3	936	1.28
4	526	1.71
5	337	2.14

3000K - CRI 90

Non Dimmable

09.4914.30A
09.4914.14A

Dali Version

09.4914.30ADA
09.4914.14ADA

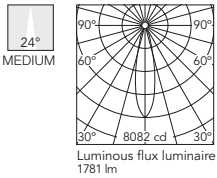

Beam Angle: 24°

h(m)	E(lx)	D(m)
1	8082	0.43
2	2020	0.86
3	898	1.28
4	505	1.71
5	323	2.14

3000K - CRI 80

Non Dimmable

09.4912.30A
09.4912.14A

Dali Version

09.4912.30ADA
09.4912.14ADA

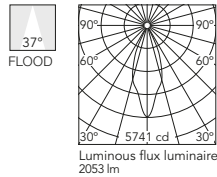

Beam Angle: 37°

h(m)	E(lx)	D(m)
1	5741	0.67
2	1435	1.34
3	638	2.01
4	359	2.69
5	230	3.36

4000K - CRI 90

Non Dimmable

09.4918.30A
09.4918.14A

Dali Version

09.4918.30ADA
09.4918.14ADA

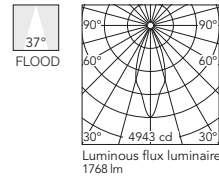

Beam Angle: 37°

h(m)	E(lx)	D(m)
1	4943	0.67
2	1236	1.34
3	549	2.01
4	309	2.69
5	198	3.36

3000K - CRI 90

Non Dimmable

09.4915.30A
09.4915.14A

Dali Version

09.4915.30ADA
09.4915.14ADA

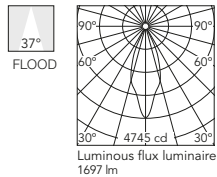

Beam Angle: 37°

h(m)	E(lx)	D(m)
1	4745	0.67
2	1186	1.34
3	527	2.01
4	297	2.69
5	190	3.36

UT DOWNLIGHT

Ut Downlight No Trim Ø86

Light Source: LED Array High Performances 27W - 3214 lm - 3000K/CRI 80 / 27W - 2656 lm - 3000K/CRI 90 / 27W - 2767 lm - 4000K/CRI 90

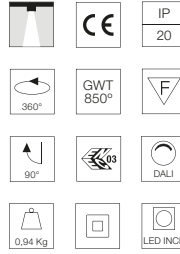
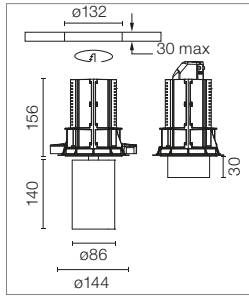

Apparecchio di illuminazione da incasso a LED. Fonte di alimentazione remota 220-240V, 50-60Hz inclusa.

Cornice di pre-installazione da ordinare separatamente.

Recessed luminaire with LED light source. 220-240V, 50-60Hz remote power supply included.

Pre-installation frame must be ordered separately.

3000K - CRI 80

Non Dimmable

09.4919.30A
09.4919.14A

Dali Version

09.4919.30ADA
09.4919.14ADA

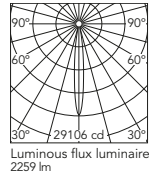

Beam Angle: 12°

4000K - CRI 90

Non Dimmable

09.4925.30A
09.4925.14A

Dali Version

09.4925.30ADA
09.4925.14ADA

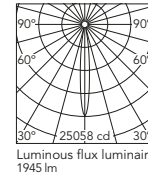

Beam Angle: 12°

3000K - CRI 90

Non Dimmable

09.4922.30A
09.4922.14A

Dali Version

09.4922.30ADA
09.4922.14ADA

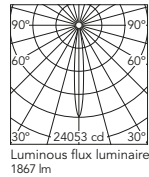

Beam Angle: 12°

4000K - CRI 90

Non Dimmable

09.4926.30A
09.4926.14A

Dali Version

09.4926.30ADA
09.4926.14ADA

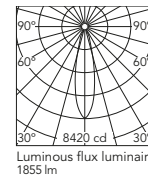

Beam Angle: 24°

3000K - CRI 80

Non Dimmable

09.4920.30A
09.4920.14A

Dali Version

09.4920.30ADA
09.4920.14ADA

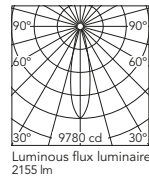

Beam Angle: 24°

3000K - CRI 90

Non Dimmable

09.4923.30A
09.4923.14A

Dali Version

09.4923.30ADA
09.4923.14ADA

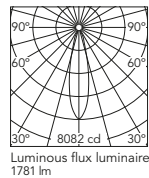

Beam Angle: 24°

4000K - CRI 90

Non Dimmable

09.4927.30A
09.4927.14A

Dali Version

09.4927.30ADA
09.4927.14ADA

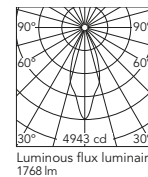

Beam Angle: 37°

3000K - CRI 80

Non Dimmable

09.4921.30A
09.4921.14A

Dali Version

09.4921.30ADA
09.4921.14ADA

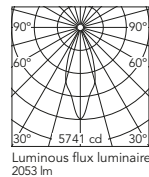

Beam Angle: 37°

3000K - CRI 90

Non Dimmable

09.4924.30A
09.4924.14A

Dali Version

09.4924.30ADA
09.4924.14ADA

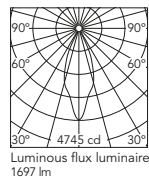

Beam Angle: 37°

UT DOWNLIGHT

Accessori / Accessories

Crocetta di schermatura, lenti e honeycomb direttamente installabili sulla testa dell'apparecchio di illuminazione senza necessità di accessori di fissaggio.

UT Downlight Ø86: Compatibilità di installazione di honeycomb + lente contemporaneamente.

Screening crosspiece, lenses and honeycomb directly installable on the head of the luminaire without needing any fastening accessory.

UT Downlight Ø86: Installation compatible with honeycomb + lense at the same time.

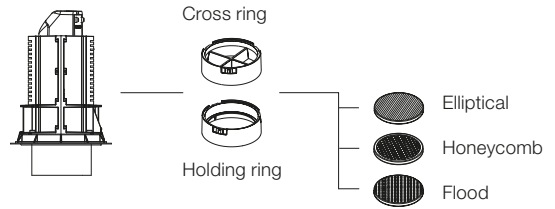

UT Downlight Ø57

Cornice di installazione No Trim.
Installation frame No Trim.



08.8994.30
08.8994.14

Filtro a croce antiabbagliamento
Screening crosspiece



08.8429.00

Lente ellittica
Elliptical lens



08.8431.00

Lente flood
Flood lens



08.8432.00

For Spot & Medium optics

Honeycomb
Honeycomb



08.8428.00

Cono di schermatura
Snoot shielding cone



08.0526.00
08.0526.40
08.0526.BW

UT Downlight Ø86

Cornice di installazione No Trim.
Installation frame No Trim.



08.8995.30
08.8995.14

Anello di supporto
Holding ring



08.8410.00

Filtro a croce antiabbagliamento
Screening crosspiece



08.8411.00

Lente ellittica
Elliptical lens



08.8163.68

Lente flood
Flood lens



08.8175.68

For Spot & Medium optics

Honeycomb
Honeycomb



08.8495.14

LIGHT SUPPLY

DESIGNED BY FLOS ARCHITECTURAL

FIXED TRIM / NO TRIM



LIGHT SOURCE
PHOSPHOR
LED
26W
2285 lm
3000K/CRI 98
28W
3000 lm
4000K/CRI 80

LIGHT SOURCE
LED ARRAY
HIGH
PERFORMANCES
29W
3402 lm
3000K/CRI 80
2811 lm
3000K/CRI 90
2929 lm
4000K/CRI 90

ADJUSTABLE TRIM / NO TRIM



LIGHT SOURCE
PHOSPHOR
LED
26W
2285 lm
3000K/CRI 98
28W
3000 lm
4000K/CRI 80

LIGHT SOURCE
LED ARRAY
HIGH
PERFORMANCES
30,1W
3402 lm
3000K/CRI 80
2811 lm
3000K/CRI 90
2929 lm
4000K/CRI 90

WALL-WASHER TRIM / NO TRIM



LIGHT SOURCE
PHOSPHOR
LED
26W
2285 lm
3000K/CRI 98
28W
3000 lm
4000K/CRI 80

LIGHT SOURCE
LED ARRAY
HIGH
PERFORMANCES
33,2W
3770 lm
3000K/CRI 80
3116 lm
3000K/CRI 90
3246 lm
4000K/CRI 90

Light Supply Adjustable

□ 40 Bianco
40 White

■ 14 Nero
14 Black



Light Supply Fixed & Wall-Washer Trim

Anello Esterno / External Ring

□ Bianco
White

■ Nero
Black

Riflettore / Reflector

▣ Alluminio
Aluminium

□ Bianco
White

▣ Alluminio
Aluminium

□ Bianco
White



Può essere ruotato di 365° e orientato di 35°.
Can be rotated 365° and swivelled 35°.

Light Supply Adjustable

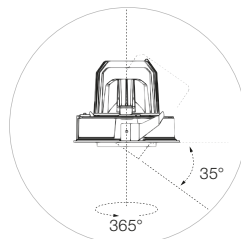

Descrizione

La nuova famiglia downlight è stata sviluppata per ottenere, all'interno di un design compatto da 165 mm di diametro, un flusso massimo di 3000 lm grazie all'ultima tecnologia di moduli LED.

Disponibile in versione fissa, adjustable e wall-washer. La versione adjustable dispone di un cilindro di supporto dell'ottica intercambiabile facile da svitare dall'apparecchio di illuminazione per accedere ai componenti elettronici e installare gli accessori professionali disponibili.

Per offrire la massima flessibilità anche in momenti successivi all'installazione, sono disponibili come accessori riflettori con ottiche spot, intermedie e flood che consentono di modificare la dimensione del fascio di luce senza neppure la necessità di smontare l'apparecchio dal soffitto.

Tutti i Light Supply No Trim si possono montare in una cornice in metallo di pre-installazione o integrare totalmente nel soffitto di cartongesso tramite le piastre di installazione con Soft Technology.

Riflettori

Realizzati tutti in alluminio purissimo con una finitura speculare.

Fascio di luce spot simmetrico a rotazione circolare, fascio medio e ampio per la versione adjustable, flood per la versione fissa.

Unità di Alimentazione

Cablaggio incluso, pronto per collegamento ad apparecchiatura remota.

Versioni senza apparecchiatura e regolabili 1-10 V disponibili su richiesta.

Accessori

Per la versione adjustable:

- Lente di distribuzione ellittica.
- Honeycomb.
- Riflettori di ricambio con ottica spot, intermedia e flood.

Per tutte le versioni No Trim:

- Cornice di pre-installazione o piastra di installazione Soft Architecture per la versione adjustable.

Informazioni Aggiuntive

Nelle versioni orientabili, possibilità di orientamento di 35° e di rotazione di 365°.

Grado di protezione IP23, IP44 a seconda delle versioni.

Classe di isolamento II.

Conformità e Marchi di Qualità

Apparecchio conforme alla Normativa Tecnica Europea EN60598-1 e relative parti seconde.

Description

New downlight family developed to get a maximum flux in a compact design. 165mm diameter offering up to 3000 lm thanks to latest technology LED modules.

Available in fixed, adjustable and wall-washer version. Adjustable version features a dismountable optic support cylinder, to be easily unscrewed from the luminaire, in order to completely access the electronic and to install the professional accessories available.

To offer maximum flexibility and installation evolution in time, reflector of spot, medium and flood optic are also available as accessories, to change the light beam dimension without even needing to dismount the fixture from the ceiling.

All Light Supply No Trim versions can be mounted in a standard pre-installation metal frame or, for total integration in plasterboard ceiling, in a Soft Technology installation plate.

Reflectors

All super pure aluminum with specular finish. Circular roto symmetrical spot, medium and flood for the adjustable version, flood for the fixed version.

Power Supply

Cabling included, ready to be powered by included remote driver.

Versions without driver and 1-10V dimmable available on request.

Accessories

For adjustable version:

- Elliptical distribution lens.
- Honeycomb.
- Spare part of spot, medium, flood optics reflectors.

For all No Trim versions:

- Pre-installation frame or Soft Architecture installation plate for adjustable version.

Additional Information

In the adjustable versions, 35° tilt and 365° rotation.

IP23, IP44 protection grade depending on the versions.

Insulation class II.

Standard Compliance and Quality Marks

EN60598-1 European Technical Standards and any subsequent additions.



Fixed / Adjustable /
Wall-Washer
Trim



Fixed
No Trim



Adjustable
No Trim



Wall-Washer
No Trim



Grazie alla remote-phosphor technology, i moduli LED che montano le versioni Phosphor LED offrono la massima qualità luminosa possibile e la percezione degli oggetti e degli spazi, raggiunge indici di riproduzione cromatica pari a 98, a seconda delle versioni.

Tutte le versioni da 3000K sono disponibili su richiesta della "versione Retail". Quest'opzione dispone di un modulo Phosphor LED speciale che, con tutti i vantaggi in termini di risparmio energetico e affidabilità disponibili sul mercato, riproduce la frequenza della luce di una lampada ad alogenuro metallico.

Questa soluzione innovativa migliora la percezione dei colori e la rappresentazione del colore bianco, oltre a ridurre la radiazione dello spettro viola, dannoso per le opere d'arte; pertanto, è indicato in particolare per l'applicazione commerciale e nei musei.

I moduli LED installati nelle versioni LED Array dispongono dell'ultima generazione tecnologica che consente una minore temperatura media durante il funzionamento dell'elettronica. Grazie a questa caratteristica, l'apparecchio di illuminazione può funzionare all'interno dei parametri di sicurezza a una maggior potenza, offrendo un aumento del 20% del flusso luminoso.

Thanks to remote-phosphor technology, the LED modules of the Phosphor LED version offer maximum quality light, the perception of objects and spaces, reaching chromatic reproduction indices of 98, depending on the version.

All the 3000K versions are available under request in the "Retail version". This option has a special Phosphor LED module that, with all the advantages regarding energy saving and reliability available on the market, reproduces the frequency of the light of a metal halide lamp. This innovative solution improves the perception of colours and the representation of white, in addition to reducing the radiation of the violet spectrum, damaging to works of art, so, it is especially indicated for commercial and museum purposes.

The LED modules installed on the LED Array versions have cutting-edge technology that permit a lower average temperature in the electronics. Thanks to this feature, the luminaire can operate at a higher power inside the safety parameters, yet still offer 20% added luminous flux.

LIGHT SUPPLY

Light Supply Fixed Trim

Light Source: Phosphor LED 26W - 2285 lm - 3000K/CRI 98 / 28W - 3000 lm - 4000K/CRI 80

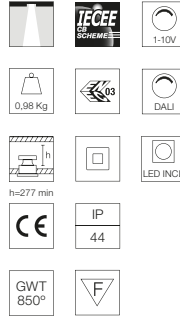
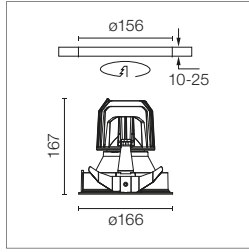

Apparecchio di illuminazione da incasso a LED. Fonte di alimentazione remota 220/240V inclusa.

E= Finitura Esterna
I= Finitura Interna.

Recessed luminaire with LED light source. Remote 220/240V power supply included.

E= External Finish
I= Internal Finish.

Light Supply Fixed No Trim

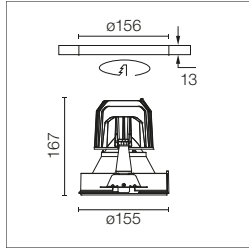

Cornice di pre-installazione. Da ordinare separatamente.

Pre-installation frame. To be ordered separately.

3000K - CRI 98

- E I Trim**
- 03.6611.3B
 - 03.6611.3C
 - Dali Version/1-10V
 - 03.6611.3B.DA
 - 03.6611.3C.DA
- E I**
- 03.6611.1B
 - 03.6611.1C
 - Dali Version/1-10V
 - 03.6611.1B.DA
 - 03.6611.1C.DA
- No Trim**
- 03.6626.40
 - 03.6626.06
 - Dali Version/1-10V
 - 03.6626.40.DA
 - 03.6626.06.DA

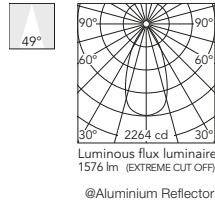
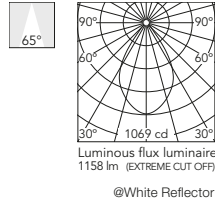

4000K - CRI 80

- E I Trim**
- 03.6610.3B
 - 03.6610.3C
 - Dali Version/1-10V
 - 03.6610.3B.DA
 - 03.6610.3C.DA
- E I**
- 03.6610.1B
 - 03.6610.1C
 - Dali Version/1-10V
 - 03.6610.1B.DA
 - 03.6610.1C.DA
- No Trim**
- 03.6625.40
 - 03.6625.06
 - Dali Version/1-10V
 - 03.6625.40.DA
 - 03.6625.06.DA

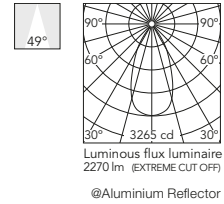
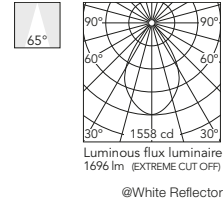

LIGHT SUPPLY

Light Supply Adjustable Trim

Light Source: Phosphor LED 26W - 2285 lm - 3000K/CRI 98

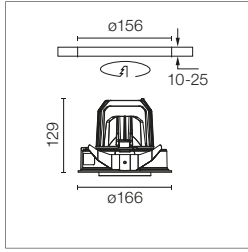

Apparecchio di illuminazione da incasso a LED. Fonte di alimentazione remota 220/240V inclusa.

Recessed luminaire with LED light source. Remote 220/240V power supply included.

Light Supply Adjustable No Trim

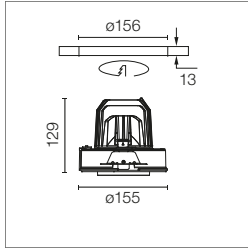

Cornice o piastra Soft Architecture per pre-installazione No Trim. Da ordinare separatamente.

Pre-installation frame or Soft Architecture installation plate for No Trim installation. To be ordered separately.

3000K - CRI 98 Trim

- 03.6606.40
- 03.6606.14
- Dali Version/1-10V
- 03.6606.40.DA
- 03.6606.14.DA
- No Trim**
- 03.6621.40
- 03.6621.14
- Dali Version/1-10V
- 03.6621.40.DA
- 03.6621.14.DA

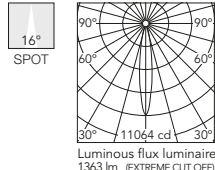

4000K - CRI 80 Trim

- 03.6603.40
- 03.6603.14
- Dali Version/1-10V
- 03.6603.40.DA
- 03.6603.14.DA
- No Trim**
- 03.6618.40
- 03.6618.14
- Dali Version/1-10V
- 03.6618.40.DA
- 03.6618.14.DA

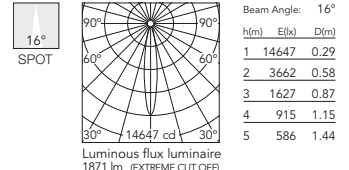

3000K - CRI 98 Trim

- 03.6607.40
- 03.6607.14
- Dali Version/1-10V
- 03.6607.40.DA
- 03.6607.14.DA
- No Trim**
- 03.6622.40
- 03.6622.14
- Dali Version/1-10V
- 03.6622.40.DA
- 03.6622.14.DA

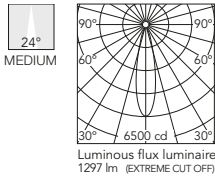

4000K - CRI 80 Trim

- 03.6604.40
- 03.6604.14
- Dali Version/1-10V
- 03.6604.40.DA
- 03.6604.14.DA
- No Trim**
- 03.6619.40
- 03.6619.14
- Dali Version/1-10V
- 03.6619.40.DA
- 03.6619.14.DA

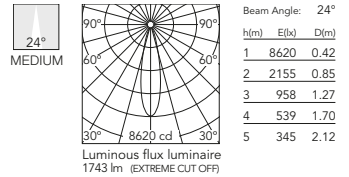

3000K - CRI 98 Trim

- 03.6608.40
- 03.6608.14
- Dali Version/1-10V
- 03.6608.40.DA
- 03.6608.14.DA
- No Trim**
- 03.6623.40
- 03.6623.14
- Dali Version/1-10V
- 03.6623.40.DA
- 03.6623.14.DA

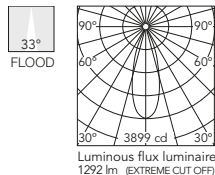

4000K - CRI 80 Trim

- 03.6605.40
- 03.6605.14
- Dali Version/1-10V
- 03.6605.40.DA
- 03.6605.14.DA
- No Trim**
- 03.6620.40
- 03.6620.14
- Dali Version/1-10V
- 03.6620.40.DA
- 03.6620.14.DA

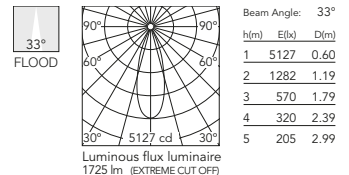

LIGHT SUPPLY

Light Supply Wall-Washer Trim

Light Source: Phosphor LED 26W - 2285 lm - 3000K/CRI 98 / 28W - 3000 lm - 4000K/CRI 80

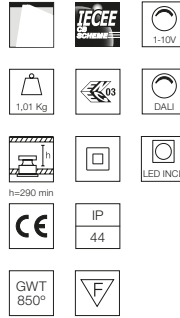
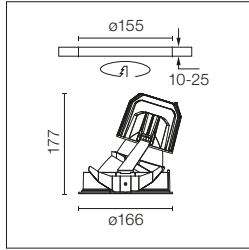

Apparecchio di illuminazione da incasso a LED. Fonte di alimentazione remota 220/240V inclusa.

Recessed luminaire with LED light source. Remote 220/240V power supply included.

E= Finitura Esterna
I= Finitura Interna.

E= External Finish
I= Internal Finish.

Light Supply Wall-Washer No Trim

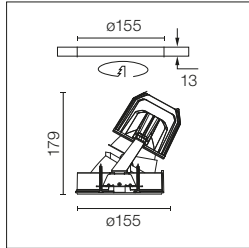

Cornice di pre-installazione. Da ordinare separatamente.

Pre-installation frame. To be ordered separately.

3000K - CRI 98

- Trim**
- 03.6614.3B
 - 03.6614.3C
 - Dali Version/1-10V
 - 03.6614.3B.DA
 - 03.6614.3C.DA
- No Trim**
- 03.6614.1B
 - 03.6614.1C
 - Dali Version/1-10V
 - 03.6614.1B.DA
 - 03.6614.1C.DA
- No Trim**
- 03.6629.40
 - 03.6629.06
 - Dali Version/1-10V
 - 03.6629.40.DA
 - 03.6629.06.DA

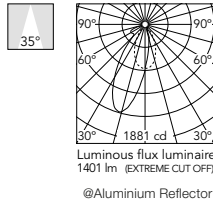
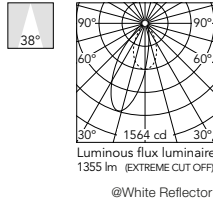

4000K - CRI 80

- Trim**
- 03.6613.3B
 - 03.6613.3C
 - Dali Version/1-10V
 - 03.6613.3B.DA
 - 03.6613.3C.DA
- No Trim**
- 03.6613.1B
 - 03.6613.1C
 - Dali Version/1-10V
 - 03.6613.1B.DA
 - 03.6613.1C.DA
- No Trim**
- 03.6628.40
 - 03.6628.06
 - Dali Version/1-10V
 - 03.6628.40.DA
 - 03.6628.06.DA

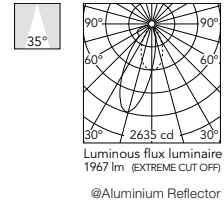
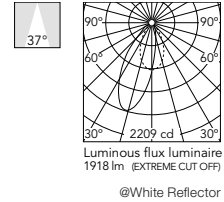

LIGHT SUPPLY

Light Supply Fixed Trim

Light Source: LED Array High Performances 29W - 3402 lm - 3000K/CRI 80 / 29W - 2811 lm - 3000K/CRI 90 / 29W - 2929 lm - 4000K/CRI 90

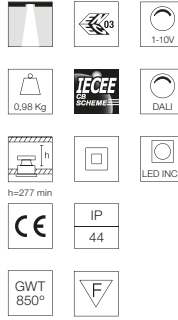
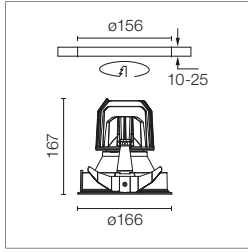

Apparecchio di illuminazione da incasso a LED. Fonte di alimentazione remota 220/240V inclusa.

Recessed luminaire with LED light source. Remote 220/240V power supply included.

E= Finitura Esterna
I= Finitura Interna.

E= External Finish
I= Internal Finish.

Light Supply Fixed No Trim

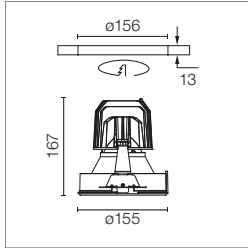

Cornice di pre-installazione. Da ordinare separatamente.

Pre-installation frame. To be ordered separately.

- 3000K - CRI 90 Trim**
- E I 03.6811.3BA
 - E I 03.6811.3CA
 - E I Dali Version/1-10V
 - E I 03.6811.3BADA
 - E I 03.6811.3CADA
- No Trim**
- E I 03.6811.1BA
 - E I 03.6811.1CA
 - E I Dali Version/1-10V
 - E I 03.6811.1BADA
 - E I 03.6811.1CADA
- No Trim**
- 03.6826.40A
 - 03.6826.06A
 - Dali Version/1-10V
 - 03.6826.40ADA
 - 03.6826.06ADA

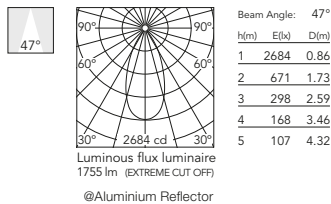
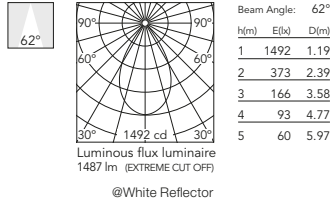

- 4000K - CRI 90 Trim**
- E I 03.6810.3BA
 - E I 03.6810.3CA
 - E I Dali Version/1-10V
 - E I 03.6810.3BADA
 - E I 03.6810.3CADA
- No Trim**
- E I 03.6810.1BA
 - E I 03.6810.1CA
 - E I Dali Version/1-10V
 - E I 03.6810.1BADA
 - E I 03.6810.1CADA
- No Trim**
- 03.6825.40A
 - 03.6825.06A
 - Dali Version/1-10V
 - 03.6825.40ADA
 - 03.6825.06ADA

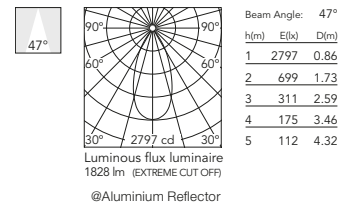
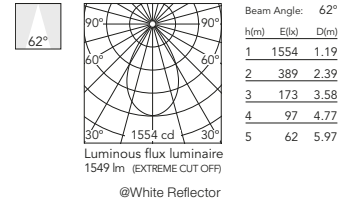

- 3000K - CRI 80 Trim**
- E I 03.6809.3BA
 - E I 03.6809.3CA
 - E I Dali Version/1-10V
 - E I 03.6809.3BADA
 - E I 03.6809.3CADA
- No Trim**
- E I 03.6809.1BA
 - E I 03.6809.1CA
 - E I Dali Version/1-10V
 - E I 03.6809.1BADA
 - E I 03.6809.1CADA
- No Trim**
- 03.6824.40A
 - 03.6824.06A
 - Dali Version/1-10V
 - 03.6824.40ADA
 - 03.6824.06ADA

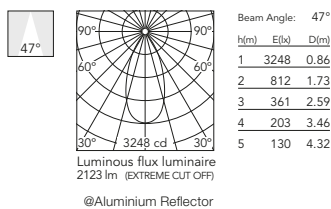
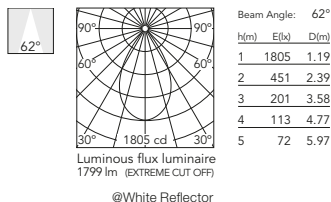

LIGHT SUPPLY

Light Supply Adjustable Trim

Light Source: LED Array High Performances 30,1W - 2811 lm - 3000K/CRI 90 / 30,1W - 2929 lm - 4000K/CRI 90

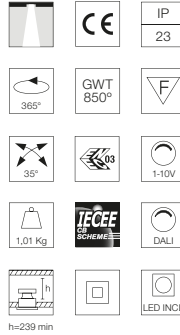
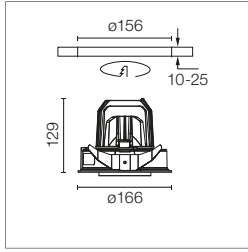

Apparecchio di illuminazione da incasso a LED. Fonte di alimentazione remota 220/240V inclusa.

Recessed luminaire with LED light source. Remote 220/240V power supply included.

Light Supply Adjustable No Trim

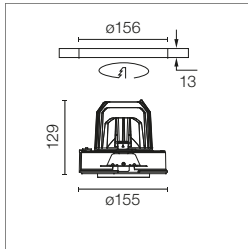

Cornice o piastra Soft Architecture per pre-installazione No Trim. Da ordinare separatamente.

Pre-installation frame or Soft Architecture installation plate for No Trim installation. To be ordered separately.

3000K - CRI 90 Trim

- 03.6806.40A
- 03.6806.14A
- Dali Version/1-10V
- 03.6806.40ADA
- 03.6806.14ADA

No Trim

- 03.6821.40A
- 03.6821.14A
- Dali Version/1-10V
- 03.6821.40ADA
- 03.6821.14ADA

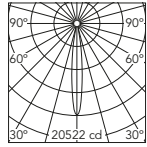

Beam Angle: 13°

h(m)	E(lx)	D(m)
1	20522	0.23
2	5131	0.46
3	2280	0.69
4	1283	0.92
5	821	1.15

Luminous flux luminaire
1698 lm (EXTREME CUT OFF)

4000K - CRI 90 Trim

- 03.6803.40A
- 03.6803.14A
- Dali Version/1-10V
- 03.6803.40ADA
- 03.6803.14ADA

No Trim

- 03.6818.40A
- 03.6818.14A
- Dali Version/1-10V
- 03.6818.40ADA
- 03.6818.14ADA

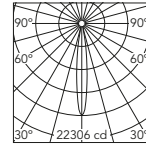

Beam Angle: 13°

h(m)	E(lx)	D(m)
1	22306	0.23
2	5576	0.46
3	2478	0.69
4	1394	0.92
5	892	1.15

Luminous flux luminaire
1846 lm (EXTREME CUT OFF)

3000K - CRI 90 Trim

- 03.6807.40A
- 03.6807.14A
- Dali Version/1-10V
- 03.6807.40ADA
- 03.6807.14ADA

No Trim

- 03.6822.40A
- 03.6822.14A
- Dali Version/1-10V
- 03.6822.40ADA
- 03.6822.14ADA

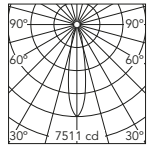

Beam Angle: 21°

h(m)	E(lx)	D(m)
1	7511	0.37
2	1878	0.75
3	835	1.12
4	469	1.49
5	300	1.87

Luminous flux luminaire
1367 lm (EXTREME CUT OFF)

4000K - CRI 90 Trim

- 03.6804.40A
- 03.6804.14A
- Dali Version/1-10V
- 03.6804.40ADA
- 03.6804.14ADA

No Trim

- 03.6819.40A
- 03.6819.14A
- Dali Version/1-10V
- 03.6819.40ADA
- 03.6819.14ADA

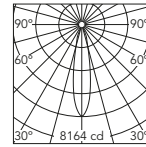

Beam Angle: 21°

h(m)	E(lx)	D(m)
1	8164	0.37
2	2041	0.75
3	907	1.12
4	510	1.49
5	327	1.87

Luminous flux luminaire
1486 lm (EXTREME CUT OFF)

3000K - CRI 90 Trim

- 03.6808.40A
- 03.6808.14A
- Dali Version/1-10V
- 03.6808.40ADA
- 03.6808.14ADA

No Trim

- 03.6823.40A
- 03.6823.14A
- Dali Version/1-10V
- 03.6823.40ADA
- 03.6823.14ADA

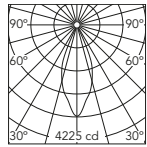

Beam Angle: 39°

h(m)	E(lx)	D(m)
1	4225	0.71
2	1056	1.42
3	469	2.14
4	264	2.85
5	169	3.56

Luminous flux luminaire
1508 lm (EXTREME CUT OFF)

4000K - CRI 90 Trim

- 03.6805.40A
- 03.6805.14A
- Dali Version/1-10V
- 03.6805.40ADA
- 03.6805.14ADA

No Trim

- 03.6820.40A
- 03.6820.14A
- Dali Version/1-10V
- 03.6820.40ADA
- 03.6820.14ADA

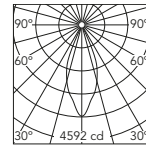

Beam Angle: 39°

h(m)	E(lx)	D(m)
1	4592	0.71
2	1148	1.42
3	510	2.14
4	287	2.85
5	184	3.56

Luminous flux luminaire
1639 lm (EXTREME CUT OFF)

LIGHT SUPPLY

Light Supply Adjustable Trim

Light Source: LED Array High Performances 30,1W - 3402 lm - 3000K CRI 80

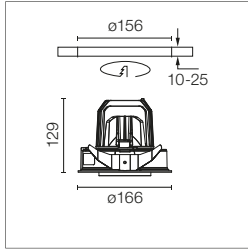

Apparecchio di illuminazione da incasso a LED. Fonte di alimentazione remota 220/240V inclusa.

Recessed luminaire with LED light source. Remote 220/240V power supply included.

Light Supply Adjustable No Trim

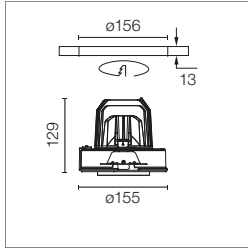

Cornice o piastra Soft Architecture per pre-installazione No Trim. Da ordinare separatamente.

Pre-installation frame or Soft Architecture installation plate for No Trim installation. To be ordered separately.

3000K - CRI 80 Trim

- 03.6800.40A
- 03.6800.14A
- Dali Version/1-10V
- 03.6800.40ADA
- 03.6800.14ADA

No Trim

- 03.6815.40A
- 03.6815.14A
- Dali Version/1-10V
- 03.6815.40ADA
- 03.6815.14ADA

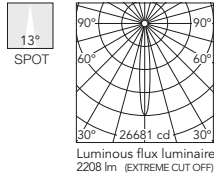

h(m)	E(lx)	D(m)
1	26681	0.23
2	6670	0.46
3	2965	0.69
4	1668	0.92
5	1067	1.15

3000K - CRI 80 Trim

- 03.6801.40A
- 03.6801.14A
- Dali Version/1-10V
- 03.6801.40ADA
- 03.6801.14ADA

No Trim

- 03.6816.40A
- 03.6816.14A
- Dali Version/1-10V
- 03.6816.40ADA
- 03.6816.14ADA

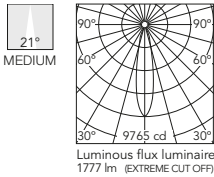

h(m)	E(lx)	D(m)
1	9765	0.37
2	2441	0.75
3	1085	1.12
4	610	1.49
5	391	1.87

3000K - CRI 80 Trim

- 03.6802.40A
- 03.6802.14A
- Dali Version/1-10V
- 03.6802.40ADA
- 03.6802.14ADA

No Trim

- 03.6817.40A
- 03.6817.14A
- Dali Version/1-10V
- 03.6817.40ADA
- 03.6817.14ADA

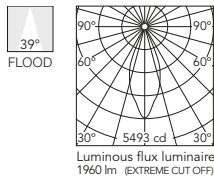

h(m)	E(lx)	D(m)
1	5493	0.71
2	1373	1.42
3	610	2.14
4	343	2.85
5	220	3.56

LIGHT SUPPLY

Light Supply Wall-Washer Trim

Light Source: LED Array High Performances 33,2W - 3770 lm - 3000K/CRI 80 / 33,2W - 3116 lm - 3000K/CRI 90 / 33,2W - 3246 lm - 4000K/CRI 90

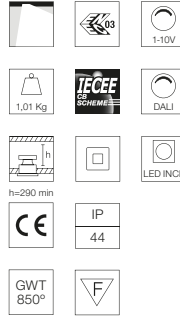
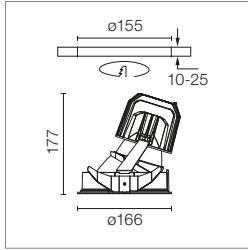

Apparecchio di illuminazione da incasso a LED. Fonte di alimentazione remota 220/240V inclusa.

Recessed luminaire with LED light source. Remote 220/240V power supply included.

E= Finitura Esterna
I= Finitura Interna.

E= External Finish
I= Internal Finish.

Light Supply Wall-Washer No Trim

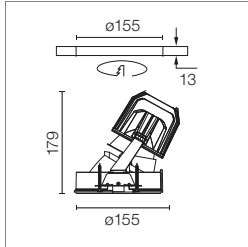

Cornice di pre-installazione. Da ordinare separatamente.

Pre-installation frame. To be ordered separately.

3000K - CRI 90

- Trim**
- E I 03.6814.3BA
 - E I 03.6814.3CA
 - E I Dali Version/1-10V
 - E I 03.6814.3BADA
 - E I 03.6814.3CADA
- No Trim**
- E I 03.6814.1BA
 - E I 03.6814.1CA
 - E I Dali Version/1-10V
 - E I 03.6814.1BADA
 - E I 03.6814.1CADA
- No Trim**
- E I 03.6829.40A
 - E I 03.6829.06A
 - E I Dali Version/1-10V
 - E I 03.6829.40ADA
 - E I 03.6829.06ADA

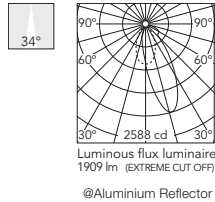
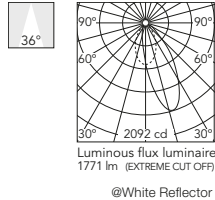

4000K - CRI 90

- Trim**
- E I 03.6813.3BA
 - E I 03.6813.3CA
 - E I Dali Version/1-10V
 - E I 03.6813.3BADA
 - E I 03.6813.3CADA
- No Trim**
- E I 03.6813.1BA
 - E I 03.6813.1CA
 - E I Dali Version/1-10V
 - E I 03.6813.1BADA
 - E I 03.6813.1CADA
- No Trim**
- E I 03.6828.40A
 - E I 03.6828.06A
 - E I Dali Version/1-10V
 - E I 03.6828.40ADA
 - E I 03.6828.06ADA

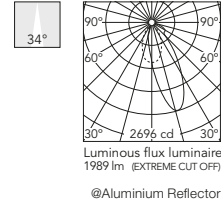
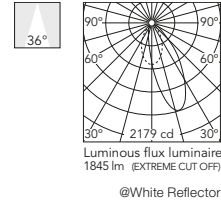

3000K - CRI 80

- Trim**
- E I 03.6812.3BA
 - E I 03.6812.3CA
 - E I Dali Version/1-10V
 - E I 03.6812.3BADA
 - E I 03.6812.3CADA
- No Trim**
- E I 03.6812.1BA
 - E I 03.6812.1CA
 - E I Dali Version/1-10V
 - E I 03.6812.1BADA
 - E I 03.6812.1CADA
- No Trim**
- E I 03.6827.40A
 - E I 03.6827.06A
 - E I Dali Version/1-10V
 - E I 03.6827.40ADA
 - E I 03.6827.06ADA

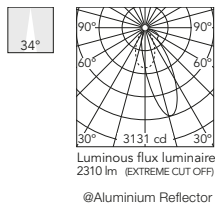
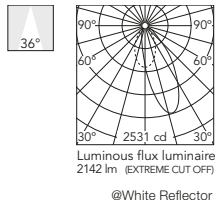

LIGHT SUPPLY

Accessori / Accessories

Cornice di pre-installazione.

Pre-installation frame.



Adjustable No Trim
08.8119.00



Fixed No Trim
08.8359.00



Wall-Washer No Trim
08.8137.00

Piastra Soft Architecture per pre-installazione in superfici di cartongesso.

Soft Architecture installation plate for integration in plasterboard.

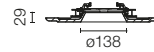

Adjustable No Trim
SA.6600.1

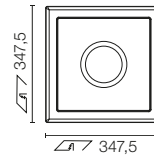

For Phosphor LED

Riflettore di ricambio per Light Supply Adjustable.

Light Supply Adjustable spare reflector.



Spot
08.8413.00
Medium
08.8414.00
Flood
08.8415.00

LIGHT SUPPLY

Accessori / Accessories

For LED Array

Riflettore di ricambio per Light Supply Adjustable.

Light Supply Adjustable spare reflector.



Spot
08.8450.00
Medium
08.8451.00
Flood
08.8452.00

Filtro a croce antiabbagliamento.

Screening crosspiece.



08.8242.14

Lente ellittica.

Elliptical lens.



08.8118.68

Honeycomb.

Honeycomb.



Celle Piccole/Small Cells
08.8049.14



Celle Grandi/Big Cells
08.8377.14

Cilindro ad alta efficienza.

Highly-efficient cylinder.



08.8453.40
08.8453.14

PURE DOWNLIGHT
DESIGNED BY KNUD HOLSCHER

TRIM / NO TRIM



LIGHT SOURCE
PHOSPHOR
LED
13,6W
1490 lm
3000K/CRI 80
11,9W
1057 lm
3000K/CRI 98

LIGHT SOURCE
POWER LED
15,7W
1400 lm
2700K/CRI 80
3000K/CRI 80

LIGHT SOURCE
LED
QR-CBC 51
GX5.3

□ 30 Bianco/RAL 9001
30 White

■ 02 Grigio/RAL 9006
02 Grey

■ 14 Nero/RAL 9005
14 Black

Pure Downlight Trim



Pure Downlight No Trim



Può essere ruotato di 360° e orientato di 60°.
Can be rotated 360° and swivelled 60°.

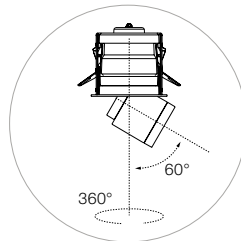

PURE DOWNLIGHT

Descrizione

Apparecchio LED di illuminazione d'accento per installazioni in interni disponibili anche per lampade LED retrofit. Portalampade in materiale ceramico o in tecnopolimero autoestinguente, con cavi elettrici unipolari isolati Teflon con doppio isolamento trasparente. Corpo lampada costituito da un elemento dissipatore in alluminio, posto sopra il portalampada, da un anello reggi-schermi realizzato in materiale termoplastico di colore nero e da un vetro temperato di 4 mm di spessore. Corpo, coperchio di chiusura e supporto orientabile della lampada sono in lega di alluminio pressofusa, verniciate a polvere di colore bianco, grigio o nero.

Riflettori

Tutte le ottiche sono realizzate in alluminio super puro con finitura speculare.
Circolare rotosimmetrica da spot 15° a wide flood 51°.

Unità di Alimentazione

Precablaggio incluso; pronto per essere alimentato per mezzo di apparecchiature remote.
Connessione rapida all'unità di alimentazione per lampade a scarica mediante connessione rapida tipo Wieland.

Accessori

- Lente di distribuzione ellittica in vetro temprato di 4 mm.
- Cilindro schermante realizzato in celle di alluminio.
- Filtri cromatici.

Informazioni Aggiuntive

Possibilità di rotazione di 360° sull'asse orizzontale, di 60° su quello verticale.
Grado di protezione IP20.
Classe di isolamento I, II o III, a seconda delle versioni.
Adatti ad installazioni su superfici normalmente infiammabili.

Conformità e Marchi di Qualità

Apparecchio conforme alla Normativa Tecnica Europea EN60598-1 e relative parti seconde.

Description

Recessed LED luminaire for indoor application, also available for LED retrofit lamps. Self-extinguishing ceramic or engineering plastic lamp holders, with single-pole, transparent electric wires with double Teflon insulation. Aluminum body, placed above the lamp holder, black thermoplastic and 4 mm tempered glass screen-support ring. Die-cast aluminum alloy body, cover and adjustable lamp support, powder-coated white, grey or black.

Reflectors

All super pure aluminum with specular finish.
Circular rotosymmetrical from 15° spot to 51° wide flood.

Power Supply

Pre-wiring included; ready for remote power supply.
Wieland connectors used for discharge control gear providing quick installation time.

Accessories

- 4 mm tempered glass elliptical distribution lens.
- Anti-glare grid in aluminium cells with black liquid paint finish.
- Chromatic filters.

Additional Information

0° - 360° horizontal rotation, 0° - 60° vertical rotation.
IP20 protection grade.
Insulation class I, II, III depending on the versions.
Suitable for installation on normally inflammable surfaces.

Standard Compliance and Quality Marks

EN60598-1 European Technical Standards and any subsequent additions.

PURE DOWNLIGHT

Pure Downlight Trim

Light Source: Phosphor LED 13,6W - 1490 lm - 3000K/CRI 80 / 11,9W - 1057 lm 3000K/CRI 98

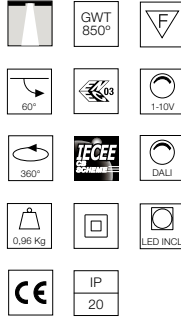
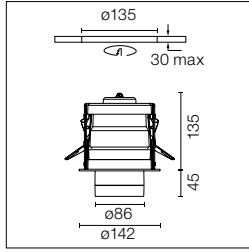

Apparecchio di illuminazione da incasso a LED. Trasformatore elettronico remoto 220/240V incluso.

Cornice di installazione da ordinare separatamente.

Recessed luminaire with LED light source. Remote electronic transformer 220/240V included.

Installation frame must be ordered separately.

Pure Downlight No Trim

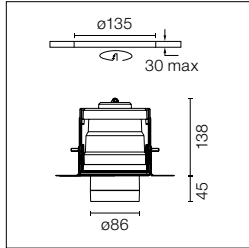

3000K - CRI 80

Non Dimmable

- 09.1635.30C
- 09.1635.02C
- 09.1635.14C

Dali Version

- 09.1635.30CDA
- 09.1635.02CDA
- 09.1635.14CDA

1-10V

- 09.1635.30C1V
- 09.1635.02C1V
- 09.1635.14C1V

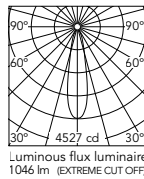

Beam Angle: 23°

h(m)	E(lx)	D(m)
1	4527	0.40
2	1132	0.81
3	503	1.21
4	283	1.62
5	181	2.02

3000K - CRI 98

Non Dimmable

- 09.1630.30C
- 09.1630.02C
- 09.1630.14C

Dali Version

- 09.1630.30CDA
- 09.1630.02CDA
- 09.1630.14CDA

1-10V

- 09.1630.30C1V
- 09.1630.02C1V
- 09.1630.14C1V

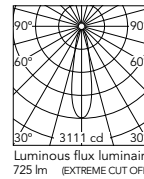

Beam Angle: 23°

h(m)	E(lx)	D(m)
1	3111	0.41
2	778	0.82
3	346	1.22
4	194	1.63
5	124	2.04

3000K - CRI 80

Non Dimmable

- 09.1636.30C
- 09.1636.02C
- 09.1636.14C

Dali Version

- 09.1636.30CDA
- 09.1636.02CDA
- 09.1636.14CDA

1-10V

- 09.1636.30C1V
- 09.1636.02C1V
- 09.1636.14C1V

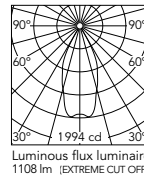

Beam Angle: 46°

h(m)	E(lx)	D(m)
1	1994	0.84
2	499	1.68
3	222	2.52
4	125	3.36
5	80	4.19

3000K - CRI 98

Non Dimmable

- 09.1631.30C
- 09.1631.02C
- 09.1631.14C

Dali Version

- 09.1631.30CDA
- 09.1631.02CDA
- 09.1631.14CDA

1-10V

- 09.1631.30C1V
- 09.1631.02C1V
- 09.1631.14C1V

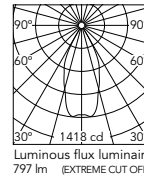

Beam Angle: 46°

h(m)	E(lx)	D(m)
1	1418	0.84
2	355	1.69
3	158	2.53
4	89	3.37
5	57	4.21

3000K - CRI 80

Non Dimmable

- 09.1637.30C
- 09.1637.02C
- 09.1637.14C

Dali Version

- 09.1637.30CDA
- 09.1637.02CDA
- 09.1637.14CDA

1-10V

- 09.1637.30C1V
- 09.1637.02C1V
- 09.1637.14C1V

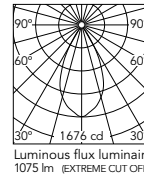

Beam Angle: 51°

h(m)	E(lx)	D(m)
1	1676	0.95
2	419	1.89
3	186	2.84
4	105	3.79
5	67	4.74

3000K - CRI 98

Non Dimmable

- 09.1632.30C
- 09.1632.02C
- 09.1632.14C

Dali Version

- 09.1632.30CDA
- 09.1632.02CDA
- 09.1632.14CDA

1-10V

- 09.1632.30C1V
- 09.1632.02C1V
- 09.1632.14C1V

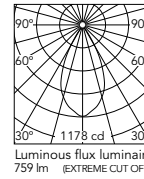

Beam Angle: 51°

h(m)	E(lx)	D(m)
1	1178	0.95
2	295	1.91
3	131	2.86
4	74	3.82
5	47	4.77

PURE DOWNLIGHT

Pure Downlight Trim

Light Source: Power LED DC 700 mA - 15,7W - 1400 lm - 2700K/CRI 80 / 15,7W - 1400 lm - 3000K/CRI80

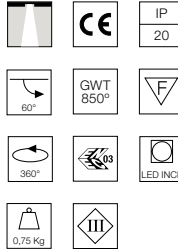
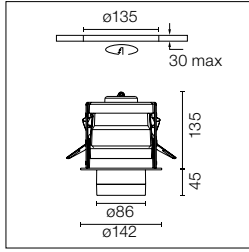

Apparecchio di illuminazione da incasso a LED. Fonte di alimentazione esclusa.

Recessed luminaire with LED light source. Power supply not included.

Cornice di installazione da ordinare separatamente.

Installation frame must be ordered separately.

Alimentazioni raccomandate / Recommended power supply*:

Non Dimmable
Dimmable 1-10V
Dimmable Dali
Mains Dimming

RF27535
RF21466
60.8847
RF21469

* Vedi capitolo Drivers / Refer to the Drivers chapter

Pure Downlight No Trim

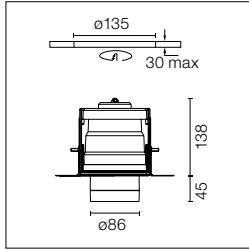

2700K - CRI 80
09.1640.30B
09.1640.02B
09.1640.14B

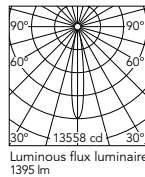

Beam Angle: 15°

h(m)	E(lx)	D(m)
1	13558	0.26
2	3390	0.52
3	1506	0.78
4	847	1.04
5	542	1.30

3000K - CRI 80
09.1645.30B
09.1645.02B
09.1645.14B

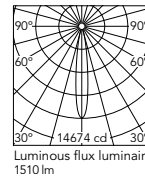

Beam Angle: 15°

h(m)	E(lx)	D(m)
1	14674	0.26
2	3668	0.52
3	1630	0.78
4	917	1.04
5	587	1.30

2700K - CRI 80
09.1641.30B
09.1641.02B
09.1641.14B

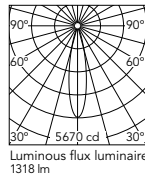

Beam Angle: 22°

h(m)	E(lx)	D(m)
1	5670	0.38
2	1417	0.77
3	630	1.15
4	354	1.54
5	227	1.92

3000K - CRI 80
09.1646.30B
09.1646.02B
09.1646.14B

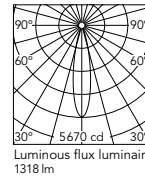

Beam Angle: 22°

h(m)	E(lx)	D(m)
1	5670	0.38
2	1417	0.77
3	630	1.15
4	354	1.54
5	227	1.92

2700K - CRI 80
09.1642.30B
09.1642.02B
09.1642.14B

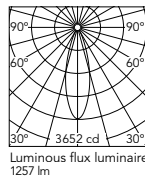

Beam Angle: 30°

h(m)	E(lx)	D(m)
1	3652	0.54
2	913	1.09
3	406	1.63
4	228	2.18
5	146	2.72

3000K - CRI 80
09.1647.30B
09.1647.02B
09.1647.14B

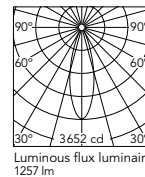

Beam Angle: 30°

h(m)	E(lx)	D(m)
1	3652	0.54
2	913	1.09
3	406	1.63
4	228	2.18
5	146	2.72

PURE DOWNLIGHT

Pure Downlight Trim

Light Source: LED QR-CBC 51 GX5.3

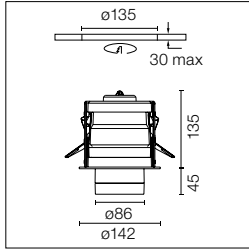

Apparecchio di illuminazione da incasso per lampada di 12V. Trasformatore remoto non incluso.

Recessed 12V lamp luminaire. Remote transformer not included.

Cornice di installazione da ordinare separatamente.

Installation frame must be ordered separately.

Pure Downlight No Trim

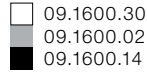
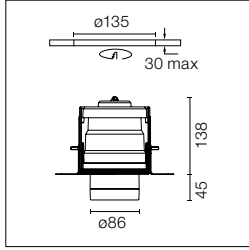

Accessori / Accessories

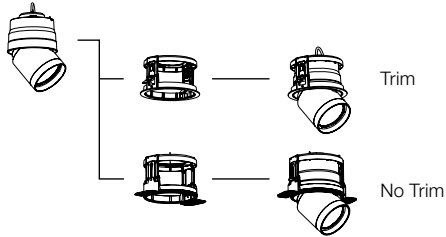

Esempio / Example:
09.1630.30 + 08.8149.30 = TRIM

Esempio / Example:
09.1630.30 + 08.8152.00 = NO TRIM

Cornice di installazione.

Installation frame.

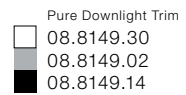

Pure Downlight No Trim
08.8152.00

PURE DOWNLIGHT

Accessori / Accessories

Le lenti ellittiche, la griglia antiriverbero e i filtri vari devono sempre essere installati con l'anello di chiusura del diametro esatto dell'apparecchio.

Elliptical lens, honeycomb filter, different filters and flood lens, must always be used with the holding ring using the correct diameter.

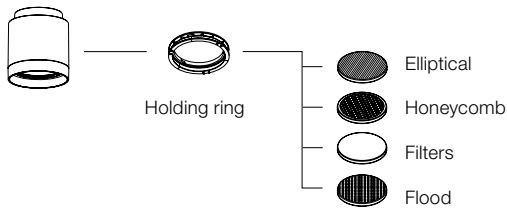

Anello di chiusura
Holding ring



08.8166.14

Lente ellittica
Elliptical lens



08.8163.68

Lente flood
Flood lens



08.8175.68

Honeycomb
Honeycomb



08.8169.14

Filtro blu
Blue filter



08.8160.64.OD

Filtro azzurro
Sky blue filter



08.8160.65.OD

Filtro ambra
Amber filter



08.8160.66.OD

Filtro rosso
Red filter



08.8160.67.OD

Filtro anti U.V.
U.V. filter



08.8160.98.OD

Filtro anti I.R.
I.R. filter



08.8160.68

Hot light
Hot light



08.8160.69

Cold light
Cold light



08.8160.CL

Daylight
Daylight



08.8160.DL

Neodimium
Neodimium



08.8160.ND

Anello esterno PRO per Pure Downlight 1. Solo per versioni ad alogeni, consultare per versione LED.







08.8232.30
08.8232.02
08.8232.14

Pure Downlight 1 external ring accessory PRO. Only for halogen lamps, consult for LED version.

COMPASS

DESIGNED BY FLOS ARCHITECTURAL

<p>ADJUSTABLE Ø90</p>  <p>LIGHT SOURCE LED PAR 16 GZ10</p> <p>LIGHT SOURCE LED QR-CBC 51 GX5.3</p>	<p>OPAL Ø90</p>  <p>LIGHT SOURCE LED QT-12 GY6.35</p>	<p>FIXED Ø90</p>  <p>LIGHT SOURCE LED QR-CBC 51 GX5.3</p>	<p>IP65 Ø95</p>  <p>LIGHT SOURCE LED QR-CBC 51 GX5.3</p>	<p>ADJUSTABLE Ø162</p>  <p>LIGHT SOURCE LED QR-111 G53</p>
---	---	---	---	--

□ 30 Bianco Opaco/RAL 9001
30 Matt White

■ 02 Grigio/RAL 9006
02 Grey

■ 14 Nero Opaco/RAL 9005
14 Matt Black



Compass Ø90

Compass Ø162

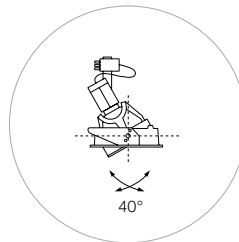
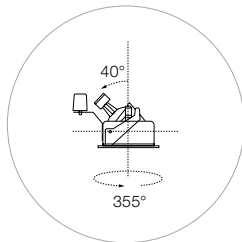

Descrizione

Apparecchi predisposti per lampade retrofit LED.

- Fisso:

Corpo da incasso in metallo verniciato di colore nero.

Anello di chiusura in lega di alluminio pressofusa e verniciata a polvere. Portalampada con elemento dissipatore in alluminio pressofuso. Anello antiriverbero in materiale termoplastico nero. Vetro di protezione temprato 4 mm di spessore. Sistema di fissaggio mediante staffe in acciaio inossidabile.

- Orientabile:

Apparecchio predisposto per sorgenti ad alogeni e a scarica alta pressione. Corpo ottico realizzato ad iniezione di alluminio, rifinito con vernice a polvere. Portalampada con elemento dissipatore in alluminio pressofuso verniciato a polvere di colore nero. Anello da incasso e anello di schermatura in materiale termoplastico; anello antiriverbero in alluminio pressofuso verniciato a polvere di colore nero. Vetro di protezione temprato di 4 mm di spessore. Sistema di fissaggio mediante staffe in acciaio inossidabile.

Accessori

- Cilindri di schermatura in Teflon nero e fissati su supporto in acciaio inossidabile.

- Cilindro schermante con spinotto rotante in materiale termoplastico nero.

- Lente di distribuzione ellittica in vetro temprato di 4 mm.

- Filtri cromatici.

Informazioni Aggiuntive

Sistema di orientamento di tipo a compasso, che permette l'orientamento fino a 40° in tutte le direzioni.

Grado di protezione IP23, IP43, IP44, IP65, a seconda delle versioni.

Classe di isolamento II, III, a seconda delle versioni.

Adatti ad installazioni su superfici normalmente infiammabili.

Conformità e Marchi di Qualità

Apparecchio conforme alla Normativa Tecnica Europea EN60598-1 e relative parti seconde.

Description

Luminaire for LED retrofit lamps.

- Fixed:

Recessed body in black-painted metal. Die-cast aluminum alloy, powder-coated closing ring. Die-cast aluminum lamp support with heat dissipating element. Black thermoplastic anti-glare ring, 4 mm tempered glass cover. Stainless steel fixing brackets.

- Adjustable:

Injection-moulded aluminum reflector body with powder-coated finish. Lamp support with die-cast aluminum, black powder-coated heat dissipating element. Thermoplastic recessed ring and screening ring; die-cast aluminum, black powder-coated anti-glare ring, 4 mm tempered glass cover. Stainless steel fixing brackets.

Accessories

- Black Teflon screening cylinders on stainless steel support.

- Screening cylinder with black thermoplastic rotating pin.

- 4 mm tempered glass elliptical distribution lens.

- Chromatic filters.

Additional Information

Compass-type adjustment system, for 0° - 40° adjustment in all directions.

IP23, IP43, IP44, IP65 protection grade depending on the versions.

Insulation class II, III depending on the versions.

Suitable for installation on normally inflammable surfaces.

Standard Compliance and Quality Marks

EN60598-1 European Technical Standards and any subsequent additions.

COMPASS

Compass Adjustable Ø90

Light Source: LED PAR 16 GZ10

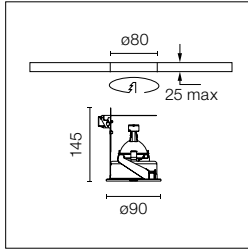

Apparecchio da incasso con alimentazione in tensione di rete per lampada LED Retrofit.

Recessed luminaire with main voltage source for LED Retrofit lamp.

Angolo di schermatura superiore ai 25°, secondo CIBSE LG3 (L<200 cd/m²).

Angle greater than 25°, as per CIBSE LG3 (L<200 cd/m²).

- 03.3506.30
- 03.3506.02
- 03.3506.14

Compass Opal C Ø90

Light Source: LED QT-12 GY6.35

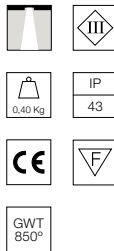
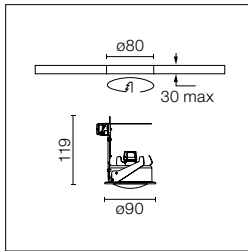

Apparecchio da incasso per lampada LED Retrofit 12V. Trasformatore remoto non incluso.

Recessed luminaire for 12V LED Retrofit lamp. Remote transformer not included.

- 03.3539.30
- 03.3539.02
- 03.3539.14

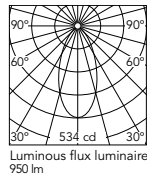

Beam Angle: 49°

h(m)	E(lx)	D(m)
1	534	0.90
2	134	1.80
3	59	2.71
4	33	3.61
5	21	4.51

Compass Opal P Ø90

Light Source: LED QT-12 GY6.35

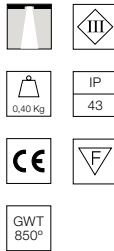
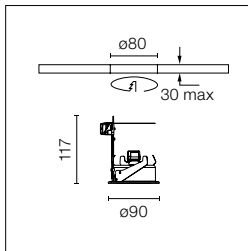

Apparecchio da incasso per lampada LED Retrofit 12V. Trasformatore remoto non incluso.

Recessed luminaire for 12V LED Retrofit lamp. Remote transformer not included.

- 03.3538.30
- 03.3538.02
- 03.3538.14

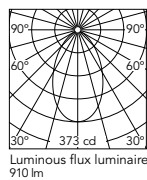

Beam Angle: 64°

h(m)	E(lx)	D(m)
1	373	1.25
2	93	2.50
3	41	3.75
4	23	5.00
5	15	6.24

COMPASS

Compass Adjustable Ø90

Light Source: LED QR-CBC 51 GX5.3

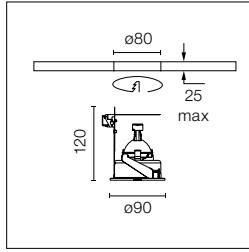

Apparecchio da incasso per lampada LED Retrofit 12V. Trasformatore remoto non incluso.

Recessed luminaire for 12V LED Retrofit lamp. Remote transformer not included.

Angolo di schermatura superiore ai 25°, secondo CIBSE LG3 (L<200 cd/m²).

Angle greater than 25°, as per CIBSE LG3 (L<200 cd/m²).

- 03.3505.30
- 03.3505.02
- 03.3505.14

Compass Fixed Ø90

Light Source: LED QR-CBC 51 GX5.3

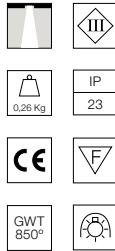
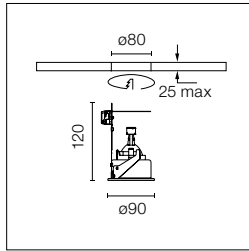

Apparecchio da incasso per lampada LED Retrofit 12V. Trasformatore remoto non incluso.

Recessed luminaire for 12V LED Retrofit lamp. Remote transformer not included.

Angolo di schermatura superiore ai 25°, secondo CIBSE LG3 (L<200 cd/m²).

Angle greater than 25°, as per CIBSE LG3 (L<200 cd/m²).

- 03.3507.30
- 03.3507.02
- 03.3507.14

Compass Adjustable Ø90

Light Source: LED QR-CBC 51 GX5.3

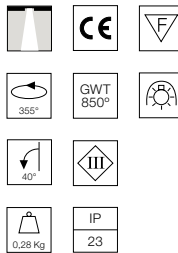
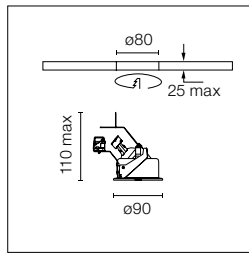

Apparecchio da incasso per lampada LED Retrofit 12V. Trasformatore remoto non incluso.

Recessed luminaire for 12V LED Retrofit lamp. Remote transformer not included.

- 03.3508.30
- 03.3508.02
- 03.3508.14

COMPASS

Compass IP65 Ø95

Light Source: LED QR-CBC 51 GX5.3

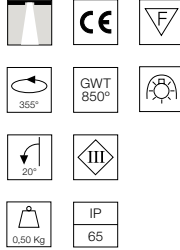
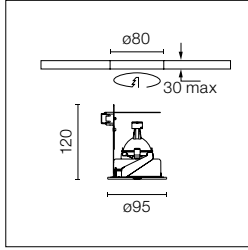

Apparecchio da incasso per lampada LED Retrofit 12V. Trasformatore remoto non incluso.

Recessed luminaire for 12V LED Retrofit lamp. Remote transformer not included.

- 03.3502.30
- 03.3502.02
- 03.3502.14

Compass Adjustable Ø162

Light Source: LED QR-111 G53

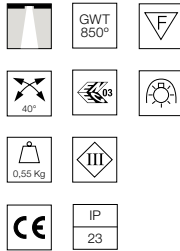
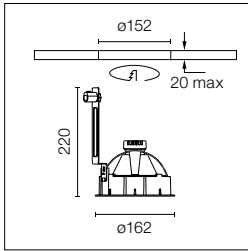

Apparecchio da incasso per lampada LED Retrofit 12V. Trasformatore remoto non incluso.

Recessed luminaire for 12V LED Retrofit lamp. Remote transformer not included.

- 03.3520.30
- 03.3520.02
- 03.3520.14

COMPASS

Accessori / Accessories

Refs: 3502 / 3505 / 3506 / 3507 / 3508

Compas Ø90/Ø95

Lente ellittica
Elliptical lens  08.8041.68

Filtro blu
Blue filter  08.8042.64.OD

Filtro azzurro
Sky blue filter  08.8042.65.OD

Filtro ambra
Amber filter  08.8042.66.OD

Filtro rosso
Red filter  08.8042.67.OD

Filtro anti U.V.
U.V. filter  08.8042.98.OD

Filtro anti I.R.
I.R. filter  08.8042.68

Hot light
Hot light  08.8042.69

Cold light
Cold light  08.8042.CL

Daylight
Daylight  08.8042.DL

Neodimium
Neodimium  08.8042.ND

Compas Ø162

Filtro a croce antiabbagliamento
Screening crosspiece  08.8034.14

Lente ellittica
Elliptical lens  08.8930.68

Griglia anti-abbagliamento
Anti-glare grid  08.8036.14

Lente flood
Flood lens  08.8931.68

Filtro blu
Blue filter  08.8932.64.OD

Filtro azzurro
Sky blue filter  08.8932.65.OD

Filtro ambra
Amber filter  08.8932.66.OD

Filtro rosso
Red filter  08.8932.67.OD

Filtro anti U.V.
U.V. filter  08.8932.98.OD

Filtro anti I.R.
I.R. filter  08.8933.68

Hot light
Hot light  08.8932.69

Cold light
Cold light  08.8932.CL

Daylight
Daylight  08.8932.DL

Neodimium
Neodimium  08.8932.ND

ANTHONY DOWNLIGHT

DESIGNED BY ANTONIO CITTERIO



LIGHT SOURCE
POWER LED
10W
905 lm
2700K/CRI 90
975 lm
3000K/CRI 90

□ 40 Bianco
40 White

■ 05 Cromo
05 Chrome

■ 14 Nero
14 Black



Descrizione

Downlight disegnato da Antonio Citterio per installazione da incasso a soffitto, con tecnologia power LED di ultima generazione.

Apparecchio di illuminazione dotato di sistema giratorio (360°) e basculante (40°) di grande versatilità, che ne consente l'orientamento preciso verso gli oggetti illuminati. Le finiture disponibili per la testa dell'apparecchio di illuminazione sono decorate, bianco, cromato e nero, mentre il corpo da incasso è sempre bianco. Questa nuova versione dispone di filtri honeycomb, ellittico e flood opzionali.

Unità di Alimentazione

Alimentatore a corrente costante non inclusa. Disponibili in versioni non regolabili e Dali per tensione di rete sia 110Vac, sia 230Vac.

Informazioni Aggiuntive

Grado di protezione IP20.
Classe di isolamento III.

Conformità e Marchi di Qualità

Apparecchio conforme alla Normativa Tecnica Europea EN60598-1 e relative parti seconde.

Description

Downlight designed by Antonio Citterio for installation in ceilings, with state-of-the-art power LED technology. Light fitting with highly versatile revolving (360°) and tilt (40°) system, enabling it to be accurately oriented towards illuminated objects. The finishes available have the light fitting heads in white, chrome and black, while the embedded body is always in white. This new version has honeycomb, elliptical and flood options.

Power Supply

Direct current power source not included Available in non-adjustable versions and DALI for network voltages 110Vac and 230Vac.

Additional Information

IP20 protection grade.
Insulation class III.

Standard Compliance and Quality Marks

EN60598-1 European Technical Standards and any subsequent additions.

ANTHONY DOWNLIGHT

Anthony Downlight

Light Source: Power LED DC 900mA - 10W - 905 lm - 2700K/CRI 90 / 10W - 975 lm - 3000K/CRI 90

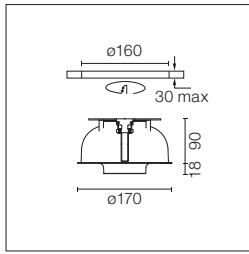

Apparecchio di illuminazione a LED ad alte prestazioni per installazione ad incasso. Fonte di alimentazione remota 220-240V non inclusa.

High-performance embedded light fixture for LED light source. Remote 220-240V power supply not included.

Elemento concavo standard in bianco per tutte le finiture; finitura nera disponibile su richiesta.

Standard trim cove in white for all finishes; black finish available under request.

Alimentazioni raccomandate / Recommended power supply*:

Non Dimmable 110-240V (900mA)	60.9233
Dimmable Dali 2 220-240V	RF30699
Dimmable Dali/1-10V/Push	RF21468
Dimmable 0-10V 220-240V	RF27961
Mains Dimming	60.9467
Casambi	60.9207

* Vedi capitolo Drivers / Refer to the Drivers chapter

2700K

- 03.6415.40B
- 03.6415.05B
- 03.6415.14B

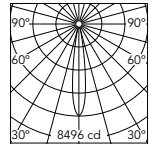

Beam Angle: 15°			
h(m)	E(lx)	D(m)	
1	8496	0.27	
2	2124	0.54	
3	944	0.81	
4	531	1.09	
5	340	1.36	

Luminous flux luminaire
795 lm

3000K

- 03.6416.40B
- 03.6416.05B
- 03.6416.14B

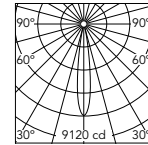

Beam Angle: 15°			
h(m)	E(lx)	D(m)	
1	9120	0.27	
2	2280	0.54	
3	1013	0.81	
4	570	1.09	
5	365	1.36	

Luminous flux luminaire
853 lm

2700K

- 03.6417.40B
- 03.6417.05B
- 03.6417.14B

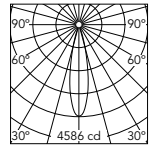

Beam Angle: 22°			
h(m)	E(lx)	D(m)	
1	4586	0.40	
2	1147	0.79	
3	510	1.19	
4	287	1.58	
5	183	1.98	

Luminous flux luminaire
827 lm

3000K

- 03.6418.40B
- 03.6418.05B
- 03.6418.14B

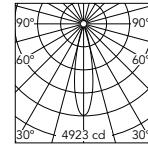

Beam Angle: 22°			
h(m)	E(lx)	D(m)	
1	4923	0.40	
2	1231	0.79	
3	547	1.19	
4	308	1.58	
5	197	1.98	

Luminous flux luminaire
888 lm

Accessori / Accessories

Lente ellittica.

Elliptical lens.



08.8418.68A

Honeycomb.

Honeycomb.



08.8419.14A

Lente flood.

Per ottenere l'ottica flood (35°) richiedere Anthony Downlight Medium + lente flood.

Flood lens.

To obtain flood optics (35°) order Anthony Downlight Medium + flood lens.



08.0050.00

WAN DOWNLIGHT

DESIGNED BY JOHANNA GRAWUNDER



LIGHT SOURCE
LED ARRAY
9,2W
945 lm
3000K/CRI 80



LIGHT SOURCE
LED
QT-14
G9

□ 30 Bianco
30 White

■ 05 Alluminio Lucido
05 Polished Aluminium

■ 14 Nero
14 Black

■ GN Verde
GN Green



Descrizione

Apparecchio di illuminazione da incasso per installazione a soffitto a luce diretta. Anello in alluminio nelle finiture cromato, bianco lucido, verde lucido e nero lucido. Schermo antiabbagliamento. L'apparecchio è dotato di due differenti anelli con finitura verde lucido e nero lucido, che hanno la funzione di riparare il vetro temperato di sicurezza.

Riflettori

Riflettore in alluminio sabbato e sbiancato chimicamente.

Unità di Alimentazione

Precablaggio incluso pronto per essere alimentato per mezzo di apparecchiature remote.

Informazioni Aggiuntive

Grado di protezione IP44.
Classe di isolamento II, III, a seconda delle versioni.
Adatti ad installazioni su superfici normalmente infiammabili.

Conformità e Marchi di Qualità

Apparecchio conforme alla Normativa Tecnica Europea EN60598-1 e relative parti seconde.

Description

Ceiling recessed luminary providing direct light. Aluminum ring, available in chrome, shiny white, enameled green, and shiny black finishes. Low glare shield. Provided by two different ring due to fix the safety tempered glass, in shiny black and enameled green.

Reflectors

Sanded and chemically bleached aluminum reflector.

Power Supply

Pre-wiring included; ready for remote power supply.

Additional Information

IP44 protection grade.
Insulation class II, III depending on the versions.
Suitable for installation on normally inflammable surfaces.

Standard Compliance and Quality Marks

EN60598-1 European Technical Standards and any subsequent additions.

WAN DOWNLIGHT

Wan Downlight

Light Source: LED Array DC 500 mA - 9,2W - 945 lm - 3000K/CRI 80

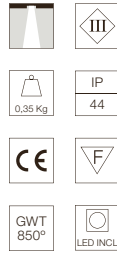
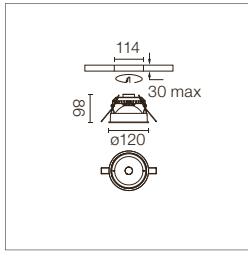

Apparecchio di illuminazione da incasso a LED. Fonte di alimentazione esclusa.

Recessed luminaire with LED light source. Power supply not included.

Alimentazioni raccomandate / Recommended power supply*:

Non Dimmable	60.9160
Dimmable 1-10V	RF27961
Dimmable Dali	RF26571
Dimmable Dali 2	60.9222
Mains Dimming	60.9411
Casambi	60.9207

* Vedi capitolo Drivers / Refer to the Drivers chapter

- 03.6154.30A
- 03.6154.05A
- 03.6154.14A
- 03.6154.GNA

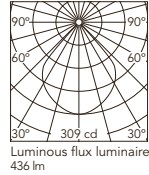

Beam Angle: 83°

h(m)	E(lx)	D(m)
1	309	1.77
2	77	3.55
3	34	5.32
4	19	7.09
5	12	8.87

Wan Downlight

Light Source: LED QT-14 G9

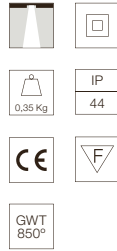
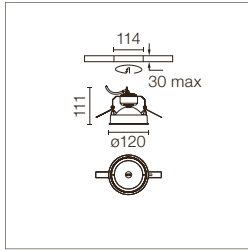

Apparecchio di illuminazione da incasso con alimentazione in tensione di rete.

Recessed luminaire with main voltage source.

- 03.6150.30
- 03.6150.05
- 03.6150.14
- 03.6150.GN

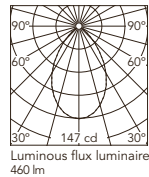

Beam Angle: 68°

h(m)	E(lx)	D(m)
1	147	1.35
2	37	2.70
3	16	4.05
4	9	5.40
5	6	6.75

@Black Ring

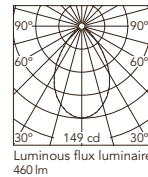

Beam Angle: 69°

h(m)	E(lx)	D(m)
1	149	1.38
2	37	2.75
3	17	4.13
4	9	5.50
5	6	6.88

@Green Ring

LIGHT SOLDIER

DESIGNED BY FLOS ARCHITECTURAL

FIXED
Ø75



ADJUSTABLE
Ø90



LIGHT SOURCE
LED ARRAY
9,2W
893 lm
2700K/CRI 90
810 lm
3000K/CRI 90

□ 30 Bianco
30 White



■ 02 Grigio
02 Grey



■ 14 Nero
14 Black



Può essere ruotato di 360° e orientato di 30°.
Can be rotated 360° and swivelled 30°.

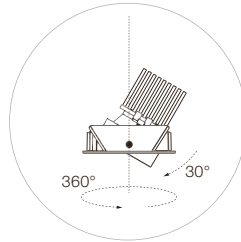

LIGHT SOLDIER

Descrizione

Apparecchi di illuminazione predisposti per installazione ad incasso con fonte luminosa LED disponibili nella versione fissa o basculante. Anello frontale rotondo di alluminio unito ad un anello in materiale termoplastico nero che offre un elevato comfort visivo.

Riflettori

Realizzati in plastica, con aperture di 18° - 26° e 56°.

Unità di Alimentazione

Fonte di alimentazione a corrente costante non inclusa.

Accessori

E' dotato di un diffusore di plastica che migliora l'uniformità della luce e il comfort visivo.

Informazioni Aggiuntive

Grado di protezione IP20.

Classe di isolamento III.

Adatti ad installazioni su superfici normalmente infiammabili.

Conformità e Marchi di Qualità

Apparecchio conforme alla Normativa Tecnica Europea EN60598-1 e relative parti seconde.

Description

Embedded light fixtures for LED light source available in fixed or tilt versions. Comprised of a round hoop at the front made of aluminium, next to a ring made of black thermoplastic material, giving great visual comfort.

Reflectors

Made of plastic, with openings of 18° - 26° and 56°.

Power Supply

Constant current power supply not included.

Accessories

With plastic diffuser to enhance light uniformity and improve visual comfort incorporated into the light fixture.

Additional Information

IP20 protection grade.

Insulation class III.

Suitable for installation on normally inflammable surfaces.

Standard Compliance and Quality Marks

EN60598-1 European Technical Standards and any subsequent additions.



LIGHT SOLDIER

Light Soldier Fixed Ø75

Light Source: LED Array DC 500 mA - 9,2W - 893 lm - 2700K/CRI 90 / 9,2W - 810 lm - 3000K/CRI 90

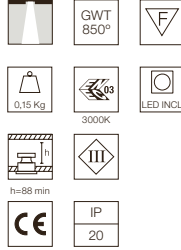
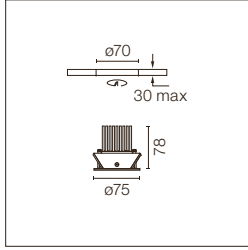

Apparecchio di illuminazione da incasso a LED. Fonte di alimentazione esclusa.

Recessed luminaire with LED light source. Power supply not included.

Alimentazioni raccomandate / Recommended power supply*:

Non Dimmable 500mA	60.9160
Non Dimmable MC	RF27370
Dimmable 1-10V MC	RF27961
Dimmable Dali 1 MC	RF26571
Dimmable Dali 2 MC	60.9222
Mains Dimming MC	60.9411
Casambi	60.9207

* Vedi capitolo Drivers / Refer to the Drivers chapter

2700K
 □ 03.4311.30A
 ■ 03.4311.02A
 ■ 03.4311.14A

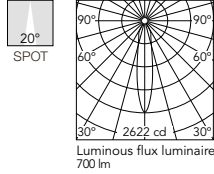

h(m)	E(lx)	D(m)
1	2622	0.35
2	655	0.70
3	291	1.04
4	164	1.39
5	105	1.74

3000K
 □ 03.4300.30B
 ■ 03.4300.02B
 ■ 03.4300.14B

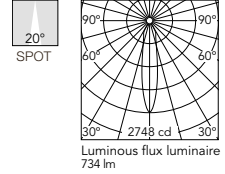

h(m)	E(lx)	D(m)
1	2748	0.35
2	687	0.70
3	305	1.04
4	172	1.39
5	110	1.74

2700K
 □ 03.4312.30A
 ■ 03.4312.02A
 ■ 03.4312.14A

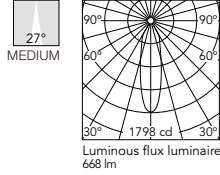

h(m)	E(lx)	D(m)
1	1798	0.48
2	450	0.95
3	200	1.43
4	112	1.90
5	72	2.38

3000K
 □ 03.4301.30B
 ■ 03.4301.02B
 ■ 03.4301.14B

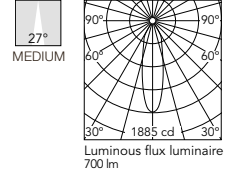

h(m)	E(lx)	D(m)
1	1885	0.48
2	471	0.95
3	209	1.43
4	118	1.90
5	75	2.38

2700K
 □ 03.4313.30A
 ■ 03.4313.02A
 ■ 03.4313.14A

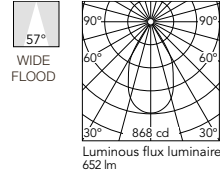

h(m)	E(lx)	D(m)
1	868	1.08
2	217	2.15
3	96	3.23
4	54	4.30
5	35	5.38

3000K
 □ 03.4302.30B
 ■ 03.4302.02B
 ■ 03.4302.14B

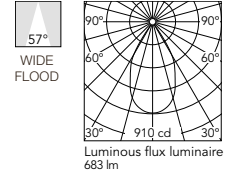

h(m)	E(lx)	D(m)
1	910	1.08
2	227	2.15
3	101	3.23
4	57	4.30
5	36	5.38

LIGHT SOLDIER

Light Soldier Adjustable Ø90

Light Source: LED Array DC 500 mA - 9,2W - 893 lm - 2700K/CRI 90 / 9,2W - 810 lm - 3000K/CRI 90

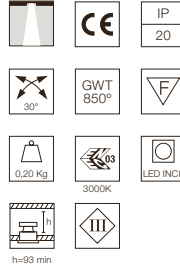
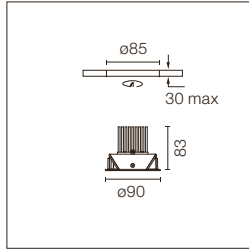

Apparecchio di illuminazione da incasso a LED. Fonte di alimentazione esclusa.

Recessed luminaire with LED light source. Power supply not included.

Alimentazioni raccomandate / Recommended power supply*:

Non Dimmable 500mA

60.9160

Non Dimmable MC

RF27370

Dimmable Dali 1 MC

RF26571

Dimmable Dali 2 MC

60.9222

Mains Dimming MC

60.9411

Casambi

60.9207

* Vedi capitolo Drivers / Refer to the Drivers chapter

2700K

03.4331.30A
03.4331.02A
03.4331.14A

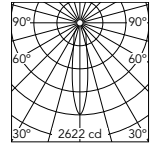

Beam Angle: 20°

h(m)	E(lx)	D(m)
1	2622	0.35
2	655	0.70
3	291	1.04
4	164	1.39
5	105	1.74

Luminous flux luminaire
700 lm

3000K

03.4320.30B
03.4320.02B
03.4320.14B

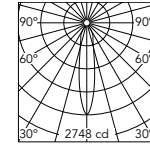

Beam Angle: 20°

h(m)	E(lx)	D(m)
1	2748	0.35
2	687	0.70
3	305	1.04
4	172	1.39
5	110	1.74

Luminous flux luminaire
734 lm

2700K

03.4332.30A
03.4332.02A
03.4332.14A

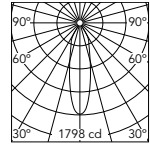

Beam Angle: 27°

h(m)	E(lx)	D(m)
1	1798	0.48
2	450	0.95
3	200	1.43
4	112	1.90
5	72	2.38

Luminous flux luminaire
668 lm

3000K

03.4321.30B
03.4321.02B
03.4321.14B

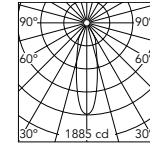

Beam Angle: 27°

h(m)	E(lx)	D(m)
1	1885	0.48
2	471	0.95
3	209	1.43
4	118	1.90
5	75	2.38

Luminous flux luminaire
700 lm

2700K

03.4333.30A
03.4333.02A
03.4333.14A

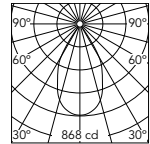

Beam Angle: 57°

h(m)	E(lx)	D(m)
1	868	1.08
2	217	2.15
3	96	3.23
4	54	4.30
5	35	5.38

Luminous flux luminaire
652 lm

3000K

03.4322.30B
03.4322.02B
03.4322.14B

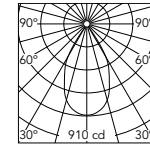

Beam Angle: 57°

h(m)	E(lx)	D(m)
1	910	1.08
2	227	2.15
3	101	3.23
4	57	4.30
5	36	5.38

Luminous flux luminaire
683 lm

Driver current (mA)	2700K		3000K	
	Luminous flux (lm)	Power (W)	Luminous flux (lm)	Power (W)
350	521	6,2	545	6,2
500	893	9,2	810	9,2

DECOFIX

DESIGNED BY FLOS ARCHITECTURAL

ROUND 1L



ROUND 2L



SQUARE 1L



SQUARE 2L



LIGHT SOURCE
LED ARRAY
9,2W
744 lm
2700K/CRI 90
945 lm
3000K/CRI 80

□ 30 Bianco
30 White

■ 14 Nero
14 Black



Colori del Cilindro Schermante (compresi)
Screening Cylinder Colours (included)

▣ Argento
Silver

■ Oro
Gold

■ Nero
Black



DECOFIX

Descrizione

Apparecchi di illuminazione predisposti per installazione ad incasso da 1 e 2 luci, per fonti di illuminazione LED. La posizione arretrata della sorgente luminosa consente un ottimo comfort visivo. Disponibile nelle versioni quadrate e rotonde rifinite in bianco e nero opaco. Sono composti da un corpo realizzato in alluminio e molle di fissaggio a soffitto. Dispongono di un radiatore per ciascun LED, realizzato in alluminio iniettato.

Riflettori

Realizzati in plastica metallizzata.

Unità di Alimentazione

Fonte di alimentazione a corrente costante esclusa.

Accessori

Tutte le versioni sono dotate di un cilindro schermante disponibile in 3 colori, nero, oro e argento, intercambiabili fra loro ed incorporati all'apparecchio. Inoltre incorpora un diffusore di plastica che migliora l'uniformità della luce e il comfort visivo.

Informazioni Aggiuntive

Grado di protezione IP20.
Classe di isolamento III.
Adatti ad installazioni su superfici normalmente infiammabili.

Conformità e Marchi di Qualità

Apparecchio conforme alla Normativa Tecnica Europea EN60598-1 e relative parti seconde.

Description

Fixed embedded light fixtures with 1 and 2 lights, for LED light source. Great visual comfort due to rear position of light source. Available in square and round versions in a matt white and black finish. They are made up of a body made in aluminium and fixing springs to the ceiling. They have a radiator for each LED made out of injected aluminium.

Reflectors

Made of metallized plastic.

Power Supply

Constant current power supply not included.

Accessories

All versions have interchangeable screening cylinders in 3 colours: black, gold or silver, incorporated into the light fixture. With a plastic diffuser to enhance light uniformity and improve visual comfort, incorporated into the light fixture.

Additional Information

IP20 protection grade.
Insulation class III.
Suitable for installation on normally inflammable surfaces.

Standard Compliance and Quality Marks

EN60598-1 European Technical Standards and any subsequent additions.



DECOFIX

Decofix Round 1L

Light Source: LED Array DC 500 mA - 9,2W - 744 lm - 2700K/CRI 90 / 9,2W - 945 lm - 3000K/CRI 80

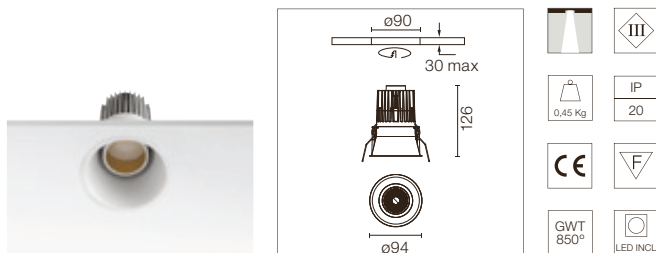

Apparecchio di illuminazione da incasso a LED. Fonte di alimentazione esclusa.

Recessed luminaire with LED light source. Power supply not included.

Alimentazioni raccomandate / Recommended power supply*:

Non Dimmable	60.9160
Dimmable 1-10V	RF27961
Dimmable Dali 1	RF26571
Dimmable Dali 2	60.9222
Mains Dimming	60.9411
Casambi	60.9207

* Vedi capitolo Drivers / Refer to the Drivers chapter

2700K
□ 09.3111.30A

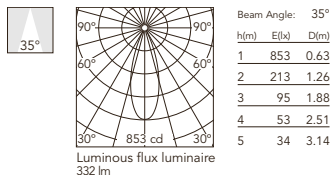

3000K
□ 09.3110.30A

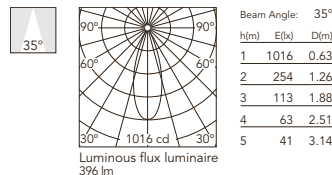

2700K
■ 09.3111.14A

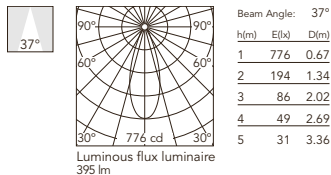

3000K
■ 09.3110.14A

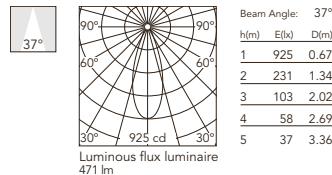

Decofix Square 1L

Light Source: LED Array DC 500 mA - 9,2W - 744 lm - 2700K/CRI 90 / 9,2W - 945 lm - 3000K/CRI 80

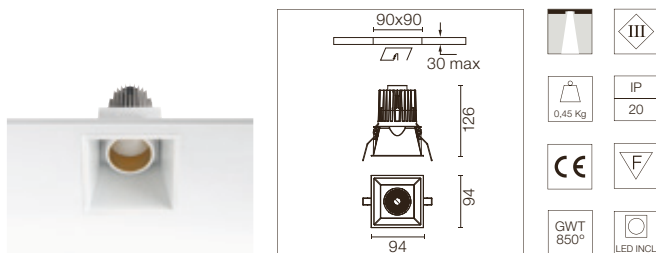

Apparecchio di illuminazione da incasso a LED. Fonte di alimentazione esclusa.

Recessed luminaire with LED light source. Power supply not included.

Alimentazioni raccomandate / Recommended power supply*:

Non Dimmable	60.9160
Dimmable 1-10V	RF27961
Dimmable Dali 1	RF26571
Dimmable Dali 2	60.9222
Mains Dimming	60.9411
Casambi	60.9207

* Vedi capitolo Drivers / Refer to the Drivers chapter

2700K
□ 09.3101.30A

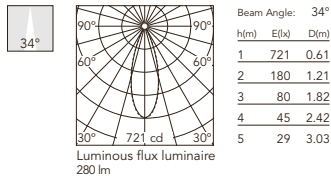

3000K
□ 09.3100.30A

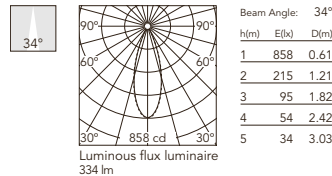

2700K
■ 09.3101.14A

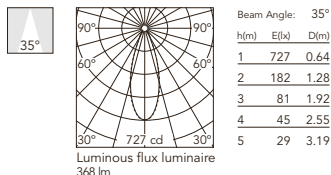

3000K
■ 09.3100.14A

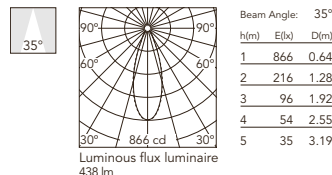

DECOFIX

Decofix Round 2L

Light Source: LED Array DC 500 mA - 2x9,2W - 2x744 lm - 2700K/CRI 90 / 2x9,2W - 2x945 lm - 3000K/CRI 80

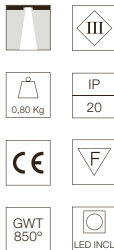
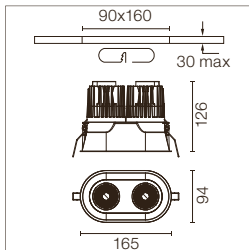

Apparecchio di illuminazione da incasso a LED a 2 luci. Fonte di alimentazione esclusa. Si richiede una fonte di alimentazione per ogni corpo ottico.

Recessed luminaire with 2 lights for LED light source. Power supply not included. Requires one power supply for each optic body.

Alimentazioni raccomandate / Recommended power supply*:

Non Dimmable	60.9160
Dimmable 1-10V	RF27961
Dimmable Dali 1	RF26571
Dimmable Dali 2	60.9222
Mains Dimming	60.9411
Casambi	60.9207

* Vedi capitolo Drivers / Refer to the Drivers chapter

2700K
□ 09.3116.30A

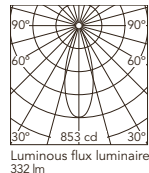

Beam Angle: 35°

h(m)	E(lx)	D(m)
1	853	0.63
2	213	1.26
3	95	1.88
4	53	2.51
5	34	3.14

3000K
□ 09.3115.30A

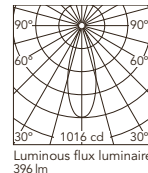

Beam Angle: 35°

h(m)	E(lx)	D(m)
1	1016	0.63
2	254	1.26
3	113	1.88
4	63	2.51
5	41	3.14

2700K
■ 09.3116.14A

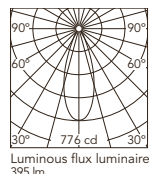

Beam Angle: 37°

h(m)	E(lx)	D(m)
1	776	0.67
2	194	1.34
3	86	2.02
4	49	2.69
5	31	3.36

3000K
■ 09.3115.14A

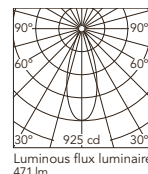

Beam Angle: 37°

h(m)	E(lx)	D(m)
1	925	0.67
2	231	1.34
3	103	2.02
4	58	2.69
5	37	3.36

Decofix Square 2L

Light Source: LED Array DC 500 mA - 2x9,2W - 2x744 lm - 2700K/CRI 90 / 2x9,2W - 2x945 lm - 3000K/CRI 80

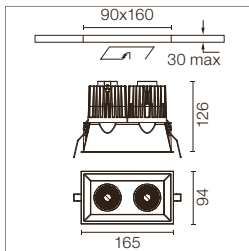

Apparecchio di illuminazione da incasso a LED a 2 luci. Fonte di alimentazione esclusa. Si richiede una fonte di alimentazione per ogni corpo ottico.

Recessed luminaire with 2 lights for LED light source. Power supply not included. Requires one power supply for each optic body included.

Alimentazioni raccomandate / Recommended power supply*:

Non Dimmable	60.9160
Dimmable 1-10V	RF27961
Dimmable Dali 1	RF26571
Dimmable Dali 2	60.9222
Mains Dimming	60.9411
Casambi	60.9207

* Vedi capitolo Drivers / Refer to the Drivers chapter

2700K
□ 09.3106.30A

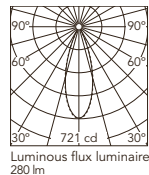

Beam Angle: 34°

h(m)	E(lx)	D(m)
1	721	0.61
2	180	1.21
3	80	1.82
4	45	2.42
5	29	3.03

3000K
□ 09.3105.30A

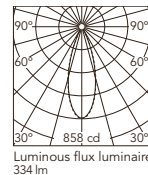

Beam Angle: 34°

h(m)	E(lx)	D(m)
1	858	0.61
2	215	1.21
3	95	1.82
4	54	2.42
5	34	3.03

2700K
■ 09.3106.14A

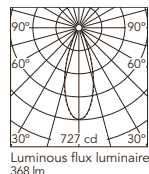

Beam Angle: 35°

h(m)	E(lx)	D(m)
1	727	0.64
2	182	1.28
3	81	1.92
4	45	2.55
5	29	3.19

3000K
■ 09.3105.14A

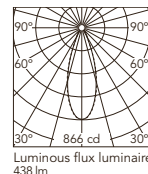

Beam Angle: 35°

h(m)	E(lx)	D(m)
1	866	0.64
2	216	1.28
3	96	1.92
4	54	2.55
5	35	3.19

JOHNNY

DESIGNED BY FLOS ARCHITECTURAL

JOHNNY 80
TRIM / NO TRIM
1L ROUND
1L/2L SQUARE



LIGHT SOURCE
POWER LED
6,2W
560 lm
2700K/CRI 90
600 lm
3000K/CRI 90

JOHNNY 80
SEMI-RECESSED
1L/2L SQUARE



LIGHT SOURCE
POWER LED
6,2W
560 lm
2700K/CRI 90
600 lm
3000K/CRI 90

JOHNNY 120
TRIM / NO TRIM
1L ROUND
1L/2L SQUARE



LIGHT SOURCE
LED ARRAY
LED ARRAY HIGH PERFORMANCE
18W
1555 lm
2700K/CRI 90
1600 lm
3000K/CRI 90

JOHNNY 120
SEMI-RECESSED
1L/2L SQUARE



Johnny 80
Trim / No Trim



□ 40 Bianco
40 White ■ 14 Nero
14 Black

Johnny 120
Trim



□ Bianco
White ■ Nero
Black

Johnny 120
No Trim



■ Nero
Black

Interno / Inside

□ Bianco
White ■ Nero
Black

Esterno / Outside

□ 40 Bianco
40 White ■ CE Cemento
CE Concrete ■ TK Teck
TK Teak ■ 14 Nero
14 Black

Johnny 80 Semi-Recessed



Johnny 120 Semi-Recessed



Può essere ruotato in qualsiasi senso.
Can be rotated in any direction.

Johnny 80

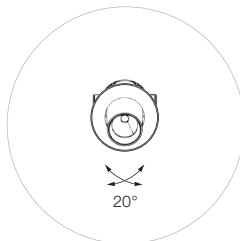

Johnny 120

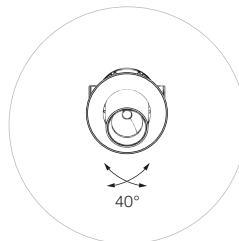

Descrizione

Sistema d'illuminazione a uno o due fuochi orientabili, in versione a incasso (Trim e No Trim) e a semi-incasso per l'installazione a soffitto.

Disponibile in due dimensioni: 80 mm e 120 mm in versione rotonda e quadrata

Sistema di orientamento esclusivo di facile fissaggio che consente l'orientamento preciso del fascio di luce.

Unità di Alimentazione

Fonte di alimentazione a corrente costante 220/240V remota inclusa.

Accessori

Johnny 80:

- Filtro a croce antiabbagliamento e honeycomb compresi nel prodotto

Johnny 120:

- Filtro a croce antiabbagliamento
- Honeycomb
- Lente ellittica
- Lente flood

Informazioni Aggiuntive

Sistema di orientamento integrato nel corpo telescopico per la versione Johnny 80.

Grado di protezione IP20.

Adatti ad installazioni su superfici normalmente infiammabili.

Conformità e Marchi di Qualità

Apparecchio conforme alla Normativa Tecnica Europea EN60598-1 e relative parti seconde.

Description

Illumination system consisting of one or two adjustable lights, in the embedded version (Trim and No Trim) and semi-embedded version to be installed on the ceiling.

Available in two sizes: 80 mm and 120 mm in round and square versions.

An exclusive, easy and adjustable system that enables an accurate adjustment of the light beam.

Power Supply

Remote constant power supply 220/240V not included.

Accessories

Johnny 80:

- Screening crosspiece and honeycomb included in the product

Johnny 120:

- Screening crosspiece
- Honeycomb
- Elliptical lens
- Flood lens

Additional Information

The Johnny 80 version has a orientation system integrated into the telescopic body.

IP20 protection grade.

Suitable for installation on normally inflammable surfaces.

Standard Compliance and Quality Marks

EN60598-1 European Technical Standards and any subsequent additions.



Johnny 80
1L Trim



Johnny 80
1L No Trim



Johnny 80
2L Trim



Johnny 80
2L No Trim



Johnny 80
Semi-Recessed



Johnny 120
Trim



Johnny 120
No Trim



Johnny 120
Semi-Recessed

JOHNNY 80

Johnny Ø80 Trim 1L Round

Light Source: Power LED

Without accessories: DC 500 mA - 6,2W - 560 lm - 2700K/CRI 90 / 6,2W - 600 lm - 3000K/CRI 90

With accessories: DC 450 mA - 5,5W - 505 lm - 2700K/CRI 90 / 5,5W - 540 lm - 3000K/CRI 90

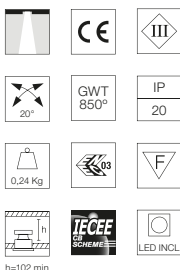
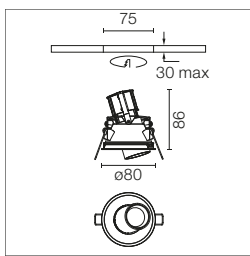

Apparecchio di illuminazione da incasso a LED. Fonte di alimentazione esclusa.

Recessed luminaire with LED light source. Power supply not included.

Accessori inclusi (honeycomb e filtro a croce antiabbagliamento).

Accessories included (honeycomb and screening crosspiece).

Johnny Ø80 No Trim 1L Round

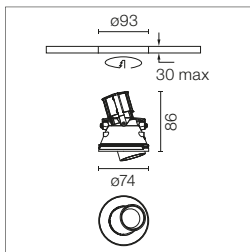

Alimentazioni raccomandate / Recommended power supply*:

	450 mA	500 mA
Non Dimmable	60.9160	60.9160
Dimmable 1-10V	RF27961	RF27961
Dimmable Dali 1	RF26571	RF26571
Dimmable Dali 2	60.9222	60.9222
Mains Dimming	60.9467	60.9411
Casambi	60.9207	60.9207

* Vedi capitolo Drivers / Refer to the Drivers chapter

- 2700K**
- 03.0701.40A
- 03.0701.14A
- 03.0701.40ANT
- 03.0701.14ANT

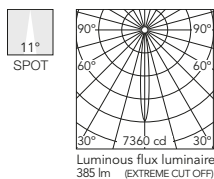

Beam Angle: 11°

h(m)	E(lx)	D(m)
1	7360	0.19
2	1840	0.38
3	818	0.57
4	460	0.76
5	294	0.95

- 3000K**
- 03.0700.40A
- 03.0700.14A
- 03.0700.40ANT
- 03.0700.14ANT

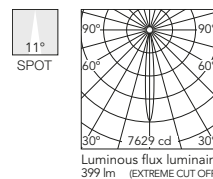

Beam Angle: 11°

h(m)	E(lx)	D(m)
1	7629	0.19
2	1907	0.38
3	848	0.57
4	477	0.76
5	305	0.95

- 2700K**
- 03.0705.40A
- 03.0705.14A
- 03.0705.40ANT
- 03.0705.14ANT

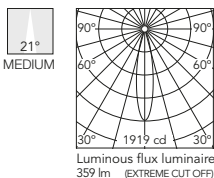

Beam Angle: 21°

h(m)	E(lx)	D(m)
1	1919	0.37
2	480	0.74
3	213	1.12
4	120	1.49
5	77	1.86

- 3000K**
- 03.0704.40A
- 03.0704.14A
- 03.0704.40ANT
- 03.0704.14ANT

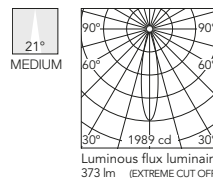

Beam Angle: 21°

h(m)	E(lx)	D(m)
1	1989	0.37
2	497	0.74
3	221	1.12
4	124	1.49
5	80	1.86

- 2700K**
- 03.0709.40A
- 03.0709.14A
- 03.0709.40ANT
- 03.0709.14ANT

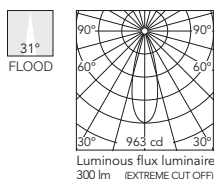

Beam Angle: 31°

h(m)	E(lx)	D(m)
1	963	0.55
2	241	1.10
3	107	1.65
4	60	2.20
5	39	2.75

- 3000K**
- 03.0708.40A
- 03.0708.14A
- 03.0708.40ANT
- 03.0708.14ANT

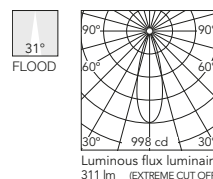

Beam Angle: 31°

h(m)	E(lx)	D(m)
1	998	0.55
2	249	1.10
3	111	1.65
4	62	2.20
5	40	2.75

JOHNNY 80

Johnny 80 Trim 1L Square

Light Source: Power LED

Without accessories: DC 500 mA - 6,2W - 560 lm - 2700K/CRI 90 / 6,2W - 600 lm - 3000K/CRI 90

With accessories: DC 450 mA - 5,5W - 505 lm - 2700K/CRI 90 / 5,5W - 540 lm - 3000K/CRI 90

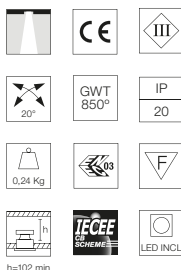
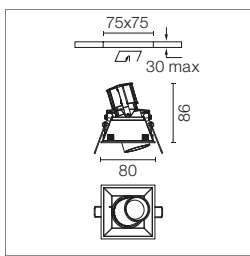

Apparecchio di illuminazione da incasso a LED. Fonte di alimentazione esclusa.

Recessed luminaire with LED light source. Power supply not included.

Accessori inclusi (honeycomb e filtro a croce antiabbagliamento).

Accessories included (honeycomb and screening crosspiece).

Johnny 80 No Trim 1L Square

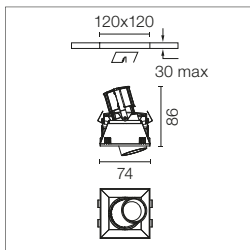

Alimentazioni raccomandate / Recommended power supply*:

	450 mA	500 mA
Non Dimmable	60.9160	60.9160
Dimmable 1-10V	RF27961	RF27961
Dimmable Dali 1	RF26571	RF26571
Dimmable Dali 2	60.9222	60.9222
Mains Dimming	60.9467	60.9411
Casambi	60.9207	60.9207

* Vedi capitolo Drivers / Refer to the Drivers chapter

- 2700K**
- 03.0703.40A
- 03.0703.14A
- 03.0703.40ANT
- 03.0703.14ANT

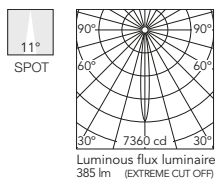

Beam Angle: 11°

h(m)	E(lx)	D(m)
1	7360	0.19
2	1840	0.38
3	818	0.57
4	460	0.76
5	294	0.95

- 3000K**
- 03.0702.40A
- 03.0702.14A
- 03.0702.40ANT
- 03.0702.14ANT

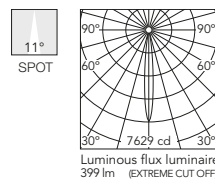

Beam Angle: 11°

h(m)	E(lx)	D(m)
1	7629	0.19
2	1907	0.38
3	848	0.57
4	477	0.76
5	305	0.95

- 2700K**
- 03.0707.40A
- 03.0707.14A
- 03.0707.40ANT
- 03.0707.14ANT

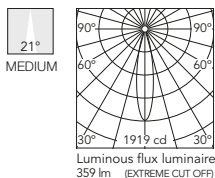

Beam Angle: 21°

h(m)	E(lx)	D(m)
1	1919	0.37
2	480	0.74
3	213	1.12
4	120	1.49
5	77	1.86

- 3000K**
- 03.0706.40A
- 03.0706.14A
- 03.0706.40ANT
- 03.0706.14ANT

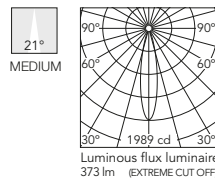

Beam Angle: 21°

h(m)	E(lx)	D(m)
1	1989	0.37
2	497	0.74
3	221	1.12
4	124	1.49
5	80	1.86

- 2700K**
- 03.0711.40A
- 03.0711.14A
- 03.0711.40ANT
- 03.0711.14ANT

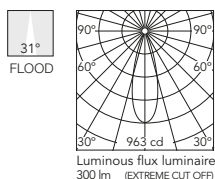

Beam Angle: 31°

h(m)	E(lx)	D(m)
1	963	0.55
2	241	1.10
3	107	1.65
4	60	2.20
5	39	2.75

- 3000K**
- 03.0710.40A
- 03.0710.14A
- 03.0710.40ANT
- 03.0710.14ANT

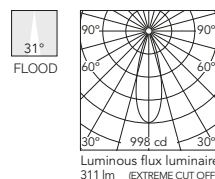

Beam Angle: 31°

h(m)	E(lx)	D(m)
1	998	0.55
2	249	1.10
3	111	1.65
4	62	2.20
5	40	2.75

JOHNNY 80

Johnny 80 Trim 2L Square

Light Source: Power LED

Without accessories: 500 mA - 2x6,2W - 2x560 lm - 2700K/CRI 90 / 2x6,2W - 2x600 lm - 3000K/CRI 90

With accessories: DC 450 mA - 2x5,5W - 2x505 lm - 2700K/CRI 90 / 2x5,5W - 2x540 lm - 3000K/CRI 90

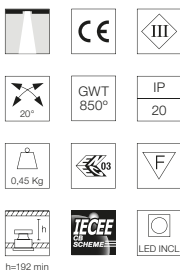
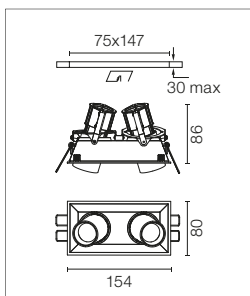

Apparecchio di illuminazione da incasso a LED. Fonte di alimentazione esclusa. Si richiede una fonte di alimentazione per ogni corpo ottico.

Recessed luminaire with LED light source. Power supply not included. Requires one power supply for each optic body.

Accessori inclusi (honeycomb e filtro a croce antiabbagliamento).

Accessories included (honeycomb and screening crosspiece).

Johnny 80 No Trim 2L Square

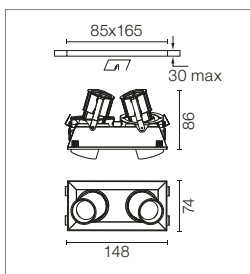

Cornice di pre-installazione da ordinare separatamente.

Pre-installation frame. To be ordered separately.

Alimentazioni raccomandate / Recommended power supply*:

	450 mA	500 mA
Non Dimmable	60.9160	60.9160
Dimmable 1-10V	RF27961	RF27961
Dimmable Dali 1	RF26571	RF26571
Dimmable Dali 2	60.9222	60.9222
Mains Dimming	60.9467	60.9411
Casambi	60.9207	60.9207

* Vedi capitolo Drivers / Refer to the Drivers chapter

2700K

- 03.0713.40A
- 03.0713.14A

- 03.0713.40ANT
- 03.0713.14ANT

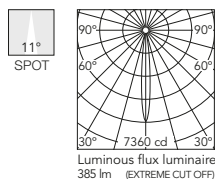

Beam Angle: 11°

h(m)	E(lx)	D(m)
1	7360	0.19
2	1840	0.38
3	818	0.57
4	460	0.76
5	294	0.95

Luminous flux luminaire 385 lm (EXTREME CUT OFF)

3000K

- 03.0712.40A
- 03.0712.14A

- 03.0712.40ANT
- 03.0712.14ANT

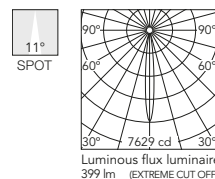

Beam Angle: 11°

h(m)	E(lx)	D(m)
1	7629	0.19
2	1907	0.38
3	848	0.57
4	477	0.76
5	305	0.95

Luminous flux luminaire 399 lm (EXTREME CUT OFF)

2700K

- 03.0715.40A
- 03.0715.14A

- 03.0715.40ANT
- 03.0715.14ANT

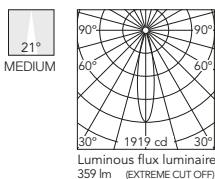

Beam Angle: 21°

h(m)	E(lx)	D(m)
1	1919	0.37
2	480	0.74
3	213	1.12
4	120	1.49
5	77	1.86

Luminous flux luminaire 359 lm (EXTREME CUT OFF)

3000K

- 03.0714.40A
- 03.0714.14A

- 03.0714.40ANT
- 03.0714.14ANT

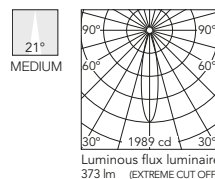

Beam Angle: 21°

h(m)	E(lx)	D(m)
1	1989	0.37
2	497	0.74
3	221	1.12
4	124	1.49
5	80	1.86

Luminous flux luminaire 373 lm (EXTREME CUT OFF)

2700K

- 03.0717.40A
- 03.0717.14A

- 03.0717.40ANT
- 03.0717.14ANT

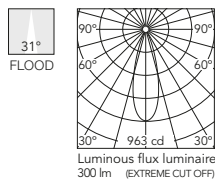

Beam Angle: 31°

h(m)	E(lx)	D(m)
1	963	0.55
2	241	1.10
3	107	1.65
4	60	2.20
5	39	2.75

Luminous flux luminaire 300 lm (EXTREME CUT OFF)

3000K

- 03.0716.40A
- 03.0716.14A

- 03.0716.40ANT
- 03.0716.14ANT

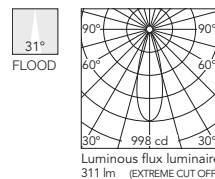

Beam Angle: 31°

h(m)	E(lx)	D(m)
1	998	0.55
2	249	1.10
3	111	1.65
4	62	2.20
5	40	2.75

Luminous flux luminaire 311 lm (EXTREME CUT OFF)

JOHNNY 80

Johnny 80 Semi-Recessed 1L Square

Light Source: Power LED

Without accessories: DC 500 mA - 6,2W - 560 lm - 2700K/CRI 90 / 6,2W - 600 lm - 3000K/CRI 90

With accessories: DC 450 mA - 5,5W - 505 lm - 2700K/CRI 90 / 5,5W - 540 lm - 3000K/CRI 90

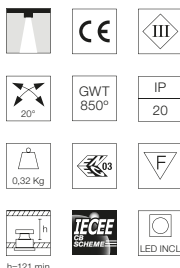
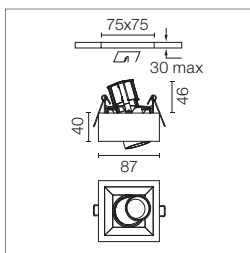

Apparecchio di illuminazione da semi-incasso a LED. Fonte di alimentazione esclusa.

Semi-recessed luminaire with LED light source. Power supply not included.

Accessori inclusi (honeycomb e filtro a croce antiabbagliamento).

Accessories included (honeycomb and screening crosspiece).

E= Finitura Esterna
I= Finitura Interna

E= External Finish
I= Internal Finish



Alimentazioni raccomandate / Recommended power supply*:

	450 mA	500 mA
Non Dimmable	60.9160	60.9160
Dimmable 1-10V	RF27961	RF27961
Dimmable Dali 1	RF26571	RF26571
Dimmable Dali 2	60.9222	60.9222
Mains Dimming	60.9467	60.9411
Casambi	60.9207	60.9207

* Vedi capitolo Drivers / Refer to the Drivers chapter

E	I	2700K
□	□	03.0761.40A
■	□	03.0761.CEA
■	■	03.0761.TKA
■	■	03.0761.14A

E	I	3000K
□	□	03.0719.40A
■	□	03.0719.CEA
■	■	03.0719.TKA
■	■	03.0719.14A

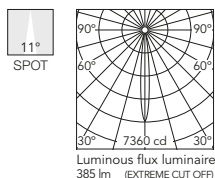

Beam Angle: 11°

h(m)	E(lx)	D(m)
1	7360	0.19
2	1840	0.38
3	818	0.57
4	460	0.76
5	294	0.95

E	I	3000K
□	□	03.0760.40A
■	□	03.0760.CEA
■	■	03.0760.TKA
■	■	03.0760.14A

E	I	2700K
□	□	03.0718.40A
■	□	03.0718.CEA
■	■	03.0718.TKA
■	■	03.0718.14A

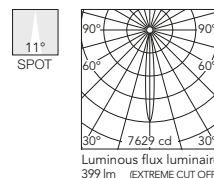

Beam Angle: 11°

h(m)	E(lx)	D(m)
1	7629	0.19
2	1907	0.38
3	848	0.57
4	477	0.76
5	305	0.95

E	I	2700K
□	□	03.0763.40A
■	□	03.0763.CEA
■	■	03.0763.TKA
■	■	03.0763.14A

E	I	3000K
□	□	03.0721.40A
■	□	03.0721.CEA
■	■	03.0721.TKA
■	■	03.0721.14A

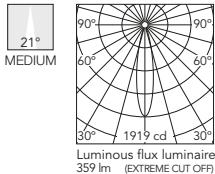

Beam Angle: 21°

h(m)	E(lx)	D(m)
1	1919	0.37
2	480	0.74
3	213	1.12
4	120	1.49
5	77	1.86

E	I	3000K
□	□	03.0762.40A
■	□	03.0762.CEA
■	■	03.0762.TKA
■	■	03.0762.14A

E	I	2700K
□	□	03.0720.40A
■	□	03.0720.CEA
■	■	03.0720.TKA
■	■	03.0720.14A

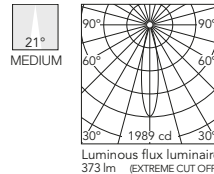

Beam Angle: 21°

h(m)	E(lx)	D(m)
1	1989	0.37
2	497	0.74
3	221	1.12
4	124	1.49
5	80	1.86

E	I	2700K
□	□	03.0765.40A
■	□	03.0765.CEA
■	■	03.0765.TKA
■	■	03.0765.14A

E	I	3000K
□	□	03.0723.40A
■	□	03.0723.CEA
■	■	03.0723.TKA
■	■	03.0723.14A

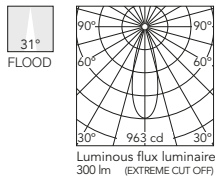

Beam Angle: 31°

h(m)	E(lx)	D(m)
1	963	0.55
2	241	1.10
3	107	1.65
4	60	2.20
5	39	2.75

E	I	3000K
□	□	03.0764.40A
■	□	03.0764.CEA
■	■	03.0764.TKA
■	■	03.0764.14A

E	I	2700K
□	□	03.0722.40A
■	□	03.0722.CEA
■	■	03.0722.TKA
■	■	03.0722.14A

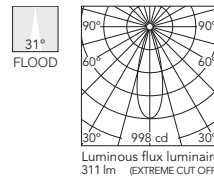

Beam Angle: 31°

h(m)	E(lx)	D(m)
1	998	0.55
2	249	1.10
3	111	1.65
4	62	2.20
5	40	2.75

JOHNNY 80

Johnny 80 Semi-Recessed 2L Square

Light Source: Power LED

Without accessories: 500 mA - 2x6,2W - 2x560 lm - 2700K/CRI 90 / 2x6,2W - 2x600 lm - 3000K/CRI 90

With accessories: DC 450 mA - 2x5,5W - 2x505 lm - 2700K/CRI 90 / 2x5,5W - 2x540 lm - 3000K/CRI 90

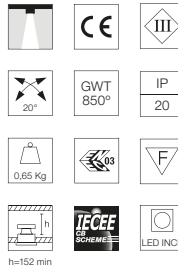
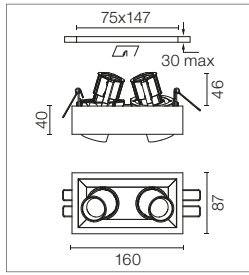

Apparecchio di illuminazione da semi-incasso a LED. Fonte di alimentazione esclusa. Si richiede una fonte di alimentazione per ogni corpo ottico.

Semi-recessed luminaire with LED light source. Power supply not included. Requires one power supply for each optic body.

Accessori inclusi (honeycomb e filtro a croce antiabbagliamento).

Accessories included (honeycomb and screening crosspiece).

E= Finitura Esterna
I= Finitura Interna

E= External Finish
I= Internal Finish



Alimentazioni raccomandate / Recommended power supply*:

	450 mA	500 mA
Non Dimmable	60.9160	60.9160
Dimmable 1-10V	RF27961	RF27961
Dimmable Dali 1	RF26571	RF26571
Dimmable Dali 2	60.9222	60.9222
Mains Dimming	60.9467	60.9411
Casambi	60.9207	60.9207

* Vedi capitolo Drivers / Refer to the Drivers chapter

E	I	2700K
□	□	03.0771.40A
■	□	03.0771.CEA
□	■	03.0771.TKA
■	■	03.0771.14A

E	I	3000K
□	□	03.0731.40A
■	□	03.0731.CEA
□	■	03.0731.TKA
■	■	03.0731.14A

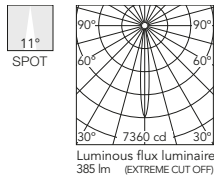

Beam Angle: 11°

h(m)	E(lx)	D(m)
1	7360	0.19
2	1840	0.38
3	818	0.57
4	460	0.76
5	294	0.95

E	I	3000K
□	□	03.0770.40A
■	□	03.0770.CEA
□	■	03.0770.TKA
■	■	03.0770.14A

E	I	2700K
□	□	03.0730.40A
■	□	03.0730.CEA
□	■	03.0730.TKA
■	■	03.0730.14A

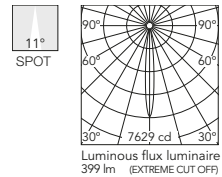

Beam Angle: 11°

h(m)	E(lx)	D(m)
1	7629	0.19
2	1907	0.38
3	848	0.57
4	477	0.76
5	305	0.95

E	I	2700K
□	□	03.0773.40A
■	□	03.0773.CEA
□	■	03.0773.TKA
■	■	03.0773.14A

E	I	3000K
□	□	03.0733.40A
■	□	03.0733.CEA
□	■	03.0733.TKA
■	■	03.0733.14A

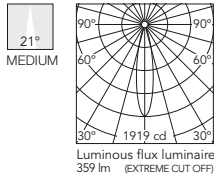

Beam Angle: 21°

h(m)	E(lx)	D(m)
1	1919	0.37
2	480	0.74
3	213	1.12
4	120	1.49
5	77	1.86

E	I	3000K
□	□	03.0772.40A
■	□	03.0772.CEA
□	■	03.0772.TKA
■	■	03.0772.14A

E	I	2700K
□	□	03.0732.40A
■	□	03.0732.CEA
□	■	03.0732.TKA
■	■	03.0732.14A

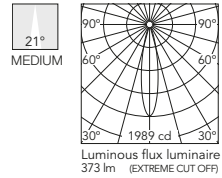

Beam Angle: 21°

h(m)	E(lx)	D(m)
1	1989	0.37
2	497	0.74
3	221	1.12
4	124	1.49
5	80	1.86

E	I	2700K
□	□	03.0775.40A
■	□	03.0775.CEA
□	■	03.0775.TKA
■	■	03.0775.14A

E	I	3000K
□	□	03.0735.40A
■	□	03.0735.CEA
□	■	03.0735.TKA
■	■	03.0735.14A

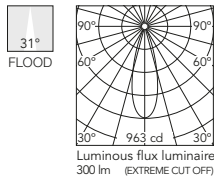

Beam Angle: 31°

h(m)	E(lx)	D(m)
1	963	0.55
2	241	1.10
3	107	1.65
4	60	2.20
5	39	2.75

E	I	3000K
□	□	03.0774.40A
■	□	03.0774.CEA
□	■	03.0774.TKA
■	■	03.0774.14A

E	I	2700K
□	□	03.0734.40A
■	□	03.0734.CEA
□	■	03.0734.TKA
■	■	03.0734.14A

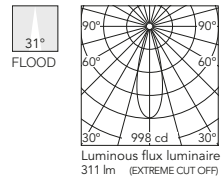

Beam Angle: 31°

h(m)	E(lx)	D(m)
1	998	0.55
2	249	1.10
3	111	1.65
4	62	2.20
5	40	2.75

JOHNNY 80

Accessori / Accessories

Johnny 80 No Trim 1L

Cornice di installazione No Trim.
Johnny ø80.



Johnny ø80 Round
 08.9102.00

Installation frame No Trim.
Johnny ø80.

Cornice di installazione No Trim.
Johnny □80.



Johnny □80 Square
 08.9103.00

Installation frame No Trim.
Johnny □80.

Johnny 80 No Trim 2L Square

Cornice di installazione No Trim.
Johnny 80 2L Square.



08.9105.00

Installation frame No Trim.
Johnny 80 2L Square.

JOHNNY 120

Johnny 120 Light Source

Light Source: LED Array / LED Array High Performance

Without accessories: DC 500 mA - 18W - 1770 lm - 2700K/CRI 90 / 18W - 1870 lm - 3000K/CRI 90

With accessories: DC 450 mA - 16W - 1612 lm - 2700K/CRI 90 / 16W - 1704 lm - 3000K/CRI 90

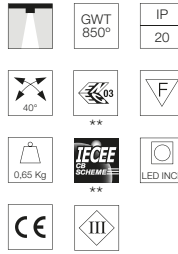
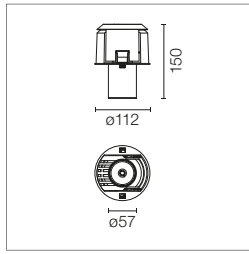

Apparecchio di illuminazione da incasso a LED. Fonte di alimentazione esclusa. È necessario una fonte di alimentazione per ogni sorgente luminosa.

Recessed luminaire with LED light source. Power supply not included. One driver is needed per each light source.

**Part number with certificate: 0741 / 0743 / 0745 / 0740 / 0742 / 0744

Alimentazioni raccomandate / Recommended power supply*:

Non Dimmable	60.9160
Dimmable 1-10V	RF27961
Dimmable Dali 1	RF26571
Dimmable Dali 2	60.9222
Mains Dimming	60.9467
Casambi	60.9207

* Vedi capitolo Drivers / Refer to the Drivers chapter

High Performance 2700K

03.0801.40
03.0801.14

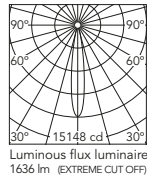

Beam Angle: 16°

h(m)	E(lx)	D(m)
1	15148	0.28
2	3787	0.56
3	1683	0.84
4	947	1.12
5	606	1.40

Luminous flux luminaire
15148 lm (EXTREME CUT OFF)

High Performance 3000K

03.0800.40
03.0800.14

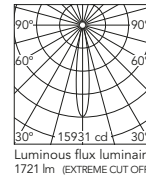

Beam Angle: 16°

h(m)	E(lx)	D(m)
1	15931	0.28
2	3983	0.56
3	1770	0.84
4	996	1.12
5	637	1.40

Luminous flux luminaire
17211 lm (EXTREME CUT OFF)

2700K

03.0741.40
03.0741.14

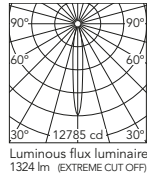

Beam Angle: 13°

h(m)	E(lx)	D(m)
1	12785	0.22
2	3196	0.44
3	1421	0.66
4	799	0.88
5	511	1.10

Luminous flux luminaire
1324 lm (EXTREME CUT OFF)

3000K

03.0740.40
03.0740.14

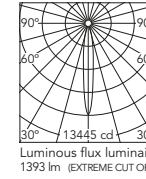

Beam Angle: 13°

h(m)	E(lx)	D(m)
1	13445	0.22
2	3361	0.44
3	1494	0.66
4	840	0.88
5	538	1.10

Luminous flux luminaire
1393 lm (EXTREME CUT OFF)

High Performance 2700K

03.0803.40
03.0803.14

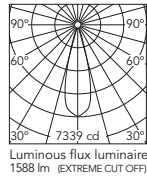

Beam Angle: 28°

h(m)	E(lx)	D(m)
1	7339	0.50
2	1835	1.00
3	815	1.50
4	459	2.00
5	294	2.50

Luminous flux luminaire
1588 lm (EXTREME CUT OFF)

High Performance 3000K

03.0802.40
03.0802.14

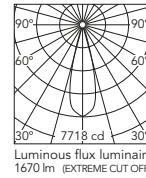

Beam Angle: 28°

h(m)	E(lx)	D(m)
1	7718	0.50
2	1930	1.00
3	858	1.50
4	482	2.00
5	309	2.50

Luminous flux luminaire
1670 lm (EXTREME CUT OFF)

2700K

03.0743.40
03.0743.14

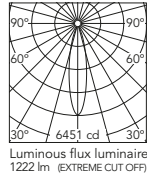

Beam Angle: 22°

h(m)	E(lx)	D(m)
1	6451	0.39
2	1613	0.79
3	717	1.18
4	403	1.58
5	258	1.97

Luminous flux luminaire
1222 lm (EXTREME CUT OFF)

3000K

03.0742.40
03.0742.14

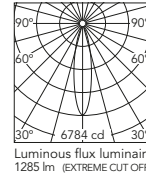

Beam Angle: 22°

h(m)	E(lx)	D(m)
1	6784	0.39
2	1696	0.79
3	754	1.18
4	424	1.58
5	271	1.97

Luminous flux luminaire
1285 lm (EXTREME CUT OFF)

High Performance 2700K

03.0805.40
03.0805.14

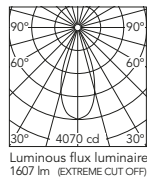

Beam Angle: 40°

h(m)	E(lx)	D(m)
1	4070	0.73
2	1017	1.46
3	452	2.18
4	254	2.91
5	163	3.64

Luminous flux luminaire
1607 lm (EXTREME CUT OFF)

High Performance 3000K

03.0804.40
03.0804.14

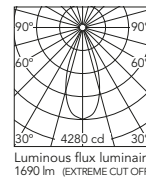

Beam Angle: 40°

h(m)	E(lx)	D(m)
1	4280	0.73
2	1070	1.46
3	476	2.18
4	268	2.91
5	171	3.64

Luminous flux luminaire
1690 lm (EXTREME CUT OFF)

2700K

03.0745.40
03.0745.14

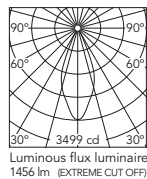

Beam Angle: 41°

h(m)	E(lx)	D(m)
1	3499	0.75
2	875	1.50
3	389	2.25
4	219	3.00
5	140	3.75

Luminous flux luminaire
1456 lm (EXTREME CUT OFF)

3000K

03.0744.40
03.0744.14

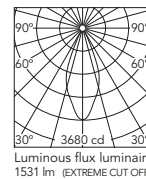

Beam Angle: 41°

h(m)	E(lx)	D(m)
1	3680	0.75
2	920	1.50
3	409	2.25
4	230	3.00
5	147	3.75

Luminous flux luminaire
1531 lm (EXTREME CUT OFF)

JOHNNY 120

Johnny 120 Round 1L – Recessed Universal Frame

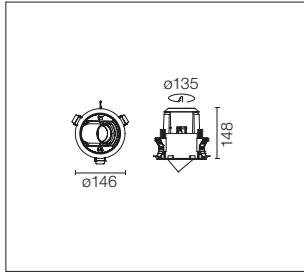

Codice unico per montaggio a incasso Trim o No Trim.
 08.0555.00=cornice bianca compresa per completare la finitura Trim.
 08.0505.00=cornici bianche e nere comprese come optional per completare la finitura Trim.

Unique reference for Trim or No Trim recessed installation.
 08.0555.00=includes white frame to complete Trim finishing.
 08.0505.00=includes optional white and black frames to complete Trim finishing.

- 08.0555.00
- + 1x Light Source
- + 1x Driver

- 08.0505.00
- + 1x Light Source
- + 1x Driver

Johnny 120 Square 1L – Recessed Universal Frame

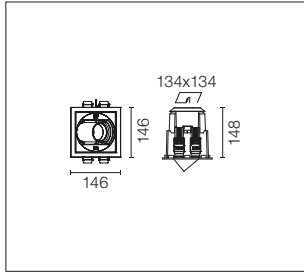
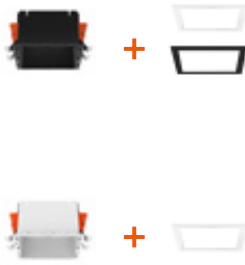

Codice unico per montaggio a incasso Trim o No Trim.
 08.0550.00=cornice bianca compresa per completare la finitura Trim.
 08.0500.00=cornici bianche e nere comprese come optional per completare la finitura Trim.

Unique reference for Trim or No Trim recessed installation.
 08.0550.00=includes white frame to complete Trim finishing.
 08.0500.00=includes optional white and black frames to complete Trim finishing.

- 08.0550.00
- + 1x Light Source
- + 1x Driver

- 08.0500.00
- + 1x Light Source
- + 1x Driver

Johnny 120 Square 2L – Recessed Universal Frame

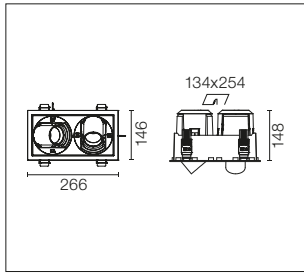
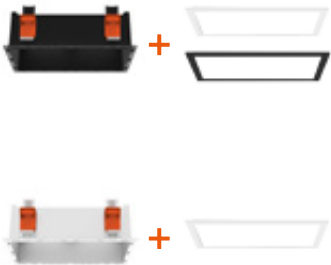

Codice unico per montaggio a incasso Trim o No Trim.
 08.0551.00=cornice bianca compresa per completare la finitura Trim.
 08.0501.00=cornici bianche e nere comprese come optional per completare la finitura Trim.

Unique reference for Trim or No Trim recessed installation.
 08.0551.00=includes white frame to complete Trim finishing.
 08.0501.00=includes optional white and black frames to complete Trim finishing.

- 08.0551.00
- + 2x Light Source
- + 2x Driver

- 08.0501.00
- + 2x Light Source
- + 2x Driver

Johnny 120 Semi-Recessed 1L Square – Housing

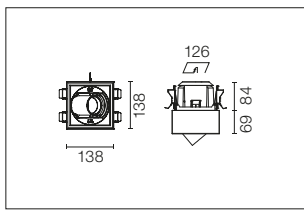

- | E | I | |
|-------------------------------------|-------------------------------------|------------|
| <input type="checkbox"/> | <input type="checkbox"/> | 08.0556.40 |
| <input type="checkbox"/> | <input checked="" type="checkbox"/> | 08.0556.CE |
| <input type="checkbox"/> | <input checked="" type="checkbox"/> | 08.0556.TK |
| <input checked="" type="checkbox"/> | <input checked="" type="checkbox"/> | 08.0556.14 |
- + 1x Light Source
 - + 1x Driver

- | E | I | |
|-------------------------------------|-------------------------------------|------------|
| <input type="checkbox"/> | <input type="checkbox"/> | 08.0506.40 |
| <input type="checkbox"/> | <input checked="" type="checkbox"/> | 08.0506.CE |
| <input type="checkbox"/> | <input checked="" type="checkbox"/> | 08.0506.TK |
| <input checked="" type="checkbox"/> | <input checked="" type="checkbox"/> | 08.0506.14 |
- + 1x Light Source
 - + 1x Driver

Johnny 120 Semi-Recessed 2L Square – Housing

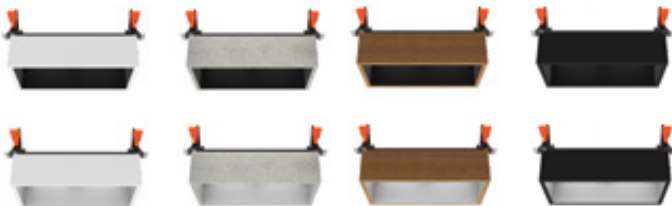

- | E | I | |
|-------------------------------------|-------------------------------------|------------|
| <input type="checkbox"/> | <input type="checkbox"/> | 08.0557.40 |
| <input type="checkbox"/> | <input checked="" type="checkbox"/> | 08.0557.CE |
| <input type="checkbox"/> | <input checked="" type="checkbox"/> | 08.0557.TK |
| <input checked="" type="checkbox"/> | <input checked="" type="checkbox"/> | 08.0557.14 |
- + 2x Light Source
 - + 2x Driver

- | E | I | |
|-------------------------------------|-------------------------------------|------------|
| <input type="checkbox"/> | <input type="checkbox"/> | 08.0507.40 |
| <input type="checkbox"/> | <input checked="" type="checkbox"/> | 08.0507.CE |
| <input type="checkbox"/> | <input checked="" type="checkbox"/> | 08.0507.TK |
| <input checked="" type="checkbox"/> | <input checked="" type="checkbox"/> | 08.0507.14 |
- + 2x Light Source
 - + 2x Driver

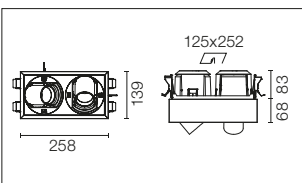

JOHNNY 120

Accessori / Accessories

Johnny 120

Filtro a croce antiabbagliamento
Screening crosspiece



08.8429.00

Lente ellittica
Elliptical lens



08.8431.00

Johnny 120

Lente flood
Flood lens



08.8432.00

Honeycomb
Honeycomb



08.8428.00

Cono di schermatura
Snoot shielding cone



08.0526.00

HOW TO ORDER JOHNNY 120

TRIM / NO TRIM 1L ROUND		TRIM / NO TRIM 1L SQUARE		TRIM / NO TRIM 2L SQUARE																																																													
<p>Universal frame</p> <p>08.0505.00 + 08.0555.00</p>		<p>Universal frame</p> <p>08.0500.00 + 08.0550.00</p>		<p>Universal frame</p> <p>08.0501.00 + 08.0551.00</p>																																																													
<p>1x Light Source*</p> <table border="1"> <thead> <tr> <th></th> <th>2700K</th> <th>3000K</th> <th>2700K High Perf.</th> <th>3000K High Perf.</th> </tr> </thead> <tbody> <tr> <td>Spot</td> <td>03.0741.40 03.0741.14</td> <td>03.0740.40 03.0740.14</td> <td>03.0801.40 03.0801.14</td> <td>03.0800.40 03.0800.14</td> </tr> <tr> <td>Medium</td> <td>03.0743.40 03.0743.14</td> <td>03.0742.40 03.0742.14</td> <td>03.0803.40 03.0803.14</td> <td>03.0802.40 03.0802.14</td> </tr> <tr> <td>Flood</td> <td>03.0745.40 03.0745.14</td> <td>03.0744.40 03.0744.14</td> <td>03.0805.40 03.0805.14</td> <td>03.0804.40 03.0804.14</td> </tr> </tbody> </table> <p>08.0505.00 + 08.0555.00</p>			2700K	3000K	2700K High Perf.	3000K High Perf.	Spot	03.0741.40 03.0741.14	03.0740.40 03.0740.14	03.0801.40 03.0801.14	03.0800.40 03.0800.14	Medium	03.0743.40 03.0743.14	03.0742.40 03.0742.14	03.0803.40 03.0803.14	03.0802.40 03.0802.14	Flood	03.0745.40 03.0745.14	03.0744.40 03.0744.14	03.0805.40 03.0805.14	03.0804.40 03.0804.14	<p>1x Light Source*</p> <table border="1"> <thead> <tr> <th></th> <th>2700K</th> <th>3000K</th> <th>2700K High Perf.</th> <th>3000K High Perf.</th> </tr> </thead> <tbody> <tr> <td>Spot</td> <td>03.0741.40 03.0741.14</td> <td>03.0740.40 03.0740.14</td> <td>03.0801.40 03.0801.14</td> <td>03.0800.40 03.0800.14</td> </tr> <tr> <td>Medium</td> <td>03.0743.40 03.0743.14</td> <td>03.0742.40 03.0742.14</td> <td>03.0803.40 03.0803.14</td> <td>03.0802.40 03.0802.14</td> </tr> <tr> <td>Flood</td> <td>03.0745.40 03.0745.14</td> <td>03.0744.40 03.0744.14</td> <td>03.0805.40 03.0805.14</td> <td>03.0804.40 03.0804.14</td> </tr> </tbody> </table> <p>08.0500.00 + 08.0550.00</p>			2700K	3000K	2700K High Perf.	3000K High Perf.	Spot	03.0741.40 03.0741.14	03.0740.40 03.0740.14	03.0801.40 03.0801.14	03.0800.40 03.0800.14	Medium	03.0743.40 03.0743.14	03.0742.40 03.0742.14	03.0803.40 03.0803.14	03.0802.40 03.0802.14	Flood	03.0745.40 03.0745.14	03.0744.40 03.0744.14	03.0805.40 03.0805.14	03.0804.40 03.0804.14	<p>2x Light Source*</p> <table border="1"> <thead> <tr> <th></th> <th>2700K</th> <th>3000K</th> <th>2700K High Perf.</th> <th>3000K High Perf.</th> </tr> </thead> <tbody> <tr> <td>Spot</td> <td>03.0741.40 03.0741.14</td> <td>03.0740.40 03.0740.14</td> <td>03.0801.40 03.0801.14</td> <td>03.0800.40 03.0800.14</td> </tr> <tr> <td>Medium</td> <td>03.0743.40 03.0743.14</td> <td>03.0742.40 03.0742.14</td> <td>03.0803.40 03.0803.14</td> <td>03.0802.40 03.0802.14</td> </tr> <tr> <td>Flood</td> <td>03.0745.40 03.0745.14</td> <td>03.0744.40 03.0744.14</td> <td>03.0805.40 03.0805.14</td> <td>03.0804.40 03.0804.14</td> </tr> </tbody> </table> <p>08.0501.00 + 08.0551.00</p>			2700K	3000K	2700K High Perf.	3000K High Perf.	Spot	03.0741.40 03.0741.14	03.0740.40 03.0740.14	03.0801.40 03.0801.14	03.0800.40 03.0800.14	Medium	03.0743.40 03.0743.14	03.0742.40 03.0742.14	03.0803.40 03.0803.14	03.0802.40 03.0802.14	Flood	03.0745.40 03.0745.14	03.0744.40 03.0744.14	03.0805.40 03.0805.14	03.0804.40 03.0804.14
	2700K	3000K	2700K High Perf.	3000K High Perf.																																																													
Spot	03.0741.40 03.0741.14	03.0740.40 03.0740.14	03.0801.40 03.0801.14	03.0800.40 03.0800.14																																																													
Medium	03.0743.40 03.0743.14	03.0742.40 03.0742.14	03.0803.40 03.0803.14	03.0802.40 03.0802.14																																																													
Flood	03.0745.40 03.0745.14	03.0744.40 03.0744.14	03.0805.40 03.0805.14	03.0804.40 03.0804.14																																																													
	2700K	3000K	2700K High Perf.	3000K High Perf.																																																													
Spot	03.0741.40 03.0741.14	03.0740.40 03.0740.14	03.0801.40 03.0801.14	03.0800.40 03.0800.14																																																													
Medium	03.0743.40 03.0743.14	03.0742.40 03.0742.14	03.0803.40 03.0803.14	03.0802.40 03.0802.14																																																													
Flood	03.0745.40 03.0745.14	03.0744.40 03.0744.14	03.0805.40 03.0805.14	03.0804.40 03.0804.14																																																													
	2700K	3000K	2700K High Perf.	3000K High Perf.																																																													
Spot	03.0741.40 03.0741.14	03.0740.40 03.0740.14	03.0801.40 03.0801.14	03.0800.40 03.0800.14																																																													
Medium	03.0743.40 03.0743.14	03.0742.40 03.0742.14	03.0803.40 03.0803.14	03.0802.40 03.0802.14																																																													
Flood	03.0745.40 03.0745.14	03.0744.40 03.0744.14	03.0805.40 03.0805.14	03.0804.40 03.0804.14																																																													
No Trim Trim White Trim Black		No Trim Trim White Trim Black		No Trim Trim White Trim Black																																																													

* Fonte di alimentazione esclusa. È necessario una fonte di alimentazione per ogni sorgente luminosa / Power supply not included. One driver is needed per each light source.

HOW TO ORDER JOHNNY 120

SEMI-RECESSED 1L SQUARE					SEMI-RECESSED 2L SQUARE				
Housing					Housing				
08.0506.40	08.0506.CE	08.0506.TK	08.0506.14		08.0507.40	08.0507.CE	08.0507.TK	08.0507.14	
08.0556.40	08.0556.CE	08.0556.TK	08.0556.14		08.0557.40	08.0557.CE	08.0557.TK	08.0557.14	
+					+				
1x Light Source*					2x Light Source*				
	2700K	3000K	2700K High Perf.	3000K High Perf.		2700K	3000K	2700K High Perf.	3000K High Perf.
Spot	03.0741.40	03.0740.40	03.0801.40	03.0800.40	Spot	03.0741.40	03.0740.40	03.0801.40	03.0800.40
	03.0741.14	03.0740.14	03.0801.14	03.0800.14		03.0741.14	03.0740.14	03.0801.14	03.0800.14
Medium	03.0743.40	03.0742.40	03.0803.40	03.0802.40	Medium	03.0743.40	03.0742.40	03.0803.40	03.0802.40
	03.0743.14	03.0742.14	03.0803.14	03.0802.14		03.0743.14	03.0742.14	03.0803.14	03.0802.14
Flood	03.0745.40	03.0744.40	03.0805.40	03.0804.40	Flood	03.0745.40	03.0744.40	03.0805.40	03.0804.40
	03.0745.14	03.0744.14	03.0805.14	03.0804.14		03.0745.14	03.0744.14	03.0805.14	03.0804.14
=					=				
White	Concrete	Teak	Black		White	Concrete	Teak	Black	

* Fonte di alimentazione esclusa. È necessario una fonte di alimentazione per ogni sorgente luminosa / Power supply not included. One driver is needed per each light source.

COMPASS BOX RECESSED

DESIGNED BY FLOS ARCHITECTURAL



SMALL 1L / 2L



LIGHT SOURCE
LED ARRAY
9,2W
945 lm
3000K/CRI 80

SMALL 1L / 2L



LIGHT SOURCE
LED
QR-CBC 51
GX5.3

LARGE 1L / 2L



LIGHT SOURCE
LED
QR-111
G53

30 Bianco Opaco/RAL 9001
30 Matt White



14 Nero Opaco/RAL 9005
14 Matt Black



Può essere orientato di 20°.
Can be swivelled 20°.

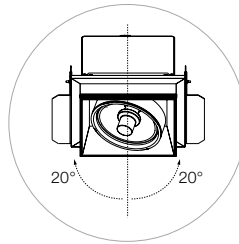

Descrizione

Sistema di 1 o 2 apparecchi orientabili, per incasso in controsoffitti con spessore da 1 a 30 mm. Progettato per lampade LED. Corpo da incasso in acciaio stampato e verniciato a polvere e cornice da incasso realizzata in estrusione di alluminio con sistema di fissaggio a controsoffitto. Sistema di orientamento "a compasso" realizzato in acciaio verniciato a polvere di colore nero opaco. Per le versioni LED retrofit: innovativo sistema di fissaggio mediante staffe in acciaio verniciato nero con bloccaggio a vite. Morsettiera delle connessioni elettriche posta al di sopra del box alloggiante le sorgenti luminose.

Riflettori

Riflettori in alluminio superpuro anodizzati color argento con finitura lucida.

Unità di Alimentazione

Precablaggio incluso; pronto per essere alimentato per mezzo di apparecchiature remote. Per le versioni LED retrofit:
- Trasformatore elettronico 20/105W, 220/240V, 50/60Hz, dimmerabile con dispositivo "leading and trailing edge".

Accessori

- Cilindro di schermatura con griglia direzionale incorporata finito con vernice a polvere nera.
- Honeycomb.
- Cornice necessaria per l'installazione in controsoffitto.

Informazioni Aggiuntive

Sistema di orientamento di tipo a compasso, che permette l'orientamento fino a 40° in tutte le direzioni. Grado di protezione: IP20. Classe di isolamento I, III, a seconda delle versioni.

Conformità e Marchi di Qualità

Apparecchio conforme alla Normativa Tecnica Europea EN60598-1 e relative parti seconde.

Description

1 or 2 lamp adjustable- system, for recessed ceiling thicknesses of 1-30 mm. Suitable for LED light sources. Pressed steel powder-coated recessed housing, extruded aluminum recessed trim frame for use with false ceiling systems. Steel "compass-type" adjustment mechanism, powder-coated matt black. For LED retrofit versions: innovative steel bracket fixing system, painted black, with allen key locking mechanism. Terminal block positioned on canopy housing box.

Reflectors

Super-pure, anodised-aluminum, silver reflectors with polished specular finish. Black thermoplastic protective ring for high luminance lamps.

Power Supply

Pre-wiring included; ready for remote power supply. For LED retrofit versions:
- Electronic transformer 20/105W, 220/240V, 50/60Hz suitable for dimming when used with trailing edge dimmers.

Accessories

- Screening cylinder with cross baffle element incorporated, black powder-coated finish.
- Honeycomb.
- Frame needed for installation on false ceiling.

Additional Information

Compass-type adjustment system permits focusing from 0° to 40° in all directions. IP20 protection grade. Insulation class I, III depending on the versions.

Standard Compliance and Quality Marks

EN60598-1 European Technical Standards and any subsequent additions.

COMPASS BOX RECESSED

Compass Box Recessed Small 1L

Light Source: LED Array DC 500 mA - 9,2W - 945 lm - 3000K/CRI 80

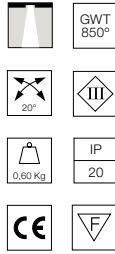
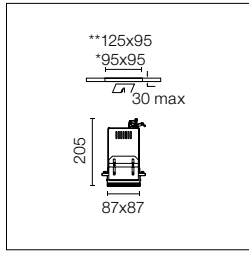

Apparecchio di illuminazione No Trim da incasso a LED. Fonte di alimentazione esclusa.

No Trim recessed luminaire with LED light source. Power supply not included.

Cornice di pre-installazione da ordinare separatamente.

Pre-installation frame must be ordered separately.

Alimentazioni raccomandate / Recommended power supply*:

Non Dimmable	60.9160
Dimmable 1-10V	RF27961
Dimmable Dali	RF26571
Dimmable Dali 2	60.9222
Mains Dimming	60.9411
Casambi	60.9207

Pre-installation frame must be ordered separately.

Alimentazioni raccomandate / Recommended power supply*:

60.9160
RF27961
RF26571
60.9222
60.9411
60.9207

* Vedi capitolo Drivers / Refer to the Drivers chapter

* Soffitto accessibile: modulare/aperto. | Accessible ceiling: modular/open.
**Soffitto non accessibile. | Inaccessible ceiling.

03.2675.30A
03.2675.14A

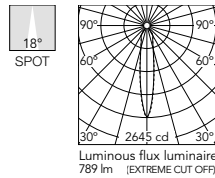

03.2677.30A
03.2677.14A

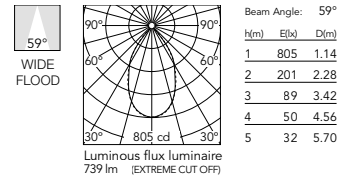

03.2676.30A
03.2676.14A

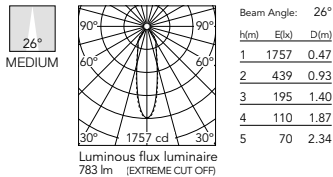

Compass Box Recessed Small 2L

Light Source: LED Array DC 500 mA - 2x9,2W - 2x945 lm - 3000K/CRI 80

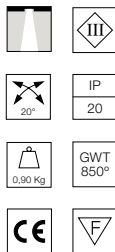
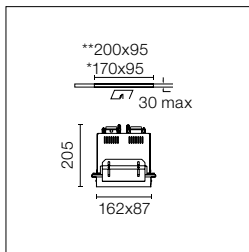

Apparecchio di illuminazione No Trim da incasso a LED. Fonte di alimentazione esclusa. Si richiede una fonte di alimentazione per ogni corpo ottico.

No Trim recessed luminaire with LED light source. Power supply not included. Requires one power supply for each optic body.

Cornice di pre-installazione da ordinare separatamente.

Pre-installation frame must be ordered separately.

Alimentazioni raccomandate / Recommended power supply*:

Non Dimmable	60.9160
Dimmable 1-10V	RF27961
Dimmable Dali	RF26571
Dimmable Dali 2	60.9222
Mains Dimming	60.9411
Casambi	60.9207

Alimentazioni raccomandate / Recommended power supply*:

60.9160
RF27961
RF26571
60.9222
60.9411
60.9207

* Vedi capitolo Drivers / Refer to the Drivers chapter

* Soffitto accessibile: modulare/aperto. | Accessible ceiling: modular/open.
**Soffitto non accessibile. | Inaccessible ceiling.

03.2680.30A
03.2680.14A

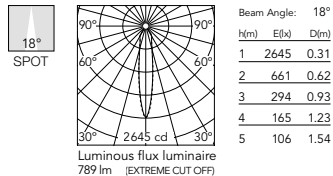

03.2682.30A
03.2682.14A

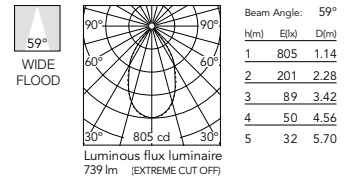

03.2681.30A
03.2681.14A

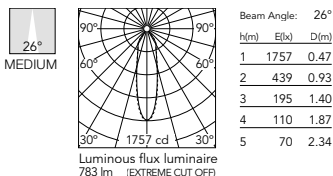

COMPASS BOX RECESSED

Compass Box Recessed Small 1L

Light Source: LED QR-CBC 51 GX5.3

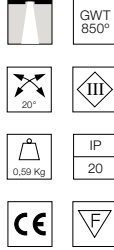
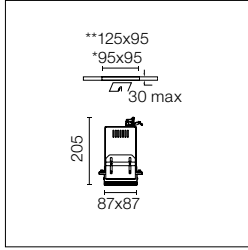

Apparecchio di illuminazione da incasso No Trim per lampada LED Retrofit 12V. Trasformatore remoto non incluso.

No Trim recessed luminaire for 12V LED Retrofit lamp. Remote transformer not included.

Cornice di pre-installazione da ordinare separatamente.

Pre-installation frame must be ordered separately.

03.2650.30
03.2650.14

* Soffitto accessibile: modulare/aperto. | Accessible ceiling: modular/open.
**Soffitto non accessibile. | Inaccessible ceiling.

Compass Box Recessed Small 2L

Light Source: LED QR-CBC 51 GX5.3

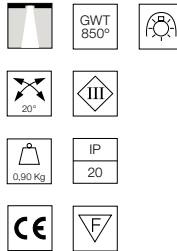
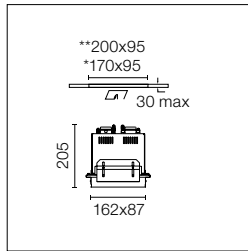

Apparecchio di illuminazione da incasso No Trim per lampada LED Retrofit 12V. Trasformatore remoto non incluso.

No Trim recessed luminaire for 12V LED Retrofit lamp. Remote transformer not included.

Cornice di pre-installazione da ordinare separatamente.

Pre-installation frame must be ordered separately.

03.2651.30
03.2651.14

* Soffitto accessibile: modulare/aperto. | Accessible ceiling: modular/open.
**Soffitto non accessibile. | Inaccessible ceiling.

Compass Box Recessed Large 1L

Light Source: LED QR-111 G53

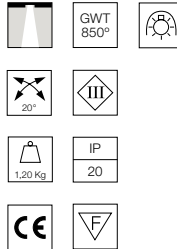
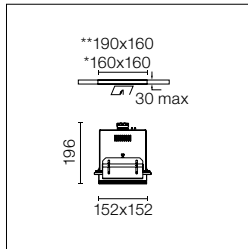

Apparecchio di illuminazione da incasso No Trim per lampada LED Retrofit 12V. Trasformatore remoto non incluso.

No Trim recessed luminaire for 12V LED Retrofit lamp. Remote transformer not included.

Cornice di pre-installazione da ordinare separatamente.

Pre-installation frame must be ordered separately.

03.2520.30
03.2520.14

* Soffitto accessibile: modulare/aperto. | Accessible ceiling: modular/open.
**Soffitto non accessibile. | Inaccessible ceiling.

Compass Box Recessed Large 2L

Light Source: LED QR-111 G53

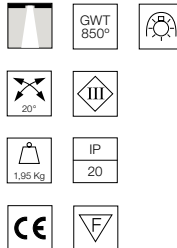
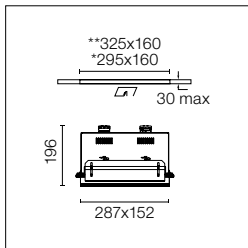

Apparecchio di illuminazione da incasso No Trim per lampada LED Retrofit 12V. Trasformatore remoto non incluso.

No Trim recessed luminaire for 12V LED Retrofit lamp. Remote transformer not included.

Cornice di pre-installazione da ordinare separatamente.

Pre-installation frame must be ordered separately.

03.2521.30
03.2521.14

* Soffitto accessibile: modulare/aperto. | Accessible ceiling: modular/open.
**Soffitto non accessibile. | Inaccessible ceiling.

COMPASS BOX RECESSED

Accessori / Accessories

Compass Box Recessed No Trim Small

Cornice di pre-installazione
piccola 1 lampadina.



08.8191.00

Pre-installation frame small
single light.

Cornice di pre-installazione
piccola 2 lampadine.



08.8192.00

Pre-installation frame small 2
lights.

Compass Box Recessed Small

Filtro a croce
antiabbagliamento.



08.8238.14

Screening crosspiece.

Honeycomb
Honeycomb



08.8196.14

Compass Box Recessed No Trim Large

Cornice di pre-installazione
grande 1 lampadina.



08.8187.00

Pre-installation frame large
single light.

Cornice di preinstallazione
grande 2 lampadine.



08.8188.00

Pre-installation frame 2 large
lights.

Compass Box Recessed Large

Filtro a croce
antiabbagliamento.



08.8034.14

Screening crosspiece.

Honeycomb
Honeycomb



08.8036.14

BATTERY

DESIGNED BY F.A. PORSCHE

TRIM / NO TRIM SMALL
1L / 2L / 3L / 4L SQUARE



LIGHT SOURCE
LED ARRAY
16,5W
2290 lm
3000K/CRI 80

TRIM / NO TRIM SMALL
1L / 2L



LIGHT SOURCE
LED
QR-CBC 51
GX5.3

TRIM / NO TRIM LARGE
1L / 2L



LIGHT SOURCE
LED
QR-111
G53

□ 20 Bianco Opaco/RAL 9016
20 Matt White

■ 08 Mercurio/RAL 9007
08 Mercury

■ 14 Nero Opaco/RAL 9005
14 Matt Black

Battery Trim



Battery No Trim

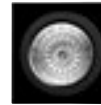
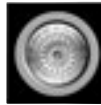

Può essere ruotato di 40° in qualsiasi senso.
Can be rotated 40° in any direction.

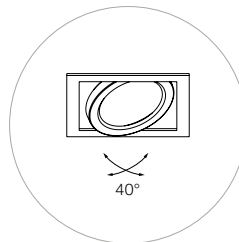

BATTERY

Descrizione

Sistema di 1, 2, 3 o 4 apparecchi orientabili, per incasso in controsoffitti con spessore da 1 a 30 mm. Progettato per lampade LED o a bassissima tensione.

Corpo da incasso in acciaio stampato e verniciato a polvere di colore nero opaco e cornice da incasso realizzata in estrusione di alluminio con sistema di fissaggio a controsoffitto. (Battery No Trim).

Sistema di orientamento "a compasso" realizzato in acciaio verniciato a polvere di colore nero opaco. Sistema di fissaggio mediante staffe in acciaio verniciato nero con bloccaggio a vite. Anelli zigrinati in alluminio presso fuso alloggiati in una cornice di acciaio di 3 mm. Morsettiera delle connessioni elettriche posta al di sopra del box alloggiante le sorgenti luminose.

Per le versioni LED retrofit: anello interno addizionale in PPS ad alta resistenza, per fissaggio lampadina e antiabbagliamento.

Riflettori

Riflettori in alluminio superpuro anodizzati color argento con finitura lucida.

Unità di Alimentazione

Precablaggio incluso; pronto per essere alimentato per mezzo di apparecchiature remote.

Per le versioni LED retrofit:

- Trasformatore elettronico 20/105W, 220/240V, 50/60Hz, dimmerabile con dispositivo "leading and trailing edge".

Accessori

- Cilindro di schermatura con griglia direzionale incorporata finito con vernice a polvere nera.
- Honeycomb.
- Lente di distribuzione ellittica in vetro temprato di 4 mm.
- Filtri cromatici.
- Cornice necessaria per l'installazione in controsoffitto (Battery No Trim).

Informazioni Aggiuntive

Sistema di orientamento di tipo a compasso, che permette l'orientamento fino a 40° in tutte le direzioni.

Grado di protezione IP20, IP23, a seconda delle versioni.

Classe di isolamento I, III, a seconda delle versioni.

Conformità e Marchi di Qualità

Apparecchio conforme alla Normativa Tecnica Europea EN60598-1 e relative parti seconde.

Description

1, 2, 3 or 4 lamp adjustable- system, for recessed ceiling thicknesses of 1-30 mm. Suitable for use with LED lamps or very low voltage lamps.

Pressed steel and matt black, powder-coated recessed housing, extruded aluminum recessed trim frame for use with false ceiling systems. (Battery No Trim).

Steel "compass-type" adjustment mechanism, powder-coated matt black. Innovative steel bracket fixing system, painted black, with allen key locking mechanism. Die-cast aluminum knurled rings housed in a 3 mm steel frame. Terminal block positioned on canopy housing box.

For LED retrofit versions: additional high-resistance PPS inner ring, for mounting lamp and anti-glare functions.

Reflectors

Super-pure, anodised-aluminum, silver reflectors with polished specular finish. Black thermoplastic protective ring for high luminance lamps.

Power Supply

Pre-wiring included; ready for remote power supply.

For LED retrofit versions:

- Electronic transformer 20/105W, 220/240V, 50/60Hz suitable for dimming when used with trailing edge dimmers.

Accessories

- Screening cylinder with cross baffle element incorporated, black powder-coated finish.
- Honeycomb.
- 4 mm tempered glass elliptical distribution lens.
- Chromatic filters.
- Frame needed for installation on false ceiling (Battery No Trim).

Additional Information

Compass-type adjustment system permits focusing from 0° to 40° in all directions.

IP20, IP23 protection grade depending on the versions.

Insulation class I, III depending on the versions.

Standard Compliance and Quality Marks

EN60598-1 European Technical Standards and any subsequent additions.



Trim



No Trim

BATTERY

Battery Trim Small 1L

Light Source: LED Array DC 500 mA - 16,5W - 2290 lm - 3000K/CRI 80

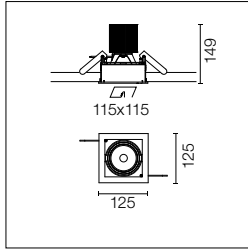

Apparecchio di illuminazione da incasso a LED. Fonte di alimentazione esclusa.

Recessed luminaire with LED light source. Power supply not included.

Battery No Trim Small 1L

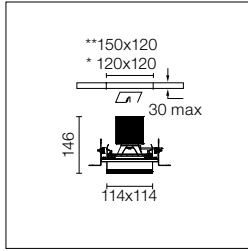
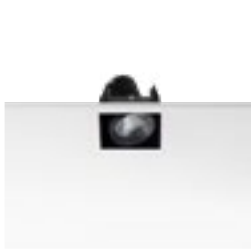

Cornice di pre-installazione da ordinare separatamente.

Pre-installation frame must be ordered separately.

Alimentazioni raccomandate / Recommended power supply*:

Non Dimmable	60.9160
Dimmable 1-10V	RF27961
Dimmable Dali 1	RF26571
Dimmable Dali 2	60.9222
Mains Dimming	60.9467
Casambi	60.9207

* Vedi capitolo Drivers / Refer to the Drivers chapter

* Soffitto accessibile: modulare/aperto. | Accessible ceiling: modular/open.
**Soffitto non accessibile. | Inaccessible ceiling.

- 04.6470.20B
- 04.6470.08B
- 04.6470.14B
- 04.6470.14BNT

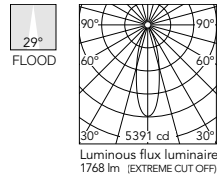

- 04.6471.20B
- 04.6471.08B
- 04.6471.14B
- 04.6471.14BNT

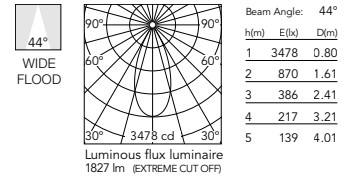

Battery Trim Small 2L

Light Source: LED Array DC 500 mA - 2x16,5W - 2x2290 lm - 3000K/CRI 80

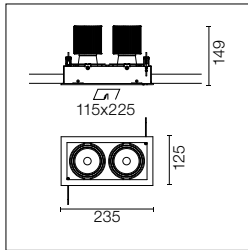

Apparecchio di illuminazione da incasso a LED. Fonte di alimentazione esclusa. E' una fonte di alimentazione per ogni corpo ottico.

Recessed luminaire with LED light source. Power supply not included. Requires one power supply for each optic body.

Battery No Trim Small 2L

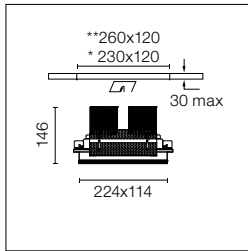

Cornice di pre-installazione da ordinare separatamente.

Pre-installation frame must be ordered separately.

Alimentazioni raccomandate / Recommended power supply*:

Non Dimmable	60.9160
Dimmable 1-10V	RF27961
Dimmable Dali 1	RF26571
Dimmable Dali 2	60.9222
Mains Dimming	60.9467
Casambi	60.9207

* Vedi capitolo Drivers / Refer to the Drivers chapter

* Soffitto accessibile: modulare/aperto. | Accessible ceiling: modular/open.
**Soffitto non accessibile. | Inaccessible ceiling.

- 04.6475.20B
- 04.6475.08B
- 04.6475.14B
- 04.6475.14BNT

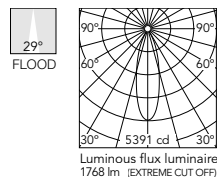

- 04.6476.20B
- 04.6476.08B
- 04.6476.14B
- 04.6476.14BNT

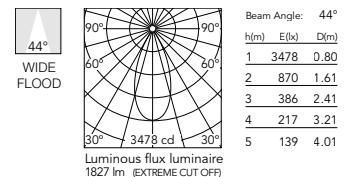

BATTERY

Battery Trim Small 3L

Light Source: LED Array DC 500 mA - 3x16,5W - 3x2290 lm - 3000K/CRI 80

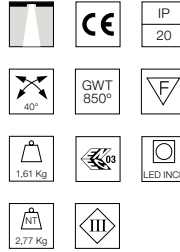
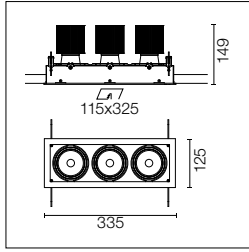

Apparecchio di illuminazione da incasso a LED. Fonte di alimentazione esclusa. E' una fonte di alimentazione per ogni corpo ottico.

Recessed luminaire with LED light source. Power supply not included. Requires one power supply for each optical body.

Battery No Trim Small 3L

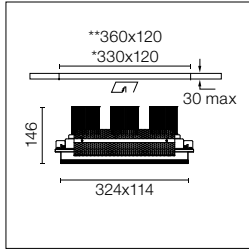

Cornice di pre-installazione da ordinare separatamente.

Pre-installation frame must be ordered separately.

Alimentazioni raccomandate / Recommended power supply*:

Non Dimmable	60.9160
Dimmable 1-10V	RF27961
Dimmable Dali 1	RF26571
Dimmable Dali 2	60.9222
Mains Dimming	60.9467
Casambi	60.9207

* Vedi capitolo Drivers / Refer to the Drivers chapter

* Soffitto accessibile: modulare/aperto. | Accessible ceiling: modular/open.
**Soffitto non accessibile. | Inaccessible ceiling.

- 04.6480.20B
- 04.6480.08B
- 04.6480.14B
- 04.6480.14BNT

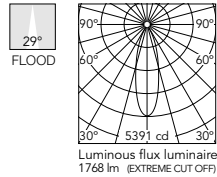

- 04.6481.20B
- 04.6481.08B
- 04.6481.14B
- 04.6481.14BNT

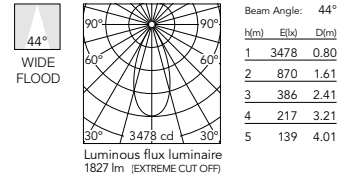

Battery Trim Small 4L Square

Light Source: LED Array DC 500 mA - 4x16,5W - 4x2290 lm - 3000K/CRI 80

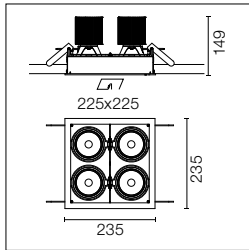

Apparecchio di illuminazione da incasso a LED. Fonte di alimentazione esclusa. E' una fonte di alimentazione per ogni corpo ottico.

Recessed luminaire with LED light source. Power supply not included. Requires one power supply for each optical body.

Battery No Trim Small 4L Square

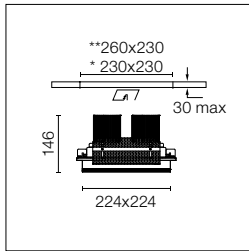

Cornice di pre-installazione da ordinare separatamente.

Pre-installation frame must be ordered separately.

Alimentazioni raccomandate / Recommended power supply*:

Non Dimmable	60.9160
Dimmable 1-10V	RF27961
Dimmable Dali 1	RF26571
Dimmable Dali 2	60.9222
Mains Dimming	60.9467
Casambi	60.9207

* Vedi capitolo Drivers / Refer to the Drivers chapter

* Soffitto accessibile: modulare/aperto. | Accessible ceiling: modular/open.
**Soffitto non accessibile. | Inaccessible ceiling.

- 04.6485.20B
- 04.6485.08B
- 04.6485.14B
- 04.6485.14BNT

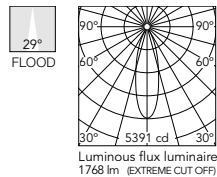

- 04.6486.20B
- 04.6486.08B
- 04.6486.14B
- 04.6486.14BNT

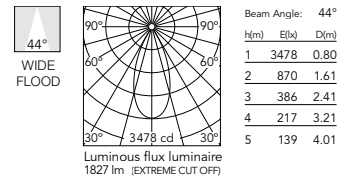

BATTERY

Battery Trim Small 1L

Light Source: LED QR-CBC 51 GX5.3

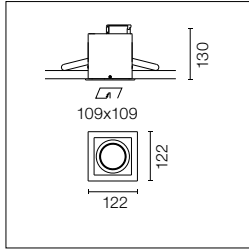

Apparecchio da incasso per lampada LED Retrofit 12V. Trasformatore remoto non incluso.

Recessed luminaire for 12V LED Retrofit lamp. Remote transformer not included.

Anello interno aggiuntivo in plastica (PPS) ad alta resistenza.

Additional inner plastic (PPS) ring for lamp approaching & low glare effect.

Battery No Trim Small 1L

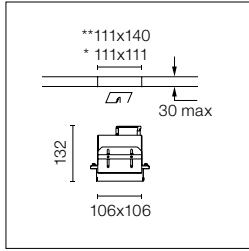

Cornice di pre-installazione da ordinare separatamente.

Pre-installation frame must be ordered separately.

- 04.6021.20
- 04.6021.08
- 04.6021.14

- 04.6021.20.NT
- 04.6021.08.NT
- 04.6021.14.NT

* Soffitto accessibile: modulare/aperto. | Accessible ceiling: modular/open.
**Soffitto non accessibile. | Inaccessible ceiling.

Battery Trim Small 2L

Light Source: LED QR-CBC 51 GX5.3

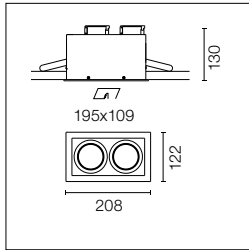

Apparecchio da incasso per lampada LED Retrofit 12V. Trasformatore remoto non incluso.

Recessed luminaire for 12V LED Retrofit lamp. Remote transformer not included.

Anello interno aggiuntivo in plastica (PPS) ad alta resistenza.

Additional inner plastic (PPS) ring for lamp approaching & low glare effect.

Battery No Trim Small 2L

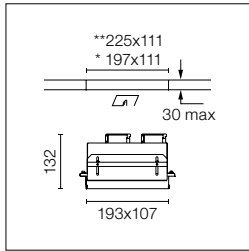

Cornice di pre-installazione da ordinare separatamente.

Pre-installation frame must be ordered separately.

- 04.6022.20
- 04.6022.08
- 04.6022.14

- 04.6022.20.NT
- 04.6022.08.NT
- 04.6022.14.NT

* Soffitto accessibile: modulare/aperto. | Accessible ceiling: modular/open.
**Soffitto non accessibile. | Inaccessible ceiling.

BATTERY

Battery Trim Large 1L

Light Source: LED QR-111 G53

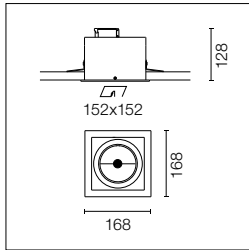

Apparecchio da incasso per lampada LED Retrofit 12V. Trasformatore remoto non incluso.

Recessed luminaire for 12V LED Retrofit lamp. Remote transformer not included.

Battery No Trim Large 1L

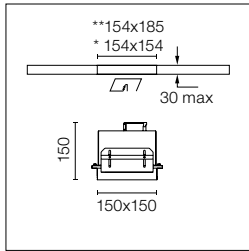

Cornice di pre-installazione da ordinare separatamente.

Pre-installation frame must be ordered separately.

04.6001.20
 04.6001.08
 04.6001.14

04.6001.20.NT
 04.6001.08.NT
 04.6001.14.NT

* Soffitto accessibile: modulare/aperto. | Accessible ceiling: modular/open.
 **Soffitto non accessibile. | Inaccessible ceiling.

Battery Trim Large 2L

Light Source: LED QR-111 G53

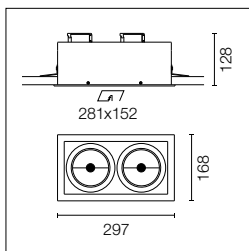

Apparecchio da incasso per lampada LED Retrofit 12V. Trasformatore remoto non incluso.

Recessed luminaire for 12V LED Retrofit lamp. Remote transformer not included.

Battery No Trim Large 2L

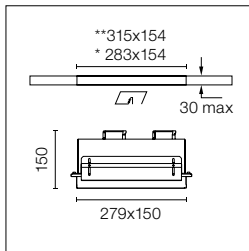

Cornice di pre-installazione da ordinare separatamente.

Pre-installation frame must be ordered separately.

04.6002.20
 04.6002.08
 04.6002.14

04.6002.20.NT
 04.6002.08.NT
 04.6002.14.NT

* Soffitto accessibile: modulare/aperto. | Accessible ceiling: modular/open.
 **Soffitto non accessibile. | Inaccessible ceiling.

BATTERY

Accessori / Accessories

Battery No Trim: LED Array

Cornice di pre-installazione piccola 1 lampadina.	Pre-installation frame small single light.		08.8523.00
---	--	---	------------

Cornice di pre-installazione piccola 2 lampadine.	Pre-installation frame small 2 lights.		08.8524.00
---	--	---	------------

Cornice di pre-installazione piccola 3 lampadine.	Pre-installation frame small 3 lights.		08.8525.00
---	--	---	------------

Cornice di pre-installazione piccola 4 lampadine.	Pre-installation frame small 4 lights.		08.8526.00
---	--	---	------------

Battery No Trim: QR-CBC 51

Cornice di pre-installazione piccola 1 lampadina.	Pre-installation frame small single light.		08.8080.00
---	--	---	------------

Cornice di pre-installazione piccola 2 lampadine.	Pre-installation frame small 2 lights.		08.8081.00
---	--	--	------------

Battery No Trim: QR-111









Cornice di pre-installazione grande 1 lampadina.	Pre-installation frame large single light.		08.8084.00
--	--	---	------------

Cornice di pre-installazione grande 2 lampadine.	Pre-installation frame large 2 lights.		08.8085.00
--	--	---	------------

BATTERY

Accessori / Accessories

Battery Trim / No Trim: LED Array

Honeycomb Honeycomb		08.8495.14
Filtro blu Blue filter		08.8503.64.OD
Filtro azzurro Sky blue filter		08.8503.65.OD
Filtro ambr Amber filter		08.8503.66.OD
Filtro rosso Red filter		08.8503.67.OD
Hot light Hot light		08.8503.69
Cold light Cold light		08.8503.CL
Daylight Daylight		08.8503.DL
Neodimium Neodimium		08.8503.ND

Battery Trim / No Trim: QR-111

Lente ellittica Elliptical lens		<input type="checkbox"/> 08.8025.20 <input type="checkbox"/> 08.8025.08 <input type="checkbox"/> 08.8025.14
Cilindro di schermatura Screening cylinder		<input type="checkbox"/> 08.8030.20 <input type="checkbox"/> 08.8030.08 <input type="checkbox"/> 08.8030.14
Honeycomb Honeycomb		<input type="checkbox"/> 08.8029.20 <input type="checkbox"/> 08.8029.08 <input type="checkbox"/> 08.8029.14
Lente flood Flood lens		<input type="checkbox"/> 08.8180.20 <input type="checkbox"/> 08.8180.08 <input type="checkbox"/> 08.8180.14
Filtro blu Blue filter		<input type="checkbox"/> 08.8027.20.AO <input type="checkbox"/> 08.8027.08.AO <input type="checkbox"/> 08.8027.14.AO
Filtro azzurro Sky blue filter		<input type="checkbox"/> 08.8027.20.AC <input type="checkbox"/> 08.8027.08.AC <input type="checkbox"/> 08.8027.14.AC
Filtro ambr Amber filter		<input type="checkbox"/> 08.8027.20.AM <input type="checkbox"/> 08.8027.08.AM <input type="checkbox"/> 08.8027.14.AM
Filtro rosso Red filter		<input type="checkbox"/> 08.8027.20.RO <input type="checkbox"/> 08.8027.08.RO <input type="checkbox"/> 08.8027.14.RO
Filtro anti U.V. U.V. filter		<input type="checkbox"/> 08.8027.20.UV <input type="checkbox"/> 08.8027.08.UV <input type="checkbox"/> 08.8027.14.UV
Filtro anti I.R. I.R. filter		<input type="checkbox"/> 08.8027.20.IR <input type="checkbox"/> 08.8027.08.IR <input type="checkbox"/> 08.8027.14.IR
Hot light Hot light		<input type="checkbox"/> 08.8027.20.HL <input type="checkbox"/> 08.8027.08.HL <input type="checkbox"/> 08.8027.14.HL
Cold light Cold light		<input type="checkbox"/> 08.8027.20.CL <input type="checkbox"/> 08.8027.08.CL <input type="checkbox"/> 08.8027.14.CL
Daylight Daylight		<input type="checkbox"/> 08.8027.20.DL <input type="checkbox"/> 08.8027.08.DL <input type="checkbox"/> 08.8027.14.DL
Neodimium Neodimium		<input type="checkbox"/> 08.8027.20.ND <input type="checkbox"/> 08.8027.08.ND <input type="checkbox"/> 08.8027.14.ND

MICRO BATTERY

DESIGNED BY F.A. PORSCHE



OPAL			FIXED	ADJUSTABLE	
LIGHT SOURCE LED ARRAY 9,2W 1060 lm 3000K/CRI 90	LIGHT SOURCE LED PAR 16 GZ10	LIGHT SOURCE LED QR-CBC 51 GX5.3	LIGHT SOURCE LED ARRAY 9,2W 1060 lm 3000K/CRI 90	LIGHT SOURCE LED PAR 16 GZ10	LIGHT SOURCE LED QR-CBC 51 GX5.3

20 Bianco Opaco/RAL 9016
20 Matt White

08 Mercurio/RAL 9007
08 Mercury

14 Nero Opaco/RAL 9005
14 Matt Black



Le versione adjustable possono essere orientate di 40° in qualunque senso.
Adjustable versions can be swivelled 40° in any direction.

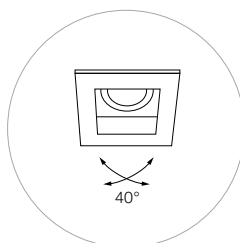

Descrizione

Apparecchio da incasso per installazioni in interni in versione orientabile o fissa. Progettato per lampade LED, a bassissima tensione o a tensione di rete o ad alogenuri metallici. Corpo inclinabile di supporto alla lampada in alluminio pressofuso finito con vernice a polvere nera. Anello di chiusura in alluminio pressofuso finito con vernice a polvere nera. Molla di fissaggio della lampada in acciaio inossidabile. Corpo da incasso per schermatura della lampada in acciaio e finito con vernice nera a polvere. Cornice esterna in alluminio verniciato. Sistema di fissaggio previsto per controsoffitti fino a 30 mm di spessore con staffe in acciaio inossidabile dotate di viti di sicurezza.

Riflettori

L'apparecchio è progettato per sole sorgenti luminose dotate di riflettore.

Unità di Alimentazione

Trasformatore elettronico di ultima generazione escluso. Trasformatore elettronico 20/105W, 220/240V, 50/60Hz, dimmerabile con dispositivo "leading and trailing edge".

Accessori

Cilindro antiabbagliamento. Cut-off 40°. Non compatibili con versioni LED.

Informazioni Aggiuntive

Sistema di orientamento di tipo a compasso, che permette l'orientamento fino a 40° in tutte le direzioni. Grado di protezione: IP44 in soffitti non accessibili, per apparecchi con vetro di protezione; IP23 in soffitti non accessibili, per apparecchi senza vetro di protezione. Classe di isolamento II, III, a seconda delle versioni. Adatti ad installazioni su superfici normalmente infiammabili.

Conformità e Marchi di Qualità

Apparecchio conforme alla Normativa Tecnica Europea EN60598-1 e relative parti seconde.

Description

Recessed indoor luminaire, adjustable or fixed. Suitable for use with LED lamps, very low voltage or direct mains power or metal halide lamps. Die-cast aluminum adjustable lamp-support with black powder-coated finish. Die-cast aluminum, black powder-coated closing ring. Stainless steel lamp fixing spring. Recessed steel body for reducing lamp visibility with black powder-coated finish. Painted aluminum outer frame. Fixing system for ceiling thicknesses 0-30 mm. with steel sprung brackets.

Reflectors

The luminaire is designed for reflector lamps only.

Power Supply

Next-generation electronic transformer not included. 20/105W, 220/240V, 50/60Hz electronic transformer suitable for dimming when used with trailing edge dimmers.

Accessories

Anti-glare cylinder. Cut-off 40°. Not compatible with LED versions.

Additional Information

Compass-type adjustment system permits focusing from 0° to 40° in all directions. IP44 protection grade in non-accessible ceilings, for luminaires with glass cover; IP23 in non-accessible ceilings, for luminaires without glass cover. Insulation class II, III depending on the versions. Suitable for installation on normally inflammable surfaces.

Standard Compliance and Quality Marks

EN60598-1 European Technical Standards and any subsequent additions.

MICRO BATTERY

Micro Battery Opal Glass

Light Source: LED Array DC 500 mA - 9,2W - 1060 lm - 3000K/CRI 90

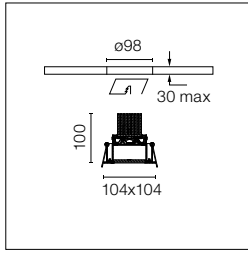

Apparecchio da incasso a LED.
Fonte di alimentazione esclusa.

Recessed luminaire with LED light source. Power supply not included.



Alimentazioni raccomandate / Recommended power supply*:

Non Dimmable	60.9160
Dimmable 1-10V	RF27961
Dimmable Dali 1	RF26571
Dimmable Dali 2	60.9222
Mains Dimming	60.9411
Casambi	60.9207

* Vedi capitolo Drivers / Refer to the Drivers chapter

- 04.6330.20B
- 04.6330.08B
- 04.6330.14B

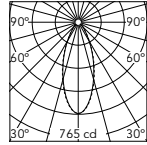

Beam Angle: 40°

h(m)	E(lx)	D(m)
1	765	0.72
2	191	1.45
3	85	2.17
4	48	2.89
5	31	3.62

Luminous flux luminaire
581 lm (EXTREME CUT OFF)

Micro Battery Opal Glass

Light Source: LED PAR 16 GZ10

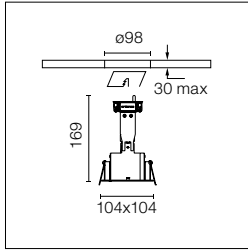

Apparecchio da incasso con alimentazione in tensione di rete per lampada LED Retrofit.

Recessed luminaire with main voltage source for LED Retrofit lamp.

- 04.6305.20
- 04.6305.08
- 04.6305.14

Micro Battery Opal Glass

Light Source: LED QR-CBC 51 GX5.3

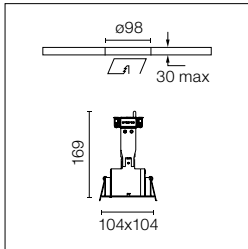

Apparecchio da incasso per lampada LED Retrofit 12V. Trasformatore remoto non incluso.

Recessed luminaire for 12V LED Retrofit lamp. Remote transformer not included.

- 04.6300.20
- 04.6300.08
- 04.6300.14

MICRO BATTERY

Micro Battery Fixed

Light Source: LED Array DC 500 mA - 9,2W - 1060 lm - 3000K/CRI 90

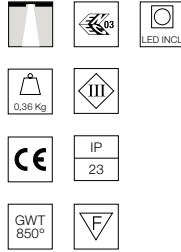
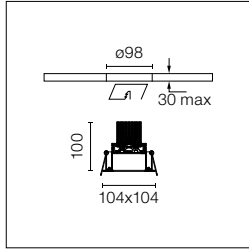

Apparecchio da incasso a LED.
Fonte di alimentazione esclusa.

Recessed luminaire with LED light source. Power supply not included.

Alimentazioni raccomandate / Recommended power supply*:

Non Dimmable	60.9160
Dimmable 1-10V	RF27961
Dimmable Dali 1	RF26571
Dimmable Dali 2	60.9222
Mains Dimming	60.9411
Casambi	60.9207

* Vedi capitolo Drivers / Refer to the Drivers chapter

- 04.6333.20B
- 04.6333.08B
- 04.6333.14B

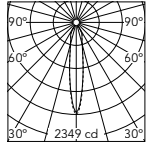

Beam Angle: 17°

h(m)	E(lx)	D(m)
1	2349	0.31
2	587	0.61
3	261	0.92
4	147	1.23
5	94	1.54

Luminous flux luminaire
611 lm (EXTREME CUT OFF)

- 04.6335.20B
- 04.6335.08B
- 04.6335.14B

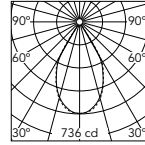

Beam Angle: 58°

h(m)	E(lx)	D(m)
1	736	1.10
2	184	2.20
3	82	3.30
4	46	4.40
5	29	5.50

Luminous flux luminaire
589 lm (EXTREME CUT OFF)

- 04.6334.20B
- 04.6334.08B
- 04.6334.14B

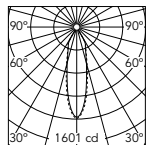

Beam Angle: 25°

h(m)	E(lx)	D(m)
1	1601	0.45
2	400	0.90
3	178	1.35
4	100	1.80
5	64	2.25

Luminous flux luminaire
614 lm (EXTREME CUT OFF)

Micro Battery Fixed

Light Source: LED PAR 16 GZ10

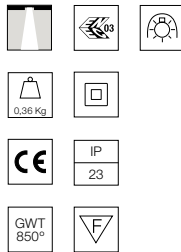
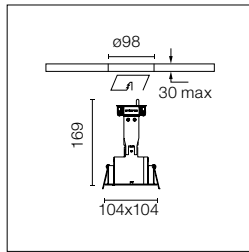

Apparecchio da incasso con alimentazione in tensione di rete per lampada LED Retrofit.

Recessed luminaire with main voltage source for LED Retrofit lamp.

- 04.6306.20
- 04.6306.08
- 04.6306.14

Micro Battery Fixed

Light Source: LED QR-CBC 51 GX5.3

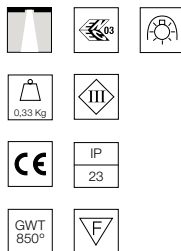
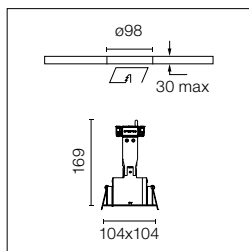

Apparecchio da incasso per lampada LED Retrofit 12V. Trasformatore remoto non incluso.

Recessed luminaire for 12V LED Retrofit lamp. Remote transformer not included.

- 04.6301.20
- 04.6301.08
- 04.6301.14

MICRO BATTERY

Micro Battery Adjustable

Light Source: LED Array DC 500 mA - 9,2W - 1060 lm - 3000K/CRI 90

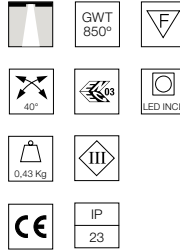
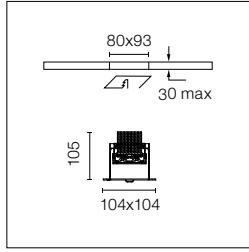
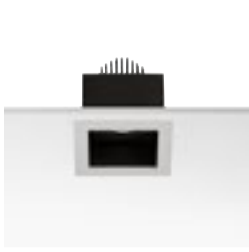

Apparecchio da incasso a LED.
Fonte di alimentazione esclusa.

Recessed luminaire with LED light source. Power supply not included.

Alimentazioni raccomandate / Recommended power supply*:

Non Dimmable	60.9160
Dimmable 1-10V	RF27961
Dimmable Dali 1	RF26571
Dimmable Dali 2	60.9222
Mains Dimming	60.9411
Casambi	60.9207

* Vedi capitolo Drivers / Refer to the Drivers chapter

- 04.6336.20B
- 04.6336.08B
- 04.6336.14B

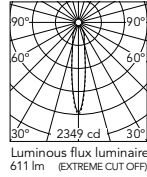

Beam Angle: 17°

h(m)	E(lx)	D(m)
1	2349	0.31
2	587	0.61
3	261	0.92
4	147	1.23
5	94	1.54

- 04.6338.20B
- 04.6338.08B
- 04.6338.14B

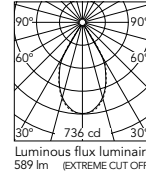

Beam Angle: 58°

h(m)	E(lx)	D(m)
1	736	1.10
2	184	2.20
3	82	3.30
4	46	4.40
5	29	5.50

- 04.6337.20B
- 04.6337.08B
- 04.6337.14B

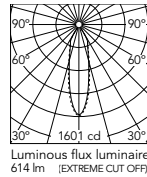

Beam Angle: 25°

h(m)	E(lx)	D(m)
1	1601	0.45
2	400	0.90
3	178	1.35
4	100	1.80
5	64	2.25

Micro Battery Adjustable

Light Source: LED PAR 16 GZ10

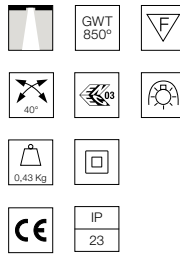
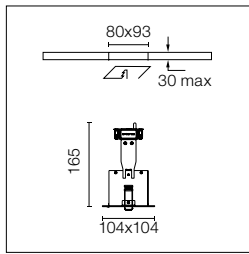

Apparecchio da incasso con alimentazione in tensione di rete per lampada LED Retrofit.

Recessed luminaire with main voltage source for LED Retrofit lamp.

- 04.6307.20
- 04.6307.08
- 04.6307.14

Micro Battery Adjustable

Light Source: LED QR-CBC 51 GX5.3

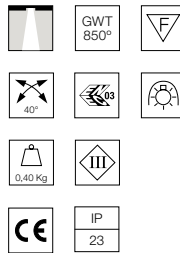
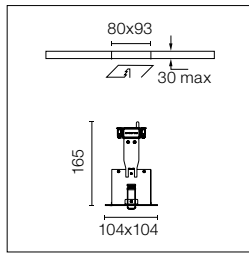

Apparecchio da incasso per lampada LED Retrofit 12V. Trasformatore remoto non incluso.

Recessed luminaire for 12V LED Retrofit lamp. Remote transformer not included.

- 04.6302.20
- 04.6302.08
- 04.6302.14

Accessori / Accessories

Cilindro antiabbagliamento. Cut-off 40°. Non compatibili con versioni LED.

Anti-glare cylinder. Cut-off 40°. Not compatible with LED versions.



- 08.8270.14

SPOTLIGHTS

Camera, Find Me, UT Spot&Pro,
Solid Pure, Pure Spot, Wan Spot,
Fort Knox.

CAMERA

DESIGNED BY KNUD HOLSCHER

IN-TRACK

CAMERA
60



LIGHT SOURCE
LED ARRAY
Up to 20W
3000K/CRI 97
Up to 1260 lm
3500K/CRI 97
Up to 1355 lm

CAMERA
90



LIGHT SOURCE
LED ARRAY
Up to 32W
3000K/CRI 97
Up to 2585 lm
3500K/CRI 97
Up to 2715 lm

GA-69

CAMERA
60



LIGHT SOURCE
LED ARRAY
Up to 20W
3000K/CRI 97
Up to 1260 lm
3500K/CRI 97
Up to 1355 lm

CAMERA
90



LIGHT SOURCE
LED ARRAY
Up to 32W
3000K/CRI 97
Up to 2585 lm
3500K/CRI 97
Up to 2715 lm

WA Bianco Tessuto
WA Textured White

DR Antracite
DR Anthracite



Descrizione

Apparecchio per interni da installare a binario trifase disponibile con sorgenti luminose a tecnologia Led di alta potenza in versione dimmerabile e non dimmerabile. La famiglia è disponibile in due misure (60 / 90). Il corpo ottico dell'apparecchio è il risultato di un'attenta ricerca ottica. Lente a doppio fuoco sviluppata da FLOS appositamente per questi prodotti. Garantisce il massimo controllo ottico e un'omogeneità della luce eccezionale. Camera sfrutta i benefici di un'innovativa lente in silicone micro texturizzata che permette un controllo estremo oltre a raggiungere un'efficienza assoluta, resistenza al calore e massima qualità nella distribuzione della luce. L'apparecchio integra un LED ARRAY abbinato ad un controllo speciale del fascio luminoso che permette di ottenere fasci molto stretti e illuminazione generale diffusa secondo le esigenze. Gruppo ottico cut-off integrato. Il Kit ottico disponibile include 5 aperture di fascio differenziate, ognuna sviluppata per un'applicazione speciale. Sia nel caso di fasci intensivi che di effetti di luce diffusa, il controllo ottico è sempre eccezionale e la luce spuria è totalmente assente.

Unità di Alimentazione

Alimentatore a corrente continua incluso disponibile nelle versioni non regolabile o regolabile tramite potenziometro integrato, DALI e Casambi. Per gestione con il sistema Casambi (Max. 200 apparecchi) è necessario ordinare apparecchi di illuminazione in versione Casambi. Per la gestione e controllo del sistema Casambi è necessario scaricare la APP FLOS Control® powered by Casambi (disponibile in Apple Store e Google Play) per dispositivi mobili.

Accessori

- Disponibile honeycomb.

Conformità e Marchi di Qualità

Apparecchio conforme alla Normativa Tecnica Europea EN60598-1 e relative parti seconde.

Description

Luminaire for indoor use to be mounted on three phase track, available in LED technology light sources and in dimmable and non-dimmable versions. The family is available in two sizes (60 / 90). The optical housing of the luminaire is the result of a careful optical research. Dual focus lens specifically developed by FLOS for these products. Ensures maximum optical control and exceptionally even light beams. Camera takes advantage of an innovative micro-textured silicone lens that allows extreme control as well as providing absolute efficiency, heat resistance and maximum quality in light distribution. It incorporates an LED Array with an innovative light projection treatment that allows very narrow optics and general lighting. Integrated full cut-off. The optical kit available includes 5 differentiated beam openings, each developed for a specific target application. Whether it's intensive beams or diffused light effects, optical control is always exceptional and fall-off is totally absent.

Power Supply

Not dimmable or dimmable 220-240V, constant current, power supply included. Dimmable versions are available with DALI, Casambi or come with a built-in Potentiometer. For Casambi management (Max. 200 luminaires) it is mandatory to use fixtures in the Casambi version. For managing and controlling the Casambi system, the FLOS Control® app powered by Casambi for mobile devices is required (available in the Apple Store and Google Play).

Accessories

- Honeycomb available.

Standard Compliance and Quality Marks

EN60598-1 European Technical Standards and any subsequent additions.

FLOS
CONTROL BY CASAMBI



Camera 60

Light Source: Super Spot: LED Array 13W - 750 lm - 3000K/CRI 97 / 13W - 780 lm - 3500K/CRI 97
S/M/F/WF: LED Array 20W - 1260 lm - 3000K/CRI 97 / 20W - 1355 lm - 3500K/CRI 97

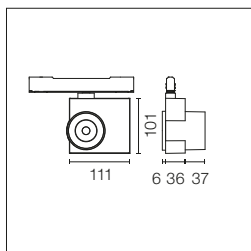

Proiettore per installazione su binario trifase con fonte di luce LED. Fonte di alimentazione 220-240V, 50-60Hz integrata. Da installare con i profili Tracking Power.

Spotlight to be installed on 3-phase track with LED light source. 220-240V, 50-60Hz power supply integrated. To be used with The Tracking Power profiles.

Optic Super Spot 3000K

Non Dimmable
09.8100.WA
09.8100.DR
Potentiometer
09.8100.WA.PC
09.8100.DR.PC
*Casambi integrated
09.8100.WA.CB
09.8100.DR.CB

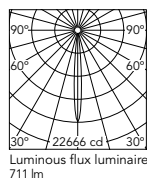

Beam Angle: 9°			
h(m)	E(lx)	D(m)	
1	22666	0.16	
2	5667	0.32	
3	2518	0.48	
4	1417	0.63	
5	907	0.79	

Luminous flux luminaire
711 lm

Optic Super Spot 3500K

Non Dimmable
09.8105.WA
09.8105.DR
Potentiometer
09.8105.WA.PC
09.8105.DR.PC
*Casambi integrated
09.8105.WA.CB
09.8105.DR.CB

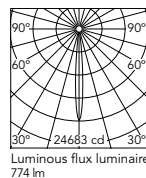

Beam Angle: 9°			
h(m)	E(lx)	D(m)	
1	24683	0.16	
2	6171	0.32	
3	2743	0.48	
4	1543	0.63	
5	987	0.79	

Luminous flux luminaire
774 lm

Optic Spot 3000K

Non Dimmable
09.8101.WA
09.8101.DR
Potentiometer
09.8101.WA.PC
09.8101.DR.PC
*Casambi integrated
09.8101.WA.CB
09.8101.DR.CB

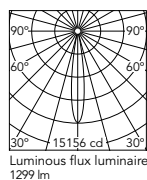

Beam Angle: 15°			
h(m)	E(lx)	D(m)	
1	15156	0.27	
2	3789	0.54	
3	1684	0.81	
4	947	1.09	
5	606	1.36	

Luminous flux luminaire
1299 lm

Optic Spot 3500K

Non Dimmable
09.8106.WA
09.8106.DR
Potentiometer
09.8106.WA.PC
09.8106.DR.PC
*Casambi integrated
09.8106.WA.CB
09.8106.DR.CB

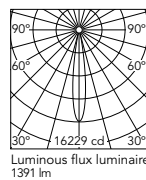

Beam Angle: 15°			
h(m)	E(lx)	D(m)	
1	16229	0.27	
2	4057	0.54	
3	1803	0.81	
4	1014	1.09	
5	649	1.36	

Luminous flux luminaire
1391 lm

Optic Medium 3000K

Non Dimmable
09.8102.WA
09.8102.DR
Potentiometer
09.8102.WA.PC
09.8102.DR.PC
*Casambi integrated
09.8102.WA.CB
09.8102.DR.CB

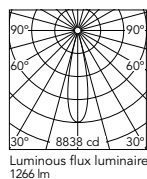

Beam Angle: 23°			
h(m)	E(lx)	D(m)	
1	8838	0.41	
2	2210	0.81	
3	982	1.22	
4	552	1.62	
5	354	2.03	

Luminous flux luminaire
1266 lm

Optic Medium 3500K

Non Dimmable
09.8107.WA
09.8107.DR
Potentiometer
09.8107.WA.PC
09.8107.DR.PC
*Casambi integrated
09.8107.WA.CB
09.8107.DR.CB

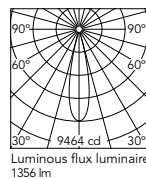

Beam Angle: 23°			
h(m)	E(lx)	D(m)	
1	9464	0.41	
2	2366	0.81	
3	1052	1.22	
4	591	1.62	
5	379	2.03	

Luminous flux luminaire
1356 lm

Optic Flood 3000K

Non Dimmable
09.8103.WA
09.8103.DR
Potentiometer
09.8103.WA.PC
09.8103.DR.PC
*Casambi integrated
09.8103.WA.CB
09.8103.DR.CB

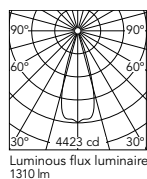

Beam Angle: 34°			
h(m)	E(lx)	D(m)	
1	4423	0.61	
2	1106	1.21	
3	491	1.82	
4	276	2.42	
5	177	3.03	

Luminous flux luminaire
1310 lm

Optic Flood 3500K

Non Dimmable
09.8108.WA
09.8108.DR
Potentiometer
09.8108.WA.PC
09.8108.DR.PC
*Casambi integrated
09.8108.WA.CB
09.8108.DR.CB

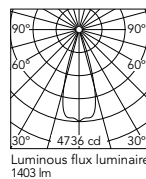

Beam Angle: 34°			
h(m)	E(lx)	D(m)	
1	4736	0.61	
2	1184	1.21	
3	526	1.82	
4	296	2.42	
5	189	3.03	

Luminous flux luminaire
1403 lm

Optic Wide Flood 3000K

Non Dimmable
09.8104.WA
09.8104.DR
Potentiometer
09.8104.WA.PC
09.8104.DR.PC
*Casambi integrated
09.8104.WA.CB
09.8104.DR.CB

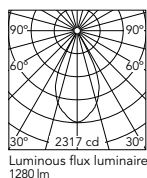

Beam Angle: 50°			
h(m)	E(lx)	D(m)	
1	2317	0.94	
2	579	1.89	
3	257	2.83	
4	145	3.77	
5	93	4.72	

Luminous flux luminaire
1280 lm

Optic Wide Flood 3500K

Non Dimmable
09.8109.WA
09.8109.DR
Potentiometer
09.8109.WA.PC
09.8109.DR.PC
*Casambi integrated
09.8109.WA.CB
09.8109.DR.CB

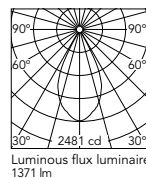

Beam Angle: 50°			
h(m)	E(lx)	D(m)	
1	2481	0.94	
2	620	1.89	
3	276	2.83	
4	155	3.77	
5	99	4.72	

Luminous flux luminaire
1371 lm

CAMERA

Camera 90

Light Source: Super Spot: LED Array 20W - 1515 lm - 3000K/CRI 97 / 20W - 1625 lm - 3500K/CRI 97
 S/M/F/WF: LED Array 32W - 2585 lm - 3000K/CRI 97 / 32W - 2715 lm - 3500K/CRI 97

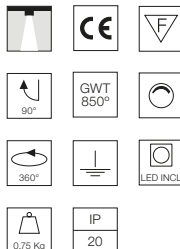
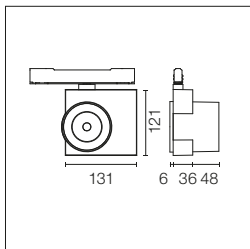

Proiettore per installazione su binario trifase con fonte di luce LED. Fonte di alimentazione 220-240V, 50-60Hz integrata. Da installare con i profili Tracking Power.

Spotlight to be installed on 3-phase track with LED light source. 220-240V, 50-60Hz power supply integrated. To be used with The Tracking Power profiles.

Optic Super Spot 3000K

- Non Dimmable
- 09.8200.WA
- 09.8200.DR
- Potentiometer
- 09.8200.WA.PC
- 09.8200.DR.PC
- *Casambi integrated
- 09.8200.WA.CB
- 09.8200.DR.CB

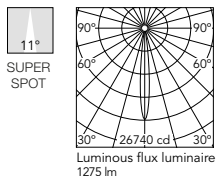

Beam Angle: 11°

h(m)	E(lx)	D(m)
1	26740	0.20
2	6685	0.39
3	2971	0.59
4	1671	0.78
5	1070	0.98

Optic Super Spot 3500K

- Non Dimmable
- 09.8205.WA
- 09.8205.DR
- Potentiometer
- 09.8205.WA.PC
- 09.8205.DR.PC
- *Casambi integrated
- 09.8205.WA.CB
- 09.8205.DR.CB

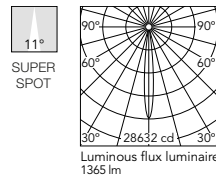

Beam Angle: 11°

h(m)	E(lx)	D(m)
1	28632	0.20
2	7158	0.39
3	3181	0.59
4	1789	0.78
5	1145	0.98

Optic Spot 3000K

- Non Dimmable
- 09.8201.WA
- 09.8201.DR
- Potentiometer
- 09.8201.WA.PC
- 09.8201.DR.PC
- *Casambi integrated
- 09.8201.WA.CB
- 09.8201.DR.CB

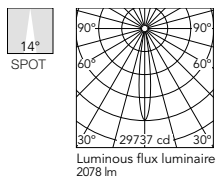

Beam Angle: 14°

h(m)	E(lx)	D(m)
1	29737	0.25
2	7434	0.49
3	3304	0.74
4	1859	0.99
5	1189	1.24

Optic Spot 3500K

- Non Dimmable
- 09.8206.WA
- 09.8206.DR
- Potentiometer
- 09.8206.WA.PC
- 09.8206.DR.PC
- *Casambi integrated
- 09.8206.WA.CB
- 09.8206.DR.CB

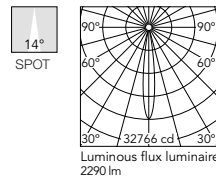

Beam Angle: 14°

h(m)	E(lx)	D(m)
1	32766	0.25
2	8192	0.49
3	3641	0.74
4	2048	0.99
5	1311	1.24

Optic Medium 3000K

- Non Dimmable
- 09.8202.WA
- 09.8202.DR
- Potentiometer
- 09.8202.WA.PC
- 09.8202.DR.PC
- *Casambi integrated
- 09.8202.WA.CB
- 09.8202.DR.CB

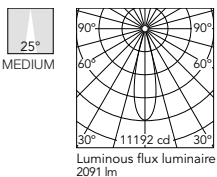

Beam Angle: 25°

h(m)	E(lx)	D(m)
1	11192	0.45
2	2798	0.90
3	1244	1.35
4	700	1.80
5	448	2.25

Optic Medium 3500K

- Non Dimmable
- 09.8207.WA
- 09.8207.DR
- Potentiometer
- 09.8207.WA.PC
- 09.8207.DR.PC
- *Casambi integrated
- 09.8207.WA.CB
- 09.8207.DR.CB

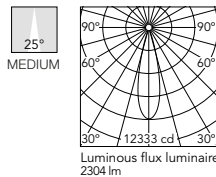

Beam Angle: 25°

h(m)	E(lx)	D(m)
1	12333	0.45
2	3083	0.90
3	1370	1.35
4	771	1.80
5	493	2.25

Optic Flood 3000K

- Non Dimmable
- 09.8203.WA
- 09.8203.DR
- Potentiometer
- 09.8203.WA.PC
- 09.8203.DR.PC
- *Casambi integrated
- 09.8203.WA.CB
- 09.8203.DR.CB

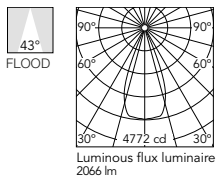

Beam Angle: 43°

h(m)	E(lx)	D(m)
1	4772	0.78
2	1193	1.56
3	530	2.34
4	298	3.12
5	191	3.90

Optic Flood 3500K

- Non Dimmable
- 09.8208.WA
- 09.8208.DR
- Potentiometer
- 09.8208.WA.PC
- 09.8208.DR.PC
- *Casambi integrated
- 09.8208.WA.CB
- 09.8208.DR.CB

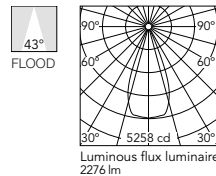

Beam Angle: 43°

h(m)	E(lx)	D(m)
1	5258	0.78
2	1315	1.56
3	584	2.34
4	329	3.12
5	210	3.90

Optic Wide Flood 3000K

- Non Dimmable
- 09.8204.WA
- 09.8204.DR
- Potentiometer
- 09.8204.WA.PC
- 09.8204.DR.PC
- *Casambi integrated
- 09.8204.WA.CB
- 09.8204.DR.CB

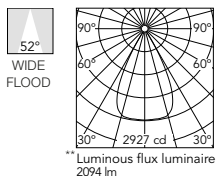

Beam Angle: 52°

h(m)	E(lx)	D(m)
1	2927	1.05
2	732	2.09
3	325	3.14
4	183	4.19
5	117	5.24

Optic Wide Flood 3500K

- Non Dimmable
- 09.8209.WA
- 09.8209.DR
- Potentiometer
- 09.8209.WA.PC
- 09.8209.DR.PC
- *Casambi integrated
- 09.8209.WA.CB
- 09.8209.DR.CB

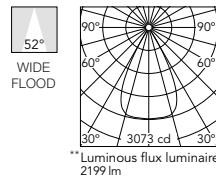

Beam Angle: 52°

h(m)	E(lx)	D(m)
1	3073	1.05
2	768	2.09
3	341	3.14
4	192	4.19
5	123	5.24

* Il sistema di controllo degli apparecchi i versione Casambi si regola direttamente tramite bluetooth con l'applicazione dedicata FLOS Control® by Casambi / The control system with the Casambi version of light fixtures is directly and individually regulated wirelessly using the application FLOS Control® by Casambi.

** Fotometrie preliminari. Consultare la nostra pagina web per informazioni aggiornate / Preliminary photometries. Visit our website for updated information.

Camera 60 GA-69 (Dali GAC-600)

Light Source: Super Spot: LED Array 13W - 750 lm - 3000K/CRI 97 / 12W - 780 lm - 3500K/CRI 97
 S/M/F/WF: LED Array 20W - 1260 lm - 3000K/CRI 97 / 20W - 1355 lm - 3500K/CRI 97

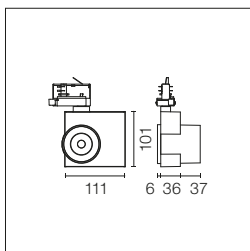

Proiettore per installazione su binario trifase con fonte di luce LED. Fonte di alimentazione 220-240V, 50-60Hz integrata. Per la versione DALI sono necessari profili dimmerabili (consultare capitolo "Tracks").

Spotlight to be installed on 3-phase track with LED light source. 220-240V, 50-60Hz power supply integrated. DALI version requires dimmable tracks (please refer to the "Tracks" chapter).

Optic Super Spot 3000K

- Non Dimmable
- 09.8110.WA
- 09.8110.DR
- Dali Version
- 09.8110.WA.DA
- 09.8110.DR.DA
- Potentiometer
- 09.8110.WA.PC
- 09.8110.DR.PC
- *Casambi integrated
- 09.8110.WA.CB
- 09.8110.DR.CB

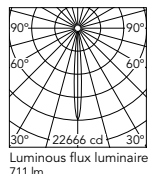

Beam Angle: 9°

h(m)	E(lx)	D(m)
1	22666	0.16
2	5667	0.32
3	2518	0.48
4	1417	0.63
5	907	0.79

Optic Super Spot 3500K

- Non Dimmable
- 09.8115.WA
- 09.8115.DR
- Dali Version
- 09.8115.WA.DA
- 09.8115.DR.DA
- Potentiometer
- 09.8115.WA.PC
- 09.8115.DR.PC
- *Casambi integrated
- 09.8115.WA.CB
- 09.8115.DR.CB

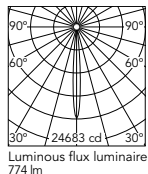

Beam Angle: 9°

h(m)	E(lx)	D(m)
1	24683	0.16
2	6171	0.32
3	2743	0.48
4	1543	0.63
5	987	0.79

Optic Spot 3000K

- Non Dimmable
- 09.8111.WA
- 09.8111.DR
- Dali Version
- 09.8111.WA.DA
- 09.8111.DR.DA
- Potentiometer
- 09.8111.WA.PC
- 09.8111.DR.PC
- *Casambi integrated
- 09.8111.WA.CB
- 09.8111.DR.CB

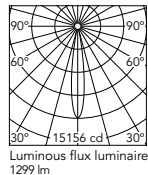

Beam Angle: 15°

h(m)	E(lx)	D(m)
1	15156	0.27
2	3789	0.54
3	1684	0.81
4	947	1.09
5	606	1.36

Optic Spot 3500K

- Non Dimmable
- 09.8116.WA
- 09.8116.DR
- Dali Version
- 09.8116.WA.DA
- 09.8116.DR.DA
- Potentiometer
- 09.8116.WA.PC
- 09.8116.DR.PC
- *Casambi integrated
- 09.8116.WA.CB
- 09.8116.DR.CB

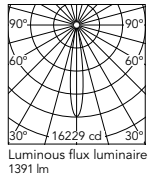

Beam Angle: 15°

h(m)	E(lx)	D(m)
1	16229	0.27
2	4057	0.54
3	1803	0.81
4	1014	1.09
5	649	1.36

Optic Medium 3000K

- Non Dimmable
- 09.8112.WA
- 09.8112.DR
- Dali Version
- 09.8112.WA.DA
- 09.8112.DR.DA
- Potentiometer
- 09.8112.WA.PC
- 09.8112.DR.PC
- *Casambi integrated
- 09.8112.WA.CB
- 09.8112.DR.CB

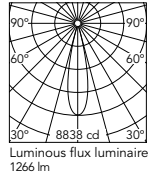

Beam Angle: 23°

h(m)	E(lx)	D(m)
1	8838	0.41
2	2210	0.81
3	982	1.22
4	552	1.62
5	354	2.03

Optic Medium 3500K

- Non Dimmable
- 09.8117.WA
- 09.8117.DR
- Dali Version
- 09.8117.WA.DA
- 09.8117.DR.DA
- Potentiometer
- 09.8117.WA.PC
- 09.8117.DR.PC
- *Casambi integrated
- 09.8117.WA.CB
- 09.8117.DR.CB

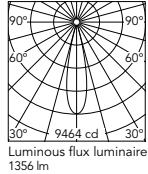

Beam Angle: 23°

h(m)	E(lx)	D(m)
1	9464	0.41
2	2366	0.81
3	1052	1.22
4	591	1.62
5	379	2.03

Optic Flood 3000K

- Non Dimmable
- 09.8113.WA
- 09.8113.DR
- Dali Version
- 09.8113.WA.DA
- 09.8113.DR.DA
- Potentiometer
- 09.8113.WA.PC
- 09.8113.DR.PC
- *Casambi integrated
- 09.8113.WA.CB
- 09.8113.DR.CB

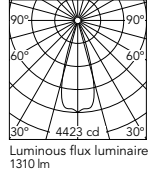

Beam Angle: 34°

h(m)	E(lx)	D(m)
1	4423	0.61
2	1106	1.21
3	491	1.82
4	276	2.42
5	177	3.03

Optic Flood 3500K

- Non Dimmable
- 09.8118.WA
- 09.8118.DR
- Dali Version
- 09.8118.WA.DA
- 09.8118.DR.DA
- Potentiometer
- 09.8118.WA.PC
- 09.8118.DR.PC
- *Casambi integrated
- 09.8118.WA.CB
- 09.8118.DR.CB

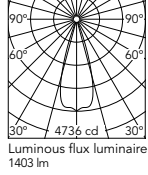

Beam Angle: 34°

h(m)	E(lx)	D(m)
1	4736	0.61
2	1184	1.21
3	526	1.82
4	296	2.42
5	189	3.03

* Il sistema di controllo degli apparecchi in versione Casambi si regola direttamente tramite bluetooth con l'applicazione dedicata FLOS Control® by Casambi / The control system with the Casambi version of light fixtures is directly and individually regulated wirelessly using the application FLOS Control® by Casambi.

**Optic Wide Flood
3000K**

Non Dimmable

09.8114.WA
09.8114.DR

Dali Version

09.8114.WA.DA
09.8114.DR.DA

Potentiometer

09.8114.WA.PC
09.8114.DR.PC

*Casambi integrated

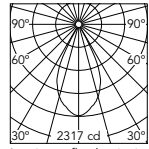
09.8114.WA.CB
09.8114.DR.CB

Beam Angle: 50°

h(m)	E(lx)	D(m)
1	2317	0.94
2	579	1.89
3	257	2.83
4	145	3.77
5	93	4.72

**Optic Wide Flood
3500K**

Non Dimmable

09.8119.WA
09.8119.DR

Dali Version

09.8119.WA.DA
09.8119.DR.DA

Potentiometer

09.8119.WA.PC
09.8119.DR.PC

*Casambi integrated

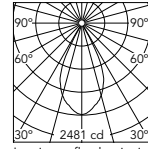
09.8119.WA.CB
09.8119.DR.CB

Beam Angle: 50°

h(m)	E(lx)	D(m)
1	2481	0.94
2	620	1.89
3	276	2.83
4	155	3.77
5	99	4.72

* Il sistema di controllo degli apparecchi i versione Casambi si regola direttamente tramite bluetooth con l'applicazione dedicata FLOS Control® by Casambi / The control system with the Casambi version of light fixtures is directly and individually regulated wirelessly using the application FLOS Control® by Casambi.

Camera 90 GA-69 (Dali GAC-600)

Light Source: Super Spot: LED Array 20W - 1515 lm - 3000K/CRI 97 / 20W - 1625 lm - 3500K/CRI 97
S/M/F/WF: LED Array 32W - 2585 lm - 3000K/CRI 97 / 32W - 2715 lm - 3500K/CRI 97

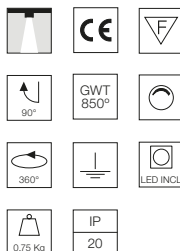
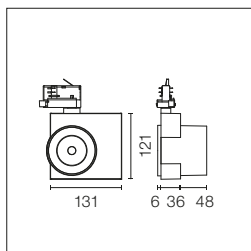

Proiettore per installazione su binario trifase con fonte di luce LED. Fonte di alimentazione 220-240V, 50-60Hz integrata. Per la versione DALI sono necessari profili dimmerabili (consultare capitolo "Tracks").

Spotlight to be installed on 3-phase track with LED light source. 220-240V, 50-60Hz power supply integrated. DALI version requires dimmable tracks (please refer to the "Tracks" chapter).

Optic Super Spot 3000K

Non Dimmable

09.8210.WA
09.8210.DR

Dali Version

09.8210.WA.DA
09.8210.DR.DA

Potentiometer

09.8210.WA.PC
09.8210.DR.PC

*Casambi integrated

09.8210.WA.CB
09.8210.DR.CB

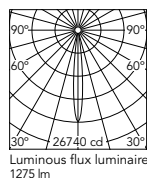

Beam Angle: 11°

h(m)	E(lx)	D(m)
1	26740	0.20
2	6685	0.39
3	2971	0.59
4	1671	0.78
5	1070	0.98

Optic Super Spot 3500K

Non Dimmable

09.8215.WA
09.8215.DR

Dali Version

09.8215.WA.DA
09.8215.DR.DA

Potentiometer

09.8215.WA.PC
09.8215.DR.PC

*Casambi integrated

09.8215.WA.CB
09.8215.DR.CB

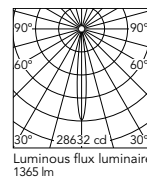

Beam Angle: 11°

h(m)	E(lx)	D(m)
1	28632	0.20
2	7158	0.39
3	3181	0.59
4	1789	0.78
5	1145	0.98

Optic Spot 3000K

Non Dimmable

09.8211.WA
09.8211.DR

Dali Version

09.8211.WA.DA
09.8211.DR.DA

Potentiometer

09.8211.WA.PC
09.8211.DR.PC

*Casambi integrated

09.8211.WA.CB
09.8211.DR.CB

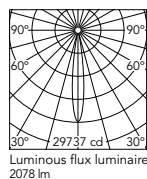

Beam Angle: 14°

h(m)	E(lx)	D(m)
1	29737	0.25
2	7434	0.49
3	3304	0.74
4	1859	0.99
5	1189	1.24

Optic Spot 3500K

Non Dimmable

09.8216.WA
09.8216.DR

Dali Version

09.8216.WA.DA
09.8216.DR.DA

Potentiometer

09.8216.WA.PC
09.8216.DR.PC

*Casambi integrated

09.8216.WA.CB
09.8216.DR.CB

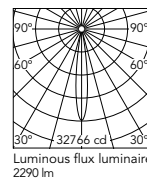

Beam Angle: 14°

h(m)	E(lx)	D(m)
1	32766	0.25
2	8192	0.49
3	3641	0.74
4	2048	0.99
5	1311	1.24

Optic Medium 3000K

Non Dimmable

09.8212.WA
09.8212.DR

Dali Version

09.8212.WA.DA
09.8212.DR.DA

Potentiometer

09.8212.WA.PC
09.8212.DR.PC

*Casambi integrated

09.8212.WA.CB
09.8212.DR.CB

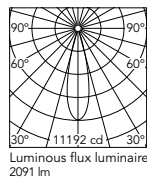

Beam Angle: 25°

h(m)	E(lx)	D(m)
1	11192	0.45
2	2798	0.90
3	1244	1.35
4	700	1.80
5	448	2.25

Optic Medium 3500K

Non Dimmable

09.8217.WA
09.8217.DR

Dali Version

09.8217.WA.DA
09.8217.DR.DA

Potentiometer

09.8217.WA.PC
09.8217.DR.PC

*Casambi integrated

09.8217.WA.CB
09.8217.DR.CB

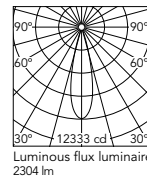

Beam Angle: 25°

h(m)	E(lx)	D(m)
1	12333	0.45
2	3083	0.90
3	1370	1.35
4	771	1.80
5	493	2.25

Optic Flood 3000K

Non Dimmable

09.8213.WA
09.8213.DR

Dali Version

09.8213.WA.DA
09.8213.DR.DA

Potentiometer

09.8213.WA.PC
09.8213.DR.PC

*Casambi integrated

09.8213.WA.CB
09.8213.DR.CB

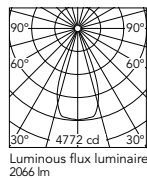

Beam Angle: 43°

h(m)	E(lx)	D(m)
1	4772	0.78
2	1193	1.56
3	530	2.34
4	298	3.12
5	191	3.90

Optic Flood 3500K

Non Dimmable

09.8218.WA
09.8218.DR

Dali Version

09.8218.WA.DA
09.8218.DR.DA

Potentiometer

09.8218.WA.PC
09.8218.DR.PC

*Casambi integrated

09.8218.WA.CB
09.8218.DR.CB

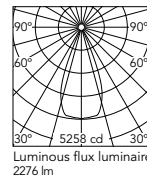

Beam Angle: 43°

h(m)	E(lx)	D(m)
1	5258	0.78
2	1315	1.56
3	584	2.34
4	329	3.12
5	210	3.90

**Optic Wide Flood
3000K**

Non Dimmable

09.8214.WA

09.8214.DR

Dali Version

09.8214.WA.DA

09.8214.DR.DA

Potentiometer

09.8214.WA.PC

09.8214.DR.PC

*Casambi integrated

09.8214.WA.CB

09.8214.DR.CB

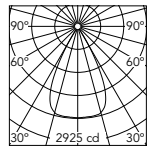

Beam Angle: 52°

h(m) E(lx) D(m)

1 2925 1.05

2 731 2.09

3 325 3.14

4 183 4.19

5 117 5.24

**Luminous flux luminaire
2093 lm**Optic Wide Flood
3500K**

Non Dimmable

09.8219.WA

09.8219.DR

Dali Version

09.8219.WA.DA

09.8219.DR.DA

Potentiometer

09.8219.WA.PC

09.8219.DR.PC

*Casambi integrated

09.8219.WA.CB

09.8219.DR.CB

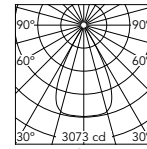

Beam Angle: 52°

h(m) E(lx) D(m)

1 3073 1.05

2 768 2.09

3 341 3.14

4 192 4.19

5 123 5.24

**Luminous flux luminaire
2199 lm**Accessori / Accessories****Camera 60**Honeycomb
Honeycomb

Super Spot / Spot

08.0175.14

Medium / Flood / Wide Flood

08.0176.14

Camera 90Honeycomb
Honeycomb

Super Spot / Spot

08.0177.14

Medium / Flood / Wide Flood

08.0178.14

* Il sistema di controllo degli apparecchi i versione Casambi si regola direttamente tramite bluetooth con l'applicazione dedicata FLOS Control® by Casambi / The control system with the Casambi version of light fixtures is directly and individually regulated wirelessly using the application FLOS Control® by Casambi.

** Fotometrie preliminari. Consultare la nostra pagina web per informazioni aggiornate / Preliminary photometries. Visit our website for updated information.

FIND ME

DESIGNED BY JORGE HERRERA

FIND ME 0
TRIM / NO TRIM



LIGHT SOURCE
POWER LED
3,5W
300 lm
2700K/CRI 90
325 lm
3000K/CRI 90

FIND ME 1
TRIM / NO TRIM



FIND ME 1
2L



LIGHT SOURCE
POWER LED
6W
560 lm
2700K/CRI 90
600 lm
3000K/CRI 90

FIND ME 1
SUSPENSION



FIND ME 2
TRIM / NO TRIM



LIGHT SOURCE
POWER LED
10W
860 lm
2700K/CRI 90
900 lm
3000K/CRI 90

□ 30 Bianco
30 White

■ 06 Cromo
06 Chrome

■ 14 Nero
14 Black

Mono Point



Double Point



Suspension



Colori del Cilindro Schermante (compresi)
Screening Cylinder Colours (included)

■ Arancio
Orange

■ Viola
Violet

■ Nero
Black



Può essere ruotato di 360° e orientato di 70°.
Can be rotated 360° and swivelled 70°.

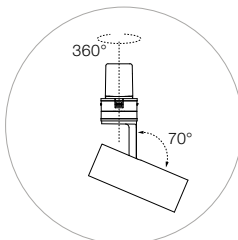

reddot design award
winner 2013

Descrizione

Famiglia di faretti per interni facile da installare in soffitti di cartongesso, formata da uno o due moduli di illuminazione LED.

L'apparecchio è disponibile nelle versioni: Mono Point, Double Point e Suspension.

La versione Mono Point viene fornita con una cornice cilindrica ad incasso sulla quale si installa il modulo di illuminazione. Questo modulo di illuminazione può essere disposto nella sua posizione superiore, per funzionare come un downlight, o nella sua posizione inferiore, per trasformarsi in un faretto orientabile.

La versione Mono Point viene fornita con una cornice, applicabile al prodotto nel caso in cui si desideri la versione Trim o non installabile se si desidera la versione No Trim.

La versione Double Point consiste in una cornice di materiale termoplastico iniettato in cui si installano due moduli di illuminazione. Proprio come nel modello Mono Point, i moduli sono orientabili e la cornice permette al prodotto di essere installato in posizione inferiore per funzionare come downlight.

La versione Suspension è una variante della versione Mono Point. La sua principale caratteristica è l'installazione a sospensione.

Riflettori

L'apparecchio viene fornito in ottica accent lighting.

Unità di Alimentazione

Il prodotto viene fornito pre-cablato, per essere collegato a una fonte di alimentazione remota (non inclusa) installata in un luogo accessibile o che passi attraverso il foro di incasso:

Find Me 0: 50 mm.

Find Me 1: 62 mm.

Find Me 2: 70 mm.

Accessori

La versione a Sospensione è dotata di un cilindro schermante disponibile in 3 colori: arancio, viola e nero, intercambiabili fra loro ed incorporati all'apparecchio. Per il Find Me 1 e 2: accessori professionali inclusi.

Informazioni Aggiuntive

Sistema di orientamento che permette la rotazione di 360° rispetto all'asse verticale e di 70° rispetto all'asse orizzontale.

Grado di protezione IP20.

Classe di isolamento III.

Conformità e Marchi di Qualità

Apparecchio conforme alla Normativa Tecnica Europea EN60598-1 e relative parti seconde.

Description

Spotlight family for indoor use, easy to mount on plasterboard ceilings, comprised of one or two LED lighting modules.

The luminaire is available in following versions: Mono Point, Double Point and Suspension.

The Mono Point version is supplied with a recessed cylindrical frame, which houses the lighting module. This lighting module can be placed in its upper position, when it will work like a downlight, or in its lower position, becoming an adjustable spotlight.

The Mono Point version is supplied with a frame, which should be fitted to the product if a Trim version is required, or without, if a No Trim version is required.

The Double Point version is supplied with an injected thermoplastic material frame, which houses two lighting modules. Like the Mono Point version, the modules are directional and the frame enables the product to be concealed, leaving just the end visible.

The Suspension version is a variant of the Mono Point version. Its main characteristic is its suspended mounting.

Reflectors

The luminaire is designed for accent lighting.

Power Supply

The fitting is supplied prewired ready to be connected to a remote power supply (not included) installed in an accessible place or to be passed through the ceiling cut-out:

Find Me 0: 50 mm.

Find Me 1: 62 mm.

Find Me 2: 70 mm.

Accessories

The Suspension version has interchangeable screening cylinders in 3 colours: orange, violet or black, incorporated into the light fixture.

For the Find Me 1 and 2: professional accessories included.

Additional Information

Adjustable system that allows a 360° rotation on vertical and 70° on horizontal edge.

IP20 protection grade.

Insulation class III.

Standard Compliance and Quality Marks

EN60598-1 European Technical Standards and any subsequent additions.



Suspension
Surface



Suspension
Recessed



Double Point



Mono Point
No Trim



Mono Point
Trim

FIND ME

Find Me 0 (Trim / No Trim)

Light Source: Power LED DC 250 mA - 3,5W - 300 lm - 2700K/CRI 90 / 3,5W - 325 lm - 3000K/CRI 90

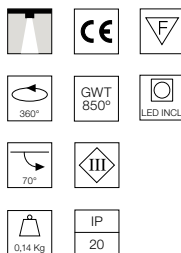
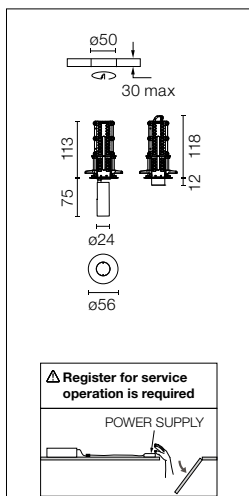

Apparecchio di illuminazione da incasso orientabile per interni. Alimentatore remoto 250 mA non compreso. Accessori inclusi (honeycomb e filtro a croce antiabbagliamento). Fonte di alimentazione remota da installare in un luogo accessibile. Non è consigliato l'uso di driver regolabili di marche diverse al presentare curve di regolazione specifiche.

Recessed adjustable luminaire for indoor application. Remote power supply 250 mA not included. Accessories included (honeycomb and screening crosspiece). Remote power supply to be installed in an accessible place. It is not recommended to use dimmable drivers of several brands due to the specific dimming curves of each brand.

Alimentazioni raccomandate e numero di apparecchi per driver (L)* / Recommended power supply and number of luminaires per driver (L)*:

1/2/3L* Non Dimmable 100-240V	60.9389
1/2/3L* Non Dimmable 220-240V	60.9160
1/2/3L* Dimmable Dali 2 110-240V	60.9601
1/2/3L* Dimmable 0-10V 220-240V	60.9405
2/3L* Mains Dimming 220-240V	60.9421
Casambi	60.9392 + 0-10V/Dali driver

Vedi capitolo Drivers / Refer to the Drivers chapter

2700K
09.3781.30A
09.3781.06A
09.3781.14A

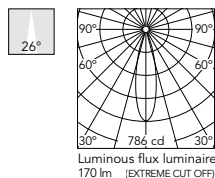

Beam Angle: 26°

h(m)	E(lx)	D(m)
1	786	0.45
2	197	0.91
3	87	1.36
4	49	1.82
5	31	2.27

Luminous flux luminaire
170 lm (EXTREME CUT OFF)

3000K
09.3780.30A
09.3780.06A
09.3780.14A

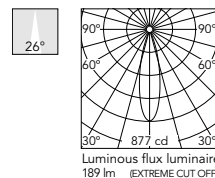

Beam Angle: 26°

h(m)	E(lx)	D(m)
1	877	0.45
2	219	0.91
3	97	1.36
4	55	1.82
5	35	2.27

Luminous flux luminaire
189 lm (EXTREME CUT OFF)

Find Me 1 (Trim / No Trim)

Light Source: Power LED DC 500 mA - 6W - 560 lm - 2700K/CRI 90 / 6W - 600 lm - 3000K/CRI 90

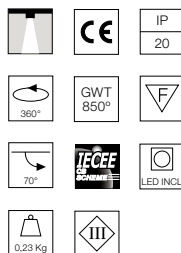
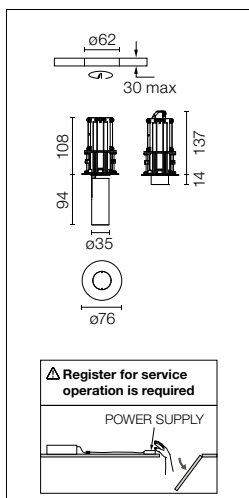
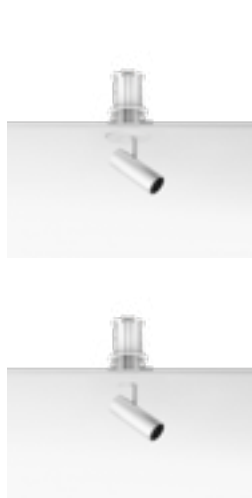

Apparecchio di illuminazione da incasso orientabile per interni. Alimentatore remoto 500 mA non compreso. Accessori inclusi (honeycomb e filtro a croce antiabbagliamento). Fonte di alimentazione remota da installare in un luogo accessibile.

Recessed adjustable luminaire for indoor application. Remote power supply 500 mA not included. Accessories included (honeycomb and screening crosspiece). Remote power supply to be installed in an accessible place.

Alimentazioni raccomandate / Recommended power supply*:

Non Dimmable 220-240V	60.9160
Non Dimmable 110-240V	60.8880
Dimmable Dali 1 110-240V	RF26571
Dimmable Dali 2 110-240V	60.9222
Mains Dimming 220-240V	60.9411
Dimmable 0/1-10V&Push 110/240V	RF27961
Casambi	60.9207

* Vedi capitolo Drivers / Refer to the Drivers chapter

2700K
09.3751.30A
09.3751.06A
09.3751.14A

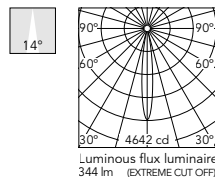

Beam Angle: 14°

h(m)	E(lx)	D(m)
1	4642	0.24
2	1160	0.48
3	516	0.72
4	290	0.95
5	186	1.19

Luminous flux luminaire
344 lm (EXTREME CUT OFF)

3000K
09.3750.30A
09.3750.06A
09.3750.14A

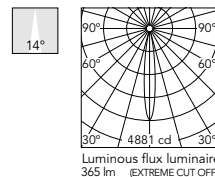

Beam Angle: 14°

h(m)	E(lx)	D(m)
1	4881	0.24
2	1220	0.49
3	542	0.73
4	305	0.97
5	195	1.21

Luminous flux luminaire
365 lm (EXTREME CUT OFF)

2700K
09.3756.30A
09.3756.06A
09.3756.14A

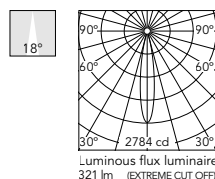

Beam Angle: 18°

h(m)	E(lx)	D(m)
1	2784	0.31
2	696	0.62
3	309	0.93
4	174	1.23
5	111	1.54

Luminous flux luminaire
321 lm (EXTREME CUT OFF)

3000K
09.3755.30A
09.3755.06A
09.3755.14A

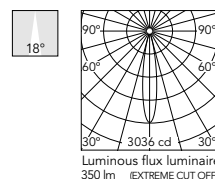

Beam Angle: 18°

h(m)	E(lx)	D(m)
1	3036	0.31
2	759	0.62
3	337	0.93
4	190	1.23
5	121	1.54

Luminous flux luminaire
350 lm (EXTREME CUT OFF)

FIND ME

Find Me 2 (Trim / No Trim)

Light Source: Power LED DC max 850 mA - 10W - 860 Lm - 2700K/CRI 90 / 10W - 900 lm - 3000K/CRI 90

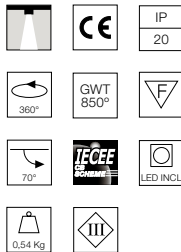
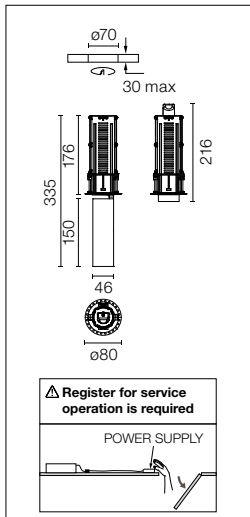

Apparecchio di illuminazione da incasso orientabile per interni. Alimentatore remoto non compreso. Accessori inclusi (honeycomb e filtro a croce antiabbagliamento). Fonte di alimentazione remota da installare in un luogo accessibile.

Recessed adjustable luminaire for indoor application. Remote power supply not included. Accessories included (honeycomb and screening crosspiece). Remote power supply to be installed in an accessible place.

Alimentazioni raccomandate / Recommended power supply*:

Non Dimmable MC 110-240V	60.8911
Non Dimmable MC 220-240V	RF27370
Non Dimmable 700mA 110-240V	60.8529
Dimmable Dali 1 220-240V	RF30699
Mains Dimming	60.9467
Dim 1-10V/Dim Dali/Push MC 110-240V	RF21468
Casambi	60.9207

* Vedi capitolo Drivers / Refer to the Drivers chapter

2700K
09.3707.30
09.3707.06
09.3707.14

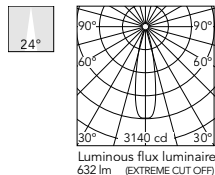

Beam Angle: 24°

h(m)	E(lx)	D(m)
1	3140	0.42
2	785	0.84
3	349	1.26
4	196	1.68
5	126	2.10

3000K
09.3708.30A
09.3708.06A
09.3708.14A

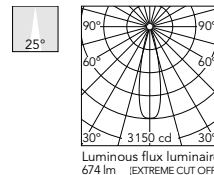

Beam Angle: 25°

h(m)	E(lx)	D(m)
1	3150	0.44
2	788	0.88
3	350	1.32
4	197	1.76
5	126	2.20

Driver current (mA)	2700K		3000K	
	Luminous flux (lm)	Power (W)	Luminous flux (lm)	Power (W)
850	860	10	900	10
800	820	9	860	9
750	770	9	810	9
700	730	8	770	8

Find Me 1 2L

Light Source: Power LED DC 500 mA - 2x6W - 2x560 lm - 2700K/CRI 90 / 2x6W - 2x600 lm - 3000K/CRI 90

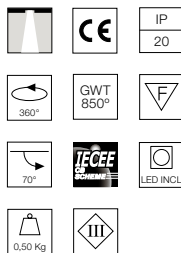
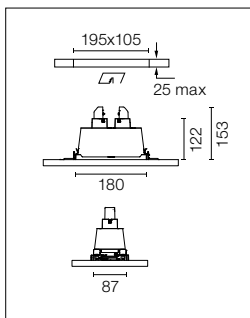

Apparecchio di illuminazione da incasso per interni con due moduli di illuminazione orientabili. Alimentatore remoto 500 mA non compreso. Accessori inclusi (honeycomb e filtro a croce antiabbagliamento).

Recessed luminaire with two adjustable spots for indoor application. Remote power supply 500 mA not included. Accessories included (honeycomb and screening crosspiece).

Alimentazioni raccomandate / Recommended power supply*:

2L Non Dimmable	RF26570
Casambi	60.9207

* Vedi capitolo Drivers / Refer to the Drivers chapter

2700K
09.3706.30C
09.3706.14C

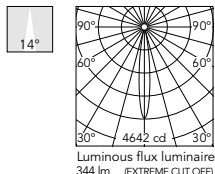

Beam Angle: 14°

h(m)	E(lx)	D(m)
1	4642	0.24
2	1160	0.48
3	516	0.72
4	290	0.95
5	186	1.19

3000K
09.3705.30C
09.3705.14C

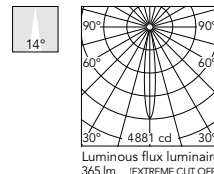

Beam Angle: 14°

h(m)	E(lx)	D(m)
1	4881	0.24
2	1220	0.49
3	542	0.73
4	305	0.97
5	195	1.21

FIND ME

Find Me 1 Suspension

Light Source: Power LED DC 500 mA - 6W - 560 lm - 2700K/CRI 90 / 6W - 600 lm - 3000K/CRI 90

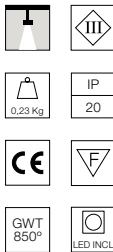
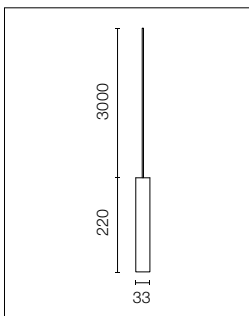

Apparecchio di illuminazione per installazioni a soffitto mediante sospensione. Il prodotto contiene cilindro di schermatura intercambiabile di vari colori (arancione, violetto e nero). Alimentatore remoto 500 mA non compreso.

Suspended ceiling-mounted luminaire. The product includes interchangeable shield cylinder in different colours (orange, violet and black). Remote power supply 500 mA not included.

Alimentazioni raccomandate / Recommended power supply*:
 Non Dimmable 60.8654
 Casambi 60.9207**

* Vedi capitolo Drivers / Refer to the Drivers chapter

** Accesso al driver attraverso lo spazio di incasso / It is necessary to anticipate a space for accessing the driver.

2700K
 09.3711.30C
 09.3711.06C
 09.3711.14C

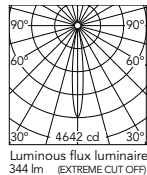

Beam Angle: 14°

3000K
 09.3710.30C
 09.3710.06C
 09.3710.14C

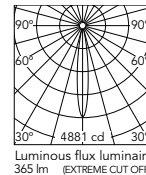

Beam Angle: 14°

Accessori / Accessories

Rosone di alimentazione ad incasso. Recessed power supply rose.



08.8782.30

Rosone di alimentazione a soffitto. Alimentatore non dimmerabile incluso. Surface power supply rose. Non dimmable power supply included.



08.8783.30
 08.8783.06
 08.8783.14

UT SPOT&PRO

DESIGNED BY FLOS ARCHITECTURAL

UT SPOT
CEILING
Ø57



LIGHT SOURCE
LED ARRAY
23,5W
2400 lm
3000K/CRI 80
1950 lm
3000K/CRI 90
2150 lm
4000K/CRI 90

UT SPOT
CEILING
Ø86



LIGHT SOURCE LED ARRAY HIGH PERFORMANCES 33W 3960 lm 3000K/CRI 80 3250 lm 3000K/CRI 90 3500 lm 4000K/CRI 90	LIGHT SOURCE PHOSPHOR LED 31W/34W 3000 lm 3000K/CRI 98 29W 3000 lm 4000K/CRI 80
--	--

UT SPOT
TRACK
Ø57



LIGHT SOURCE
LED ARRAY
23,5W
2500 lm
3000K/CRI 80
2000 lm
3000K/CRI 90
2150 lm
4000K/CRI 90

UT SPOT
TRACK
Ø86



LIGHT SOURCE
LED ARRAY
HIGH
PERFORMANCES
33W
3960 lm
3000K/CRI 80
3250 lm
3000K/CRI 90
3500 lm
4000K/CRI 90

LIGHT SOURCE
PHOSPHOR
LED
27W
3000 lm
3000K/CRI 98
23W
3000 lm
4000K/CRI 80

UT SPOT
TRACK
WALL-WASHER
Ø86



LIGHT SOURCE
LED ARRAY
HIGH
PERFORMANCES
33W
3960 lm
3000K/CRI 80
3250 lm
3000K/CRI 90
3500 lm
4000K/CRI 90

UT SPOT
TRACK
Ø57



LIGHT SOURCE
LED ARRAY
23,5W
2500 lm
3000K/CRI 80
2000 lm
3000K/CRI 90
2150 lm
4000K/CRI 90

UT SPOT
TRACK
Ø86



LIGHT SOURCE
LED ARRAY
HIGH
PERFORMANCES
33W
3770 lm
3000K/CRI 80
3116 lm
3000K/CRI 90
3246 lm
4000K/CRI 90

LIGHT SOURCE
PHOSPHOR
LED
31W/34W
2650 lm
3000K/CRI 98
29W
3000 lm
4000K/CRI 80

UT SPOT
TRACK
MULTICHIP
Ø86



LIGHT SOURCE
TOP LED
11,5W
850 lm
3000K/CRI 90
950 lm
3000K/CRI 80
1000 lm
4000K/CRI 80

UT SPOT
TRACK
WALL-WASHER
Ø86



LIGHT SOURCE
LED ARRAY
HIGH
PERFORMANCES
33W
3960 lm
3000K/CRI 80
3250 lm
3000K/CRI 90
3500 lm
4000K/CRI 90

UT SPOT&PRO

UT PRO
150 GA-69



LIGHT SOURCE
LED ARRAY
23,5W
2300 lm
3000K/CRI 80
1950 lm
3000K/CRI 90
2009 lm
4000K/CRI 90

UT PRO
175 GA-69



LIGHT SOURCE
LED ARRAY
35,3W
4145 lm
3000K/CRI 80
3425 lm
3000K/CRI 90
3569 lm
4000K/CRI 90

UT PRO
175 LENS
GA-69



LIGHT SOURCE
LED ARRAY
35,3W
3950 lm
3000K/CRI 80
3250 lm
3000K/CRI 90
3400 lm
4000K/CRI 90

UT PRO
WALL-WASHER
GA-69



LIGHT SOURCE
TOP LED
25,5W
2700 lm
3000K/CRI 90
2900 lm
4000K/CRI 90

□ 30 Bianco
30 White

■ 14 Nero
14 Black



□ 30 Bianco
30 White

■ 14 Nero
14 Black

□ 30.78 All White
30.78 All White



Descrizione

Apparecchio per interni da installare a binario trifase o a soffitto, disponibile con sorgenti luminose a tecnologia Led di alta potenza e in versione DALI e non DALI.

La famiglia è disponibile in due misure (Ø57 / Ø86) e quattro diverse versioni: Track (totale flessibilità di installazione), Ceiling (installazione stand-alone), Multichip (angoli del fascio di luce inferiori a 150°) e Wall-Washer (solo versione Ø86).

Il corpo ottico dell'apparecchio è in alluminio iniettato ad alta pressione, rifiniti con verniciatura a polvere color bianco o nero.

La versione a soffitto include l'alimentatore remoto. Disponibile anche UT Downlight (vedere la sezione Downlight del catalogo).

Unità di Alimentazione

Alimentatore a corrente continua non regolabile o regolabile Dalì 220-240V compreso.

Con potenziometro incorporato nella versione track con cassetta. Nelle versioni con adattatore integrato non è presente il potenziometro.

Accessori

- Disponibili filtro a croce antiabbagliamento, lente ellittica, lente flood e honeycomb.
- Anello supporto (UT Spot ø86).

Informazioni Aggiuntive

Adatti ad installazioni su superfici normalmente infiammabili.

Gli apparecchi FLOS per binario trifase sono progettati e testati con i binari raccomandati da FLOS. La compatibilità è garantita con i binari prodotti da Nordic Aluminium. Compatibilità con Eutrac su richiesta. Per verificare la compatibilità con altri binari, contattare FLOS prima dell'installazione.

Gli apparecchi FLOS per binario trifase DALI sono progettati in conformità al protocollo Pulse DALI di Nordic Aluminium.

- UT Spot ø86 (Track / Ceiling):

Grazie alla remote-phosphor technology, i moduli LED che montano le versioni Phosphor LED offrono la massima qualità luminosa possibile e la percezione degli oggetti e degli spazi raggiunge indici di riproduzione cromatica pari a 98, a seconda delle versioni.

I moduli LED installati nelle versioni LED Array dispongono dell'ultima generazione tecnologica che consente una minore temperatura media durante il funzionamento dell'elettronica. Grazie a questa caratteristica, l'apparecchio di illuminazione può funzionare all'interno dei parametri di sicurezza a una maggior potenza, offrendo un aumento del 20% del flusso luminoso.

Conformità e Marchi di Qualità

Apparecchio conforme alla Normativa Tecnica Europea EN60598-1 e relative parti seconde.

Description

A luminaire for indoor use to be mounted on three phase track or on ceilings, available in LED technology light sources and in DALI and non-DALI versions.

The family is available in two sizes (Ø57 / Ø86) and in four different versions: Track (totally flexible installation), Ceiling (stand-alone installation), Multichip (beam angles less than 150°) and Wall-Washer (only Ø86 version).

The optical housing of the luminaire is manufactured in high-pressure injected aluminium, with white or black finishes.

Remote driver included in ceiling versions.

Also available UT Downlight (see Downlights catalogue section).

Power Supply

Not dimmable or dimmable Dalì 220-240V, constant current, power supply included.

Includes a built-in potentiometer in the track with box version. Versions with a built-in adapter do not include a potentiometer.

Accessories

- Screening crosspiece, elliptical lens, flood lens and honeycomb.
- Support ring (UT Spot ø86).

Additional Information

Suitable for installation on normally inflammable surfaces. FLOS three-phase lighting track luminaires are designed and fully tested for tracks recommended by FLOS.

Compatibility is guaranteed with three-phase track produced by Nordic Aluminium. Compatibility with Eutrac under request. To verify compatibility with any other track, please contact FLOS before installation.

FLOS three-phase DALI track luminaires are designed for Pulse DALI from Nordic Aluminium.

- UT Spot ø86 (Track / Ceiling):

Thanks to remote-phosphor technology, the LED modules of the Phosphor LED versions offer maximum quality light, the perception of objects and spaces, reaching chromatic reproduction indices of 98, depending on the version.

The LED modules installed on the LED Array versions have cutting-edge technology that permit a lower average temperature in the electronics. Thanks to this feature, the luminaire can operate at a higher power inside the safety parameters, yet still offer 20% added luminous flux.

Standard Compliance and Quality Marks

EN60598-1 European Technical Standards and any subsequent additions.



UT Spot Ceiling



UT Spot Track

UT SPOT

Ut Spot Ceiling Ø57

Light Source: LED Array 23,5W - 2400 lm - 3000K/CRI 80 / 23,5W - 1950 lm - 3000K/CRI 90 / 23,5W - 2150 lm - 4000K/CRI 90

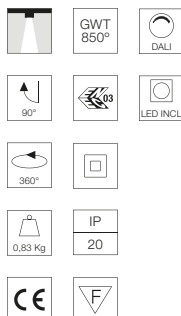
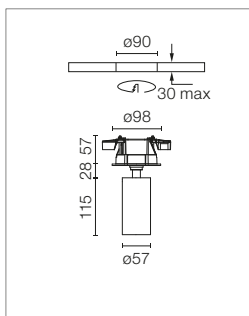

Proiettore per installazione a soffitto con fonte di luce LED. Fonte di alimentazione remota 220-240V, 50-60Hz inclusa.

Spotlight to be installed on ceiling with LED light source. 220-240V, 50-60Hz remote power supply included.

3000K - CRI 80

Non Dimmable

09.4460.30A

09.4460.14A

Dali Version

09.4460.30ADA

09.4460.14ADA

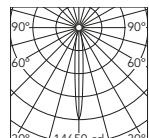

Beam Angle: 10°

h(m)	E(lx)	D(m)
1	14650	0.18
2	3662	0.36
3	1628	0.54
4	916	0.72
5	586	0.90

Luminous flux luminaire
1255 lm

4000K - CRI 90

Non Dimmable

09.4470.30A

09.4470.14A

Dali Version

09.4470.30ADA

09.4470.14ADA

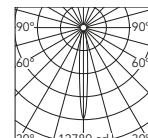

Beam Angle: 10°

h(m)	E(lx)	D(m)
1	12780	0.18
2	3195	0.36
3	1420	0.54
4	799	0.72
5	511	0.90

Luminous flux luminaire
1094 lm

3000K - CRI 90

Non Dimmable

09.4463.30A

09.4463.14A

Dali Version

09.4463.30ADA

09.4463.14ADA

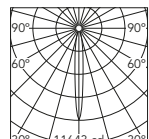

Beam Angle: 10°

h(m)	E(lx)	D(m)
1	11643	0.18
2	2911	0.36
3	1294	0.54
4	728	0.72
5	466	0.90

Luminous flux luminaire
997 lm

3000K - CRI 80

Non Dimmable

09.4461.30A

09.4461.14A

Dali Version

09.4461.30ADA

09.4461.14ADA

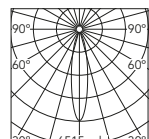

Beam Angle: 21°

h(m)	E(lx)	D(m)
1	6515	0.37
2	1629	0.73
3	724	1.10
4	407	1.47
5	261	1.83

Luminous flux luminaire
1184 lm

4000K - CRI 90

Non Dimmable

09.4471.30A

09.4471.14A

Dali Version

09.4471.30ADA

09.4471.14ADA

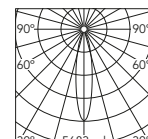

Beam Angle: 21°

h(m)	E(lx)	D(m)
1	5683	0.37
2	1421	0.73
3	631	1.10
4	355	1.47
5	227	1.83

Luminous flux luminaire
1033 lm

3000K - CRI 90

Non Dimmable

09.4464.30A

09.4464.14A

Dali Version

09.4464.30ADA

09.4464.14ADA

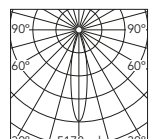

Beam Angle: 21°

h(m)	E(lx)	D(m)
1	5178	0.37
2	1294	0.73
3	575	1.10
4	324	1.47
5	207	1.83

Luminous flux luminaire
941 lm

3000K - CRI 80

Non Dimmable

09.4462.30A

09.4462.14A

Dali Version

09.4462.30ADA

09.4462.14ADA

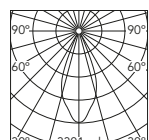

Beam Angle: 42°

h(m)	E(lx)	D(m)
1	3301	0.76
2	825	1.52
3	367	2.28
4	206	3.05
5	132	3.81

Luminous flux luminaire
1394 lm

4000K - CRI 90

Non Dimmable

09.4472.30A

09.4472.14A

Dali Version

09.4472.30ADA

09.4472.14ADA

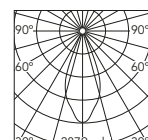

Beam Angle: 42°

h(m)	E(lx)	D(m)
1	2879	0.76
2	720	1.52
3	320	2.28
4	180	3.05
5	115	3.81

Luminous flux luminaire
1216 lm

3000K - CRI 90

Non Dimmable

09.4465.30A

09.4465.14A

Dali Version

09.4465.30ADA

09.4465.14ADA

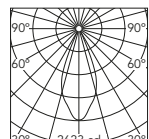

Beam Angle: 42°

h(m)	E(lx)	D(m)
1	2623	0.76
2	656	1.52
3	291	2.28
4	164	3.05
5	105	3.81

Luminous flux luminaire
1108 lm

UT SPOT

Ut Spot Ceiling Ø86

Light Source: LED Array High Performances 33W - 3960 lm - 3000K/CRI 80 / 33W - 3250 lm - 3000K/CRI 90 / 33W - 3500 lm - 4000K/CRI 90

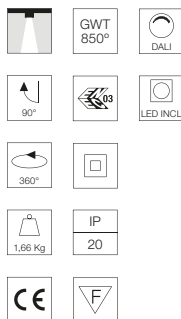
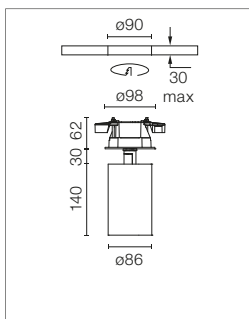

Proiettore per installazione a soffitto con fonte di luce LED. Fonte di alimentazione remota 220-240V, 50-60Hz inclusa.

Spotlight to be installed on ceiling with LED light source. 220-240V, 50-60Hz remote power supply included.

3000K - CRI 80

Non Dimmable

- 09.4860.30A
- 09.4860.14A
- Dali Version
- 09.4860.30ADA
- 09.4860.14ADA

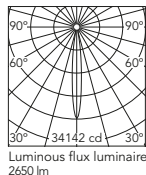

Beam Angle: 12°

h(m)	E(lx)	D(m)
1	34142	0.21
2	8535	0.41
3	3794	0.62
4	2134	0.82
5	1366	1.03

Luminous flux luminaire 2650 lm

4000K - CRI 90

Non Dimmable

- 09.4870.30A
- 09.4870.14A
- Dali Version
- 09.4870.30ADA
- 09.4870.14ADA

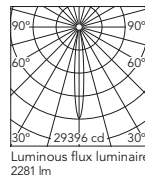

Beam Angle: 12°

h(m)	E(lx)	D(m)
1	29396	0.21
2	7349	0.41
3	3266	0.62
4	1837	0.82
5	1176	1.03

Luminous flux luminaire 2281 lm

3000K - CRI 90

Non Dimmable

- 09.4863.30A
- 09.4863.14A
- Dali Version
- 09.4863.30ADA
- 09.4863.14ADA

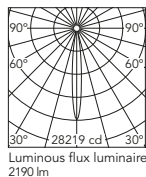

Beam Angle: 12°

h(m)	E(lx)	D(m)
1	28219	0.21
2	7055	0.41
3	3135	0.62
4	1764	0.82
5	1129	1.03

Luminous flux luminaire 2190 lm

3000K - CRI 80

Non Dimmable

- 09.4861.30A
- 09.4861.14A
- Dali Version
- 09.4861.30ADA
- 09.4861.14ADA

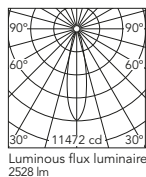

Beam Angle: 24°

h(m)	E(lx)	D(m)
1	11472	0.43
2	2868	0.86
3	1275	1.28
4	717	1.71
5	459	2.14

Luminous flux luminaire 2528 lm

4000K - CRI 90

Non Dimmable

- 09.4871.30A
- 09.4871.14A
- Dali Version
- 09.4871.30ADA
- 09.4871.14ADA

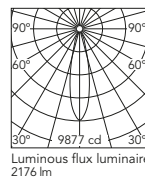

Beam Angle: 24°

h(m)	E(lx)	D(m)
1	9877	0.43
2	2469	0.86
3	1097	1.28
4	617	1.71
5	395	2.14

Luminous flux luminaire 2176 lm

3000K - CRI 90

Non Dimmable

- 09.4864.30A
- 09.4864.14A
- Dali Version
- 09.4864.30ADA
- 09.4864.14ADA

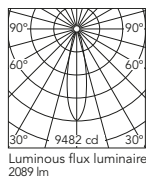

Beam Angle: 24°

h(m)	E(lx)	D(m)
1	9482	0.43
2	2370	0.86
3	1054	1.28
4	593	1.71
5	379	2.14

Luminous flux luminaire 2089 lm

3000K - CRI 80

Non Dimmable

- 09.4862.30A
- 09.4862.14A
- Dali Version
- 09.4862.30ADA
- 09.4862.14ADA

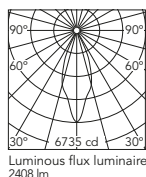

Beam Angle: 37°

h(m)	E(lx)	D(m)
1	6735	0.67
2	1684	1.34
3	748	2.01
4	421	2.69
5	269	3.36

Luminous flux luminaire 2408 lm

4000K - CRI 90

Non Dimmable

- 09.4872.30A
- 09.4872.14A
- Dali Version
- 09.4872.30ADA
- 09.4872.14ADA

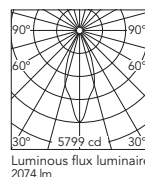

Beam Angle: 37°

h(m)	E(lx)	D(m)
1	5799	0.67
2	1450	1.34
3	644	2.01
4	362	2.69
5	232	3.36

Luminous flux luminaire 2074 lm

3000K - CRI 90

Non Dimmable

- 09.4865.30A
- 09.4865.14A
- Dali Version
- 09.4865.30ADA
- 09.4865.14ADA

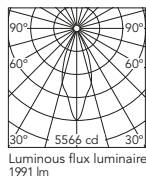

Beam Angle: 37°

h(m)	E(lx)	D(m)
1	5566	0.67
2	1392	1.34
3	618	2.01
4	348	2.69
5	223	3.36

Luminous flux luminaire 1991 lm

UT SPOT

Ut Spot Ceiling Ø86

Light Source: Phosphor LED 31W/34W - 3000 lm - 3000K/CRI 98 / 29W - 3000 lm - 4000K/CRI 80

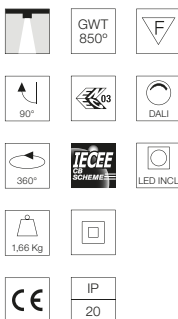
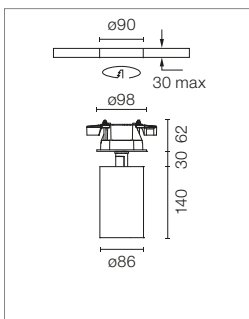

Proiettore per installazione a soffitto con fonte di luce LED. Fonte di alimentazione remota 220-240V, 50-60Hz inclusa.

Spotlight to be installed on ceiling with LED light source. 220-240V, 50-60Hz remote power supply included.

3000K - CRI 98

Non Dimmable

09.4263.30

09.4263.14

Dali Version

09.4263.30.DA

09.4263.14.DA

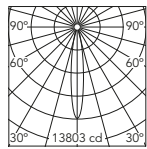

Beam Angle: 16°

h(m)	E(lx)	D(m)
1	13803	0.28
2	3451	0.55
3	1534	0.83
4	863	1.10
5	552	1.38

Luminous flux luminaire 1822 lm

4000K - CRI 80

Non Dimmable

09.4270.30

09.4270.14

Dali Version

09.4270.30.DA

09.4270.14.DA

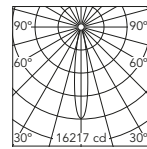

Beam Angle: 17°

h(m)	E(lx)	D(m)
1	16217	0.29
2	4054	0.58
3	1802	0.88
4	1014	1.17
5	649	1.46

Luminous flux luminaire 2216 lm

3000K - CRI 98

Non Dimmable

09.4264.30A

09.4264.14A

Dali Version

09.4264.30ADA

09.4264.14ADA

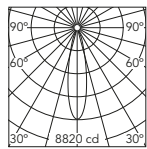

Beam Angle: 23°

h(m)	E(lx)	D(m)
1	8820	0.41
2	2205	0.82
3	980	1.23
4	551	1.64
5	353	2.05

Luminous flux luminaire 1898 lm

4000K - CRI 80

Non Dimmable

09.4271.30A

09.4271.14A

Dali Version

09.4271.30ADA

09.4271.14ADA

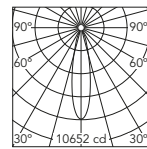

Beam Angle: 23°

h(m)	E(lx)	D(m)
1	10652	0.41
2	2663	0.81
3	1184	1.22
4	666	1.63
5	426	2.03

Luminous flux luminaire 2260 lm

3000K - CRI 98

Non Dimmable

09.4265.30

09.4265.14

Dali Version

09.4265.30.DA

09.4265.14.DA

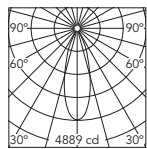

Beam Angle: 32°

h(m)	E(lx)	D(m)
1	4889	0.57
2	1222	1.15
3	543	1.72
4	306	2.29
5	196	2.87

Luminous flux luminaire 1654 lm

4000K - CRI 80

Non Dimmable

09.4272.30

09.4272.14

Dali Version

09.4272.30.DA

09.4272.14.DA

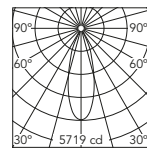

Beam Angle: 32°

h(m)	E(lx)	D(m)
1	5719	0.58
2	1430	1.15
3	635	1.73
4	357	2.31
5	229	2.89

Luminous flux luminaire 1947 lm

UT SPOT

Ut Spot Track Ø57

Light Source: LED Array 23,5W - 2500 lm - 3000K/CRI 80 / 23,5W - 2000 lm - 3000K/CRI 90 / 23,5W- 2150 lm - 4000K/CRI 90

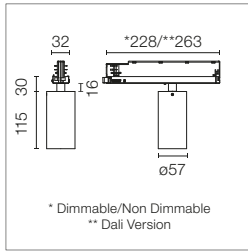

Proiettore per installazione su binario trifase con fonte di luce LED. Fonte di alimentazione 220-240V, 50-60Hz integrata.

Spotlight to be installed on 3-phase track with LED light source. 220-240V, 50-60Hz power supply integrated.

Le versioni .30 hanno l'adattatore a guida, il braccio e la parte posteriore della testa neri. Nelle versioni "all white" l'adattatore a guida, il braccio e la parte posteriore della testa sono bianchi, e solo l'anello antiabbagliamento è nero.

.30 versions come with the track adapter, the arm and the rear of the head in black. In the "All white" versions, the track adapter, the arm, the rear of the head and the head are white. Only the anti-glare ring is black.

3000K - CRI 80

- Non Dimmable
- 09.7700.30A
- 09.7700.14A
- Non Dimmable All White
- 09.7700.30A78
- Dali Version
- 09.7700.30ADA
- 09.7700.14ADA
- Dali Version All White
- 09.7700.30AYU

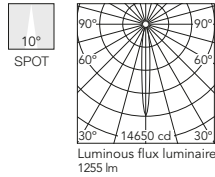

Beam Angle: 10°

h(m)	E(lx)	D(m)
1	14650	0.18
2	3662	0.36
3	1628	0.54
4	916	0.72
5	586	0.90

4000K - CRI 90

- Non Dimmable
- 09.7701.30A
- 09.7701.14A
- Non Dimmable All White
- 09.7701.30A78
- Dali Version
- 09.7701.30ADA
- 09.7701.14ADA
- Dali Version All White
- 09.7701.30AYU

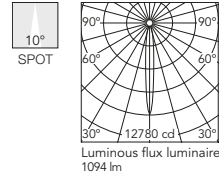

Beam Angle: 10°

h(m)	E(lx)	D(m)
1	12780	0.18
2	3195	0.36
3	1420	0.54
4	799	0.72
5	511	0.90

3000K - CRI 90

- Non Dimmable
- 09.7706.30A
- 09.7706.14A
- Non Dimmable All White
- 09.7706.30A78
- Dali Version
- 09.7706.30ADA
- 09.7706.14ADA
- Dali Version All White
- 09.7706.30AYU

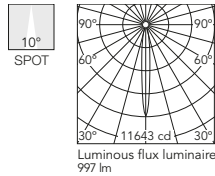

Beam Angle: 10°

h(m)	E(lx)	D(m)
1	11643	0.18
2	2911	0.36
3	1294	0.54
4	728	0.72
5	466	0.90

4000K - CRI 90

- Non Dimmable
- 09.7703.30A
- 09.7703.14A
- Non Dimmable All White
- 09.7703.30A78
- Dali Version
- 09.7703.30ADA
- 09.7703.14ADA
- Dali Version All White
- 09.7703.30AYU

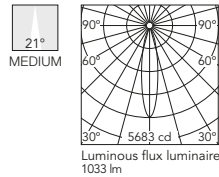

Beam Angle: 21°

h(m)	E(lx)	D(m)
1	5683	0.37
2	1421	0.73
3	631	1.10
4	407	1.47
5	261	1.83

3000K - CRI 80

- Non Dimmable
- 09.7702.30A
- 09.7702.14A
- Non Dimmable All White
- 09.7702.30A78
- Dali Version
- 09.7702.30ADA
- 09.7702.14ADA
- Dali Version All White
- 09.7702.30AYU

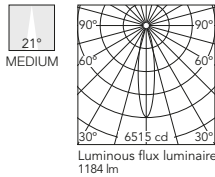

Beam Angle: 21°

h(m)	E(lx)	D(m)
1	6515	0.37
2	1629	0.73
3	724	1.10
4	407	1.47
5	261	1.83

3000K - CRI 90

- Non Dimmable
- 09.7707.30A
- 09.7707.14A
- Non Dimmable All White
- 09.7707.30A78
- Dali Version
- 09.7707.30ADA
- 09.7707.14ADA
- Dali Version All White
- 09.7707.30AYU

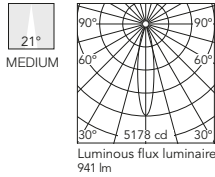

Beam Angle: 21°

h(m)	E(lx)	D(m)
1	5178	0.37
2	1294	0.73
3	575	1.10
4	324	1.47
5	207	1.83

3000K - CRI 80

- Non Dimmable
- 09.7704.30A
- 09.7704.14A
- Non Dimmable All White
- 09.7704.30A78
- Dali Version
- 09.7704.30ADA
- 09.7704.14ADA
- Dali Version All White
- 09.7704.30AYU

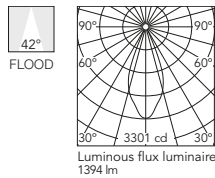

Beam Angle: 42°

h(m)	E(lx)	D(m)
1	3301	0.76
2	825	1.52
3	367	2.28
4	206	3.05
5	132	3.81

4000K - CRI 90

- Non Dimmable
- 09.7705.30A
- 09.7705.14A
- Non Dimmable All White
- 09.7705.30A78
- Dali Version
- 09.7705.30ADA
- 09.7705.14ADA
- Dali Version All White
- 09.7705.30AYU

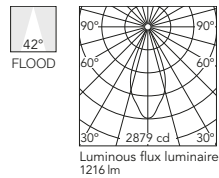

Beam Angle: 42°

h(m)	E(lx)	D(m)
1	2879	0.76
2	720	1.52
3	320	2.28
4	180	3.05
5	115	3.81

3000K - CRI 90

- Non Dimmable
- 09.7708.30A
- 09.7708.14A
- Non Dimmable All White
- 09.7708.30A78
- Dali Version
- 09.7708.30ADA
- 09.7708.14ADA
- Dali Version All White
- 09.7708.30AYU

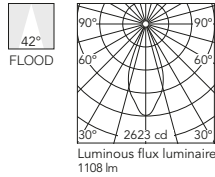

Beam Angle: 42°

h(m)	E(lx)	D(m)
1	2623	0.76
2	656	1.52
3	291	2.28
4	164	3.05
5	105	3.81

UT SPOT

Ut Spot Track Ø86

Light Source: LED Array High Performances 33W - 3770 lm - 3000K/CRI 80 / 33W - 3116 lm - 3000K/CRI 90 / 33W - 3246 lm - 4000K/CRI 90

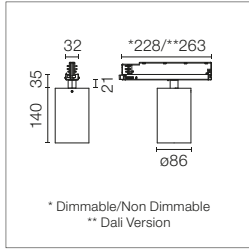

Proiettore per installazione su binario trifase con fonte di luce LED. Fonte di alimentazione 220-240V, 50-60Hz integrata.

Spotlight to be installed on 3-phase track with LED light source. 220-240V, 50-60Hz power supply integrated.

Le versioni .30 hanno l'adattatore a guida, il braccio e la parte posteriore della testa neri. Nelle versioni "all white" l'adattatore a guida, il braccio e la parte posteriore della testa sono bianchi, e solo l'anello antiabbagliamento è nero.

.30 versions come with the track adapter, the arm and the rear of the head in black. In the "All white" versions, the track adapter, the arm, the rear of the head and the head are white. Only the anti-glare ring is black.

3000K - CRI 80

- Non Dimmable
- 09.7750.30A
- 09.7750.14A
- Non Dimmable All White
- 09.7750.30A78
- Dali Version
- 09.7750.30ADA
- 09.7750.14ADA
- Dali Version All White
- 09.7750.30AYU

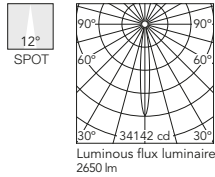

Beam Angle: 12°

h(m)	E(lx)	D(m)
1	34142	0.21
2	8535	0.41
3	3794	0.62
4	2134	0.82
5	1366	1.03

Luminous flux luminaire 2650 lm

4000K - CRI 90

- Non Dimmable
- 09.7751.30A
- 09.7751.14A
- Non Dimmable All White
- 09.7751.30A78
- Dali Version
- 09.7751.30ADA
- 09.7751.14ADA
- Dali Version All White
- 09.7751.30AYU

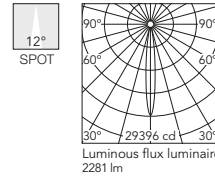

Beam Angle: 12°

h(m)	E(lx)	D(m)
1	29396	0.21
2	7349	0.41
3	3266	0.62
4	1837	0.82
5	1176	1.03

Luminous flux luminaire 2281 lm

3000K - CRI 90

- Non Dimmable
- 09.7756.30A
- 09.7756.14A
- Non Dimmable All White
- 09.7756.30A78
- Dali Version
- 09.7756.30ADA
- 09.7756.14ADA
- Dali Version All White
- 09.7756.30AYU

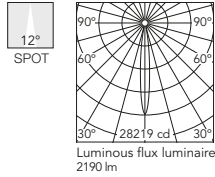

Beam Angle: 12°

h(m)	E(lx)	D(m)
1	28219	0.21
2	7055	0.41
3	3135	0.62
4	1764	0.82
5	1129	1.03

Luminous flux luminaire 2190 lm

4000K - CRI 90

- Non Dimmable
- 09.7753.30A
- 09.7753.14A
- Non Dimmable All White
- 09.7753.30A78
- Dali Version
- 09.7753.30ADA
- 09.7753.14ADA
- Dali Version All White
- 09.7753.30AYU

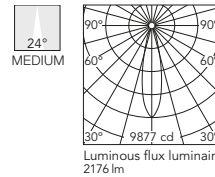

Beam Angle: 24°

h(m)	E(lx)	D(m)
1	9877	0.43
2	2469	0.86
3	1097	1.28
4	617	1.71
5	395	2.14

Luminous flux luminaire 2176 lm

3000K - CRI 80

- Non Dimmable
- 09.7752.30A
- 09.7752.14A
- Non Dimmable All White
- 09.7752.30A78
- Dali Version
- 09.7752.30ADA
- 09.7752.14ADA
- Dali Version All White
- 09.7752.30AYU

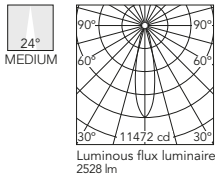

Beam Angle: 24°

h(m)	E(lx)	D(m)
1	11472	0.43
2	2868	0.86
3	1275	1.28
4	717	1.71
5	459	2.14

Luminous flux luminaire 2528 lm

3000K - CRI 90

- Non Dimmable
- 09.7757.30A
- 09.7757.14A
- Non Dimmable All White
- 09.7757.30A78
- Dali Version
- 09.7757.30ADA
- 09.7757.14ADA
- Dali Version All White
- 09.7757.30AYU

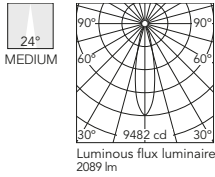

Beam Angle: 24°

h(m)	E(lx)	D(m)
1	9482	0.43
2	2370	0.86
3	1054	1.28
4	593	1.71
5	379	2.14

Luminous flux luminaire 2089 lm

4000K - CRI 90

- Non Dimmable
- 09.7755.30A
- 09.7755.14A
- Non Dimmable All White
- 09.7755.30A78
- Dali Version
- 09.7755.30ADA
- 09.7755.14ADA
- Dali Version All White
- 09.7755.30AYU

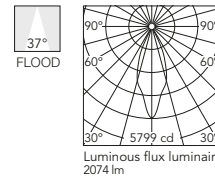

Beam Angle: 37°

h(m)	E(lx)	D(m)
1	5799	0.67
2	1450	1.34
3	644	2.01
4	362	2.69
5	232	3.36

Luminous flux luminaire 2074 lm

3000K - CRI 80

- Non Dimmable
- 09.7754.30A
- 09.7754.14A
- Non Dimmable All White
- 09.7754.30A78
- Dali Version
- 09.7754.30ADA
- 09.7754.14ADA
- Dali Version All White
- 09.7754.30AYU

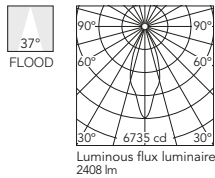

Beam Angle: 37°

h(m)	E(lx)	D(m)
1	6735	0.67
2	1684	1.34
3	748	2.01
4	421	2.69
5	269	3.36

Luminous flux luminaire 2408 lm

3000K - CRI 90

- Non Dimmable
- 09.7758.30A
- 09.7758.14A
- Non Dimmable All White
- 09.7758.30A78
- Dali Version
- 09.7758.30ADA
- 09.7758.14ADA
- Dali Version All White
- 09.7758.30AYU

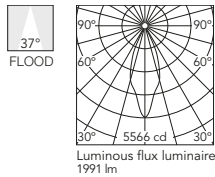

Beam Angle: 37°

h(m)	E(lx)	D(m)
1	5566	0.67
2	1392	1.34
3	618	2.01
4	348	2.69
5	223	3.36

Luminous flux luminaire 1991 lm

UT SPOT

Ut Spot Track Ø86

Light Source: Phosphor LED 27W - 3000 lm - 3000K/CRI 98 / 23W - 3000 lm - 4000K/CRI 80

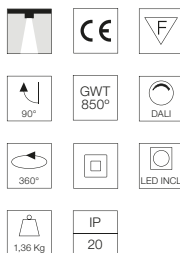
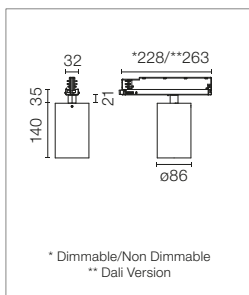

Priorettore per installazione su binario trifase con fonte di luce LED. Fonte di alimentazione 220-240V, 50-60Hz integrata.

Spotlight to be installed on 3-phase track with LED light source. 220-240V, 50-60Hz power supply integrated.

Le versioni .30 hanno l'adattatore a guida, il braccio e la parte posteriore della testa neri. Nelle versioni "all white" l'adattatore a guida, il braccio e la parte posteriore della testa sono bianchi, e solo l'anello antiabbagliamento è nero.

.30 versions come with the track adapter, the arm and the rear of the head in black. In the "All white" versions, the track adapter, the arm, the rear of the head and the head are white. Only the anti-glare ring is black.

Finishes Available



3000K - CRI 98

Non Dimmable

- 09.7733.30
- 09.7733.14
- All White
- 09.7733.30.78

Dali Version

- 09.7733.30.DA
- 09.7733.14.DA
- All White
- 09.7733.30.YU

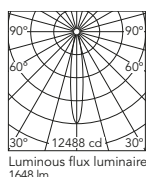

h(m)	E(lx)	D(m)
1	12488	0.28
2	3122	0.55
3	1388	0.83
4	781	1.10
5	500	1.38

4000K - CRI 80

Non Dimmable

- 09.7730.30
- 09.7730.14
- All White
- 09.7730.30.78

Dali Version

- 09.7730.30.DA
- 09.7730.14.DA
- All White
- 09.7730.30.YU

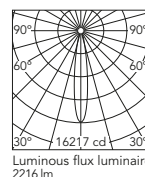

h(m)	E(lx)	D(m)
1	16217	0.29
2	4054	0.58
3	1802	0.88
4	1014	1.17
5	649	1.46

3000K - CRI 98

Non Dimmable

- 09.7734.30A
- 09.7734.14A
- All White
- 09.7734.30A78

Dali Version

- 09.7734.30ADA
- 09.7734.14ADA
- All White
- 09.7734.30AYU

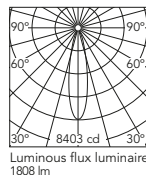

h(m)	E(lx)	D(m)
1	8403	0.41
2	2101	0.82
3	934	1.23
4	525	1.64
5	336	2.05

4000K - CRI 80

Non Dimmable

- 09.7731.30A
- 09.7731.14A
- All White
- 09.7731.30A78

Dali Version

- 09.7731.30ADA
- 09.7731.14ADA
- All White
- 09.7731.30AYU

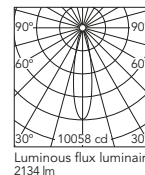

h(m)	E(lx)	D(m)
1	10058	0.41
2	2514	0.81
3	1118	1.22
4	629	1.63
5	402	2.03

3000K - CRI 98

Non Dimmable

- 09.7735.30
- 09.7735.14
- All White
- 09.7735.30.78

Dali Version

- 09.7735.30.DA
- 09.7735.14.DA
- All White
- 09.7735.30.YU

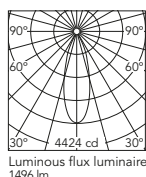

h(m)	E(lx)	D(m)
1	4424	0.57
2	1106	1.15
3	492	1.72
4	276	2.29
5	177	2.87

4000K - CRI 80

Non Dimmable

- 09.7732.30
- 09.7732.14
- All White
- 09.7732.30.78

Dali Version

- 09.7732.30.DA
- 09.7732.14.DA
- All White
- 09.7732.30.YU

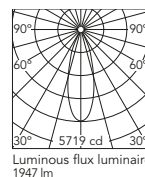

h(m)	E(lx)	D(m)
1	5719	0.58
2	1430	1.15
3	635	1.73
4	357	2.31
5	229	2.89

UT SPOT

Ut Spot Track Wall-Washer Ø86

Light Source: LED Array High Performances 33W - 3960 lm - 3000K/CRI 80 / 33W - 3250 lm - 3000K/CRI 90 / 33W - 3500 lm - 4000K/CRI 90

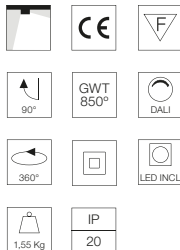
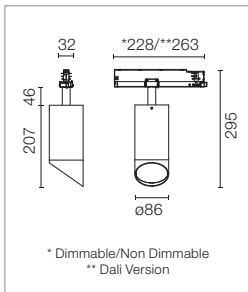

Proiettore per installazione su binario trifase con fonte di luce LED. Fonte di alimentazione 220-240V, 50-60Hz integrata.

Spotlight to be installed on 3-phase track with LED light source. 220-240V, 50-60Hz power supply integrated.

Le versioni .30 hanno l'adattatore a guida, il braccio e la parte posteriore della testa neri. Nelle versioni "all white" l'adattatore a guida, il braccio e la parte posteriore della testa sono bianchi, e solo l'anello antiabbagliamento è nero.

.30 versions come with the track adapter, the arm and the rear of the head in black. In the "All white" versions, the track adapter, the arm, the rear of the head and the head are white. Only the anti-glare ring is black.

Finishes Available



3000K - CRI 80

Non Dimmable

- 09.7770.30A
- 09.7770.14A

All White

- 09.7770.30A78

Dali Version

- 09.7770.30ADA
- 09.7770.14ADA

Dali Version All White

- 09.7770.30AYU

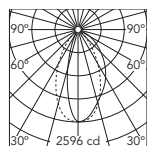

Beam Angle: 50°

h(m)	E(lx)	D(m)
1	2596	0.98
2	649	1.97
3	288	2.95
4	162	3.94
5	104	4.92

Luminous flux luminaire 2560 lm

4000K - CRI 90

Non Dimmable

- 09.7772.30A
- 09.7772.14A

All White

- 09.7772.30A78

Dali Version

- 09.7772.30ADA
- 09.7772.14ADA

Dali Version All White

- 09.7772.30AYU

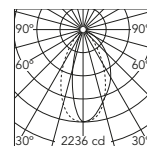

Beam Angle: 50°

h(m)	E(lx)	D(m)
1	2236	0.98
2	559	1.97
3	248	2.95
4	140	3.94
5	89	4.92

Luminous flux luminaire 2204 lm

3000K - CRI 90

Non Dimmable

- 09.7771.30A
- 09.7771.14A

All White

- 09.7771.30A78

Dali Version

- 09.7771.30ADA
- 09.7771.14ADA

Dali Version All White

- 09.7771.30AYU

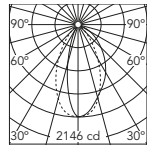

Beam Angle: 50°

h(m)	E(lx)	D(m)
1	2146	0.98
2	537	1.97
3	238	2.95
4	134	3.94
5	86	4.92

Luminous flux luminaire 2116 lm

UT SPOT

Ut Spot Track Ø57

Light Source: LED Array 23,5W - 2500 lm - 3000K/CRI 80 / 23,5W - 2000 lm - 3000K/CRI 90 / 23,5W - 2150 lm - 4000K/CRI 90

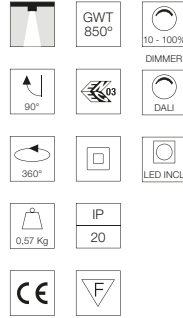
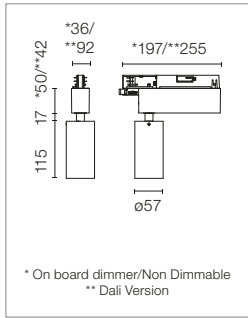

Proiettore per installazione su binario trifase con fonte di luce LED. Fonte di alimentazione 220-240V, 50-60Hz integrata.

Spotlight to be installed on 3-phase track with LED light source. 220-240V, 50-60Hz power supply integrated.

3000K - CRI 80

On board dimmer

09.4440.30A

09.4440.14A

Non Dimmable

09.4480.30A

09.4480.14A

Dali Version

09.4440.30ADA

09.4440.14ADA

3000K - CRI 90

On board dimmer

09.4443.30A

09.4443.14A

Non Dimmable

09.4486.30A

09.4486.14A

Dali Version

09.4443.30ADA

09.4443.14ADA

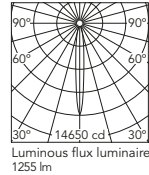

Beam Angle: 10°

h(m)	E(lx)	D(m)
1	14650	0.18
2	3662	0.36
3	1628	0.54
4	916	0.72
5	586	0.90

4000K - CRI 90

On board dimmer included

09.4450.30A

09.4450.14A

Non Dimmable

09.4481.30A

09.4481.14A

Dali Version

09.4450.30ADA

09.4450.14ADA

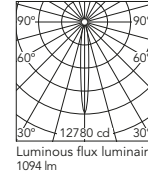

Beam Angle: 10°

h(m)	E(lx)	D(m)
1	12780	0.18
2	3195	0.36
3	1420	0.54
4	799	0.72
5	511	0.90

3000K - CRI 80

On board dimmer

09.4441.30A

09.4441.14A

Non Dimmable

09.4482.30A

09.4482.14A

Dali Version

09.4441.30ADA

09.4441.14ADA

3000K - CRI 90

On board dimmer

09.4444.30A

09.4444.14A

Non Dimmable

09.4487.30A

09.4487.14A

Dali Version

09.4444.30ADA

09.4444.14ADA

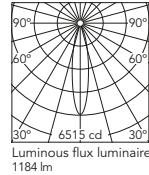

Beam Angle: 21°

h(m)	E(lx)	D(m)
1	6515	0.37
2	1629	0.73
3	724	1.10
4	407	1.47
5	261	1.83

4000K - CRI 90

On board dimmer included

09.4451.30A

09.4451.14A

Non Dimmable

09.4483.30A

09.4483.14A

Dali Version

09.4451.30ADA

09.4451.14ADA

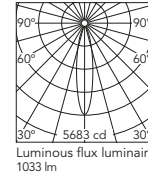

Beam Angle: 21°

h(m)	E(lx)	D(m)
1	5683	0.37
2	1421	0.73
3	631	1.10
4	355	1.47
5	227	1.83

3000K - CRI 80

On board dimmer

09.4442.30A

09.4442.14A

Non Dimmable

09.4484.30A

09.4484.14A

Dali Version

09.4442.30ADA

09.4442.14ADA

3000K - CRI 90

On board dimmer

09.4445.30A

09.4445.14A

Non Dimmable

09.4488.30A

09.4488.14A

Dali Version

09.4445.30ADA

09.4445.14ADA

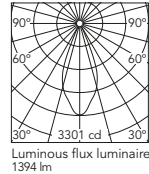

Beam Angle: 42°

h(m)	E(lx)	D(m)
1	3301	0.76
2	825	1.52
3	367	2.28
4	206	3.05
5	132	3.81

4000K - CRI 90

On board dimmer included

09.4452.30A

09.4452.14A

Non Dimmable

09.4485.30A

09.4485.14A

Dali Version

09.4452.30ADA

09.4452.14ADA

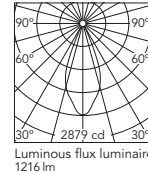

Beam Angle: 42°

h(m)	E(lx)	D(m)
1	2879	0.76
2	720	1.52
3	320	2.28
4	180	3.05
5	115	3.81

UT SPOT

Ut Spot Track Ø86

Light Source: LED Array High Performances 33W - 3770 lm - 3000K/CRI 80 / 33W - 3116 lm - 3000K/CRI 90 / 33W - 3246 lm - 4000K/CRI 90

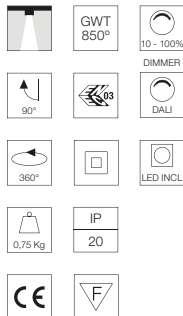
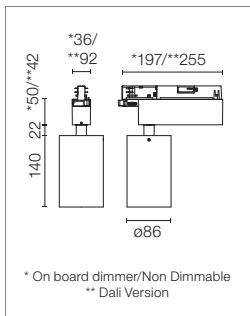

Proiettore per installazione su binario trifase con fonte di luce LED. Fonte di alimentazione 220-240V, 50-60Hz integrata.

Spotlight to be installed on 3-phase track with LED light source. 220-240V, 50-60Hz power supply integrated.

3000K - CRI 80

On board dimmer

09.4840.30A

09.4840.14A

Non Dimmable

09.4880.30A

09.4880.14A

Dali Version

09.4840.30ADA

09.4840.14ADA

3000K - CRI 90

On board dimmer

09.4843.30A

09.4843.14A

Non Dimmable

09.4886.30A

09.4886.14A

Dali Version

09.4843.30ADA

09.4843.14ADA

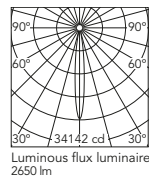

Beam Angle: 12°

h(m)	E(lx)	D(m)
1	34142	0.21
2	8535	0.41
3	3794	0.62
4	2134	0.82
5	1366	1.03

Luminous flux luminaire 2650 lm

4000K - CRI 90

On board dimmer included

09.4850.30A

09.4850.14A

Non Dimmable

09.4881.30A

09.4881.14A

Dali Version

09.4850.30ADA

09.4850.14ADA

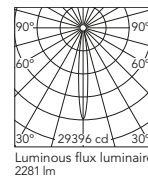

Beam Angle: 12°

h(m)	E(lx)	D(m)
1	29396	0.21
2	7349	0.41
3	3266	0.62
4	1837	0.82
5	1176	1.03

Luminous flux luminaire 2281 lm

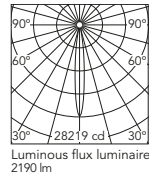

Beam Angle: 12°

h(m)	E(lx)	D(m)
1	28219	0.21
2	7055	0.41
3	3135	0.62
4	1764	0.82
5	1129	1.03

Luminous flux luminaire 2190 lm

3000K - CRI 80

On board dimmer

09.4841.30A

09.4841.14A

Non Dimmable

09.4882.30A

09.4882.14A

Dali Version

09.4841.30ADA

09.4841.14ADA

3000K - CRI 90

On board dimmer

09.4844.30A

09.4844.14A

Non Dimmable

09.4887.30A

09.4887.14A

Dali Version

09.4844.30ADA

09.4844.14ADA

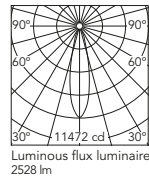

Beam Angle: 24°

h(m)	E(lx)	D(m)
1	11472	0.43
2	2868	0.86
3	1275	1.28
4	717	1.71
5	459	2.14

Luminous flux luminaire 2528 lm

4000K - CRI 90

On board dimmer included

09.4851.30A

09.4851.14A

Non Dimmable

09.4883.30A

09.4883.14A

Dali Version

09.4851.30ADA

09.4851.14ADA

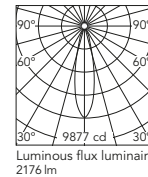

Beam Angle: 24°

h(m)	E(lx)	D(m)
1	9877	0.43
2	2469	0.86
3	1097	1.28
4	617	1.71
5	395	2.14

Luminous flux luminaire 2176 lm

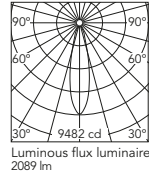

Beam Angle: 24°

h(m)	E(lx)	D(m)
1	9482	0.43
2	2370	0.86
3	1054	1.28
4	593	1.71
5	379	2.14

Luminous flux luminaire 2089 lm

3000K - CRI 80

On board dimmer

09.4842.30A

09.4842.14A

Non Dimmable

09.4884.30A

09.4884.14A

Dali Version

09.4842.30ADA

09.4842.14ADA

3000K - CRI 90

On board dimmer

09.4845.30A

09.4845.14A

Non Dimmable

09.4888.30A

09.4888.14A

Dali Version

09.4845.30ADA

09.4845.14ADA

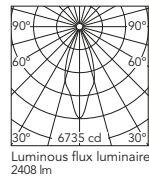

Beam Angle: 37°

h(m)	E(lx)	D(m)
1	6735	0.67
2	1684	1.34
3	748	2.01
4	421	2.69
5	269	3.36

Luminous flux luminaire 2408 lm

4000K - CRI 90

On board dimmer included

09.4852.30A

09.4852.14A

Non Dimmable

09.4885.30A

09.4885.14A

Dali Version

09.4852.30ADA

09.4852.14ADA

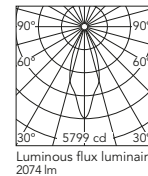

Beam Angle: 37°

h(m)	E(lx)	D(m)
1	5799	0.67
2	1450	1.34
3	644	2.01
4	362	2.69
5	232	3.36

Luminous flux luminaire 2074 lm

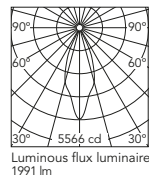

Beam Angle: 37°

h(m)	E(lx)	D(m)
1	5566	0.67
2	1392	1.34
3	618	2.01
4	348	2.69
5	223	3.36

Luminous flux luminaire 1991 lm

UT SPOT

Ut Spot Track Ø86

Light Source: Phosphor LED 31W/34W - 2650 lm - 3000K/CRI 98 / 29W - 3000 lm - 4000K/CRI 80

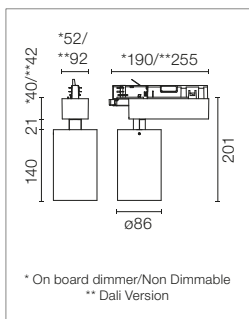

- GWT 850°
- 90°
- 360°
- 1,36 Kg
- CE
- IP 20
- 83
- DIMMER 10 - 100%
- DALI
- LED INCL

Proiettore per installazione su binario trifase con fonte di luce LED. Fonte di alimentazione 220-240V, 50-60Hz integrata.

Spotlight to be installed on 3-phase track with LED light source. 220-240V, 50-60Hz power supply integrated.

3000K - CRI 98

On board dimmer

09.4243.30

09.4243.14

Non Dimmable

09.4286.30

09.4286.14

Dali Version

09.4243.30.DA

09.4243.14.DA

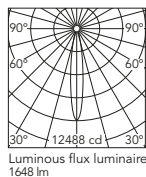

Beam Angle: 16°

h(m)	E(lx)	D(m)
1	12488	0.28
2	3122	0.55
3	1388	0.83
4	781	1.10
5	500	1.38

Luminous flux luminaire 1648 lm

4000K - CRI 80

On board dimmer

09.4250.30

09.4250.14

Non Dimmable

09.4281.30

09.4281.14

Dali Version

09.4250.30.DA

09.4250.14.DA

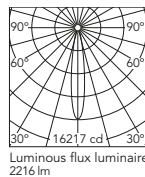

Beam Angle: 17°

h(m)	E(lx)	D(m)
1	16217	0.29
2	4054	0.58
3	1802	0.88
4	1014	1.17
5	649	1.46

Luminous flux luminaire 2216 lm

3000K - CRI 98

On board dimmer

09.4244.30A

09.4244.14A

Non Dimmable

09.4287.30A

09.4287.14A

Dali Version

09.4244.30ADA

09.4244.14ADA

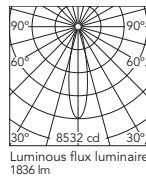

Beam Angle: 23°

h(m)	E(lx)	D(m)
1	8532	0.41
2	2133	0.82
3	948	1.23
4	533	1.64
5	341	2.05

Luminous flux luminaire 1836 lm

4000K - CRI 80

On board dimmer

09.4251.30A

09.4251.14A

Non Dimmable

09.4283.30A

09.4283.14A

Dali Version

09.4251.30ADA

09.4251.14ADA

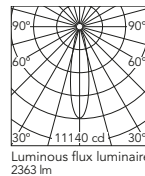

Beam Angle: 23°

h(m)	E(lx)	D(m)
1	11140	0.41
2	2785	0.81
3	1238	1.22
4	696	1.63
5	446	2.03

Luminous flux luminaire 2363 lm

3000K - CRI 98

On board dimmer

09.4245.30

09.4245.14

Non Dimmable

09.4288.30

09.4288.14

Dali Version

09.4245.30.DA

09.4245.14.DA

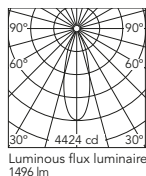

Beam Angle: 32°

h(m)	E(lx)	D(m)
1	4424	0.57
2	1106	1.15
3	492	1.72
4	276	2.29
5	177	2.87

Luminous flux luminaire 1496 lm

4000K - CRI 80

On board dimmer

09.4252.30

09.4252.14

Non Dimmable

09.4285.30

09.4285.14

Dali Version

09.4252.30.DA

09.4252.14.DA

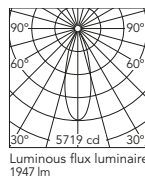

Beam Angle: 32°

h(m)	E(lx)	D(m)
1	5719	0.58
2	1430	1.15
3	635	1.73
4	357	2.31
5	229	2.89

Luminous flux luminaire 1947 lm

UT SPOT

Ut Spot Track Multichip Ø86

Light Source: Top LED 11,5W - 850 lm - 3000K/CRI 90 / 11,5W - 950 lm - 3000K/CRI 80 / 11,5W - 1000 lm - 4000K/CRI 80

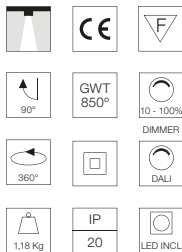
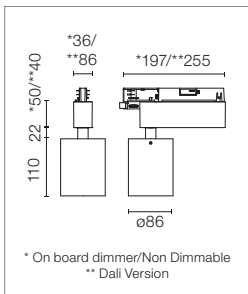

Proiettore per installazione su binario trifase con fonte di luce LED. Fonte di alimentazione 220-240V, 50-60Hz integrata.

Spotlight to be installed on 3-phase track with LED light source. 220-240V, 50-60Hz power supply integrated.

Gli accessori non sono compatibili con questa versione.

The accessories are not compatible with this version.

3000K - CRI 80

On board dimmer

- 09.4980.30
- 09.4980.14

Non Dimmable

- 09.4983.30
- 09.4983.14

Dali Version

- 09.4980.30.DA
- 09.4980.14.DA

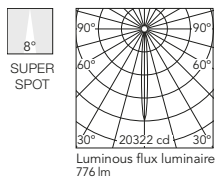

h(m)	E(lx)	D(m)
1	20322	0.14
2	5081	0.27
3	2258	0.41
4	1270	0.54
5	813	0.68

4000K - CRI 80

On board dimmer

- 09.4982.30
- 09.4982.14

Non Dimmable

- 09.4985.30
- 09.4985.14

Dali Version

- 09.4982.30.DA
- 09.4982.14.DA

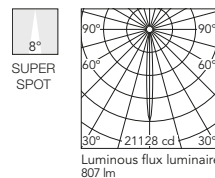

h(m)	E(lx)	D(m)
1	21128	0.14
2	5282	0.27
3	2348	0.41
4	1321	0.54
5	845	0.68

3000K - CRI 90

On board dimmer

- 09.4981.30
- 09.4981.14

Non Dimmable

- 09.4984.30
- 09.4984.14

Dali Version

- 09.4981.30.DA
- 09.4981.14.DA

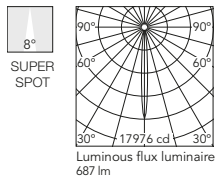

h(m)	E(lx)	D(m)
1	17976	0.14
2	4494	0.27
3	1997	0.41
4	1124	0.54
5	719	0.68

Ut Spot Track Wall-Washer Ø86

Light Source: LED Array High Performances 33W - 3960 lm - 3000K/CRI 80 / 33W - 3250 lm - 3000K/CRI 90 / 33W - 3500 lm - 4000K/CRI 90

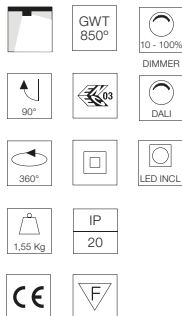
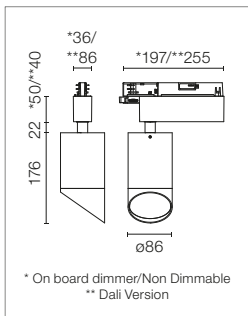

Proiettore per installazione su binario trifase con fonte di luce LED. Fonte di alimentazione 220-240V, 50-60Hz integrata.

Spotlight to be installed on 3-phase track with LED light source. 220-240V, 50-60Hz power supply integrated.

3000K - CRI 80

On board dimmer

- 09.4950.30A
- 09.4950.14A

Non Dimmable

- 09.4951.30A
- 09.4951.14A

Dali Version

- 09.4950.30ADA
- 09.4950.14ADA

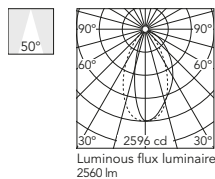

h(m)	E(lx)	D(m)
1	2596	0.98
2	649	1.97
3	288	2.95
4	162	3.94
5	104	4.92

4000K - CRI 90

On board dimmer

- 09.4956.30A
- 09.4956.14A

Non Dimmable

- 09.4957.30A
- 09.4957.14A

Dali Version

- 09.4956.30ADA
- 09.4956.14ADA

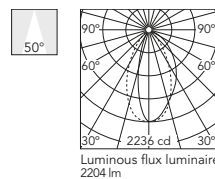

h(m)	E(lx)	D(m)
1	2236	0.98
2	559	1.97
3	248	2.95
4	140	3.94
5	89	4.92

3000K - CRI 90

On board dimmer

- 09.4953.30A
- 09.4953.14A

Non Dimmable

- 09.4954.30A
- 09.4954.14A

Dali Version

- 09.4953.30ADA
- 09.4953.14ADA

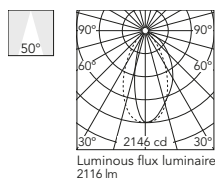

h(m)	E(lx)	D(m)
1	2146	0.98
2	537	1.97
3	238	2.95
4	134	3.94
5	86	4.92

UT PRO

UT Pro 150 GA-69

Light Source: LED Array 23,5W - 2300 lm - 3000K/CRI 80 / 23,5W - 1950 lm - 3000K/CRI 90 / 23,5W - 2009 lm - 4000K/CRI 90

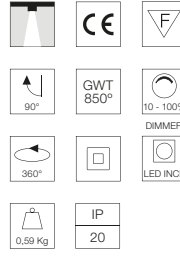
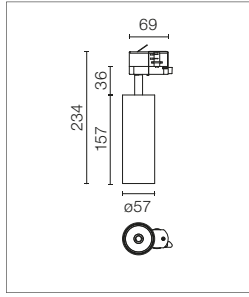

Proiettore per installazione su guida trifase standard con fonte di luce LED. Fonte di alimentazione 120-270V integrata.

Spotlight to be installed in standard 3-phase track with LED light source. 120-270V power supply integrated.

Le versioni .40 hanno l'adattatore a guida, il braccio e la parte posteriore della testa neri. Nelle versioni "all white" l'adattatore a guida, il braccio e la parte posteriore della testa sono bianchi, e solo l'anello antiabbagliamento è nero.

.40 versions come with the track adapter, the arm and the rear of the head in black. In the "All white" versions, the track adapter, the arm, the rear of the head and the head are white. Only the anti-glare ring is black.

Finishes Available



- 3000K - CRI 80**
On board dimmer
 09.7270.40A
 09.7270.14A
 All White
 09.7270.40A78

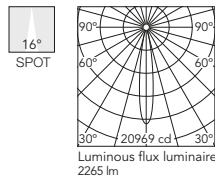

Beam Angle: 16°

h(m)	E(lx)	D(m)
1	20969	0.28
2	5242	0.56
3	2330	0.84
4	1311	1.12
5	839	1.40

- 3000K - CRI 90**
On board dimmer
 09.7276.40A
 09.7276.14A
 All White
 09.7276.40A78

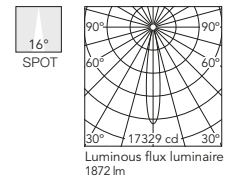

Beam Angle: 16°

h(m)	E(lx)	D(m)
1	17329	0.28
2	4332	0.56
3	1925	0.84
4	1083	1.12
5	693	1.40

- 4000K - CRI 90**
On board dimmer
 09.7271.40A
 09.7271.14A
 All White
 09.7271.40A78

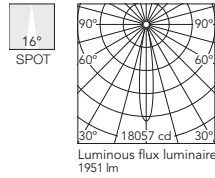

Beam Angle: 16°

h(m)	E(lx)	D(m)
1	18057	0.28
2	4514	0.56
3	2006	0.84
4	1129	1.12
5	722	1.40

- 3000K - CRI 80**
On board dimmer
 09.7272.40A
 09.7272.14A
 All White
 09.7272.40A78

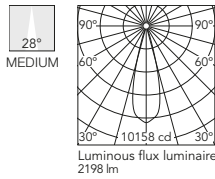

Beam Angle: 28°

h(m)	E(lx)	D(m)
1	10158	0.50
2	2540	1.00
3	1129	1.50
4	635	2.00
5	406	2.50

- 3000K - CRI 90**
On board dimmer
 09.7277.40A
 09.7277.14A
 All White
 09.7277.40A78

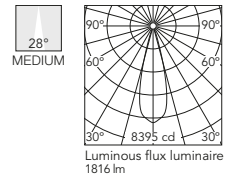

Beam Angle: 28°

h(m)	E(lx)	D(m)
1	8395	0.50
2	2099	1.00
3	933	1.50
4	525	2.00
5	336	2.50

- 4000K - CRI 90**
On board dimmer
 09.7273.40A
 09.7273.14A
 All White
 09.7273.40A78

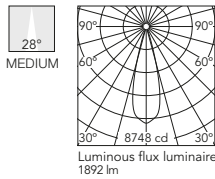

Beam Angle: 28°

h(m)	E(lx)	D(m)
1	8748	0.50
2	2187	1.00
3	972	1.50
4	547	2.00
5	350	2.50

- 3000K - CRI 80**
On board dimmer
 09.7274.40A
 09.7274.14A
 All White
 09.7274.40A78

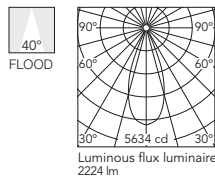

Beam Angle: 40°

h(m)	E(lx)	D(m)
1	5634	0.73
2	1408	1.46
3	626	2.18
4	352	2.91
5	225	3.64

- 3000K - CRI 90**
On board dimmer
 09.7278.40A
 09.7278.14A
 All White
 09.7278.40A78

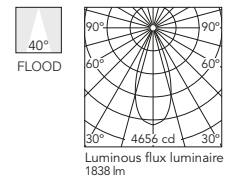

Beam Angle: 40°

h(m)	E(lx)	D(m)
1	4656	0.73
2	1164	1.46
3	517	2.18
4	291	2.91
5	186	3.64

- 4000K - CRI 90**
On board dimmer
 09.7275.40A
 09.7275.14A
 All White
 09.7275.40A78

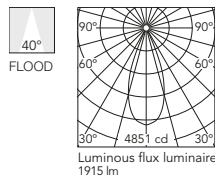

Beam Angle: 40°

h(m)	E(lx)	D(m)
1	4851	0.73
2	1213	1.46
3	539	2.18
4	303	2.91
5	194	3.64

UT PRO

UT Pro 175 GA-69

Light Source: LED Array 35,3W - 3950 lm - 3000K/CRI 80 / 35,3W - 3250 lm - 3000K/CRI 90 / 35,3W - 3400 lm - 4000K/CRI 90

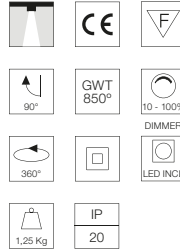
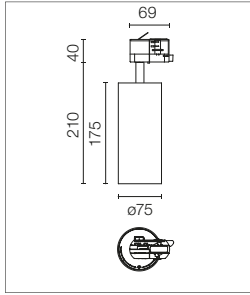

Proiettore per installazione su guida trifase standard con fonte di luce LED. Fonte di alimentazione 120-270V integrata.

Spotlight to be installed in standard 3-phase track with LED light source. 120-270V power supply integrated.

Le versioni .40 hanno l'adattatore a guida, il braccio e la parte posteriore della testa neri. Nelle versioni "all white" l'adattatore a guida, il braccio e la parte posteriore della testa sono bianchi, e solo l'anello antiabbagliamento è nero.

.40 versions come with the track adapter, the arm and the rear of the head in black. In the "All white" versions, the track adapter, the arm, the rear of the head and the head are white. Only the anti-glare ring is black.

Finishes Available



- 3000K - CRI 80**
On board dimmer
- 09.7310.40
 - 09.7310.14
 - All White
 - 09.7310.40.78

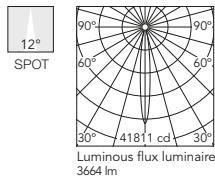

- 3000K - CRI 90**
On board dimmer
- 09.7311.40
 - 09.7311.14
 - All White
 - 09.7311.40.78

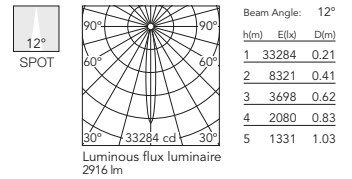

- 4000K - CRI 90**
On board dimmer
- 09.7312.40
 - 09.7312.14
 - All White
 - 09.7312.40.78

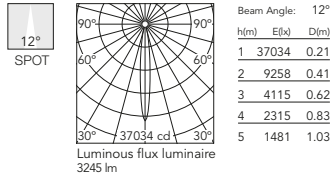

- 3000K - CRI 90**
On board dimmer
- 09.7314.40
 - 09.7314.14
 - All White
 - 09.7314.40.78

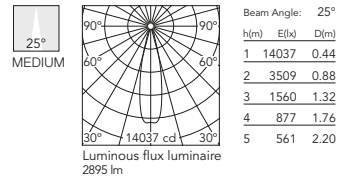

- 3000K - CRI 80**
On board dimmer
- 09.7313.40
 - 09.7313.14
 - All White
 - 09.7313.40.78

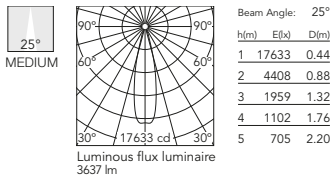

- 4000K - CRI 90**
On board dimmer
- 09.7315.40
 - 09.7315.14
 - All White
 - 09.7315.40.78

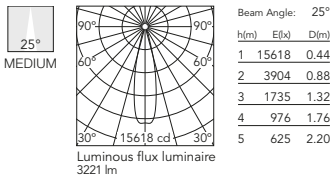

- 3000K - CRI 90**
On board dimmer
- 09.7317.40
 - 09.7317.14
 - All White
 - 09.7317.40.78

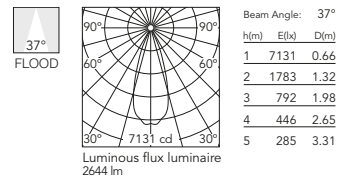

- 3000K - CRI 80**
On board dimmer
- 09.7316.40
 - 09.7316.14
 - All White
 - 09.7316.40.78

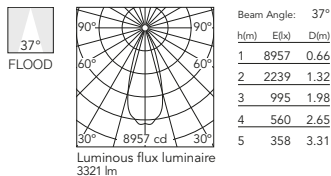

- 4000K - CRI 90**
On board dimmer
- 09.7318.40
 - 09.7318.14
 - All White
 - 09.7318.40.78

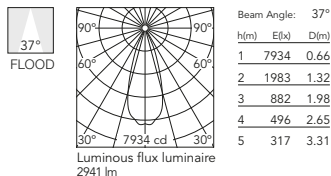

UT PRO

UT Pro 175 Lens GA-69

Light Source: LED Array 35,3W - 3950 lm - 3000K/CRI 80 / 35,3W - 3250 lm - 3000K/CRI 90 / 35,3W - 3400 lm - 4000K/CRI 90

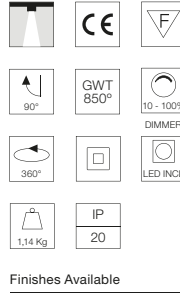
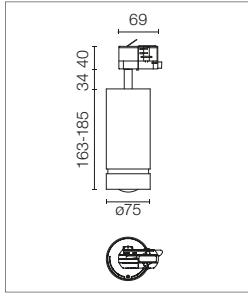

Proiettore per installazione su guida trifase standard con fonte di luce LED. Dotato di lente che permette di regolare l'angolo di apertura da 13° a 56°. Fonte di alimentazione 120-270V integrata.

Spotlight to be installed in standard 3-phase track with LED light source. Includes adjustable lens allowing opening angle calibration from 13° to 56°. 120-270V power supply integrated.

Le versioni .40 hanno l'adattatore a guida, il braccio e la parte posteriore della testa neri. Nelle versioni "all white" l'adattatore a guida, il braccio e la parte posteriore della testa sono bianchi, e solo l'anello antiabbagliamento è nero.

.40 versions come with the track adapter, the arm and the rear of the head in black. In the "All white" versions, the track adapter, the arm, the rear of the head and the head are white. Only the anti-glare ring is black.

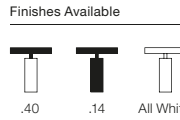

- 3000K - CRI 80**
On board dimmer
- 09.7373.40
 - 09.7373.14
 - All White
 - 09.7373.40.78

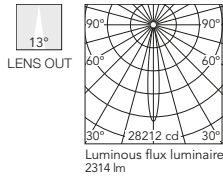

Beam Angle: 13°	h(m)	E(lx)	D(m)
1	28212	0.23	
2	7053	0.46	
3	3135	0.70	
4	1763	0.93	
5	1128	1.16	

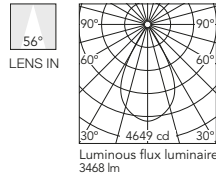

Beam Angle: 56°	h(m)	E(lx)	D(m)
1	4649	1.07	
2	1162	2.14	
3	517	3.21	
4	291	4.29	
5	186	5.36	

- 3000K - CRI 90**
On board dimmer
- 09.7374.40
 - 09.7374.14
 - All White
 - 09.7374.40.78

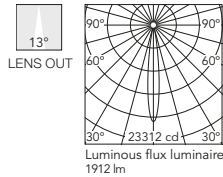

Beam Angle: 13°	h(m)	E(lx)	D(m)
1	23312	0.23	
2	5828	0.46	
3	2590	0.70	
4	1457	0.93	
5	932	1.16	

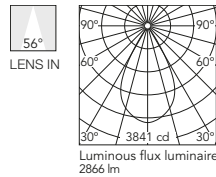

Beam Angle: 56°	h(m)	E(lx)	D(m)
1	3841	1.07	
2	960	2.14	
3	427	3.21	
4	240	4.29	
5	154	5.36	

- 4000K - CRI 90**
On board dimmer
- 09.7375.40
 - 09.7375.14
 - All White
 - 09.7375.40.78

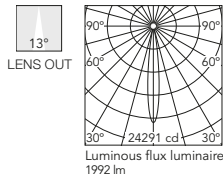

Beam Angle: 13°	h(m)	E(lx)	D(m)
1	24291	0.23	
2	6073	0.46	
3	2699	0.70	
4	1518	0.93	
5	972	1.16	

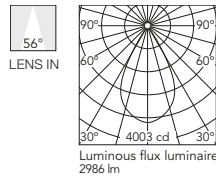

Beam Angle: 56°	h(m)	E(lx)	D(m)
1	4003	1.07	
2	1001	2.14	
3	445	3.21	
4	250	4.29	
5	160	5.36	

UT Pro Wall-Washer GA-69 (Dali GA-600)

Light Source: Top LED 25,5W - 2700 lm - 3000K/CRI 90 / 25,5W - 2900 lm - 4000K/CRI 90

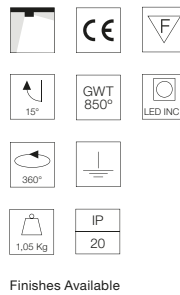
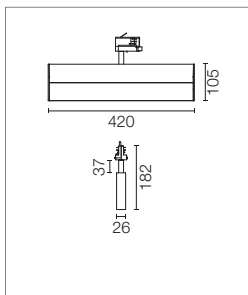

Modulo d'illuminazione Wall-Washer installabile su guida trifase standard con fonte di luce LED. Fonte di alimentazione 220-240V integrata. Per la versione DALI sono necessari profili dimmerabili (consultare capitolo "Tracks").

Wall-Washer lighting module to be installed in standard 3-phase track with LED light source. 220-240V power supply integrated. DALI version requires dimmable tracks (please refer to the "Tracks" chapter).

Le versioni .40 hanno l'adattatore a guida, il braccio e la parte posteriore della testa neri. Nelle versioni "all white" l'adattatore a guida, il braccio e la parte posteriore della testa sono bianchi, e solo l'anello antiabbagliamento è nero.

.40 versions come with the track adapter, the arm and the rear of the head in black. In the "All white" versions, the track adapter, the arm, the rear of the head and the head are white. Only the anti-glare ring is black.



- 3000K - CRI 90**
Non Dimmable
- 09.7504.40
 - 09.7504.14
 - All White
 - 09.7504.40.78

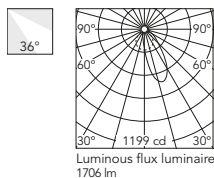

Beam Angle: 36°	h(m)	E(lx)	D(m)
1	1199	0.76	
2	300	1.54	
3	133	2.34	
4	75	3.12	
5	48	3.92	

- 4000K - CRI 90**
Non Dimmable
- 09.7505.40
 - 09.7505.14
 - All White
 - 09.7505.40.78

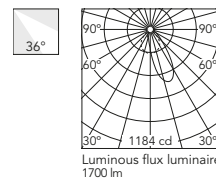

Beam Angle: 36°	h(m)	E(lx)	D(m)
1	1184	0.76	
2	296	1.52	
3	132	2.28	
4	74	3.04	
5	47	3.80	

- Dali Version**
- 09.7504.40.DA
 - 09.7504.14.DA
 - All White
 - 09.7504.40.YU

- Dali Version**
- 09.7505.40.DA
 - 09.7505.14.DA
 - All White
 - 09.7505.40.YU

UT SPOT&PRO

Accessori / Accessories

Crocetta di schermatura, lenti e honeycomb direttamente installabili sulla testa dell'apparecchio di illuminazione senza necessità di accessori di fissaggio. Compatibilità di installazione di honeycomb + lente contemporaneamente.

Screening crosspiece, lenses and honeycomb directly installable on the head of the luminaire without needing any fastening accessory. Installation compatible with honeycomb + lense at the same time.

UT Spot Ø57 / UT Pro 150

Filtro a croce.
antiabbagliamento.
Screening crosspiece.  08.8429.00

Lente ellittica
Elliptical lens  08.8431.00

Lente flood
Flood lens  08.8432.00

For Spot & Medium optics

Honeycomb
Honeycomb  08.8428.00

Cono di schermatura
Snoot shielding cone   08.0526.00
08.0526.40
08.0526.BW

UT Pro 175

Filtro a croce.
antiabbagliamento.
Screening crosspiece.  08.9108.00

Lente ellittica
Elliptical lens  08.9109.00

Lente flood
Flood lens  08.9110.00

Honeycomb
Honeycomb  08.9107.00

Cono di schermatura
Snoot shielding cone   08.9111.00

Accessori / Accessories

Crocetta di schermatura, lenti e honeycomb direttamente installabili sulla testa dell'apparecchio di illuminazione senza necessità di accessori di fissaggio.

UT Spot Ø86: Compatibilità di installazione di honeycomb + lente contemporaneamente.

UT Spot Ø86 Multichip: Gli accessori non sono compatibili con questa versione.

Screening crosspiece, lenses and Honeycomb directly installable on the head of the luminaire without needing any fastening accessory.

UT Spot Ø86: Installation compatible with Honeycomb + Lense at the same time.

UT Spot Ø86 Multichip: The accessories are not compatible with this version.

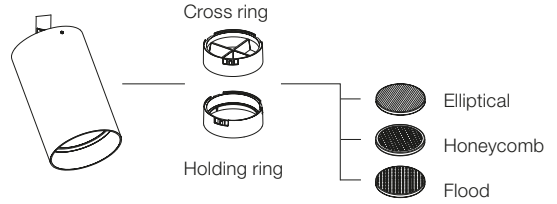

UT Spot Ø86

Anello di supporto
Holding ring  08.8410.00

UT Spot Ø86 Phosphor LED / UT Spot Ø86 LED Array

Filtro a croce
antiabbagliamento.
Screening crosspiece.  08.8411.00

UT Spot Ø86 LED Array

Lente ellittica
Elliptical lens  08.8163.68

Lente flood
Flood lens  08.8175.68

For Spot & Medium optics

Honeycomb
Honeycomb  08.8495.14

SOLID PURE

DESIGNED BY KNUD HOLSCHER

TRACK

CEILING



LIGHT SOURCE

LED ARRAY
23W
2747 lm
3000K/CRI 80
23W
2231 lm
3000K/CRI 90
23W
2865 lm
4000K/CRI 80

LIGHT SOURCE

LED ARRAY
30W
3516 lm
3000K/CRI 80
30W
2855 lm
3000K/CRI 90
30W
3667 lm
4000K/CRI 80

LIGHT SOURCE

LED ARRAY
35W
4321 lm
3000K/CRI 80
35W
3509 lm
3000K/CRI 90
35W
4508 lm
4000K/CRI 80

□ 30 Bianco
30 White

■ 14 Nero
14 Black



Può essere ruotato di 360° e orientato di 190°.
Can be rotated 360° and swivelled 190°.

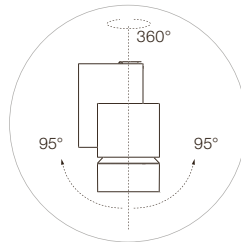

reddot design award
winner 2013

Descrizione

Apparecchio per interni da installare a binario trifase o a soffitto o parete, disponibile con sorgenti luminose a tecnologia Led di alta potenza e in versione DALI e non DALI.

Il corpo ottico dell'apparecchio e il contenitore degli alimentatori sono in alluminio iniettato ad alta pressione, rifiniti con verniciatura a polvere color bianco, grigio o nero. L'anello per il fissaggio dei riflettori è realizzato in materiale termoplastico color nero e alloggia al suo interno un elemento porta accessori in grado a sua volta di alloggiare filtri cromatici ed elementi antiabbagliamento tipo pannello alveolare. L'apparecchio a binario ha incorporato un adattatore da binario trifase.

Il corretto funzionamento per tutta la vita utile del modulo Led è garantito grazie ad un innovativo design del sistema di dissipazione termica, che permette un costante ricircolo del flusso dell'aria al suo interno. Per ottenere ciò si utilizzano soluzioni con radiatori passivi (versioni 23/30/35W) e attivi (versione 53W) in base al flusso necessario per il ricircolo dell'aria.

Riflettori

Tutte le ottiche sono realizzate in alluminio superpuro con finitura speculare. Circolare simmetrico rotante. L'apparecchio è disponibile in tre tipi di riflettori: spot, medium y flood.

Unità di Alimentazione

Alimentatore a corrente continua non regolabile o regolabile Dali 220/240V compreso.

Accessori

- Honeycomb.
- Filtri cromatici.

Informazioni Aggiuntive

Possibilità di bloccare l'orientamento del fascio di luce sia nel piano orizzontale (rotazione di 360° rispetto all'asse verticale) che nel piano verticale (190° rispetto all'asse orizzontale).

È disponibile in versione DALI sia a binario che a soffitto.

Grado di protezione IP20.

Classe di isolamento I.

Adatti ad installazioni su superfici normalmente infiammabili.

Gli apparecchi FLOS per binario trifase sono progettati e testati con i binari raccomandati da FLOS. La compatibilità è garantita con i binari prodotti da Nordic Aluminium e Eutrac. Per verificare la compatibilità con altri binari, contattare FLOS prima dell'installazione.

Gli apparecchi FLOS per binario trifase DALI sono progettati in conformità al protocollo Pulse DALI di Nordic Aluminium.

Conformità e Marchi di Qualità

Apparecchio conforme alla Normativa Tecnica Europea EN60598-1 e relative parti seconde.

Description

A luminaire for indoor use to be mounted on three-phase track or on ceilings/walls, available in high power LED technology light sources and in DALI and non-DALI versions.

The optical housing of the luminaire, as well as the container of the power supply equipment, is manufactured in high-pressure injected aluminium, with white, grey or black finishes. The reflector fastening ring houses an accessory-holder element where chromatic filters and honeycomb type anti-glare elements can be housed. The perfect operation of the LED module is guaranteed thanks to its heat dissipation system, which permits constant recirculation of the air on the inside. To this end, solutions with passive radiators (23/30/35W versions) and active radiators (53W version) are used depending on the required air recirculation flow.

Reflectors

All optics are made of superpure aluminium with specular finish. Symmetrical circular rotary system. Available in 3 optics: spot, medium y flood.

Power Supply

Not dimmable or dimmable Dali 220/240V, constant current, power supply included.

Accessories

- Honeycomb.
- Chromatic filters.

Additional Information

Block system to fix the lightbeam in horizontal (360° rotation on vertical edge) as well as vertical (190° on horizontal edge).

DALI version for track and surface mounting is available.

IP20 protection grade.

Insulation class I.

Suitable for installation on normally inflammable surfaces.

FLOS three-phase lighting track luminaires are designed and fully tested for tracks recommended by FLOS.

Compatibility is guaranteed with three-phase track produced by Nordic Aluminium and Eutrac. To verify compatibility with any other track, please contact FLOS before installation.

FLOS three-phase DALI track luminaires are designed for Pulse DALI from Nordic Aluminium.

Standard Compliance and Quality Marks

EN60598-1 European Technical Standards and any subsequent additions.



Ceiling



Track

SOLID PURE

Solid Pure Track

Light Source: LED Array 23W - 2747 lm - 3000K/CRI 80

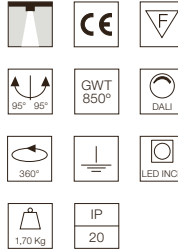
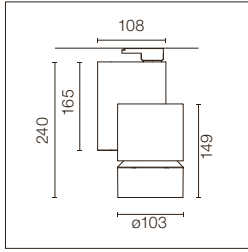

Proiettore per installazione su binario trifase con fonte di luce LED. Fonte di alimentazione 220-240V, 50-60Hz integrata.

Spotlight to be installed on 3-phase track with LED light source. 220-240V, 50-60Hz power supply included.

- Non Dimmable
 09.2888.30
 09.2888.14
 Dali Version
 09.2888.30.DA
 09.2888.14.DA

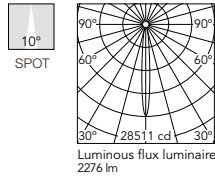

- Non Dimmable
 09.2890.30
 09.2890.14
 Dali Version
 09.2890.30.DA
 09.2890.14.DA

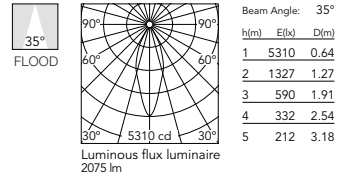

- Non Dimmable
 09.2889.30
 09.2889.14
 Dali Version
 09.2889.30.DA
 09.2889.14.DA

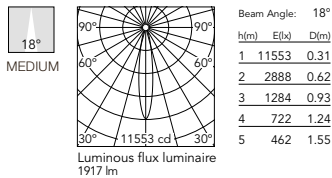

Solid Pure Track

Light Source: LED Array 30W - 3516 lm - 3000K/CRI 80 / 35W - 4321 lm - 3000K/CRI 80

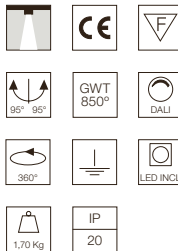
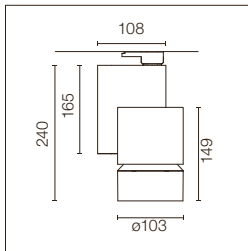

Proiettore per installazione su binario trifase con fonte di luce LED. Fonte di alimentazione 220-240V, 50-60Hz integrata.

Spotlight to be installed on 3-phase track with LED light source. 220-240V, 50-60Hz power supply included.

- 3000K - CRI 80**
 30W - 3516 lm
 Non Dimmable
 09.2870.30
 09.2870.14
 Dali Version
 09.2870.30.DA
 09.2870.14.DA

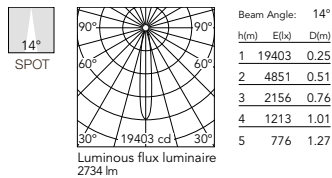

- 3000K - CRI 80**
 35W - 4321 lm
 Non Dimmable
 09.2953.30
 09.2953.14
 Dali Version
 09.2953.30.DA
 09.2953.14.DA

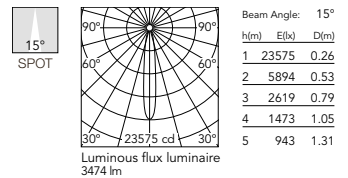

- 3000K - CRI 80**
 30W - 3516 lm
 Non Dimmable
 09.2871.30
 09.2871.14
 Dali Version
 09.2871.30.DA
 09.2871.14.DA

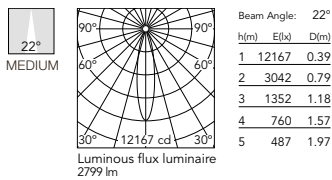

- 3000K - CRI 80**
 35W - 4321 lm
 Non Dimmable
 09.2954.30
 09.2954.14
 Dali Version
 09.2954.30.DA
 09.2954.14.DA

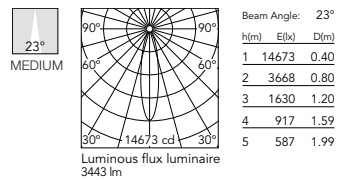

- 3000K - CRI 80**
 30W - 3516 lm
 Non Dimmable
 09.2872.30
 09.2872.14
 Dali Version
 09.2872.30.DA
 09.2872.14.DA

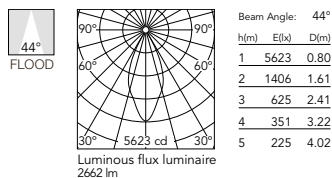

- 3000K - CRI 80**
 35W - 4321 lm
 Non Dimmable
 09.2955.30
 09.2955.14
 Dali Version
 09.2955.30.DA
 09.2955.14.DA

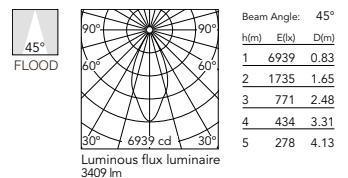

SOLID PURE

Solid Pure Ceiling

Light Source: LED Array 23W - 2747 lm - 3000K/CRI 80

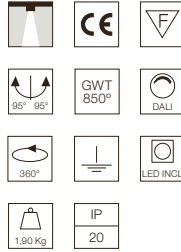
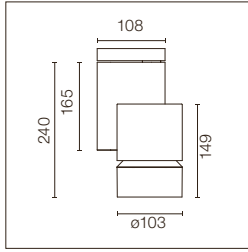

Proiettore per installazione a soffitto/parete con fonte di luce LED. Fonte di alimentazione 220-240V, 50-60Hz integrata.

Spotlight to be installed on ceiling/wall with LED light source. 220-240V, 50-60Hz power supply included.

- Non Dimmable
- 09.2894.30
- 09.2894.14
- Dali Version
- 09.2894.30.DA
- 09.2894.14.DA

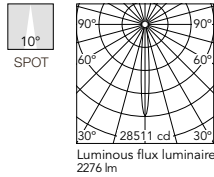

- Non Dimmable
- 09.2896.30
- 09.2896.14
- Dali Version
- 09.2896.30.DA
- 09.2896.14.DA

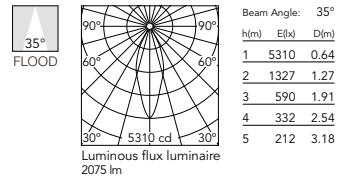

- Non Dimmable
- 09.2895.30
- 09.2895.14
- Dali Version
- 09.2895.30.DA
- 09.2895.14.DA

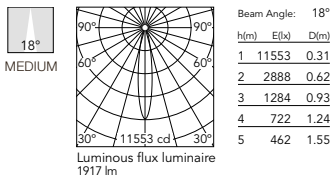

Solid Pure Ceiling

Light Source: LED Array 30W - 3516 lm - 3000K/CRI 80 / 35W - 4321 lm - 3000K/CRI 80

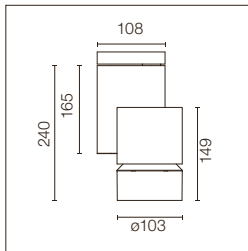

Proiettore per installazione a soffitto/parete con fonte di luce LED. Fonte di alimentazione 220-240V, 50-60Hz integrata.

Spotlight to be installed on ceiling/wall with LED light source. 220-240V, 50-60Hz power supply included.

- 3000K - CRI 80**
- 30W - 3516 lm
- Non Dimmable
- 09.2876.30
- 09.2876.14
- Dali Version
- 09.2876.30.DA
- 09.2876.14.DA

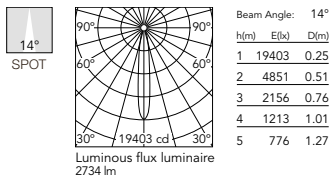

- 3000K - CRI 80**
- 35W - 4321 lm
- Non Dimmable
- 09.2956.30
- 09.2956.14
- Dali Version
- 09.2956.30.DA
- 09.2956.14.DA

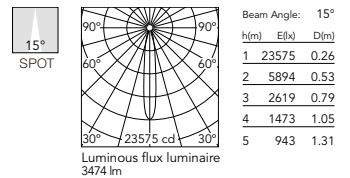

- 3000K - CRI 80**
- 30W - 3516 lm
- Non Dimmable
- 09.2877.30
- 09.2877.14
- Dali Version
- 09.2877.30.DA
- 09.2877.14.DA

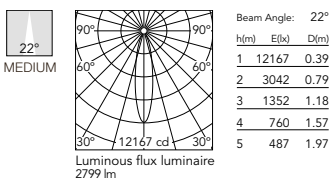

- 3000K - CRI 80**
- 35W - 4321 lm
- Non Dimmable
- 09.2957.30
- 09.2957.14
- Dali Version
- 09.2957.30.DA
- 09.2957.14.DA

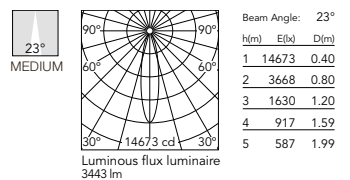

- 3000K - CRI 80**
- 30W - 3516 lm
- Non Dimmable
- 09.2878.30
- 09.2878.14
- Dali Version
- 09.2878.30.DA
- 09.2878.14.DA

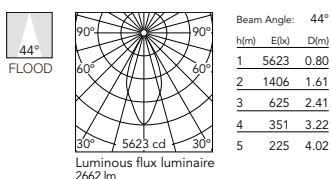

- 3000K - CRI 80**
- 35W - 4321 lm
- Non Dimmable
- 09.2958.30
- 09.2958.14
- Dali Version
- 09.2958.30.DA
- 09.2958.14.DA

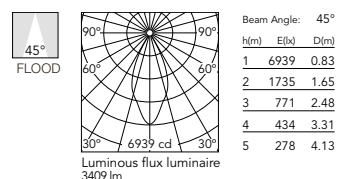

SOLID PURE

Solid Pure Track

Light Source: LED Array 23W - 2231 lm - 3000K/CRI 90

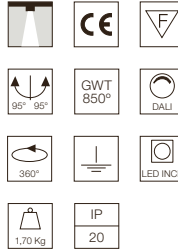
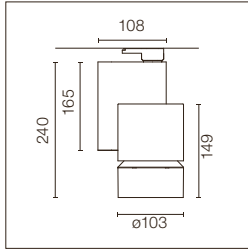

Proiettore per installazione su binario trifase con fonte di luce LED. Fonte di alimentazione 220-240V, 50-60Hz integrata.

Spotlight to be installed on 3-phase track with LED light source. 220-240V, 50-60Hz power supply included.

- Non Dimmable
 09.2885.30
 09.2885.14
 Dali Version
 09.2885.30.DA
 09.2885.14.DA

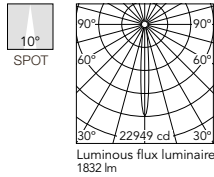

- Non Dimmable
 09.2887.30
 09.2887.14
 Dali Version
 09.2887.30.DA
 09.2887.14.DA

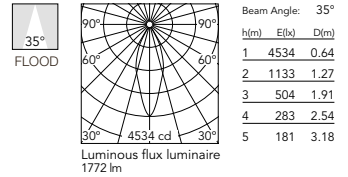

- Non Dimmable
 09.2886.30
 09.2886.14
 Dali Version
 09.2886.30.DA
 09.2886.14.DA

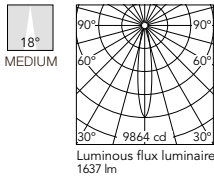

Solid Pure Track

Light Source: LED Array 30W - 2855 lm - 3000K/CRI 90 / 35W - 3509 lm - 3000K/CRI 90

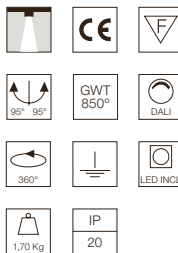
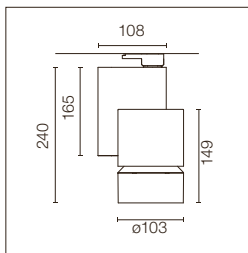

Proiettore per installazione su binario trifase con fonte di luce LED. Fonte di alimentazione 220-240V, 50-60Hz integrata.

Spotlight to be installed on 3-phase track with LED light source. 220-240V, 50-60Hz power supply included.

- 3000K - CRI 90**
 30W - 2855 lm
 Non Dimmable
 09.2997.30
 09.2997.14
 Dali Version
 09.2997.30.DA
 09.2997.14.DA

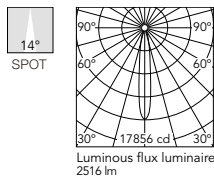

- 3000K - CRI 90**
 35W - 3509 lm
 Non Dimmable
 09.2991.30
 09.2991.14
 Dali Version
 09.2991.30.DA
 09.2991.14.DA

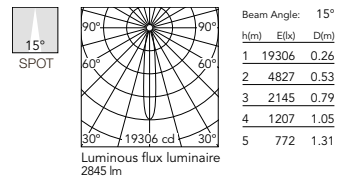

- 3000K - CRI 90**
 30W - 2855 lm
 Non Dimmable
 09.2998.30
 09.2998.14
 Dali Version
 09.2998.30.DA
 09.2998.14.DA

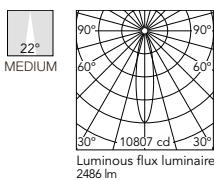

- 3000K - CRI 90**
 35W - 3509 lm
 Non Dimmable
 09.2992.30
 09.2992.14
 Dali Version
 09.2992.30.DA
 09.2992.14.DA

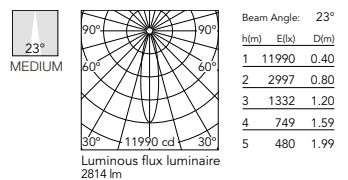

- 3000K - CRI 90**
 30W - 2855 lm
 Non Dimmable
 09.2999.30
 09.2999.14
 Dali Version
 09.2999.30.DA
 09.2999.14.DA

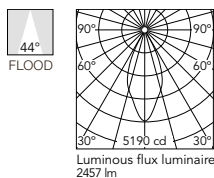

- 3000K - CRI 90**
 35W - 3509 lm
 Non Dimmable
 09.2993.30
 09.2993.14
 Dali Version
 09.2993.30.DA
 09.2993.14.DA

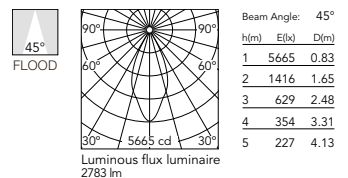

SOLID PURE

Solid Pure Ceiling

Light Source: LED Array 23W - 2231 lm - 3000K/CRI 90

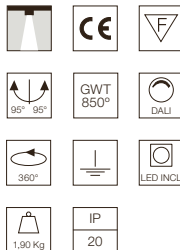
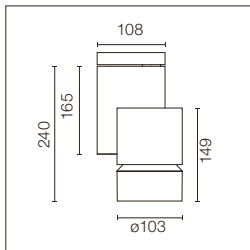

Proiettore per installazione a soffitto/parete con fonte di luce LED. Fonte di alimentazione 220-240V, 50-60Hz integrata.

Spotlight to be installed on ceiling/wall with LED light source. 220-240V, 50-60Hz power supply included.

- Non Dimmable
- 09.2891.30
- 09.2891.14
- Dali Version
- 09.2891.30.DA
- 09.2891.14.DA

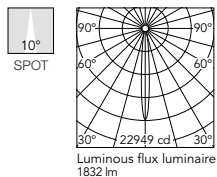

Beam Angle: 10°

h(m)	E(lx)	D(m)
1	22949	0.18
2	5737	0.35
3	2550	0.53
4	1434	0.71
5	918	0.88

- Non Dimmable
- 09.2893.30
- 09.2893.14
- Dali Version
- 09.2893.30.DA
- 09.2893.14.DA

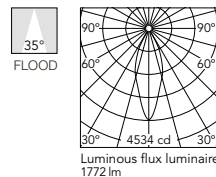

Beam Angle: 35°

h(m)	E(lx)	D(m)
1	4534	0.64
2	1133	1.27
3	504	1.91
4	283	2.54
5	181	3.18

- Non Dimmable
- 09.2892.30
- 09.2892.14
- Dali Version
- 09.2892.30.DA
- 09.2892.14.DA

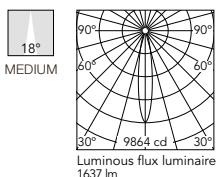

Beam Angle: 18°

h(m)	E(lx)	D(m)
1	9864	0.31
2	2466	0.62
3	1096	0.93
4	616	1.24
5	395	1.55

Solid Pure Ceiling

Light Source: LED Array 30W - 2855 lm - 3000K/CRI 90 / 35W - 3509 lm - 3000K/CRI 90

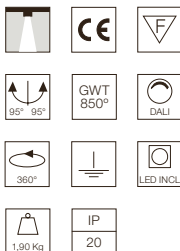
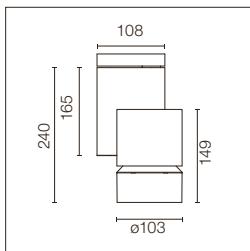

Proiettore per installazione a soffitto/parete con fonte di luce LED. Fonte di alimentazione 220-240V, 50-60Hz integrata.

Spotlight to be installed on ceiling/wall with LED light source. 220-240V, 50-60Hz power supply included.

- 3000K - CRI 90**
30W - 2855 lm
- Non Dimmable
 - 09.2873.30
 - 09.2873.14
 - Dali Version
 - 09.2873.30.DA
 - 09.2873.14.DA

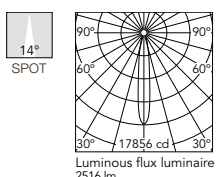

Beam Angle: 14°

h(m)	E(lx)	D(m)
1	17856	0.25
2	4464	0.51
3	1984	0.76
4	1116	1.01
5	714	1.27

- 3000K - CRI 90**
35W - 3509 lm
- Non Dimmable
 - 09.2994.30
 - 09.2994.14
 - Dali Version
 - 09.2994.30.DA
 - 09.2994.14.DA

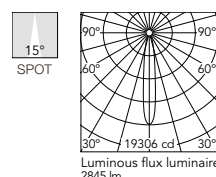

Beam Angle: 15°

h(m)	E(lx)	D(m)
1	19306	0.26
2	4827	0.53
3	2145	0.79
4	1207	1.05
5	772	1.31

- 3000K - CRI 90**
30W - 2855 lm
- Non Dimmable
 - 09.2874.30
 - 09.2874.14
 - Dali Version
 - 09.2874.30.DA
 - 09.2874.14.DA

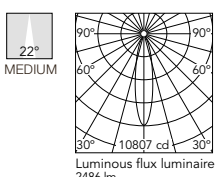

Beam Angle: 22°

h(m)	E(lx)	D(m)
1	10807	0.39
2	2702	0.79
3	1201	1.18
4	675	1.57
5	432	1.97

- 3000K - CRI 90**
35W - 3509 lm
- Non Dimmable
 - 09.2995.30
 - 09.2995.14
 - Dali Version
 - 09.2995.30.DA
 - 09.2995.14.DA

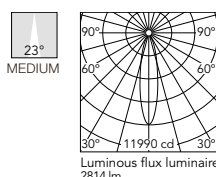

Beam Angle: 23°

h(m)	E(lx)	D(m)
1	11990	0.40
2	2997	0.80
3	1332	1.20
4	749	1.59
5	480	1.99

- 3000K - CRI 90**
30W - 2855 lm
- Non Dimmable
 - 09.2875.30
 - 09.2875.14
 - Dali Version
 - 09.2875.30.DA
 - 09.2875.14.DA

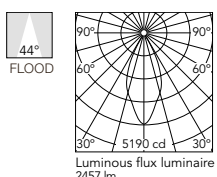

Beam Angle: 44°

h(m)	E(lx)	D(m)
1	5190	0.80
2	1298	1.61
3	577	2.41
4	324	3.22
5	208	4.02

- 3000K - CRI 90**
35W - 3509 lm
- Non Dimmable
 - 09.2996.30
 - 09.2996.14
 - Dali Version
 - 09.2996.30.DA
 - 09.2996.14.DA

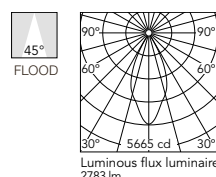

Beam Angle: 45°

h(m)	E(lx)	D(m)
1	5665	0.83
2	1416	1.65
3	629	2.48
4	354	3.31
5	227	4.13

SOLID PURE

Solid Pure Track

Light Source: LED Array 23W - 2865 lm - 4000K/CRI 80

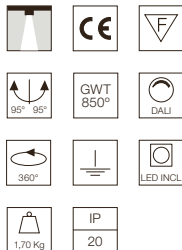
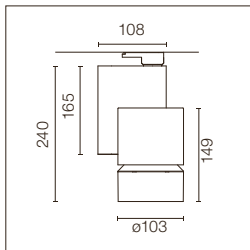

Proiettore per installazione su binario trifase con fonte di luce LED. Fonte di alimentazione 220-240V, 50-60Hz integrata.

Spotlight to be installed on 3-phase track with LED light source. 220-240V, 50-60Hz power supply included.

- Non Dimmable
- 09.2897.30
- 09.2897.14
- Dali Version
- 09.2897.30.DA
- 09.2897.14.DA

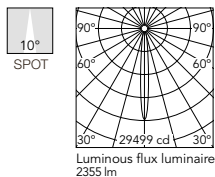

Beam Angle: 10°

h(m)	E(lx)	D(m)
1	29499	0.18
2	7375	0.35
3	3278	0.53
4	1844	0.71
5	1180	0.88

- Non Dimmable
- 09.2899.30
- 09.2899.14
- Dali Version
- 09.2899.30.DA
- 09.2899.14.DA

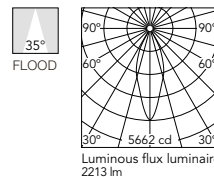

Beam Angle: 35°

h(m)	E(lx)	D(m)
1	5662	0.64
2	1415	1.27
3	629	1.91
4	354	2.54
5	226	3.18

- Non Dimmable
- 09.2898.30
- 09.2898.14
- Dali Version
- 09.2898.30.DA
- 09.2898.14.DA

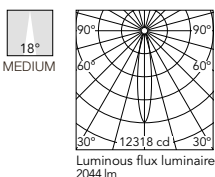

Beam Angle: 18°

h(m)	E(lx)	D(m)
1	12318	0.31
2	3080	0.62
3	1369	0.93
4	770	1.24
5	493	1.55

Solid Pure Track

Light Source: LED Array 30W - 3667 lm - 4000K/CRI 80 / 35W - 4508 lm - 4000K/CRI 80

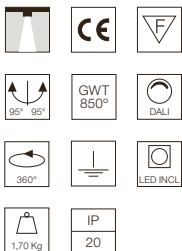
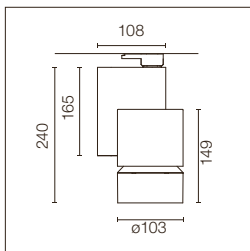

Proiettore per installazione su binario trifase con fonte di luce LED. Fonte di alimentazione 220-240V, 50-60Hz integrata.

Spotlight to be installed on 3-phase track with LED light source. 220-240V, 50-60Hz power supply included.

- 4000K - CRI 80**
30W - 3667 lm
- Non Dimmable
 - 09.2879.30
 - 09.2879.14
 - Dali Version
 - 09.2879.30.DA
 - 09.2879.14.DA

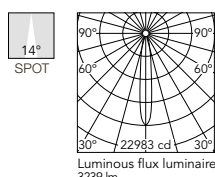

Beam Angle: 14°

h(m)	E(lx)	D(m)
1	22983	0.25
2	5746	0.51
3	2554	0.76
4	1436	1.01
5	919	1.27

- 4000K - CRI 80**
35W - 4508 lm
- Non Dimmable
 - 09.2959.30
 - 09.2959.14
 - Dali Version
 - 09.2959.30.DA
 - 09.2959.14.DA

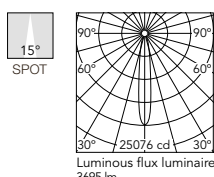

Beam Angle: 15°

h(m)	E(lx)	D(m)
1	25076	0.26
2	6269	0.53
3	2786	0.79
4	1567	1.05
5	1003	1.31

- 4000K - CRI 80**
30W - 3667 lm
- Non Dimmable
 - 09.2880.30
 - 09.2880.14
 - Dali Version
 - 09.2880.30.DA
 - 09.2880.14.DA

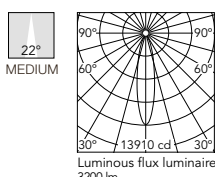

Beam Angle: 22°

h(m)	E(lx)	D(m)
1	13910	0.39
2	3478	0.79
3	1546	1.18
4	869	1.57
5	556	1.97

- 4000K - CRI 80**
35W - 4508 lm
- Non Dimmable
 - 09.2960.30
 - 09.2960.14
 - Dali Version
 - 09.2960.30.DA
 - 09.2960.14.DA

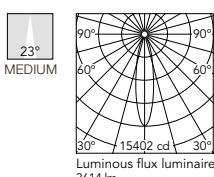

Beam Angle: 23°

h(m)	E(lx)	D(m)
1	15402	0.40
2	3850	0.80
3	1711	1.20
4	963	1.59
5	616	1.99

- 4000K - CRI 80**
30W - 3667 lm
- Non Dimmable
 - 09.2881.30
 - 09.2881.14
 - Dali Version
 - 09.2881.30.DA
 - 09.2881.14.DA

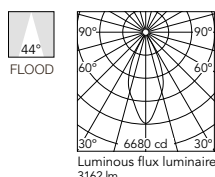

Beam Angle: 44°

h(m)	E(lx)	D(m)
1	6680	0.80
2	1670	1.61
3	742	2.41
4	418	3.22
5	267	4.02

- 4000K - CRI 80**
35W - 4508 lm
- Non Dimmable
 - 09.2961.30
 - 09.2961.14
 - Dali Version
 - 09.2961.30.DA
 - 09.2961.14.DA

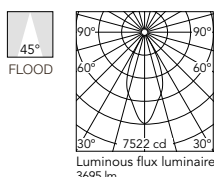

Beam Angle: 45°

h(m)	E(lx)	D(m)
1	7522	0.83
2	1880	1.65
3	836	2.48
4	470	3.31
5	301	4.13

SOLID PURE

Solid Pure Ceiling

Light Source: LED Array 23W - 2865 lm - 4000K/CRI 80

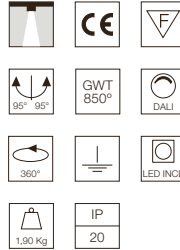
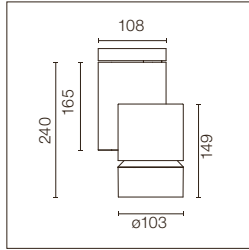

Proiettore per installazione a soffitto con fonte di luce LED. Fonte di alimentazione 220-240V, 50-60Hz integrata.

Spotlight to be installed on ceiling with LED light source. 220-240V, 50-60Hz power supply included.

- Non Dimmable
- 09.2865.30
- 09.2865.14
- Dali Version
- 09.2865.30.DA
- 09.2865.14.DA

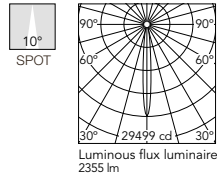

- Non Dimmable
- 09.2867.30
- 09.2867.14
- Dali Version
- 09.2867.30.DA
- 09.2867.14.DA

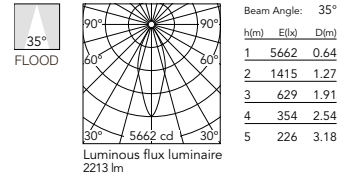

- Non Dimmable
- 09.2866.30
- 09.2866.14
- Dali Version
- 09.2866.30.DA
- 09.2866.14.DA

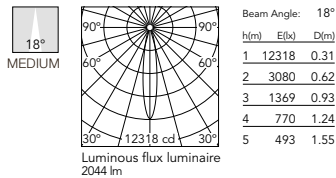

Solid Pure Ceiling

Light Source: LED Array 30W - 3667 lm - 4000K/CRI 80 / 35W - 4508 lm - 4000K/CRI 80

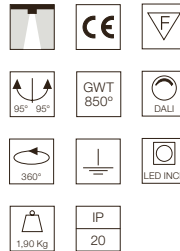
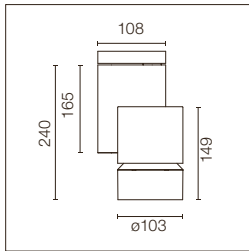

Proiettore per installazione a soffitto con fonte di luce LED. Fonte di alimentazione 220-240V, 50-60Hz integrata.

Spotlight to be installed on ceiling with LED light source. 220-240V, 50-60Hz power supply included.

- 4000K - CRI 80**
- 30W - 3667 lm
- Non Dimmable
- 09.2882.30
- 09.2882.14
- Dali Version
- 09.2882.30.DA
- 09.2882.14.DA

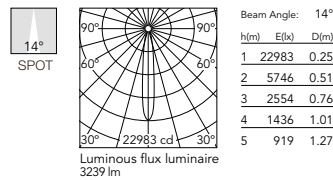

- 4000K - CRI 80**
- 35W - 4508 lm
- Non Dimmable
- 09.2962.30
- 09.2962.14
- Dali Version
- 09.2962.30.DA
- 09.2962.14.DA

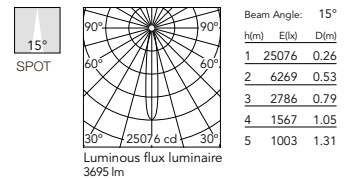

- 4000K - CRI 80**
- 30W - 3667 lm
- Non Dimmable
- 09.2883.30
- 09.2883.14
- Dali Version
- 09.2883.30.DA
- 09.2883.14.DA

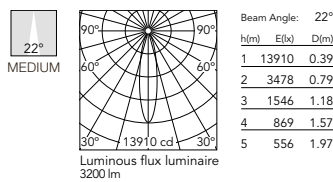

- 4000K - CRI 80**
- 35W - 4508 lm
- Non Dimmable
- 09.2963.30
- 09.2963.14
- Dali Version
- 09.2963.30.DA
- 09.2963.14.DA

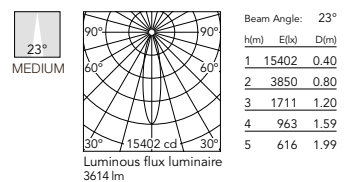

- 4000K - CRI 80**
- 30W - 3667 lm
- Non Dimmable
- 09.2884.30
- 09.2884.14
- Dali Version
- 09.2884.30.DA
- 09.2884.14.DA

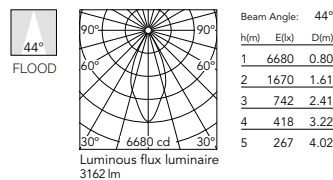

- 4000K - CRI 80**
- 35W - 4508 lm
- Non Dimmable
- 09.2964.30
- 09.2964.14
- Dali Version
- 09.2964.30.DA
- 09.2964.14.DA

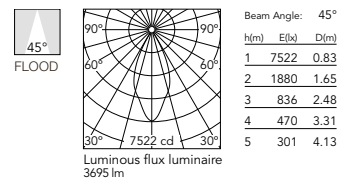

SOLID PURE

Accessori / Accessories

Tutti gli accessori devono essere usati sempre con l'anello di supporto. Questo anello di supporto permette l'installazione di un elemento di schermatura a "nido d'ape", di un filtro colorato o di un elemento di schermatura + un filtro colorato.

All accessories should always be used with the holding ring. This holding ring allows to use the spotlight with a "honeycomb" anti-glare screen or a color filter or both, a "honeycomb" + a color filter.

Anello di chiusura
Holding ring



08.8768.14

Honeycomb
Honeycomb



08.8763.14

Filtro blu
Blue filter



08.8766.64.OD

Filtro azzurro
Sky blue filter



08.8766.65.OD

Filtro ambra
Amber filter



08.8766.66.OD

Filtro rosso
Red filter



08.8766.67.OD

PURE SPOT

DESIGNED BY KNUD HOLSCHER

PURE SPOT

PURE SPOT
PRO



LIGHT SOURCE
LED ARRAY
17,5W
2115 lm
3000K/CRI 80

LIGHT SOURCE
POWER LED
15,7W
1400 lm
2700K/CRI 80
3000K/CRI 80

LIGHT SOURCE
PHOSPHOR
LED
19,5W
2000 lm
3000K/CRI 80
17W
1400 lm
3000K/CRI 98

□ 30 Bianco
30 White

■ 02 Grigio
02 Grey

■ 14 Nero
14 Black



Può essere ruotato di 180° e orientato di 180°.
Can be rotated 180° and swivelled 180°.

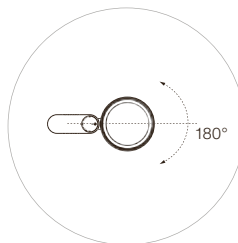
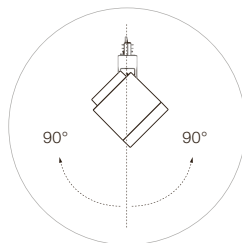

reddot design award
winner 2008

DESIGN PLUS

488

PURE SPOT

Descrizione

Apparecchio per installazione a plafone o mediante binario elettrico trifase.

Portalampe in materiale ceramico o in tecnopolimero autoestingente, con cavi elettrici unipolari isolati Teflon con doppio isolamento trasparente. Corpo lampada costituito da un elemento dissipatore in alluminio, posto sopra il portalampe, da un anello reggi-schermi realizzato in materiale termoplastico di colore nero e da un vetro temperato di 4mm di spessore. Corpo, coperchio di chiusura e supporto orientabile della lampada sono in lega di alluminio pressofusa, verniciate a polvere di colore bianco, grigio o nero. Adattatore trifase in materiale termoplastico.

Riflettori

Tutte le ottiche sono realizzate in alluminio super puro con finitura speculare.
Circolare rotosimmetrica da spot 10° a wide flood 51°.

Unità di Alimentazione

Trasformatore elettronico a corrente costante non regolabile 220/240V-50/60Hz.

Accessori

- Lente di distribuzione ellittica in vetro temperato di 4mm.
- Honeycomb.
- Filtri cromatici.

Informazioni Aggiuntive

Possibilità di rotazione di 180° sull'asse verticale, di 180° su quello orizzontale. Apparato con sistema di bloccaggio sia

orizzontale che verticale.

Grado di protezione IP20.

Classe di isolamento I.

Adatti ad installazioni su superfici normalmente infiammabili.

Gli apparecchi FLOS per binario trifase sono progettati e testati con i binari raccomandati da FLOS. La compatibilità è garantita con i binari prodotti da Nordic Aluminium e Eutrac. Per verificare la compatibilità con altri binari, contattare FLOS prima dell'installazione.

Conformità e Marchi di Qualità

Apparecchio conforme alla Normativa Tecnica Europea EN60598-1 e relative parti seconde.

Description

Luminaire for ceiling or three-phase electric track installation.

Self-extinguishing ceramic or engineering plastic lamp holders, with single-pole, transparent electric wires with double Teflon insulation. Aluminum body, placed above the lamp holder, black thermoplastic and 4mm tempered glass screen-support ring. Die-cast aluminum alloy body, cover and adjustable lamp support, powder-coated white, grey or black. Thermoplastic three-phase adapter.

Reflectors

All super pure aluminum with specular finish.
Circular rotosymmetrical from 10° spot to 51° wide flood.

Power Supply

Electronic transformer with non-adjustable constant current 220/240V 50/60Hz.

Accessories

- 4mm tempered glass elliptical distribution lens.
- Honeycomb.
- Chromatic filters.

Additional Information

0° - 180° vertical rotation, 0° - 180° horizontal rotation.
Horizontal and vertical locking system.

IP20 protection grade.

Insulation class I.

Suitable for installation on normally inflammable surfaces.

FLOS three-phase lighting track luminaires are designed and fully tested for tracks recommended by FLOS.

Compatibility is guaranteed with three-phase track produced by Nordic Aluminium and Eutrac. To verify compatibility with any other track, please contact FLOS before installation.

Standard Compliance and Quality Marks

EN60598-1 European Technical Standards and any subsequent additions.



Ceiling



Track

PURE SPOT

Pure Spot Track

Light Source: LED Array 17,5W - 2115 lm - 3000K/CRI 80

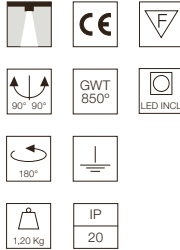
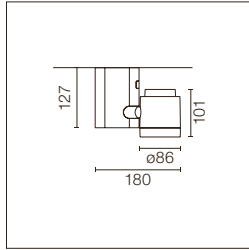

Proiettore per installazione su binario trifase con fonte di luce LED. Fonte di alimentazione 220/240V, 50/60Hz integrata.

Spotlight to be installed on 3-phase track with LED light source. 220/240V, 50/60Hz power supply integrated.

- 09.2570.30A
- 09.2570.02A
- 09.2570.14A

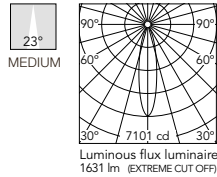

Beam Angle: 23°

h(m)	E(lx)	D(m)
1	7101	0.40
2	1775	0.80
3	789	1.21
4	444	1.61
5	284	2.01

- 09.2571.30A
- 09.2571.02A
- 09.2571.14A

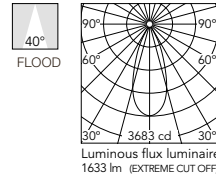

Beam Angle: 40°

h(m)	E(lx)	D(m)
1	3683	0.72
2	921	1.44
3	409	2.16
4	230	2.88
5	147	3.60

Pure Spot Ceiling

Light Source: LED Array 17,5W - 2115 lm - 3000K/CRI 80

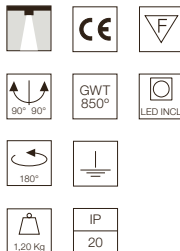
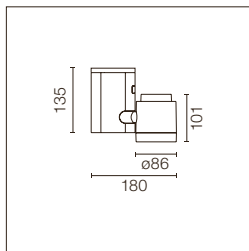

Proiettore per installazione a soffitto/parete con fonte di luce LED. Fonte di alimentazione 220/240V, 50/60Hz integrata.

Spotlight to be installed on ceiling/wall with LED light source. 220/240V, 50/60Hz power supply integrated.

- 09.2575.30A
- 09.2575.02A
- 09.2575.14A

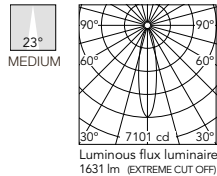

Beam Angle: 23°

h(m)	E(lx)	D(m)
1	7101	0.40
2	1775	0.80
3	789	1.21
4	444	1.61
5	284	2.01

- 09.2576.30A
- 09.2576.02A
- 09.2576.14A

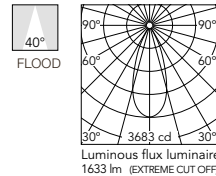

Beam Angle: 40°

h(m)	E(lx)	D(m)
1	3683	0.72
2	921	1.44
3	409	2.16
4	230	2.88
5	147	3.60

PURE SPOT

Pure Spot Track

Light Source: Phosphor LED 19,5W - 2000 lm - 3000K/CRI 80 / 17W - 1400 lm - 3000K/CRI 98

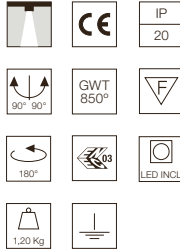
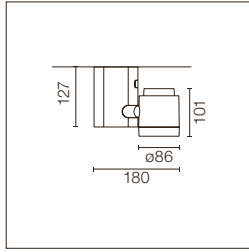

Proiettore per installazione su binario trifase con fonte di luce LED. Trasformatore elettronico 220/240V, 50/60Hz per LED a fosfori integrato.

Spotlight to be installed on 3-phase track with LED light source. Electronic transformer 220/240V, 50/60Hz for phosphor LED integrated. LED integrated.

3000K - CRI 80
 09.2410.30C
 09.2410.02C
 09.2410.14C

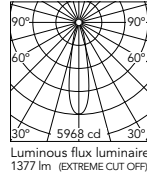

Beam Angle: 23°

h(m)	E(lx)	D(m)
1	5968	0.41
2	1492	0.81
3	663	1.22
4	373	1.62
5	239	2.03

3000K - CRI 98
 09.2400.30C
 09.2400.02C
 09.2400.14C

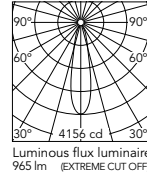

Beam Angle: 23°

h(m)	E(lx)	D(m)
1	4156	0.41
2	1039	0.81
3	462	1.22
4	260	1.63
5	166	2.04

3000K - CRI 80
 09.2411.30C
 09.2411.02C
 09.2411.14C

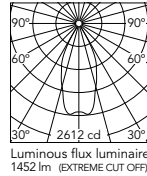

Beam Angle: 45°

h(m)	E(lx)	D(m)
1	2612	0.84
2	653	1.68
3	290	2.51
4	163	3.35
5	104	4.19

3000K - CRI 98
 09.2401.30C
 09.2401.02C
 09.2401.14C

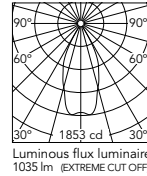

Beam Angle: 46°

h(m)	E(lx)	D(m)
1	1853	0.85
2	463	1.70
3	206	2.54
4	116	3.39
5	74	4.24

3000K - CRI 80
 09.2412.30C
 09.2412.02C
 09.2412.14C

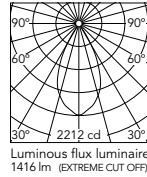

Beam Angle: 51°

h(m)	E(lx)	D(m)
1	2212	0.95
2	553	1.90
3	246	2.85
4	138	3.79
5	88	4.74

3000K - CRI 98
 09.2402.30C
 09.2402.02C
 09.2402.14C

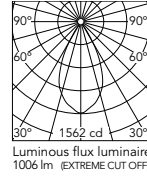

Beam Angle: 51°

h(m)	E(lx)	D(m)
1	1562	0.95
2	391	1.91
3	174	2.86
4	98	3.82
5	62	4.77

PURE SPOT

Pure Spot Ceiling

Light Source: Phosphor LED 19,5W - 2000 lm - 3000K/CRI 80 / 17W - 1400 lm - 3000K/CRI 98

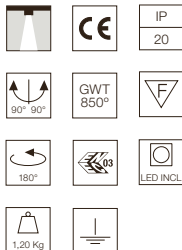
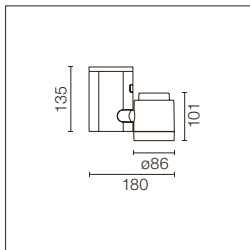

Proiettore per installazione a soffitto/
parete con fonte di luce LED.
Trasformatore elettronico 220/240V,
50/60Hz per LED a fosfori integrato.

Spotlight to be installed on ceiling/
wall with LED light source. Electronic
transformer 220/240V, 50/60Hz for
phosphor LED integrated.

3000K - CRI 80
09.2460.30C
09.2460.02C
09.2460.14C

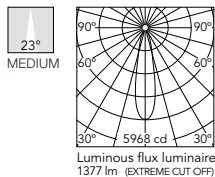

Beam Angle: 23°

h(m)	E(lx)	D(m)
1	5968	0.41
2	1492	0.81
3	663	1.22
4	373	1.62
5	239	2.03

3000K - CRI 98
09.2450.30C
09.2450.02C
09.2450.14C

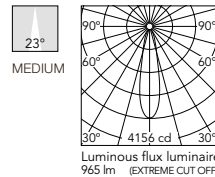

Beam Angle: 23°

h(m)	E(lx)	D(m)
1	4156	0.41
2	1039	0.81
3	462	1.22
4	260	1.63
5	166	2.04

3000K - CRI 80
09.2461.30C
09.2461.02C
09.2461.14C

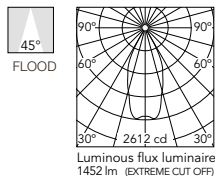

Beam Angle: 45°

h(m)	E(lx)	D(m)
1	2612	0.84
2	653	1.68
3	290	2.51
4	163	3.35
5	104	4.19

3000K - CRI 98
09.2451.30C
09.2451.02C
09.2451.14C

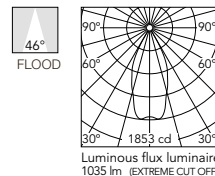

Beam Angle: 46°

h(m)	E(lx)	D(m)
1	1853	0.85
2	463	1.70
3	206	2.54
4	116	3.39
5	74	4.24

3000K - CRI 80
09.2462.30C
09.2462.02C
09.2462.14C

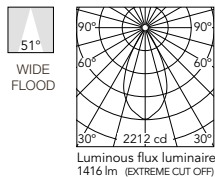

Beam Angle: 51°

h(m)	E(lx)	D(m)
1	2212	0.95
2	553	1.90
3	246	2.85
4	138	3.79
5	88	4.74

3000K - CRI 98
09.2452.30C
09.2452.02C
09.2452.14C

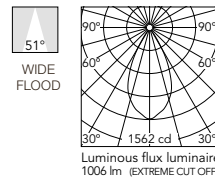

Beam Angle: 51°

h(m)	E(lx)	D(m)
1	1562	0.95
2	391	1.91
3	174	2.86
4	98	3.82
5	62	4.77

PURE SPOT

Pure Spot Track

Light Source: Power LED 15,7W - 1400 lm - 2700K/CRI 80 / 15,7W - 1400 lm - 3000K/CRI 80

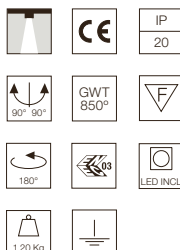
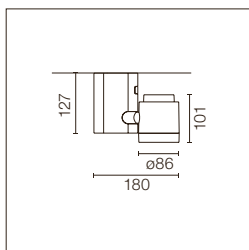

Proiettore per installazione su binario trifase con fonte di luce LED. Fonte di alimentazione 220/240V, 50/60Hz integrata.

Spotlight to be installed on 3-phase track with LED light source. 220/240V, 50/60Hz power supply integrated.

2700K - CRI 80

- 09.2405.30B
- 09.2405.02B
- 09.2405.14B

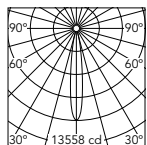

Beam Angle: 15°

h(m)	E(lx)	D(m)
1	13558	0.26
2	3390	0.52
3	1506	0.78
4	847	1.04
5	542	1.30

Luminous flux luminaire 1395 lm (EXTREME CUT OFF)

3000K - CRI 80

- 09.2415.30B
- 09.2415.02B
- 09.2415.14B

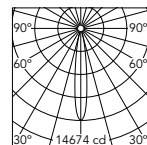

Beam Angle: 15°

h(m)	E(lx)	D(m)
1	14674	0.26
2	3668	0.52
3	1630	0.78
4	917	1.04
5	587	1.30

Luminous flux luminaire 1510 lm (EXTREME CUT OFF)

2700K - CRI 80

- 09.2406.30B
- 09.2406.02B
- 09.2406.14B

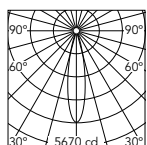

Beam Angle: 22°

h(m)	E(lx)	D(m)
1	5670	0.38
2	1417	0.77
3	630	1.15
4	354	1.54
5	227	1.92

Luminous flux luminaire 1318 lm (EXTREME CUT OFF)

3000K - CRI 80

- 09.2416.30B
- 09.2416.02B
- 09.2416.14B

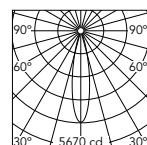

Beam Angle: 22°

h(m)	E(lx)	D(m)
1	5670	0.38
2	1417	0.77
3	630	1.15
4	354	1.54
5	227	1.92

Luminous flux luminaire 1318 lm (EXTREME CUT OFF)

2700K - CRI 80

- 09.2407.30B
- 09.2407.02B
- 09.2407.14B

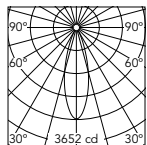

Beam Angle: 30°

h(m)	E(lx)	D(m)
1	3652	0.54
2	913	1.09
3	406	1.63
4	228	2.18
5	146	2.72

Luminous flux luminaire 1257 lm (EXTREME CUT OFF)

3000K - CRI 80

- 09.2417.30B
- 09.2417.02B
- 09.2417.14B

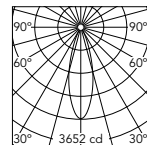

Beam Angle: 30°

h(m)	E(lx)	D(m)
1	3652	0.54
2	913	1.09
3	406	1.63
4	228	2.18
5	146	2.72

Luminous flux luminaire 1257 lm (EXTREME CUT OFF)

PURE SPOT

Pure Spot Ceiling

Light Source: Power LED 15,7W - 1400 lm - 2700K/CRI 80 / 15,7W - 1400 lm - 3000K/CRI 80

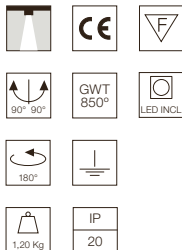
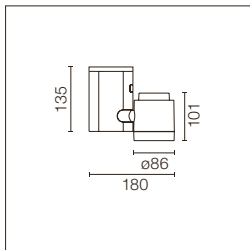

Proiettore per installazione a soffitto/parete con fonte di luce LED. Fonte di alimentazione 220/240V, 50/60Hz integrata.

Spotlight to be installed on ceiling/wall with LED light source. 220/240V, 50/60Hz power supply integrated

- 2700K - CRI 80**
- 09.2455.30B
 - 09.2455.02B
 - 09.2455.14B

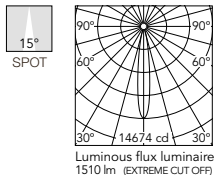

Beam Angle: 15°

h(m)	E(lx)	D(m)
1	14674	0.26
2	3668	0.52
3	1630	0.78
4	917	1.04
5	587	1.30

Luminous flux luminaire 1510 lm (EXTREME CUT OFF)

- 3000K - CRI 80**
- 09.2465.30B
 - 09.2465.02B
 - 09.2465.14B

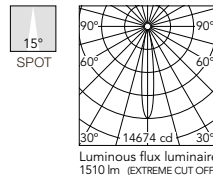

Beam Angle: 15°

h(m)	E(lx)	D(m)
1	14674	0.26
2	3668	0.52
3	1630	0.78
4	917	1.04
5	587	1.30

Luminous flux luminaire 1510 lm (EXTREME CUT OFF)

- 2700K - CRI 80**
- 09.2456.30B
 - 09.2456.02B
 - 09.2456.14B

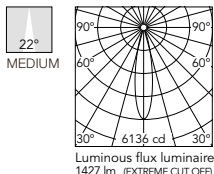

Beam Angle: 22°

h(m)	E(lx)	D(m)
1	6136	0.38
2	1534	0.77
3	682	1.15
4	384	1.54
5	245	1.92

Luminous flux luminaire 1427 lm (EXTREME CUT OFF)

- 3000K - CRI 80**
- 09.2466.30B
 - 09.2466.02B
 - 09.2466.14B

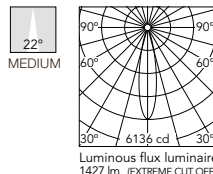

Beam Angle: 22°

h(m)	E(lx)	D(m)
1	6136	0.38
2	1534	0.77
3	682	1.15
4	384	1.54
5	245	1.92

Luminous flux luminaire 1427 lm (EXTREME CUT OFF)

- 2700K - CRI 80**
- 09.2457.30B
 - 09.2457.02B
 - 09.2457.14B

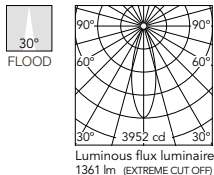

Beam Angle: 30°

h(m)	E(lx)	D(m)
1	3952	0.54
2	988	1.09
3	439	1.63
4	247	2.18
5	158	2.72

Luminous flux luminaire 1361 lm (EXTREME CUT OFF)

- 3000K - CRI 80**
- 09.2467.30B
 - 09.2467.02B
 - 09.2467.14B

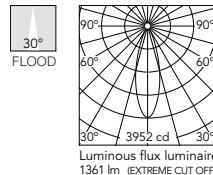

Beam Angle: 30°

h(m)	E(lx)	D(m)
1	3952	0.54
2	988	1.09
3	439	1.63
4	247	2.18
5	158	2.72

Luminous flux luminaire 1361 lm (EXTREME CUT OFF)

Pure Spot Pro Track

Light Source: LED Array 17,5W - 2115 lm - 3000K/CRI 80

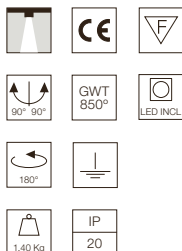
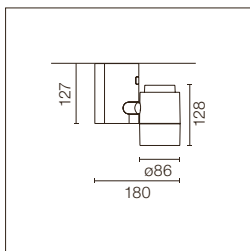

Proiettore per installazione su binario trifase con fonte di luce LED. Fonte di alimentazione 220/240V, 50/60Hz integrata.

Spotlight to be installed on 3-phase track with LED light source. 220/240V, 50/60Hz power supply integrated.

- 09.2580.30A
- 09.2580.02A
- 09.2580.14A

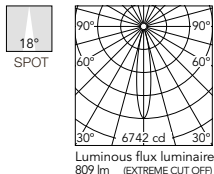

Beam Angle: 18°

h(m)	E(lx)	D(m)
1	6742	0.31
2	1685	0.62
3	749	0.94
4	421	1.25
5	270	1.56

Luminous flux luminaire 809 lm (EXTREME CUT OFF)

- 09.2581.30A
- 09.2581.02A
- 09.2581.14A

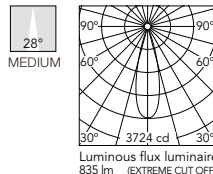

Beam Angle: 28°

h(m)	E(lx)	D(m)
1	3724	0.49
2	931	0.99
3	414	1.48
4	233	1.97
5	149	2.47

Luminous flux luminaire 835 lm (EXTREME CUT OFF)

PURE SPOT

Pure Spot Pro Ceiling

Light Source: LED Array 17,5W - 2115 lm - 3000K/CRI 80

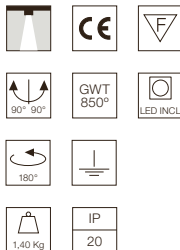
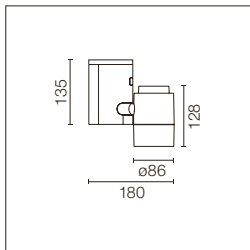

Proiettore per installazione a soffitto/parete con fonte di luce LED. Fonte di alimentazione 220/240V, 50/60Hz integrata.

Spotlight to be installed on ceiling/wall with LED light source. 220/240V, 50/60Hz power supply integrated

- 09.2585.30A
- 09.2585.02A
- 09.2585.14A

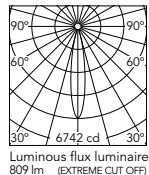

Beam Angle: 18°

h(m)	E(lx)	D(m)
1	6742	0.31
2	1685	0.62
3	749	0.94
4	421	1.25
5	270	1.56

- 09.2586.30A
- 09.2586.02A
- 09.2586.14A

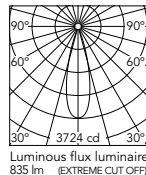

Beam Angle: 28°

h(m)	E(lx)	D(m)
1	3724	0.49
2	931	0.99
3	414	1.48
4	233	1.97
5	149	2.47

Pure Spot Pro Track

Light Source: Phosphor LED 19,5W - 2000 lm - 3000K/CRI 80 / 17W - 1400 lm - 3000K/CRI 98

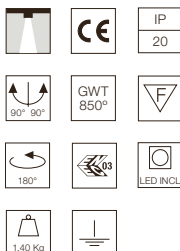
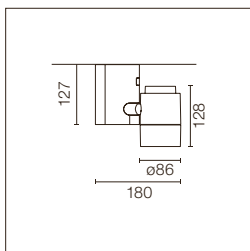

Proiettore per installazione su binario trifase con fonte di luce LED. Fonte di alimentazione 220-240V, 50-60Hz integrata.

Spotlight to be installed on 3-phase track with LED light source. Electronic transformer 220/240V, 50/60Hz for phosphor LED integrated.

- 3000K - CRI 80**
- 09.2430.30C
 - 09.2430.02C
 - 09.2430.14C

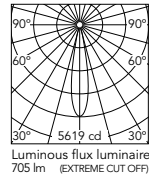

Beam Angle: 20°

h(m)	E(lx)	D(m)
1	5619	0.35
2	1405	0.69
3	624	1.04
4	351	1.38
5	225	1.73

- 3000K - CRI 98**
- 09.2420.30C
 - 09.2420.02C
 - 09.2420.14C

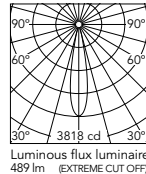

Beam Angle: 20°

h(m)	E(lx)	D(m)
1	3818	0.35
2	955	0.70
3	424	1.05
4	239	1.40
5	153	1.75

- 3000K - CRI 80**
- 09.2431.30C
 - 09.2431.02C
 - 09.2431.14C

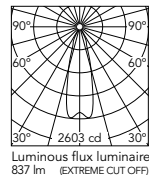

Beam Angle: 29°

h(m)	E(lx)	D(m)
1	2603	0.53
2	651	1.05
3	289	1.58
4	163	2.10
5	104	2.63

- 3000K - CRI 98**
- 09.2421.30C
 - 09.2421.02C
 - 09.2421.14C

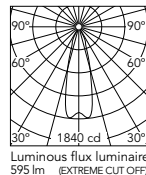

Beam Angle: 30°

h(m)	E(lx)	D(m)
1	1840	0.53
2	460	1.06
3	204	1.59
4	115	2.11
5	74	2.64

- 3000K - CRI 80**
- 09.2432.30C
 - 09.2432.02C
 - 09.2432.14C

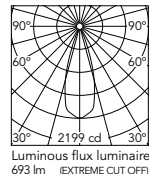

Beam Angle: 34°

h(m)	E(lx)	D(m)
1	2199	0.61
2	550	1.22
3	244	1.83
4	137	2.44
5	88	3.05

- 3000K - CRI 98**
- 09.2422.30C
 - 09.2422.02C
 - 09.2422.14C

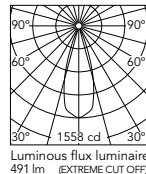

Beam Angle: 34°

h(m)	E(lx)	D(m)
1	1558	0.61
2	389	1.22
3	173	1.83
4	97	2.44
5	62	3.05

PURE SPOT

Pure Spot Pro Ceiling

Light Source: Phosphor LED 19,5W - 2000 lm - 3000K/CRI 80 / 17W - 1400 lm - 3000K/CRI 98

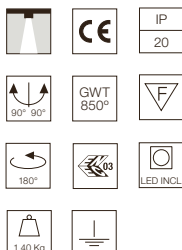
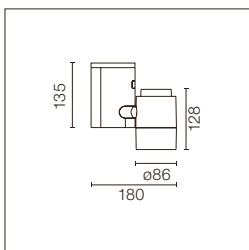

Proiettore per installazione a soffitto/ parete con fonte di luce LED.
Trasformatore elettronico 220/240V, 50/60Hz per LED a fosfori integrato.

Spotlight to be installed on ceiling/ wall with LED light source. Electronic transformer 220/240V, 50/60Hz for phosphor LED integrated.

- 3000K - CRI 80**
- 09.2480.30C
 - 09.2480.02C
 - 09.2480.14C

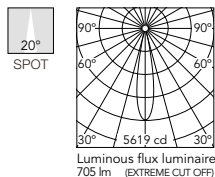

Beam Angle: 20°

h(m)	E(lx)	D(m)
1	5619	0.35
2	1405	0.69
3	624	1.04
4	351	1.38
5	225	1.73

- 3000K - CRI 98**
- 09.2470.30C
 - 09.2470.02C
 - 09.2470.14C

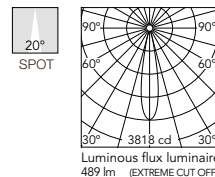

Beam Angle: 20°

h(m)	E(lx)	D(m)
1	3818	0.35
2	955	0.70
3	424	1.05
4	239	1.40
5	153	1.75

- 3000K - CRI 80**
- 09.2481.30C
 - 09.2481.02C
 - 09.2481.14C

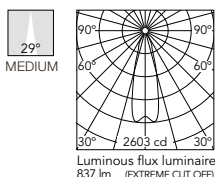

Beam Angle: 29°

h(m)	E(lx)	D(m)
1	2603	0.53
2	651	1.05
3	289	1.58
4	163	2.10
5	104	2.63

- 3000K - CRI 98**
- 09.2471.30C
 - 09.2471.02C
 - 09.2471.14C

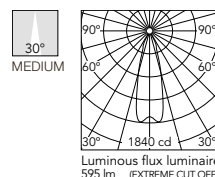

Beam Angle: 30°

h(m)	E(lx)	D(m)
1	1840	0.53
2	460	1.06
3	204	1.59
4	115	2.11
5	74	2.64

- 3000K - CRI 80**
- 09.2482.30C
 - 09.2482.02C
 - 09.2482.14C

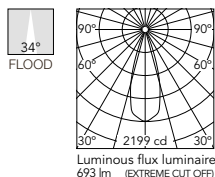

Beam Angle: 34°

h(m)	E(lx)	D(m)
1	2199	0.61
2	550	1.22
3	244	1.83
4	137	2.44
5	88	3.05

- 3000K - CRI 98**
- 09.2472.30C
 - 09.2472.02C
 - 09.2472.14C

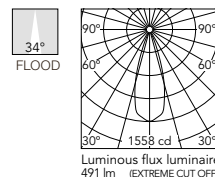

Beam Angle: 34°

h(m)	E(lx)	D(m)
1	1558	0.61
2	389	1.22
3	173	1.83
4	97	2.44
5	62	3.05

PURE SPOT

Pure Spot Pro Track

Light Source: Power LED 15,7W - 1400 lm - 2700K/CRI 80 / 15,7W - 1400 lm - 3000K/CRI 80

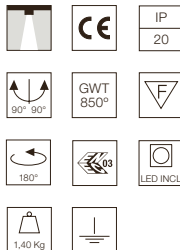
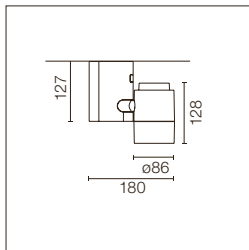

Proiettore per installazione su binario trifase con fonte di luce LED. Fonte di alimentazione 220/240V, 50/60Hz integrata.

Spotlight to be installed on 3-phase track with LED light source. 220/240V, 50/60Hz power supply integrated.

2700K - CRI 80

- 09.2425.30B
- 09.2425.02B
- 09.2425.14B

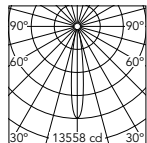

Beam Angle: 15°

h(m)	E(lx)	D(m)
1	13558	0.26
2	3390	0.52
3	1506	0.78
4	847	1.04
5	542	1.30

Luminous flux luminaire 1395 lm (EXTREME CUT OFF)

3000K - CRI 80

- 09.2435.30B
- 09.2435.02B
- 09.2435.14B

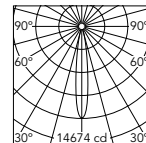

Beam Angle: 15°

h(m)	E(lx)	D(m)
1	14674	0.26
2	3668	0.52
3	1630	0.78
4	917	1.04
5	587	1.30

Luminous flux luminaire 1510 lm (EXTREME CUT OFF)

2700K - CRI 80

- 09.2426.30B
- 09.2426.02B
- 09.2426.14B

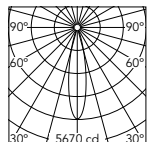

Beam Angle: 22°

h(m)	E(lx)	D(m)
1	5670	0.38
2	1417	0.77
3	630	1.15
4	354	1.54
5	227	1.92

Luminous flux luminaire 1318 lm (EXTREME CUT OFF)

3000K - CRI 80

- 09.2436.30B
- 09.2436.02B
- 09.2436.14B

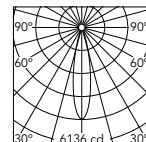

Beam Angle: 22°

h(m)	E(lx)	D(m)
1	6136	0.38
2	1534	0.77
3	682	1.15
4	384	1.54
5	245	1.92

Luminous flux luminaire 1427 lm (EXTREME CUT OFF)

2700K - CRI 80

- 09.2427.30B
- 09.2427.02B
- 09.2427.14B

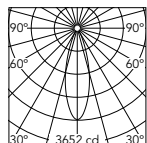

Beam Angle: 30°

h(m)	E(lx)	D(m)
1	3652	0.54
2	913	1.09
3	406	1.63
4	228	2.18
5	146	2.72

Luminous flux luminaire 1257 lm (EXTREME CUT OFF)

3000K - CRI 80

- 09.2437.30B
- 09.2437.02B
- 09.2437.14B

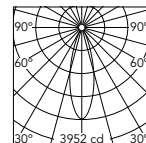

Beam Angle: 30°

h(m)	E(lx)	D(m)
1	3952	0.54
2	988	1.09
3	439	1.63
4	247	2.18
5	158	2.72

Luminous flux luminaire 1361 lm (EXTREME CUT OFF)

PURE SPOT

Pure Spot Pro Ceiling

Light Source: Power LED 15,7W - 1400 lm - 2700K/CRI 80 / 15,7W - 1400 lm - 3000K/CRI 80

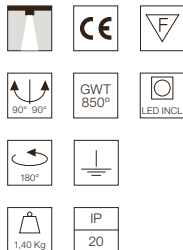
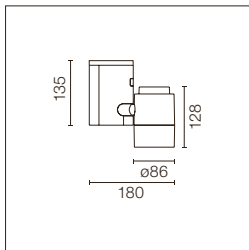

Proiettore per installazione a soffitto/parete con fonte di luce LED. Fonte di alimentazione 220/240V, 50/60Hz integrata.

Spotlight to be installed on ceiling/wall with LED light source. 220/240V, 50/60Hz power supply integrated.

- 2700K - CRI 80**
- 09.2475.30B
 - 09.2475.02B
 - 09.2475.14B

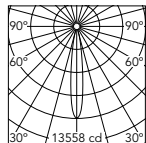

Beam Angle: 15°

h(m)	E(lx)	D(m)
1	13558	0.26
2	3390	0.52
3	1506	0.78
4	847	1.04
5	542	1.30

Luminous flux luminaire 1395 lm (EXTREME CUT OFF)

- 3000K - CRI 80**
- 09.2485.30B
 - 09.2485.02B
 - 09.2485.14B

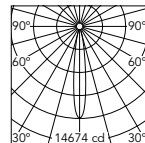

Beam Angle: 15°

h(m)	E(lx)	D(m)
1	14674	0.26
2	3668	0.52
3	1630	0.78
4	917	1.04
5	587	1.30

Luminous flux luminaire 1510 lm (EXTREME CUT OFF)

- 2700K - CRI 80**
- 09.2476.30B
 - 09.2476.02B
 - 09.2476.14B

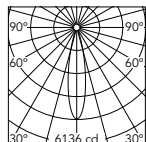

Beam Angle: 22°

h(m)	E(lx)	D(m)
1	6136	0.38
2	1534	0.77
3	682	1.15
4	384	1.54
5	245	1.92

Luminous flux luminaire 1427 lm (EXTREME CUT OFF)

- 3000K - CRI 80**
- 09.2486.30B
 - 09.2486.02B
 - 09.2486.14B

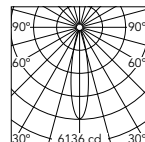

Beam Angle: 22°

h(m)	E(lx)	D(m)
1	6136	0.38
2	1534	0.77
3	682	1.15
4	384	1.54
5	245	1.92

Luminous flux luminaire 1427 lm (EXTREME CUT OFF)

- 2700K - CRI 80**
- 09.2477.30B
 - 09.2477.02B
 - 09.2477.14B

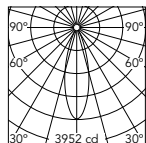

Beam Angle: 30°

h(m)	E(lx)	D(m)
1	3952	0.54
2	988	1.09
3	439	1.63
4	247	2.18
5	158	2.72

Luminous flux luminaire 1361 lm (EXTREME CUT OFF)

- 3000K - CRI 80**
- 09.2487.30B
 - 09.2487.02B
 - 09.2487.14B

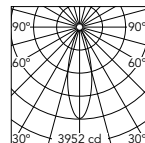

Beam Angle: 30°

h(m)	E(lx)	D(m)
1	3952	0.54
2	988	1.09
3	439	1.63
4	247	2.18
5	158	2.72

Luminous flux luminaire 1361 lm (EXTREME CUT OFF)

PURE SPOT

Accessori / Accessories

Pure Spot

Le lenti ellittiche, la griglia antiriverbero e i filtri vari devono sempre essere installati con l'anello di chiusura.

Elliptical lens, honeycomb filter, different filters and flood lens, must always be used with the holding ring.

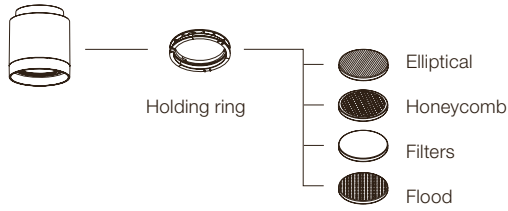

Anello di chiusura
Holding ring  08.8166.14

Honeycomb
Honeycomb  08.8169.14

Pure Spot Pro

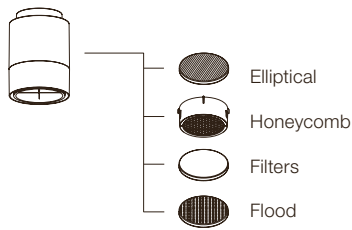

Honeycomb
Honeycomb  08.8186.14

Pure Spot / Pure Spot Pro

Lente ellittica
Elliptical lens  08.8163.68

Lente flood
Flood lens  08.8175.68

Filtro blu
Blue filter  08.8160.64.OD

Filtro azzurro
Sky blue filter  08.8160.65.OD

Filtro ambra
Amber filter  08.8160.66.OD

Filtro rosso
Red filter  08.8160.67.OD

Filtro anti U.V.
U.V. filter  08.8160.98.OD

Filtro anti I.R.
I.R. filter  08.8160.68

Hot light
Hot light  08.8160.69

Cold light
Cold light  08.8160.CL

Daylight
Daylight  08.8160.DL

Neodimium
Neodimium  08.8160.ND

Anello esterno PRO per Pure Spot. Solo per versioni ad alogeni. Consultare per versione LED.  08.8232.30
08.8232.02
08.8232.14

Pure Spot external ring accessory PRO. Only for halogen lamps. Consult for LED version.



LIGHT SOURCE
LED ARRAY
9,2W
945 lm
3000K/CRI 80



LIGHT SOURCE
LED
QT-14
G9

□ 30 Bianco
30 White

■ 05 Alluminio Lucido
05 Polished Aluminium

■ 14 Nero
14 Black

■ GN Verde
GN Green



Può essere ruotato di 360° e orientato di 60°.
Can be rotated 360° and swivelled 60°.

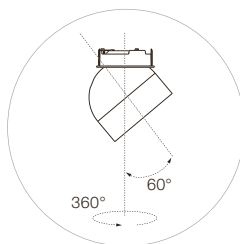

Descrizione

Apparecchio di illuminazione a parete o soffitto per illuminazione diretta. Corpo in alluminio con finiture cromata, bianco lucido, verde lucido e nero lucido. Schermo antiabbagliamento. L'apparecchio è dotato di due differenti anelli con finitura verde lucido e nero lucido, che hanno la funzione di riparare il vetro temperato di sicurezza.

Riflettori

Riflettore in alluminio sabbato e sbiancato chimicamente.

Unità di Alimentazione

Precablaggio incluso pronto per essere alimentato per mezzo di apparecchiature remote.

Informazioni Aggiuntive

Rotazione sull'asse verticale fino a 360° e orientamento fino a 60°.
Grado di protezione IP20.
Classe di isolamento II, III, a seconda delle versioni.
Adatti ad installazioni su superfici normalmente infiammabili.

Conformità e Marchi di Qualità

Apparecchio conforme alla Normativa Tecnica Europea EN60598-1 e relative parti seconde.

Description

Wall or ceiling lamp providing direct light. Aluminum body, available in chrome, shiny white, enameled green, and shiny black finishes. Low glare shield. Provided by two different ring due to fix the safety tempered glass, in shiny black and enameled green.

Reflectors

Sanded and chemically bleached aluminum reflector.

Power Supply

Pre-wiring included; ready for remote power supply.

Additional Information

0° - 360° vertical rotation and 0° - 60° adjustment.
IP20 protection grade.
Insulation class II, III depending on the versions.
Suitable for installation on normally inflammable surfaces.

Standard Compliance and Quality Marks

EN60598-1 European Technical Standards and any subsequent additions.

WAN SPOT

Wan Spot

Light Source: LED Array DC 500 mA - 9,2W - 945 lm - 3000K/CRI 80

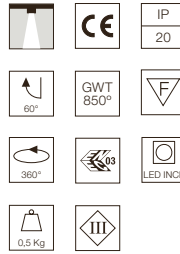
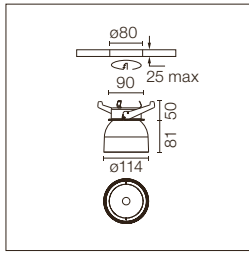

Apparecchio di illuminazione da installare ad incasso a soffitto/parete. Fonte di alimentazione esclusa.

Spotlight to be installed recessed on ceiling/wall. Power supply not included.

Alimentazioni raccomandate / Recommended power supply*:

Non Dimmable	60.9160
Dimmable 1-10V	RF27961
Dimmable Dali	RF26571
Dimmable Dali 2	60.9222
Mains Dimming	60.9411
Casambi	60.9207

* Vedi capitolo Drivers / Refer to the Drivers chapter

- 03.6174.30A
- 03.6174.05A
- 03.6174.14A
- 03.6174.GNA

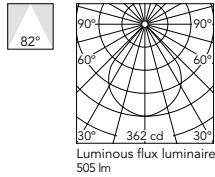

Beam Angle: 82°

h(m)	E(lx)	D(m)
1	362	1.75
2	91	3.50
3	40	5.25
4	23	7.00
5	14	8.75

Wan Spot

Light Source: LED QT-14 G9

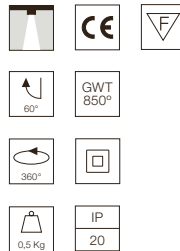
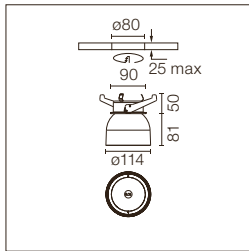

Apparecchio di illuminazione da installare ad incasso a soffitto/parete con alimentazione a tensione di rete.

Spotlight to be installed recessed on ceiling/wall with main voltage source.

- 03.6170.30
- 03.6170.05
- 03.6170.14
- 03.6170.GN

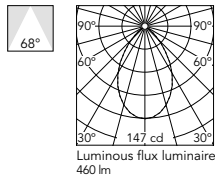

Beam Angle: 68°

h(m)	E(lx)	D(m)
1	147	1.35
2	37	2.70
3	16	4.05
4	9	5.40
5	6	6.75

@Black Ring

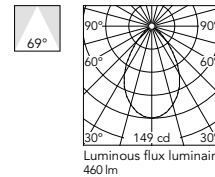

Beam Angle: 69°

h(m)	E(lx)	D(m)
1	149	1.38
2	37	2.75
3	17	4.13
4	9	5.50
5	6	6.88

@Green Ring

FORT KNOX

DESIGNED BY PHILIPPE STARCK

TRACK /
CEILING



LIGHT SOURCE

LED ARRAY
9,2W
945 lm
3000K/CRI 80
13,8W
1474 lm
3000K/CRI 80

□ 30 Bianco/RAL 9001
30 White



▒ 05 Alluminio Lucido
05 Polished Aluminium



■ 14 Nero/RAL 9005
14 Black



Può essere ruotato di 355° e orientato di 95°.
Can be rotated 355° and swivelled 95°.

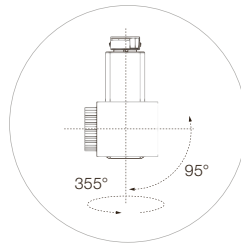

Descrizione

Apparecchio per installazione a plafone o mediante binario elettrico trifase.

Portalampane in materiale ceramico o in tecnopolimero autoestinguento, con cavi elettrici unipolari isolati Teflon con doppio isolamento trasparente. Corpo lampada costituito da un elemento dissipatore in alluminio, posto sopra il portalampane, da un anello reggi-schermi realizzato in materiale termoplastico di colore nero e da un vetro temperato di 4mm di spessore. Corpo, coperchio di chiusura e supporto orientabile della lampada sono in lega di alluminio presso fusa, con finiture lucidate a mano e protette con vernice trasparente a liquido, o verniciate a polvere di colore bianco o nero opaco. Adattatore trifase in materiale termoplastico.

Unità di Alimentazione

I dispositivi per l'alimentazione delle sorgenti luminose sono integrati nell'apparecchio e posizionati nel corpo principale.

Per le applicazioni a binario trifase l'apparecchio è dotato di disco di selezione rotante in senso orario o antiorario, che consente di selezionare la linea alla quale connettere elettricamente il proiettore.

Leva di sblocco che consente l'inserimento dell'adattatore.

Accessori

- Lente di distribuzione ellittica in vetro temprato di 4 mm.
- Filtri cromatici.

Informazioni Aggiuntive

Possibilità di rotazione a 355° sull'asse verticale, + 0° - 95° di orientamento orizzontale.

Grado di protezione IP20.

Classe di isolamento I, II, a seconda delle versioni.

Adatti ad installazioni su superfici normalmente infiammabili.

Gli apparecchi FLOS per binario trifase sono progettati e testati con i binari raccomandati da FLOS. La compatibilità è garantita con i binari prodotti da Nordic Aluminium e Eutrac. Per verificare la compatibilità con altri binari, contattare FLOS prima dell'installazione.

Conformità e Marchi di Qualità

Apparecchio conforme alla Normativa Tecnica Europea EN60598-1 e relative parti seconde.

Description

Luminaire for ceiling or three-phase electric track installation.

Self-extinguishing ceramic or engineering plastic lamp holders, with single-pole, transparent electric wires with double Teflon insulation. Aluminum body, placed above the lamp holder, black thermoplastic and 4mm tempered glass screen-support ring. Die-cast aluminum alloy body, cover and adjustable lamp support, with hand-polished finish and protected with transparent liquid paint, or powder-coated white or matt black. Thermoplastic three-phase adapter.

Power Supply

Power units built into the main body of the luminaire. For three-phase track applications, disc with clockwise and anti-clockwise rotation for spotlight selection. Release lever to insert adapter.

Accessories

- 4 mm tempered glass elliptical distribution lens.
- Chromatic filters.

Additional Information

0° - 355° vertical rotation, + 0° - 95° horizontal adjustment. IP20 protection grade.

Insulation class I, III depending on the versions.

Suitable for installation on normally inflammable surfaces.

FLOS three-phase lighting track luminaires are designed and fully tested for tracks recommended by FLOS.

Compatibility is guaranteed with three-phase track produced by Nordic Aluminium and Eutrac. To verify compatibility with any other track, please contact FLOS before installation.

Standard Compliance and Quality Marks

EN60598-1 European Technical Standards and any subsequent additions.



Ceiling



Track

FORT KNOX

Fort Knox Track

Light Source: LED Array 9,2W - 945 lm - 3000K/CRI 80 / 13,8W - 1474 lm - 3000K/CRI 80

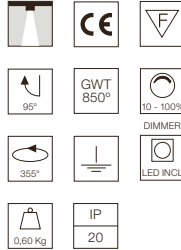
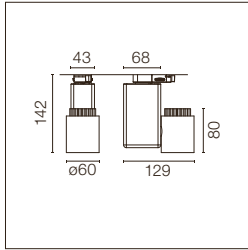

Proiettore per installazione su binario trifase con fonte di luce LED. Fonte di alimentazione 220-240V, 50-60Hz integrata.

Spotlight to be installed on 3-phase track with LED light source. 220-240V, 50-60Hz power supply included.

3000K - CRI 80

9,2W
Non Dimmable
09.2150.30A
09.2150.05A
09.2150.14A

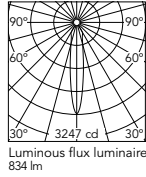

Beam Angle: 17°

h(m)	E(lx)	D(m)
1	3247	0.30
2	812	0.59
3	361	0.89
4	203	1.19
5	130	1.49

3000K - CRI 80

13,8W
Built-In Potentiometer
09.2160.30A
09.2160.05A
09.2160.14A

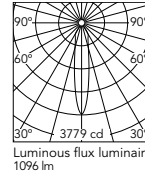

Beam Angle: 19°

h(m)	E(lx)	D(m)
1	3779	0.33
2	945	0.66
3	420	0.98
4	236	1.31
5	151	1.64

3000K - CRI 80

9,2W
Non Dimmable
09.2151.30A
09.2151.05A
09.2151.14A

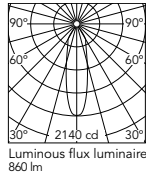

Beam Angle: 27°

h(m)	E(lx)	D(m)
1	2140	0.48
2	535	0.97
3	238	1.45
4	134	1.94
5	86	2.42

3000K - CRI 80

13,8W
Built-In Potentiometer
09.2161.30A
09.2161.05A
09.2161.14A

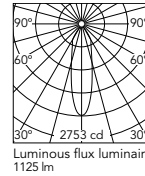

Beam Angle: 27°

h(m)	E(lx)	D(m)
1	2753	0.48
2	688	0.95
3	306	1.43
4	172	1.91
5	110	2.38

3000K - CRI 80

9,2W
Non Dimmable
09.2152.30A
09.2152.05A
09.2152.14A

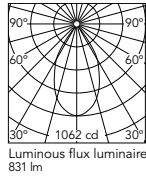

Beam Angle: 57°

h(m)	E(lx)	D(m)
1	1062	1.08
2	266	2.16
3	118	3.24
4	66	4.32
5	42	5.40

3000K - CRI 80

13,8W
Built-In Potentiometer
09.2162.30A
09.2162.05A
09.2162.14A

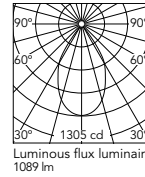

Beam Angle: 61°

h(m)	E(lx)	D(m)
1	1305	1.17
2	326	2.34
3	145	3.51
4	82	4.68
5	52	5.85

FORT KNOX

Fort Knox Ceiling

Light Source: LED Array 9,2W - 945 lm - 3000K/CRI 80 / 13,8W - 1474 lm - 3000K/CRI 80

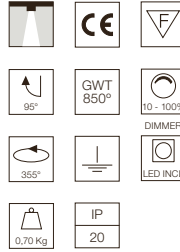
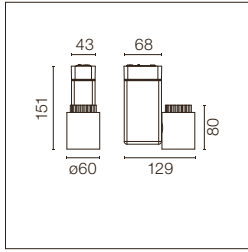

Proiettore per installazione a soffitto/ parete con fonte di luce LED. Fonte di alimentazione 220-240V, 50-60Hz integrata.

Spotlight to be installed on ceiling/ wall with LED light source. 220-240V, 50-60Hz power supply included.

3000K - CRI 80

9,2W
Non Dimmable
09.2155.30A
09.2155.05A
09.2155.14A

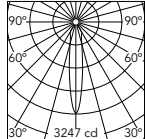

Beam Angle: 17°		
h(m)	E(lx)	D(m)
1	3247	0.30
2	812	0.59
3	361	0.89
4	203	1.19
5	130	1.49

Luminous flux luminaire 834 lm

3000K - CRI 80

13,8W
Built-In Potentiometer
09.2165.30A
09.2165.05A
09.2165.14A

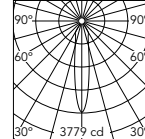

Beam Angle: 19°		
h(m)	E(lx)	D(m)
1	3779	0.33
2	945	0.66
3	420	0.98
4	236	1.31
5	151	1.64

Luminous flux luminaire 1096 lm

3000K - CRI 80

9,2W
Non Dimmable
09.2156.30A
09.2156.05A
09.2156.14A

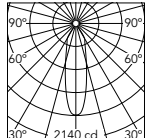

Beam Angle: 27°		
h(m)	E(lx)	D(m)
1	2140	0.48
2	535	0.97
3	238	1.45
4	134	1.94
5	86	2.42

Luminous flux luminaire 860 lm

3000K - CRI 80

13,8W
Built-In Potentiometer
09.2166.30A
09.2166.05A
09.2166.14A

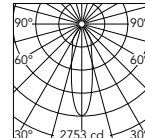

Beam Angle: 27°		
h(m)	E(lx)	D(m)
1	2753	0.48
2	688	0.95
3	306	1.43
4	172	1.91
5	110	2.38

Luminous flux luminaire 1125 lm

3000K - CRI 80

9,2W
Non Dimmable
09.2157.30A
09.2157.05A
09.2157.14A

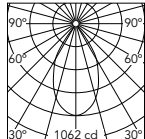

Beam Angle: 57°		
h(m)	E(lx)	D(m)
1	1062	1.08
2	266	2.16
3	118	3.24
4	66	4.32
5	42	5.40

Luminous flux luminaire 831 lm

3000K - CRI 80

13,8W
Built-In Potentiometer
09.2167.30A
09.2167.05A
09.2167.14A

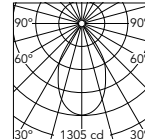

Beam Angle: 61°		
h(m)	E(lx)	D(m)
1	1305	1.17
2	326	2.34
3	145	3.51
4	82	4.68
5	52	5.85

Luminous flux luminaire 1089 lm

Accessori / Accessories

Honeycomb
Honeycomb



08.8502.14

Hot light
Hot light



08.8501.69

Filtro blu
Blue filter



08.8501.64.OD

Cold light
Cold light



08.8501.CL

Filtro azzurro
Sky blue filter



08.8501.65.OD

Daylight
Daylight



08.8501.DL

Filtro ambra
Amber filter



08.8501.66.OD

Neodimium
Neodimium



08.8501.ND

Filtro rosso
Red filter



08.8501.67.OD

CEILING / WALL

C1, UT Pro Surface, Kap Surface &
Suspension, Compass Box, Super Line & Pro,
Super Flat, Light Bell, Fort Knox
Wall & Mini, Thin LED, Wall System, G-O,
The Block of Light, Giano, Box.

MONO SPOT
CEILING SMALL

LIGHT SOURCE
POWER LED
6W
510 lm
2700K/CRI 90
560 lm
3000K/CRI 90

MONO SPOT
WALL SMALL

LIGHT SOURCE
POWER LED
6W
510 lm
2700K/CRI 90
560 lm
3000K/CRI 90

DOUBLE SPOT
WALL SMALL

LIGHT SOURCE
POWER LED
12W
1020 lm
2700K/CRI 90
1120 lm
3000K/CRI 90

MONO SPOT
CEILING LARGE

LIGHT SOURCE
POWER LED
Up to 14W
1225 lm
2700K/CRI 90
1300 lm
3000K/CRI 90

MONO SPOT
WALL LARGE

LIGHT SOURCE
POWER LED
Up to 14W
1225 lm
2700K/CRI 90
1300 lm
3000K/CRI 90

DOUBLE SPOT
WALL LARGE

LIGHT SOURCE
POWER LED
Up to 28W
2450 lm
2700K/CRI 90
2600 lm
3000K/CRI 90

□ DY Bianco
DY White

■ DR Antracite
DR Anthracite

■ EQ Rame Spazzolato
EQ Brushed Copper

■ ER Acciaio Spazzolato
ER Brushed Steel

■ ES Bronzo Spazzolato
ES Brushed Bronze



Può essere ruotato di 180° e orientato di 60°.
Can be rotated 180° and swivelled 60°.

Può essere ruotato di 355° e orientato di 60°.
Can be rotated 355° and swivelled 60°.

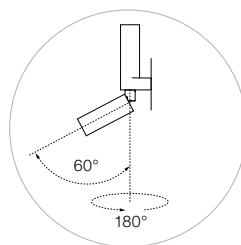

Wall

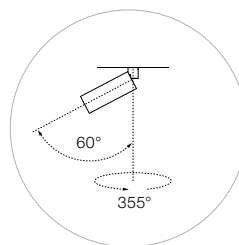

Ceiling

Descrizione

Un nuovo programma di apparecchi per installazione a parete e soffitto sviluppato ad-hoc per applicazioni residenziali e alberghiere.

Il design estremamente essenziale del prodotto nasconde uno speciale snodo meccanico integrato che consente di estrarre ed orientare il corpo lampada fino a 60° sull'asse verticale e sull'asse orizzontale (355° per la versione a incasso e 140° per la versione a parete) garantendo un'incredibile versatilità ideale per soddisfare le esigenze di qualsiasi progetto.

Le versioni sviluppate per installazione a parete sono disponibili con emissione singola o doppia.

Gruppo Ottico

Gruppo ottico ad elevato comfort visivo integrato nel corpo del prodotto e disponibile con aperture di fascio differenziate.

L'apparecchio è predisposto per produrre un'emissione di luce diffusa o una distribuzione più concentrata ideale per illuminazione d'accento o luce puntuale per la lettura in applicazioni da testa-letto.

Le versioni biemissione includono come accessorio uno schermo diffondente che può essere integrato all'interno del gruppo ottico per creare un effetto di luce soffusa.

Alimentazione

Tutti gli apparecchi vanno alimentati con driver remoto non incluso disponibile con varie alternative di controllo.

Sistema di Regolazione

Gli apparecchi possono essere controllati via 0/1-10V, DALI, Push Dimming e Casambi. Sistema di controllo in modalità broadcast. Negli apparecchi a doppia emissione è possibile controllare in maniera indipendente l'emissione diretta e quella indiretta.

Installazione

Il prodotto è predisposto per l'installazione su superfici di varia natura.

Tutti i prodotti vanno completati con un kit di montaggio dedicato per ottenere un'installazione No-trim o con Basetta. L'installazione No trim è compatibile esclusivamente con superfici in cartongesso con spessore minimo di 9mm e massimo 25mm.

L'installazione con Basetta consente di effettuare la connessione elettrica all'interno del supporto di superficie.

Informazione Aggiuntiva

Sistema elettrico controllato in corrente costante. Grado di protezione IP20.

Adatto per installazione su superfici normalmente infiammabili.

Conformità e Marchi di Qualità

Apparecchio conforme alla Normativa Tecnica Europea EN60598-1 e relative parti seconde.

Description

New program of wall and ceiling-mounted luminaires developed for residential and hospitality use.

The extremely minimalist design of the product hides a special, integrated mechanical connection that allows the luminaire body to be extracted and oriented up to 60° on the vertical axis and on the horizontal axis (355° in the ceiling version and 140° in the wall version), ensuring an impressive versatility, ideal to meet the needs of any project.

Versions developed for wall mounting are available with single or dual emission.

Optical Group

Optical group with high visual comfort in the body of the product, available with differentiated beamwidths.

This luminaire is designed to provide diffuse light emission or a more concentrated light distribution, ideal when accent or spot lighting is needed for reading in bed headboard applications.

Dual-emission models include a diffusing screen as accessory that can be integrated into the optical unit, producing a soft light effect.

Power Supply

All devices must be powered by a remote controller (not included) available with various control options.

Control System

Units can be controlled by 0/1-10V, DALI, Push Dimming and Casambi. Broadcast control system. In devices with dual emission, direct and indirect emissions can be controlled independently.

Installation

The product is ready to be installed on different surface types.

All products are completed with a dedicated No Trim or plate installation mounting kit. The No Trim installation is only compatible with plasterboard surfaces with a minimum thickness of 9mm and a maximum of 25mm. Plate installation allows the electrical connection to be made inside the surface mount.

Additional Information

Constant voltage controlled electrical system.

IP20 Protection Index.

Suitable for installation on normally flammable surfaces.

Standard Compliance and Quality Marks

EN60598-1 European Technical Standards and any subsequent additions.

Mono Spot Ceiling Small Ø35

Light Source: Power LED DC 500 mA - 6W - 510 lm - 2700K/CRI 90 / 6W - 560 lm - 3000K/CRI 90

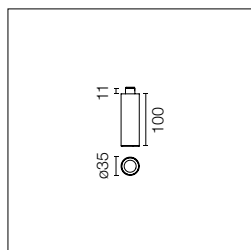

Apparecchio orientabile a LED per interni adatto per installazione a soffitto. Il corpo del prodotto può essere estratto dalla superficie di installazione e orientato di 60° sull'asse verticale e 355° sull'asse orizzontale.
Gruppo ottico Full cut-off integrato. Alimentazione remota (non inclusa) da posizionare in un luogo accessibile.

Adjustable luminaire with LED for indoor use, suitable for ceiling installation. The body can be extracted from the installation surface for 60° orientation on the vertical axis and 355° on the horizontal axis.
Integrated Full cut-off optical group. The remote power supply (not included) must be placed in an accessible location.

Alimentazioni raccomandate / Recommended power supply*:

Non Dimmable 60.9592
Dimmable 1-10V 60.9208
Dimmable Dali 2 / Push RF30699
Casambi 60.9207

* Vedi capitolo Drivers / Refer to the Drivers chapter

2700K

03.1220.DY
03.1220.DR
03.1220.EQ
03.1220.ER
03.1220.ES

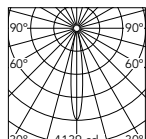

Beam Angle: 15°		
h(m)	E(lx)	D(m)
1	4139	0.26
2	1035	0.51
3	460	0.77
4	259	1.03
5	166	1.28

Luminous flux luminaire
376 lm

3000K

03.1225.DY
03.1225.DR
03.1225.EQ
03.1225.ER
03.1225.ES

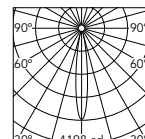

Beam Angle: 15°		
h(m)	E(lx)	D(m)
1	4198	0.26
2	1050	0.51
3	466	0.77
4	262	1.03
5	168	1.28

Luminous flux luminaire
382 lm

2700K

03.1221.DY
03.1221.DR
03.1221.EQ
03.1221.ER
03.1221.ES

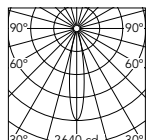

Beam Angle: 18°		
h(m)	E(lx)	D(m)
1	2640	0.32
2	660	0.65
3	293	0.97
4	165	1.30
5	106	1.62

Luminous flux luminaire
368 lm

3000K

03.1226.DY
03.1226.DR
03.1226.EQ
03.1226.ER
03.1226.ES

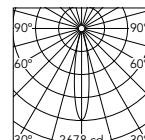

Beam Angle: 18°		
h(m)	E(lx)	D(m)
1	2678	0.32
2	669	0.65
3	298	0.97
4	167	1.30
5	107	1.62

Luminous flux luminaire
374 lm

Mono Spot Wall Small Ø35

Light Source: Power LED DC 500 mA - 6W - 510 lm - 2700K/CRI 90 / 6W - 560 lm - 3000K/CRI 90

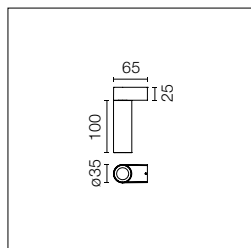

Apparecchio orientabile a LED per interni adatto per installazione a parete. Il corpo del prodotto può essere estratto dalla superficie di installazione e orientato di 60° sull'asse verticale e 180° sull'asse orizzontale.
Gruppo ottico Full cut-off integrato. Alimentazione remota (non inclusa) da posizionare in un luogo accessibile.

Adjustable luminaire with LED for indoor use, suitable for wall installation. The body can be extracted from the installation surface for 60° orientation on the vertical axis and 180° on the horizontal axis.
Integrated Full cut-off optical group. The remote power supply (not included) must be placed in an accessible location.

Alimentazioni raccomandate / Recommended power supply*:

Non Dimmable 60.9592
Dimmable 1-10V 60.9208
Dimmable Dali 2 / Push RF30699
Casambi 60.9207

* Vedi capitolo Drivers / Refer to the Drivers chapter

2700K

03.1200.DY
03.1200.DR
03.1200.EQ
03.1200.ER
03.1200.ES

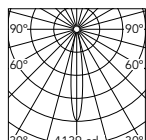

Beam Angle: 15°		
h(m)	E(lx)	D(m)
1	4139	0.26
2	1035	0.51
3	460	0.77
4	259	1.03
5	166	1.28

Luminous flux luminaire
376 lm

3000K

03.1205.DY
03.1205.DR
03.1205.EQ
03.1205.ER
03.1205.ES

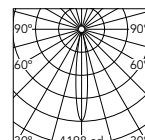

Beam Angle: 15°		
h(m)	E(lx)	D(m)
1	4198	0.26
2	1050	0.51
3	466	0.77
4	262	1.03
5	168	1.28

Luminous flux luminaire
382 lm

2700K

03.1201.DY
03.1201.DR
03.1201.EQ
03.1201.ER
03.1201.ES

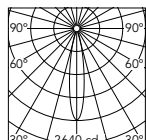

Beam Angle: 18°		
h(m)	E(lx)	D(m)
1	2640	0.32
2	660	0.65
3	293	0.97
4	165	1.30
5	106	1.62

Luminous flux luminaire
368 lm

3000K

03.1206.DY
03.1206.DR
03.1206.EQ
03.1206.ER
03.1206.ES

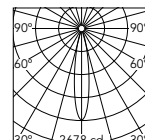

Beam Angle: 18°		
h(m)	E(lx)	D(m)
1	2678	0.32
2	669	0.65
3	298	0.97
4	167	1.30
5	107	1.62

Luminous flux luminaire
374 lm

Double Spot Wall Small Ø35

Light Source: Power LED DC 500 mA - 12W - 1020 lm - 2700K/CRI 90 / 12W - 1120 lm - 3000K/CRI 90

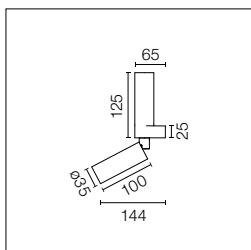

Apparecchio orientabile a LED per interni adatto per installazione a parete. Il corpo inferiore del prodotto può essere estratto dalla superficie di installazione e orientato di 60° sull'asse verticale e 180° sull'asse orizzontale.
Gruppo ottico Full cut-off integrato. Accessori integrati (lente diffondente up).
Alimentazione remota (non inclusa) da posizionare in un luogo accessibile.

Adjustable luminaire with LED for indoor use, suitable for wall installation. The lower part of the body can be extracted from the installation surface for 60° orientation on the vertical axis and 180° on the horizontal axis.
Integrated Full cut-off optical group. Accessories integrated (up diffuser).
The remote power supply (not included) must be placed in an accessible location.

Alimentazioni raccomandate / Recommended power supply*:

Non Dimmable	60.9592
Dimmable 1-10V	60.9208
Dimmable Dalí 2 / Push	RF30699
Casambi	60.9207

* Vedi capitolo Drivers / Refer to the Drivers chapter

2700K

03.1210.DY
03.1210.DR
03.1210.EQ
03.1210.ER
03.1210.ES

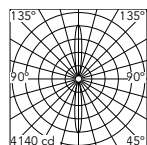

Beam Angle: 15°

h(m)	E(lx)	D(m)
1	4140	0.26
2	1035	0.51
3	460	0.77
4	259	1.03
5	166	1.28

** Luminous flux luminaire
753 lm

2700K

03.1211.DY
03.1211.DR
03.1211.EQ
03.1211.ER
03.1211.ES

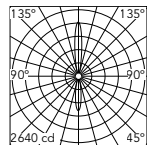

Beam Angle: 18°

h(m)	E(lx)	D(m)
1	2640	0.32
2	660	0.65
3	293	0.97
4	165	1.30
5	106	1.62

** Luminous flux luminaire
745 lm

3000K

03.1215.DY
03.1215.DR
03.1215.EQ
03.1215.ER
03.1215.ES

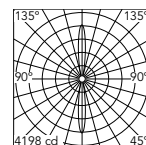

Beam Angle: 15°

h(m)	E(lx)	D(m)
1	4198	0.26
2	1049	0.51
3	466	0.77
4	263	1.03
5	168	1.28

** Luminous flux luminaire
763 lm

3000K

03.1216.DY
03.1216.DR
03.1216.EQ
03.1216.ER
03.1216.ES

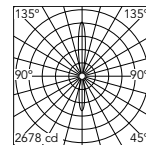

Beam Angle: 18°

h(m)	E(lx)	D(m)
1	2678	0.32
2	669	0.65
3	298	0.97
4	168	1.30
5	107	1.62

** Luminous flux luminaire
755 lm

** Dati fotometrici senza lente diffondente up / Photometric data without up diffuser.

Mono Spot Ceiling Large Ø56

Light Source: Power LED DC 950 mA - 11W - 970 lm - 2700K/CRI 90 / 11W - 1050 lm - 3000K/CRI 90
 Power LED DC 1200 mA - 14W - 1225 lm - 2700K/CRI 90 / 14W - 1300 lm - 3000K/CRI 90

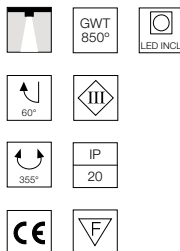
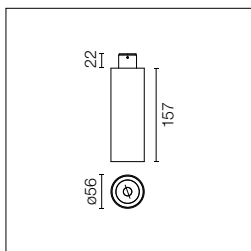

Apparecchio orientabile a LED per interni adatto per installazione a soffitto. Il corpo del prodotto può essere estratto dalla superficie di installazione e orientato di 60° sull'asse verticale e 355° sull'asse orizzontale.
 Gruppo ottico Full cut-off integrato. Alimentazione remota (non inclusa) da posizionare in un luogo accessibile.

Adjustable luminaire with LED for indoor use, suitable for ceiling installation. The body can be extracted from the installation surface for 60° orientation on the vertical axis and 355° on the horizontal axis.
 Integrated Full cut-off optical group. The remote power supply (not included) must be placed in an accessible location.

Alimentazioni raccomandate / Recommended power supply*:

	950 mA	1200 mA
Non Dimmable	RF27370	60.9276
Dimmable Dali 2 / Push	RF30699	60.9276
Dimmable 0/1-10V	60.9439	60.9276
Casambi	60.9207	60.9276+60.9392

* Vedi capitolo Drivers / Refer to the Drivers chapter

- 2700K**
 03.1250.DY
 03.1250.DR
 03.1250.EQ
 03.1250.ER
 03.1250.ES

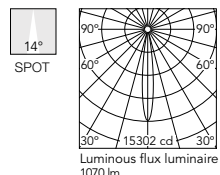

h(m)	E(lx)	D(m)
1	15302	0.24
2	3825	0.48
3	1700	0.72
4	956	0.96
5	612	1.20

Luminous flux luminaire 1070 lm

- 3000K**
 03.1255.DY
 03.1255.DR
 03.1255.EQ
 03.1255.ER
 03.1255.ES

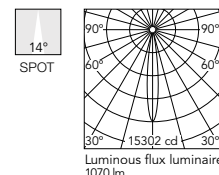

h(m)	E(lx)	D(m)
1	15302	0.24
2	3825	0.48
3	1700	0.72
4	956	0.96
5	612	1.20

Luminous flux luminaire 1070 lm

- 2700K**
 03.1251.DY
 03.1251.DR
 03.1251.EQ
 03.1251.ER
 03.1251.ES

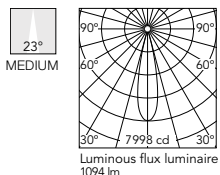

h(m)	E(lx)	D(m)
1	7998	0.40
2	1999	0.80
3	889	1.20
4	500	1.60
5	320	2.00

Luminous flux luminaire 1094 lm

- 3000K**
 03.1256.DY
 03.1256.DR
 03.1256.EQ
 03.1256.ER
 03.1256.ES

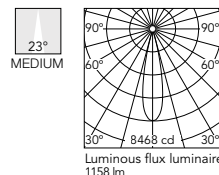

h(m)	E(lx)	D(m)
1	8468	0.40
2	2117	0.80
3	941	1.20
4	529	1.60
5	339	2.00

Luminous flux luminaire 1158 lm

- 2700K**
 03.1252.DY
 03.1252.DR
 03.1252.EQ
 03.1252.ER
 03.1252.ES

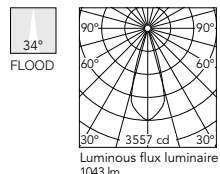

h(m)	E(lx)	D(m)
1	3557	0.61
2	889	1.22
3	395	1.83
4	222	2.43
5	142	3.04

Luminous flux luminaire 1043 lm

- 3000K**
 03.1257.DY
 03.1257.DR
 03.1257.EQ
 03.1257.ER
 03.1257.ES

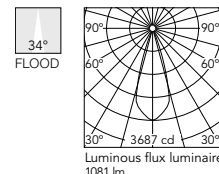

h(m)	E(lx)	D(m)
1	3687	0.61
2	922	1.22
3	410	1.83
4	230	2.43
5	147	3.04

Luminous flux luminaire 1081 lm

- 2700K**
 03.1253.DY
 03.1253.DR
 03.1253.EQ
 03.1253.ER
 03.1253.ES

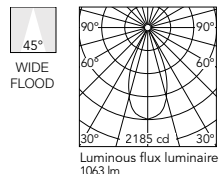

h(m)	E(lx)	D(m)
1	2185	0.84
2	546	1.68
3	243	2.52
4	137	3.35
5	87	4.19

Luminous flux luminaire 1063 lm

- 3000K**
 03.1258.DY
 03.1258.DR
 03.1258.EQ
 03.1258.ER
 03.1258.ES

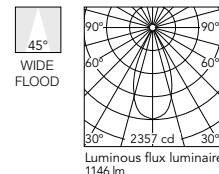

h(m)	E(lx)	D(m)
1	2357	0.84
2	589	1.68
3	262	2.52
4	147	3.35
5	94	4.19

Luminous flux luminaire 1146 lm

Mono Spot Wall Large Ø56

Light Source: Power LED DC 950 mA - 11W - 970 lm - 2700K/CRI 90 / 11W - 1050 lm - 3000K/CRI 90
 Power LED DC 1200 mA - 14W - 1225 lm - 2700K/CRI 90 / 14W - 1300 lm - 3000K/CRI 90

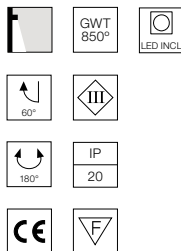
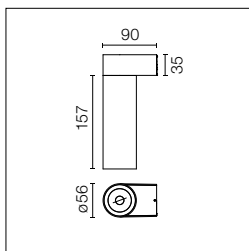

Apparecchio orientabile a LED per interni adatto per installazione a parete. Il corpo del prodotto può essere estratto dalla superficie di installazione e orientato di 60° sull'asse verticale e 180° sull'asse orizzontale.
 Gruppo ottico Full cut-off integrato. Alimentazione remota (non inclusa) da posizionare in un luogo accessibile.

Adjustable luminaire with LED for indoor use, suitable for wall installation. The body can be extracted from the installation surface for 60° orientation on the vertical axis and 180° on the horizontal axis.
 Integrated Full cut-off optical group. The remote power supply (not included) must be placed in an accessible location.

Alimentazioni raccomandate / Recommended power supply*:

	950 mA	1200 mA
Non Dimmable	RF27370	60.9276
Dimmable Dali 2 / Push	RF30699	60.9276
Dimmable 0/1-10V	60.9439	60.9276
Casambi	60.9207	60.9276+60.9392

* Vedi capitolo Drivers / Refer to the Drivers chapter

- 2700K**
 03.1230.DY
 03.1230.DR
 03.1230.EQ
 03.1230.ER
 03.1230.ES

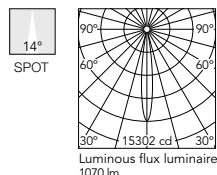

Beam Angle: 14°

h(m)	E(lx)	D(m)
1	15302	0.24
2	3825	0.48
3	1700	0.72
4	956	0.96
5	612	1.20

Luminous flux luminaire 15302 cd
 1070 lm

- 3000K**
 03.1235.DY
 03.1235.DR
 03.1235.EQ
 03.1235.ER
 03.1235.ES

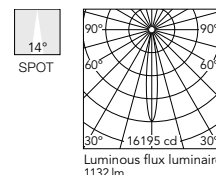

Beam Angle: 14°

h(m)	E(lx)	D(m)
1	16195	0.24
2	4049	0.48
3	1799	0.72
4	1012	0.96
5	648	1.20

Luminous flux luminaire 16195 cd
 1132 lm

- 2700K**
 03.1231.DY
 03.1231.DR
 03.1231.EQ
 03.1231.ER
 03.1231.ES

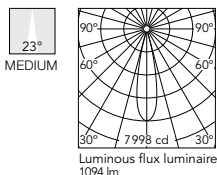

Beam Angle: 23°

h(m)	E(lx)	D(m)
1	7998	0.40
2	1999	0.80
3	889	1.20
4	500	1.60
5	320	2.00

Luminous flux luminaire 7998 cd
 1094 lm

- 3000K**
 03.1236.DY
 03.1236.DR
 03.1236.EQ
 03.1236.ER
 03.1236.ES

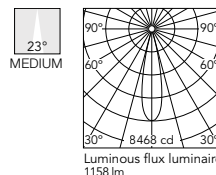

Beam Angle: 23°

h(m)	E(lx)	D(m)
1	8468	0.40
2	2117	0.80
3	941	1.20
4	529	1.60
5	339	2.00

Luminous flux luminaire 8468 cd
 1158 lm

- 2700K**
 03.1232.DY
 03.1232.DR
 03.1232.EQ
 03.1232.ER
 03.1232.ES

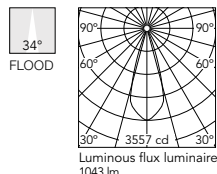

Beam Angle: 34°

h(m)	E(lx)	D(m)
1	3557	0.61
2	889	1.22
3	395	1.83
4	222	2.43
5	142	3.04

Luminous flux luminaire 3557 cd
 1043 lm

- 3000K**
 03.1237.DY
 03.1237.DR
 03.1237.EQ
 03.1237.ER
 03.1237.ES

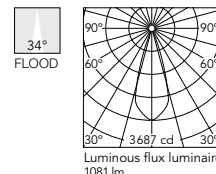

Beam Angle: 34°

h(m)	E(lx)	D(m)
1	3687	0.61
2	922	1.22
3	410	1.83
4	230	2.43
5	147	3.04

Luminous flux luminaire 3687 cd
 1081 lm

- 2700K**
 03.1233.DY
 03.1233.DR
 03.1233.EQ
 03.1233.ER
 03.1233.ES

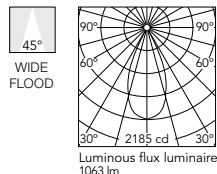

Beam Angle: 45°

h(m)	E(lx)	D(m)
1	2185	0.84
2	546	1.68
3	243	2.52
4	137	3.35
5	87	4.19

Luminous flux luminaire 2185 cd
 1063 lm

- 3000K**
 03.1238.DY
 03.1238.DR
 03.1238.EQ
 03.1238.ER
 03.1238.ES

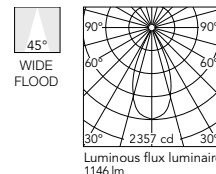

Beam Angle: 45°

h(m)	E(lx)	D(m)
1	2357	0.84
2	589	1.68
3	262	2.52
4	147	3.35
5	94	4.19

Luminous flux luminaire 2357 cd
 1146 lm

Double Spot Wall Large Ø56

Light Source: Power LED DC 950 mA - 22W - 1940 lm - 2700K/CRI 90 / 22W - 2100 lm - 3000K/CRI 90
 Power LED DC 1200 mA - 28W - 2450 lm - 2700K/CRI 90 / 28W - 2600 lm - 3000K/CRI 90

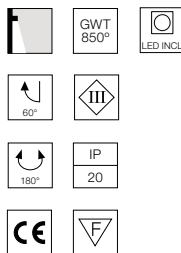
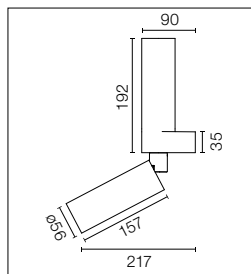

Apparecchio orientabile a LED per interni adatto per installazione a parete. Il corpo inferiore del prodotto può essere estratto dalla superficie di installazione e orientato di 60° sull'asse verticale e 180° sull'asse orizzontale.
 Gruppo ottico Full cut-off integrato. Accessori integrati (lente diffondente up).
 Alimentazione remota (non inclusa) da posizionare in un luogo accessibile.

Adjustable luminaire with LED for indoor use, suitable for wall installation. The lower part of the body can be extracted from the installation surface for 60° orientation on the vertical axis and 180° on the horizontal axis.
 Integrated Full cut-off optical group. Accessories integrated (up diffuser).
 The remote power supply (not included) must be placed in an accessible location.

Alimentazioni raccomandate / Recommended power supply*:

	950 mA	1200 mA
Non Dimmable	RF27370	60.9276
Dimmable Dali 2 / Push	RF30699	60.9276
Dimmable 0/1-10V	60.9439	60.9276
Casambi	60.9207	60.9276+60.9392

* Vedi capitolo Drivers / Refer to the Drivers chapter

- 2700K**
 03.1240.DY
 03.1240.DR
 03.1240.EQ
 03.1240.ER
 03.1240.ES

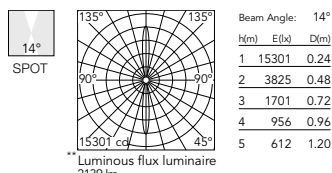

- 3000K**
 03.1245.DY
 03.1245.DR
 03.1245.EQ
 03.1245.ER
 03.1245.ES

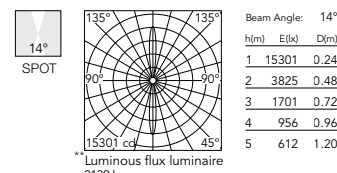

- 2700K**
 03.1241.DY
 03.1241.DR
 03.1241.EQ
 03.1241.ER
 03.1241.ES

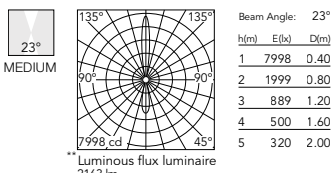

- 3000K**
 03.1246.DY
 03.1246.DR
 03.1246.EQ
 03.1246.ER
 03.1246.ES

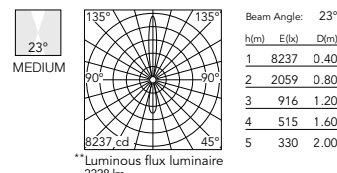

- 2700K**
 03.1242.DY
 03.1242.DR
 03.1242.EQ
 03.1242.ER
 03.1242.ES

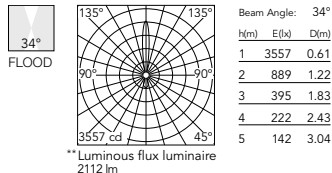

- 3000K**
 03.1247.DY
 03.1247.DR
 03.1247.EQ
 03.1247.ER
 03.1247.ES

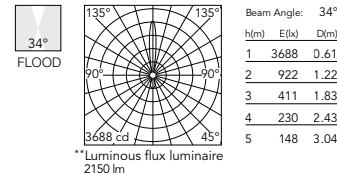

- 2700K**
 03.1243.DY
 03.1243.DR
 03.1243.EQ
 03.1243.ER
 03.1243.ES

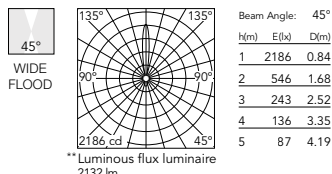

- 3000K**
 03.1248.DY
 03.1248.DR
 03.1248.EQ
 03.1248.ER
 03.1248.ES

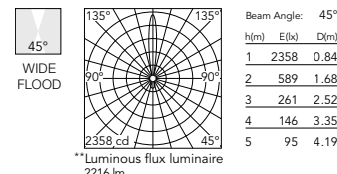

** Dati fotometrici senza lente diffondente up / Photometric data without up diffuser.

HOW TO ORDER C 1

	SURFACE					RECESSED			
	SMALL			LARGE		SMALL		LARGE	
	Ceiling	Wall	Wall flush	Ceiling	Wall flush	Ceiling	Wall	Ceiling	Wall
Mono Spot									
Mono Spot									
Double Spot									

C 1

Accessori / Accessories

Cornice di installazione No Trim per installazione a parete.	No Trim installation frame for wall mounting.			C1 Wall Small Mono 08.0206.00 C1 Wall Small Double 08.0227.00
Cornice di installazione No Trim per installazione a parete.	No Trim installation frame for wall mounting.			C1 Wall Large Mono 08.0205.00 C1 Wall Large Double 08.0226.00
Cornice di installazione No Trim per installazione a soffitto.	No Trim installation frame for ceiling mounting.			C1 Ceiling Small 08.0208.00
Cornice di installazione No Trim per installazione a soffitto.	No Trim installation frame for ceiling mounting.			C1 Ceiling Large 08.0207.00
Supporto in alluminio verniciato per installazione superficiale a parete.	Coated aluminum mount for surface installation (wall).			C1 Wall Small Mono 08.0209.DY 08.0209.DR 08.0209.EQ 08.0209.ER 08.0209.ES C1 Wall Small Double 08.0228.DY 08.0228.DR 08.0228.EQ 08.0228.ER 08.0228.ES
Supporto in alluminio per l'installazione a filo della superficie (a parete). Adatto a superfici resistenti come il mattone, il legno o il cemento. Non adatto a pareti in cartongesso.	Aluminum mount for surface flush installation (wall). Fit for resistant surfaces such as brick, wood or concrete. Not valid for plasterboard walls.			C1 Wall Small Mono 08.0231.00 C1 Wall Small Double 08.0255.00 C1 Wall Large Mono 08.0210.00 C1 Wall Large Double 08.0254.00
Supporto in alluminio verniciato per installazione superficiale a soffitto.	Coated aluminum mount for surface installation (ceiling).			C1 Ceiling Small 08.0211.DY 08.0211.DR 08.0211.EQ 08.0211.ER 08.0211.ES
Supporto in alluminio verniciato per installazione superficiale a soffitto.	Coated aluminum mount for surface installation (ceiling).			C1 Ceiling Large 08.0212.DY 08.0212.DR 08.0212.EQ 08.0212.ER 08.0212.ES

UT PRO SURFACE

DESIGNED BY FLOS ARCHITECTURAL

UT PRO SURFACE 150



LIGHT SOURCE
LED ARRAY
23,5W
2300 lm
3000K/CRI 80
1950 lm
3000K/CRI 90
2009 lm
4000K/CRI 90

UT PRO SURFACE 175



LIGHT SOURCE
LED ARRAY
35,3W
4145 lm
3000K/CRI 80
3425 lm
3000K/CRI 90
3569 lm
4000K/CRI 90

□ 40 Bianco
40 White



■ 14 Nero
14 Black



Descrizione

Apparecchio di illuminazione da interni per montaggio a superficie, disponibile con sorgenti luminose con tecnologia LED ad alta potenza e regolatore incluso. Il corpo ottico dell'apparecchio e il contenitore degli alimentatori sono in alluminio iniettato ad alta pressione, rifiniti con verniciatura a polvere color bianco o nero. Gli apparecchi vengono accompagnati da una fonte di alimentazione incorporata nell'apparecchio.

Sistema Ottico

Sono disponibili con ottiche spot, medium e flood e con riflettori di vetro borosilicato ad alta efficienza incorporato.

Accessori

Disponibile crocetta di schermatura, lente ellittica, lente Flood e Honeycomb.

Informazioni Aggiuntive

Possibilità di rotazione a 360° su asse verticale e a 90° su asse orizzontale. Meccanismo di blocco dell'asse orizzontale incorporato.
Grado di protezione IP20.

Conformità e Marchi di Qualità

Apparecchio conforme alla Normativa Tecnica Europea EN60598-1 e relative parti seconde.

Description

Indoor luminaire for surface installation, available in high power, LED technology light sources and regulator included.

The optical housing of the luminaire, as well as the container of the power supply equipment, is manufactured in high-pressure injected aluminium, with white or black finishes.

The luminaires include a power supply unit in the luminaire's own body.

Optic System

Available with spot, medium and flood optics and a built-in high-efficiency borosilicate glass reflector.

Accessories

Shielding cylinder, elliptical lens, flood and honeycomb lens.

Additional Information

Possibility of 360° rotation in the vertical axis and 90° rotation in the horizontal axis. Blocking mechanism for horizontal axis integrated.
IP20 protection grade.

Compliance of Standards and Quality Marks

EN60598-1 European Technical Standards and any subsequent additions.

UT PRO SURFACE

UT Pro Surface 150

Light Source: LED Array 23,5W - 2300 lm - 3000K/CRI 80 / 23,5W - 1950 lm - 3000K/CRI 90 / 23,5W - 2009 lm - 4000K/CRI 90

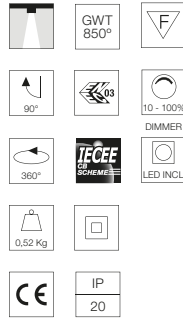
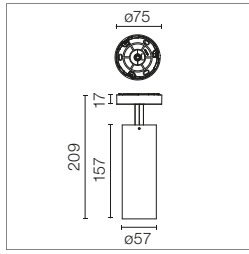

Proiettore da installare a superficie con sorgente luminosa LED. Fonte di alimentazione 120-277V e potenziometro inclusi.

LED light source projector for surface installation. 120-277V power supply unit and potentiometer included.

3000K - CRI 80
On board dimmer
09.7290.40A
09.7290.14A

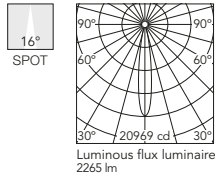

3000K - CRI 90
On board dimmer
09.7296.40A
09.7296.14A

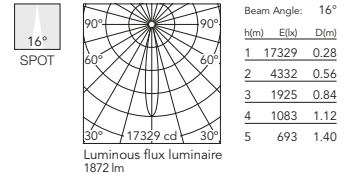

4000K - CRI 90
On board dimmer
09.7291.40A
09.7291.14A

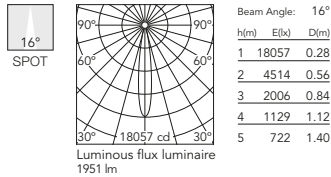

3000K - CRI 80
On board dimmer
09.7292.40A
09.7292.14A

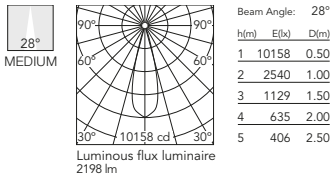

3000K - CRI 90
On board dimmer
09.7297.40A
09.7297.14A

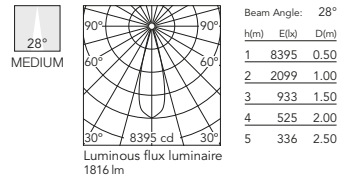

4000K - CRI 90
On board dimmer
09.7293.40A
09.7293.14A

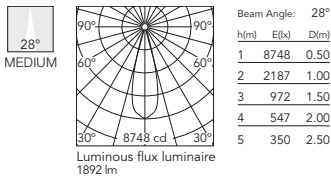

3000K - CRI 80
On board dimmer
09.7294.40A
09.7294.14A

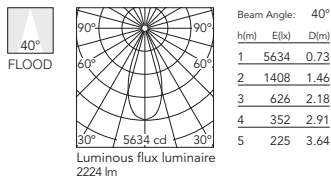

3000K - CRI 90
On board dimmer
09.7298.40A
09.7298.14A

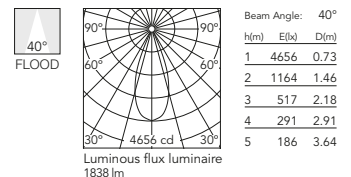

4000K - CRI 90
On board dimmer
09.7295.40A
09.7295.14A

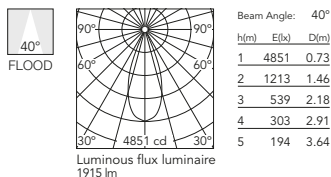

UT PRO SURFACE

UT Pro Surface 175

Light Source: LED Array 35,3W - 3950 lm - 3000K/CRI 80 / 35,3W - 3250 lm - 3000K/CRI 90 / 35,3W - 3400 lm - 4000K/CRI 90

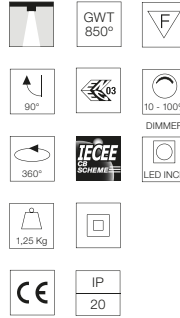
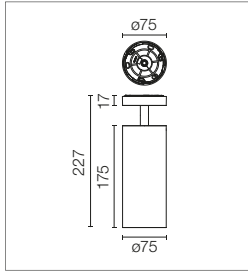

Proiettore da installare a superficie con sorgente luminosa LED. Fonte di alimentazione 120-277V e potenziometro inclusi.

LED light source projector for surface installation. 120-277V power supply unit and potentiometer included.

3000K - CRI 80
On board dimmer
09.7320.40
09.7320.14

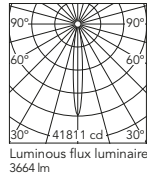

Beam Angle: 12°

h(m)	E(lx)	D(m)
1	41811	0.21
2	10453	0.41
3	4646	0.62
4	2613	0.83
5	1672	1.03

3000K - CRI 90
On board dimmer
09.7321.40
09.7321.14

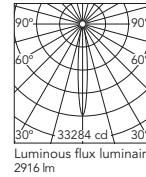

Beam Angle: 12°

h(m)	E(lx)	D(m)
1	33284	0.21
2	8321	0.41
3	3698	0.62
4	2080	0.83
5	1331	1.03

4000K - CRI 90
On board dimmer
09.7322.40
09.7322.14

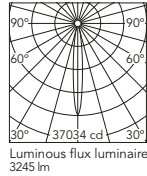

Beam Angle: 12°

h(m)	E(lx)	D(m)
1	37034	0.21
2	9258	0.41
3	4115	0.62
4	2315	0.83
5	1481	1.03

3000K - CRI 80
On board dimmer
09.7323.40
09.7323.14

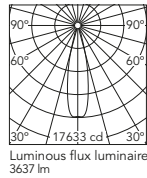

Beam Angle: 25°

h(m)	E(lx)	D(m)
1	17633	0.44
2	4408	0.88
3	1959	1.32
4	1102	1.76
5	705	2.20

3000K - CRI 90
On board dimmer
09.7324.40
09.7324.14

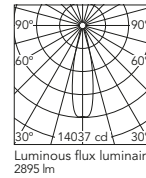

Beam Angle: 25°

h(m)	E(lx)	D(m)
1	14037	0.44
2	3509	0.88
3	1560	1.32
4	877	1.76
5	561	2.20

4000K - CRI 90
On board dimmer
09.7325.40
09.7325.14

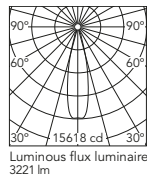

Beam Angle: 25°

h(m)	E(lx)	D(m)
1	15618	0.44
2	3904	0.88
3	1735	1.32
4	976	1.76
5	625	2.20

3000K - CRI 80
On board dimmer
09.7326.40
09.7326.14

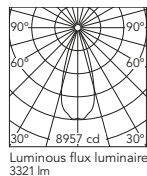

Beam Angle: 37°

h(m)	E(lx)	D(m)
1	8957	0.66
2	2239	1.32
3	995	1.98
4	560	2.65
5	358	3.31

3000K - CRI 90
On board dimmer
09.7327.40
09.7327.14

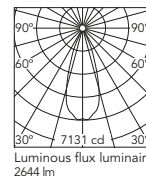

Beam Angle: 37°

h(m)	E(lx)	D(m)
1	7131	0.66
2	1783	1.32
3	792	1.98
4	446	2.65
5	285	3.31

4000K - CRI 90
On board dimmer
09.7328.40
09.7328.14

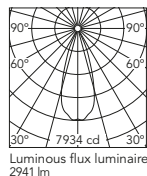

Beam Angle: 37°

h(m)	E(lx)	D(m)
1	7934	0.66
2	1983	1.32
3	882	1.98
4	496	2.65
5	317	3.31

UT PRO SURFACE

Accessori / Accessories

Crocetta di schermatura, lenti e honeycomb direttamente installabili sulla testa dell'apparecchio di illuminazione senza necessità di accessori di fissaggio. Compatibilità di installazione di honeycomb + lente contemporaneamente.

Screening crosspiece, lenses and honeycomb directly installable on the head of the luminaire without needing any fastening accessory. Installation compatible with honeycomb + lense at the same time.

Filtro a croce antiabbagliamento.	Screening crosspiece.		UT Pro Surface 150 08.8429.00 UT Pro Surface 175 08.9108.00
-----------------------------------	-----------------------	---	--

Lente ellittica.	Elliptical lens.		UT Pro Surface 150 08.8431.00 UT Pro Surface 175 08.9109.00
------------------	------------------	---	--

Lente flood.	Flood lens.		UT Pro Surface 150 08.8432.00 UT Pro Surface 175 08.9110.00
--------------	-------------	---	--

Honeycomb.	Honeycomb.		UT Pro Surface 150 08.8428.00 UT Pro Surface 175 08.9107.00
------------	------------	---	--

Cono di schermatura.	Snoot shielding cone.		 UT Pro Surface 150 08.0526.00 08.0526.40 08.0526.BW UT Pro Surface 175 08.9111.00
----------------------	-----------------------	---	--

KAP SURFACE&SUSPENSION

DESIGNED BY FLOS ARCHITECTURAL



Esterno / Outside

B1 Bianco B1 White
 14 Nero 14 Black
 18 Deep Brown 18 Deep Brown

Interno / Inside

Bianco White
 Oro Satinato Matt Gold
 Rame Copper
 Nero Black

**Kap 80
Round / Square**



Esterno / Outside

11 Bianco 11 White
 AS Alluminio Spazzolato AS Brushed Aluminium
 AN Nero AN Black
 B3 Marrone B3 Brown

Interno / Inside

Bianco White
 Oro Satinato Matt Gold
 Blu Blue
 Nero Black

Kap Ø100



KAP SURFACE & SUSPENSION

Descrizione

Famiglia di apparecchi con illuminazione diretta o indiretta in base alla versione, per installazione a soffitto, parete o sospesa. La versione Ø80 presenta moduli di illuminazione rotondi e quadrati.

Il corpo principale dell'apparecchio è realizzato in alluminio estruso.

La versione Kap 80 Surface è disponibile in tre finiture esterne (bianco, nero e deep brown) e quattro finiture interne (bianco, oro opaco, rame e nero).

Le versioni restanti sono disponibili in quattro finiture esterne (bianco, alluminio lucido, nero e marrone) e quattro finiture interne (bianco, oro opaco, blu e nero).

Riflettori

La versione Ø100 presenta un riflettore interno realizzato in policarbonato verniciato nella parte interna, mentre la versione Ø80 presenta un riflettore in alluminio verniciato. Inoltre, entrambe le versioni vanno accompagnate da un diffusore in policarbonato opalino che garantisce una luce uniforme.

Unità di Alimentazione

Trasformatore elettrico incorporato.

Informazioni aggiuntive

Grado di protezione IP20.

Classe di isolamento I.

Adatti ad installazioni su superfici normalmente infiammabili.

Conformità e Marchi di Qualità

Apparecchio conforme alla Normativa Tecnica Europea EN60598-1 e relative parti seconde.

Description

Family of luminaires with direct or indirect lighting depending on the version, to be installed on ceilings, walls or suspended. Version Ø80 comes with round or square lighting modules.

The main body of the luminaire is made of extruded aluminum.

Kap 80 Surface version is available in three external finishes (black, white and deep brown) and four internal finishes (white, matt gold, copper and black).

The other versions are available in four external finishes (white, polished aluminium, black and brown) and four internal finishes (white, matt gold, blue and black).

Reflectors

Version Ø100 has an internal reflector in painted polycarbonate in its internal part, while version Ø80 has a reflector in painted aluminium. Furthermore, both versions incorporate a diffusing lens in opal polycarbonate to ensure uniform light distribution.

Power Supply

Electronic transformer incorporated.

Additional Information

IP20 protection grade.

Insulation class I.

Suitable for installation on normally inflammable surfaces.

Standard Compliance and Quality Marks

EN60598-1 European Technical Standards and any subsequent additions.



Ceiling



Suspension



Wall

KAP SURFACE

Kap 80 Surface Ceiling Round - Optic Spot / Optic Medium

Light Source: LED Array 9,2W - 935 lm - 2700K/CRI 90 / 9,2W - 974 lm - 3000K/CRI 90

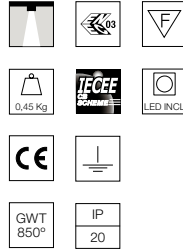
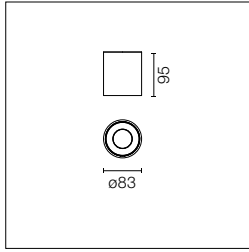

Apparecchio di illuminazione a LED per installazione a soffitto. Fonte di alimentazione integrata al corpo dell'apparecchio. Non dimmabile 110/240V - Main&Dali/Push dimmabile 220/240V.

Luminaire for mounting on the ceiling with LED light source. Power source incorporated into luminaire body. Non dimmable 110/240V - Main&Dali/Push dimmable 220/240V.

E= Finitura Esterna
I= Finitura Interna

E= External Finish
I= Internal Finish

Optic Spot 2700K

- E I Non Dimmable
- 03.6020.B1
- 03.6020.14
- 03.6020.18
- Mains Dimming
- 03.5920.B1
- 03.5920.14
- 03.5920.18
- Dali/Push Version
- 03.6020.B1.DA
- 03.6020.14.DA
- 03.6020.18.DA

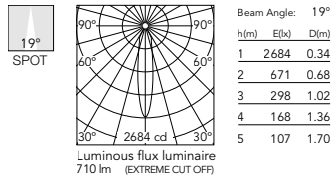

Optic Spot 3000K

- E I Non Dimmable
- 03.6024.B1
- 03.6024.14
- 03.6024.18
- Mains Dimming
- 03.5924.B1
- 03.5924.14
- 03.5924.18
- Dali/Push Version
- 03.6024.B1.DA
- 03.6024.14.DA
- 03.6024.18.DA

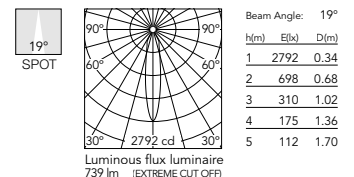

- Non Dimmable
- 03.6021.B1
- 03.6021.14
- 03.6021.18
- Mains Dimming
- 03.5921.B1
- 03.5921.14
- 03.5921.18
- Dali/Push Version
- 03.6021.B1.DA
- 03.6021.14.DA
- 03.6021.18.DA

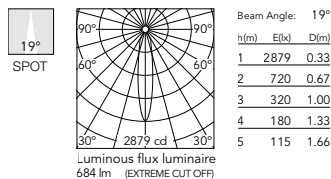

- Non Dimmable
- 03.6025.B1
- 03.6025.14
- 03.6025.18
- Mains Dimming
- 03.5925.B1
- 03.5925.14
- 03.5925.18
- Dali/Push Version
- 03.6025.B1.DA
- 03.6025.14.DA
- 03.6025.18.DA

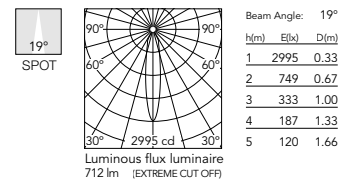

- Non Dimmable
- 03.6022.B1
- 03.6022.14
- 03.6022.18
- Mains Dimming
- 03.5922.B1
- 03.5922.14
- 03.5922.18
- Dali/Push Version
- 03.6022.B1.DA
- 03.6022.14.DA
- 03.6022.18.DA

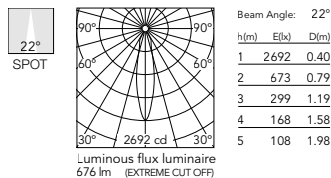

- Non Dimmable
- 03.6026.B1
- 03.6026.14
- 03.6026.18
- Mains Dimming
- 03.5926.B1
- 03.5926.14
- 03.5926.18
- Dali/Push Version
- 03.6026.B1.DA
- 03.6026.14.DA
- 03.6026.18.DA

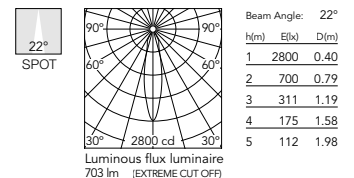

- Non Dimmable
- 03.6023.B1
- 03.6023.14
- 03.6023.18
- Mains Dimming
- 03.5923.B1
- 03.5923.14
- 03.5923.18
- Dali/Push Version
- 03.6023.B1.DA
- 03.6023.14.DA
- 03.6023.18.DA

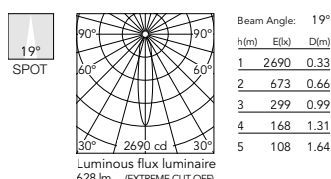

- Non Dimmable
- 03.6027.B1
- 03.6027.14
- 03.6027.18
- Mains Dimming
- 03.5927.B1
- 03.5927.14
- 03.5927.18
- Dali/Push Version
- 03.6027.B1.DA
- 03.6027.14.DA
- 03.6027.18.DA

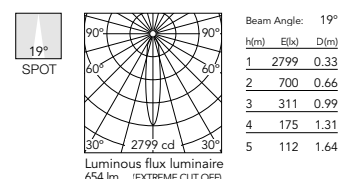

KAP SURFACE

Optic Medium 2700K

E I	Non Dimmable
	03.6000.B1
	03.6000.14
	03.6000.18
	Mains Dimming
	03.5900.B1
	03.5900.14
	03.5900.18
	Dali/Push Version
	03.6000.B1.DA
	03.6000.14.DA
	03.6000.18.DA

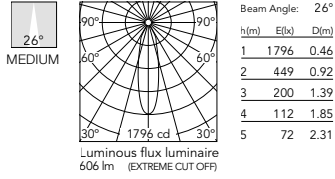

Optic Medium 3000K

E I	Non Dimmable
	03.6004.B1
	03.6004.14
	03.6004.18
	Mains Dimming
	03.5904.B1
	03.5904.14
	03.5904.18
	Dali/Push Version
	03.6004.B1.DA
	03.6004.14.DA
	03.6004.18.DA

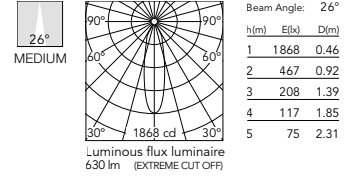

	Non Dimmable
	03.6001.B1
	03.6001.14
	03.6001.18
	Mains Dimming
	03.5901.B1
	03.5901.14
	03.5901.18
	Dali/Push Version
	03.6001.B1.DA
	03.6001.14.DA
	03.6001.18.DA

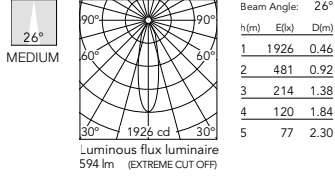

	Non Dimmable
	03.6005.B1
	03.6005.14
	03.6005.18
	Mains Dimming
	03.5905.B1
	03.5905.14
	03.5905.18
	Dali/Push Version
	03.6005.B1.DA
	03.6005.14.DA
	03.6005.18.DA

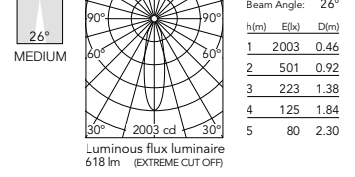

	Non Dimmable
	03.6002.B1
	03.6002.14
	03.6002.18
	Mains Dimming
	03.5902.B1
	03.5902.14
	03.5902.18
	Dali/Push Version
	03.6002.B1.DA
	03.6002.14.DA
	03.6002.18.DA

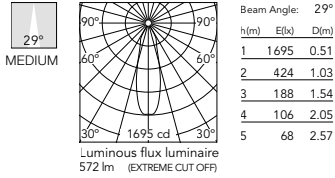

	Non Dimmable
	03.6006.B1
	03.6006.14
	03.6006.18
	Mains Dimming
	03.5906.B1
	03.5906.14
	03.5906.18
	Dali/Push Version
	03.6006.B1.DA
	03.6006.14.DA
	03.6006.18.DA

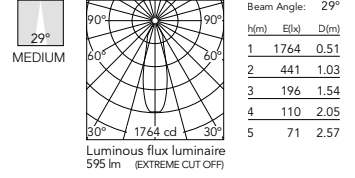

	Non Dimmable
	03.6003.B1
	03.6003.14
	03.6003.18
	Mains Dimming
	03.5903.B1
	03.5903.14
	03.5903.18
	Dali/Push Version
	03.6003.B1.DA
	03.6003.14.DA
	03.6003.18.DA

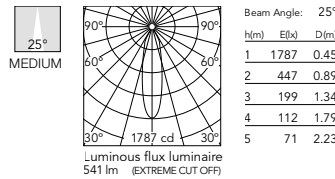

	Non Dimmable
	03.6007.B1
	03.6007.14
	03.6007.18
	Mains Dimming
	03.5907.B1
	03.5907.14
	03.5907.18
	Dali/Push Version
	03.6007.B1.DA
	03.6007.14.DA
	03.6007.18.DA

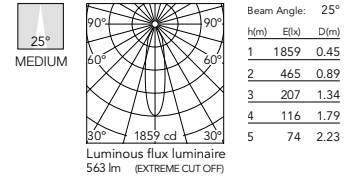

KAP SURFACE

Kap 80 Surface Ceiling Round - Optic Flood

Light Source: LED Array 9,2W - 935 lm - 2700K/CRI 90 / 9,2W - 974 lm - 3000K/CRI 90

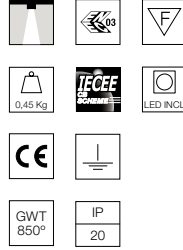
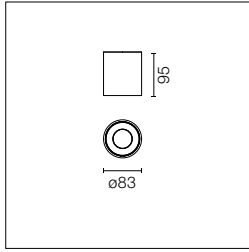

Apparecchio di illuminazione a LED per installazione a soffitto. Fonte di alimentazione integrata al corpo dell'apparecchio. Non dimmabile 110/240V - Main&Dali/Push dimmabile 220/240V.

Luminaire for mounting on the ceiling with LED light source. Power source incorporated into luminaire body. Non dimmable 110/240V - Main&Dali/Push dimmable 220/240V.

E= Finitura Esterna
I= Finitura Interna

E= External Finish
I= Internal Finish

Optic Flood 2700K

- E I Non Dimmable
- 03.6040.B1
- 03.6040.14
- 03.6040.18
- Mains Dimming
- 03.5940.B1
- 03.5940.14
- 03.5940.18
- Dali/Push Version
- 03.6040.B1.DA
- 03.6040.14.DA
- 03.6040.18.DA

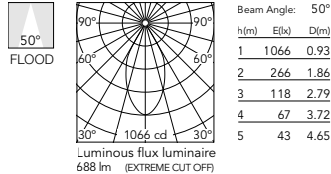

Optic Flood 3000K

- E I Non Dimmable
- 03.6044.B1
- 03.6044.14
- 03.6044.18
- Mains Dimming
- 03.5944.B1
- 03.5944.14
- 03.5944.18
- Dali/Push Version
- 03.6044.B1.DA
- 03.6044.14.DA
- 03.6044.18.DA

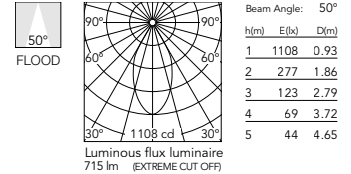

- Non Dimmable
- 03.6041.B1
- 03.6041.14
- 03.6041.18
- Mains Dimming
- 03.5941.B1
- 03.5941.14
- 03.5941.18
- Dali/Push Version
- 03.6041.B1.DA
- 03.6041.14.DA
- 03.6041.18.DA

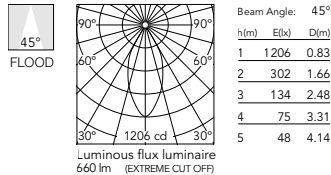

- Non Dimmable
- 03.6045.B1
- 03.6045.14
- 03.6045.18
- Mains Dimming
- 03.5945.B1
- 03.5945.14
- 03.5945.18
- Dali/Push Version
- 03.6045.B1.DA
- 03.6045.14.DA
- 03.6045.18.DA

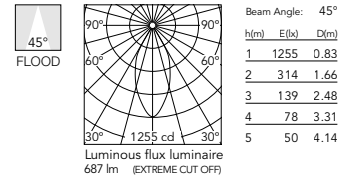

- Non Dimmable
- 03.6042.B1
- 03.6042.14
- 03.6042.18
- Mains Dimming
- 03.5942.B1
- 03.5942.14
- 03.5942.18
- Dali/Push Version
- 03.6042.B1.DA
- 03.6042.14.DA
- 03.6042.18.DA

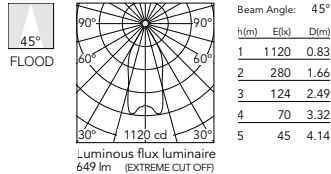

- Non Dimmable
- 03.6046.B1
- 03.6046.14
- 03.6046.18
- Mains Dimming
- 03.5946.B1
- 03.5946.14
- 03.5946.18
- Dali/Push Version
- 03.6046.B1.DA
- 03.6046.14.DA
- 03.6046.18.DA

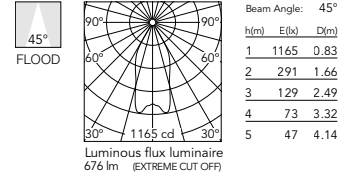

- Non Dimmable
- 03.6043.B1
- 03.6043.14
- 03.6043.18
- Mains Dimming
- 03.5943.B1
- 03.5943.14
- 03.5943.18
- Dali/Push Version
- 03.6043.B1.DA
- 03.6043.14.DA
- 03.6043.18.DA

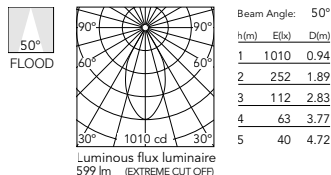

- Non Dimmable
- 03.6047.B1
- 03.6047.14
- 03.6047.18
- Mains Dimming
- 03.5947.B1
- 03.5947.14
- 03.5947.18
- Dali/Push Version
- 03.6047.B1.DA
- 03.6047.14.DA
- 03.6047.18.DA

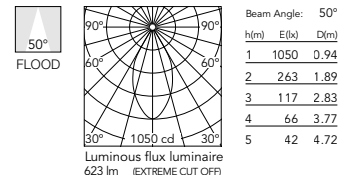

KAP SURFACE

Kap 80 Surface Ceiling Square - Optic Spot

Light Source: LED Array 9,2W - 935 lm - 2700K/CRI 90 / 9,2W - 974 lm - 3000K/CRI 90

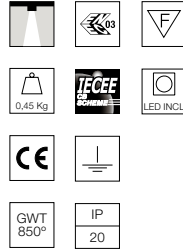
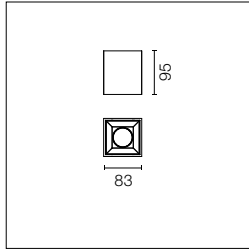

Apparecchio di illuminazione a LED per installazione a soffitto. Fonte di alimentazione integrata al corpo dell'apparecchio. Non dimmabile 110/240V - Main&Dali/Push dimmabile 220/240V.

Luminaire for mounting on the ceiling with LED light source. Power source incorporated into luminaire body. Non dimmable 110/240V - Main&Dali/Push dimmable 220/240V.

E= Finitura Esterna
I= Finitura Interna

E= External Finish
I= Internal Finish

Optic Spot 2700K

- E I Non Dimmable
- 03.6030.B1
 - 03.6030.14
 - 03.6030.18
- Mains Dimming
- 03.5930.B1
 - 03.5930.14
 - 03.5930.18
- Dali/Push Version
- 03.6030.B1.DA
 - 03.6030.14.DA
 - 03.6030.18.DA

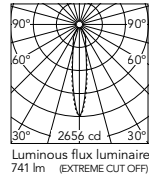

Beam Angle: 18°

h(m)	E(lx)	D(m)
1	2656	0.31
2	664	0.62
3	295	0.94
4	166	1.25
5	106	1.56

Optic Spot 3000K

- E I Non Dimmable
- 03.6034.B1
 - 03.6034.14
 - 03.6034.18
- Mains Dimming
- 03.5934.B1
 - 03.5934.14
 - 03.5934.18
- Dali/Push Version
- 03.6034.B1.DA
 - 03.6034.14.DA
 - 03.6034.18.DA

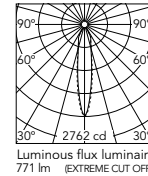

Beam Angle: 18°

h(m)	E(lx)	D(m)
1	2762	0.31
2	691	0.62
3	307	0.94
4	173	1.25
5	110	1.56

- Non Dimmable
- 03.6031.B1
 - 03.6031.14
 - 03.6031.18
- Mains Dimming
- 03.5931.B1
 - 03.5931.14
 - 03.5931.18
- Dali/Push Version
- 03.6031.B1.DA
 - 03.6031.14.DA
 - 03.6031.18.DA

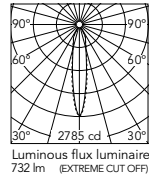

Beam Angle: 18°

h(m)	E(lx)	D(m)
1	2785	0.31
2	696	0.63
3	309	0.94
4	174	1.26
5	111	1.57

- Non Dimmable
- 03.6035.B1
 - 03.6035.14
 - 03.6035.18
- Mains Dimming
- 03.5935.B1
 - 03.5935.14
 - 03.5935.18
- Dali/Push Version
- 03.6035.B1.DA
 - 03.6035.14.DA
 - 03.6035.18.DA

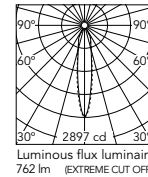

Beam Angle: 18°

h(m)	E(lx)	D(m)
1	2897	0.31
2	724	0.63
3	322	0.94
4	181	1.26
5	116	1.57

- Non Dimmable
- 03.6032.B1
 - 03.6032.14
 - 03.6032.18
- Mains Dimming
- 03.5932.B1
 - 03.5932.14
 - 03.5932.18
- Dali/Push Version
- 03.6032.B1.DA
 - 03.6032.14.DA
 - 03.6032.18.DA

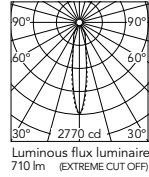

Beam Angle: 18°

h(m)	E(lx)	D(m)
1	2770	0.31
2	693	0.62
3	308	0.94
4	173	1.25
5	111	1.56

- Non Dimmable
- 03.6036.B1
 - 03.6036.14
 - 03.6036.18
- Mains Dimming
- 03.5936.B1
 - 03.5936.14
 - 03.5936.18
- Dali/Push Version
- 03.6036.B1.DA
 - 03.6036.14.DA
 - 03.6036.18.DA

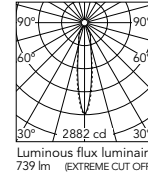

Beam Angle: 18°

h(m)	E(lx)	D(m)
1	2882	0.31
2	720	0.62
3	320	0.94
4	180	1.25
5	115	1.56

- Non Dimmable
- 03.6033.B1
 - 03.6033.14
 - 03.6033.18
- Mains Dimming
- 03.5933.B1
 - 03.5933.14
 - 03.5933.18
- Dali/Push Version
- 03.6033.B1.DA
 - 03.6033.14.DA
 - 03.6033.18.DA

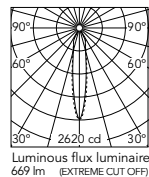

Beam Angle: 17°

h(m)	E(lx)	D(m)
1	2620	0.30
2	655	0.60
3	291	0.90
4	164	1.20
5	105	1.50

- Non Dimmable
- 03.6037.B1
 - 03.6037.14
 - 03.6037.18
- Mains Dimming
- 03.5937.B1
 - 03.5937.14
 - 03.5937.18
- Dali/Push Version
- 03.6037.B1.DA
 - 03.6037.14.DA
 - 03.6037.18.DA

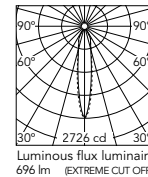

Beam Angle: 17°

h(m)	E(lx)	D(m)
1	2726	0.30
2	681	0.60
3	303	0.90
4	170	1.20
5	109	1.50

KAP SURFACE

Kap 80 Surface Ceiling Square - Optic Medium / Optic Flood

Light Source: LED Array 9,2W - 935 lm - 2700K/CRI 90 / 9,2W - 974 lm - 3000K/CRI 90

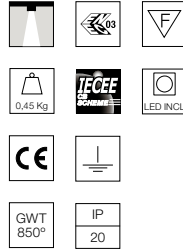
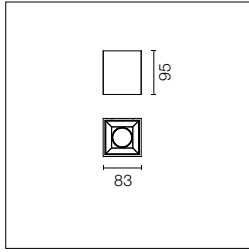

Apparecchio di illuminazione a LED per installazione a soffitto. Fonte di alimentazione integrata al corpo dell'apparecchio. Non dimmabile 110/240V - Main&Dali/Push dimmabile 220/240V.

Luminaire for mounting on the ceiling with LED light source. Power source incorporated into luminaire body. Non dimmable 110/240V - Main&Dali/Push dimmable 220/240V.

E= Finitura Esterna
I= Finitura Interna

E= External Finish
I= Internal Finish

Optic Medium 2700K

- E I Non Dimmable
- 03.6010.B1
- 03.6010.14
- 03.6010.18
- Mains Dimming
- 03.5910.B1
- 03.5910.14
- 03.5910.18
- Dali/Push Version
- 03.6010.B1.DA
- 03.6010.14.DA
- 03.6010.18.DA

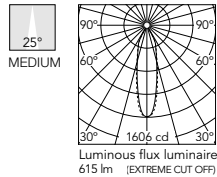

Beam Angle: 25°

h(m)	E(lx)	D(m)
1	1606	0.45
2	401	0.90
3	178	1.34
4	100	1.79
5	64	2.24

Optic Medium 3000K

- E I Non Dimmable
- 03.6014.B1
- 03.6014.14
- 03.6014.18
- Mains Dimming
- 03.5914.B1
- 03.5914.14
- 03.5914.18
- Dali/Push Version
- 03.6014.B1.DA
- 03.6014.14.DA
- 03.6014.18.DA

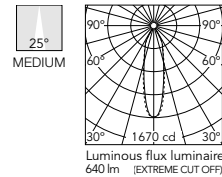

Beam Angle: 25°

h(m)	E(lx)	D(m)
1	1670	0.45
2	418	0.90
3	186	1.34
4	104	1.79
5	67	2.24

- Non Dimmable
- 03.6011.B1
- 03.6011.14
- 03.6011.18
- Mains Dimming
- 03.5911.B1
- 03.5911.14
- 03.5911.18
- Dali/Push Version
- 03.6011.B1.DA
- 03.6011.14.DA
- 03.6011.18.DA

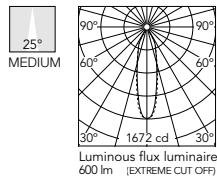

Beam Angle: 25°

h(m)	E(lx)	D(m)
1	1672	0.45
2	418	0.90
3	186	1.34
4	104	1.79
5	67	2.24

- Non Dimmable
- 03.6015.B1
- 03.6015.14
- 03.6015.18
- Mains Dimming
- 03.5915.B1
- 03.5915.14
- 03.5915.18
- Dali/Push Version
- 03.6015.B1.DA
- 03.6015.14.DA
- 03.6015.18.DA

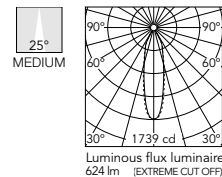

Beam Angle: 25°

h(m)	E(lx)	D(m)
1	1739	0.45
2	435	0.90
3	193	1.34
4	109	1.79
5	70	2.24

- Non Dimmable
- 03.6012.B1
- 03.6012.14
- 03.6012.18
- Mains Dimming
- 03.5912.B1
- 03.5912.14
- 03.5912.18
- Dali/Push Version
- 03.6012.B1.DA
- 03.6012.14.DA
- 03.6012.18.DA

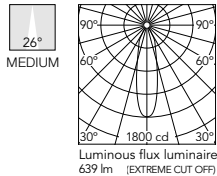

Beam Angle: 26°

h(m)	E(lx)	D(m)
1	1800	0.46
2	450	0.93
3	200	1.39
4	112	1.86
5	72	2.32

- Non Dimmable
- 03.6016.B1
- 03.6016.14
- 03.6016.18
- Mains Dimming
- 03.5916.B1
- 03.5916.14
- 03.5916.18
- Dali/Push Version
- 03.6016.B1.DA
- 03.6016.14.DA
- 03.6016.18.DA

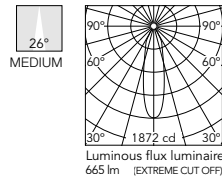

Beam Angle: 26°

h(m)	E(lx)	D(m)
1	1872	0.46
2	468	0.93
3	208	1.39
4	117	1.86
5	75	2.32

- Non Dimmable
- 03.6013.B1
- 03.6013.14
- 03.6013.18
- Mains Dimming
- 03.5913.B1
- 03.5913.14
- 03.5913.18
- Dali/Push Version
- 03.6013.B1.DA
- 03.6013.14.DA
- 03.6013.18.DA

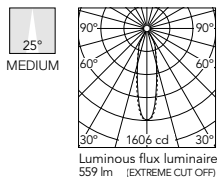

Beam Angle: 25°

h(m)	E(lx)	D(m)
1	1606	0.44
2	402	0.88
3	178	1.32
4	100	1.76
5	64	2.20

- Non Dimmable
- 03.6017.B1
- 03.6017.14
- 03.6017.18
- Mains Dimming
- 03.5917.B1
- 03.5917.14
- 03.5917.18
- Dali/Push Version
- 03.6017.B1.DA
- 03.6017.14.DA
- 03.6017.18.DA

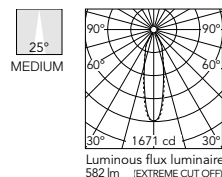

Beam Angle: 25°

h(m)	E(lx)	D(m)
1	1671	0.44
2	418	0.88
3	186	1.32
4	104	1.76
5	67	2.20

KAP SURFACE

Optic Flood 2700K

- E I** Non Dimmable
- 03.6050.B1
 - 03.6050.14
 - 03.6050.18
- Mains Dimming
- 03.5950.B1
 - 03.5950.14
 - 03.5950.18
- Dali/Push Version
- 03.6050.B1.DA
 - 03.6050.14.DA
 - 03.6050.18.DA

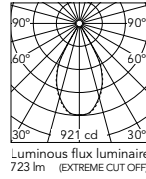

Beam Angle: 55°

h(m)	E(lx)	D(m)
1	921	1.03
2	230	2.07
3	102	3.10
4	58	4.14
5	37	5.17

Optic Flood 3000K

- E I** Non Dimmable
- 03.6054.B1
 - 03.6054.14
 - 03.6054.18
- Mains Dimming
- 03.5954.B1
 - 03.5954.14
 - 03.5954.18
- Dali/Push Version
- 03.6054.B1.DA
 - 03.6054.14.DA
 - 03.6054.18.DA

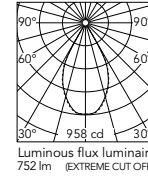

Beam Angle: 55°

h(m)	E(lx)	D(m)
1	958	1.03
2	240	2.07
3	106	3.10
4	60	4.14
5	38	5.17

- Non Dimmable
- 03.6051.B1
 - 03.6051.14
 - 03.6051.18
- Mains Dimming
- 03.5951.B1
 - 03.5951.14
 - 03.5951.18
- Dali/Push Version
- 03.6051.B1.DA
 - 03.6051.14.DA
 - 03.6051.18.DA

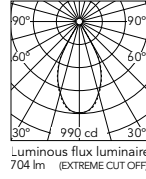

Beam Angle: 53°

h(m)	E(lx)	D(m)
1	990	1.00
2	248	2.00
3	110	3.00
4	62	4.00
5	40	5.01

- Non Dimmable
- 03.6055.B1
 - 03.6055.14
 - 03.6055.18
- Mains Dimming
- 03.5955.B1
 - 03.5955.14
 - 03.5955.18
- Dali/Push Version
- 03.6055.B1.DA
 - 03.6055.14.DA
 - 03.6055.18.DA

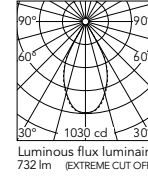

Beam Angle: 53°

h(m)	E(lx)	D(m)
1	1030	1.00
2	258	2.00
3	114	3.00
4	64	4.00
5	41	5.01

- Non Dimmable
- 03.6052.B1
 - 03.6052.14
 - 03.6052.18
- Mains Dimming
- 03.5952.B1
 - 03.5952.14
 - 03.5952.18
- Dali/Push Version
- 03.6052.B1.DA
 - 03.6052.14.DA
 - 03.6052.18.DA

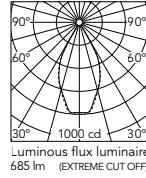

Beam Angle: 52°

h(m)	E(lx)	D(m)
1	1000	0.97
2	250	1.93
3	111	2.90
4	63	3.87
5	40	4.84

- Non Dimmable
- 03.6056.B1
 - 03.6056.14
 - 03.6056.18
- Mains Dimming
- 03.5956.B1
 - 03.5956.14
 - 03.5956.18
- Dali/Push Version
- 03.6056.B1.DA
 - 03.6056.14.DA
 - 03.6056.18.DA

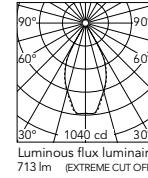

Beam Angle: 52°

h(m)	E(lx)	D(m)
1	1040	0.97
2	260	1.93
3	116	2.90
4	65	3.87
5	42	4.84

- Non Dimmable
- 03.6053.B1
 - 03.6053.14
 - 03.6053.18
- Mains Dimming
- 03.5953.B1
 - 03.5953.14
 - 03.5953.18
- Dali/Push Version
- 03.6053.B1.DA
 - 03.6053.14.DA
 - 03.6053.18.DA

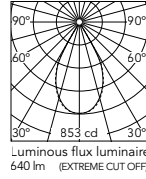

Beam Angle: 55°

h(m)	E(lx)	D(m)
1	853	1.05
2	213	2.10
3	95	3.16
4	53	4.21
5	34	5.26

- Non Dimmable
- 03.6057.B1
 - 03.6057.14
 - 03.6057.18
- Mains Dimming
- 03.5957.B1
 - 03.5957.14
 - 03.5957.18
- Dali/Push Version
- 03.6057.B1.DA
 - 03.6057.14.DA
 - 03.6057.18.DA

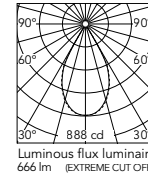

Beam Angle: 55°

h(m)	E(lx)	D(m)
1	888	1.05
2	222	2.10
3	99	3.16
4	55	4.21
5	36	5.26

KAP SURFACE

Kap Surface Ceiling

Light Source: Power LED 9W - 1000 lm - 3000K/CRI 80

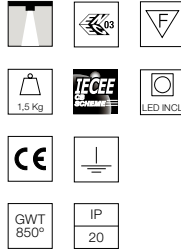
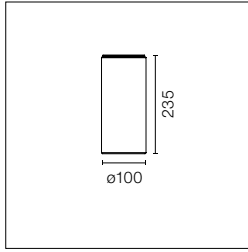

Apparecchio di illuminazione a LED per installazione a soffitto. Fonte di alimentazione 110/240V - 50/60Hz non regolabile integrata al corpo dell'apparecchio.

Luminaire for mounting on the ceiling with LED light source. Non-adjustable 110/240V - 50/60Hz power supply integrated into luminaire body.

E= Finitura Esterna
I= Finitura Interna

E= External Finish
I= Internal Finish

E	I	Code
White	White	03.4520.11B
White	Black	03.4520.ASB
Black	White	03.4520.ANB
Black	Black	03.4520.B3B

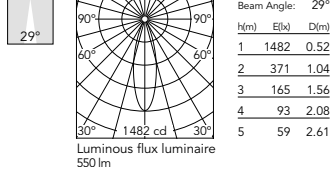

E	I	Code
White	White	03.4521.11B
White	Black	03.4521.ASB
Black	White	03.4521.ANB
Black	Black	03.4521.B3B

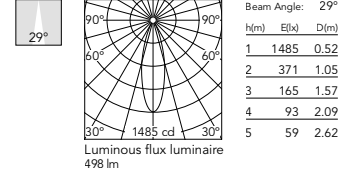

E	I	Code
White	Blue	03.4522.11B
White	Black	03.4522.ASB
Black	Blue	03.4522.ANB
Black	Black	03.4522.B3B

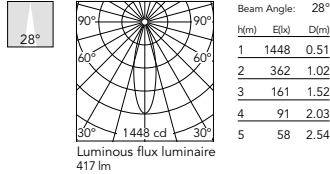

E	I	Code
White	Black	03.4523.11B
White	White	03.4523.ASB
Black	Black	03.4523.ANB
Black	White	03.4523.B3B

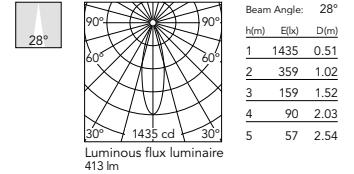

Kap Surface Wall

Light Source: Power LED 9W - 1000 lm - 3000K/CRI 80

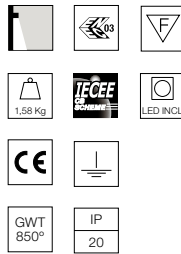
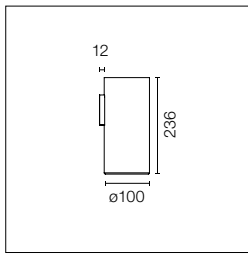

Apparecchio di illuminazione a LED per installazione a parete. Fonte di alimentazione 110/240V - 50/60Hz non regolabile integrata al corpo dell'apparecchio.

Luminaire for wall mounting with LED light source. Non-adjustable 110/240V - 50/60Hz power supply integrated into luminaire body.

E= Finitura Esterna
I= Finitura Interna

E= External Finish
I= Internal Finish

E	I	Code
White	White	03.5730.11B
White	Black	03.5730.ASB
Black	White	03.5730.ANB
Black	Black	03.5730.B3B

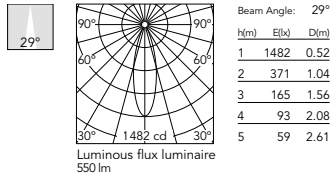

E	I	Code
White	White	03.5731.11B
White	Black	03.5731.ASB
Black	White	03.5731.ANB
Black	Black	03.5731.B3B

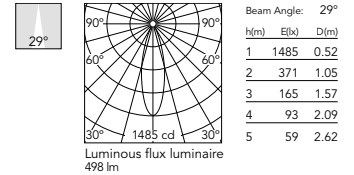

E	I	Code
White	Blue	03.5732.11B
White	Black	03.5732.ASB
Black	Blue	03.5732.ANB
Black	Black	03.5732.B3B

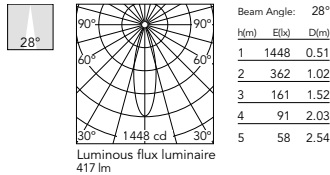

E	I	Code
White	Black	03.5733.11B
White	White	03.5733.ASB
Black	Black	03.5733.ANB
Black	White	03.5733.B3B

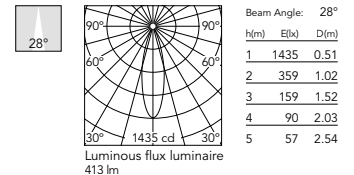

KAP SUSPENSION

Kap Suspension

Light Source: Power LED 9W - 1000 lm - 3000K/CRI 80

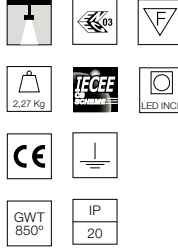
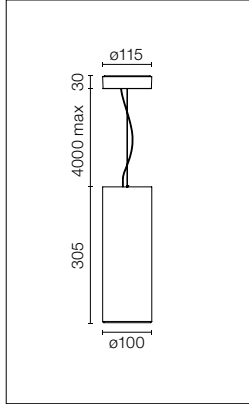

Apparecchio di illuminazione a LED per installazione a sospensione. Fonte di alimentazione 110/240V - 50/60Hz non regolabile integrata al corpo dell'apparecchio.

Suspended ceiling-mounted luminaire with LED light source. Non-adjustable 110/240V - 50/60Hz power supply integrated into luminaire body.

E= Finitura Esterna
I= Finitura Interna

E= External Finish
I= Internal Finish

E	I	
White	White	03.5810.11B
White	Black	03.5810.ASB
Black	White	03.5810.ANB
Black	Black	03.5810.B3B

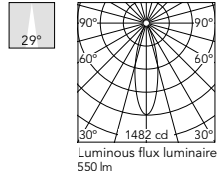

E	I	
White	White	03.5811.11B
White	Black	03.5811.ASB
Black	White	03.5811.ANB
Black	Black	03.5811.B3B

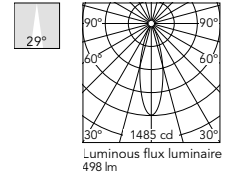

E	I	
White	Blue	03.5812.11B
White	Black	03.5812.ASB
Black	Blue	03.5812.ANB
Black	Black	03.5812.B3B

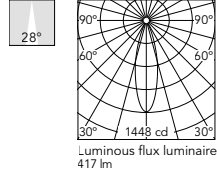

E	I	
White	Black	03.5813.11B
White	Blue	03.5813.ASB
Black	Black	03.5813.ANB
Black	Blue	03.5813.B3B

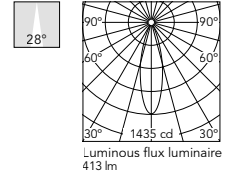

COMPASS BOX

DESIGNED BY FLOS ARCHITECTURAL

SMALL
1L / 2L / 4L /
4L SQUARE

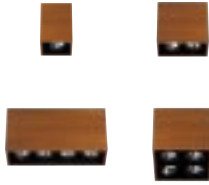

LIGHT SOURCE
LED ARRAY
6,2W
860 lm
3000K/CRI 80

SMALL
1L / 2L / 4L

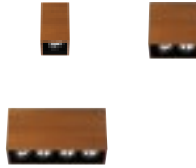

LIGHT SOURCE
LED
QR-CBC 51
GX5.3

LARGE H:135
1L / 2L / 4L /
4L SQUARE



LIGHT SOURCE
LED
QR-111
G53

□ 30 Bianco Opaco/RAL 9001
30 Matt White

■ 14 Nero Opaco/RAL 9005
14 Matt Black

▒ 29 Alluminio Anodizzato
29 Anodized Aluminium



■ WG Wenge
WG Wenge

■ TK Teck
TK Teak



Può essere orientato di 20°.
Can be swivelled 20°.

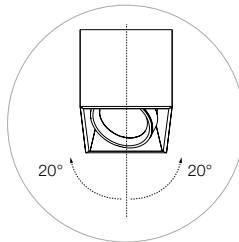

COMPASS BOX

Descrizione

Apparecchi di illuminazione da 1, 2 o 4 luci orientabili per installazioni a parete o a soffitto.

Progettato per lampade LED.

Corpo ottico in acciaio stampato verniciato di colore nero e struttura esterna realizzata in estruso di alluminio con sistema di fissaggio al tetto.

Connessione elettrica e dispositivi di controllo incorporati nell'apparecchio.

Unità di Alimentazione

LED:

- Fonte di alimentazione a corrente costante 220/240V, 50-60Hz non regolabile integrata. Alimentazione a 350 mA.

Ad alogeni:

- Trasformatore elettronico 20/105W-220/240V - 50/60Hz con regolazione d'intensità tramite dispositivo "leading and trailing edge".

Accessori

- Cilindro schermante con spinotto rotante in materiale termoplastico nero.

- Honeycomb.

Informazioni Aggiuntive

Disponibile in due altezze.

Sistema di orientamento che consente la rotazione di 20° in tutte le direzioni.

Grado di protezione IP20.

Classe di isolamento I, II, a seconda delle versioni.

Adatti ad installazioni su superfici normalmente infiammabili.

Conformità e Marchi di Qualità

Apparecchio conforme alla Normativa Tecnica Europea EN60598-1 e relative parti seconde.

Description

Wall or ceiling luminaires with 1, 2 or 4 adjustable lights.

Suitable for LED light sources.

Pressed steel, black-painted optical body and extruded-aluminum outer structure with fixing system.

Electrical connection and control devices incorporated in the luminaire.

Power Supply

LED:

- Built-in, non-regulable constant current power supply of 220/240V, 50/60Hz. 350 mA current.

For LED retrofit versions:

- Electronic transformer of 20/105W – 220/240V - 50/60Hz with intensity regulation through "leading and trailing edge" device.

Accessories

- Screening cylinder and black thermoplastic rotating pin.

- Honeycomb.

Additional Information

Two heights.

0-20° adjustment in all directions.

IP20 protection grade.

Insulation class I, II depending on the versions.

Suitable for installation on normally inflammable surfaces.

Standard Compliance and Quality Marks

EN60598-1 European Technical Standards and any subsequent additions.



COMPASS BOX

Compass Box Small 1L

Light Source: LED Array 6,2W - 860 lm - 3000K/CRI 80

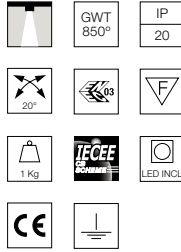
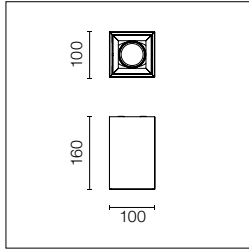

Apparecchio di illuminazione da superficie a LED per soffitto/parete. Fonte di alimentazione 220-240V, 50-60Hz non regolabile integrata al corpo dell'apparecchio.

Surface spotlight to be installed on ceiling/wall with LED light source. Non-regulable 220-240V, 50-60Hz power supply integrated in luminaire body.

- 03.2630.30A
- 03.2630.29A
- 03.2630.14A
- 03.2630.WGA
- 03.2630.TKA

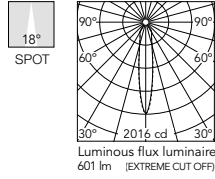

- 03.2632.30A
- 03.2632.29A
- 03.2632.14A
- 03.2632.WGA
- 03.2632.TKA

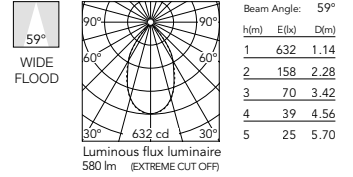

- 03.2631.30A
- 03.2631.29A
- 03.2631.14A
- 03.2631.WGA
- 03.2631.TKA

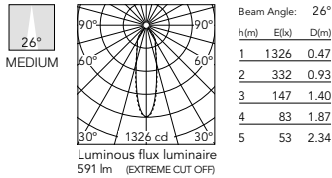

Compass Box Small 2L

Light Source: LED Array 2x6,2W - 2x860 lm - 3000K/CRI 80

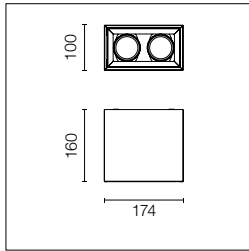

Apparecchio di illuminazione da superficie a LED per soffitto/parete. Fonte di alimentazione 220-240V, 50-60Hz non regolabile integrata al corpo dell'apparecchio.

Surface spotlight to be installed on ceiling/wall with LED light source. Non-regulable 220-240V, 50-60Hz power supply integrated in luminaire body.

- 03.2635.30A
- 03.2635.29A
- 03.2635.14A
- 03.2635.WGA
- 03.2635.TKA

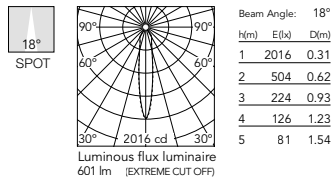

- 03.2637.30A
- 03.2637.29A
- 03.2637.14A
- 03.2637.WGA
- 03.2637.TKA

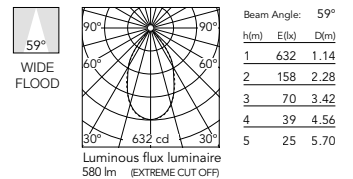

- 03.2636.30A
- 03.2636.29A
- 03.2636.14A
- 03.2636.WGA
- 03.2636.TKA

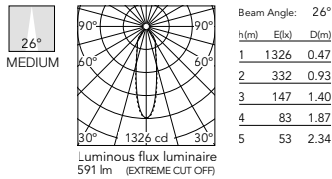

COMPASS BOX

Compass Box Small 4L

Light Source: LED Array 4x6,2W - 4x860 lm - 3000K/CRI 80

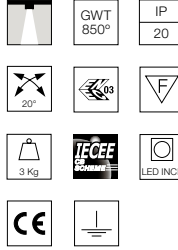
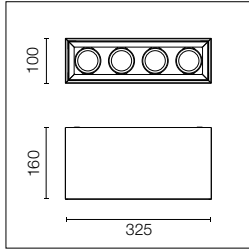

Apparecchio di illuminazione da superficie a LED per soffitto/parete. Fonte di alimentazione 220-240V, 50-60Hz non regolabile integrata al corpo dell'apparecchio.

Surface spotlight to be installed on ceiling/wall with LED light source. Non-regulable 220-240V, 50-60Hz power supply integrated in luminaire body.

- 03.2640.30A
- 03.2640.29A
- 03.2640.14A
- 03.2640.WGA
- 03.2640.TKA

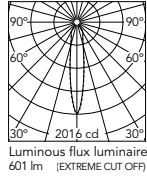

Beam Angle: 18°

h(m)	E(lx)	D(m)
1	2016	0.31
2	504	0.62
3	224	0.93
4	126	1.23
5	81	1.54

- 03.2642.30A
- 03.2642.29A
- 03.2642.14A
- 03.2642.WGA
- 03.2642.TKA

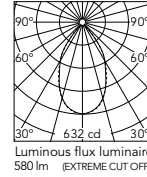

Beam Angle: 59°

h(m)	E(lx)	D(m)
1	632	1.14
2	158	2.28
3	70	3.42
4	39	4.56
5	25	5.70

- 03.2641.30A
- 03.2641.29A
- 03.2641.14A
- 03.2641.WGA
- 03.2641.TKA

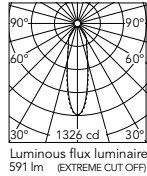

Beam Angle: 26°

h(m)	E(lx)	D(m)
1	1326	0.47
2	332	0.93
3	147	1.40
4	83	1.87
5	53	2.34

Compass Box Small 4L Square

Light Source: LED Array 4x6,2W - 4x860 lm - 3000K/CRI 80

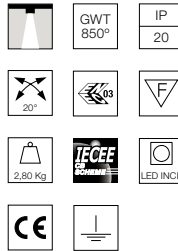
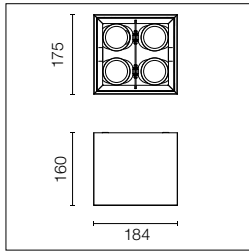

Apparecchio di illuminazione da superficie a LED per soffitto/parete. Fonte di alimentazione 220-240V, 50-60Hz non regolabile integrata al corpo dell'apparecchio.

Surface spotlight to be installed on ceiling/wall with LED light source. Non-regulable 220-240V, 50-60Hz power supply integrated in luminaire body.

- 03.2645.30A
- 03.2645.29A
- 03.2645.14A
- 03.2645.WGA
- 03.2645.TKA

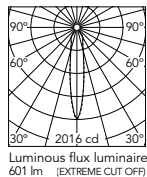

Beam Angle: 18°

h(m)	E(lx)	D(m)
1	2016	0.31
2	504	0.62
3	224	0.93
4	126	1.23
5	81	1.54

- 03.2647.30A
- 03.2647.29A
- 03.2647.14A
- 03.2647.WGA
- 03.2647.TKA

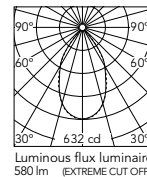

Beam Angle: 59°

h(m)	E(lx)	D(m)
1	632	1.14
2	158	2.28
3	70	3.42
4	39	4.56
5	25	5.70

- 03.2646.30A
- 03.2646.29A
- 03.2646.14A
- 03.2646.WGA
- 03.2646.TKA

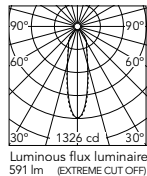

Beam Angle: 26°

h(m)	E(lx)	D(m)
1	1326	0.47
2	332	0.93
3	147	1.40
4	83	1.87
5	53	2.34

COMPASS BOX

Compass Box Small 1L

Light Source: LED QR-CBC 51 GX5.3

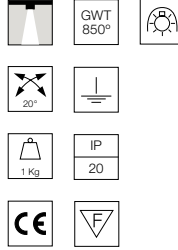
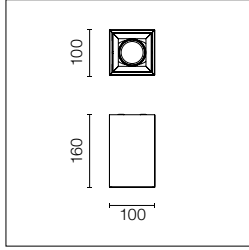

Apparecchio di illuminazione da superficie per soffitto/parete. Completo di trasformatore elettronico 220/240V – 12V, 50/60Hz. Per le lampade compatibili possibilità di regolazione dell'intensità luminosa tramite dimmer "leading and trailing edge".

Surface spotlight to be installed on ceiling/wall. Electronic transformer integrated 220/240V – 12V, 50/60Hz. The intensity of the lighting may be adjusted via leading and trail edge modulation in compatible lamps.

- 03.2600.30
- 03.2600.29
- 03.2600.14
- 03.2600.WG
- 03.2600.TK

Compass Box Small 2L

Light Source: LED QR-CBC 51 GX5.3

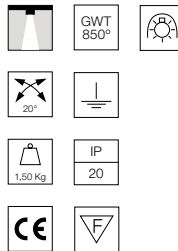
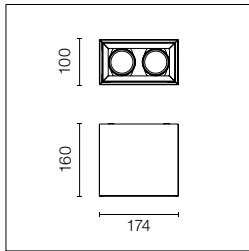

Apparecchio di illuminazione da superficie per soffitto/parete. Completo di trasformatore elettronico 220/240V – 12V, 50/60Hz. Per le lampade compatibili possibilità di regolazione dell'intensità luminosa tramite dimmer "leading and trailing edge".

Surface spotlight to be installed on ceiling/wall. Electronic transformer integrated 220/240V – 12V, 50/60Hz. The intensity of the lighting may be adjusted via leading and trail edge modulation in compatible lamps.

- 03.2601.30
- 03.2601.29
- 03.2601.14
- 03.2601.WG
- 03.2601.TK

Compass Box Small 4L

Light Source: LED QR-CBC 51 GX5.3

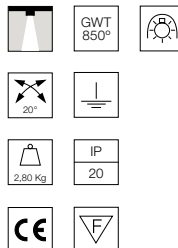
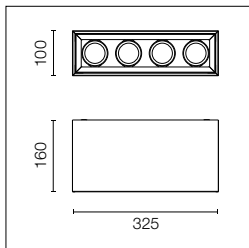

Apparecchio di illuminazione da superficie per soffitto/parete. Completo di trasformatore elettronico 220/240V – 12V, 50/60Hz. Per le lampade compatibili possibilità di regolazione dell'intensità luminosa tramite dimmer "leading and trailing edge".

Surface spotlight to be installed on ceiling/wall. Electronic transformer integrated 220/240V – 12V, 50/60Hz. The intensity of the lighting may be adjusted via leading and trail edge modulation in compatible lamps.

- 03.2603.30
- 03.2603.29
- 03.2603.14
- 03.2603.WG
- 03.2603.TK

Compass Box Large 1L H:135

Light Source: LED QR-111 G53

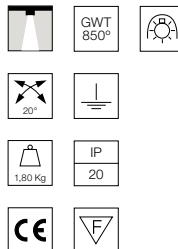
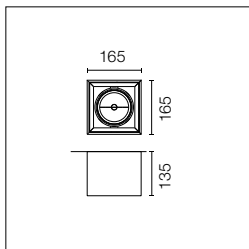

Apparecchio di illuminazione da superficie per soffitto/parete. Completo di trasformatore elettronico 220/240V – 12V, 50/60Hz. Per le lampade compatibili possibilità di regolazione dell'intensità luminosa tramite dimmer "leading and trailing edge".

Surface spotlight to be installed on ceiling/wall. Electronic transformer integrated 220/240V – 12V, 50/60Hz. The intensity of the lighting may be adjusted via leading and trail edge modulation in compatible lamps.

- 03.1060.30
- 03.1060.29
- 03.1060.14
- 03.1060.WG
- 03.1060.TK

COMPASS BOX

Compass Box Large 2L H:135

Light Source: LED QR-111 G53

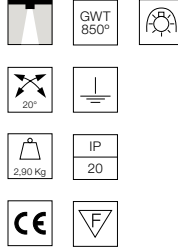
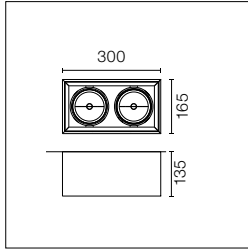

Apparecchio di illuminazione da superficie per soffitto/parete. Completo di trasformatore elettronico 220/240V – 12V, 50/60Hz. Per le lampade compatibili possibilità di regolazione dell'intensità luminosa tramite dimmer "leading and trailing edge".

Surface spotlight to be installed on ceiling/wall. Electronic transformer integrated 220/240V – 12V, 50/60Hz. The intensity of the lighting may be adjusted via leading and trail edge modulation in compatible lamps.

- 03.1061.30
- 03.1061.29
- 03.1061.14
- 03.1061.WG
- 03.1061.TK

Compass Box Large 4L H:135

Light Source: LED QR-111 G53

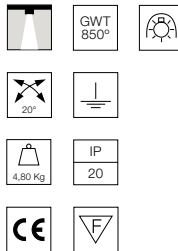
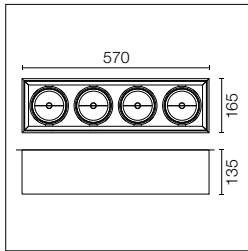

Apparecchio di illuminazione da superficie per soffitto/parete. Completo di trasformatore elettronico 220/240V – 12V, 50/60Hz. Per le lampade compatibili possibilità di regolazione dell'intensità luminosa tramite dimmer "leading and trailing edge".

Surface spotlight to be installed on ceiling/wall. Electronic transformer integrated 220/240V – 12V, 50/60Hz. The intensity of the lighting may be adjusted via leading and trail edge modulation in compatible lamps.

- 03.1063.30
- 03.1063.29
- 03.1063.14
- 03.1063.WG
- 03.1063.TK

Compass Box Large 4L H:135 Square

Light Source: LED QR-111 G53

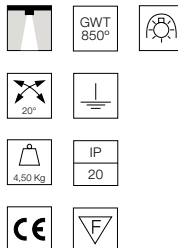
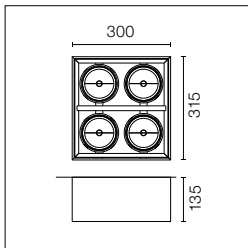

Apparecchio di illuminazione da superficie per soffitto/parete. Completo di trasformatore elettronico 220/240V – 12V, 50/60Hz. Per le lampade compatibili possibilità di regolazione dell'intensità luminosa tramite dimmer "leading and trailing edge".

Surface spotlight to be installed on ceiling/wall. Electronic transformer integrated 220/240V – 12V, 50/60Hz. The intensity of the lighting may be adjusted via leading and trail edge modulation in compatible lamps.

- 03.1064.30
- 03.1064.29
- 03.1064.14
- 03.1064.WG
- 03.1064.TK

Accessori / Accessories

Compass Box Small: QR-CBC 51

Filtro a croce antiabbagliamento
Screening crosspiece



08.8238.14

Honeycomb
Honeycomb



08.8196.14

Compass Box Large: QR-111

Filtro a croce antiabbagliamento
Screening crosspiece



08.8034.14

Honeycomb
Honeycomb



08.8036.14

SUPER LINE&PRO

DESIGNED BY FLOS ARCHITECTURAL

SUPER LINE
UP&DOWN
INDIRECT

LIGHT SOURCE
TOP LED
58W
4488 lm UP
2160 lm DOWN
3000K/CRI 90

4794 lm UP
2280 lm DOWN
4000K/CRI 90

SUPER LINE
UP&DOWN
DIRECT

LIGHT SOURCE
TOP LED
58W
2268 lm UP
4488 lm DOWN
3000K/CRI 90

2376 lm UP
4794 lm DOWN
4000K/CRI 90

SUPER LINE
DOWN

LIGHT SOURCE
TOP LED
38,6W
4488 lm
3000K/CRI 90
4794 lm
4000K/CRI 90

SUPER LINE PRO
UP&DOWN

LIGHT SOURCE
TOP LED
60W
UP TO 4075 lm UP
UP TO 4605 lm DOWN
3000K/CRI 90

UP TO 4337 lm UP
UP TO 4900 lm DOWN
4000K/CRI 90

SUPER LINE PRO
DOWN

LIGHT SOURCE
TOP LED
40W
UP TO 5072 lm
3000K/CRI 90
UP TO 4765 lm
4000K/CRI 90

□ 40 Bianco
40 White

■ 02 Grigio
02 Grey

■ 14 Nero
14 Black

Super Line



Super Line Pro



Super Line

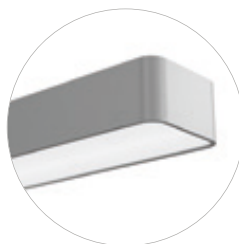

Super Line Pro



Descrizione

Collezione di apparecchi di illuminazione sospesi per illuminazione generale con la firma di un design minimalista, disegnata per offrire illuminazione ad alto rendimento, qualità della luce e confort visivo combinato in un formato ultracompatto.

La versione Super Line Pro è stata sviluppata appositamente per soddisfare tutti i requisiti per il controllo dell'abbagliamento e il confort visivo negli spazi di lavoro. Offre un UGR inferiore a 14 e un valore di intensità massima per angoli di 65° secondo la norma inferiore a 3000 cd/m², garantendo le migliori condizioni negli ambienti di lavoro e in innumerevoli altre applicazioni. (Vedi tabella UGR nella sezione accessori).

Il corpo principale degli apparecchi d'illuminazione è fabbricato in alluminio estruso. Il Super Line è dotato di un filtro diffusore tecnico multistrato che, grazie alla combinazione di filtri prismatici ed ellittici, assicura una distribuzione perfetta della luce e migliora l'effetto ottico e il confort visivo mediante le sue proprietà antiabbagliamento.

Super Line Up & Down è disponibili in due versioni:

- Indirect: versione che privilegia l'emissione indiretta verso l'alto, con un'intensità luminosa indiretta più importante, che rende omogeneo l'ambiente di illuminazione, disegnata per offrire un UGR<19e la condizione luminosa ideale richiesta negli uffici.

- Direct: versione che privilegia l'illuminazione diretta e massimizza l'efficienza, prevenendo contemporaneamente l'effetto "caverna" con la sua intensità indiretta, garantendo un elevato livello di confort.

Super Line Pro Up&Down comprende un' unica versione che può essere regolata tramite il driver corrispondente per offrire una maggiore quantità di flusso nell'emissione superiore o inferiore.

Per minimizzare l'impatto visivo della collezione, i conduttori fungono da cavi di sospensione, eliminando così la canalina di alimentazione. Lunghezza di sospensione 4,25m.

Informazioni di Installazione

Super Line è fabbricata combinando il modulo di alimentazione selezionato con uno di questi tre kit d'installazione esistenti:

- Surface Kit: comprende cassetta a incasso con il driver di alimentazione.

- Integrated Kit: comprende cassetta di installazione a incasso, con il driver di alimentazione.

- Remote Power Supply Kit: comprende protezione accessoria per il cavo che attraversa il cartongesso.

Tutti i kit di installazione sono disponibili sia nella versione DALI che in quella non dimmerabile.

Super Line Pro dispone degli stessi Kit di alimentazione. Per la versione UP&Down gli alimentatori sono provvisti di due uscite verso l'apparecchio, ognuna delle quali presenta un'intensità di corrente dedicata (mA). Collegando le due uscite rispettivamente ad ognuna delle due entrate (Up o Down) dell'apparecchio è possibile associare il flusso maggioritario e quello minoritario all'emisfero superiore o a quello inferiore.

Le versioni non dimmerabili sono provviste di un driver multi-corrente, che può essere attivato durante l'installazione per ottenere le condizioni di illuminazione richieste. I kit di installazione Super Line vengono forniti dalla fabbrica al 100% della potenza nominale.

Tutti gli apparecchi sono provvisti di una livella circolare ad alta precisione, che semplifica l'installazione dell'apparecchio, controllando la calibrazione di entrambe le assi.

Informazioni Aggiuntive

Classe d'isolation I.

Grado di protezione IP20.

Conformità e Marchi di Qualità

Apparecchio conforme alla Normativa Tecnica Europea EN60598-1 e relative parti seconde.

Description

Collection of suspended luminaires for general lighting with a signature minimalist shape, designed to offer high-performance lighting, light quality and visual comfort combined in a very compact size.

The Super Line Pro version was designed to meet all requirements to reduce glare and improve visual comfort in offices, complying with the most restrictive conditions. A UGR less than 14 and a maximum intensity value less than 3000 cd/m² at an angle of 65° according to the standard, guarantee the best conditions for workplaces and make it perfect for many other applications. (Refer to the UGR chart in the accessories section).

The main body of the lights is made from extruded aluminium. Super Line is equipped with a multilayer diffusion filter which, thanks to its combination of elliptical and prism-shaped filters, ensures that the light is perfectly distributed and improves the overall visual effect, as well as providing comfort with its anti-glare properties.

Super Line Up&Down is available in two different versions:

- Indirect: a version which is better for emitting light indirectly upwards, with a greater intensity of indirect luminosity that homogenizes the lighting area, designed to provide UGR<19 and the perfect lighting conditions for offices.

- Direct: a version which is better for direct lighting and maximises efficiency, but at the same time prevents any "cave effect" with its indirect intensity, guaranteeing a high level of comfort.

Super Line Pro Up&Down comes in only one version that can be adjusted using the corresponding driver to offer a higher flux in the upper or lower part.

To minimise the visual impact of the collection, the suspension cables are also the wires, which eliminates the need for a power supply cable. Suspension length: 4.25 meters.

Installation Information

The Super Line is constructed combining the selected light source module with one of the three existing installation kits:

- Surface Kit: includes surface mounted box including the power supply driver.

- Integrated Kit: includes flush-recessed installation box, including power supply driver.

- Remote Power Supply Kit: includes an accessory as pass-through cable protection as well as a power supply driver for a remote accessible installation.

All installation kits are available either in DALI version or in a non dimmable version.

Super Line Pro uses the same power kits. For the Up&Down version, the power sources have two outputs to the light fitting, each with an amount of current (mA). By connecting each of these outputs to an input of the light fitting (Up or Down), a higher or lower flux can be chosen for each part.

The non dimmable versions are equipped with a multi-current driver that can be set during the installation in order to achieve the required illumination conditions. The Super Line installation kits come from factory at 100% of their nominal power.

All luminaires host a high-precision circular level, simplifying the installation of the luminaire, controlling calibration in both axes.

Additional Information

Insulation class I.

IP20 protection grade.

Standard Compliance and Quality Marks

EN60598-1 European Technical Standards and any subsequent additions.

FLOS
CONTROL BY CASAMBI



SUPER LINE & PRO

Super Line Up&Down Indirect

Light Source: Top LED 58W - 4488 lm UP - 2160 lm DOWN - 3000K/CRI 90 / 58W - 4794 lm UP - 2280 lm DOWN - 4000K/CRI 90

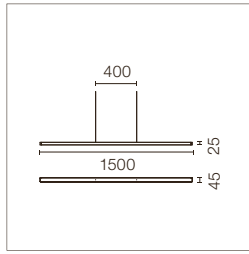

Apparecchio di illuminazione LED generale diretta e indiretta con design minimalista distintivo e compatto, adatto per installazione a soffitto mediante sospensione. Fonte di alimentazione compresa nei diversi kit di installazione che devono essere ordinati separatamente.

LED luminaire for direct and indirect lighting with a signature minimalist and compact design, to be installed on ceilings by means of suspension. Power source included in installation kits must be ordered separately.

- 3000K**
- 03.9502.40
 - 03.9502.02
 - 03.9502.14

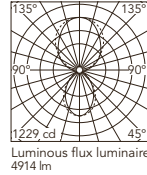

Beam Angle DIR: 101°

h(m)	E(lx)	D(m)
1	1229	2.39
2	307	4.78
3	137	7.17
4	77	9.57
5	49	11.96

- 4000K**
- 03.9503.40
 - 03.9503.02
 - 03.9503.14

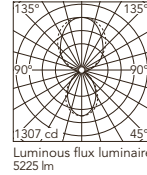

Beam Angle DIR: 101°

h(m)	E(lx)	D(m)
1	1307	2.39
2	327	4.78
3	145	7.17
4	82	9.57
5	52	11.96

Super Line Up&Down Direct

Light Source: Top LED 58W - 2268 lm UP - 4488 lm DOWN - 3000K/CRI 90 / 58W - 2376 lm UP - 4794 lm DOWN - 4000K/CRI 90

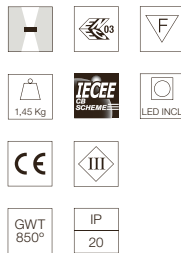
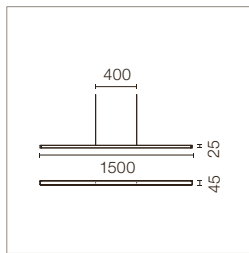

Apparecchio di illuminazione LED generale diretta e indiretta con design minimalista distintivo e compatto, adatto per installazione a soffitto mediante sospensione. Fonte di alimentazione compresa nei diversi kit di installazione che devono essere ordinati separatamente.

LED luminaire for direct and indirect lighting with a signature minimalist and compact design, to be installed on ceilings by means of suspension. Power source included in installation kits must be ordered separately.

- 3000K**
- 03.9500.40
 - 03.9500.02
 - 03.9500.14

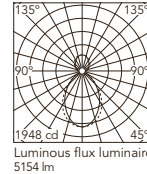

Beam Angle DIR: 82°

h(m)	E(lx)	D(m)
1	1948	1.57
2	487	3.13
3	216	4.70
4	122	6.27
5	78	7.84

- 4000K**
- 03.9501.40
 - 03.9501.02
 - 03.9501.14

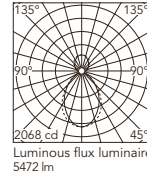

Beam Angle DIR: 82°

h(m)	E(lx)	D(m)
1	2068	1.57
2	517	3.13
3	230	4.70
4	129	6.27
5	83	7.84

Super Line Down

Light Source: Top LED 38,5W - 4488 lm - 3000K/CRI 90 / 38,5W- 4794 lm - 4000K/CRI 90

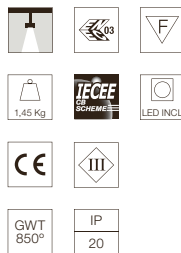
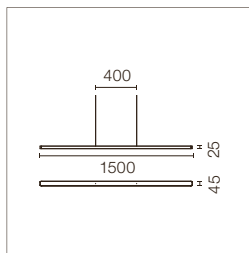

Apparecchio di illuminazione LED generale con design minimalista distintivo e compatto, adatto per installazione a soffitto mediante sospensione. Fonte di alimentazione compresa nei diversi kit di installazione, che devono essere ordinati separatamente.

LED luminaire for general lighting with a signature minimalist and compact design, to be installed on ceilings by means of suspension. Power source included in installation kits must be ordered separately.

- 3000K**
- 03.9510.40
 - 03.9510.02
 - 03.9510.14

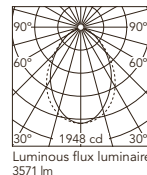

Beam Angle: 82°

h(m)	E(lx)	D(m)
1	1948	1.57
2	487	3.13
3	216	4.70
4	122	6.27
5	78	7.84

- 4000K**
- 03.9511.40
 - 03.9511.02
 - 03.9511.14

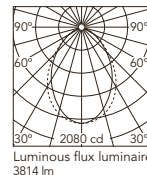

Beam Angle: 82°

h(m)	E(lx)	D(m)
1	2080	1.57
2	520	3.13
3	231	4.70
4	130	6.27
5	83	7.84

SUPER LINE & PRO

Super Line Pro Up&Down

Light Source: Majority UP - Top LED 60W - 4075 lm UP - 2500 lm DOWN - 3000K/CRI 90 / 60W - 4335 lm UP - 2660 lm DOWN - 4000K/CRI 90
 Majority DOWN - Top LED 60W - 2590 lm UP - 4605 lm DOWN - 3000K/CRI 90 / 60W - 2755 lm UP - 4900 lm DOWN - 4000K/CRI 90

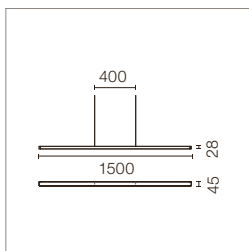

Apparecchio di illuminazione LED generale diretta e indiretta con design minimalista distintivo e compatto, adatto per installazione a soffitto mediante sospensione. Fonte di alimentazione compresa nei diversi kit di installazione che devono essere ordinati separatamente. La selezione della maggiore intensità Up o Down si realizza nei kit di alimentazione che includono un driver con due uscite indipendenti.

LED luminaire for direct and indirect lighting with a signature minimalist and compact design, to be installed on ceilings by means of suspension. Power source included in installation kits must be ordered separately. Greater Up or Down intensity can be selected using power kits with a device with two independent outputs.

- 3000K**
- 03.9560.40
 - 03.9560.02
 - 03.9560.14

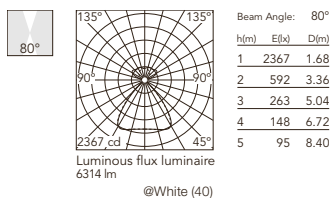
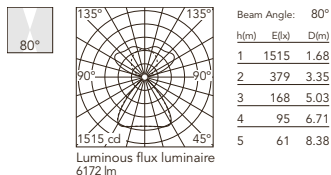

- 4000K**
- 03.9561.40
 - 03.9561.02
 - 03.9561.14

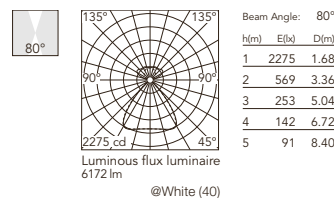
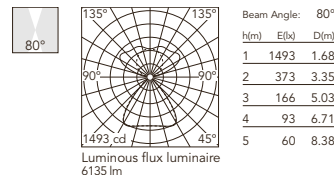

Super Line Pro Down

Light Source: Top LED 40W - 4765 lm - 3000K/CRI 90 / 40W- 5070 lm - 4000K/CRI 90

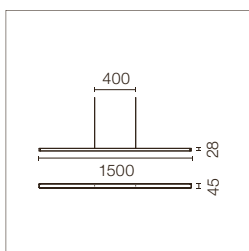

Apparecchio di illuminazione LED generale con design minimalista distintivo e compatto, adatto per installazione a soffitto mediante sospensione. Fonte di alimentazione compresa nei diversi kit di installazione, che devono essere ordinati separatamente, potendo selezionare l'intensità massima.

LED luminaire for general lighting with a signature minimalist and compact design, to be installed on ceilings by means of suspension. Power source included in installation kits must be ordered separately, allowing the maximum brightness to be selected.

- 3000K**
- 03.9570.40
 - 03.9570.02
 - 03.9570.14

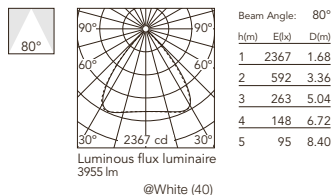

- 4000K**
- 03.9571.40
 - 03.9571.02
 - 03.9571.14

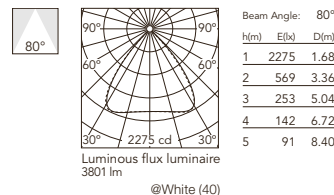

Accessori / Accessories

Le versioni non dimmerabili di Super Line e Super Line Pro Down sono equipaggiate con un'alimentazione di corrente multipla che può essere configurata durante l'installazione dell'apparecchio per adattare le condizioni di illuminazione e il livello di comfort visivo richiesti. Il kit di installazione viene fornito dalla fabbrica al 100% della potenza nominale (1050 mA).

Super Line Pro soddisfa in tutte le sue versioni e a massima potenza i parametri di UGR<19 e L65°<3000 cd.

The non-adjustable versions of Super Line and Super Line Pro Down are equipped with a multi-current driver, that can be set during the installation in order to achieve the required illumination conditions and comfort levels. Installation kits come from factory at 100% of their nominal power (1050 mA).

At maximum power, all versions of Super Line Pro comply with the requirements UGR<19 and L 65°<3000 cd.

Super Line

Driver setting	Light emission	Indirect		Direct	
		UGR*	L 65° < 3000 cd	UGR*	L 65° < 3000 cd
1050 mA	100%	UGR < 19			
850 mA	80%	UGR < 19			
700 mA	70%	UGR < 19			
550 mA	55%	UGR < 19	✓		
500 mA	50%	UGR < 19	✓	UGR < 19	✓
350 mA	36%	UGR < 19	✓	UGR < 19	✓

*X=4H, Y=8H, S=0.25H, reflections 70/50/20

Super Line Pro

Light emission	UGR*	L 65° < 3000 cd
Up & Down Majority Up	UGR < 14	✓
Up & Down Majority Down	UGR < 17	✓
Down	UGR < 18	✓

Super Line / Super Line Pro Down

Surface Power Supply Kit

Comprende fonte di alimentazione 60W - 220/240V. I Kit per Super Line e Super Line Pro Down dispongono di driver con dip-switch per selezionare l'intensità massima richiesta.

60W – 220/240V power supply included. Kits for Super Line and Super Line Pro Down are equipped with a dip-switch driver to select the maximum intensities.

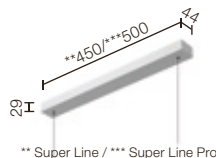

Non Dimmable

- 08.0520.40
- 08.0520.02
- 08.0520.14
- Dali Version*
- 08.0521.40
- 08.0521.02
- 08.0521.14

Super Line Pro Up&Down

Surface Power Supply Kit

Include driver 85W - 220/240V. I Kit per Super Line Pro Up&Down dispongono di due uscite per permettere di scegliere quale emissione (Up o Down) disporrà di un'intensità maggiore.

85W – 220/240V power supply included. Kits for Super Line Pro Up&Down are equipped with two outputs to select which part (Up or Down) is brighter.

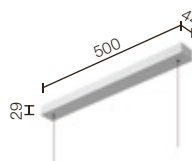

Non Dimmable/Dali Version

- 08.0640.40
- 08.0640.02
- 08.0640.14

Super Line / Super Line Pro Down

Recessed Power Supply Kit

Comprende fonte di alimentazione 60W - 220/240V. I Kit per Super Line e Super Line Pro Down dispongono di driver con dip-switch per selezionare l'intensità massima richiesta.

60W – 220/240V power supply included. Kits for Super Line and Super Line Pro Down are equipped with a dip-switch driver to select the maximum intensities.

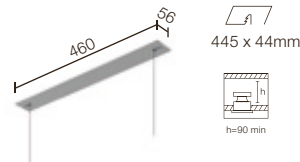

Non Dimmable

- 08.0522.40
- 08.0522.02
- 08.0522.14
- Dali Version*
- 08.0523.40
- 08.0523.02
- 08.0523.14

Super Line Pro Up&Down

Recessed Power Supply Kit

Include driver 85W - 220/240V. I Kit per Super Line Pro Up&Down dispongono di due uscite per permettere di scegliere quale emissione (Up o Down) disporrà di un'intensità maggiore.

85W – 220/240V power supply included. Kits for Super Line Pro Up&Down are equipped with two outputs to select which part (Up or Down) is brighter.

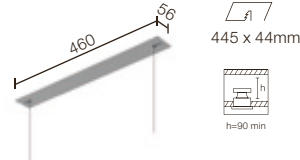

Non Dimmable/Dali Version

- 08.0641.40
- 08.0641.02
- 08.0641.14

* Per versioni 1-10V e Push, consultare il Front Office/Ufficio tecnico / For 1-10V and Push versions, please ask the Front Office/Technical Department.

SUPER LINE&PRO

Accessori / Accessories

Super Line / Super Line Pro Down

Remote Power Supply Kit

Fornito con due kit sospensione e una fonte di alimentazione a 60W - 220/240V. I Kit per Super Line e Super Line Pro Down dispongono di driver con dip-switch per selezionare l'intensità massima richiesta.

Includes two suspension kits and a 60W - 220/240V power supply. Kits for Super Line and Super Line Pro Down are equipped with a dip-switch driver to select the maximum intensities.

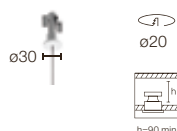

- Non Dimmable
- 08.0524.40
 - 08.0524.02
 - 08.0524.14
- Dali Version*
- 08.0525.40
 - 08.0525.02
 - 08.0525.14

Super Line Pro Up&Down

Remote Power Supply Kit

Fornito con due kit di sospensione e due fonte di alimentazione da 45W - 220/240V. I Kit per Super Line Pro Up&Down dispongono di due uscite per permettere di scegliere quale emissione (Up o Down) disporrà di un'intensità maggiore.

Includes two suspension kits and two 45W - 220/240V power supplies. Kits for Super Line Pro Up&Down are equipped with two outputs to select which part (Up or Down) is brighter.

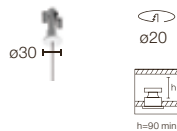

- Non Dimmable/Dali Version
- 08.0642.40
 - 08.0642.02
 - 08.0642.14

Installation Sequence

Recessed Power Supply Kit

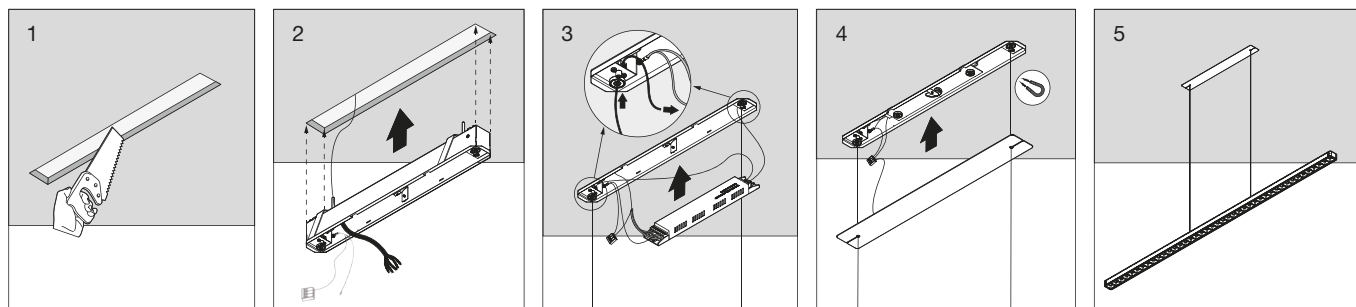

Surface Power Supply Kit

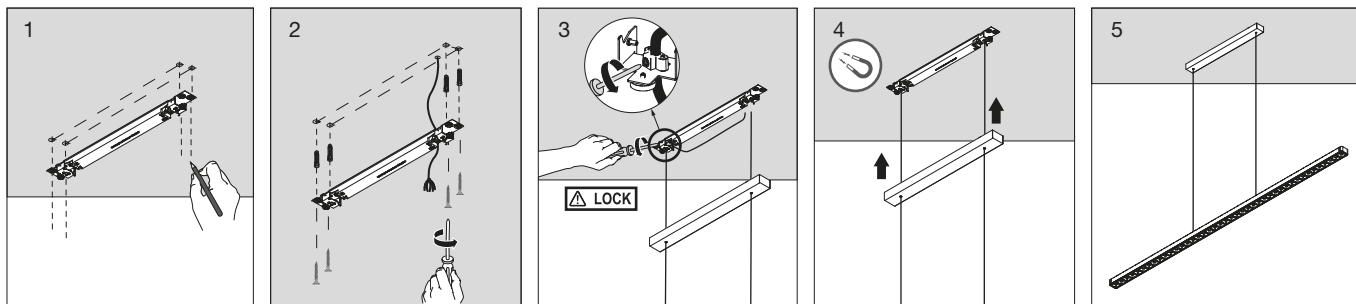

Remote Power Supply Kit

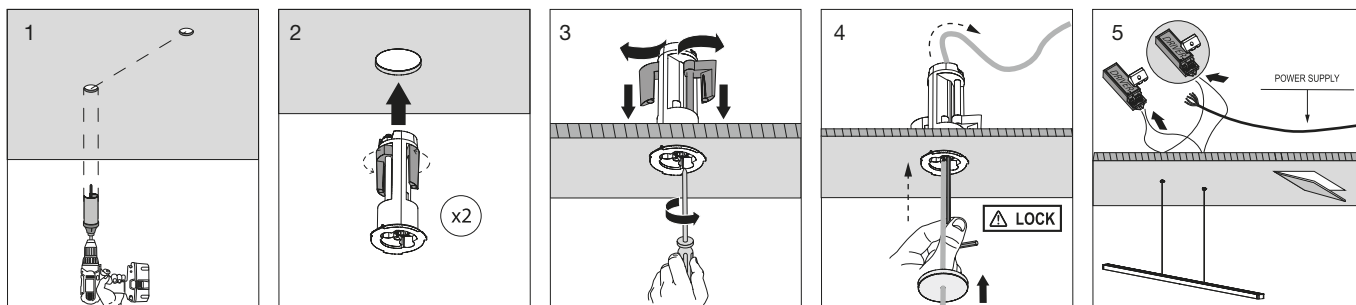

* Per versioni 1-10V e Push, consultare il Front Office/Ufficio tecnico / For 1-10V and Push versions, please ask the Front Office/Technical Department.

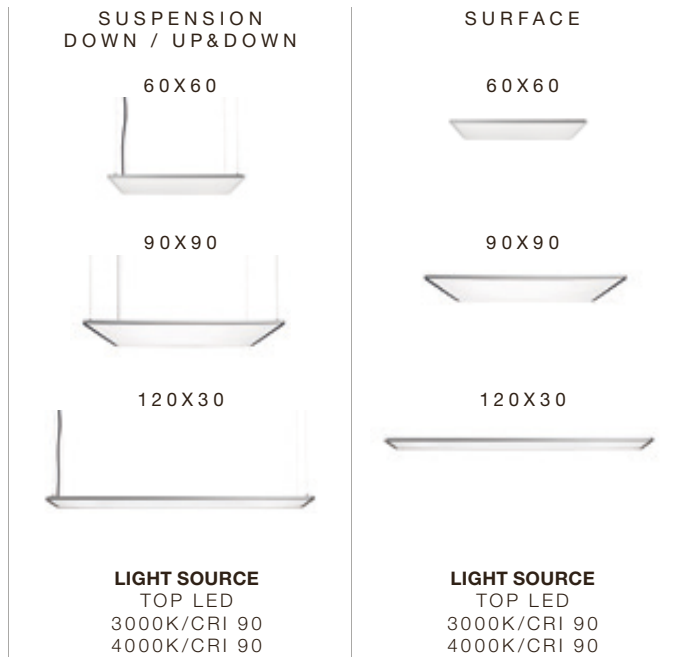

□ 30 Bianco
30 White

■ 02 Grigio
02 Grey

■ 14 Nero
14 Black



Descrizione

Famiglia di apparecchi di illuminazione generale a luce diretta e indiretta. La famiglia Super Flat è disponibile in due versioni: a forma quadrata e a forma rettangolare, entrambe in alluminio estruso e con angolari in alluminio ad iniezione.

Super Flat dispone di guide appositamente progettate per garantire un flusso luminoso ottimale e un grande comfort visivo. L'efficienza di questo innovativo sistema di illuminazione permette di ridurre al minimo le perdite di energia.

Per una maggiore versatilità del prodotto, tutta la famiglia Super Flat è stata sviluppata in versioni a sospensione e a plafone.

Unità di Alimentazione

L'apparecchio di illuminazione viene fornito con gli alimentatori a corrente costante 220/240V compresi.

Informazioni Aggiuntive

- Versione 30x30:

Classe d'isolation II, Grado di protezione IP20.

- Versioni 60x60/90x90/120x20/120x30:

Classe d'isolation I, Grado di protezione IP20.

Conformità e Marchi di Qualità

Apparecchio conforme alla Normativa Tecnica Europea EN60598-1 e relative parti seconde.

Description

Family of general lighting luminaires with direct and indirect light distribution. The Super Flat family has several square and rectangular versions, all of which are made of extruded aluminium and with angle brackets made of injected aluminium.

Super Flat has some especially designed guides, guaranteeing optimal light flow and great visual comfort. Energy losses are minimised with this efficient and innovative lighting system.

The entire Super Flat family has been developed in suspended and surface mounted versions for greater product versatility.

Power Supply

The luminaire is supplied with integrated 220/240 V constant current power supply sources.

Additional Information

- Version 30x30:

Insulation class II, IP20 protection grade.

- Versions 60x60/90x90/120x20/120x30:

Insulation class I, IP20 protection grade.

Standard Compliance and Quality Marks

EN60598-1 European Technical Standards and any subsequent additions.



reddot design award
winner 2013

SUPER FLAT

Super Flat Suspension 60x60 Down

Light Source: Top LED 3000K/CRI 90 / 4000K/CRI 90

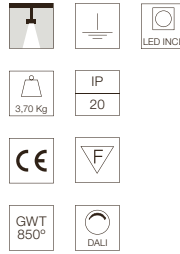
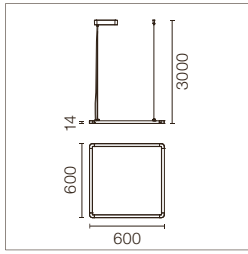

Apparecchio LED di illuminazione generale da installare a soffitto mediante sospensione. Alimentatore 220/240V compreso.

General lighting LED luminaire to be suspended from ceiling. Power supply 220/240V included.

3000K
Light Source:
Max. 4821 lm.
Efficienza dell'apparecchio:
Max. 115 lm/W

4000K
Light Source:
Max. 5303 lm.
Efficienza dell'apparecchio:
Max. 126 lm/W.

3000K
Light Source:
Max. 4821 lm.
Luminous efficiency of luminaire:
Max. 115 lm/W

4000K
Light Source:
Max. 5303 lm.
Luminous efficiency of luminaire:
Max. 126 lm/W.

Consumo totale del sistema:
40W.

Total consumption of the system:
40W.

3000K

Non Dimmable

- 09.5010.30B
- 09.5010.02B
- 09.5010.14B

Dali Version

- 09.5010.30BDA
- 09.5010.02BDA
- 09.5010.14BDA

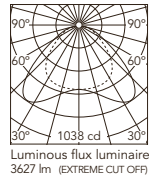

Beam Angle: 109°

h(m)	E(lx)	D(m)
1	1038	2.81
2	259	5.63
3	115	8.44
4	65	11.25
5	42	14.06

4000K

Non Dimmable

- 09.5011.30B
- 09.5011.02B
- 09.5011.14B

Dali Version

- 09.5011.30BDA
- 09.5011.02BDA
- 09.5011.14BDA

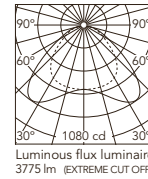

Beam Angle: 109°

h(m)	E(lx)	D(m)
1	1080	2.81
2	270	5.63
3	120	8.44
4	68	11.25
5	43	14.06

Super Flat Suspension 60x60 Up&Down

Light Source: Top LED 3000K/CRI 90 / 4000K/CRI 90

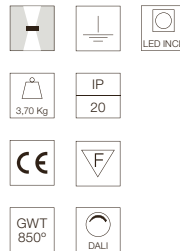
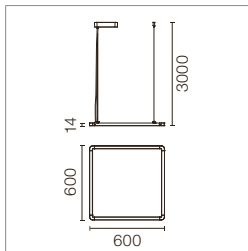

Apparecchio LED di illuminazione generale indiretta e diretta da installare a soffitto mediante sospensione. Alimentatore 220/240V compreso.

General lighting LED luminaire, direct and indirect beam, to be suspended from ceiling. Power supply 220/240V included.

3000K
Light Source:
Up: Max. 2410 lm.
Down: Max. 2410 lm.
Efficienza dell'apparecchio:
Max. 115 lm/W

4000K
Light Source:
Up: Max. 2651 lm.
Down: Max. 2651 lm.
Efficienza dell'apparecchio:
Max. 126 lm/W.

3000K
Light Source:
Up: Max. 2410 lm.
Down: Max. 2410 lm.
Luminous efficiency of luminaire:
Max. 115 lm/W

4000K
Light Source:
Up: Max. 2651 lm.
Down: Max. 2651 lm.
Luminous efficiency of luminaire:
Max. 126 lm/W.

Consumo totale del sistema:
40W.

Total consumption of the system:
40W.

3000K

Non Dimmable

- 09.5015.30B
- 09.5015.02B
- 09.5015.14B

Dali Version

- 09.5015.30BDA
- 09.5015.02BDA
- 09.5015.14BDA

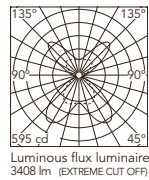

Beam Angle DIR: 52°

h(m)	E(lx)	D(m)
1	595	1.37
2	149	2.73
3	66	4.10
4	37	5.47
5	24	6.83

4000K

Non Dimmable

- 09.5016.30B
- 09.5016.02B
- 09.5016.14B

Dali Version

- 09.5016.30BDA
- 09.5016.02BDA
- 09.5016.14BDA

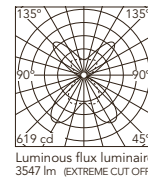

Beam Angle DIR: 52°

h(m)	E(lx)	D(m)
1	619	1.37
2	155	2.73
3	69	4.10
4	39	5.47
5	25	6.83

SUPER FLAT

Super Flat Suspension 90x90 Down

Light Source: Top LED 3000K/CRI 90 / 4000K/CRI 90

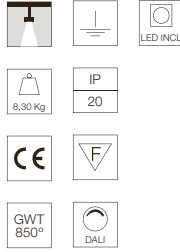
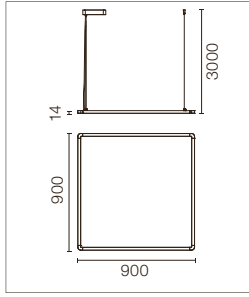

Apparecchio LED di illuminazione generale da installare a soffitto mediante sospensione. Alimentatore 220/240V compreso.

General lighting LED luminaire to be suspended from ceiling. Power supply 220/240V included.

3000K
Light Source:
Max. 6964 lm.
Efficienza dell'apparecchio:
Max. 138 lm/W
4000K
Light Source:
Max. 7660 lm.
Efficienza dell'apparecchio:
Max. 151 lm/W.

3000K
Light Source:
Max. 6964 lm.
Luminous efficiency of luminaire:
Max. 138 lm/W
4000K
Light Source:
Max. 7660 lm.
Luminous efficiency of luminaire:
Max. 151 lm/W.

Consumo totale del sistema:
55W.

Total consumption of the system:
55W.

3000K

Non Dimmable

- 09.5020.30B
- 09.5020.02B
- 09.5020.14B

Dali Version

- 09.5020.30BDA
- 09.5020.02BDA
- 09.5020.14BDA

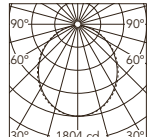

Beam Angle: 104°

h(m)	E(lx)	D(m)
1	1804	2.58
2	451	5.15
3	200	7.73
4	113	10.31
5	72	12.88

Luminous flux luminaire
4802 lm (EXTREME CUT OFF)

4000K

Non Dimmable

- 09.5021.30B
- 09.5021.02B
- 09.5021.14B

Dali Version

- 09.5021.30BDA
- 09.5021.02BDA
- 09.5021.14BDA

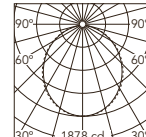

Beam Angle: 104°

h(m)	E(lx)	D(m)
1	1878	2.58
2	469	5.15
3	209	7.73
4	117	10.31
5	75	12.88

Luminous flux luminaire
4998 lm (EXTREME CUT OFF)

Super Flat Suspension 90x90 Up&Down

Light Source: Top LED 3000K/CRI 90 / 4000K/CRI 90

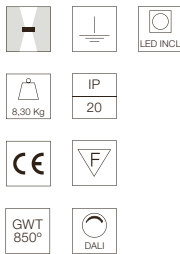
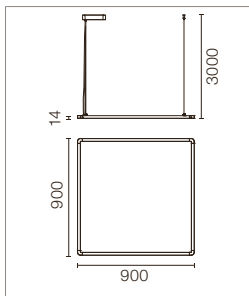

Apparecchio LED di illuminazione generale indiretta e diretta da installare a soffitto mediante sospensione. Alimentatore 220/240V compreso.

General lighting LED luminaire, direct and indirect beam, to be suspended from ceiling. Power supply 220/240V included.

3000K
Light Source:
Up: Max. 3482 lm.
Down: Max. 3482 lm.
Efficienza dell'apparecchio:
Max. 138 lm/W
4000K
Light Source:
Up: Max. 3830 lm.
Down: Max. 3830 lm.
Efficienza dell'apparecchio:
Max. 151 lm/W.

3000K
Light Source:
Up: Max. 3482 lm.
Down: Max. 3482 lm.
Luminous efficiency of luminaire:
Max. 138 lm/W
4000K
Light Source:
Up: Max. 3830 lm.
Down: Max. 3830 lm.
Luminous efficiency of luminaire:
Max. 151 lm/W.

Consumo totale del sistema:
55W.

Total consumption of the system:
55W.

3000K

Non Dimmable

- 09.5025.30B
- 09.5025.02B
- 09.5025.14B

Dali Version

- 09.5025.30BDA
- 09.5025.02BDA
- 09.5025.14BDA

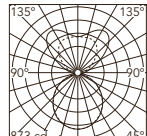

Beam Angle DIR: 108°

h(m)	E(lx)	D(m)
1	873	2.75
2	218	5.49
3	97	8.24
4	55	10.98
5	35	13.73

Luminous flux luminaire
4450 lm (EXTREME CUT OFF)

4000K

Non Dimmable

- 09.5026.30B
- 09.5026.02B
- 09.5026.14B

Dali Version

- 09.5026.30BDA
- 09.5026.02BDA
- 09.5026.14BDA

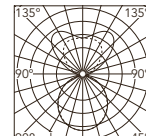

Beam Angle DIR: 108°

h(m)	E(lx)	D(m)
1	908	2.75
2	227	5.49
3	101	8.24
4	57	10.98
5	36	13.73

Luminous flux luminaire
4631 lm (EXTREME CUT OFF)

SUPER FLAT

Super Flat Suspension 120x30 Down

Light Source: Top LED 3000K/CRI 90 / 4000K/CRI 90

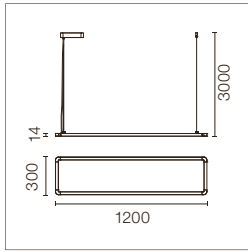

Apparecchio LED di illuminazione generale da installare a soffitto mediante sospensione. Alimentatore 220/240V compreso.

General lighting LED luminaire to be suspended from ceiling. Power supply 220/240V included.

3000K
Light Source:
Max. 6964 lm.
Efficienza dell'apparecchio:
Max. 138 lm/W

4000K
Light Source:
Max. 7660 lm.
Efficienza dell'apparecchio:
Max. 151 lm/W.

3000K
Light Source:
Max. 6964 lm.
Luminous efficiency of luminaire:
Max. 138 lm/W

4000K
Light Source:
Max. 7660 lm.
Luminous efficiency of luminaire:
Max. 151 lm/W.

Consumo totale del sistema:
56W.

Total consumption of the system:
56W.

3000K

Non Dimmable

- 09.5040.30B
- 09.5040.02B
- 09.5040.14B

Dali Version

- 09.5040.30BDA
- 09.5040.02BDA
- 09.5040.14BDA

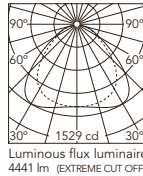

Beam Angle: 105°

h(m)	E(lx)	D(m)
1	1529	2.62
2	382	5.25
3	170	7.87
4	96	10.49
5	61	13.12

Luminous flux luminaire
4441 lm (EXTREME CUT OFF)

4000K

Non Dimmable

- 09.5041.30B
- 09.5041.02B
- 09.5041.14B

Dali Version

- 09.5041.30BDA
- 09.5041.02BDA
- 09.5041.14BDA

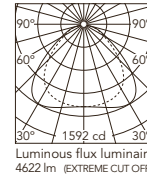

Beam Angle: 105°

h(m)	E(lx)	D(m)
1	1592	2.62
2	398	5.25
3	177	7.87
4	99	10.49
5	64	13.12

Luminous flux luminaire
4622 lm (EXTREME CUT OFF)

Super Flat Suspension 120x30 Up&Down

Light Source: Top LED 3000K/CRI 90 / 4000K/CRI 90

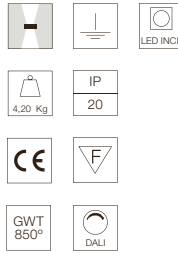
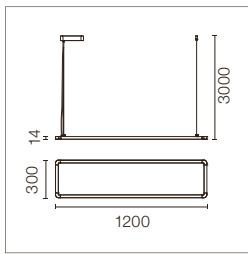

Apparecchio LED di illuminazione generale indiretta e diretta da installare a soffitto mediante sospensione. Alimentatore 220/240V compreso.

General lighting LED luminaire, direct and indirect beam, to be suspended from ceiling. Power supply 220/240V included.

3000K
Light Source:
Up: Max. 3482 lm.
Down: Max. 3482 lm.
Efficienza dell'apparecchio:
Max. 138 lm/W

4000K
Light Source:
Up: Max. 3830 lm.
Down: Max. 3830 lm.
Efficienza dell'apparecchio:
Max. 151 lm/W

3000K
Light Source:
Up: Max. 3482 lm.
Down: Max. 3482 lm.
Luminous efficiency of luminaire:
Max. 138 lm/W

4000K
Light Source:
Up: Max. 3830 lm.
Down: Max. 3830 lm.
Luminous efficiency of luminaire:
Max. 151 lm/W

Consumo totale del sistema:
56W.

Total consumption of the system:
56W.

3000K

Non Dimmable

- 09.5045.30B
- 09.5045.02B
- 09.5045.14B

Dali Version

- 09.5045.30BDA
- 09.5045.02BDA
- 09.5045.14BDA

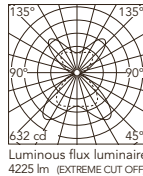

Beam Angle DIR: 109°

h(m)	E(lx)	D(m)
1	632	2.82
2	158	5.64
3	70	8.46
4	40	11.27
5	25	14.09

Luminous flux luminaire
4225 lm (EXTREME CUT OFF)

4000K

Non Dimmable

- 09.5046.30B
- 09.5046.02B
- 09.5046.14B

Dali Version

- 09.5046.30BDA
- 09.5046.02BDA
- 09.5046.14BDA

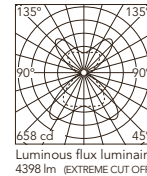

Beam Angle DIR: 109°

h(m)	E(lx)	D(m)
1	658	2.82
2	165	5.64
3	73	8.46
4	41	11.27
5	26	14.09

Luminous flux luminaire
4398 lm (EXTREME CUT OFF)

SUPER FLAT

Super Flat Surface 60x60 Down

Light Source: Top LED 3000K/CRI 90 / 4000K/CRI 90

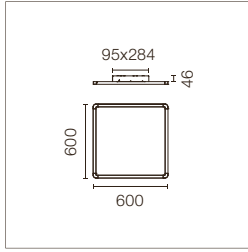

Apparecchio LED di illuminazione generale da installare a soffitto. Alimentatore 220/240V compreso.

Surface mounted general lighting LED luminaire. Power supply 220/240V included.

3000K
Light Source:
Max. 4821 lm.
Efficienza dell'apparecchio:
Max. 115 lm/W

4000K
Light Source:
Max. 5303 lm.
Efficienza dell'apparecchio:
Max. 126 lm/W.

3000K
Light Source:
Max. 4821 lm.
Luminous efficiency of luminaire:
Max. 115 lm/W

4000K
Light Source:
Max. 5303 lm.
Luminous efficiency of luminaire:
Max. 126 lm/W.

Consumo totale del sistema:
40W.

Total consumption of the system:
40W.

3000K

Non Dimmable

- 09.6010.30B
- 09.6010.02B
- 09.6010.14B

Dali Version

- 09.6010.30BDA
- 09.6010.02BDA
- 09.6010.14BDA

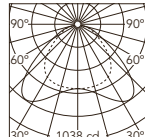

Beam Angle: 109°

h(m)	E(lx)	D(m)
1	1038	2.81
2	259	5.63
3	115	8.44
4	65	11.25
5	42	14.06

Luminous flux luminaire
3627 lm (EXTREME CUT OFF)

4000K

Non Dimmable

- 09.6011.30B
- 09.6011.02B
- 09.6011.14B

Dali Version

- 09.6011.30BDA
- 09.6011.02BDA
- 09.6011.14BDA

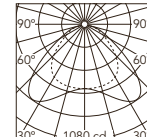

Beam Angle: 109°

h(m)	E(lx)	D(m)
1	1080	2.81
2	270	5.63
3	120	8.44
4	68	11.25
5	43	14.06

Luminous flux luminaire
3775 lm (EXTREME CUT OFF)

Super Flat Surface 90x90 Down

Light Source: Top LED 3000K/CRI 90 / 4000K/CRI 90

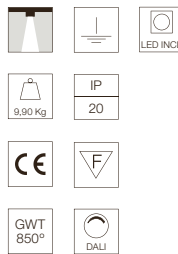
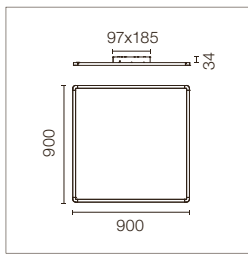

Apparecchio LED di illuminazione generale da installare a soffitto mediante sospensione. Alimentatore 220/240V compreso.

Surface mounted general lighting LED luminaire. Power supply 220/240V included.

3000K
Light Source:
Max. 6964 lm.
Efficienza dell'apparecchio:
Max. 138 lm/W

4000K
Light Source:
Max. 7660 lm.
Efficienza dell'apparecchio:
Max. 151 lm/W.

3000K
Light Source:
Max. 6964 lm.
Luminous efficiency of luminaire:
Max. 138 lm/W

4000K
Light Source:
Max. 7660 lm.
Luminous efficiency of luminaire:
Max. 151 lm/W.

Consumo totale del sistema:
55W.

Total consumption of the system:
55W.

3000K

Non Dimmable

- 09.6020.30B
- 09.6020.02B
- 09.6020.14B

Dali Version

- 09.6020.30BDA
- 09.6020.02BDA
- 09.6020.14BDA

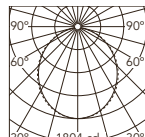

Beam Angle: 104°

h(m)	E(lx)	D(m)
1	1804	2.58
2	451	5.15
3	200	7.73
4	113	10.31
5	72	12.88

Luminous flux luminaire
4802 lm (EXTREME CUT OFF)

4000K

Non Dimmable

- 09.6021.30B
- 09.6021.02B
- 09.6021.14B

Dali Version

- 09.6021.30BDA
- 09.6021.02BDA
- 09.6021.14BDA

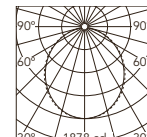

Beam Angle: 104°

h(m)	E(lx)	D(m)
1	1878	2.58
2	469	5.15
3	209	7.73
4	117	10.31
5	75	12.88

Luminous flux luminaire
4998 lm (EXTREME CUT OFF)

SUPER FLAT

Super Flat Surface 120x30 Down

Light Source: Top LED 3000K/CRI 90 / 4000K/CRI 90

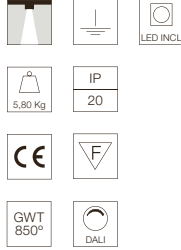
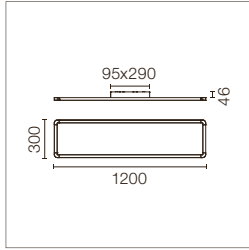

Apparecchio LED di illuminazione generale da installare a soffitto. Alimentatore 220/240V compreso.

Surface mounted general lighting LED luminaire. Power supply 220/240V included.

3000K

Light Source:
Max. 6964 lm.
Efficienza dell'apparecchio:
Max. 138 lm/W

4000K

Light Source:
Max. 7660 lm.
Efficienza dell'apparecchio:
Max. 151 lm/W

3000K

Light Source:
Max. 6964 lm.
Luminous efficiency of luminaire:
Max. 138 lm/W

4000K

Light Source:
Max. 7660 lm.
Luminous efficiency of luminaire:
Max. 151 lm/W

Consumo totale del sistema:
56W.

Total consumption of the system:
56W.

3000K

Non Dimmable

09.6040.30B

09.6040.02B

09.6040.14B

Dali Version

09.6040.30BDA

09.6040.02BDA

09.6040.14BDA

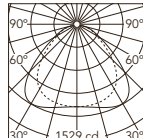

Beam Angle: 105°

h(m)	E lx	D(m)
1	1529	2.62
2	382	5.25
3	170	7.87
4	96	10.49
5	61	13.12

Luminous flux luminaire
4441 lm (EXTREME CUT OFF)

4000K

Non Dimmable

09.6041.30B

09.6041.02B

09.6041.14B

Dali Version

09.6041.30BDA

09.6041.02BDA

09.6041.14BDA

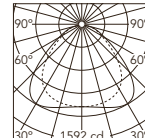

Beam Angle: 105°

h(m)	E lx	D(m)
1	1592	2.62
2	398	5.25
3	177	7.87
4	99	10.49
5	64	13.12

Luminous flux luminaire
4622 lm (EXTREME CUT OFF)

LIGHT BELL

DESIGNED BY PIERO LISSONI



LIGHT SOURCE
LED ARRAY
55W
6388 lm
2700K/CRI 90
6714 lm
3000K/CRI 90

Esterno / Outside

□ 70 Bianco Opaco
70 Matt White

■ AP Alluminio Lucido
AP Polished Aluminium

■ AN Nero Anodizzato
AN Anodized Black

Interno / Inside

■ Alluminio Anodizzato
Anodized Aluminium

■ Alluminio Anodizzato
Anodized Aluminium

■ Oro
Gold



Esterno / Outside

■ 18 Bruno
18 Dark Brown

■ 7C Nero Opaco
7C Matt Black

Interno / Inside

■ Oro
Gold

■ Rame Galvanico
Galvanic Copper



Esterno / Interno
Outside / Inside

□ 76 Vetro Trasparente
76 Transparent Glass

■ CE Cemento
CE Concrete



LIGHT BELL

Descrizione

Apparecchio di illuminazione generale a sospensione da installare in interni. Dispone di sorgente luminosa LED di ultima generazione ad alta efficienza e diffusore in termoplastica tecnica a basse perdite. Il riflettore dell'apparecchio viene fornito separatamente ed è disponibile in alluminio spazzolato in varie decorazioni e in vetro trasparente. Alimentatore integrato nel corpo dell'apparecchio.

Unità di Alimentazione

Alimentatore a corrente costante 220/240V integrato.

Informazioni Aggiuntive

Disponibile in versioni Dali, e Dimmerabile Push.
Grado di protezione IP20.
Classe di isolamento I.
Dissipatore tipo pin-block.

Conformità e Marchi di Qualità

Apparecchio conforme alla Normativa Tecnica Europea EN60598-1 e relative parti seconde.

Description

Suspended general lighting luminaire for indoor mounting. It has a high efficiency latest generation LED light source and a low-loss technical thermoplastic diffuser. The reflector is supplied separately and is available in spun aluminium with different patterns, and in transparent glass, depending on the versions. Power supply source integrated into luminaire housing.

Power Supply

Integrated 220/240V constant voltage power supply source.

Additional Information

Available in Dali, and Dimmable Push versions.
IP20 protection grade.
Insulation class I.
Pin-block type dissipater.

Standard Compliance and Quality Marks

EN60598-1 European Technical Standards and any subsequent additions.



LIGHT BELL

Light Bell Light Source

Light Source: LED Array 55W - 6388 lm - 2700K/CRI 90 / 55W - 6714 lm - 3000K/CRI 90

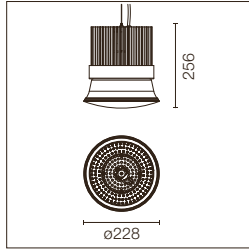

Apparecchio di illuminazione a LED per installazione a sospensione (massima distanza dal soffitto 4 metri). Alimentatore 220/240V integrato nel corpo dell'apparecchio. Riflettore non compreso, viene fornito separatamente. Contattateci per IP superiori. Fornito con cavo di sospensione di 4m.

Suspended luminaire for mounting on the ceiling with LED light source. (4 metres maximum distance to ceiling). Power supply source 220/240V integrated into luminaire housing. Reflector not included; supplied separately. Please ask us for a higher IP. Includes a 4-meter suspension cable.

2700K

- Non Dimmable
- 07.9641.14A
- Dimmable Push
- 07.9641.14ADP
- Dimmable Dali
- 07.9641.14ADA

3000K

- Non Dimmable
- 07.9642.14A
- Dimmable Push
- 07.9642.14ADP
- Dimmable Dali
- 07.9642.14ADA

Light Bell Reflector

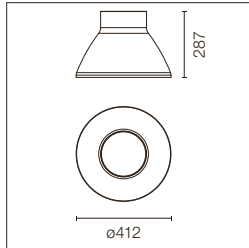

07.9630.70



E I **2700K**
07.9630.70
+
07.9641.14A

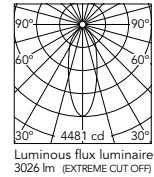

Beam Angle: 37°

h(m)	E(lx)	D(m)
1	4481	0.67
2	1120	1.33
3	498	2.00
4	280	2.67
5	179	3.34

E I **3000K**
07.9630.70
+
07.9642.14A

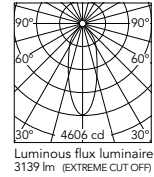

Beam Angle: 37°

h(m)	E(lx)	D(m)
1	4606	0.68
2	1152	1.35
3	512	2.03
4	288	2.70
5	184	3.38



07.9630.AP



E I **2700K**
07.9630.AP
+
07.9641.14A

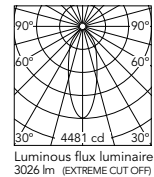

Beam Angle: 37°

h(m)	E(lx)	D(m)
1	4481	0.67
2	1120	1.33
3	498	2.00
4	280	2.67
5	179	3.34

E I **3000K**
07.9630.AP
+
07.9642.14A

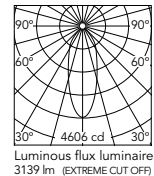

Beam Angle: 37°

h(m)	E(lx)	D(m)
1	4606	0.68
2	1152	1.35
3	512	2.03
4	288	2.70
5	184	3.38



07.9630.AN



E I **2700K**
07.9630.AN
+
07.9641.14A

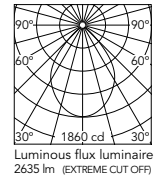

Beam Angle: 78°

h(m)	E(lx)	D(m)
1	1860	1.61
2	465	3.22
3	207	4.84
4	116	6.45
5	74	8.06

E I **3000K**
07.9630.AN
+
07.9642.14A

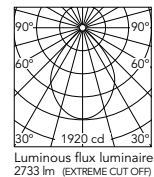

Beam Angle: 78°

h(m)	E(lx)	D(m)
1	1920	1.62
2	480	3.23
3	213	4.85
4	120	6.47
5	77	8.08

E= Finitura Esterna
I= Finitura Interna

E= External Finish
I= Internal Finish

LIGHT BELL

Light Bell Reflector



07.9630.18



E I 2700K
07.9630.18
+
07.9641.14A

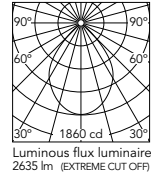

Luminous flux luminaire
2635 lm (EXTREME CUT OFF)

Beam Angle: 78°

h(m)	E(lx)	D(m)
1	1860	1.61
2	465	3.22
3	207	4.84
4	116	6.45
5	74	8.06

E I 3000K
07.9630.18
+
07.9642.14A

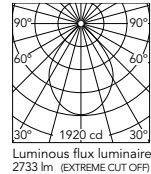

Luminous flux luminaire
2733 lm (EXTREME CUT OFF)

Beam Angle: 78°

h(m)	E(lx)	D(m)
1	1920	1.62
2	480	3.23
3	213	4.85
4	120	6.47
5	77	8.08



07.9630.7C



E I 2700K
07.9630.7C
+
07.9641.14A

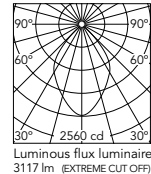

Luminous flux luminaire
3117 lm (EXTREME CUT OFF)

Beam Angle: 74°

h(m)	E(lx)	D(m)
1	2560	1.49
2	640	2.98
3	284	4.47
4	160	5.97
5	102	7.46

E I 3000K
07.9630.7C
+
07.9642.14A

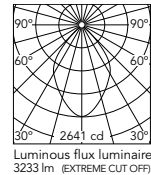

Luminous flux luminaire
3233 lm (EXTREME CUT OFF)

Beam Angle: 74°

h(m)	E(lx)	D(m)
1	2641	1.50
2	660	2.99
3	293	4.49
4	165	5.98
5	106	7.48



07.9630.76



2700K
07.9630.76
+
07.9641.14A

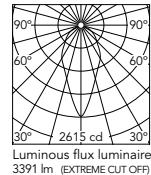

Luminous flux luminaire
3391 lm (EXTREME CUT OFF)

Beam Angle: 46°

h(m)	E(lx)	D(m)
1	2615	0.81
2	654	1.63
3	291	2.44
4	163	3.26
5	105	4.07

3000K
07.9630.76
+
07.9642.14A

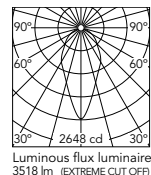

Luminous flux luminaire
3518 lm (EXTREME CUT OFF)

Beam Angle: 46°

h(m)	E(lx)	D(m)
1	2648	0.85
2	662	1.71
3	294	2.56
4	166	3.41
5	106	4.27



07.9630.CE



2700K
07.9630.CE
+
07.9641.14A

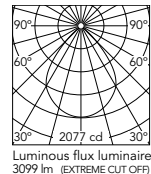

Luminous flux luminaire
3099 lm (EXTREME CUT OFF)

Beam Angle: 79°

h(m)	E(lx)	D(m)
1	2077	1.66
2	519	3.32
3	231	4.97
4	130	6.63
5	83	8.29

3000K
07.9630.CE
+
07.9642.14A

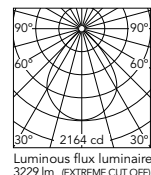

Luminous flux luminaire
3229 lm (EXTREME CUT OFF)

Beam Angle: 79°

h(m)	E(lx)	D(m)
1	2164	1.66
2	541	3.32
3	240	4.97
4	135	6.63
5	87	8.29

Accessori / Accessories

Rosone di alimentazione per interni. IP20. Rosette for indoors. IP20.

* La versione DALI F0557020 viene fornita con cavo di 4m, 5 poli e sezione 0,75mm².
* The F0557020 Dali version has a 4-meter cable, 5 poles and a 0.75mm² section.



Non Dimmable
F0556020
Dimmable Push/**Dali
F0557020

Rosone di alimentazione. IP54. Rosette. IP54.



08.8775.40

FORT KNOX WALL

DESIGNED BY PHILIPPE STARCK

FORT KNOX WALL



LIGHT SOURCE
POWER LED
35W
3930 lm
3000K/CRI 90
4135 lm
4000K/CRI 90

FORT KNOX WALL MINI



LIGHT SOURCE
POWER LED
25W
2695 lm
3000K/CRI 90
2840 lm
4000K/CRI 90

□ 40 Bianco
40 White

◻ 05 Alluminio Lucido
05 Polished Aluminium

■ 14 Nero/RAL 9005
14 Black



Descrizione

Apparecchio di illuminazione per installazione a parete a luce indiretta.

Corpo in lega di alluminio pressofuso con finitura lucida a mano protetta con vernice liquida trasparente o verniciato a polvere bianco o nero opaco.

Supporto a parete in alluminio pressofuso. Grazie al suo innovativo design, questo supporto permette la regolazione sia in orizzontale che in verticale, fino a 10 mm, garantendone la perfetta installazione su qualsiasi superficie. Inoltre, il prodotto viene fornito con una livella a bolla che permette di calibrare perfettamente l'apparecchio.

Riflettori

Lente asimmetrica che permette, grazie al design perfettamente adattato, un'efficienza massima dell'apparecchio di illuminazione oltre a una perfetta distribuzione della luce.

Unità di Alimentazione

Fonte di alimentazione Non Dimmable, Dimmable 1-10V o Dimmable Dali incorporata nel blocco principale dell'apparecchio di illuminazione.

Informazioni aggiuntive

Grado di protezione IP20.
Classe di isolamento I.

Conformità e Marchi di Qualità

Apparecchio conforme alla Normativa Tecnica Europea EN60598-1 e relative parti seconde.

Description

Luminaire for wall application designed for indirect lighting.

Die-cast aluminium alloy body with hand polished finish and protected with transparent liquid paint, or powder-coated white or matt black.

Wall support made in injected aluminium. Thanks to its innovative design, this holder allows both horizontal and vertical regulation up to 10 mm, ensuring a perfect installation on any type of surface. Additionally, this product includes a spirit level, allowing a perfect luminaire calibration.

Reflectors

Thanks to its adapted design, the asymmetrical lens allow luminaire's maximum efficiency and optimal light distribution.

Power Supply

Non Dimmable, Dimmable 1-10V or Dimmable Dali power source incorporated in the luminaire body..

Additional Information

IP20 protection grade.
Insulation class I.

Standard Compliance and Quality Marks

EN60598-1 European Technical Standards and any subsequent additions.

FORT KNOX WALL

Fort Knox Wall

Light Source: Power LED 35W - 3930 lm - 3000K/CRI 90 / 35W - 4135 lm - 4000K/CRI 90

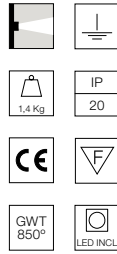
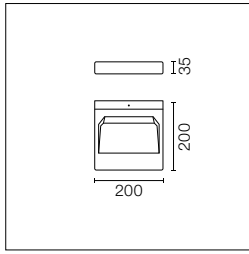

Apparecchio di illuminazione LED a parete per luce indiretta. Fonte di alimentazione 220-240V incorporata nella struttura dell'apparecchio.

Wall-mounted LED luminaire for indirect lighting. Power source 220-240V incorporated into luminaire's body.

3000K

Dimmable 1-10V

- 09.2110.40C
- 09.2110.05C
- 09.2110.14C
- Dali Version
- 09.2110.40CDA
- 09.2110.05CDA
- 09.2110.14CDA

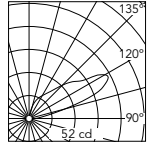

Luminous flux luminaire 3036 lm

Beam Angle: 30°

h(m)	E(lx)	D(m)
1	52	18.90
2	12	37.79
3	6	56.69
4	3	75.58
5	3	94.48

4000K

Dimmable 1-10V

- 09.2112.40C
- 09.2112.05C
- 09.2112.14C
- Dali Version
- 09.2112.40CDA
- 09.2112.05CDA
- 09.2112.14CDA

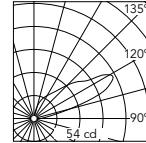

Luminous flux luminaire 3198 lm

Beam Angle: 30°

h(m)	E(lx)	D(m)
1	54	18.90
2	13	37.79
3	6	56.69
4	3	75.58
5	3	94.48

Fort Knox Wall Mini

Light Source: Power LED 25W - 2695 lm - 3000K/CRI 90 / 25W - 2840 lm - 4000K/CRI 90

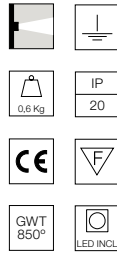
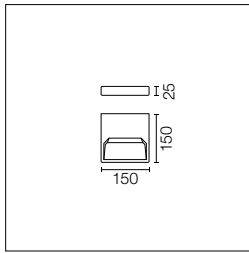

Apparecchio di illuminazione LED a parete per luce indiretta. Fonte di alimentazione 220-240V incorporata nella struttura dell'apparecchio. Mains Dimming su richiesta.

Wall-mounted LED luminaire for indirect lighting. Power source 220-240V incorporated into luminaire's body. Mains Dimming under request.

3000K

Non Dimmable

- 09.2125.40B
- 09.2125.05B
- 09.2125.14B

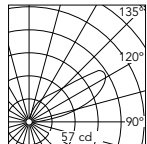

Luminous flux luminaire 1972 lm

Beam Angle: 33°

h(m)	E(lx)	D(m)
1	57	18.96
2	14	37.92
3	6	56.87
4	4	75.83
5	2	94.79

4000K

Non Dimmable

- 09.2127.40B
- 09.2127.05B
- 09.2127.14B

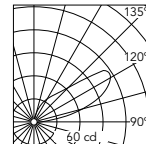

Luminous flux luminaire 2080 lm

Beam Angle: 33°

h(m)	E(lx)	D(m)
1	60	18.96
2	15	37.92
3	6	56.87
4	4	75.83
5	2	94.79

THIN LED

DESIGNED BY FLOS ARCHITECTURAL



LIGHT SOURCE
TOP LED
20W/m
24V
1822 lm/m
3000K/CRI 90

□ 30 Bianco
30 White

■ 29 Alluminio Anodizzato
29 Anodized Aluminium

■ BZ Bronzo Anodizzato
BZ Anodized Bronze



Modello brevettato e registrato / Patented and registered model.

Descrizione

Apparecchio d'illuminazione a parete per illuminazione indiretta.
Corpo in alluminio anodizzato con riflettore ottico interno in alluminio extra-puro. Facilissimo da installare ed estremamente versatile. Il circuito stampato è formato da moduli articolati con connettore doppio tramite contatti in argento. Tale caratteristica garantisce un'alimentazione di potenza sicura evitando i danni che potrebbero essere provocati durante la fase di installazione.
Il LED utilizzato, con un passo molto ridotto ed una emissione a 120° insieme al sistema di riflessione, garantisce una prestazione molto elevata ed una illuminazione uniforme.
Grazie al sistema di controllo dell'emissione luminosa brevettato, le prestazioni dell'accessorio luminoso sono veramente notevoli con una distribuzione luminosa ottimizzata molto confortevole.

Unità di Alimentazione

Fonte di alimentazione di 24V disponibile da 20W fino a 100W di potenza (3 metri di lunghezza).
Sistema di controllo con dimmer 1-10V o Dali disponibili.

Informazioni Aggiuntive

Moduli LED: 404 mm - 1201 mm - 1034 mm - 2040 mm - 2541 mm- 3042 mm.
Modulo cieco: 1034 mm.
Lunghezza di collegamento max. 3044 mm.
Coperture laterali incluse.
Grado di protezione IP20.
Classe di isolamento III.
Installabile su superfici normalmente infiammabili.

Conformità e Marchi di Qualità

Apparecchio conforme alla Normativa Tecnica Europea EN60598-1 e relative parti seconde.

Description

Wall application luminaire for indirect lighting.
Anodised aluminium housing with internal super-pure optical aluminium reflector. Very easy to install and extremely versatile. The printed circuit is made of jointed modules with double connector through silver contacts. This ensure a safe power supply avoiding damages which could be caused during assembling phase.
The utilized LED, with a very tight pitch and a 120° emission, together with the reflection system, grant a very high and even lighting emission performance.
Thanks to a patented light emission control system, the light fitting performance is really high, with an optimized and very comfortable light distribution.

Power Supply

24V power supplies available with a power of between 20W and 100W (3 metres in length).
Control system with 1-10V dimmer or Dali available.

Additional Information

Led modules: 404 mm - 1201 mm - 1034 mm - 2040 mm - 2541 mm- 3042 mm.
Blind module: 1034 mm.
Max connection length 3044 mm.
Side covers included.
IP20 protection grade.
Classe d'isolation III.
Suitable for installation on normally inflammable surfaces.

Standard Compliance and Quality Marks

EN60598-1 European Technical Standards and any subsequent additions.



THIN LED

Thin LED

Light Source: Top LED 20W/m - 24V - 1822 lm/m - 3000K/CRI 90

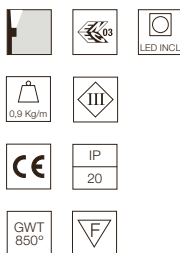
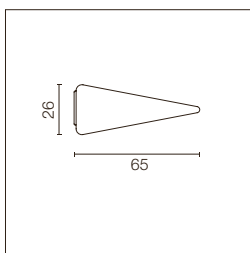

Apparecchio di illuminazione a parete per illuminazione indiretta a LED. Driver remoto non incluso.

Wall application luminaire for indirect lighting with LED. Remote transformer not included.

L: 404 mm

6,8W - 711 lm - 16 LEDs

- 09.0045.30B
- 09.0045.29B
- 09.0045.BZB

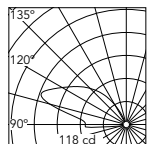

Luminous flux luminaire 621 lm

Beam Angle: 101°

h(m)	E(lx)	D(m)
1	118	6.46
2	30	12.92
3	13	19.38
4	7	25.84
5	5	32.30

L: 2040 mm

41W - 4266 lm - 84 LEDs

- 09.0101.30B
- 09.0101.29B
- 09.0101.BZB

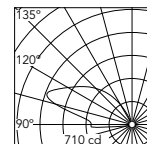

Luminous flux luminaire 3726 lm

Beam Angle: 101°

h(m)	E(lx)	D(m)
1	710	6.46
2	178	12.92
3	79	19.38
4	44	25.84
5	28	32.30

L: 1034 mm

20,5W - 2133 lm - 42 LEDs

- 09.0100.30B
- 09.0100.29B
- 09.0100.BZB

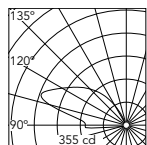

Luminous flux luminaire 1863 lm

Beam Angle: 101°

h(m)	E(lx)	D(m)
1	355	6.46
2	89	12.92
3	39	19.38
4	22	25.84
5	14	32.30

L: 2541 mm

47,8W - 5250 lm - 105 LEDs

- 09.0102.30B
- 09.0102.29B
- 09.0102.BZB

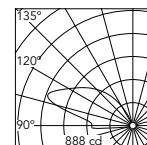

Luminous flux luminaire 4657 lm

Beam Angle: 101°

h(m)	E(lx)	D(m)
1	888	6.46
2	222	12.92
3	99	19.38
4	55	25.84
5	36	32.30

L: 1201 mm

23,9W - 2450 lm - 55 LEDs

- 09.0120.30B
- 09.0120.29B
- 09.0120.BZB

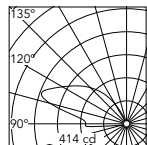

Luminous flux luminaire 2173 lm

Beam Angle: 101°

h(m)	E(lx)	D(m)
1	414	6.46
2	104	12.92
3	46	19.38
4	26	25.84
5	17	32.30

L: 3042 mm

61,5W - 6399 lm - 126 LEDs

- 09.0103.30B
- 09.0103.29B
- 09.0103.BZB

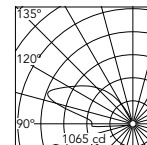

Luminous flux luminaire 5588 lm

Beam Angle: 101°

h(m)	E(lx)	D(m)
1	1065	6.46
2	266	12.92
3	118	19.38
4	67	25.84
5	43	32.30

L: 1034 mm BLIND*

- 09.0104.30A
- 09.0104.29A
- 09.0104.BZA

* Per creare linee continue di profili / To create continuous profile lines.

Driver / Drivers

Trasformatore elettronico per LED a tensione costante (24V). 100/240V.

Electronic transformer with constant voltage (24V) for LED. 100/240V.

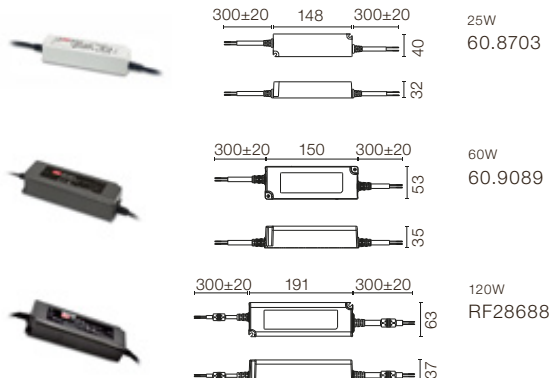

Unità di controllo per dimmer 1-10V con 1 canale per la regolazione di moduli LED, per drivers di 24V. Alimentatore non incluso. Max. 120W - 5A.

Dimmable 1-10V control unit with 1 channel for 24V LED modules. Power supply not included. Max. 120W - 5A.

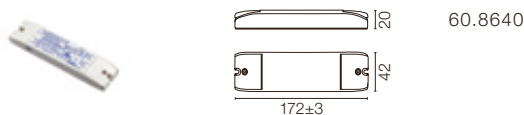





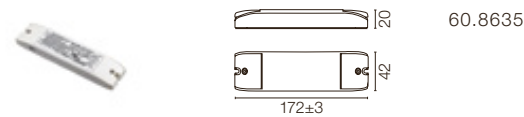

Unità di controllo dimmer Dali con 1 canale per la regolazione di moduli LED, per drivers di 24V. Alimentatore non incluso. Lunghezza massima 5 m/92,5W.

Dimmable Dali control unit with 1 channel for 24V LED modules. Power supply not included. Maximum length 5 m/92,5W.



WALL SYSTEM

DESIGNED BY ANTONIO CITTERIO

<p>BACK 1</p>  <p style="text-align: center;">LIGHT SOURCE TOP LED 6W 426 lm 3000K/CRI 80</p>	<p>BACK 1 OPTICAL SWITCH</p> 	<p>BACK 2</p>  <p style="text-align: center;">LIGHT SOURCE TOP LED 8W 553 lm 3000K/CRI 80</p>	<p>UP&DOWN</p>  <p style="text-align: center;">LIGHT SOURCE POWER LED 4W 2X150 lm 3000K/CRI 82</p>	<p>MINIKELVIN WALL FLEX</p> 	<p>MINIKELVIN FLEX</p>  <p style="text-align: center;">LIGHT SOURCE TOP LED 4W 216 lm 3000K/CRI 85</p>
--	---	--	---	---	---

Wall System

■ 57 Cromo
57 Chrome



Minikelvin

□ 09 Bianco
09 White

■ 57 Cromo
57 Chrome

■ 30 Nero
30 Black



Può essere ruotato di 360° e orientato di 120°.
Can be rotated 360° and swivelled 120°.

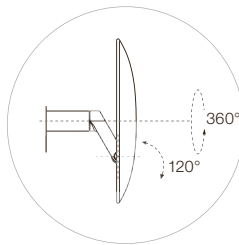

WALL SYSTEM

Descrizione

Famiglia di apparecchi di illuminazione per installazione a parete a luce indiretta (Wall System Back), diretta a doppia emissione (Wall System up&down) e a luce diffusa (Wall System Minikelvin Flex e Minikelvin Wall Flex).

- Wall System Back e Wall System Up&Down:

Corpo in alluminio pressofuso con finitura cromata, attacco a parete in PC stampato ad iniezione. Il diffusore è in metacrilato fotoinciso internamente stampato ad iniezione.

- Wall System Minikelvin Flex:

Testa in alluminio pressofuso cromato o verniciato (bianco / nero) montata su tubo flessibile, diffusore in metacrilato fotoinciso esternamente con cornice alluminata.

Per i modelli Back, Up&Down e Minikelvin Flex sono disponibili due versioni: incasso con driver integrato, che monta fregi tondi (Ø125) a parete di colore alluminio, bianco o nero, o incasso con driver remoto, a filo parete senza fregio. La versione con driver integrato utilizza come cassaforma indistintamente le scatole per muratura o cartongesso, facilmente reperibili su tutti i mercati europei; per quanto riguarda il mercato americano è previsto l'alloggiamento nella J-box standard.

- Minikelvin Wall Flex:

Testa in alluminio pressofuso cromato o verniciato (bianco / nero) montata su tubo flessibile, diffusore in metacrilato fotoinciso esternamente con cornice alluminata. Attacco a parete in PC stampato ad iniezione.

Unità di Alimentazione

Le versioni con driver integrato dispongono di alimentatore elettronico di ultima generazione.

Informazioni Aggiuntive

Grado di protezione IP20.

Classe di isolamento III.

Adatti ad installazioni su superfici normalmente infiammabili.

Conformità e Marchi di Qualità

Apparecchio conforme alla Normativa Tecnica Europea EN60598-1 e relative parti seconde.

Description

Range of indirect-illumination (Wall System Back), dual-emission, direct-illumination (Wall System up&down) and diffuse illumination (Wall System Minikelvin Flex and Minikelvin Wall Flex) wall-mounted lighting devices.

- Wall System Back and Wall System Up&Down:

Body in die-cast aluminium with chrome finish, wall attachment in injection-stamped PC. The diffuser is in injection-stamped, internally photo-etched methacrylate.

- Wall System Minikelvin Flex:

Die-cast head in chrome finish or painted (black / white) mounted on flexible tube, diffuser in methacrylate externally photo-etched with aluminate frame.

For the Back, Up&Down and Minikelvin Flex models, two versions are available: recessed with integrated driver, which takes round wall ornamentals (Ø125) in aluminium, white or black colour, or recessed with remote driver, flush with wall without ornamental. The version with integrated driver uses as casing either masonry boxes or plaster board, widely available all over Europe. For the US market, housing in the standard J-box is envisaged.

- Minikelvin Wall Flex:

Die-cast head in chrome finish or painted (black / white) mounted on flexible tube, diffuser in methacrylate externally photo-etched with aluminate frame. Wall attachment in injection-stamped PC.

Power Supply

Versions with integrated driver have a latest-generation electronic transformer.

Additional Information

IP20 protection grade.

Insulation class III.

Suitable for installation on normally inflammable surfaces.

Standard Compliance and Quality Marks

EN60598-1 European Technical Standards and any subsequent additions.

WALL SYSTEM

Wall System Back 1 Remote Power Supply

Light Source: Top LED 6W - 426 lm - 3000K/CRI 80

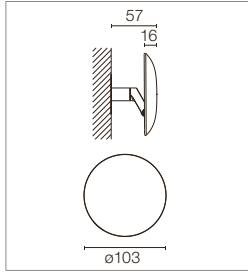

Apparecchio di illuminazione per installazione a filo parete a luce indiretta con driver remoto.

Indirect-illumination lighting device for installation flush with the wall with remote driver.

F9492057

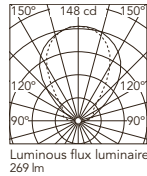

Beam Angle: 70°

h(m)	E(lx)	D(m)
1	148	2.05
2	37	4.10
3	16	6.16
4	9	8.21
5	6	10.26

Wall System Back 1 Power Supply Integrated

Light Source: Top LED 6W - 426 lm - 3000K/CRI 80

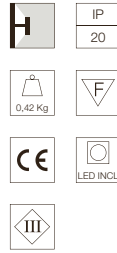
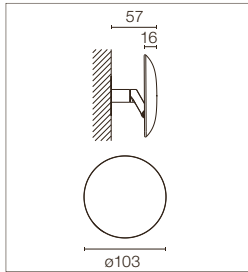

Apparecchio di illuminazione per installazione a parete a luce indiretta con driver integrato e con complemento fregio tondo (ø125).

Indirect-illumination lighting device for wall mounting with integrated driver and with round ornamental (ø125).

Vedi accessori disponibili. Per installazione in cartongesso è necessario utilizzare una cassa di dimensioni minime 110,2x68,8x53,7 mm.

See available accessories. For installation on plasterboard, a box of minimum size 110.2 x 68.8 x 53.7 mm must be used.

F9494057

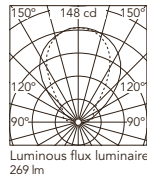

Beam Angle: 70°

h(m)	E(lx)	D(m)
1	148	2.05
2	37	4.10
3	16	6.16
4	9	8.21
5	6	10.26

Wall System Back 1 Remote Power Supply Optical Switch

Light Source: Top LED 6W - 426 lm - 3000K/CRI 80

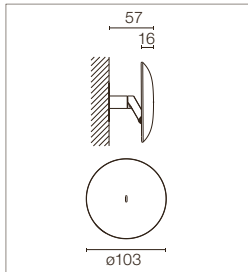

Apparecchio di illuminazione per installazione a filo parete a luce indiretta con driver remoto. ON/OFF con tecnologia Soft Touch e regolazione del flusso luminoso a 2 intensità (100% - 50% - 0%).

Indirect-illumination lighting device for installation flush with the wall with remote driver. ON/OFF switch with Soft Touch technology and light flow adjustment to 2 intensities (100% - 50% - 0%).

F9493057

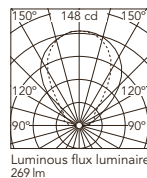

Beam Angle: 70°

h(m)	E(lx)	D(m)
1	148	2.05
2	37	4.10
3	16	6.16
4	9	8.21
5	6	10.26

WALL SYSTEM

Wall System Back 1 Power Supply Integrated Optical Switch

Light Source: Top LED 6W - 426 lm - 3000K/CRI 80

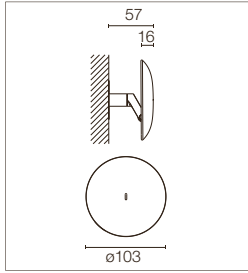

Apparecchio di illuminazione per installazione a parete a luce indiretta con driver integrato e con complemento fregio tondo (ø125). ON/OFF con tecnologia Soft Touch e regolazione del flusso luminoso a 2 intensità (100% - 50% - 0%).

Indirect-illumination lighting device for wall mounting with integrated driver and with round ornamental (ø125). ON/OFF switch with Soft Touch technology and light flow adjustment to 2 intensities (100% - 50% - 0%).

Vedi accessori disponibili.

See available accessories.

F9497057

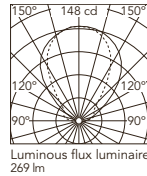

Beam Angle: 70°

h(m)	E(lx)	D(m)
1	148	2.05
2	37	4.10
3	16	6.16
4	9	8.21
5	6	10.26

Wall System Back 2 Remote Power Supply

Light Source: Top LED 8W - 553 lm - 3000K/CRI 80

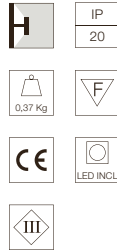
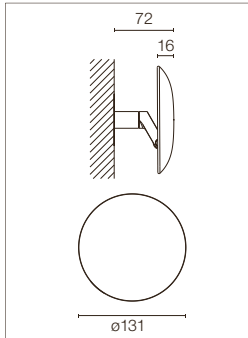

Apparecchio di illuminazione per installazione a filo parete a luce indiretta con driver remoto.

Indirect-illumination lighting device for installation flush with the wall with remote driver.

F9466057

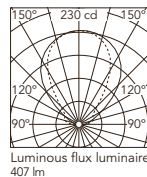

Beam Angle: 70°

h(m)	E(lx)	D(m)
1	230	2.07
2	57	4.14
3	26	6.21
4	14	8.28
5	9	10.35

Wall System Back 2 Power Supply Integrated

Light Source: Top LED 8W - 553 lm - 3000K/CRI 80

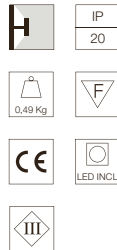
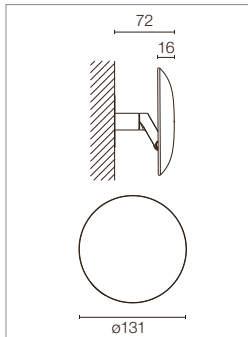

Apparecchio di illuminazione per installazione a parete a luce indiretta con driver integrato e con complemento fregio tondo (ø125).

Indirect-illumination lighting device for wall mounting with integrated driver and with round ornamental (ø125).

Vedi accessori disponibili. Per installazione in cartongesso è necessario utilizzare una cassa di dimensioni minime 110,2x68,8x53,7 mm.

See available accessories. For installation on plasterboard, a box of minimum size 110.2 x 68.8 x 53.7 mm must be used.

F9467057

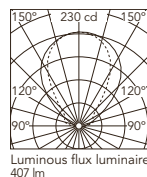

Beam Angle: 70°

h(m)	E(lx)	D(m)
1	230	2.07
2	57	4.14
3	26	6.21
4	14	8.28
5	9	10.35

WALL SYSTEM

Wall System Up&Down Remote Power Supply

Light Source: Power LED 4W - 2x150 lm - 3000K/CRI 82

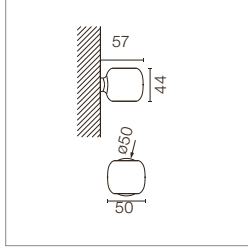

Apparecchio di illuminazione per installazione a filo parete a luce doppia emissione con driver remoto.

Lighting device with dual emission bulb for installation flush with the wall with remote driver.

F9477057

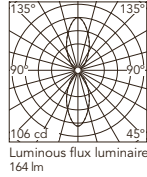

Beam Angle DIR: 49°

h(m)	E(lx)	D(m)
1	106	0.92
2	26	1.83
3	12	2.75
4	7	3.66
5	4	4.58

Wall System Up&Down Power Supply Integrated

Light Source: Power LED 4W - 2x150 lm - 3000K/CRI 82

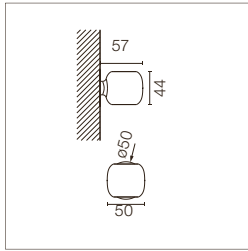

Apparecchio di illuminazione per installazione a parete a luce doppia emissione con driver integrato e con complemento fregio tondo (ø125).

Lighting device with dual emission bulb for wall mounting with remote driver and with round ornamental (ø125).

Vedi accessori disponibili. Per installazione in cartongesso è necessario utilizzare una cassa di dimensioni minime 110,2x68,8x53,7 mm.

See available accessories. For installation on plasterboard, a box of minimum size 110.2 x 68.8 x 53.7 mm must be used.

F9474057

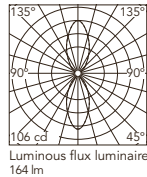

Beam Angle DIR: 49°

h(m)	E(lx)	D(m)
1	106	0.92
2	26	1.83
3	12	2.75
4	7	3.66
5	4	4.58

Minikelvin Wall Flex

Light Source: Top LED 4W - 216 lm - 3000K/CRI 85

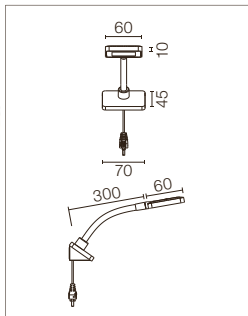

Apparecchio di illuminazione per installazione a parete a luce diffusa. Attacco a parete in alluminio pressofuso. L'alimentatore è sulla spina e la lunghezza utile di cavo è di 200 cm. ON/OFF con tecnologia Soft Touch e regolazione del flusso luminoso a 2 intensità (100% - 50% - 0%).

Diffuse illumination lighting device for wall mounting Wall attachment in die-cast aluminium. The adaptor is on the plug and the useful cable length is 200 cm. ON/OFF switch with Soft Touch technology and light flow adjustment to 2 intensities (100% - 50% - 0%).

F4185009
F4185057
F4185030

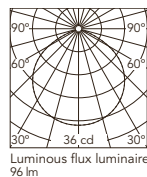

Beam Angle: 111°

h(m)	E(lx)	D(m)
1	36	2.89
2	9	5.77
3	4	8.66
4	2	11.55
5	1	14.44

WALL SYSTEM

Wall System Minikelvin Flex Remote Power Supply

Light Source: Top LED 4W - 216 lm - 3000K/CRI 85

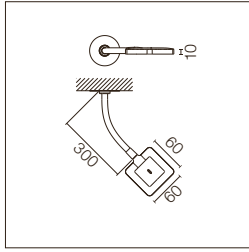

Apparecchio di illuminazione per installazione a filo parete a luce diffusa con driver remoto. ON/OFF con tecnologia Soft Touch e regolazione del flusso luminoso a 2 intensità (100% - 50% - 0%).

Diffuse illumination lighting device for installation flush with the wall with remote driver. ON/OFF switch with Soft Touch technology and light flow adjustment to 2 intensities (100% - 50% - 0%).

- F9478009
- ▒ F9478057
- F9478030

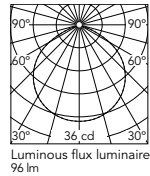

h(m)	E(lx)	D(m)
1	36	2.89
2	9	5.77
3	4	8.66
4	2	11.55
5	1	14.44

Wall System Minikelvin Flex Power Supply Integrated

Light Source: Top LED 4W - 216 lm - 3000K/CRI 85

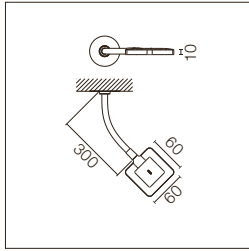

Apparecchio di illuminazione per installazione a parete a luce diffusa con driver integrato e con fregio tondo (ø125). ON/OFF con tecnologia Soft Touch e regolazione del flusso luminoso a 2 intensità (100% - 50% - 0%).

Diffuse illumination lighting device for installation flush with the wall with integrated driver and with round ornamental (ø125). ON/OFF switch with Soft Touch technology and light flow adjustment to 2 intensities (100% - 50% - 0%).

Vedi accessori disponibili. Per installazione in cartongesso è necessario utilizzare una cassa di dimensioni minime 110,2x68,8x53,7 mm.

See available accessories. For installation on plasterboard, a box of minimum size 110.2 x 68.8 x 53.7 mm must be used.

- F9463009
- ▒ F9463057
- F9463030

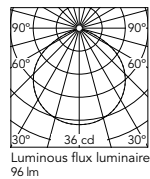

h(m)	E(lx)	D(m)
1	36	2.89
2	9	5.77
3	4	8.66
4	2	11.55
5	1	14.44

Accessori / Accessories

Scatola da incasso con 3 moduli per installazione in muratura di 119x80x50 mm.

3-Module flush mounted box for masonry, measuring 119x80x50 mm.



80.8067

Driver / Drivers

Trasformatore elettronico per LED a tensione costante (24V). 220/240V, 50/60Hz.

Electronic transformer with constant voltage (24V) for LED. 220/240V, 50/60Hz.

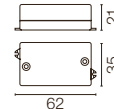

8W - Remote installation
RF23065

Trasformatore elettronico per LED a tensione costante (24V). 110/240V, 50/60Hz.

Electronic transformer with constant voltage (24V) for LED. 110/240V, 50/60Hz.

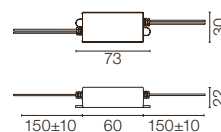

60.9157



LIGHT SOURCE
TOP LED
1,2W
105 lm
3000K/CRI 90

□ 30 Bianco
30 White

■ 29 Alluminio
Anodizzato
29 Anodized
Aluminium

■ 55 Acciaio
Inossidabile
55 Stainless
Steel

■ BZ Bronzo
BZ Bronze

■ AN Nero
Anodizzato
AN Anodized
Black



Colori Della Luce
Light Colours

□ Luce Bianca
White Light

■ Luce Ambra
Amber Light



Descrizione

Apparecchio di illuminazione predisposto per installazione ad incasso per interni in tutte le finiture, salvo la finitura in acciaio inossidabile che è anche adatto per esterni.

Disponibile con fonte di illuminazione LED di ultima generazione adatto per rispondere alle diverse esigenze di illuminazione delle aree di passaggio o delle scale. Il diffusore interno è disponibile in varie colori. Il corpo dell'apparecchio è realizzato in alluminio, acciaio inossidabile o bronzo lavorato.

Unità di Alimentazione

Fonte di alimentazione a tensione costante esclusa, disponibile come accessorio. È possibile installare fino a 6 o 15 G-O con le fonti di alimentazione raccomandate.

Accessori

E' previsto un accessorio da incasso per pareti in muratura realizzato in alluminio estruso.

Informazioni Aggiuntive

Grado di protezione IP65.
Classe di isolamento III.
Adatti ad installazioni su superfici normalmente infiammabili.

Conformità e Marchi di Qualità

Apparecchio conforme alla Normativa Tecnica Europea EN60598-1 e relative parti seconde.

Description

Embedded light fixture for indoor use in all its finishes, except stainless steel which is suitable for outdoor use. Available with next-generation LED light source, suitable for responding to diverse signalling needs on pathways or stairways. Available in different light shades, through coloured internal diffuser. Light body made of aluminium, stainless steel or machined bronze.

Power Supply

Constant voltage power supply not included, available as an accessory.

Up to 6 or 15 G-O can be installed with the recommended power sources.

Accessories

With extruded aluminium accessories for embedding in concrete walls.

Additional Information

IP65 protection grade.
Insulation class III.
Suitable for installation on normally inflammable surfaces.

Standard Compliance and Quality Marks

EN60598-1 European Technical Standards and any subsequent additions.



G-O

Light Source: Top LED 1,2W - 24V - 105 lm - 3000K/CRI 90

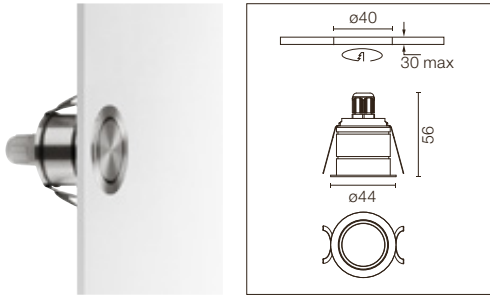

Apparecchio di segnalazione da semi-incasso per applicazione in interni per soffitto/parete. Fonte di alimentazione non inclusa. Include cavo di alimentazione di 1000 mm.

Semi recessed signalling lamp for indoor use on ceiling/wall. Power supply not included. 1000 mm power cable included.

Apparecchio per installazione remota in luogo accessibile: non passa attraverso il foro di incasso dell'apparecchio, eccetto il 60.9157.

Equipment for remote installation in an accesible place: it does not fit through the recessing hole of the luminaire, except 60.9157.

Alimentazioni raccomandate / Recommended power supply*:
 Non Dimmable 110-240V 60.9157 (8W)
 Non Dimmable 220-240V 60.8703 (25W)
 Dali Controler 60.8635

* Vedi capitolo Drivers / Refer to the Drivers chapter

Per installare Dali è necessaria l'apparecchiatura non dimmabile e il controller Dali.

For Dali installation, the non-dimmable kit and the Dali controller are needed.

Luce Bianca/White Light
 09.3200.30A
 09.3200.29A
 09.3200.55A
 09.3200.BZA
 09.3200.ANA

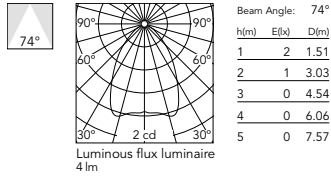

Luce Ambra/Amber Light
 09.3201.30A
 09.3201.29A
 09.3201.55A
 09.3201.BZA
 09.3201.ANA

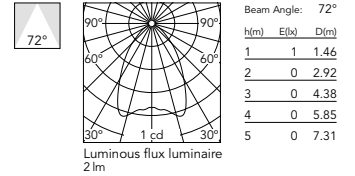

Accessori / Accessories

Cassaforma realizzata in alluminio anodizzato per installazione all'esterno.

Housing for recessed installation made in anodized aluminium for outdoor installation.



08.8422.00

THE BLOCK OF LIGHT

DESIGNED BY KNUD HOLSCHER



LIGHT SOURCE
POWER LED
2,2W
154 lm
3000K/CRI 80

□ 01 Bianco Opaco
01 Matt White

■ 72 Grigio
72 Grey

■ 04 Nero Opaco
04 Matt Black



Descrizione

Apparecchio di illuminazione predisposto per installazione ad incasso per interni o esterni (grado di protezione IP65). Disponibile con fonte di illuminazione LED di ultima generazione adatto per rispondere alle diverse esigenze di illuminazione delle aree di passaggio o di scale.

Corpo esterno realizzato in alluminio, verniciato nelle finiture bianco opaco, grigio o nero opaco.

Unità di Alimentazione

Fonte di alimentazione a corrente costante 100/240V, 50-60Hz non regolabile integrata. Alimentazione a 700 mA.

Accessori

E' previsto un accessorio da incasso per pareti in muratura realizzato in acciaio galvanizzato.

Informazioni Aggiuntive

Grado di protezione IP65.

Classe di isolamento I.

Adatti ad installazioni su superfici normalmente infiammabili.

Conformità e Marchi di Qualità

Apparecchio conforme alla Normativa Tecnica Europea EN60598-1 e relative parti seconde.

Description

Embedded light fixture designed for indoor or outdoor use (IP65 protection grade). Available with next-generation LED light source in response to diverse signalling needs on pathways or stairways.

Front made of aluminium with finish in matt white, grey or matt black.

Power Supply

Built-in, non-regulable constant current power supply of 100/240V, 50/60Hz. 700 mA current.

Accessories

Has galvanised steel accessories for embedding in concrete walls.

Additional Information

IP65 protection grade.

Insulation class I.

Suitable for installation on normally inflammable surfaces.

Standard Compliance and Quality Marks

EN60598-1 European Technical Standards and any subsequent additions.



THE BLOCK OF LIGHT

TheBlockofLight

Light Source: Power LED 2,2W - 154 lm - 3000K/CRI 80

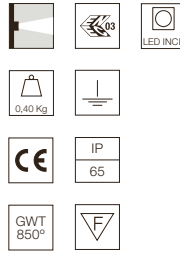
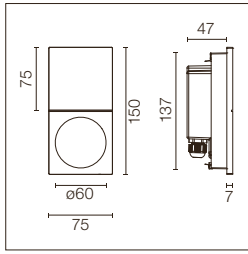

Apparecchio di segnalazione da semi-incasso per applicazione in interni o esterni. Fonte di alimentazione non regolabile 100-240V, 50-60Hz integrata. Include cavo di alimentazione 500 mm.

Semi-recessed signalling lamp for indoor or outdoor use. Non-regulable 100-240V, 50-60Hz power supply and 500 mm power cable included.

□ 09.3310.01C

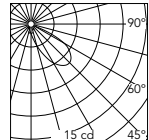

Beam Angle: 45°

h(m)	E(lx)	D(m)
1	15	1.79
2	4	3.58
3	2	5.37
4	1	7.16
5	1	8.95

Luminous flux luminaire 85 lm

■ 09.3310.72C

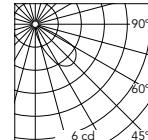

Beam Angle: 45°

h(m)	E(lx)	D(m)
1	6	1.85
2	2	3.70
3	1	5.55
4	0	7.40
5	0	9.25

Luminous flux luminaire 50 lm

■ 09.3310.04C

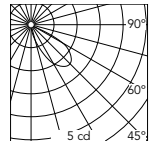

Beam Angle: 41°

h(m)	E(lx)	D(m)
1	5	1.64
2	1	3.28
3	1	4.92
4	0	6.55
5	0	8.19

Luminous flux luminaire 40 lm

Accessori / Accessories

Passacavo da incasso in cemento.

Can for embedding in concrete.



08.8423.00

GIANO

DESIGNED BY RODOLFO DORDONI

GIANO
Ø 100



LIGHT SOURCE
POWER LED
1W
77 lm
3000K/CRI 80

GIANO
Ø 220

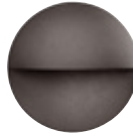

LIGHT SOURCE
POWER LED
6W
650 lm
3000K/CRI 80

01 Bianco Opaco
01 Matt White
RAL 9010

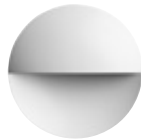

72 Grigio
72 Grey
RAL 9006

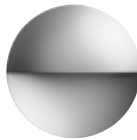

04 Nero Opaco
04 Matt Black
RAL 9011



18 Bruno
18 Dark Brown



Descrizione

Famiglia di apparecchi per illuminazione di segnalazione, per esterni ed interni, disponibile in due dimensioni di diametro 100 mm e 200 mm. Corpo principale in lega di alluminio pressofuso. Finitura in vernice antiossidante di alta resistenza alla corrosione. Diffusore in policarbonato opalino che consente una luce uniforme.

Unità di Alimentazione

Trasformatore elettronico a corrente costante non regolabile 100/240V - 50/60Hz.

Accessori

Cassaforma in plastica per installazioni su pareti in cemento armato.

Informazioni Aggiuntive

Grado di protezione IP65.
Classe di isolamento I.
Adatti ad installazioni su superfici normalmente infiammabili.

Conformità e Marchi di Qualità

Apparecchio conforme alla Normativa Tecnica Europea EN60598-1 e relative parti seconde.

Description

Family of luminaires for both interior and exterior signaling available in two sizes 100 mm and 220 mm. Main body injected in alloy aluminium under pressure. Anti-rust paint finish made in high resistance to corrosion. It has an opal polycarbonate diffuser to obtain a uniform light.

Power Supply

Constant current non-adjustable electronic transformer 100/240V - 50/60Hz.

Accessories

Thermoplastic housing for concrete wall installation.

Additional Information

IP65 protection grade.
Insulation class I.
Suitable for installation on normally inflammable surfaces.

Standard Compliance and Quality Marks

EN60598-1 European Technical Standards and any subsequent additions.

Giano Ø100

Light Source: Power LED 1W - 77 lm - 3000K/CRI 80

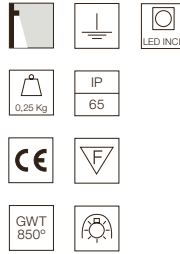
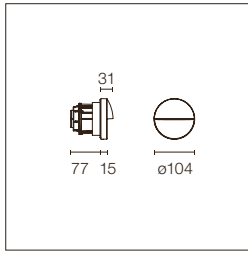

Apparecchio di segnalazione da incasso per applicazione in interni o esterni. Fonte di alimentazione non regolabile 100-240V, 50-60Hz integrata.

Recessed signalling lamp for indoor or outdoor use. Non-regulable 100-240V, 50-60Hz power supply included.

- 09.3000.01C
- 09.3000.72C
- 09.3000.04C
- 09.3000.18C

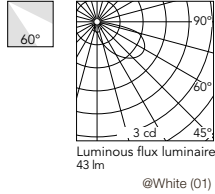

Beam Angle: 60°

h(m)	E(lx)	D(m)
1	3	6.28
2	1	12.56
3	0	18.84
4	0	25.12
5	0	31.40

Giano Ø220

Light Source: Power LED 6W - 650 lm - 3000K/CRI 80

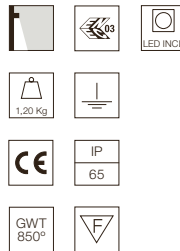
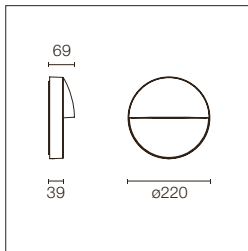

Apparecchio di segnalazione a superficie per applicazione in interni o esterni. Fonte di alimentazione non regolabile 100-240V, 50-60Hz integrata.

Surface signalling lamp for indoor or outdoor use. Non-regulable 100-240V, 50-60Hz power supply included.

- 09.3001.01B
- 09.3001.72B
- 09.3001.04B
- 09.3001.18B

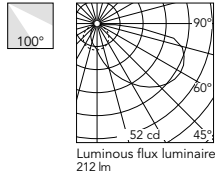

Beam Angle: 100°

h(m)	E(lx)	D(m)
1	52	10.35
2	13	20.70
3	6	31.04
4	3	41.39
5	2	51.74

Accessori / Accessories

Accessorio per l'installazione a calcestruzzo per Giano Ø100.

Accessory for concrete instalation for Giano Ø100.

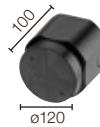

08.8261.00

BOX

DESIGNED BY PIERO LISSONI

BOX



LIGHT SOURCE
POWER LED
5W
500 lm
3000K/CRI 80

LIGHT SOURCE
TC-DEL
G24Q
18/26W

MINI BOX

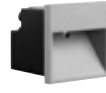

LIGHT SOURCE
POWER LED
2W
110 lm
3000K/CRI 80

LIGHT SOURCE
LED
QT-14
G9

LIGHT SOURCE
LED
QT-9
G4

□ 01 Bianco Opaco
01 Matt White
RAL 9010

■ 72 Grigio
72 Grey
RAL 9006

■ 04 Nero Opaco
04 Matt Black
RAL 9011

■ 18 Bruno
18 Dark Brown



Descrizione

Famiglia di apparecchi di segnalazione per esterni ed interni disponibile in due dimensioni: 100x100 mm e 236x256 mm. Cornice anteriore in pressofusione di alluminio. Verniciatura antiossidante ad alta resistenza alla corrosione. Corpo posteriore stampato ad iniezione in tecnopolimero ad alta resistenza.

Diffusore in policarbonato per la protezione della sorgente luminosa. Guarnizioni in silicone. Viti realizzate in acciaio inossidabile. Pressacavo tipo PG7 o PG11.

Riflettori

Riflettori asimmetrici in alluminio anodizzato color argento con finitura lucida.

Unità di Alimentazione

- Le versioni LED dispongono di trasformatore elettronico di ultima generazione incluso.
- Unità di alimentazione convenzionale a dispersione molto bassa, inclusa nelle versioni di fluorescenza e QT-9.

Accessori

Accessorio per installazione ad incasso o a filo della parete per il Box e Mini Box.

Accessorio realizzato in ferro verniciato a polvere con sistema frontale reversibile in plastica. A seconda della posizione del sistema frontale, il Box/Mini Box potrà essere installato a filo della parete o in superficie.

Informazioni Aggiuntive

Grado di protezione IP65.

Classe di isolamento I, II, a seconda delle versioni.

Adatti ad installazioni su superfici normalmente infiammabili.

Conformità e Marchi di Qualità

Apparecchio conforme alla Normativa Tecnica Europea EN60598-1 e relative parti seconde.

Description

Range of indoor and outdoor guidelights in two sizes: 100x100 mm and 236x256 mm. Die-cast aluminum front ring. High corrosion-resistance anti-oxidizing paint. High-resistance injection-moulded engineering plastic. Polycarbonate diffuser for lamp protection. Silicone seals. Stainless steel screws. PG7 or PG11 cable glands.

Reflectors

Anodized aluminum asymmetrical reflectors painted silver with glossy finish.

Power Supply

- The LED versions incorporate an electronic transformer of last generation.
- Conventional feeding low loss unit included in fluorescence versions of and QT-9.

Accessories

Installation accessory embedded or leveled to wall for the Box and the Mini Box.

Accessory made of iron powder-coated painted with plastic reversible front. The Box/Mini Box will be leveled to wall or on surface depending on the position of the front accessory.

Additional Information

IP65 protection grade.

Insulation class I, II depending on the versions.

Suitable for installation on normally inflammable surfaces.

Standard Compliance and Quality Marks

EN60598-1 European Technical Standards and any subsequent additions.



BOX

Box

Light Source: Power LED 5W - 500 lm - 3000K/CRI 80

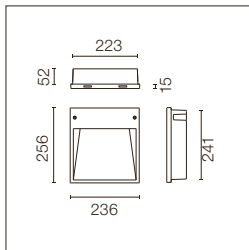

Apparecchio di segnalazione da semi-incasso per applicazione in interni o esterni. Fonte di alimentazione 220-240V, 50-60Hz inclusa.

Semi-recessed signalling lamp for indoor or outdoor use. 220-240V, 50-60Hz non-regulable power supply included.

- 07.9007.01B
- 07.9007.72B
- 07.9007.04B
- 07.9007.18B

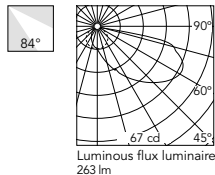

Beam Angle: 84°

h(m)	E(lx)	D(m)
1	67	5.27
2	17	10.54
3	7	15.81
4	4	21.07
5	3	26.34

Box

Light Source: TC-DEL G24Q - 18/26W

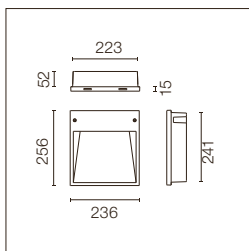

Apparecchio di segnalazione da incasso per applicazione in interni o esterni. Alimentatore elettronico integrato.

Recessed signalling lamp for indoor or outdoor use. Electronic control gear integrated.

- 18W**
- 07.9000.01.E3
 - 07.9000.72.E3
 - 07.9000.04.E3
 - 07.9000.18.E3

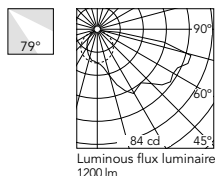

Beam Angle: 79°

h(m)	E(lx)	D(m)
1	84	6.73
2	21	13.47
3	9	20.20
4	5	26.93
5	3	33.66

- 26W**
- 07.9001.01.E3
 - 07.9001.72.E3
 - 07.9001.04.E3
 - 07.9001.18.E3

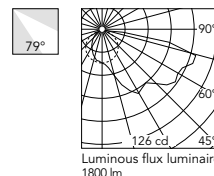

Beam Angle: 79°

h(m)	E(lx)	D(m)
1	126	6.7
2	31	13.4
3	14	20.2
4	8	26.9
5	5	33.6

Mini Box

Light Source: Power LED 2W - 110 lm - 3000K/CRI 80

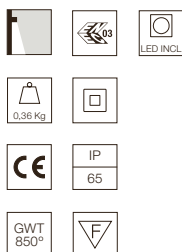
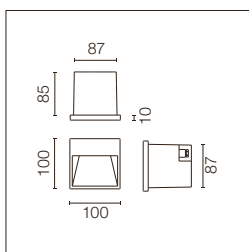

Apparecchio di segnalazione da semi-incasso per applicazione in interni o esterni. Fonte di alimentazione 100-240V, 50-60Hz inclusa.

Semi-recessed signalling lamp for indoor or outdoor use. 100-240V, 50-60Hz non-regulable power supply included.

- 07.9006.01C
- 07.9006.72C
- 07.9006.04C
- 07.9006.18C

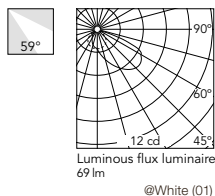

Beam Angle: 59°

h(m)	E(lx)	D(m)
1	12	2.67
2	3	5.35
3	1	8.02
4	1	10.69
5	0	13.36

BOX

Mini Box

Light Source: LED QT-14 G9

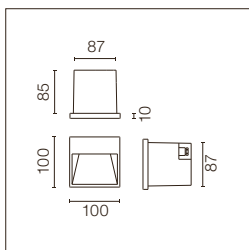

Apparecchio di segnalazione da incasso per applicazione in interni o esterni. Sorgente luminosa a tensione di rete.

Recessed signalling lamp for indoor or outdoor use. Main voltage light source.

- 07.9005.01
- 07.9005.72
- 07.9005.04
- 07.9005.18

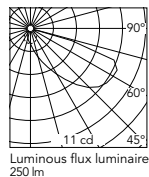

Beam Angle: 72°

h(m)	E(lx)	D(m)
1	11	3.05
2	3	6.11
3	1	9.16
4	1	12.22
5	0	15.27

Mini Box

Light Source: LED QT-9 G4

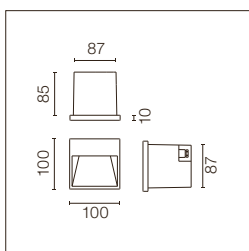

Apparecchio di segnalazione da incasso per applicazione in interni o esterni. Trasformatore convenzionale integrato.

Recessed signalling lamp for indoor or outdoor use. Conventional transformer integrated.

- 07.9004.01
- 07.9004.72
- 07.9004.04
- 07.9004.18

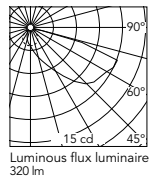

Beam Angle: 65°

h(m)	E(lx)	D(m)
1	15	3.31
2	4	6.63
3	2	9.94
4	1	13.26
5	1	16.57

Accessori / Accessories

Dima in poliestere per l'installazione ad incasso su muri e pareti di cemento.

High density polystyrene matched die for installation on cement.

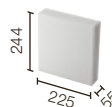

80.1318

Dima in poliestere per l'installazione ad incasso su muri e pareti di cemento.

High density polystyrene matched die for installation on cement.



80.1332

Scatola di derivazione stagna IP67 da utilizzarsi per le connessioni elettriche.

IP67 junction box: to be used for the power connection.



08.8012.00

Accessorio per livellare la parete nella installazione del Box.

Accessory for flush wall installation for Box.



08.8256.00

Accessorio per livellare la parete nella installazione del Mini Box.

Accessory for flush wall installation for Mini Box.



08.8246.00

BINARI TRIFASE / THREE PHASE TRACKS

Binario Trifase

GLOBAL TRACK offre molteplici vantaggi alle installazioni più avanzate: i principali adattatori sono alimentabili e il cavo di alimentazione può essere nascosto sotto degli eleganti accessori in sospensione. I binari GLOBAL TRACK sono stati progettati per essere facilmente montati sulle pareti o sui soffitti, o appesi ai soffitti. I binari possono essere appesi all'altezza desiderata.

Altri vantaggi del sistema trifasico sono l'elevata capacità di potenza e la possibilità di formare dei gruppi indipendenti di installazione fissa nei tre circuiti. Ciò permette l'illuminazione degli ambienti più esigenti.

Three Phase Track

GLOBAL TRACK offers benefits for advanced installations: the main connectors are feedable and the feeding cable can be hidden under the elegant suspension accessories. GLOBAL TRACK lighting tracks are designed for easy surface mounting on ceilings and walls, or recessed mounting in suspended ceilings. Lighting tracks can be suspended at any desired height. Other advantages of the three-circuit system are its high loading capacity and the possibility of forming independent fixture groups in all three circuits. This permits illumination of the most demanding environments.

Surface

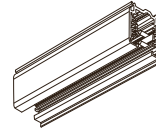
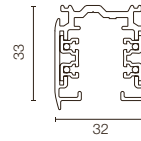

Surface Dali

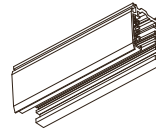
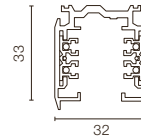
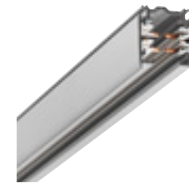

1000 mm
60.3101.11
60.3101.29
60.3101.14
Dali Version
60.3101.11ADA
60.3101.29ADA
60.3101.14ADA

2000 mm
60.3102.11
60.3102.29
60.3102.14
Dali Version
60.3102.11ADA
60.3102.29ADA
60.3102.14ADA

3000 mm
60.3103.11
60.3103.29
60.3103.14
Dali Version
60.3103.11ADA
60.3103.29ADA
60.3103.14ADA

4000 mm
60.3104.11
60.3104.29
60.3104.14
Dali Version
60.3104.11ADA
60.3104.29ADA
60.3104.14ADA

Recessed

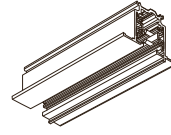
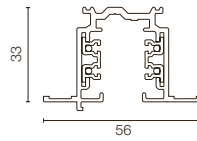
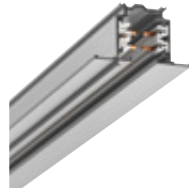

Recessed Dali

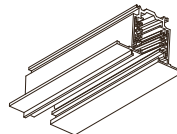
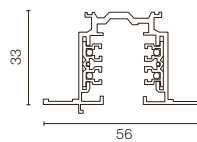
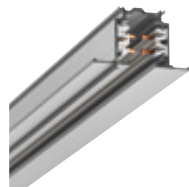

1000 mm
60.3810.11
60.3810.29
60.3810.14
Dali Version
60.3810.11ADA
60.3810.29ADA
60.3810.14ADA

2000 mm
60.3820.11
60.3820.29
60.3820.14
Dali Version
60.3820.11ADA
60.3820.29ADA
60.3820.14ADA

3000 mm
60.3830.11
60.3830.29
60.3830.14
Dali Version
60.3830.11ADA
60.3830.29ADA
60.3830.14ADA

4000 mm
60.3840.11
60.3840.29
60.3840.14
Dali Version
60.3840.11ADA
60.3840.29ADA
60.3840.14ADA

BINARI TRIFASE / THREE PHASE TRACKS

Aste rigide per evitare l'inclinazione del profilo (strutture rettilinee senza angoli) o per installazioni in cui è necessario un sistema di fissaggio più rigido.
Rigid rod to avoid the profile from tilting (rectilinear structures without corners) or to be installed in places where a more rigid fixing system is required.

Tige di sospensione con rosone
1000 mm filetto m6.  60.3014.11
 60.3014.14

Suspension rod with 1000 mm rose.
M6 thread.

Set prolunga tige sospensione 1000
mm filetto m6.  60.3097.11
 60.3097.14

1000 mm suspension rod extension
set m6 thread.

Kit di sospensione flessibile.  60.3008.11
 60.3008.14

Flexible suspension kit.

Attacco a soffitto con rosone.  60.3094.11
 60.3094.14

Ceiling fitting with rose.

Punto di aggancio su binario per
sospensione con tige filetto m6.  60.3018.11
 60.3018.14

Attachment on track for rod
suspension m6 thread.

Si consiglia l'uso di cavo in acciaio se la struttura in quanto a dimensioni è in equilibrio, stabile e presenta uno o più angoli, dato che in queste strutture la guida non si inclina anche se il peso delle lampade non viene equilibrato.
A steel cable is recommended if the structure, because of its dimensions, is stable and includes one or more angles, since in these structures the track does not tilt even if the weight of the luminaries is not balanced.

Cavetto di sospensione con
piombino senza rosone e attacco
a soffitto.  1500 mm
60.3095.29
 3000 mm
 60.3096.29

Lead-weighted wire without rose
and ceiling fitting.

Staffa per fissaggio binario a soffitto/
parete o sospensione con cavetto
piombino.  60.3025.11
 60.3025.14
 60.3025.29

Bracket for track fixing wall/ceiling or
suspension with lead-weighted wire.

Staffa per fissaggio binario a soffitto
o parete.  60.3093.29

Bracket for fixing track to wall or
ceiling.

Punto di aggancio su binario per
sospensione con cavetto.  60.3057.11
 60.3057.29

Attachment on track for wire
suspension.

Supporto parete completo
braccio 70mm.  60.3083.29

Complete wall support 70mm.

Striscia di copertura binario
L 3000mm.  60.3090.11

Track cover strip L 3000mm.

Rosone copertura
alimentazione.  60.3092.11

Power supply rose cover.

Copertura per connettori
alimentazione binario ad
incasso.  60.3053.11
 60.3053.14
Dali Version

Cover for power supply
connectors recessed track. 60.3145.11
 60.3145.14

Copertura per connettori.
Cover for connectors.  60.3091.11
 60.3091.14
Dali Version

60.3146.11
 60.3146.14

* Connettore con conduttore di
terra a destra.  60.3038.11
 60.3038.14
 60.3038.12
Dali Version

Live end right.

60.3038.11ADA
 60.3038.14ADA
 60.3038.12ADA

* Connettore con conduttore di
terra a sinistra.  60.3039.11
 60.3039.14
 60.3039.12
Dali Version

Live end left.

60.3039.11ADA
 60.3039.14ADA
 60.3039.12ADA

BINARI TRIFASE / THREE PHASE TRACKS

Connettore a scomparsa.



- 60.3044.11
- 60.3044.14
- 60.3044.12
- Dali Version
- 60.3044.11ADA
- 60.3044.14ADA
- 60.3044.12ADA

Straight connector.

* Connettore a croce.



- 60.3036.11
- 60.3036.14
- 60.3036.29
- Dali Version
- 60.3036.11ADA
- 60.3036.14ADA
- 60.3036.29ADA

Cross coupling.

* Connettore alimentazione centrale.



- 60.3043.11
- 60.3043.14
- 60.3043.29
- Dali Version
- 60.3043.11ADA
- 60.3043.14ADA
- 60.3043.29ADA

Mean connector.

Terminale di chiusura.



- 60.3016.11
- 60.3016.14
- 60.3016.12

Blind end.

* Connettore a 90°.



- Interni/Inside
- 60.3029.11
- 60.3029.14
- 60.3029.29
- Dali Version
- 60.3029.11ADA
- 60.3029.14ADA
- 60.3029.29ADA

Connector 90°.

Connettore flessibile DALI.



- 60.3037.11
- 60.3037.14
- 60.3037.29
- Dali Version
- 60.3037.11ADA
- 60.3037.14ADA
- 60.3037.29ADA

DALI flexible couple.

- Externi/Outside
- 60.3028.11
- 60.3028.14
- 60.3028.29
- Dali Version
- 60.3028.11ADA
- 60.3028.14ADA
- 60.3028.29ADA

Connettore angolare regolabile.



- 60.3046.11
- 60.3046.14
- 60.3046.29

Corner adjustable connector.

Scatola da incasso per punto di fissaggio.



- 60.3022.11
- 60.3022.14

Recessed box for fix-point.

* Connettore T - interno.



- Destra/Right
- 60.3047.11
- 60.3047.14
- 60.3047.29
- Dali Version
- 60.3047.11ADA
- 60.3047.14ADA
- 60.3047.29ADA

Connector T - inside.

Punto di fissaggio.



- 60.3023.11
- 60.3023.14
- 60.3023.29

Fix-point.

- Sinistra/Left
- 60.3048.11
- 60.3048.14
- 60.3048.29
- Dali Version
- 60.3048.11ADA
- 60.3048.14ADA
- 60.3048.29ADA

Chiave di piegatura conduttori.



60.3054

Lead bending key.

* Connettore T - esterno.



- Destra/Right
- 60.3049.11
- 60.3049.14
- 60.3049.29
- Sinistra/Left
- 60.3051.11
- 60.3051.14
- 60.3051.29

Conector T - outside.

* Possibilità di alimentazione / Feeding possible.

BINARI TRIFASE / THREE PHASE TRACKS

Istruzioni di Installazione dei Binari Trifase / Installation Instructions for the Three-Phase Tracks (3P+N+PE) Un 400V, In 16A, 50Hz, Classe I, IP 20

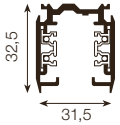

La posizione del conduttore neutro viene indicata con la linea larga.
The position of the neutral lead is shown by the thick line.

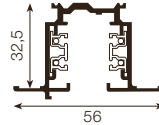

La posizione del conduttore neutro viene indicata con la linea larga.
The position of the neutral lead is shown by the thick line.

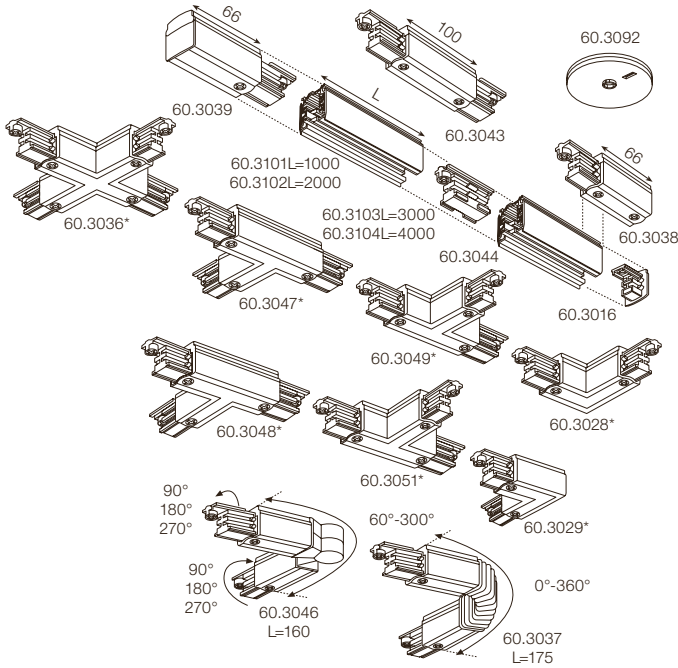

*Può essere usato come punto di alimentazione / Can be used as a power supply point

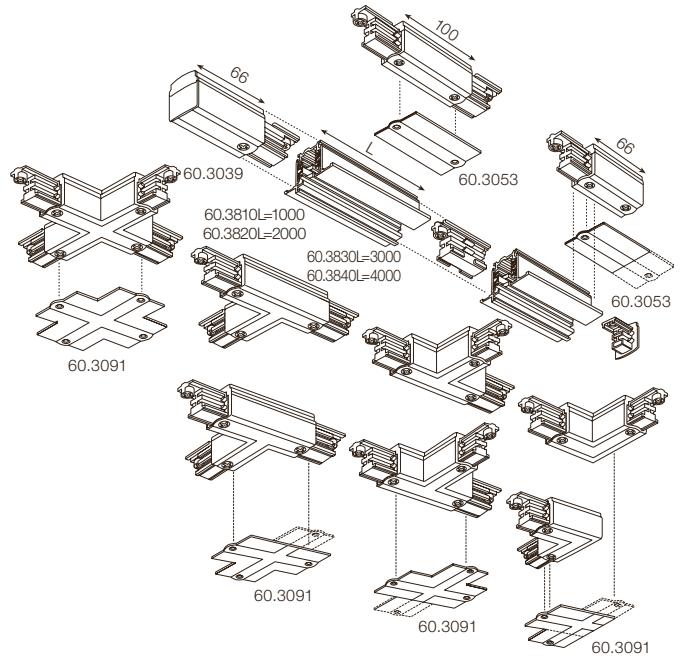

Montaggio in scanalatura sul soffitto Mounting in a groove in the ceiling

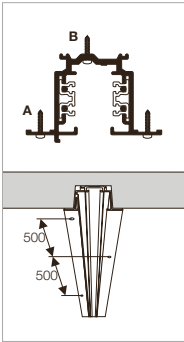

- le guide possono essere fissate nei bordi (A) o alla fine della guida (B).
- modo A: con viti Ø 3,0 - 4,5, a una distanza di 500mm.
- modo B: con viti a testa piatta Ø 3,0, che sostiene una distanza di 1000mm e un carico massimo di 20 kg/m.

- tracks can be fixed through the flanges (A) or through the track bottom (B).
- manner A: with screws Ø 3,0 - 4,5, at distance of 500mm.
- manner B: with flat head screws Ø 3,0, supporting distance 1000mm-max. load 20 kg/m.

Montaggio in sospensione a soffitto Mounting in suspended ceilings

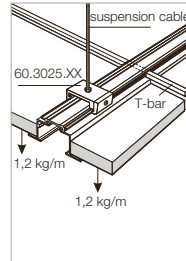

- con morsetti 60.3025.XX.
- la struttura di attacco del soffitto deve essere facile da smontare, gli attacchi e le guide non vanno fissati tra loro.
- sospensione a distanza massima di 1000mm.
- carico massimo sull'attacco di 1,2 kg/m per bordo di guida.
- sospensione guida con carico massimo 10 kg / distanza di sospensione.

- with clamps 60.3025.XX.
- the ceiling plate structure must be easy to demount, the plates and the tracks are not fixed onto each others.
- hanging at max. 1000mm distance.
- plate load max. 1,2 kg/m per track flange.
- track hanging load max. 10 kg / hanging distance.

Taglio dei Binari / Cutting Track

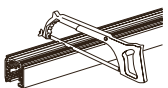

1 . Taglio del binario
1 . Cutting the track

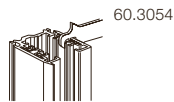

2 . Posizionamento chiave di piegatura nel binario
2 . Positioning bending key in the track

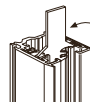

3 . Curvatura dei conduttori
3 . Lead bending



4 . Conduttori piegati
4 . Bent leads

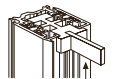

5 . Controllo dei conduttori piegati
5 . Bent leads control

BINARI TRIFASE / THREE PHASE TRACKS

Installazione dei Connettori / Connector Installation

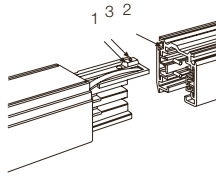

1 . Linguetta guida
1 . Guide flap

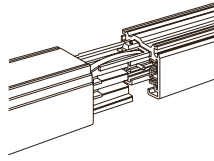

2 . Canale
2 . Canal

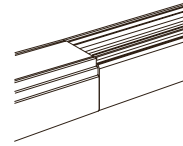

3 . Fissaggio a pressione
3 . Pressure fixing

Fissaggio del Binario e Capacita' di Carico del Fissaggio / Fixing the Track and Load Capacity

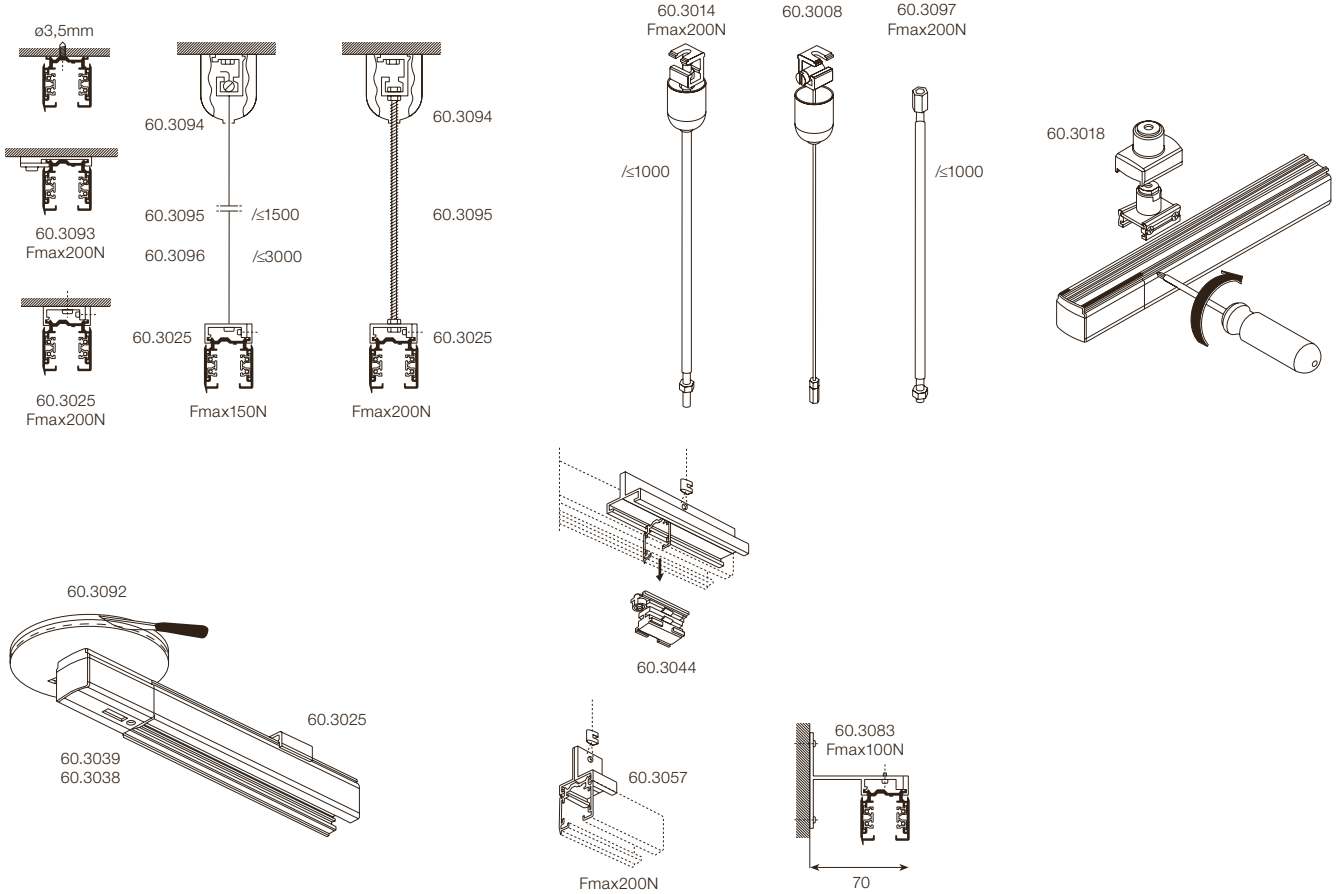

Distanza di Ancoraggio e Portata

La distanza di ancoraggio raccomandata è L=1000mm.
I binari sono dotati di fori di ancoraggio.

Fastening Distance and Loading Capacity

Recommended fastening distance L=1000mm.
The tracks have fastening holes.

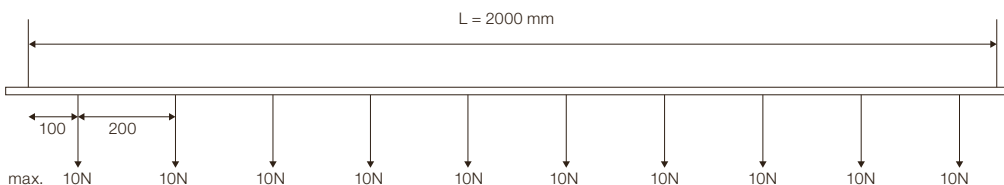
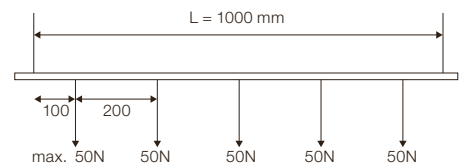
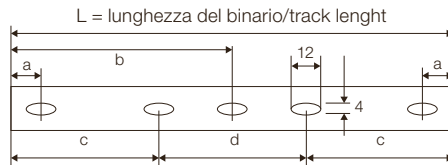

L mm	a mm	b mm	c mm	d mm
1000	250	1000		
2000	250			
3000	250		1000	1000
4000	250		1500	1000

BINARI TRIFASE / THREE PHASE TRACKS

Note di Progettazione

Quando si installa la guida, si deve scegliere la parte in cui si vuole avere la presa di terra. Dipendendo dalla posizione di tale presa, bisognerà utilizzare i relativi accessori. Nelle seguenti figure la linea tracciata ci indica la posizione della presa di terra.

Se abbiamo solo una guida, si può scegliere da quale parte installare l'alimentazione.

Figura 1. Lunghezza della guida, 1 metro, con connettore di alimentazione (A) e il suo connettore specchio (B).

La figura 2 ci mostra due diverse applicazioni. La presa di terra può essere sia interna che esterna.

Si può utilizzare rispettivamente (C) & (D) o (E) & (F).

Se la presa di terra è esterna - primo caso - si utilizzeranno i connettori a T (C) con il loro specchio (D).

I connettori a L saranno gli stessi per ogni angolo, (H).

Se invece la presa di terra è interna - secondo caso - si utilizzeranno i connettori a T (E) con lo specchio (F). Il connettore a L per questo caso sarà (I).

Planning Information

When you instal the track, you have to choose on which side you wish to have the ridge. The ridge will tell you which accesories to use with. Have a look at the following figures where the dotted line indicates the ridge on the track.

If you have only one track, you can choose on which side you connect it and use the corresponding parts.

Figure 1. Track of length 1 mt. with end feed (A) and its mirror image (B).

Figure 2. Shows two different cases. You will notice that the ridge can be either inside or outside the installation system. You can use respectively either (C) & (D) or (E) & (F).

If the ridge is outside, first case, you have to use the T connector (C) with its miror image (D). The L connectors are then the same for each corner, (H). Inversely, if you have the ridge inside, second case, you will have to use the T connector (E) with its miror image (F). The corresponding L connector is in this case (I).

1.



2.

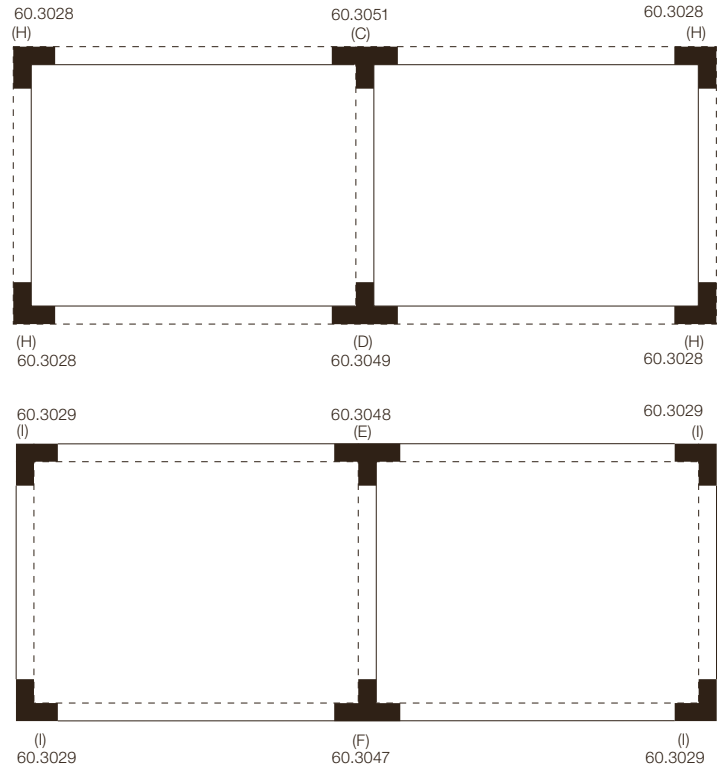

Esempio / Example

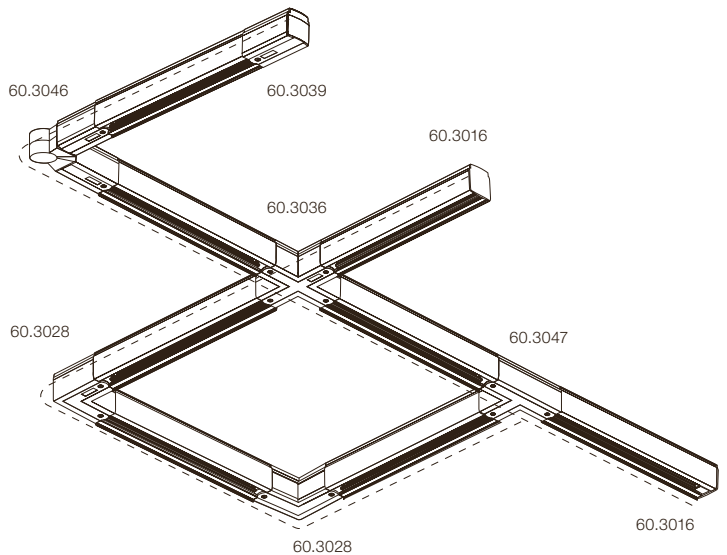

DRIVER / DRIVERS

Fonte di Alimentazione a Corrente Costante per LED / Constant Current Power Supply for LED

Fonte di alimentazione a corrente costante. 350mA - 17,5W / 500mA - 20W / 700mA - 20W - 220/240V - 50/60Hz non regolabile.

Non dimmable continuous current power supply. 350mA - 17,5W / 500mA - 20W / 700mA - 20W - 220/240V - 50/60Hz.

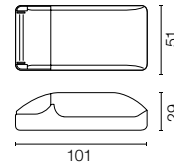

RF27535

Fonte di alimentazione a corrente costante non regolabile. 110/240V.

Non dimmable continuous current power supply. 110/240V.

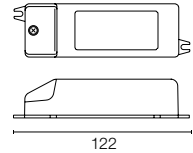

17W / 700 mA
*60.8655
20W / 500 mA
*60.8650
22W / 1050 mA
*RF26569

*110V - 12W

Fonte di alimentazione a corrente costante 15-30W, 220/240V -50/60Hz con corrente di alimentazione selezionabile tramite switch 350mA - 15W / 400mA - 17W / 450mA - 19W / 500mA - 22W / 550mA - 24W / 600mA - 26W / 650mA - 28W / 700mA - 30W non regolabile.

Non dimmable continuous current power supply. 15-30W, 220/240V -50/60Hz with power current selected through adjustable switch. 350mA - 15W / 400mA - 17W / 450mA - 19W / 500mA - 22W / 550mA - 24W / 600mA - 26W / 650mA - 28W / 700mA - 30W.

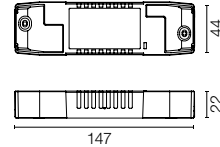

60.9592

Fonte di alimentazione a corrente costante 25W, 110/240V - 50/60Hz con corrente di alimentazione selezionabile tramite switch 350mA - 12W / 500mA - 15W / 700 mA - 25W non regolabile.

Non dimmable continuous current power supply of 25W, 110/240V - 50/60Hz with power current selected through adjustable 350mA - 12W / 500mA - 15W / 700 mA - 25W switch.

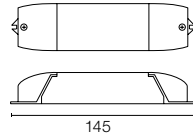

60.8437

110V - max 18W

Fonte di alimentazione a corrente costante 110/240V 32W, con corrente di alimentazione selezionabile tramite switch 350 mA-17W /500 mA-24W /700 mA-32W /900 mA - 32W non regolabile.

Non dimmable continuous current power supply of 110/240V 32W, with power current selected through adjustable 350 mA-17W /500 mA-24W /700 mA-32W /900 mA - 32W switch.

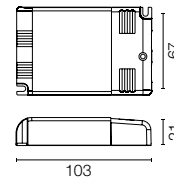

60.9233

110V - max 15W

Fonte di alimentazione a corrente costante 15-20W, 110/240V - 50/60Hz, con corrente di alimentazione selezionabile tramite switch 350 mA-15W /500 mA/ /550 / 700 / 850 mA / 900 mA - 20W non regolabile.

Non dimmable continuous current power supply of 15-20W, 110/240V - 50/60Hz, with power current selected through adjustable 350 mA-15W /500 mA/ /550 / 700 / 850 mA / 900 mA - 20W switch.

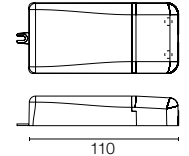

60.8911

110V - max 15W

Fonte di alimentazione a corrente costante 25W, 110/240V - 50/60Hz con corrente di alimentazione selezionabile tramite switch 350 mA-18W / 400 mA - 21W / 500mA - 25W /600mA - 30W /700/750/900 mA - 32W regolabile. 1-10V o push dimming, richiede cavi di sincronizzazione non inclusi.

Continuous current power supply of 25W, 110/240V - 50/60Hz with power current selected through adjustable 350 mA-18W / 400 mA - 21W / 500mA - 25W /600mA - 30W /700/750/900 mA - 32W switch. 1-10V or push dimming, synchronisation cables not included.

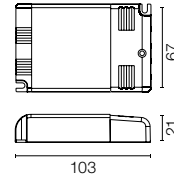

RF21466

110V - max 15W

Fonte di alimentazione a corrente costante max 20W, 110/240V - 50/60Hz con corrente di alimentazione selezionabile tramite switch 350 mA - 15W /500/550/700/850/900 mA - 20W regolabile. 0/1-10V o push dimming, richiede cavi di sincronizzazione non inclusi.

Continuous current power supply of max 20W, 110/240V - 50/60Hz with power current selected through adjustable 350 mA - 15W /500/550/700/850/900 mA - 20W switch. 0/1-10V or push dimming, synchronisation cables not included.

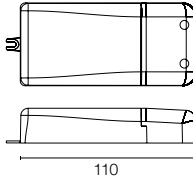

60.8668

110V - max 15W

Fonte di alimentazione a corrente costante 25-50W, 110/240V - 50/60Hz con corrente di alimentazione selezionabile tramite switch 350mA - 25W /500mA - 35W/ 700mA - 50W /750mA - 54W /900/ 1050 mA - 60W regolabile. Dali 2, 0/1-10V o push dimming, richiede cavi di sincronizzazione non inclusi.

Continuous current power supply of 25-50W, 110/240V - 50/60Hz with power current selected through adjustable 350mA - 25W /500mA - 35W/ 700mA - 50W /750mA - 54W /900/ 1050 mA - 60W switch. Dali 2, 0/1-10V or push dimming, synchronisation cables not included.

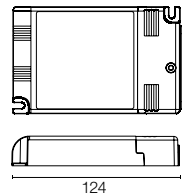

RF21468

110V - max 40W

DRIVER / DRIVERS

Fonte di Alimentazione a Corrente Costante per LED / Constant Current Power Supply for LED

Fonte di alimentazione a corrente costante 13-20W, 110/240V - 50/60Hz con corrente di alimentazione selezionabile tramite switch 300 mA - 15W / 350 mA - 18W / 400/450/500/550/600/650/700/750/800/850/900 mA - 15W. regolabile. 0/1-10V o push dimming, richiede cavi di sincronizzazione non inclusi.

Continuous current power supply of 13-20W, 110/240V - 50/60Hz with power current selected through adjustable 300 mA - 15W / 350 mA - 18W / 400/450/500/550/600/650 /700/750/800/850/900 mA - 15W. switch. 0/1-10V or push dimming, synchronisation cables not included.

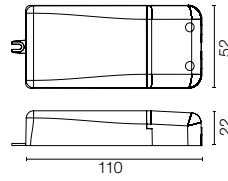

RF27961

110V - max 15W

Fonte di alimentazione a corrente costante 30-50W, 110/240V - 50/60Hz con corrente di alimentazione selezionabile tramite switch 300mA - 34W /350 mA -39W /400 mA - 45W /450 - mA - 50W /500 mA - 56W /550/600/650/700mA - 60W regolabile. Dali 1, Dali 2, 0/1-10V o push dimming, richiede cavi di sincronizzazione non inclusi.

Continuous current power supply of 30-50W, 110/240V - 50/60Hz with power current selected through adjustable 300mA - 34W /350 mA -39W /400 mA - 45W /450 - mA - 50W /500 mA - 56W /550/600/650/700mA - 60W switch. Dali1, Dali 2, 0/1-10V or push dimming, synchronisation cables not included.

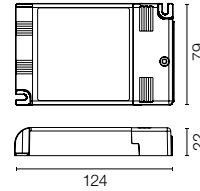

60.8837

110V - max 40W

Fonte di alimentazione a corrente costante 12-20W, 110/240V - 50/60Hz con corrente di alimentazione selezionabile tramite switch 350mA - 17W / 400mA - 19W / 450 /500 / 550 / 600 / 700mA - 20W regolabile Dali 1 e Dali 2.

Continuous current power supply of 12-20W, 110/240V - 50/60Hz with power current selected through adjustable 350mA - 17W / 400mA - 19W / 450 / 500 / 550 / 600 / 700mA - 20W dimmable Dali 1 and Dali 2.

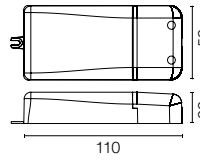

60.9222

110V - max 15W

Fonte di alimentazione a corrente costante 10-20W, 110/240V - 50/60Hz con corrente di alimentazione selezionabile tramite switch 250 mA - 10W / 350 mA - 15W /400 mA - 17W /450 mA - 19W /500/550/600/700 mA - 20W regolabile Dali 1.

Continuous current power supply of 10-20W, 110/240V - 50/60Hz with power current selected through adjustable 250 mA - 10W / 350 mA - 15W /400 mA - 17W /450 mA - 19W /500/550/600/700 mA - 20W, Dali 1 switch.

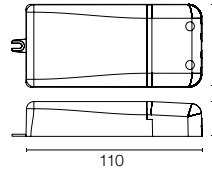

RF26571

110V - max 15W

Fonte di alimentazione a corrente costante 10-20W, 110/240V - 50/60Hz con corrente di alimentazione selezionabile tramite switch 250 mA - 10W / 350 mA - 15W /400 mA - 17W /450 mA - 19W /500/550/600/700 mA - 20W regolabile Dali 1.

Continuous current power supply of 13-20W, 110/240V - 50/60Hz with power current selected through adjustable 250 mA - 13W / 350 mA - 18W /400/450/500/550/600/700/800/900 mA - 20W, 1-10V or push dimming.

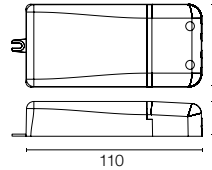

60.9208

110V - max 15W

Fonte di alimentazione a corrente costante 20-40W, 110/240V - 50/60Hz con corrente di alimentazione selezionabile tramite switch 350 mA -18,5W / 400 mA - 21W / 500 mA - 26,5W / 600 mA - 31,5W /650 mA -34,5W /700 mA -37W /750 mA - 39,5W /800/850/900/950/1000/1050/1200 mA - 40W regolabile. Dali 1, 0/1-10V o push dimming, richiede cavi di sincronizzazione non inclusi.

Continuous current power supply of 20-40W, 110/240V - 50/60Hz with power current selected through adjustable 350 mA -18,5W / 400 mA - 21W / 500 mA - 26,5W / 600 mA - 31,5W /650 mA -34,5W /700 mA -37W /750 mA - 39,5W /800/850/900/950/1000/1050/1200 mA - 40W switch. Dali 1, 0/1-10V or push dimming, synchronisation cables not included.

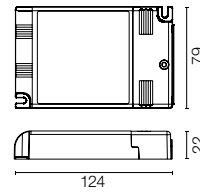

60.9276

Fonte di alimentazione a corrente costante 13-42W, 220/240V - 50/60Hz con corrente di alimentazione selezionabile tramite switch 300 mA - 13W / 350 mA - 15W / 400 mA - 18W / 450 mA - 20W / 500 mA - 22W / 550 mA - 24W / 600 mA - 27W / 650 mA - 29W / 700 mA - 31W / 750 mA - 32W / 800 mA - 33W / 850 mA - 35W / 900 mA -38W / 950 mA - 40W / 1000/1050 mA - 42W regolabile.

Continuous current power supply of 13-42W, 220/240V - 50/60Hz with power current selected through adjustable 300 mA - 13W / 350 mA - 15W / 400 mA - 18W / 450 mA - 20W / 500 mA - 22W / 550 mA - 24W / 600 mA - 27W / 650 mA - 29W / 700 mA - 31W / 750 mA - 32W / 800 mA - 33W / 850 mA - 35W / 900 mA -38W / 950 mA - 40W / 1000/1050 mA - 42W switch.

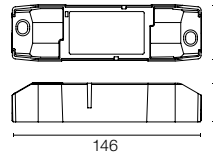

RF27370

Fonte di alimentazione a corrente costante 17/24/32W, 220/240V - 50/60Hz con corrente di alimentazione selezionabile tramite switch 350 mA -17W / 500 mA - 24W / 700 mA - 32W regolabile.

Continuous current power supply of 17/24/32W, 220/240V - 50/60Hz with power current selected through adjustable 350 mA -17W / 500 mA - 24W / 700 mA - 32W switch.

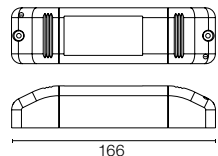

60.8656

DRIVER / DRIVERS

Fonte di Alimentazione a Corrente Costante per LED / Constant Current Power Supply for LED

Fonte di alimentazione a corrente costante 6W, 100V / 14W, 240V - 50/60Hz con corrente di alimentazione 500 mA.

Continuous current power supply of 6W, 100V / 14W, 240V - 50/60Hz with 500 mA supply voltage.



RF26570

Fonte di alimentazione a corrente costante 7,2-24W, 220/240V-50/60Hz con corrente di alimentazione selezionabile tramite switch 150 mA - 7,2W /200 mA - 9,5W /250 mA - 12W /300 mA -14,5W /350 mA -17W/400 mA - 19,5W /450 mA -21,5W /500 mA -24W regolabile. Mains o push dimming.

Continuous current power supply of 7,2-24W, 220/240V - 50/60Hz with power current selected through adjustable 150 mA - 7,2W /200 mA - 9,5W /250 mA - 12W /300 mA -14,5W /350 mA -17W/400 mA - 19,5W /450 mA -21,5W /500 mA - 24W switch. Mains or push dimming.

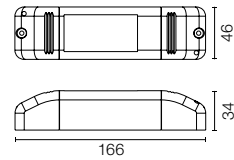

60.9421

Fonte di alimentazione a corrente costante 10W, 110V / 12W, 240V - 50/60Hz con corrente di alimentazione 700 mA.

Continuous current power supply of 10W, 110V / 12W, 240V - 50/60Hz with 700 mA supply voltage.

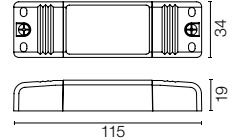

60.8529

Fonte di alimentazione a corrente costante 18W, 220/240V - 50/60Hz con corrente di alimentazione 450 mA mains dimming, trailing edge.

Continuous current power supply of 18W, 220/240V - 50/60Hz with 450 mA supply voltage mains dimming, trailing edge.

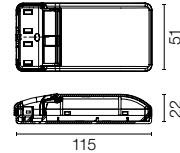

60.9268

Fonte di alimentazione a corrente costante 32W, 230/240V - 50/60Hz con corrente di alimentazione selezionabile tramite switch 350mA - 17W / 500mA - 24W / 700/ 750 mA - 32W regolabile tramite trailing and leading edge dimming, mains dimming o push dimming.

Continuous current power supply of 32W, 230/240V - 50/60Hz with power current selected through adjustable 350mA - 17W / 500mA - 24W / 700/ 750 mA - 32W switch by trailing and leading edge dimming, mains dimming or push dimming.

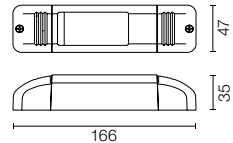

RF21469

Trasformatore elettronico per LED a tensione costante (24V). 8W, 220/240V, 50/60Hz.

Electronic transformer with constant voltage (24V) for LED. 8W, 220/240V, 50/60Hz.

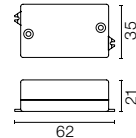

RF23065

Trasformatore elettronico per LED a tensione costante (24V). 8W, 110/240V, 50/60Hz.

Electronic transformer with constant voltage (24V) for LED. 8W, 110/240V, 50/60Hz.

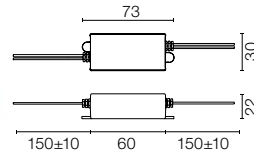

60.9157

Fonte di alimentazione a corrente costante 10W, 100-240V - 50/60Hz con corrente di alimentazione 500 mA non regolabile.

Constant voltage supply source of 10W, 100-240V - 50/60Hz with non adjustable 250 mA supply voltage.

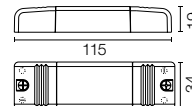

60.9389

Fonte di alimentazione a corrente costante 20W, 100-240V - 50/60Hz con corrente di alimentazione 500 mA regolabile.

Constant voltage supply source of 20W, 100-240V - 50/60Hz with adjustable 250 mA supply voltage.

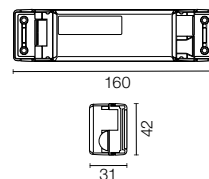

0-10V
60.9405
Dali
60.9601

DRIVER / DRIVERS

Fonte di Alimentazione a Corrente Costante per LED / Constant Current Power Supply for LED

Fonte di alimentazione a corrente continua non dimmerabile di 220/240V - 50/60Hz con corrente di alimentazione selezionata tramite interruttore regolabile 200 mA - 8,5W / 300 mA - 13W / 350 mA - 15W / 400 mA - 17,5W / 450 mA - 19,5W / 500 mA - 22W.

Non dimmable continuous current power supply of 220/240V - 50/60Hz with power current selected through adjustable with switch 200 mA - 8,5W / 300 mA - 13W / 350 mA - 15W / 400 mA - 17,5W / 450 mA - 19,5W / 500 mA - 22W.

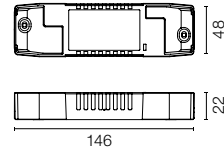

60.9160

Fonte di alimentazione a corrente costante, dimmerabile 0-10V, 220/240V - 50/60Hz, 200mA - 20W.

Continuous current power supply, 0-10V dimmable, 220/240V - 50/60Hz, 200mA - 20W.

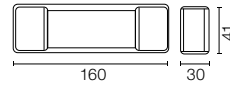

60.9483

Fonte di alimentazione a corrente costante, dimmerabile Dali 2, 220/240V - 50/60Hz, 200mA - 20W.

Continuous current power supply, dimmable Dali 2, 220/240V - 50/60Hz, 200mA - 20W.

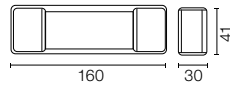

60.9604

Fonte di alimentazione a corrente costante, dimmerabile 0/1-10V, 220/240V - 50/60Hz, 300 mA - 16W / 350 mA - 18W / 400 mA - 21W / 500 mA - 27W / 600 mA - 32W / 650 mA - 35W / 700/750/800/900/1000/1050 mA - 36W.

Continuous current power supply, 0/1-10V dimmable, 220/240V - 50/60Hz, 300 mA - 16W / 350 mA - 18W / 400 mA - 21W / 500 mA - 27W / 600 mA - 32W / 650 mA - 35W / 700/750/800/900/1000/1050 mA - 36W.

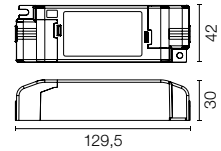

60.9439

Fonte di alimentazione a corrente costante 240V - 50/60Hz dimmerabile Dali 2, push dimming, con corrente di alimentazione selezionabile tramite switch 300mA - 16W / 350mA - 18W / 400mA - 21W / 500mA - 27W / 600mA - 32W / 650 mA - 35W / 700/750/800/900/1000/1050 mA - 36W.

Continuous current supply source of 240V - 50/60Hz with dimmable Dali 2, push dimming, 300mA - 16W / 350mA - 18W / 400mA - 21W / 500mA - 27W / 600mA - 32W / 650 mA - 35W / 700/750/800/900/1000/1050 mA - 36W.

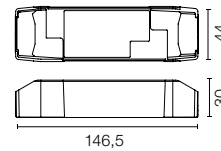

RF30699

Fonte di alimentazione a corrente costante, dimmerabile Casambi, 220/240V - 50/60Hz, 300mA - 16W / 350mA - 18,5W / 400mA - 21,5W / 450 mA - 24W / 500mA - 27W / 600mA - 32W / 650 mA - 35W / 700 mA - 36W / 750/800/900/1000/1050/1200 mA - 38W.

Continuous current power supply, dimmable Casambi, 220/240V - 50/60Hz, 300mA - 16W / 350mA - 18,5W / 400mA - 21,5W / 450 mA - 24W / 500mA - 27W / 600mA - 32W / 650 mA - 35W / 700 mA - 36W / 750/800/900/1000/1050/1200 mA - 38W.

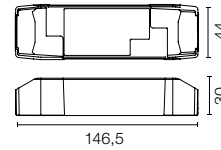

60.9207

Fonte di alimentazione 1-10V, Mains a corrente costante regolabile, leading & trailing edge 220/240V - 50/60Hz, 500mA - 10W.

Continuous current power supply, 1-10V, regulable Mains, leading & trailing edge 220/240V - 50/60Hz, 500mA - 10W.

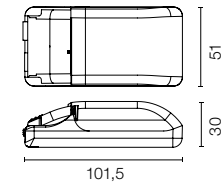

60.9411

Fonte di alimentazione Mains a corrente costante regolabile, leading & trailing edge 220/240V - 50/60Hz, 300mA - 14W / 350 mA - 17W / 400 mA - 19W / 450/500/600/650/700/750/800/900 mA - 20W.

Continuous current power supply, Mains dimming, leading & trailing edge 220/240V - 50/60Hz, 300mA - 14W / 350 mA - 17W / 400 mA - 19W / 450/500/600/650/700/750/800/900 mA - 20W.

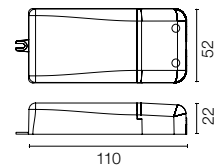

60.9467

DRIVER / DRIVERS

Fonte di Alimentazione a Tensione Costante per LED / Constant Voltage Power Source for LED

Unità di controllo dimmer DALI con 1 canale per la regolazione di moduli LED, per drivers di 24V. Alimentatore non incluso.

Dimmable DALI control unit with 1 channel for 24V LED modules. Power supply not included.

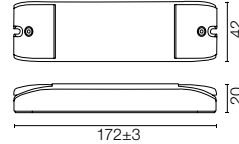

60.8635

Alimentatore LED per installazione remota in quadro elettrico 24V/240W. 100/240V.

LED power supply source for remote installation in 24V/240W electric control panel. 100/240V.

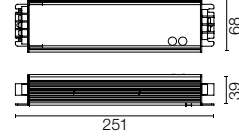

60.8268

Trasformatore elettronico per LED a tensione costante (24V). 100/240V.

Electronic transformer with constant voltage (24V) for LED. 100/240V.

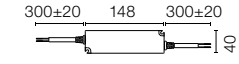

25W

60.8703

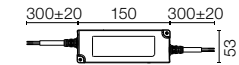

60W

60.9089

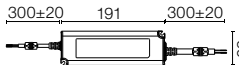

120W

RF28688

Trasformatore elettronico per LED a tensione costante (24V). 60W. 100/240V. Per uso indipendente.

Electronic transformer with constant voltage (24V) for LED. 60W. 100/240V. For independent use.

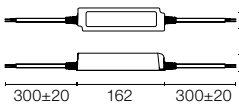

60.8515

Alimentatore LED per installazione remota in quadro elettrico 24V/200W. Per evitare problemi di sovraccarico si consiglia di installare un alimentatore indipendente ogni 185W. 100/240V.

LED power supply source for remote installation in 24V/200W electric control panel. To avoid problems of overload it is recommended to install a power source every 185W. 100/240V.

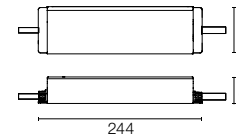

RF28143

Trasformatori Elettronici 12V / 12V Electronic Transformer

Trasformatore elettronico 12V. 220/240V, 50/60Hz. Possibilità di regolazione tramite dimmer "leading and trailing edge".

12V electronic transformer. 220/240V, 50/60Hz. Adjustable by means of "leading and trailing edge".

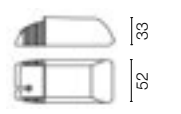

35-105W

60.9424

20-70W

60.9398

Verificare la compatibilità con le lampade LED Retrofit / Please check compatibility with Retrofit LED lamps.

Trasformatore elettronico 12V. 230/240V, 50-225W.

12V electronic transformer. 230/240V, 50-225W.

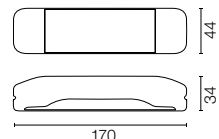

RF18525

Verificare la compatibilità con le lampade LED Retrofit / Please check compatibility with Retrofit LED lamps.

Trasformatori Convenzionali 12V / 12V Conventional Transformer

Trasformatore ferromagnetico 12V. 230V, 50/60Hz. IP67. Cavo primario: 75 cm, cavo secondario: 145 cm.

12V conventional transformer. 230V - 50/60Hz. IP67. Primary wire: 75 cm, secondary wire: 145 cm.

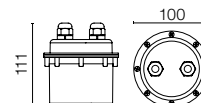



50W



RF21467



DRIVER / DRIVERS

Ref	L max(m) 1.5mm ²	L max(m) 2.5mm ²
RF23065	5	N/A
60.8268	2	3,5
RF21467	5	8,5
RF18525	1	1,5
60.8437	20	50
60.8515	5	N/A
60.8529	20	50
RF21468	10	15
RF21466	10	15
RF21469	10	15
60.8629	50	50
60.8635	5	8
60.8650	50	50
60.8654	20	50
60.8655	20	50
60.8656	20	50
60.8668	10	15
RF26569	20	30
60.8689	50	50
60.8703	5	N/A
60.8837	10	15
RF26571	10	15
60.9208	10	15
RF26570	50	50
60.8911	20	50
60.9089	5	N/A
60.9157	5	N/A
60.9160	10	15
RF27370	20	30
RF30699	10	15
RF27961	10	15
60.9207	10	15
60.9222	10	15
60.9233	20	50
60.9268	15	15
60.9276	10	15
RF27535	20	50
RF28143	2,5	4
60.9389	6	15
60.9398	2	2
60.9405	6	15
RF28688	5	10
60.9411	5	10
60.9421	20	50
60.9424	2	2
60.9439	2,5	4
60.9467	10	15
60.9483	2,5	4
60.9592	10	15
60.9601	20	50
60.9604	2,5	4



SORGENTI LUMINOSE / LIGHT SOURCES



	Wattage (W)	Color T ^a (K)	Voltage (V)	Reference
 QT-14 CLEAR	18	2770	230	60.6616
	28	2770	230	60.6617
	42	2700	230	60.6618
 BASE G9 230V				



	Angle	Wattage (W)	Color T ^a (K)	Voltage (V)	Reference
 HI PAR 51	25°	50	3000	230	60.6722
	40°	50	3000	230	60.6723
	60°	50	3000	230	60.6724
 BASE GX10 230V					



	Wattage (W)	Color T ^a (K)	Voltage (V)	Reference
 QT-14 ES	20	2900	230	RF19264
	33	2900	230	RF18863
 BASE G9 230V				

	Wattage (W)	Color T ^a (K)	Voltage (V)	Reference
 TC-DEL	18	2700	230	60.6213
	18	3000	230	60.6256
	18	4000	230	60.6257
	26	2700	230	60.6214
	26	3000	230	60.6258
	26	4000	230	60.6259
 BASE G24q 230V				

	Wattage (W)	Color T ^a (K)	Voltage (V)	Reference
 QT-12	35	3000	12	60.6300
	50	3000	12	60.6303
	75	3000	12	60.6304
	90	3000	12	60.6305
	100	3000	12	60.6306
	35	2900	12	60.6404 ^{IRC}
	50	3000	12	60.6399 ^{IRC}
	 BASE GY6.35 12V			

	Wattage (W)	Color T ^a (K)	Reference
 T5 FH	14	3300	60.6500
	21	3300	60.6503
	21	4000	60.6504
	28	3000	60.6506
	28	4000	60.6507
	35	3300	60.6509
	35	4000	60.6510
	 BASE G5 230V		

	Wattage (W)	Color T ^a (K)	Voltage (V)	Reference
 QT-9	10	3000	12	60.6301
	20	3000	12	60.6302
 BASE G4 12V				

	Wattage (W)	Color T ^a (K)	Reference	
 T5 FQ	24	3300	60.6512	
	24	4000	60.6513	
	39	3300	60.6515	
	39	4000	60.6516	
	54	3000	60.6518	
	54	4000	60.6519	
	54	5000	60.6520	
	80	3300	60.6521	
	80	4000	60.6522	
	80	5000	60.6523	
	 BASE G5 230V			

LED ARRAY

Controllo Maggiore Controllo Ottico

Il modulo LED Array dispone di una superficie ad alta densità luminosa che consente, tramite riflettori, di controllare la luce in modo molto efficace. È possibile ottenere una grande varietà di angoli di apertura, ed è quindi adatto a qualunque tipo di applicazione.

Control Greater Optical Control

The LED Array module has a high-density light surface that allows the light to be effectively controlled through reflectors. A wide variety of opening angles can be obtained, thereby catering for any application.

Senza Pixelazione Luce Bianca senza Pixelazione

Il LED Array, grazie alla sua configurazione, dà un bianco uniforme, senza variazione di colore. Inoltre, per tutta la sua durata, il modulo garantisce un eccezionale mantenimento del flusso luminoso e della temperatura del colore.

No Pixellation White Light without Pixellation

Due to its configuration, the LED Array achieves a uniform standard of whites with no change in colour. In addition, during the useful life of the module, an exceptional maintenance of the luminous flow and colour temperature is obtained.

Riduzione dei Costi Riduzione dei Costi Operativi

Con questa soluzione LED, si ottiene una notevole riduzione dei costi di manutenzione, grazie alla lunga durata con un flusso luminoso minimo del 70%. L'energia consumata si riduce fino al 75% rispetto alle fonti di illuminazione tradizionali.

Cost Reduction Reduction in Operating Costs

With this LED solution, there is a drastic reduction in maintenance costs due to its long useful life with a minimum luminous flow of 70 %. The energy consumed is reduced by 75 % compared to traditional lighting sources.

Applicazione in Campo "Retail" Fonte Luminosa per Applicazione in Campo "Retail"

Il flusso luminoso non contiene raggi IR o UV, i quali danneggiano i tessuti o provocano un prematuro deterioramento dei generi alimentari. L'eliminazione del calore nel fascio luminoso si traduce in una riduzione dei costi per aria condizionata.

Retail Application Light Source for Retail Application

The luminous flow contains no IR or UV radiation, which cause damage to clothing or the premature spoiling of food. The elimination of heat in the light beam is transformed into a reduction in air conditioning costs.

Riflettori Resa Luminosa

Il modulo LED Array non è una sorgente puntiforme. La luce è emessa tramite l'area della resina della matrice LED. Questa struttura influisce quando si fanno calcoli illuminotecnici e sul controllo dell'angolo di apertura del LED. Per questo motivo, il corretto controllo luminoso si ottiene tramite riflettori. Questi riflettori si possono realizzare in termoplastica metallizzata, in quanto non vi sono esigenze termiche legate alla sorgente luminosa. Potendosi realizzare con termoplastica, il design offre una maggiore flessibilità ed è possibile ottimizzare la superficie riflettente con forme non fattibili con i riflettori tradizionali in alluminio, con una resa del 90%. È possibile ottenere angoli di apertura da 20° fino a circa 60°.

Reflectors Light Performance

The LED module is not a point source. The light is emitted through the LED matrix resin area. This construction has an influence when making light calculations and controlling the LED opening angle. As a result, the best way to perform this light control is using reflectors. These reflectors may be made of metallic thermoplastic material since there is no thermal demand on the light source. As they can be made of thermoplastic, there is greater flexibility in their design and the reflecting surface can be optimised with non-viable forms with traditional aluminium reflectors, with a performance of 90 %. Opening angles of between approximately 20° and 60° can be obtained.

POWER LED

Fascio di Luce **Fascio di Luce Stretto**

Essendo la sorgente luminosa è puntiforme il controllo ottico deve essere realizzato mediante lenti. Tale controllo ottico consente la riduzione del fascio di luce fino ad angoli molto chiusi. Per questo, in applicazioni in cui è necessaria una grande densità di luce, questa è la sorgente luminosa più adeguata.

Light Beam **Closed Light Beam**

Due to the fact that the light comes from a point source, optical control must be carried out using lenses. This optical control allows for the reduction of the light beam to very closed angles. For this reason, this is the most appropriate light source in applications which require a high light density.

Design **Libertà di Design**

I power LED si montano su schede elettroniche. Queste si possono progettare secondo un'infinità di dimensioni e forme: il design completo della sorgente luminosa (scheda elettronica + LED + lenti) è caratterizzato da un'estrema flessibilità e libertà. Tale flessibilità lo distingue dalle fonti luminose tradizionali.

Design **Freedom of Design**

The power LEDs are mounted on electronic board. These electronic boards can be designed in many different sizes and shapes, so that the complete light source design (electronic board + LED + Lenses) is extremely flexible and has great freedom. This flexibility makes it different from traditional light sources.

Colore **Ampia Gamma di Temperature di Colore**

I power LED sono discreti e si possono scegliere in un'ampia varietà di temperature di colore. Si stabiliscono dei "bin" (intervalli dello spettro cromatico) in cui si garantisce che i LED dispongano di una variazione cromatica minima rispetto alla temperatura di colore selezionata.

Colour **Wide Range of Colour Temperatures**

The power LEDs are discreet, and can be selected in a wide range of colour temperatures. Bins are established (chromatic spectrum ranges) in which it is guaranteed that the LEDs have a minimum chromatic change with respect to the colour temperature selected.

TOP LED

Fascio di Luce **Luce Diffusa**

Grazie alla loro forma geometrica, sono eccellenti per applicazioni in cui non vi sono requisiti di luce diretta, come nel caso di luce indiretta o dispositivi di illuminazione con diffusore incorporato.

Light Beam **Diffuse Light**

Given their geometry, they are excellent for applications that have no directed light requirements, such as indirect light or luminaires.

Alimentazione **Tensione 24V**

Con le loro dimensioni compatte e la loro alimentazione semplice, i "Top LED" offrono molteplici soluzioni differenti al momento di progettare un circuito stampato. La facile alimentazione tramite fonti di tensione costante a 12/24 V, con possibili montaggi e connessioni in parallelo, unitamente alla possibilità di creare design raggruppati e irregolari, li rendono i candidati perfetti quando è necessario progettare una fonte luminosa lontana dai canoni stabiliti dalle fonti di luce tradizionali.

Power Supply **Voltage 24V**

Given their compact dimensions and simple power supply, the "Top LED" offer dozens of different solutions for designing a printed circuit. Their easy power supply using constant 12/24V voltage supplies with possible assemblies and connections in parallel, together with the possibility of creating grouped and irregular designs, make them the perfect candidate when a light source far from the conventions set my traditional light sources is necessary.

Colore **Ampia Gamma di Temperature di Colore**

I "Top LED", come i "Power LED", sono disponibili in una vasta gamma di temperature di colore distribuite lungo lo spettro cromatico. La scelta stabilita verrà definita dal relativo bin, garantendone l'omogeneità all'interno di esso.

Colour **Wide Range of Colour Temperatures**

The "Top LED" like the "Power LED" are available in a large range of colour temperatures distributed throughout the entire chromatic spectrum. The selection made will be defined by its bin guaranteeing its homogeneity in it.

REMOTE PHOSPHOR LED

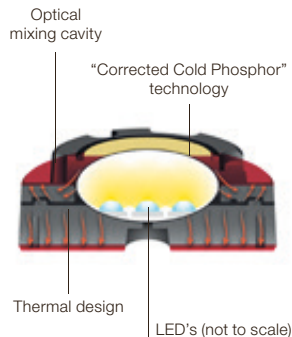

Coerenza del Colore e Omogeneità Cromatica

Il modulo LED al fosforo remoto è disponibile in un intervallo di temperature di colore da 2700K, 3000K e 4000K. Ciascuna delle suddette temperature di colore sono esattamente posizionate nel BBL (Black Body Locus) per garantire una perfetta luce bianca. La tolleranza di selezione dei LED è di 1x2 nell'ellisse di MacAdam, migliorando la specifica ANSI C78.377.

Consistency Colour and Chromatic Homogeneity

The remote phosphor LED module is available in a colour temperature range of 2700K, 3000K and 4000K. Each of these colour temperatures is exactly positioned in the BBL (Black Body Locus) to guarantee perfect white light. The LEDs selection tolerance is 1x2 in the MacAdam ellipse, improving the ANSI C78.377 specification.

Uniforme Fascio di Luce

Le lampadine alogene o i LED Array possono subire variazioni di luce su una superficie illuminata a causa dell'assenza di uniformità tipica della fonte luminosa. Il modulo al fosforo remoto ha una superficie di emissione luminosa uniforme, che si riflette in un perfetto fascio di luce senza ombre né variazioni di colore.

Uniform Light Beam

Halogen lamps or LED Arrays may suffer changes in light on an illuminated surface, due to the non-uniformity of the light source. The remote phosphor module has a uniform light-emitting surface that is reflected in a perfect beam of light without shadows or changes in colour.

Riproduzione Alta Cromatica

Con la versione "Artist", attraverso l'ideale combinazione della gamma di LED e le specifiche al fosforo, si ottiene un CRI al di sopra del 95. Questo modulo è stato ottimizzato per ottenere eccellenti risultati nei colori più saturi. Per il rosso, si ottiene un valore al di sopra del 90. Queste cifre non solo superano quelle di altre soluzioni LED ma migliorano anche i risultati delle lampadine tradizionali fluorescenti o ad alogenuri metallici.

Reproduction High Chromatic

With the "Artist" version; through the correct combination of the LEDs selection and phosphor specifications, a CRI above 95 is obtained. This module has been optimised to obtain excellent results in the most saturated colours. For the red, a value above 90 has been obtained. These numbers not only surpass those of other LED solutions, but improve the results of traditional fluorescent or metal halogenide lamps.

COLOUR RENDERING CHART

A comparison between the Phosphor LED (Artist Series) and other lighting sources
Note: 2700K and 4000K perform similarly

	Ra	R1	R2	R3	R4	R5	R6	R7	R8	R9	R10	R11	R12	R13	R14	R15
Artist Series XTM	98	98	99	98	98	98	97	98	98	96	99	98	88	98	98	98
Typical IR coated Halogen Dichroic	98	98	99	99	99	98	98	99	97	92	97	98	97	98	99	97
Typical Compact Halogen Halide	82	90	94	69	82	81	81	87	71	27	59	62	55	93	78	88
Typical Compact Fluorescent	87	91	93	86	91	89	90	88	70	17	76	91	81	93	92	81

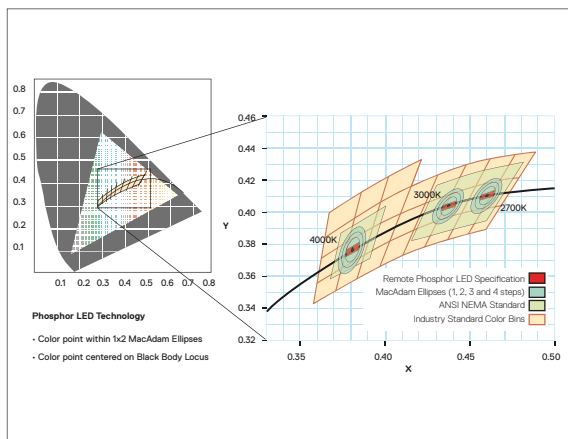

Independent measurements by University College London

SIMBOLOGIA / PICTOGRAPHY

Grado di Protezione Degree of Protection



Indice di protezione contro la penetrazione di corpi solidi e di liquidi.

Protection degree offered by the fixture to the ingress of solids and liquids.



0 Nessuna protezione.
 1 Protezione contro i corpi solidi di dimensioni superiori a 50 mm.
 2 Protezione contro i corpi solidi di dimensioni superiori a 12 mm.
 3 Protezione contro i corpi solidi di dimensioni superiori a 2,5 mm.
 4 Protezione contro i corpi solidi di dimensioni superiori a 1 mm.
 5 Protezione contro la polvere.
 6 Totalmente protetto contro la polvere.

0 No protection.
 1 Protected against solid bodies over 50 mm in diameter.
 2 Protected against solid bodies over 12 mm in diameter.
 3 Protected against solid bodies over 2,5 mm in diameter.
 4 Protected against solid bodies over 1 mm in diameter.
 5 Protected against dust.
 6 Fully protected against dust.

1a cifra: protezione contro la penetrazione dei corpi solidi.

1st figure: protection against penetration by solid bodies.



0 Nessuna protezione.
 1 Protezione contro la caduta in verticale di gocce d'acqua.
 2 Protezione contro la caduta in verticale di gocce d'acqua con angolo di inclinazione max di 15°.
 3 Protezione contro la caduta in verticale di gocce d'acqua con angolo di inclinazione max di 60°.
 4 Protezione contro gli spruzzi d'acqua.
 5 Protezione contro i getti d'acqua.
 6 Protezione contro le ondate d'acqua.
 7 Protezione contro l'immersione.
 8 Protezione contro l'immersione prolungata.

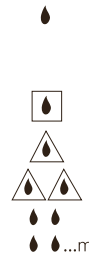

0 No protection.
 1 Protected against drops of water falling vertically.
 2 Protected against drops of water at a max. inclination of 15 degrees.
 3 Protected against drops of water at a max. inclination of 60 degrees.
 4 Protected against splashed of water.
 5 Protected against jets of water.
 6 Protected against waves.
 7 Protected against immersion.
 8 Protected against long term immersion.

2a cifra: protezione contro l'infiltrazione di acqua.

2nd figure: protection against penetration by water.

Simbologia Pictography



Apparecchio idoneo per essere installato su superfici normalmente infiammabili.

Luminaire with builtin power packs or transformers, suitable for mounting directly onto normally inflammable surfaces.



Ballast convenzionale.

Conventional Ballast.



Supera la prova del Filo Incandescente (Glow Wire Test) a 850°C conforme alla norma IEC 60695-2-10.

Passes Glow Wire Test at 850°C according to standard IEC 60695-2-10.



Apparecchi di illuminazione progettati esclusivamente per l'uso di lampade alogene al tungsteno o lampade di alogenuri metallici con paralume protettivo proprio.

Luminaires designed to exclusively use wolfram halogen lamps or metal halide lamps with own protection screen.

Classi di Isolamento delle Lampade Luminaires Classification



Class I

Lampada la cui protezione contro la scarica elettrica non si basa solo sull'isolamento di base dell'apparecchio, ma su un ulteriore sistema di sicurezza che consiste nel collegamento dei componenti conduttivi accessibili a un conduttore di sicurezza (messa a terra) facente parte dell'impianto elettrico fisso.

Luminaire in which protection against electrical shocks is not just based on the basic insulation but also on an additional safety precautions consisting of connecting the accessible conductive parts to a safety conductor (earth).



Class II

Lampada la cui protezione contro la scarica elettrica non si basa solo sull'isolamento di base dell'apparecchio, ma su un ulteriore misura di sicurezza che consiste in un doppio isolamento rinforzato senza dispositivi per la messa a terra.

Luminaire in which protection against electrical shocks is not just based on the basic insulation but also on an additional safety precautions consisting of double reinforced insulation without conductive parts to a safety conductor (earth).



Class III

Lampada la cui protezione contro la scarica elettrica si basa su un sistema a bassissima tensione, che non viene mai superata. Una lampada di Classe III non deve mai essere fornita con la messa a terra.

Luminaire in which protection against electrical shocks is based on the very low safety supply voltage and no voltages are produced higher than this. A Class III luminaire must never be provided with earthing.

Omologazioni Homologations



Tutte le lampade prodotte e presentate in questo programma sono state realizzate in conformità con la Norma Europea EN 60 598 e sono pertanto conformi ai requisiti definiti nella Direttiva CEE 73/23 (Direttiva di Bassa Tensione). La loro realizzazione garantisce anche la conformità alla Direttiva 89/336 per quanto concerne la Compatibilità Elettromagnetica. Tutti i prodotti rientranti nel campo di applicazione delle suddette Direttive riportano la marcatura CE, che ne attesta la conformità ai relativi requisiti.

All lamps manufactured and illustrated in this catalog comply with European Standard EN 60 598 and consequently meet the requirements set forth in Directive 73/23 EEC (Low Voltage Directive). They also comply with Directive 89/336 covering electromagnetic compatibility. All products falling under the scope of the above-mentioned Directives bear the CE mark as proof of their compliance with the respective requirements.



La presenza del marchio ENEC sul prodotto conferma l'adempimento della Normativa Europea e garantisce l'affidabilità del sistema organizzativo e produttivo responsabile della fabbricazione del prodotto, attraverso un ente di certificazione accreditato. Il marchio ENEC conferma il nostro impegno ed è la migliore garanzia in tema di sicurezza e qualità di tutti i nostri prodotti.

The ENEC mark on the product stands for the compliance of European Standard as well as a trustworthy organisation and product system and is guaranteed by an accredited certification body. This agreed mark stands for our engagement and represents the best guarantee in security and quality matter of our products.



L'Associazione Spagnola di Normalizzazione e Certificazione AENOR certifica che il Sistema di garanzia di qualità adottato dalla Antares Iluminación S. A. soddisfa i requisiti della Norma Europea EN ISO 9001: Sistema di Qualità.

The Spanish Association for Standards and Certification AENOR, certifies that quality assurance system adopted by Antares Iluminación, S.A. complies with the requirements of the standard UNE-EN ISO-9001 Quality Systems.



L'Organismo di Certificazione QCERT S.A.S. studia la conformità dei nostri prodotti per la commercializzazione in Colombia, in base alla normativa nazionale ed internazionale vigente. Questo certificato di prodotto permette a produttori e distributori di espandere il loro mercato ed ottenere un vantaggio competitivo che andrà oltre le frontiere del mercato locale, potenziando il commercio a livello internazionale.

The QCERT S.A.S. Certification Body evaluates the conformity of our products to enable their placement on the Colombian market while taking into account the current national and international regulations. This product certification allows manufacturers and marketers to expand their markets and gain a competitive advantage that can transcend the boundaries of the local market while enhancing international trade.



Creata da IECEE, sistema di certificazione CB basato sulle Norme Internazionali IEC, riconosciuto in Arabia Saudita, Argentina, Australia, Austria, Bahrein, Belgio, Bielorussia, Brasile, Bulgaria, Canada, Cina, Colombia, Croazia, Danimarca, Emirati Arabi Uniti, Finlandia, Francia, Germania, Giappone, Grecia, India, Indonesia, Irlanda, Israele, Italia, Kenia, Libia, Malesia, Messico, Norvegia, Nuova Zelanda, Paesi Bassi, Pakistan, Polonia, Portogallo, Regno Unito, Repubblica Ceca, Repubblica di Corea, Romania, Russia, Serbia, Singapore, Slovacchia, Slovenia, Spagna, Stati Uniti, Sudafrica, Svezia, Svizzera, Thailandia, Turchia, Ucraina, Ungheria e Uruguay.

Created by IECEE, the CB certification system based on the IEC International Standards is recognized in Saudi Arabia, Argentina, Australia, Austria, Bahrain, Belgium, Belarus, Brazil, Bulgaria, Canada, China, Colombia, Croatia, Denmark, United Arab Emirates, Finland, France, Germany, Japan, Greece, India, Indonesia, Ireland, Israel, Italy, Kenya, Libya, Malaysia, Mexico, Norway, New Zealand, Netherlands, Pakistan, Poland, Portugal, United Kingdom, Czech Republic, Republic of Korea, Romania, Russia, Serbia, Singapore, Slovakia, Slovenia, Spain, United States, South Africa, Sweden, Switzerland, Thailand, Turkey, Ukraine, Hungary and Uruguay.

**Dati Fotometrici
Photometric Data**

Con il passare del tempo, è aumentato il numero di input visivi ai quali l'uomo è esposto. Attualmente, sembra che circa il 75% delle informazioni elaborate dall'uomo per rapportarsi al proprio ambiente siano ricevute attraverso gli occhi, che funzionano in modo simile ad una macchina fotografica, utilizzando la luce emessa o riflessa dagli oggetti presenti in un determinato ambiente. Ciò significa che le informazioni elaborate dal cervello dipendono fortemente dai livelli, dal tipo di luce, e dal modo con cui tale ambiente viene illuminato.

Con la documentazione fotometrica redatta (in particolare tramite il programma di calcolo) intendiamo fornire ai progettisti illuminotecnici il materiale necessario per la realizzazione dei progetti di illuminazione rispondenti all'attuale normativa EN 12464-1 in termini di adeguata distribuzione della luce, comfort visivo, massima efficienza luminosa e quindi consumo energetico ridotto al minimo possibile. Per sfruttare al massimo le possibilità del programma di calcolo, è essenziale disporre di tutte le informazioni necessarie sui prodotti da utilizzare.

Norma EN 12464-1

Specifica i requisiti illuminotecnici per soddisfare le esigenze delle prestazioni visive nei diversi ambienti in interni, ed in particolare nei posti di lavoro, anche muniti di videoterminali, prescrivendo i valori degli illuminamenti medi E_m , dell'indice di resa cromatica R_a , del comfort visivo UGR.

Indice unificato di abbagliamento UGR (Unified Glare Rating)

Definisce la classe di abbagliamento molesto causato dall'impianto di illuminazione in un interno, tenendo conto della tipologia degli apparecchi, delle caratteristiche di riflessione e dimensionali dei locali, della posizione degli osservatori.

Ad esempio per postazioni CAD le norme EN 12464-1 prescrivono $E_m = 500 \text{ lx}$, $R_a = 80$, $UGR \leq 19$.

Rappresentazione Grafica delle Caratteristiche di Emissione Luminosa

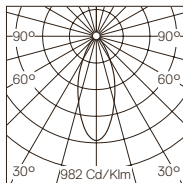

La distribuzione delle intensità luminose emesse da un apparecchio viene rappresentata con un diagramma polare relativo ad uno o più piani C che sezionano l'apparecchio passando per il suo baricentro luminoso. I piani e le intensità sono definiti da un sistema di coordinate sferiche (C, γ , I). Le curve congiungenti gli estremi dei vettori intensità su un piano C si chiamano curve fotometriche o indicatori di emissione.

Il numero dei piani sezione C è prescritto dalle raccomandazioni CIE, e richiamato nella Norma Europea relativa ai rilievi fotometrici e presentazione dei dati (CEN 13 032-1).

Per apparecchi che presentano emissioni rotosimmetriche l'emissione luminosa viene data da un'unica curva. In tutti gli altri casi la rappresentazione grafica viene data almeno dai piani trasversale (C0-180) e longitudinale (C90-270).

Per apparecchi che possono montare lampade geometricamente uguali ma con flussi luminosi differenti, generalmente si accetta che il diagramma polare delle intensità venga rappresentato per un flusso luminoso ideale di 1.000 lumen e quindi espresso in cd/klm.

Per fonti luminose con ottica incorporata i valori dell'intensità luminosa massima forniti in questo catalogo sono assoluti (cd) e non si riferiscono ad un flusso normalizzato di 1.000 lm, mentre nelle altre fonti gli stessi valori corrispondono ad un flusso ideale di 1.000 lm (cd/klm).

Per prodotti LED che incorporano elettronica di controllo e dissipatore di calore, e che possono essere alimentati sia a tensione di rete che con alimentatore DC, includendo apparecchi di illuminazione LED completi muniti di moduli LED non sostituibili, il metodo di prova LM-79 utilizza la fotometria assoluta per misurare direttamente il flusso luminoso totale per una configurazione particolare.

La distribuzione reale della luce e l'intensità luminosa si misurano direttamente dall'apparecchio di illuminazione completo.

With the passing of time, we have been exposed to a rising number of visual impacts. It is currently estimated that about 75% of the information we process when relating to our surroundings is received through our eyes, which work very much like a camera, through the light that is emitted or reflected from objects in a given environment. This means that the information processed by the brain is heavily reliant on the level and type of light, and how this environment is illuminated.

The photometric documentation that has been prepared (especially through the calculation program) aims to provide lighting designers with the material they need to develop lighting projects that comply with the EN 12464-1 standard now in force, in terms of sufficient light distribution, visual comfort, maximum lighting efficiency and consequently, the lowest possible energy consumption. In order to make the most of the calculation program, it is essential to have all the necessary information on the products to be used.

EN 12464-1 Standard

Sets the technical lighting requirements that satisfy the needs of indoor visual performance, especially in workplaces, even when visual display terminals are used, by prescribing the average illuminance values E_m , color rendering R_a , visual comfort UGR.

UGR (Unified Glare Rating)

Classifies the discomfort glare caused by an indoor lighting system, taking into account the kind of luminaires, the reflecting features and size of the rooms, the position of the observers.

For example, for CAD workstations, EN 12464-1 standards set $E_m = 500 \text{ lx}$, $R_a = 80$, $UGR \leq 19$.

Diagram of the Characteristics of Light Output

Luminous intensity distribution is presented in the form of a polar plot of one or more C planes that cross-section the luminaire, passing through its light center of gravity. The planes and the intensity are shown by means of a system of spherical coordinates (C, γ , I). The curves that join the ends of the intensity vectors on a C plane are called photometric curves or output indicators.

The number of C-section planes is prescribed by CIE recommendations, and is referred to in the European Standards on photometric measurements and data presentation (CEN 13 032-1).

For revolving or symmetrical luminaires, light output is shown as a single curve. In all the other cases, the diagram shows the horizontal (C0-180) and longitudinal (C90-270) planes at least.

For luminaires that can be fitted with light sources that are geometrically the same but with different luminous fluxes, it is generally accepted that the polar plot shows an ideal luminous flux of 1,000 lumen and is therefore expressed in cd/klm.

For light sources that include reflectors, the maximum luminous intensity values provided in this catalogue are absolute (cd) and do not refer to a standard 1,000 lm flux. For other sources, the same values correspond to an ideal 1,000 lm (cd/klm) flux.

For LED-based products incorporating control electronics and heat sinks, products requiring only line voltage or DC power supply, including complete LED luminaires with no replaceable integrated LED sources, the LM-79 test method uses absolute photometry to directly measure total lumen output for a particular configuration.

The real distribution of light and light intensity are measured directly for the complete luminaire.

E(lx/Klm)	D(m)
1	4918 0.20
2	1229 0.40
3	546 0.60
4	307 0.80
5	197 0.99

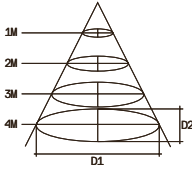

Illuminamento (rappresentato con il Simbolo E)

L'illuminamento medio espresso in lux (lx) su una superficie è il quoziente tra il flusso luminoso, espresso in lumen (lm) che investe la superficie e la misura (m^2) della superficie stessa. A seconda delle esigenze si possono calcolare illuminamenti orizzontali (per es. sulla scrivania: per leggere), verticali (illuminazione di un campo sportivo: per riconoscere gli atleti), semicilindrici (arredo urbano: per identificare chi ci viene incontro). In qualche caso, per es. nell'impiego di faretti o di lampade con riflettore incorporato, la rappresentazione delle prestazioni viene semplificata mediante tabelle dette "coni di luce" che riportano sia i valori degli illuminamenti medi e massimi, sia i diametri della macchia luminosa in relazione alle distanze dal piano rispetto all'apparecchio. L'angolo al vertice del cono di luce è l'apertura del fascio dell'apparecchio, ossia l'angolo descritto dal vettore intensità quando il suo modulo sia maggiore della metà dell'intensità massima. L'illuminamento viene espresso in lux per ogni 1.000 lm (lx/klm). Per fonti luminose con ottica incorporata, i valori degli illuminamenti medi e massimi sono assoluti, mentre per le altre fonti, essi corrispondono a un flusso ideale di 1.000 lm.

Isolux

Su una superficie, i risultati fotometrici di un impianto di illuminazione possono essere graficamente rappresentati mediante "isolux" ossia linee che collegano i punti con il medesimo illuminamento. Le isolux consentono di valutare in modo rapido, anche se approssimato il valore medio e l'uniformità dell'illuminamento.

Classificazione Fotometrica degli Apparecchi

Considerando la caratterizzazione della distribuzione del flusso luminoso e secondo diverse relazioni fra il flusso emesso da una lampada nell'emisfero superiore e inferiore, nonché il rapporto fra i diversi rendimenti, è possibile caratterizzare un apparecchio in conformità a differenti raccomandazioni e standard: CIE, DIN 5040, UTE, e CIBSE LG3.

CIE

Rappresentazione della distribuzione del flusso emesso dall'apparecchio all'interno di coni con angoli di apertura definiti; l'ultimo numero della serie fornisce il rendimento totale dell'apparecchio.

Gli apparecchi illuminanti vengono classificati in base a cinque numeri (codici CIE)

$N_1 = F_1/F_4$ $N_2 = F_2/F_4$ $N_3 = F_3/F_4$ $N_4 = F_4/F_5$ $N_5 = F_5/F =$ rendimento

Dove:

F_1 è il flusso emesso nel cono di angolo solido $\pi/2$, angolo al vertice 83°

F_2 è il flusso emesso nel cono di angolo solido π , angolo al vertice 120°

F_3 è il flusso emesso nel cono di angolo solido $3\pi/2$, angolo al vertice 151°

F_4 è il flusso emesso nel cono di angolo solido 2π , angolo al vertice 180°

F_5 è il flusso emesso nel cono di angolo solido 4π , angolo al vertice 360°

F è il flusso installato.

Illuminance (shown as E)

The average illuminance expressed in lux (lx) on a surface is the quotient resulting from the luminous flux, expressed in lumen (lm), on the surface and the dimension (m^2) of the surface itself. Depending on the need, the illuminance value can be horizontal (e.g. on a desk: for reading), vertical (illumination of a sports fields: to see the players), semi-cylindrical (urban fittings: to see who is coming towards us).

In some cases, for example when using spotlights or lamps with a reflector, the performance features are simply shown by means of tables called "light cones" showing both the average and maximum illuminance values, as well as the diameter of the luminous spot, in relation to the distance of the plane from the luminaire. The vertex angle of the light cone is the luminaire's beam, that is, the angle formed by the intensity vector when its module is greater than half of the maximum intensity.

Illuminance is expressed in lux per 1,000 lm (lx/klm). For light sources that include reflectors, the average and maximum illuminance values are absolute. For other sources, they correspond to an ideal 1,000 lm flux.

Isolux

The photometric results of a lighting installation can be shown on a surface using an "Isolux", that is, lines connecting the points with the same illuminance. Isolux diagrams are used to quickly determine, albeit in an approximate manner, the average value and uniformity of the illuminance.

Photometric classification of luminaires

Using the classification of luminous flux distribution and using the various ratios between the flux emitted by a luminaire in the upper and lower hemispheres, as well as the ratio of their different yields, a luminaire can be classified on the basis of different recommendations and standards: CIE, DIN 5040, UTE, and CIBSE LG3.

CIE

Diagram of flux distribution by a luminaire inside cones with specific angles; the last number of the series provides the total output ratio of the luminaire. Illuminating luminaires are classified on the basis of five numbers (CIE codes)

$N_1 = F_1/F_4$ $N_2 = F_2/F_4$ $N_3 = F_3/F_4$ $N_4 = F_4/F_5$ $N_5 = F_5/F =$ yield

Where:

F_1 is the flux emitted in the solid angle cone $\pi/2$, vertex angle 83°

F_2 is the flux emitted in the solid angle cone π , vertex angle 120°

F_3 is the flux emitted in the solid angle cone $3\pi/2$, vertex angle 151°

F_4 is the flux emitted in the solid angle cone 2π , vertex angle 180°

F_5 is the flux emitted in the solid angle cone 4π , vertex angle 360°

F is the installed flux.

DIN 5040

La classificazione fotometrica degli apparecchi è costituita da una lettera e due numeri. La lettera indica la distribuzione luminosa partendo dalla A: diretta concentrata, fino ad E: indiretta. La prima cifra indica la percentuale di flusso luminoso emesso nell'emisfero inferiore (diretta). La seconda cifra indica la percentuale di flusso nell'emisfero superiore (indiretto).

DIN 5040

The photometric classification of luminaires consists of a letter and two numbers. The letter indicates the luminous distribution starting from A: direct concentrated to E: indirect. The first number indicates the percentage of luminous flux emitted in the lower hemisphere (direct). The second number indicates the percentage of luminous flux in the upper hemisphere (indirect).

UTE

La classificazione fotometrica degli apparecchi è costituita da un numero che indica il rendimento diretto seguito da una lettera che indica la distribuzione luminosa partendo da A per il fascio stretto fino a J per il semindiretto. Nel caso in cui l'apparecchio avesse anche un'emissione indiretta (superiore), si aggiungerebbe il rendimento indiretto seguito dalla lettera "T". Ad esempio per un apparecchio che emetta il 30% del suo flusso verso il basso e il 35% del flusso verso l'alto, con un'emissione semindiretta, il codice UTE sarebbe 0,30J + 0,35T.

UTE

The photometric classification of luminaires consists of a number that indicates the direct output ratio followed by a letter that indicates the luminous distribution starting from A for a narrow angle to J for semi-indirect. Should the luminaire also have indirect emission (upper hemisphere), the indirect yield followed by the letter "T" is added. For example, for a luminaire emitting 30% of its flux downwards and 35% upwards, with a semi-indirect emission, the UTE code would be 0.30J + 0.35T.

CIBSE LG3

Con le modifiche al Lighting Guidance 3 del 2001 il sistema di classificazione per categorie (Cat) è stato abolito per uniformarsi alla normativa Europea EN 12464-1. Questa normativa inglese classificava gli apparecchi in tre categorie secondo la luminanza su quattro piani: C0-180, C90-270, C135-315 e C225-45. Erano classificate come CIBSE LG3 Cat 1 gli apparecchi aventi luminanza inferiore a 200 cd/m² per angoli di osservazione γ a partire da 55°. Erano classificate CIBSE LG3 Cat 2 gli apparecchi aventi luminanza inferiore a 200 cd/m² per angoli di osservazione γ a partire da 65°. Erano classificati CIBSE LG3 Cat 3 gli apparecchi aventi luminanza inferiore a 200 cd/m² per angoli di osservazione γ a partire da 75°.

CIBSE LG3

With the amendment of Lighting Guidance 3 in 2001, the category classification system (Cat) was abolished to conform to European Standard EN 12464-1. This British Standard classified luminaires in three luminance categories: C0-180, C90-270, C135-315 and C225-45. CIBSE LG3 Cat 1 if luminance was lower than 200 cd/m² starting at a 55° observation angle γ . CIBSE LG3 Cat 2 if luminance was lower than 200 cd/m² starting at a 65° observation angle γ . CIBSE LG3 Cat 3 if luminance was lower than 200 cd/m² starting at a 75° observation angle γ .

Filtri Colorati

L'applicazione di filtri colorati ad un apparecchio di illuminazione consente di modificare le caratteristiche foto-colorimetriche, ad esempio la temperatura del colore della lampada, adeguandola alle esigenze di un'illuminazione di accento o di una ambientazione particolare. L'utilizzo di filtri determina, inoltre, una riduzione dell'emissione luminosa di entità variabile in funzione delle caratteristiche del filtro.

Colored Filters

The use of colored filters in a luminaire modifies its photo-colorimetric features, for example the color temperature of the light bulb, adapting it for accent lighting or for a special setting. The use of filters also reduces the luminous output which can vary depending on the filter's characteristics.

File Eulumdat

I file Eulumdat di tutti gli apparecchi di illuminazione FLOS sono disponibili sul nostro sito www.flos.com, per consentirne l'impiego con i programmi di calcolo illuminotecnico.

Eulumdat Files

The Eulumdat files of all the FLOS luminaires are available on our website www.flos.com, so they can be used in technical lighting calculations.

SOFT ARCHITECTURE

Wall Rupture, Softprofile, Kaprofile,
Juncos, Wall Piercing, Soft Spun, Abajourd'hui,
Uso Boob, Usl Out, Apps,
G-O In, Teardrop, Uso,
Round, Square & Vertical Light,
Usb Round & Square Light.



Wall Rupture



Softprofile Smooth

Smooth Small

Smooth Large



Softprofile Deco

Starck Small

Starck Large

Wanders Small

Wanders Large



Kaprofile



Wall Rupture Designed By Thierry Dreyfus

Light Source: LED White - Gold Finish - 17,5W/m - 1140 lm/m - 2700K / LED White - Silver Finish - 17,5W/m - 1225 lm/m - 5000K

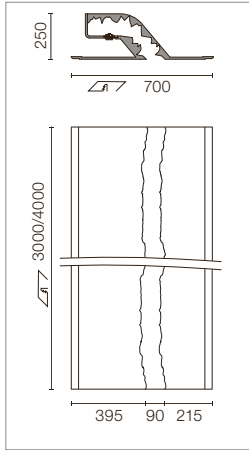

Apparecchio ad incasso per installazione a parete con tecnologia Soft. Moduli di LED con varie temperature di colore in base all'arredamento e alimentatori non dimmerabili compresi. Alimentazione 220/240V inclusa.

Soft technology wall-mounted, recessed luminaire. LED modules to emit lights with different colour temperature depending on décor; non-dimmable gear included. 220/240V power supply included.

Per le configurazioni personalizzate, contattare gli uffici commerciali Flos architectural.

For personal configuration ask Flos architectural sales team.

Profile

- 3m
 - SA.2423.5A145
 - SA.2423.5A165
- 4m
 - SA.2424.5A145
 - SA.2424.5A165

Wall Rupture with End caps Designed By Thierry Dreyfus

Light Source: LED White - Gold Finish - 17,5W/m - 1140 lm/m - 2700K / LED White - Silver Finish - 17,5W/m - 1225 lm/m - 5000K

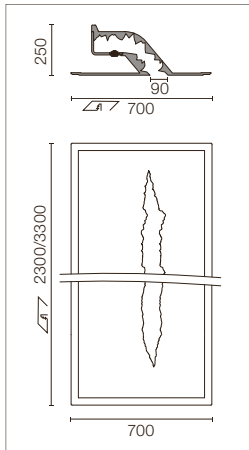

End cap

- 2,3m
 - SA.2453.5A145
 - SA.2453.5A165
- 3,3m
 - SA.2454.5A145
 - SA.2454.5A165



SOFT ARCHITECTURE | LINEAR

Softprofile Smooth Small Designed By Flos Soft Architecture

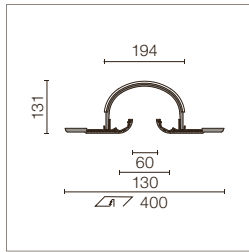

Apparecchio ad incasso per installazione a parete o a soffitto con tecnologia Soft. Permette l'installazione di moduli in entrambi i lati. Sistema di illuminazione non compreso.

Soft technology wall or ceiling-mounted recessed luminaire. It permits the installation of LED modules on both sides. Lighting systems not included.

Vedere moduli LED e regolatori LED.

See LED modules and LED drivers.

Terminale di Chiusura / End cap



Profile

3m
SA.2293.1
4m
SA.2294.1

End cap

SA.2295.1

Softprofile Smooth Large Designed By Flos Soft Architecture

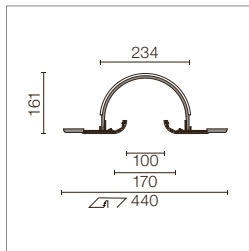

Apparecchio ad incasso per installazione a parete o a soffitto con tecnologia Soft. Permette l'installazione di moduli in entrambi i lati. Sistema di illuminazione non compreso.

Soft technology wall or ceiling-mounted recessed luminaire. It permits the installation of LED modules on both sides. Lighting systems not included.

Vedere moduli LED e regolatori LED.

See LED modules and LED drivers.

Terminale di Chiusura / End cap



Profile

3m
SA.2323.1
4m
SA.2324.1

End cap

SA.2325.1

Softprofile Deco Starck Small Designed By Philippe Starck

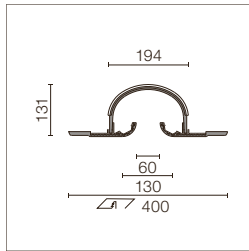

Apparecchio ad incasso per installazione a parete o a soffitto con tecnologia Soft. Permette l'installazione di moduli in entrambi i lati. Sistema di illuminazione non compreso.

Soft technology wall or ceiling-mounted recessed luminaire. It permits the installation of LED modules on both sides. Lighting systems not included.

Vedere moduli LED e regolatori LED.

See LED modules and LED drivers.

Terminale di Chiusura / End cap

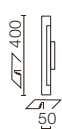

Profile

3m
SA.2313.1
SA.2313.3.120
SA.2313.3.140
SA.2313.3.160
4m
SA.2314.1
SA.2314.3.120
SA.2314.3.140
SA.2314.3.160

End cap

SA.2295.1

Softprofile Deco Starck Large Designed By Philippe Starck

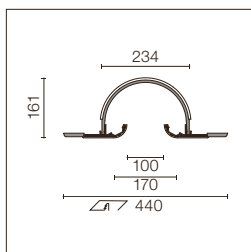

Terminale di Chiusura / End cap



Apparecchio ad incasso per installazione a parete o a soffitto con tecnologia Soft. Permette l'installazione di moduli in entrambi i lati. Sistema di illuminazione non compreso.

Soft technology wall or ceiling-mounted recessed luminaire. It permits the installation of LED modules on both sides. Lighting systems not included.

Vedere moduli LED e regolatori LED. See LED modules and LED drivers.

Profile

- 3m
 - SA.2343.1
 - SA.2343.3.120
 - SA.2343.3.140
 - SA.2343.3.160
- 4m
 - SA.2344.1
 - SA.2344.3.120
 - SA.2344.3.140
 - SA.2344.3.160

End cap

- SA.2325.1

Softprofile Deco Wanders Small Designed By Marcel Wanders

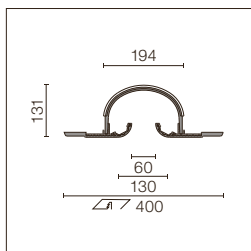

Terminale di Chiusura / End cap



Apparecchio ad incasso per installazione a parete o a soffitto con tecnologia Soft. Permette l'installazione di moduli in entrambi i lati. Sistema di illuminazione non compreso.

Soft technology wall or ceiling-mounted recessed luminaire. It permits the installation of LED modules on both sides. Lighting systems not included.

Vedere moduli LED e regolatori LED. See LED modules and LED drivers.

Profile

- 3m
 - SA.2303.1
 - SA.2303.3.120
- 4m
 - SA.2304.1
 - SA.2304.3.120

End cap

- SA.2295.1

Softprofile Deco Wanders Large Designed By Marcel Wanders

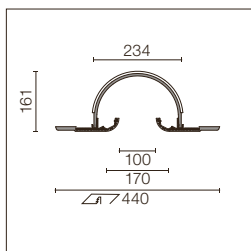

Terminale di Chiusura / End cap



Apparecchio ad incasso per installazione a parete o a soffitto con tecnologia Soft. Permette l'installazione di moduli in entrambi i lati. Sistema di illuminazione non compreso.

Soft technology wall or ceiling-mounted recessed luminaire. It permits the installation of LED modules on both sides. Lighting systems not included.

Vedere moduli LED e regolatori LED. See LED modules and LED drivers.

Profile

- 3m
 - SA.2333.1
 - SA.2333.3.120
- 4m
 - SA.2334.1
 - SA.2334.3.120

End cap

- SA.2325.1

Kaprofile Designed By Flos Soft Architecture

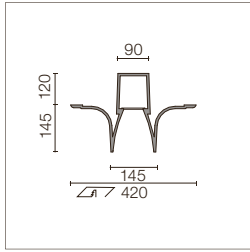

Profilo modulare con tecnologia Soft per installazione a soffitto. Sistemi di illuminazione a fluorescenza non compresi.
Vedi Modulo Lineare T5 Doppio. I profili si possono tagliare della misura desiderata.
Consultare il front office per l'installazione del modulo LED.

Soft technology ceiling-mounted modular profile. Fluorescence lighting systems not included. See Linear Module T5 Double. Profiles can be cut to the desired length.
Consult the front office for LED module installation.

Terminale di Chiusura / End cap

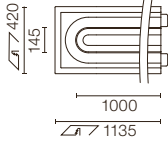

*Angolare / Corner

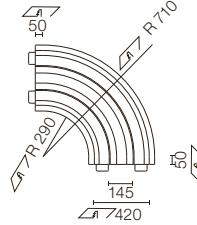

* Negli angolari, moduli di illuminazione compresi.
* In Corner, lighting modules included.

2m
SA.2282.1

End cap 1m
SA.2285.1

Corner
SA.2286.1

SOFT ARCHITECTURE | LINEAR

USP T5 DIRECT LIGHT - T5 MODULE

For Kapprofile

Modulo Lineare T5 Doppio Linear Module T5 Double

T5 FH	N. di Codice Reference	Wattaggio (W) Wattage (W)	Lunghezza (L) Length (L)	*Numero (N°) Number (N°)
	Non Dimmable			
	08.8306.00	2x21	1025	9
	08.8307.00	2x28	1325	9
	08.8308.00	2x35	1625	9
	Dimmable 1-10V			
	08.8320.00	2x21	1025	9
	08.8321.00	2x28	1325	9
	08.8322.00	2x35	1625	9
	Dimmable Dali			
08.8314.00	2x21	1025	9	
08.8315.00	2x28	1325	9	
08.8316.00	2x35	1625	9	

Modulo T5 lineare per una illuminazione ottimale senza zone d'ombra, resa possibile grazie alla sovrapposizione. I moduli sono disponibili in versione dimmerabile e per diversi wattaggi T5 (alta efficienza). Lampada non inclusa.

Linear T5 module for optimal illumination without dark zones, which are avoided by the overlapping. The modules are available in a dimmable version, and for different T5 wattages (high efficiency). Lamp not included.

* N°: Numero massimo di moduli connessi in una linea / N°: Maximum number of modules connected in one line.

Modulo Lineare T5 Schema Doppio Linear Module T5 Double Scheme



Modulo Lineare T5 Connessione Doppio Linear Module T5 Double Connection

Sovrapposizione Massima / Maximum Overlapping

Wattaggio Wattage (W)	A	B	*Numero Number (N°)
2x21	875	1900	9
2x28	1175	2500	9
2x35	1475	3100	9

Sovrapposizione Minima / Minimum Overlapping

Wattaggio Wattage (W)	A	C	*Numero Number (N°)
2x21	875	1975	9
2x28	1175	2575	9
2x35	1475	3175	9

Accessori / Accessories

Cavo di alimentazione con presa femmina. Tre poli, lunghezza: 250mm. Solo per versioni senza dimmer. Da ordinare separatamente.

Feed cable with female plug. Three poles, length: 250mm. Only for not dimmable versions. Must be ordered separately.



08.8330.00

Cavo di alimentazione con presa femmina. Tre poli, lunghezza: 250mm. Cavo di alimentazione per segnale 1-10 V/DALI compreso. Da ordinare separatamente.

Feed cable with female plug. Three poles, length: 250mm. Feed cable for signal 1-10V / DALI included. Must be ordered separately.



08.8356.00

SOFT ARCHITECTURE | LINEAR

LED DRIVERS

For: Softprofile Smooth - Softprofile Deco

Modulo Lineare LED Linear Module LED



Modulo LED per un'illuminazione indiretta ottimale. Connessioni Tyco maschio / femmina per una connessione facile su entrambi i lati. Può essere agganciato direttamente al Profilo.

LED module for optimal indirect illumination. Tyco connections male / female for easy electrical connection in both sides. Can be clipped directly to the Profile.

White

08.8512.00C
3,5W
228 lm
3000K
CRI 85

RGB

08.8294.00A
1,7W
77 lm
CRI>90

08.8513.00C
7W
456 lm
3000K
CRI 85

08.8296.00A
3,5W
154 lm
CRI>90

Non Dimmable

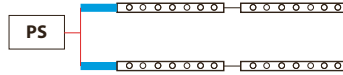

Cablaggio Wiring

Cavo di alimentazione da 500mm per moduli LED bianchi con connessione rapida. È necessario utilizzarne uno per ciascuna linea LED (due per ciascun Profilo). Massimo per ciascun cavo di alimentazione: 3 metri lineari LED. Alimentatore elettronico non incluso.

500mm feed cable for white LED modules with fast connection. Necessary one for each LED line (two for each Profile). Maximum for each feed cable: 3 LED line meters. Electronic power supply not included.

White

06.1016.00

Dimmable 1-10V

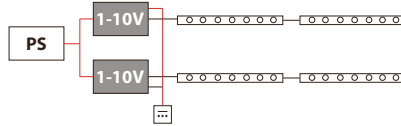

Interfacce Dimmerabili Dimmable Interfaces

Interfaccia 1-10 V con due cavi di alimentazione da 500mm con connessione rapida, per moduli LED bianchi. Massimo per ciascuna interfaccia: LED da 6 metri. Alimentatore elettronico non incluso.

1-10V interface with two 500mm feed cable for white LED modules with fast connection. Maximum for each interface: 6 LED meters. Electronic power supply not included.

White

06.1022.00

1-10V

Interfacce Dimmerabili Dimmable Interfaces

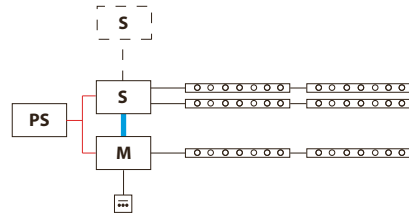

Interfaccia Master Dali con un distributore a 5 poli e 2 cavi di alimentazione da 500mm a connessione rapida. Alimentatore elettronico non incluso.

Dali Master interface with one 5 pole distributor and two 500mm feed cable for easy connection. Electronic power supply not included.

White

06.1023.00

M

RGB

06.1025.00

M

Interfaccia Master DMX con distributore a 5 poli e due cavi di alimentazione a connessione rapida. Alimentatore elettronico non incluso.

DMX Master interface with 5 pole distributor and two 500mm feed cable for easy connection. Electronic power supply not included.

06.1026.00

M

Interfaccia Master RGB a radiofrequenza (RF) con un distributore a 5 poli e due cavi di alimentazione da 500mm a connessione rapida. Trasmettitore a parete per i cambi di colore integrato. Alimentatore elettronico non incluso.

Radio Frequency (RF) RGB Master interface with 5 pole distributor and two 500mm feed cable for easy connection. Wall transmitter to make color changing integrated. Electronic power supply not included.

06.1027.00

M

SOFT ARCHITECTURE | LINEAR

LED DRIVERS

For: Softprofile Smooth - Softprofile Deco

Interfacce Dimmerabili Dimmable Interfaces

Interfaccia Slave per espandere il segnale con due distributori a 5 poli e quattro cavi di alimentazione da 500mm a connessione rapida. Alimentatore elettronico non incluso.

Slave interface to expand the signal with two 5 pole distributors and four 500mm feed cable for easy connection. Electronic power supply not included.

	White	RGB
	06.1024.00	06.1028.00
	S	S
	08.8297.00	08.8298.00

Cavo prolunga da 2 metri per moduli LED con connessione rapida. Si possono collegare gli uni agli altri per ottenere lunghezze maggiori. Massimo 20 metri.

2 meters prolongation cable for LED modules with fast connection. Can be connected with each other to greater length. 20 meters max.

Alimentatore / Power Supply

Installazione in Controsoffitti Installation in False Ceiling

PS

Elettronico 25W / Electronic 25W
Alimentazione elettrica / Power supply
LED. 25W – 24V. 100-240V, 50-60Hz.

60.8703

Elettronico 60W / Electronic 60W
Alimentazione elettrica / Power supply
LED. 60W – 24V. 100-240V, 50-60Hz.

60.9089

Elettronico 120W / Electronic 120W
Alimentazione elettrica / Power supply
LED. 120W – 24V. 100-240V, 50-60Hz.

RF28688





Installazione Remota in Quadro Elettrico Remote Installation Electrical Panel

PS

Elettronico 240W / Electronic 240W
Alimentazione elettrica / Power supply
LED. 240W – 24V. 100-240V, 50-60Hz.

60.8268

Schema di Installazione / Installation Guidelines

	White					RGB				
	20W	60W	100W	150W	240W	20W	60W	100W	150W	240W
Lunghezza massima LED* Max length LED*	1m	3,5m	5,5m	8m	13m	2m	8m	12m	20m	34m
Sezione cavo (fornito dall'installatore) Cable section (Installer provides)	0,5mm ²	0,5mm ²	0,75mm ²	0,75mm ²	1mm ²	0,5mm ²	0,5mm ²	0,75mm ²	0,75mm ²	1mm ²
Distanza massima Max distance	 5m	10m	15m	30m	50m	5m	10m	15m	30m	50m
Distanza massima Max distance		20m				20m				
Distanza massima Max distance		20m				20m				
Massima lunghezza moduli LED collegati con Max length LED connected to		2m				7m				
Massima lunghezza moduli LED collegati con Max length LED connected to		4m				14m				

* Attenzione: Per Softprofile, 2x lunghezza del LED = lunghezza del profilo / Beware: For Softprofile, 2x LED length = profile length



Juncos

Juncos 1L



Juncos 3L



Juncos 6L



Juncos 9L



Wall Piercing

Wall Piercing 1X



Wall Piercing 2X



Wall Piercing 4X



Wall Piercing 2X Line



Soft Spun

Soft Spun Small
Halogen/ Fluorescent/
LED



Soft Spun Large
Halogen/ Fluorescent/
LED



Abajourd'hui

Abajourd'hui Small



Abajourd'hui Large



Juncos Designed By Flos Soft Architecture

Juncos 1L

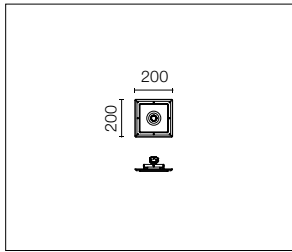

Apparecchio di illuminazione LED per interni a semi-incasso che, grazie alla tecnologia Soft Architecture, si integra perfettamente nello spazio architettonico. Fonte di alimentazione non inclusa. Consultare drivers nella pagina seguente.

Semi-recessed LED luminaire for indoor applications. Seamless integration in the architectural environment by Soft Architecture technology. Power supply not included. See drivers in next page.

Prodotto precabato per essere collegato a corrente costante.

Pre-wired product to be connected to constant current.

Juncos 3L

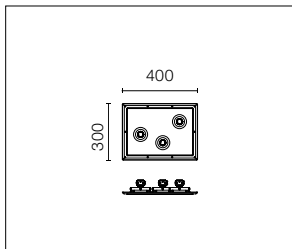

Prodotto precabato in serie per essere collegato a corrente costante.

Pre-wired product for serial connection to constant current.

Juncos 6L

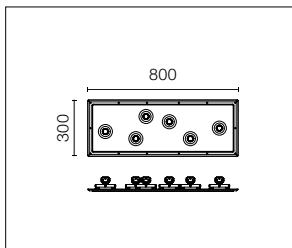

Prodotto precabato in serie per essere collegato a corrente costante.

Pre-wired product for serial connection to constant current.

Juncos 9L

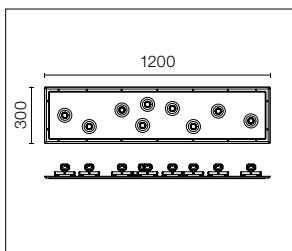
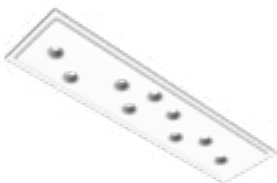

Prodotto precabato in serie per essere collegato a corrente costante.

Pre-wired product for serial connection to constant current.

Piastra Soft / Soft Plate

Juncos 1L

SA.5200.5.120

Juncos 3L

SA.5201.5.120

Juncos 6L

SA.5202.5.120

Juncos 9L

SA.5203.5.120

Junco 250 mm

Light Source: Power LED DC 700 mA - 2,1W - 216 lm - 3000K/CRI 80 / 2,1W - 182 lm- 2700K/CRI 90

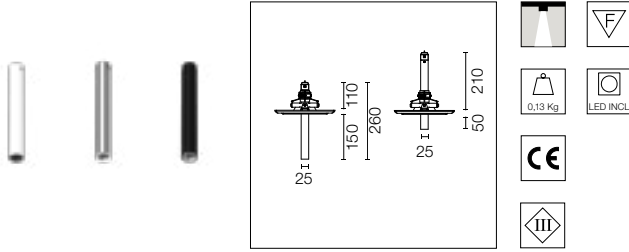

Apparecchio di illuminazione che offre una grande versatilità. Individualmente orientabile e con grado di incasso regolabile. Disponibile in rifiniture nere, bianche e cromate.

Luminaire that offers many possibilities. Can be individually focused and their recessed height is adjustable. Available in a black, white and chrome finish.

Junco 400 mm

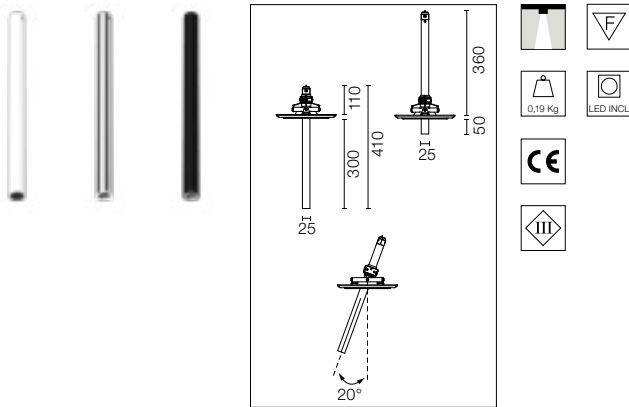

Junco 250 mm 2700K

- 08.8595.40A
- 08.8595.06A
- 08.8595.AAA

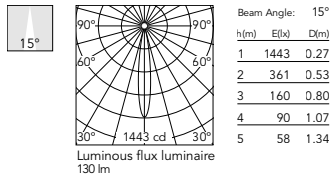

3000K

- 08.8590.40A
- 08.8590.06A
- 08.8590.AAA

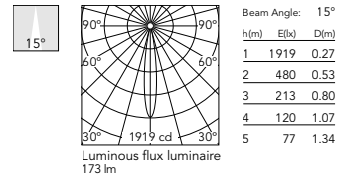

Junco 400 mm 2700K

- 08.8596.40A
- 08.8596.06A
- 08.8596.AAA

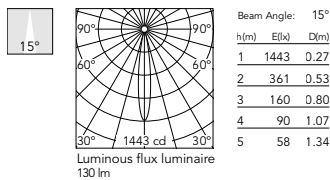

3000K

- 08.8591.40A
- 08.8591.06A
- 08.8591.AAA

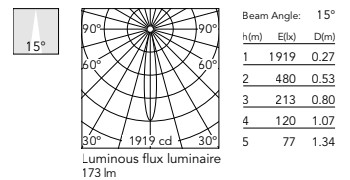

Driver / Drivers

Fonte di alimentazione a corrente costante di 17W, 700mA - 100/240V - 50/60Hz.

Non dimmable continuous current power supply of 17W, 700mA - 100/240V - 50/60Hz.

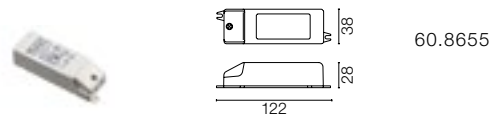

Fonte di alimentazione a corrente costante di 32W, 700mA - 220/240V - 50/60Hz.

Non dimmable continuous current power supply of 32W, 700mA - 220/240V - 50/60Hz.

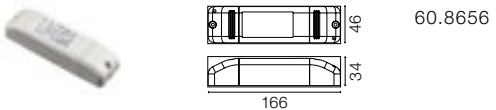

Fonte di alimentazione a corrente costante 25W, 120-240V / 50-60Hz con corrente di alimentazione selezionabile tramite switch 700mA regolabile 1-10V o push dimming.

Continuous current power supply of 25W, 120-240V - 50/60Hz with power current selected through adjustable 700mA 1-10V switch or push dimming.

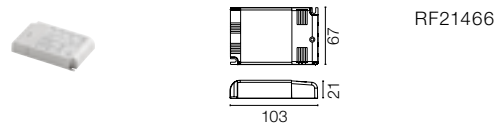

Distanza massima del dispositivo LED / Max. distance from LED driver

Dispositivo a corrente costante / constant current driver (700ma)

Distanza / Distance	10 m	20 m	50 m
Sezione del cavo / Cable section	0,5mm ²	1mm ²	2,5mm ²

Wall Piercing 1X Designed By Ron Gilad

Light Source: LED White 1x6,4W - 416 lm - 2700K/CRI>90 / LED RGB 1x7,4W

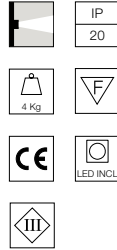
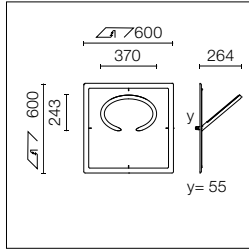

Apparecchio a semi-incasso da installare a soffitto o a parete. Disponibile nelle versioni a led bianco o RGB. Alimentatore e regolatori non compresi.

Moduli LED RGB inclusi. Per l'alimentatore e l'interfaccia di attenuazione vedi driver LED.

Soft technology semi-recessed luminaire for ceiling or wall mounting. Available in white LED or RGB versions. Control gear not included.

LED modules included. For power supply and dimming interface see LED drivers.

LED White
 SA.5020.5A120
 SA.5020.5A180

LED RGB
 SA.5020.6A120
 SA.5020.6A180

Wall Piercing 2X Designed By Ron Gilad

Light Source: LED White 2x6,4W - 2x416 lm - 2700K/CRI>90 / LED RGB 2x7,4W

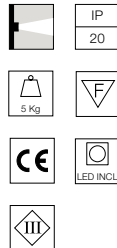
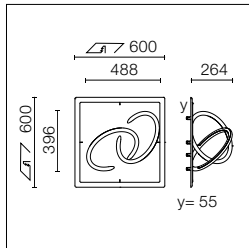

Apparecchio a semi-incasso da installare a soffitto o a parete. Disponibile nelle versioni a led bianco o RGB. Alimentatore e regolatori non compresi.

Moduli LED RGB inclusi. Per l'alimentatore e l'interfaccia di attenuazione vedi driver LED.

Soft technology semi-recessed luminaire for ceiling or wall mounting. Available in white LED or RGB versions. Control gear not included.

LED modules included. For power supply and dimming interface see LED drivers.

LED White
 SA.5021.5A120
 SA.5021.5A180

LED RGB
 SA.5021.6A120
 SA.5021.6A180

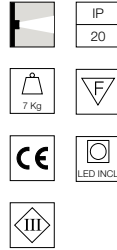
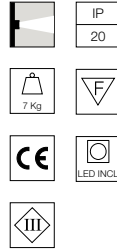
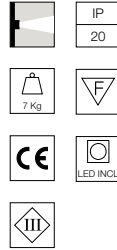
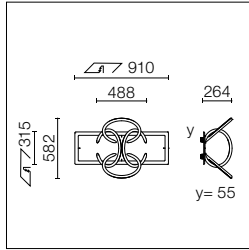

Wall Piercing 4X Designed By Ron Gilad**Light Source:** LED White 4x6,4W - 4x416 lm - 2700K/CRI>90 / LED RGB 4x7,4W

Apparecchio a semi-incasso da installare a soffitto o a parete. Disponibile nelle versioni a led bianco o RGB. Alimentatore e regolatori non compresi.

Moduli LED RGB inclusi. Per l'alimentatore e l'interfaccia di attenuazione vedi driver LED.

Soft technology semi-recessed luminaire for ceiling or wall mounting. Available in white LED or RGB versions. Control gear not included.

LED modules included. For power supply and dimming interface see LED drivers.

LED White
 SA.5022.5A120
 SA.5022.5A180

LED RGB
 SA.5022.6A120
 SA.5022.6A180

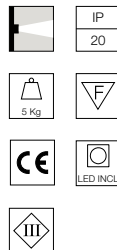
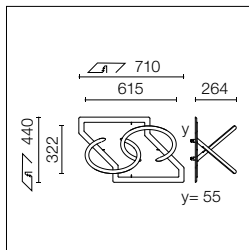
Wall Piercing 2X Line Designed By Ron Gilad**Light Source:** LED White 2x6,4W - 2x416 lm - 2700K/CRI>90 / LED RGB 2x7,4W

Apparecchio a semi-incasso da installare a soffitto o a parete. Disponibile nelle versioni a led bianco o RGB. Alimentatore e regolatori non compresi.

Moduli LED RGB inclusi. Per l'alimentatore e l'interfaccia di attenuazione vedi driver LED.

Soft technology semi-recessed luminaire for ceiling or wall mounting. Available in white LED or RGB versions. Control gear not included.

LED modules included. For power supply and dimming interface see LED drivers.

LED White
 SA.5023.5A120
 SA.5023.5A180

LED RGB
 SA.5023.6A120
 SA.5023.6A180



SOFT ARCHITECTURE | 3D

LED DRIVERS

For Wall Piercing

Non Dimmable

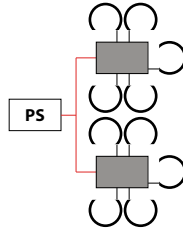

Cablaggio Wiring

Distributore maschio a 5 poli a connessione rapida con il cavo di alimentazione. È in grado di connettere fino a 5 Wall Piercing. Alimentatore elettronico non incluso.

5 male pole distributor for easy connection with feed cable. It's able to connect up to 5 Wall Piercings. Electronic power supply not included.

White

06.1003.00

Dimmable 1-10V

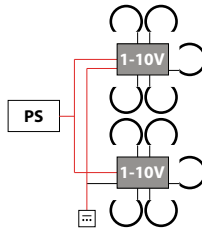

Interfacce Dimmerabili Dimmable Interfaces

Interfaccia 1-10V. Distributore a 5 poli a connessione rapida integrato. È in grado di connettere fino a 5 Wall Piercing. Alimentatore elettronico non incluso.

1-10V interface. 5 pole distributor for easy connection integrated. It's able to connect up to 5 Wall Piercings. Electronic power supply not included.

White

06.1011.00

1-10V

Interfacce Dimmerabili Dimmable Interfaces

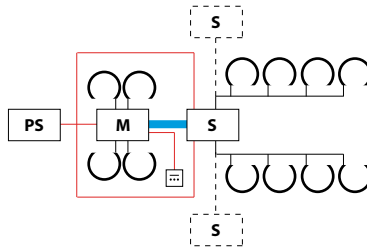

Interfaccia Master DALI con distributore a 5 poli a connessione rapida, integrato. È in grado di controllare fino a 5 Wall Piercing. Se sono presenti nello stesso impianto altri Wall Piercing, è necessario espandere il segnale con interfacce Slave. Alimentatore elettronico non incluso.

DALI Master interface with 5 pole distributor for easy connection integrated. It's able to control up to 5 Wall Piercing. If more Wall Piercings are in the same installation it's necessary to expand the signal with Slave interfaces. Electronic power supply not included.

White

06.1019.00

M

RGB

06.1012.00

M

Interfaccia Master DMX con distributore a 5 poli a connessione rapida integrato. È in grado di comandare fino a 5 Wall Piercing. Se vi sono altri Wall Piercing nello stesso impianto, è necessario espandere il segnale con interfacce Slave. Alimentatore elettronico non incluso.

DMX Master interface with 5 pole distributor for easy connection integrated. It's able to control up to 5 wall piercing. If more Wall Piercings are in the same installation it's necessary to expand the signal with Slave interfaces. Electronic power supply not included.

06.1005.00

M

— Fornito dall'installatore / Installer provides

SOFT ARCHITECTURE | 3D

LED DRIVERS

For Wall Piercing

Interfacce Dimmerabili Dimmable Interfaces

Interfaccia Master RGB a radiofrequenza (RF) con un distributore a 5 poli integrato per una facile connessione. Trasmettitore a parete per effettuare i cambi di colore, integrato. È in grado di comandare fino a 5 Wall Piercing. Se vi sono altri Wall Piercing nello stesso impianto, è necessario espandere il segnale con interfacce Slave. Alimentatore elettronico non incluso.

Radio Frequency (RF) RGB Master interface with 5 pole distributor for easy connection integrated. Wall transmitter to make color changing integrated. It's able to control up to 5 Wall Piercings. If more Wall Piercings are in the same installation it's necessary to expand the signal with Slave interfaces. Electronic power supply not included.

White

RGB

06.1013.00

M

Interfaccia Slave per espandere il segnale DALI/DMX/RF con due distributori a 5 poli a connessione rapida. È in grado di espandere il segnale Master in 10 Wall Piercing. Se vi sono altri Wall Piercing nello stesso impianto è necessario espandere il segnale con altre interfacce Slave. Alimentatore elettronico non incluso.

Slave interface to expand the DALI/DMX/RF signal with two 5 pole distributors for easy connection. It's able to expand the Master signal in 10 Wall Piercings. If more Wall Piercings are in the same installation it's necessary to expand the signal with more Slave interfaces. Electronic power supply not included.

06.1020.00

S

06.1014.00

S

Cavo prolunga da 2 metri per moduli LED con connessione rapida. Si possono collegare gli uni agli altri per ottenere lunghezze maggiori. Massimo 20 metri.

2 meters prolongation cable for LED modules with fast connection. Can be connected with each other to greater length. 20 meters max.

08.8297.00

08.8298.00

Alimentatore / Power Supply

Installazione in Controsoffitti Installation in False Ceiling

PS

Elettronico 25W / Electronic 25W

Alimentazione elettrica / Power supply
LED. 25W – 24V. 100-240V, 50-60Hz.

60.8703

Elettronico 60W / Electronic 60W

Alimentazione elettrica / Power supply
LED. 60W – 24V. 100-240V, 50-60Hz.

60.9089

Elettronico 120W / Electronic 120W

Alimentazione elettrica / Power supply
LED. 120W – 24V. 100-240V, 50-60Hz.

RF28688

Installazione Remota in Quadro Elettrico Remote Installation Electrical Panel

PS



Elettronico 240W / Electronic 240W

Alimentazione elettrica / Power supply
LED. 240W – 24V. 100-240V, 50-60Hz.

60.8268

Schema di Installazione Installation Guidelines

White/RGB

		20W	60W	100W	150W	240W
Wall Piercing		2	8	13	20	32
Sezione cavo (fornito dall'installatore) Cable section (Installer provides)		0,5mm ²	0,5mm ²	0,75mm ²	0,75mm ²	1mm ²
Distanza massima Max distance		5m	10m	15m	30m	50m
Distanza massima Max distance		20m				
Distanza massima Max distance		20m				

Soft Spun Halogen Small Designed By Sebastian Wrong

Light Source: LED QT-DE-12 1xR7s

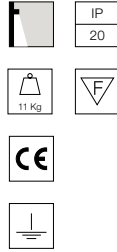
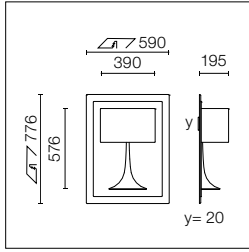

Apparecchio da incasso con alimentazione in tensione di rete per lampada LED Retrofit.

Recessed luminaire with main voltage source for LED Retrofit lamp.

Vedi catalogo Flos Decorative Collection.

See Flos Decorative Collection catalogue.

SA.5005.1

Soft Spun Halogen Large Designed By Sebastian Wrong

Light Source: LED QT-DE-12 1xR7s (diffuser) / LED White 1,4W - 80 lm - 2700K/CRI>90 (base)

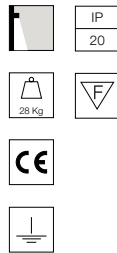
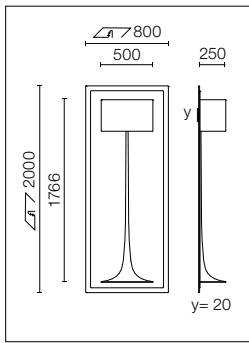

Apparecchio da incasso con alimentazione in tensione di rete per lampada LED Retrofit. Driver LED elettronico 220-240 V / 50-60 Hz integrato.

Recessed luminaire with main voltage source for LED Retrofit lamp. Electronic LED driver 220-240V / 50-60Hz integrated.

Vedi catalogo Flos Decorative Collection.

See Flos Decorative Collection catalogue.

SA.5009.1

Soft Spun Fluorescent Small Designed By Sebastian Wrong

Light Source: TC-L 2x2G11 - 18W

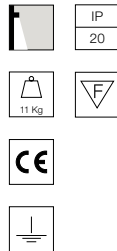
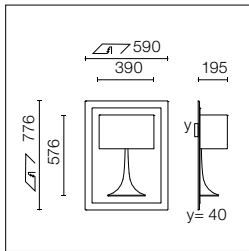

Apparecchio ad incasso per lampada fluorescente. Alimentatori 220/240V non dimmerabili compresi.

Recessed luminaire for fluorescent lamp. Non-dimmable 220/240V ballasts included.

Vedi catalogo Flos Decorative Collection.

See Flos Decorative Collection catalogue.

SA.5004.1

Soft Spun Fluorescent Large Designed By Sebastian Wrong

Light Source: TC-L 2x2G11 - 24W (diffuser) / LED White 1,4W - 80 lm - 2700K/CRI>90 (base)

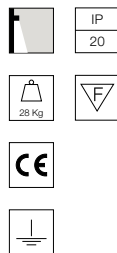
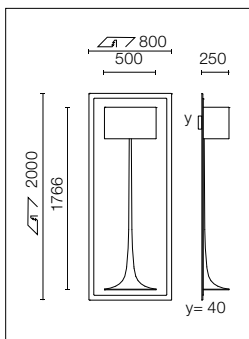

Apparecchio ad incasso per lampada fluorescente. Alimentatori 220/240V non dimmerabili compresi.

Recessed luminaire for fluorescent lamp. Non-dimmable 220/240V ballasts included.

Vedi catalogo Flos Decorative Collection.

See Flos Decorative Collection catalogue.

SA.5008.1

Soft Spun LED Small Designed By Sebastian Wrong

Light Source: LED White 35W - 1800 lm - 3000K/CRI 90

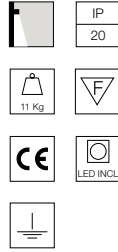
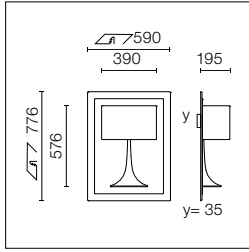

Apparecchio ad incasso per lampada LED. Alimentatori 220/240V non dimmerabili compresi.

Recessed luminaire for LED lamp. Non-dimmable 220/240V power supply included.

Vedi catalogo Flos Decorative Collection.

See Flos Decorative Collection catalogue.

SA.5006.1F

Soft Spun LED Large Designed By Sebastian Wrong

Light Source: LED White 35W - 1800 lm - 3000K/CRI 90 (diffuser) / LED White 1,4W - 80 lm - 2700K/CRI>90 (base)

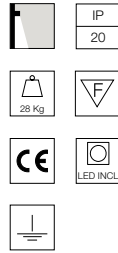
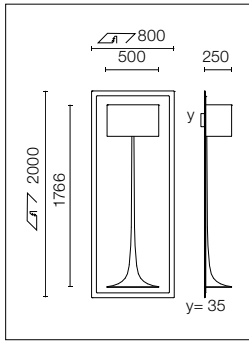

Apparecchio ad incasso per lampada LED. Alimentatori 220/240V non dimmerabili compresi.

Recessed luminaire for LED lamp. Non-dimmable 220/240V power supply included.

Vedi catalogo Flos Decorative Collection.

See Flos Decorative Collection catalogue.

SA.5007.1F

Abajourd'hui Small Designed By Flos Soft Architecture

Light Source: QT-32 E27 - max 75W

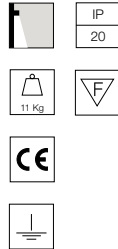
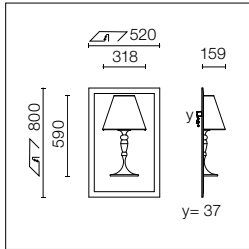

Apparecchio ad incasso con alimentazione diretta dalla rete. Fonte di luce esclusa. Da ordinare separatamente.

Recessed luminaire with direct connection to mains. Excluded light source. To be ordered separately.

Vedi catalogo Flos Decorative Collection.

See Flos Decorative Collection catalogue.

SA.5001.1

Abajourd'hui Large Designed By Flos Soft Architecture

Light Source: QT-32 E27 - max 150W

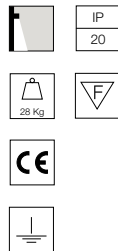
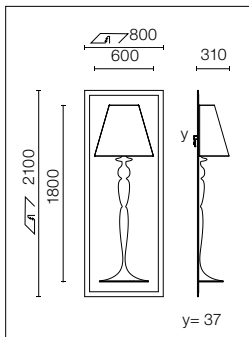

Apparecchio ad incasso con alimentazione diretta dalla rete.

Recessed luminaire with direct connection to mains.

Vedi catalogo Flos Decorative Collection.

See Flos Decorative Collection catalogue.

SA.5000.1



Uso Boob

USO Boob 600 1L



USO Boob 600 for Modular Ceiling



USO Boob 600 2L



USO Boob 100 1L



USL Out

USL 6031



USL 6031 Recessed



USL 6060 for Modular Ceiling



USO Boob 600 1L Designed By Flos Soft Architecture

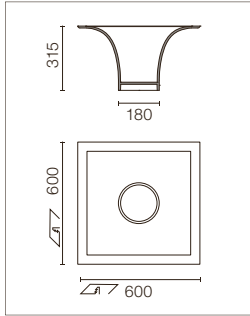

Applicazione architettonica con tecnologia Soft che permette una perfetta integrazione dei prodotti Flos architectural.
Per le configurazioni personalizzate, è possibile aggiungere punti luce nella struttura. Contattare gli uffici commerciali Flos architectural.

Soft technology architectural application that permits perfect integration of the Flos architectural products.
For personal configuration, you can add light points in the structure. Ask Flos architectural sales team.

I codici non comprendono i prodotti della collezione Flos architectural.

References do not include Flos architectural products.

- SA.1014.3.001
- SA.1014.3.102
- SA.1014.3.003
- SA.1014.3.004
- SA.1014.3.006
- SA.1014.3.009

- SA.1014.3.014
- SA.1014.3.015
- SA.1014.3.116
- SA.1014.3.025
- SA.1014.3.026
- SA.1014.3.027

Prodotti della Collezione Flos architectural Consigliati / Flos architectural Recommended Products

Light Sniper	Easy Kap Ø105	Wan Downlight	Wan Spot	Pure Downlight 1 NT*	Compass Ø162	Kap Ø145*	Pure Downlight 1 T	Kap Ø105*	
SA.1014.3.001	SA.1014.3.102	SA.1014.3.003	SA.1014.3.004	SA.1014.3.006	SA.1014.3.009	SA.1014.3.014	SA.1014.3.015	SA.1014.3.116	
Decofix 1L Round	Light Soldier Fixed	Light Soldier Adjustable	* Cornice No Trim compresa / Frame No Trim included Cornice No Trim non compresa. Da ordinare separatamente / No Trim Frame excluded. To be ordered separately						
									SA.1014.3.025

USO Boob 600 For Modular Ceiling Designed By Flos Soft Architecture

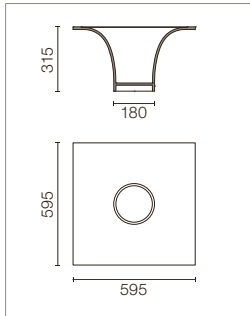

Applicazione architettonica con tecnologia Soft che permette una perfetta integrazione dei prodotti Flos architectural.
Per le configurazioni personalizzate, è possibile aggiungere punti luce nella struttura. Contattare gli uffici commerciali Flos architectural.

Soft technology architectural application that permits perfect integration of the Flos architectural products.
For personal configuration, you can add light points in the structure. Ask Flos architectural sales team.

I codici non comprendono i prodotti della collezione Flos architectural.

References do not include Flos architectural products.

- SA.1019.3.001
- SA.1019.3.102
- SA.1019.3.003
- SA.1019.3.004
- SA.1019.3.006
- SA.1019.3.009

- SA.1019.3.014
- SA.1019.3.015
- SA.1019.3.116
- SA.1019.3.025
- SA.1019.3.026
- SA.1019.3.027

Prodotti della Collezione Flos architectural Consigliati / Flos architectural Recommended Products

Light Sniper	Easy Kap Ø105	Wan Downlight	Wan Spot	Pure Downlight 1 NT*	Compass Ø162	Kap Ø145*	Pure Downlight 1 T	Kap Ø105*	
SA.1019.3.001	SA.1019.3.102	SA.1019.3.003	SA.1019.3.004	SA.1019.3.006	SA.1019.3.009	SA.1019.3.014	SA.1019.3.015	SA.1019.3.116	
Decofix 1L Round	Light Soldier Fixed	Light Soldier Adjustable	* Cornice No Trim compresa / Frame No Trim included Cornice No Trim non compresa. Da ordinare separatamente / No Trim Frame excluded. To be ordered separately						
									SA.1019.3.025

USO Boob 600 2L Designed By Flos Soft Architecture

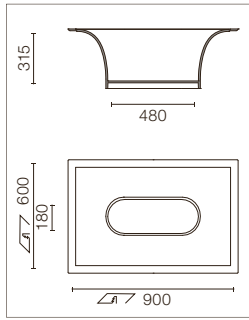
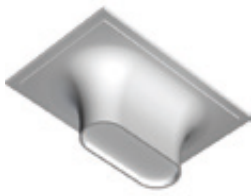

Applicazione architettonica con tecnologia Soft che permette una perfetta integrazione dei prodotti Flos architectural.
Per le configurazioni personalizzate, è possibile aggiungere punti luce nella struttura. Contattare gli uffici commerciali Flos architectural.

Soft technology architectural application that permits perfect integration of the Flos architectural products.
For personal configuration, you can add light points in the structure. Ask Flos architectural sales team.

I codici non comprendono i prodotti della collezione Flos architectural.

References do not include Flos architectural products.

SA.1015.3.001
SA.1015.3.102
SA.1015.3.003
SA.1015.3.004
SA.1015.3.006
SA.1015.3.009

SA.1015.3.014
SA.1015.3.015
SA.1015.3.116
SA.1015.3.025
SA.1015.3.026
SA.1015.3.027

Prodotti della Collezione Flos architectural Consigliati / Flos architectural Recommended Products

Light Sniper	Easy Kap Ø105	Wan Downlight	Wan Spot	Pure Downlight 1 NT*	Compass Ø162	Kap Ø145*	Pure Downlight 1 T	Kap Ø105*	
SA.1015.3.001	SA.1015.3.102	SA.1015.3.003	SA.1015.3.004	SA.1015.3.006	SA.1015.3.009	SA.1015.3.014	SA.1015.3.015	SA.1015.3.116	
Decofix 1L Round	Light Soldier Fixed	Light Soldier Adjustable	* Cornice No Trim compresa / Frame No Trim included Cornice No Trim non compresa. Da ordinare separatamente / No Trim Frame excluded. To be ordered separately						
SA.1015.3.025	SA.1015.3.026	SA.1015.3.027							

Use Boob 100 1L Designed By Flos Soft Architecture

Light Source: LED QR-CBC-51 1xGU5.3

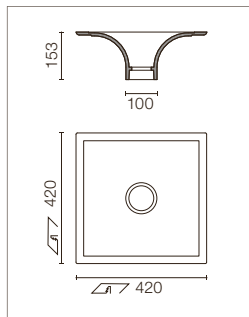

Apparecchio da incasso per lampada LED Retrofit 12V. Trasformatore remoto non compreso: trasformatore elettronico 12V. 220/240V, 50/60Hz. Possibilità di regolazione tramite dimmer "leading and trailing edge".

Recessed luminaire for 12V LED Retrofit lamp. Remote transformer not included: electronic transformer 12V. 220/240V, 50/60Hz. Adjustable by means of "leading and trailing edge".

SA.1012.3.019

Elettrico / Electrical
50/70W
60.9398
105W
60.9424

SOFT ARCHITECTURE | OUT

USL 6031 Designed By Flos Soft Architecture

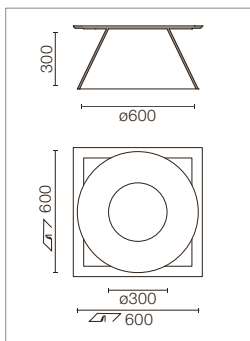

Applicazione architettonica con tecnologia Soft che permette una perfetta integrazione dei prodotti Flos architectural.
Per le configurazioni personalizzate, è possibile aggiungere punti luce nella struttura. Contattare gli uffici commerciali Flos architectural.

Soft technology architectonic application that permits perfect integration of the Flos architectural products.
For personal configuration, you can add light points in the structure. Ask Flos architectural sales team.

I codici non comprendono i prodotti della collezione Flos architectural.

References do not include Flos architectural products.

SA.4008.3.001
SA.4008.3.102
SA.4008.3.003
SA.4008.3.004
SA.4008.3.009

SA.4008.3.015
SA.4008.3.017
SA.4008.3.025
SA.4008.3.026
SA.4008.3.027

Prodotti della Collezione Flos architectural Consigliati / Flos architectural Recommended Products

Light Sniper	Easy Kap Ø105	Wan Downlight	Wan Spot	Compass Ø162	Pure Downlight 1 T	Kap Ø145 165mm Hole	Decofix 1L Round	Light Soldier Fixed
SA.4008.3.001 h=165	SA.4008.3.102 h=187	SA.4008.3.003 h=111	SA.4008.3.004 h=50	SA.4008.3.009 h=220	SA.4008.3.015 h=135	SA.4008.3.017 h=230	SA.4008.3.025 h=126	SA.4008.3.026 h=72
Light Soldier Adjustable								
SA.4008.3.027 h=72								

USL 6031 Recessed Designed By Flos Soft Architecture

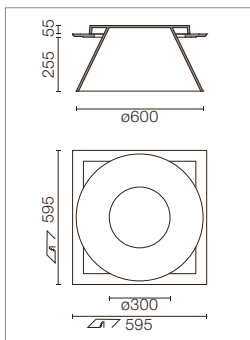

Applicazione architettonica con tecnologia Soft che permette una perfetta integrazione dei prodotti Flos architectural.
Per le configurazioni personalizzate, è possibile aggiungere punti luce nella struttura. Contattare gli uffici commerciali Flos architectural.

Soft technology architectonic application that permits perfect integration of the Flos architectural products.
For personal configuration, you can add light points in the structure. Ask Flos architectural sales team.

I codici non comprendono i prodotti della collezione Flos architectural.

References do not include Flos architectural products.

SA.4010.3.001
SA.4010.3.102
SA.4010.3.003
SA.4010.3.004
SA.4010.3.009

SA.4010.3.015
SA.4010.3.017
SA.4010.3.025
SA.4010.3.026
SA.4010.3.027

Prodotti della Collezione Flos architectural Consigliati / Flos architectural Recommended Products

Light Sniper	Easy Kap Ø105	Wan Downlight	Wan Spot	Compass Ø162	Pure Downlight 1 T	Kap Ø145 165mm Hole	Decofix 1L Round	Light Soldier Fixed
SA.4010.3.001 h=220	SA.4010.3.102 h=242	SA.4010.3.003 h=166	SA.4010.3.004 h=105	SA.4010.3.009 h=275	SA.4010.3.015 h=190	SA.4010.3.017 h=285	SA.4010.3.025 h=181	SA.4010.3.026 h=127
Light Soldier Adjustable								
SA.4010.3.027 h=127								

USL 6060 for Modular Ceiling Designed By Flos Soft Architecture

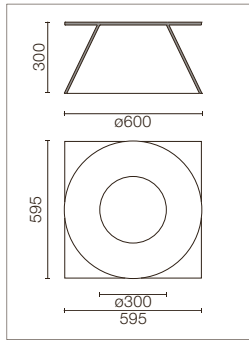
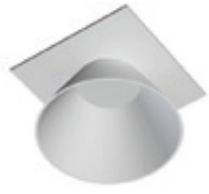

Applicazione architettonica con tecnologia Soft che permette una perfetta integrazione dei prodotti Flos architectural.
Per le configurazioni personalizzate, è possibile aggiungere punti luce nella struttura. Contattare gli uffici commerciali Flos architectural.

Soft technology architectural application that permits perfect integration of the Flos architectural products.
For personal configuration, you can add light points in the structure. Ask Flos architectural sales team.











I codici non comprendono i prodotti della collezione Flos architectural.

References do not include Flos architectural products.

- SA.4009.3.001
- SA.4009.3.102
- SA.4009.3.003
- SA.4009.3.004
- SA.4009.3.009

- SA.4009.3.015
- SA.4009.3.017
- SA.4009.3.025
- SA.4009.3.026
- SA.4009.3.027

Prodotti della Collezione Flos architectural Consigliati / Flos architectural Recommended Products

Light Sniper	Easy Kap Ø105	Wan Downlight	Wan Spot	Compass Ø162	Pure Downlight 1 T	Kap Ø145 165mm Hole	Decofix 1L Round	Light Soldier Fixed
								
SA.4009.3.001 h=165	SA.4009.3.102 h=187	SA.4009.3.003 h=111	SA.4009.3.004 h=50	SA.4009.3.009 h=220	SA.4009.3.015 h=135	SA.4009.3.017 h=230	SA.4009.3.025 h=126	SA.4009.3.026 h=72
Light Soldier Adjustable								
								
SA.4009.3.027 h=72								







<p>Apps</p> 	<p>G-O In</p> 	<p>Teardrop</p> <p>Small / Medium / Large</p> 
--	--	--

<p>USO</p>	<p>USO Kap 105 / 145</p> 	<p>USO 332</p> 	<p>USO 700</p> 	<p>USO 800</p> 	<p>USO 1000</p> 	<p>USO 1400</p> 
-------------------	--	--	--	---	---	---

<p>USO Cove Lighting</p>	<p>USO 900 Cove Lighting</p> 	<p>USO 1700 Cove Lighting</p> 	<p>USO 2200 Cove Lighting</p> 	<p>USO 2500 Cove Lighting</p> 	<p>USO 100 50 Cove Lighting</p> 	<p>USO 140 90 Cove Lighting</p> 
---------------------------------	--	---	---	--	---	---

<p>Round Light</p> <p>Small / Medium / Large</p> 	<p>Square Light</p> <p>Small / Large</p> 	<p>Vertical Light</p> <p>Small / Large</p> 
--	--	--

<p>USB Round</p>	<p>USB Round 1L</p> 	<p>USB Round 1L W-W</p> 	<p>USB Round 2L</p> 	<p>USB Round 2L W-W</p> 
-------------------------	---	---	---	--

<p>USB Square</p>	<p>USB Square 1L</p> 	<p>USB Square 1L W-W</p> 	<p>USB Square 2L</p> 	<p>USB Square 2L W-W</p> 
--------------------------	--	--	--	---

Apps Designed By Jorge Herrera

Light Source: LED Array 4W - 350 lm - 4000K/CRI 80

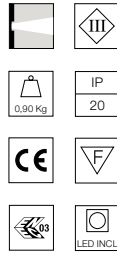
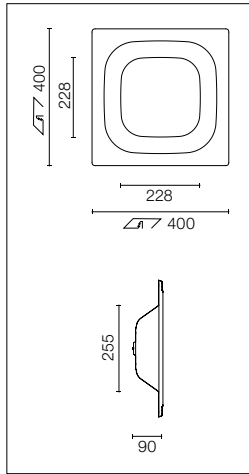

Apparecchio di segnalazione ad incasso per applicazioni in interni. Alimentatore non compreso: fonte di alimentazione a corrente costante 350mA. 220/240V, 50/60Hz.

Recessed sign luminaire for indoor application. Power supply source not included: continuous current power supply of 350mA. 220/240V, 50/60Hz.

- 90° DIR**
 SA.5061.3.076
 SA.5061.3.0OG
 SA.5061.3.0V3

- 45° DIR**
 SA.5062.3.076
 SA.5062.3.0OG
 SA.5062.3.0V3

- WC Ladies**
 SA.5063.3.076
 SA.5063.3.0OG
 SA.5063.3.0V3

- WC Men**
 SA.5064.3.076
 SA.5064.3.0OG
 SA.5064.3.0V3

- WC**
 SA.5065.3.076
 SA.5065.3.0OG
 SA.5065.3.0V3

- Bar**
 SA.5066.3.076
 SA.5066.3.0OG
 SA.5066.3.0V3

- Restaurant**
 SA.5067.3.076
 SA.5067.3.0OG
 SA.5067.3.0V3

- Elevator**
 SA.5068.3.076
 SA.5068.3.0OG
 SA.5068.3.0V3

- Info**
 SA.5069.3.076
 SA.5069.3.0OG
 SA.5069.3.0V3

- Stairs**
 SA.5070.3.076
 SA.5070.3.0OG
 SA.5070.3.0V3

Elettrico / Electrical
 60.8402

Segnali Signs

90° DIR

45° DIR

WC Ladies

WC Men

Colori della Luce Perimetrale
 Peripheral Lighting Colours

76 Bianco
 76 White

OG Arancione
 OG Orange

V3 Viola
 V3 Violet



WC

Bar

Restaurant

Elevator



Info

Stairs

* Your Custom ID



* Per una configurazione personale del colore e il simbolo del segnale, consultare il team vendite di Flos architectural.
 For a personal colour scheme and sign pictogram please ask the Flos architectural sales staff.



reddot design award
 winner 2012

Apps Emergency Designed By Jorge Herrera

Light Source: LED Array 4W - 350 lm - 4000K/CRI 80

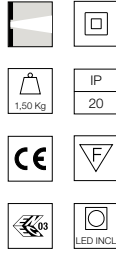
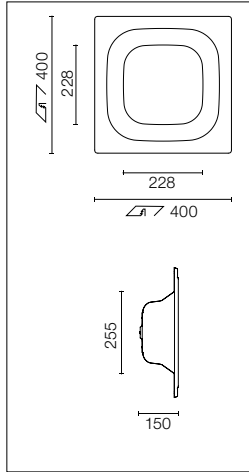

Apparecchi di segnalazione di emergenza ad incasso per applicazioni in interni. Alimentatore e dispositivo di emergenza compresi. Autonomia 4 ore, flusso 80%.

Recessed emergency sign luminaire for indoor application. Power supply source and emergency gear included. 4-hour autonomy, 80% Flow.

- 90° DIR**
SA.5071.3.076
- Exit Right**
SA.5073.3.076
- Exit**
SA.5075.3.076
- Fire Hose**
SA.5077.3.076

- 45° DIR**
SA.5072.3.076
- Exit Left**
SA.5074.3.076
- Extinguisher**
SA.5076.3.076
- Fire Alarm**
SA.5078.3.076

Segnali Signs



reddot design award
winner 2012

G-O In Designed By Jorge Herrera

Light Source: Top LED 1,2W - 24V - 105 lm - 3000K/CRI 90

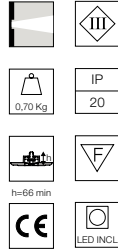
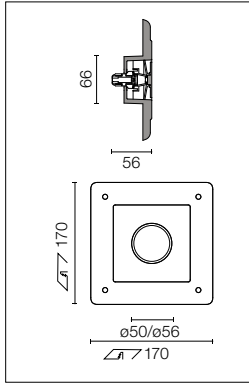

Apparecchio di segnalazione ad incasso per applicazioni in interni. Dispositivo di alimentazione non compreso: trasformatore elettronico per LED a tensione costante (24V), 220/240V, 50/60Hz. Cavo di alimentazione di 1000mm compreso.

Recessed sign luminaire for indoor application. Power supply source not included: electronic transformer with constant voltage (24V) for LED. 220/240V, 50/60Hz. It includes 1000mm power supply cable.

Luce Bianca / White Light
SA.5100.1A
Luce Ambra / Amber Light
SA.5101.1A
Luce Blu / Blue Light
SA.5102.1A

Elettrico / Electrical
8W
60.9157

**Colori della Luce
Lighting Colours**

- Bianco
White
- Ambra
Amber
- Blu
Blue



Assicurarsi della corretta polarità (+-) Ensure correct polarity (+-) Red +/- Rosso+/Nero.

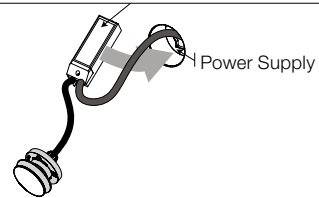

reddot design award
winner 2013

Teardrop Small Designed By Calvi Brambilla

Light Source: LED QR-CBC-51 1xGU5.3

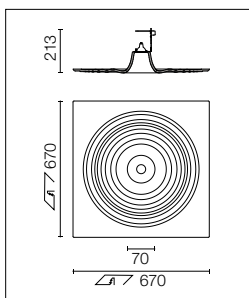
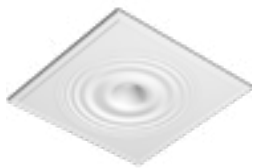

Apparecchio da incasso per lampada LED Retrofit 12V. Trasformatore remoto non compreso: trasformatore elettronico 12V. 220/240V, 50/60Hz. Possibilità di regolazione tramite dimmer "leading and trailing edge".

Recessed luminaire for 12V LED Retrofit lamp. Remote transformer not included: electronic transformer 12V. 220/240V, 50/60Hz. Adjustable by means of "leading and trailing edge".

SA.1039.1

Elettrico / Electrical
50/70W
60.9398
105W
60.9424

Teardrop Medium Designed By Calvi Brambilla

Light Source: TC-DEL 2xG24q - 26W

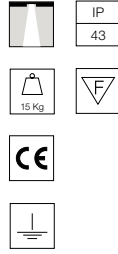
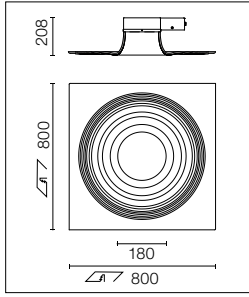

Apparecchio ad incasso per lampada fluorescente. Alimentatori non dimmerabili 220-240V / 50-60Hz compresi.

Recessed luminaire for fluorescent lamp. Non-dimmable ballasts 220-240V / 50-60Hz integrated.

SA.1040.1

Teardrop Large Designed By Calvi Brambilla

Light Source: TC-L 4x2G11 - 18W

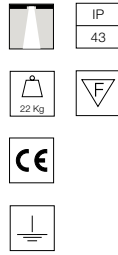
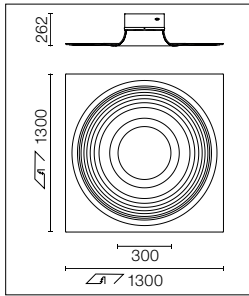

Apparecchio ad incasso per lampada fluorescente. Alimentatori non dimmerabili 220-240V / 50-60Hz compresi.

Recessed luminaire for fluorescent lamp. Non-dimmable ballasts 220-240V / 50-60Hz integrated.

SA.1041.1

USO Kap 105 Designed By Flos Soft Architecture

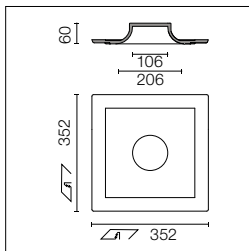

Applicazione architettonica con tecnologia Soft che permette una perfetta integrazione dei prodotti Flos architectural. Per le configurazioni personalizzate, è possibile aggiungere punti luce nella struttura. Contattare gli uffici commerciali Flos architectural.

Soft technology architectonic application that permits perfect integration of the Flos architectural products. For personal configuration, you can add light points in the structure. Ask Flos architectural sales team.

I codici non comprendono i prodotti della collezione Flos architectural.

References do not include Flos architectural products.

SA.1034.3.001
SA.1034.3.116

Prodotti della Collezione Flos architectural Consigliati / Flos architectural Recommended Products

Light Sniper	Kap Ø105*
SA.1034.3.001 h=225	SA.1034.3.116 h=290

* Cornice No Trim compresa / Frame No Trim included
Cornice No Trim non compresa. Da ordinare separatamente /
No Trim Frame excluded. To be ordered separately

USO Kap 145 Designed By Flos Soft Architecture

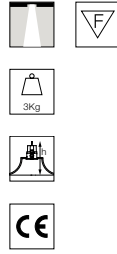
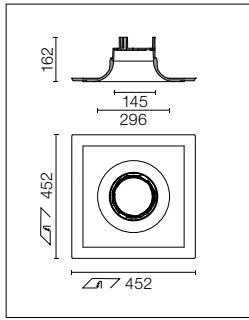

Applicazione architettonica con tecnologia Soft che permette una perfetta integrazione dei prodotti Flos architectural.
Per le configurazioni personalizzate, è possibile aggiungere punti luce nella struttura. Contattare gli uffici commerciali Flos architectural.

Soft technology architectonic application that permits perfect integration of the Flos architectural products.
For personal configuration, you can add light points in the structure. Ask Flos architectural sales team.

I codici non comprendono i prodotti della collezione Flos architectural.

References do not include Flos architectural products.

SA.1035.1

Prodotti della Collezione Flos architectural Consigliati / Flos architectural Recommended Products

Kap Ø145*

SA.1035.1
h=305

* Cornice No Trim compresa / Frame No Trim included

USO 332 Designed By Flos Soft Architecture

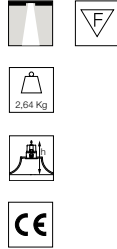
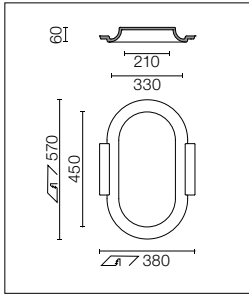

Applicazione architettonica con tecnologia Soft per soffitti modulari che permette una perfetta integrazione dei prodotti Flos architectural.
Per le configurazioni personalizzate, è possibile aggiungere punti luce nella struttura. Contattare gli uffici commerciali Flos architectural.

Soft technology architectonic application for modular ceilings that permits perfect integration of the Flos architectural products.
For personal configuration, you can add light points in the structure. Ask Flos architectural sales team.

I codici non comprendono i prodotti della collezione Flos architectural.

References do not include Flos architectural products.

SA.1001.3.001
SA.1001.3.102
SA.1001.3.003
SA.1001.3.004
SA.1001.3.006
SA.1001.3.009

SA.1001.3.014
SA.1001.3.015
SA.1001.3.116
SA.1001.3.025
SA.1001.3.026
SA.1001.3.027

Prodotti della Collezione Flos architectural Consigliati / Flos architectural Recommended Products

Light Sniper	Easy Kap Ø105	Wan Downlight	Wan Spot	Pure Downlight 1 NT*	Compass Ø162	Kap Ø145*	Pure Downlight 1 T	Kap Ø105*	
SA.1001.3.001 h=225	SA.1001.3.102 h=247	SA.1001.3.003 h=171	SA.1001.3.004 h=110	SA.1001.3.006 h=198	SA.1001.3.009 h=280	SA.1001.3.014 h=290	SA.1001.3.015 h=195	SA.1001.3.116 h=290	
Decofix 1L Round	Light Soldier Fixed	Light Soldier Adjustable	* Cornice No Trim compresa / Frame No Trim included Cornice No Trim non compresa. Da ordinare separatamente / No Trim Frame excluded. To be ordered separately						
SA.1001.3.025 h=186	SA.1001.3.026 h=132	SA.1001.3.027 h=132							

* Cornice No Trim compresa / Frame No Trim included
Cornice No Trim non compresa. Da ordinare separatamente /
No Trim Frame excluded. To be ordered separately

USO 700 Designed By Flos Soft Architecture

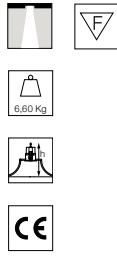
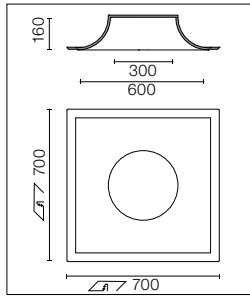

Applicazione architettonica con tecnologia Soft che permette una perfetta integrazione dei prodotti Flos architectural.
Per le configurazioni personalizzate, è possibile aggiungere punti luce nella struttura. Contattare gli uffici commerciali Flos architectural.

Soft technology architectonic application that permits perfect integration of the Flos architectural products.
For personal configuration, you can add light points in the structure. Ask Flos architectural sales team.













I codici non comprendono i prodotti della collezione Flos architectural.

References do not include Flos architectural products.

SA.1002.3.001
SA.1002.3.102
SA.1002.3.003
SA.1002.3.004
SA.1002.3.006
SA.1002.3.009

SA.1002.3.014
SA.1002.3.015
SA.1002.3.116
SA.1002.3.025
SA.1002.3.026
SA.1002.3.027

Prodotti della Collezione Flos architectural Consigliati / Flos architectural Recommended Products

Light Sniper	Easy Kap Ø105	Wan Downlight	Wan Spot	Pure Downlight 1 NT*	Compass Ø162	Kap Ø145*	Pure Downlight 1 T	Kap Ø105*
								
SA.1002.3.001 H=325	SA.1002.3.102 H=347	SA.1002.3.003 H=271	SA.1002.3.004 H=210	SA.1002.3.006 H=298	SA.1002.3.009 H=380	SA.1002.3.014 H=390	SA.1002.3.015 H=295	SA.1002.3.116 H=390
Decofix 1L Round	Light Soldier Fixed	Light Soldier Adjustable	* Cornice No Trim compresa / Frame No Trim included Cornice No Trim non compresa. Da ordinare separatamente / No Trim Frame excluded. To be ordered separately					
								
SA.1002.3.025 H=286	SA.1002.3.026 H=232	SA.1002.3.027 H=232						

USO 800 Designed By Flos Soft Architecture

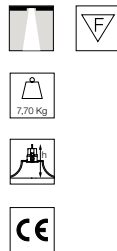
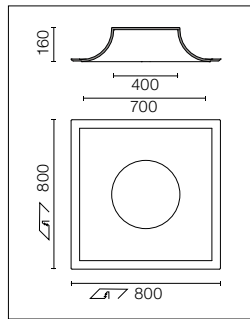

Applicazione architettonica con tecnologia Soft che permette una perfetta integrazione dei prodotti Flos architectural.
Per le configurazioni personalizzate, è possibile aggiungere punti luce nella struttura. Contattare gli uffici commerciali Flos architectural.

Soft technology architectonic application that permits perfect integration of the Flos architectural products.
For personal configuration, you can add light points in the structure. Ask Flos architectural sales team.











I codici non comprendono i prodotti della collezione Flos architectural.

References do not include Flos architectural products.

SA.1003.3.001
SA.1003.3.102
SA.1003.3.003
SA.1003.3.004
SA.1003.3.009

SA.1003.3.015
SA.1003.3.017
SA.1003.3.025
SA.1003.3.026
SA.1003.3.027

Prodotti della Collezione Flos architectural Consigliati / Flos architectural Recommended Products

Light Sniper	Easy Kap Ø105	Wan Downlight	Wan Spot	Compass Ø162	Pure Downlight 1 T	Kap Ø145 165mm Hole	Decofix 1L Round	Light Soldier Fixed
								
SA.1003.3.001 H=325	SA.1003.3.102 H=347	SA.1003.3.003 H=271	SA.1003.3.004 H=210	SA.1003.3.009 H=380	SA.1003.3.015 H=295	SA.1003.3.017 H=390	SA.1003.3.025 H=286	SA.1003.3.026 H=232
Light Soldier Adjustable								
								
SA.1003.3.027 H=232								

USO 1000 Designed By Flos Soft Architecture

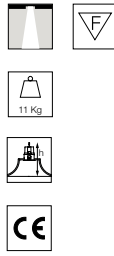
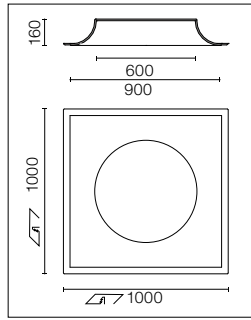

Applicazione architettonica con tecnologia Soft che permette una perfetta integrazione dei prodotti Flos architectural.
Per le configurazioni personalizzate, è possibile aggiungere punti luce nella struttura. Contattare gli uffici commerciali Flos architectural.

Soft technology architectonic application that permits perfect integration of the Flos architectural products.
For personal configuration, you can add light points in the structure. Ask Flos architectural sales team.











I codici non comprendono i prodotti della collezione Flos architectural.

References do not include Flos architectural products.

SA.1004.3.001
SA.1004.3.102
SA.1004.3.003
SA.1004.3.004
SA.1004.3.009

SA.1004.3.015
SA.1004.3.017
SA.1004.3.025
SA.1004.3.026
SA.1004.3.027

Prodotti della Collezione Flos architectural Consigliati / Flos architectural Recommended Products

Light Sniper	Easy Kap Ø105	Wan Downlight	Wan Spot	Compass Ø162	Pure Downlight 1 T	Kap Ø145 165mm Hole	Decofix 1L Round	Light Soldier Fixed
 SA.1004.3.001 H=325	 SA.1004.3.102 H=347	 SA.1004.3.003 H=271	 SA.1004.3.004 H=210	 SA.1004.3.009 H=380	 SA.1004.3.015 H=295	 SA.1004.3.017 H=390	 SA.1004.3.025 H=286	 SA.1004.3.026 H=232
Light Soldier Adjustable  SA.1004.3.027 H=232								

USO 1400 Designed By Flos Soft Architecture

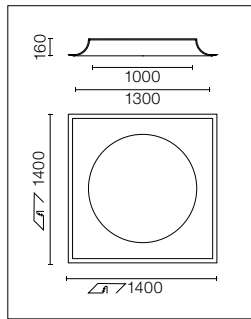

Applicazione architettonica con tecnologia Soft che permette una perfetta integrazione dei prodotti Flos architectural.
Per le configurazioni personalizzate, è possibile aggiungere punti luce nella struttura. Contattare gli uffici commerciali Flos architectural.

Soft technology architectonic application that permits perfect integration of the Flos architectural products.
For personal configuration, you can add light points in the structure. Ask Flos architectural sales team.











I codici non comprendono i prodotti della collezione Flos architectural.

References do not include Flos architectural products.

SA.1005.3.001
SA.1005.3.102
SA.1005.3.003
SA.1005.3.004
SA.1005.3.009

SA.1005.3.015
SA.1005.3.017
SA.1005.3.025
SA.1005.3.026
SA.1005.3.027

Prodotti della Collezione Flos architectural Consigliati / Flos architectural Recommended Products

Light Sniper	Easy Kap Ø105	Wan Downlight	Wan Spot	Compass Ø162	Pure Downlight 1 T	Kap Ø145 165mm Hole	Decofix 1L Round	Light Soldier Fixed
 SA.1005.3.001 H=325	 SA.1005.3.102 H=347	 SA.1005.3.003 H=271	 SA.1005.3.004 H=210	 SA.1005.3.009 H=380	 SA.1005.3.015 H=295	 SA.1005.3.017 H=390	 SA.1005.3.025 H=286	 SA.1005.3.026 H=232
Light Soldier Adjustable  SA.1005.3.027 H=232								

USO 900 Cove Lighting Designed By Flos Soft Architecture

Light Source: T5 FH 4xG5 - 21W - 7600 lm / T5 FQ 4xG5 - 39W - 12400 lm / Cold Cathode 90W - 3x30W - 7776 lm - 3000K/CRI 85
 LED White 75,6W - 21x3,6W - 7875 lm - 3000K/CRI 90 / LED RGB 75,6W - 21x3,6W

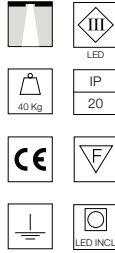
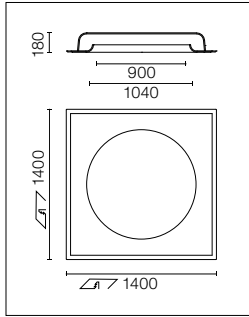

Apparecchio ad incasso da installare a soffitto. Illuminazione diretta con lampade fluorescenti, catodo freddo o LED. Nelle versioni LED, alimentatori non compresi. Vedere regolatori LED.

Recessed ceiling luminaire. Direct lighting with fluorescent, cold cathode or LED lamps. Control gear not included in LED versions.

See LED LED drivers.

T5 FH

Dimmable 1-10V
 SA.1006.4.11V
 Dimmable Dali
 SA.1006.4.1DA

Cold Cathode
 SA.1006.4.300

***LED RGB**
 SA.1006.6D100

T5 FQ

Non Dimmable
 SA.1006.4.200
 Dimmable 1-10V
 SA.1006.4.21V
 Dimmable Dali
 SA.1006.4.2DA

***LED White**
 SA.1006.5D110

USO 1700 Cove Lighting Designed By Flos Soft Architecture

Light Source: T5 FH 8xG5 - 21W - 15200 lm / T5 FQ 8xG5 - 39W - 24800 lm / Cold Cathode 161W - 4x40W - 13824 lm - 3000K/CRI 85
 LED White 136,8W - 38x3,6W - 14250 lm - 3000K/CRI 90 / LED RGB 136,8W - 38x3,6W

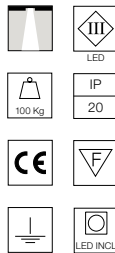
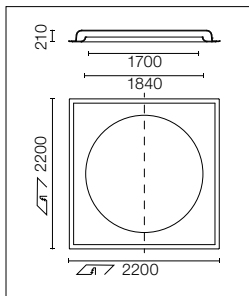

Apparecchio ad incasso da installare a soffitto. Illuminazione diretta con lampade fluorescenti, catodo freddo o LED. Nelle versioni LED, alimentatori non compresi. Vedere regolatori LED.

Recessed ceiling luminaire. Direct lighting with fluorescent, cold cathode or LED lamps. Control gear not included in LED versions.

See LED LED drivers.

Spedito in due colli.

Delivered in two pieces.

T5 FH

Dimmable 1-10V
 SA.1007.4.11V
 Dimmable Dali
 SA.1007.4.1DA

Cold Cathode
 SA.1007.4.300

***LED RGB**
 SA.1007.6D100

T5 FQ

Non Dimmable
 SA.1007.4.200
 Dimmable 1-10V
 SA.1007.4.21V
 Dimmable Dali
 SA.1007.4.2DA

***LED White**
 SA.1007.5D110

USO 2200 Cove Lighting Designed By Flos Soft Architecture

Light Source: T5 FH 8xG5 - 28W - 20800 lm / T5 FQ 8xG5 - 54W - 35600 lm / Cold Cathode 205W - 4x51W - 17568 lm - 3000K/CRI 85
LED White 180W - 50x3,6W - 18750 lm - 3000K/CRI 90 / LED RGB 180W - 50x3,6W

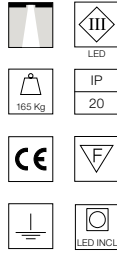
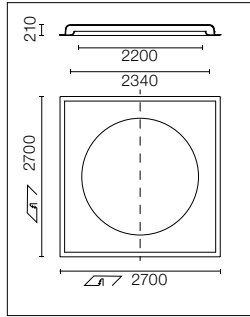

Apparecchio ad incasso da installare a soffitto. Illuminazione diretta con lampade fluorescenti, catodo freddo o LED. Nelle versioni LED, alimentatori non compresi.
Vedere regolatori LED.

Spedito in due colli.

Recessed ceiling luminaire. Direct lighting with fluorescent, cold cathode or LED lamps. Control gear not included in LED versions.

See LED LED drivers.

Delivered in two pieces.

T5 FH

Dimmable 1-10V
SA.1008.4.11V
Dimmable Dali
SA.1008.4.1DA

Cold Cathode
SA.1008.4.300

***LED RGB**
SA.1008.6D100

T5 FQ

Non Dimmable
SA.1008.4.200
Dimmable 1-10V
SA.1008.4.21V
Dimmable Dali
SA.1008.4.2DA

***LED White**
SA.1008.5D110

USO 2500 Cove Lighting Designed By Flos Soft Architecture

Light Source: T5 FH 8xG5 - 28W - 20800 lm / T5 FQ 8xG5 - 54W - 35600 lm / Cold Cathode 230W - 19728 lm - 3000K/CRI 85
LED White 194W - 54x3,6W - 20250 lm - 3000K/CRI 90 / LED RGB 194W - 54x3,6W

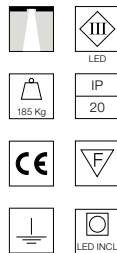
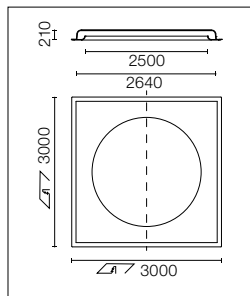

Apparecchio ad incasso da installare a soffitto. Illuminazione diretta con lampade fluorescenti, catodo freddo o LED. Nelle versioni LED, alimentatori non compresi.
Vedere regolatori LED.

Spedito in due colli.

Recessed ceiling luminaire. Direct lighting with fluorescent, cold cathode or LED lamps. Control gear not included in LED versions.

See LED LED drivers.

Delivered in two pieces.

T5 FH

Dimmable 1-10V
SA.1009.4.11V
Dimmable Dali
SA.1009.4.1DA

Cold Cathode
SA.1009.4.300

***LED RGB**
SA.1009.6D100

T5 FQ

Non Dimmable
SA.1009.4.200
Dimmable 1-10V
SA.1009.4.21V
Dimmable Dali
SA.1009.4.2DA

***LED White**
SA.1009.5D110

SOFT ARCHITECTURE | IN

USO 100 50 Cove Lighting Designed By Flos Soft Architecture

Light Source: T5 FH 4xG5 - 14W - 4800 lm / T5 FQ 4xG5 - 24W - 7000 lm / Cold Cathode 58W - 3x19W - 4968 lm - 3000K/CRI 85
LED White 57,6W - 16x3,6W - 6000 lm - 3000K/CRI 90 / LED RGB 57,6W - 16x3,6W

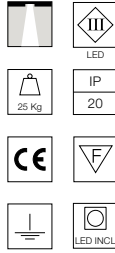
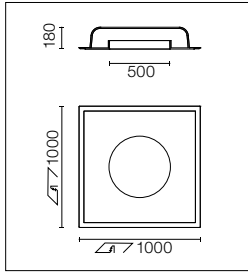

Apparecchio ad incasso da installare a soffitto. Illuminazione diretta con lampade fluorescenti, catodo freddo o LED. Nelle versioni LED, alimentatori non compresi. Vedere regolatori LED.

Recessed ceiling luminaire. Direct lighting with fluorescent, cold cathode or LED lamps. Control gear not included in LED versions.

See LED LED drivers.

T5 FH

Non Dimmable
SA.1010.4.100

T5 FQ

Non Dimmable
SA.1010.4.200

Cold Cathode

SA.1010.4.300

*LED White

SA.1010.5D110

*LED RGB

SA.1010.6D100

USO 140 90 Cove Lighting Designed By Flos Soft Architecture

Light Source: T5 FH 4xG5 - 21W - 7600 lm / T5 FQ 4xG5 - 39W - 12400 lm / Cold Cathode 90W - 3x30W - 7776 lm - 3000K/CRI 85
LED White 75,6W - 21x3,6W - 7805 lm - 3000K/CRI 90 / LED RGB 75,6W - 21x3,6W

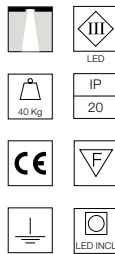
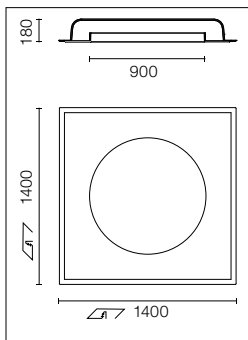

Apparecchio ad incasso da installare a soffitto. Illuminazione diretta con lampade fluorescenti, catodo freddo o LED. Nelle versioni LED, alimentatori non compresi. Vedere regolatori LED.

Recessed ceiling luminaire. Direct lighting with fluorescent, cold cathode or LED lamps. Control gear not included in LED versions.

See LED LED drivers.

Spedito in due colli.

Delivered in two pieces.

T5 FH

Dimmable 1-10V
SA.1011.4.11V
Dimmable Dali
SA.1011.4.1DA

T5 FQ

Non Dimmable
SA.1011.4.200
Dimmable 1-10V
SA.1011.4.21V
Dimmable Dali
SA.1011.4.2DA

Cold Cathode

SA.1011.4.300

*LED White

SA.1011.5D110

*LED RGB

SA.1011.6D100

Round Light Small Designed By Flos Soft Architecture

Light Source: LED White 1W - 60 lm - 3000K/CRI > 90

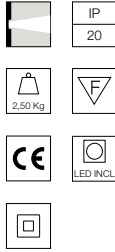
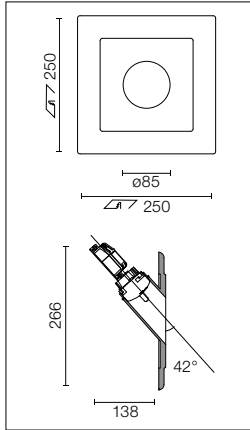

Apparecchio di segnalazione ad incasso per applicazioni in interni. Alimentatore 100/240V compreso.

Recessed sign luminaire for indoor application. 100/240V power supply source included.

SA.3010.1C

Round Light Medium Designed By Flos Soft Architecture

Light Source: LED White 7W - 720 lm - 3000K/CRI > 90

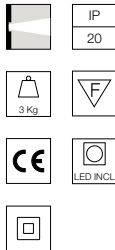
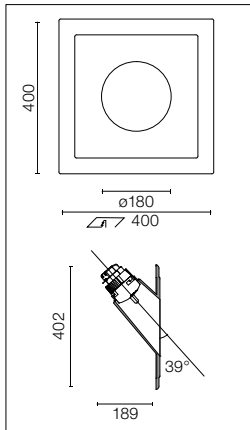

Apparecchio di segnalazione ad incasso per applicazioni in interni. Alimentatore 100/240V compreso.

Recessed sign luminaire for indoor application. 100/240V power supply source included.

SA.3011.1B

Round Light Large Designed By Flos Soft Architecture

Light Source: LED White 7W - 720 lm - 3000K/CRI > 90

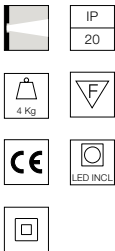
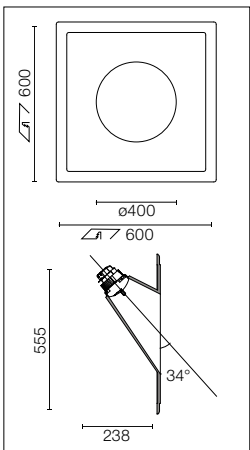

Apparecchio di segnalazione ad incasso per applicazioni in interni. Alimentatore 100/240V compreso.

Recessed sign luminaire for indoor application. 100/240V power supply source included.

SA.3012.1B

Square Light Small Designed By Flos Soft Architecture

Light Source: LED White 1W - 60 lm - 3000K/CRI > 90

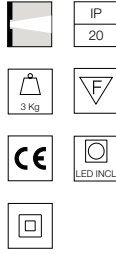
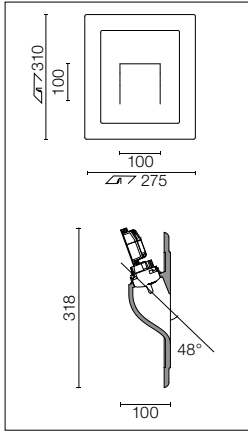

Apparecchio di segnalazione ad incasso per applicazioni in interni. Alimentatore 100/240V compreso.

Recessed sign luminaire for indoor application. 100/240V power supply source included.

SA.3013.1C

Square Light Large Designed By Flos Soft Architecture

Light Source: LED White 7W - 720 lm - 3000K/CRI > 80

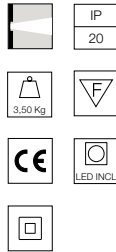
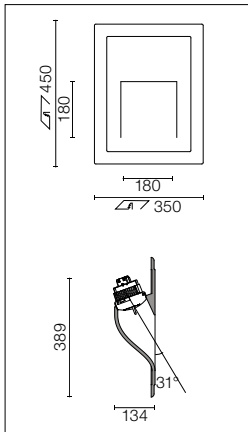

Apparecchio di segnalazione ad incasso per applicazioni in interni. Alimentatore 100/240V compreso.

Recessed sign luminaire for indoor application. 100/240V power supply source included.

SA.3014.1B

Vertical Light Small Designed By Flos Soft Architecture

Light Source: LED White 1W - 60 lm - 3000K/CRI > 90

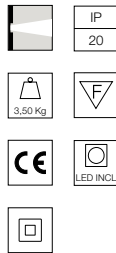
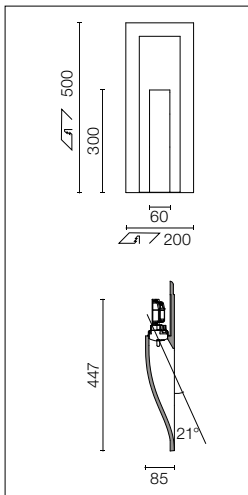

Apparecchio di segnalazione ad incasso per applicazioni in interni. Alimentatore 100/240V compreso.

Recessed sign luminaire for indoor application. 100/240V power supply source included.

SA.3015.1C

Vertical Light Large Designed By Flos Soft Architecture

Light Source: LED White 1W - 60 lm - 3000K/CRI > 90

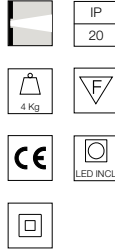
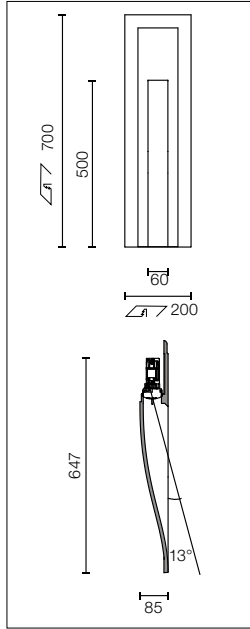

Apparecchio di segnalazione ad incasso per applicazioni in interni. Alimentatore 100/240V compreso.

Recessed sign luminaire for indoor application. 100/240V power supply source included.

SA.3016.1C

USB Round 1L Designed By Flos Soft Architecture

Light Source: LED QR-CBC-51 1xGU5.3

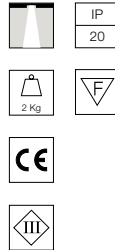
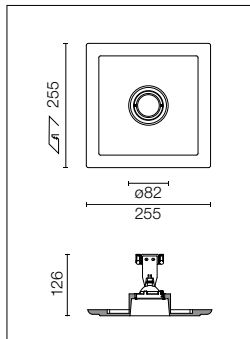

Apparecchio da incasso per lampada LED Retrofit 12V. 220/240V, 50/60Hz. Possibilità di regolazione tramite dimmer "leading and trailing edge". Trasformatore remoto non compreso.

Recessed luminaire for 12V LED Retrofit lamp. 220/240V, 50/60Hz. Adjustable by means of "leading and trailing edge". Remote transformer not included.

SA.3017.1

Elettrico / Electrical
50/70W
60.9398
105W
60.9424

Accessori / Accessories

Anti-Abbagliamento.
Anello accessorio con cut-off 40°.

Anti-Glare.
40° cut-off accessory ring.



08.8270.00

USB Round 1L W-W Designed By Flos Soft Architecture

Light Source: LED QR-CBC-51 1xGU5.3

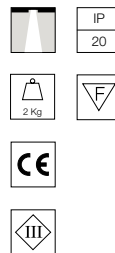
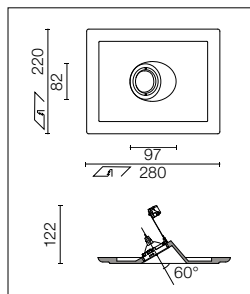

Apparecchio da incasso per lampada LED Retrofit 12V. 220/240V, 50/60Hz. Possibilità di regolazione tramite dimmer "leading and trailing edge". Trasformatore remoto non compreso.

Recessed luminaire for 12V LED Retrofit lamp. 220/240V, 50/60Hz. Adjustable by means of "leading and trailing edge". Remote transformer not included.

SA.3019.1

Elettrico / Electrical
50/70W
60.9398
105W
60.9424

USB Round 2L Designed By Flos Soft Architecture

Light Source: LED QR-CBC-51 2xGU5.3

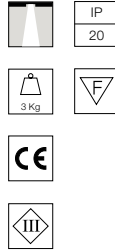
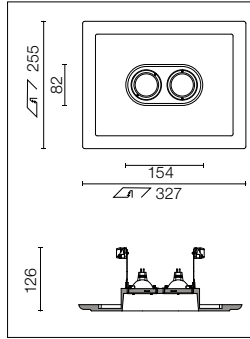

Apparecchio da incasso per lampada LED Retrofit 12V. 220/240V, 50/60Hz. Possibilità di regolazione tramite dimmer "leading and trailing edge". Trasformatore remoto non compreso.

Recessed luminaire for 12V LED Retrofit lamp. 220/240V, 50/60Hz. Adjustable by means of "leading and trailing edge". Remote transformer not included.

SA.3018.1

Elettrico / Electrical
50/70W
60.9398
105W
60.9424

Accessori / Accessories

Anti-Abbagliamento.
Anello accessorio con cut-off 40°.

Anti-Glare.
40° cut-off accessory ring.



■ 08.8270.00

USB Round 2L W-W Designed By Flos Soft Architecture

Light Source: LED QR-CBC-51 2xGU5.3

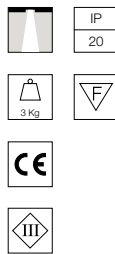
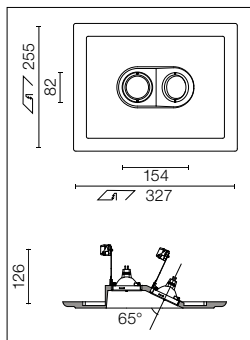

Apparecchio da incasso per lampada LED Retrofit 12V. 220/240V, 50/60Hz. Possibilità di regolazione tramite dimmer "leading and trailing edge". Trasformatore remoto non compreso.

Recessed luminaire for 12V LED Retrofit lamp. 220/240V, 50/60Hz. Adjustable by means of "leading and trailing edge". Remote transformer not included.

SA.3020.1

Elettrico / Electrical
50/70W
60.9398
105W
60.9424

USB Square 1L Designed By Flos Soft Architecture

Light Source: LED QR-CBC-51 1xGU5.3

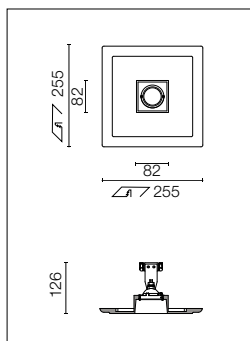

Apparecchio da incasso per lampada LED Retrofit 12V. 220/240V, 50/60Hz. Possibilità di regolazione tramite dimmer "leading and trailing edge". Trasformatore remoto non compreso.

Recessed luminaire for 12V LED Retrofit lamp. 220/240V, 50/60Hz. Adjustable by means of "leading and trailing edge". Remote transformer not included.

SA.3021.1

Elettrico / Electrical
50/70W
60.9398
105W
60.9424

Accessori / Accessories

Anti-Abbagliamento.
Anello accessorio con cut-off 40°.

Anti-Glare.
40° cut-off accessory ring.



■ 08.8270.00

USB Square 1L W-W Designed By Flos Soft Architecture

Light Source: LED QR-CBC-51 1xGU5.3

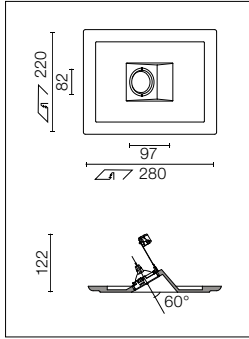

Apparecchio da incasso per lampada LED Retrofit 12V. 220/240V, 50/60Hz. Possibilità di regolazione tramite dimmer "leading and trailing edge". Trasformatore remoto non compreso.

Recessed luminaire for 12V LED Retrofit lamp. 220/240V, 50/60Hz. Adjustable by means of "leading and trailing edge". Remote transformer not included.

SA.3009.1

Elettrico / Electrical
50/70W
60.9398
105W
60.9424

USB Square 2L Designed By Flos Soft Architecture

Light Source: LED QR-CBC-51 2xGU5.3

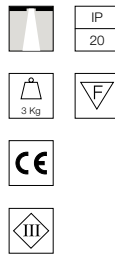
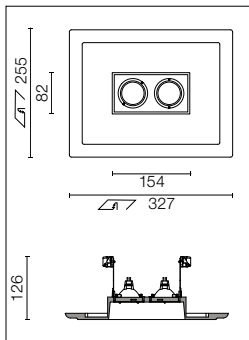

Apparecchio da incasso per lampada LED Retrofit 12V. 220/240V, 50/60Hz. Possibilità di regolazione tramite dimmer "leading and trailing edge". Trasformatore remoto non compreso.

Recessed luminaire for 12V LED Retrofit lamp. 220/240V, 50/60Hz. Adjustable by means of "leading and trailing edge". Remote transformer not included.

SA.3022.1

Elettrico / Electrical
50/70W
60.9398
105W
60.9424

Accessori / Accessories

Anti-Abbagliamento.
Anello accessorio con cut-off 40°.

Anti-Glare.
40° cut-off accessory ring.



08.8270.00

USB Square 2L W-W Designed By Flos Soft Architecture

Light Source: LED QR-CBC-51 2xGU5.3

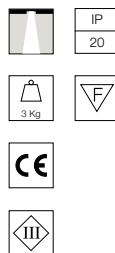
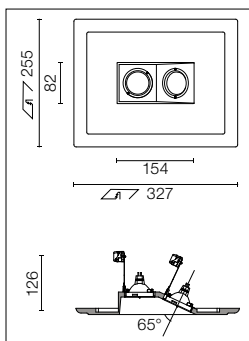

Apparecchio da incasso per lampada LED Retrofit 12V. 220/240V, 50/60Hz. Possibilità di regolazione tramite dimmer "leading and trailing edge". Trasformatore remoto non compreso.

Recessed luminaire for 12V LED Retrofit lamp. 220/240V, 50/60Hz. Adjustable by means of "leading and trailing edge". Remote transformer not included.

SA.3023.1

Elettrico / Electrical
50/70W
60.9398
105W
60.9424

SOFT ARCHITECTURE | IN

LED DRIVERS

For: USO Cove Lighting: USO 900 C.L., USO 1700 C.L., USO 2200 C.L., USO 2500 C.L., USO 100 50 C.L., USO 140 90 C.L.

Non Dimmable

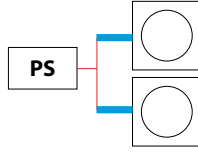

Cablaggio Wiring

Cavo di alimentazione da 500mm per moduli LED bianchi a connessione rapida.
Alimentatore elettronico non incluso.

500mm feed cable for white LED modules with fast connection.
Electronic power supply not included.

White

06.1016.00

RGB

06.1049.00

Dimmable 1-10V

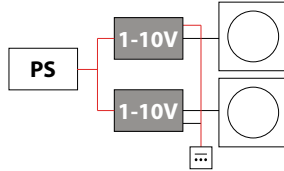

Interfacce Dimmerabili Dimmable Interfaces

Interfaccia dimmerabile 1-10V con cavo di alimentazione da 500mm per moduli LED bianchi con connessione rapida. Alimentatore elettronico non incluso.

1-10V dimmable interface with 500mm feed cable for white LED modules with fast connection.
Electronic power supply not included.

White

06.1022.00

1-10V

Interfacce Dimmerabili Dimmable Interfaces

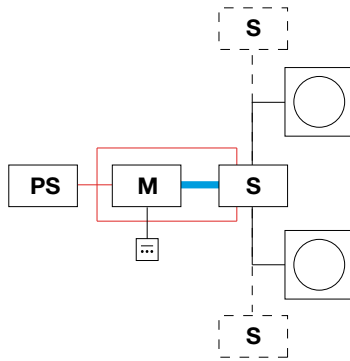

Interfaccia Master DALI con un distributore a 5 poli e un cavo di alimentazione da 500mm a connessione rapida. È in grado di controllare un Uso. Se sono presenti nello stesso impianto altri Uso, è necessario espandere il segnale con interfacce Slave. Alimentatore elettronico non incluso.

DALI Master interface with one 5 pole distributor and one 500mm feed cable for easy connection. It's able to control one USO. If more USOs are in the same installation it's necessary to expand the signal with Slave interfaces. Electronic power supply not included.

White

06.1019.00

M

RGB

06.1012.00

M

Interfaccia Master DMX con un distributore a 5 poli e un cavo di alimentazione da 500mm a connessione rapida. È in grado di comandare un Uso. Se vi sono altri Uso nello stesso impianto è necessario espandere il segnale con interfacce Slave. Alimentatore elettronico non incluso.

DMX Master interface with one 5 pole distributor and one 500mm feed cable for easy connection. It's able to control one USO. If more USOs are in the same installation it's necessary to expand the signal with Slave interfaces. Electronic power supply not included.

06.1005.00

M

Interfaccia Master RGB a radiofrequenza (RF) con un distributore a 5 poli e un cavo di alimentazione da 500mm a connessione rapida. Trasmettitore a parete per effettuare i cambi di colore, integrato. È in grado di comandare un USO. Se vi sono altri Uso nello stesso impianto è necessario espandere il segnale con interfacce Slave. Alimentatore elettronico non incluso.

Radio Frequency (RF) RGB Master interface with one 5 pole distributor and one 500mm feed cable for easy connection. Wall transmitter to make color changing integrated. It's able to control one USO. If more USOs are in the same installation it's necessary to expand the signal with Slave interfaces. Electronic power supply not included.

06.1013.00

M

— Fornito dall'installatore / Installer provides

SOFT ARCHITECTURE | IN

LED DRIVERS

For: USO Cove Lighting: USO 900 C.L., USO 1700 C.L., USO 2200 C.L., USO 2500 C.L., USO 100 50 C.L., USO 140 90 C.L.

Interfacce Dimmerabili Dimmable Interfaces

Interfaccia Slave per espandere il segnale di controllo con due cavi di alimentazione da 500mm a connessione rapida. È in grado di espandere il segnale Master in due Uso. Alimentatore elettronico non incluso.

Slave interface to expand the control signal with two 500mm feed cables for easy connection. It's able to expand the Master signal in two USOs. Electronic power supply not included.

Cavo prolunga da 2 metri per moduli LED con connessione rapida. Si possono collegare gli uni agli altri per ottenere lunghezze maggiori. Massimo 20 metri.

2 meters prolongation cable for LED modules with fast connection. Can be connected with each other to greater length. 20 meters max.

White	RGB
06.1022.00 S	06.1014.00 S
08.8297.00 —	08.8298.00 —

Alimentatore / Power Supply

Elettronico 100W / Electronic 100W
Alimentazione elettrica / Power supply
LED. 100W – 24V. 100-240V, 50-60Hz.

60.9443

Elettronico 200W / Electronic 200W
Alimentazione elettrica / Power supply
LED. 200W – 24V. 100-240V, 50-60Hz.

RF28143

Elettronico 120W / Electronic 120W
Alimentazione elettrica / Power supply
LED. 120W – 24V. 100-240V, 50-60Hz.

RF28688

Elettronico 240W / Electronic 240W
Alimentazione elettrica / Power supply
LED. 240W – 24V. 100-240V, 50-60Hz.

60.8268

Schema di Installazione Installation Guidelines

REFERENCE	POWER (W)	LED MODULES	POWER SUPPLY UNITS	MAX. Distance			LED WHITE			RGB		
				PS-100	M-S	100-100000	NO DIM	1-10V	DALI	DALI	DMX	RF
USO 100 50 Cove Lighting WHT: SA.1010.5D110 RGB: SA.1010.6D110	58	12 + 4 for corners (16)	100W 60.9443	15m (0,75 mm ²)	20m	20m	2x (06.1016.00) FEED CABLE	06.1016.00 FEED CABLE + 06.1022.00 MASTER 1-10V	06.1016.00 FEED CABLE + 06.1019.00 DALI MASTER	06.1012.00 MASTER DALI + 06.1014.00 SLAVE	06.1005.00 MASTER DMX + 06.1014.00 SLAVE	06.1013.00 MASTER RF + 06.1014.00 SLAVE
USO 140 90 Cove Lighting WHT: SA.1011.5D110 RGB: SA.1011.6D110	76	17 + 4 for corners (21)						2x (06.1016.00) FEED CABLE + 06.1022.00 MASTER 1-10V	2x (06.1016.00) FEED CABLE + 06.1019.00 DALI MASTER			
USO 900 Cove Lighting WHT: SA.1006.5D110 RGB: SA.1006.6D110								3x (06.1016.00) FEED CABLE + 1x (06.1019.00) DALI MASTER + 1x (06.1020.00) SLAVE WHITE + 2x (06.1022.00) REPEATER PWM	2x (06.1014.00)* SLAVE			
USO 1700 Cove Lighting WHT: SA.1007.5D110 RGB: SA.1007.6D110	137	30 + 8 for corners (38)	240W 60.8268	40m (1 mm ²)	20m	20m	4x (06.1016.00) FEED CABLE	3x (06.1016.00) FEED CABLE + 2x (06.1022.00) MASTER 1-10V	5x (06.1016.00) FEED CABLE + 1x (06.1019.00) DALI MASTER + 1x (06.1020.00) SLAVE WHITE + 2x (06.1022.00) REPEATER PWM	2x (06.1014.00)* SLAVE	2x (06.1014.00)* SLAVE	2x (06.1014.00)* SLAVE
USO 2200 Cove Lighting WHT: SA.1008.5D110 RGB: SA.1008.6D110	180	38 + 12 for corners (50)					5x (06.1016.00) FEED CABLE	5x (06.1016.00) FEED CABLE + 2x (06.1022.00) MASTER 1-10V				
USO 2500 Cove Lighting WHT: SA.1009.5D110 RGB: SA.1009.6D110	194	42 + 12 for corners (54)										

* For USO 2500 Cove Lighting RGB
1st Slave: 12 + 12 LED modules
2nd Slave: 10 + 10 + 10 LED modules

Per informazioni più dettagliate, consultare il foglio di istruzioni. Per un'installazione più complessa, consultare l'ufficio tecnico. / For more detailed information, please refer to the instruction sheet. For a more complex installation, please consult the technical department.



CARATTERISTICHE DEL COMPOSITE COMPOSITE CHARACTERISTICS



CARATTERISTICHE FISICHE

Impermeabilità

Il materiale è adatto a tutte le applicazioni in ambienti interni e non assorbe l'acqua eventualmente presente in caso di umidità eccessiva. Il materiale non deve essere utilizzato in ambienti esterni.

Reazione al test sul fuoco per i prodotti per l'edilizia

Il prodotto Soft Architecture è classificato A1 o A1fl, conformemente alla norma UNE-EN 13501-1: 07 e ai metodi di test UNE-EN ISO 1716:02 e UNE-EN ISO 1182:02.

Resistenza chimica

Il materiale non deve essere esposto a sostanze chimiche liquide o cristalli deliquescenti.

Isolamento termico

Il materiale ha un valore di conduttività termica non superiore a 0,47 W/m. gr. K.

Densità

Il materiale ha una densità media di 1323 Kg/m³.

Caratteristiche strutturali

Il materiale ha le seguenti caratteristiche (in base alla norma EN 13279-2:2006).

Carico massimo di flessione: 139 N a 7,2mm di spessore.

Compressione: il carico massimo di compressione è superiore a 10000 N.

Durezza: la durezza C shore è superiore a 90.

PHYSICAL CHARACTERISTICS

Water Penetration

The material shall be suitable for all internal application, and shall not absorb moisture which may be present through excessive humidity. The material should not be used externally.

Reaction to Fire test for building products

The product Soft Architecture is classified as A1 or A1fl, according to UNE-EN 13501-1: 07, and test methods UNE-EN ISO 1716:02 and UNE-EN ISO 1182:02.

Chemical Resistance

The material shall not be exposed to liquid chemicals or deliquesced crystals.

Thermal Insulation

The material shall have a thermal conductivity value not greater than 0.47W/m. deg K.

Density

The material have a medium density of 1323 Kg/m³.

Structural Characteristics

The material shall have the following characteristics (following EN 13279-2:2006).

Flexion max load: 139N at 7.2mm thickness.

Compression: compression max load shall be bigger than 10000N.

Hardness: Shore C hardness shall be above 90.

CARATTERISTICHE DEI MATERIALI

Eco-efficienza idrica

Viene utilizzata acqua potabile dalla rete idrica, in proporzioni adeguate, per ottenere una lavorabilità ottimale. L'acqua viene riutilizzata ciclicamente, tramite filtri speciali, per prevenire danni ecologici all'ambiente prima dello smaltimento.

Agenti di sformatura

Alla superficie dello stampo vengono uniti o applicati esternamente degli agenti di sformatura, per ottimizzare il tempo di ciclo e ottenere una finitura omogenea della superficie. Tali agenti non hanno alcun effetto nocivo sulla superficie stessa del prodotto.

FEATURES OF MATERIALS

Water Eco Efficiency

Clean water from drinking network is used in correct proportion to provide optimum workability. Water is cyclically re-used through special filters to prevent ecologic damages to nature before disposal.

Mould Release Agents

Proprietary mould release agents are incorporated or applied externally to the mould surface, to optimize cycle time and to achieve consistency of surface finish. These agents shall not have any adverse effect upon the surface of the produced item.

DESIGN E PRODUZIONE

Design

Per sviluppare tutti i componenti è stata impiegata la più avanzata tecnologia 3D. Tali componenti vengono disegnati e prodotti secondo un sistema di garanzia della qualità completamente documentato, conforme alla norma ISO 9001:2008.

DESIGN & MANUFACTURING

Design

Latest 3D technology has been applied to develop all components. They are being manufactured and designed in accordance with a fully documented quality assurance system complying with ISO 9001:2008.

CONTROLLO QUALITÀ

Aspetti generali

Tutti i componenti vengono controllati singolarmente per evitare difetti superficiali o di manodopera.

Normativa: UNE-EN 13815: 06; UNE-EN 14246: 07.

Ortogonalità

Tutti i componenti sono controllati singolarmente per evitare difetti di manodopera superiori a valori tra 0,5mm e 500mm dall'angolo.

Planarità

Tutti i componenti sono controllati singolarmente per evitare difetti di manodopera relativi alla planarità superiori a valori più grandi di 1mm 1m.

Spessore

Tutti i componenti per soffitti continui sono controllati singolarmente per evitare variazioni superiori a 2mm dallo spessore medio obiettivo.

Tolleranza dimensionale

Tutti i componenti sono ispezionati singolarmente per evitare una tolleranza dimensionale superiore a +/- 3mm.

Altre informazioni in www.soft-architecture.com.

Efflorescenza

Tutti i componenti con superficie illuminata/visibile sono controllati singolarmente per evitare l'efflorescenza della luce.

Fatto a mano

Questo prodotto è stato fabbricato a mano, qualsiasi imperfezione è dovuta alla sua lavorazione artigianale.

QUALITY CONTROL

General

All components are individually inspected to prevent surface or manufacturing defects.

Normative: UNE-EN 13815: 06; UNE-EN 14246: 07.

Squareness

All components are individually inspected to prevent manufacturing defects bigger than 0.5mm to 500mm from corner.

Flatness

All components are individually inspected to prevent flatness manufacturing defects bigger than 1mm in 1m.

Thickness

All components for continuous ceilings are individually inspected to prevent changes bigger than 2mm in mean target thickness.

Dimensional Tolerance

All components are individually inspected to prevent dimensional tolerance above +/- 3mm.

For more info see www.soft-architecture.com.

Efflorescence

All components with illuminated/visible surface are individually inspected to prevent light efflorescence.

Handmade

This product has been manufactured by hand. Any imperfection is because of its handcrafted process.



TERMINI COMUNI COMMON TERMS



CRADLE TO CRADLE

Soft Architecture è progettato per durare nel tempo e ridurre al minimo gli effetti dannosi sull'ambiente in fase di produzione. La sostenibilità, l'innovazione e la qualità sono i nostri obiettivi principali, ispirati dalla natura.

CRADLE TO CRADLE

Soft Architecture is designed to last and to minimize the harmful effects on the natural environment during production. Sustainability, innovation and quality are our main goals, inspired by nature.

1-10V

1-10 V è uno dei primi e più semplici dispositivi di comando elettronici per moduli di illuminazione. Il segnale di comando è una tensione CC che varia tra uno e dieci volt. Il modulo di illuminazione comandato dovrebbe graduare la propria uscita in modo tale che a 10 V la luce comandata sia al 100% della sua resa potenziale, mentre a 1 V dovrebbe essere pari allo 0% della resa (ad es. "spento").

1-10V

1-10 V is one of the earliest and simplest electronic lighting control. The control signal is a DC voltage that varies between one and ten volts. The controlled lighting should scale its output so that at 10 V, the controlled light should be at 100% of its potential output, and at 1 V it should be at 0% output (i.e. "Off").

CRI

L'indice di resa dei colori (color rendering index, CRI) è una misura quantitativa della capacità di una sorgente luminosa di riprodurre fedelmente i colori di vari oggetti rispetto a una sorgente luminosa ideale o naturale. Le sorgenti luminose con un elevato CRI sono da preferirsi nelle applicazioni in cui il colore è di fondamentale importanza.

CRI

The color rendering index (CRI) is a quantitative measure of the ability of a light source to reproduce the colors of various objects faithfully in comparison with an ideal or natural light source. Light sources with a high CRI are desirable in color-critical applications.

DALI

L'interfaccia DALI (Digital Addressable Lighting Interface) è uno standard tecnico per i sistemi basati su rete che comandano l'illuminazione negli edifici. Lo standard DALI comprende il protocollo di comunicazione e l'interfaccia elettrica per le reti di controllo dell'illuminazione.

DALI

Digital Addressable Lighting Interface (DALI) is a technical standard for network-based systems that control lighting in buildings. The DALI standard encompasses the communications protocol and electrical interface for lighting control networks.

DIMMER

I dimmer sono dispositivi utilizzati per variare la luminosità di una luce.

DIMMER

Dimmers are devices used to vary the brightness of a light.

DMX

DMX è uno standard per le reti di comunicazione digitale comunemente utilizzato per controllare le luci di scena. Consente di programmare la regolazione del colore e la variazione dell'RGB.

DMX

DMX is a standard for digital communication networks that are commonly used to control stage lighting. Allows to program the colour regulation and variation for RGB.

KELVIN

Il kelvin è utilizzato nella misurazione della temperatura del colore delle sorgenti luminose. La temperatura del colore è una caratteristica della luce visibile che presenta importanti applicazioni nell'illuminazione in quanto indica se la luce è calda (temperature di colore basse) o fredda (temperature di colore alte).

KELVIN

The kelvin is used in the measure of the color temperature of light sources. Color temperature is a characteristic of visible light that has important applications in lighting because indicates if the light is warm (low color temperatures) or cold (high color temperatures).

LUMEN

Il lumen (simbolo: lm) è l'unità di misura SI del flusso luminoso, una misura della potenza della luce percepita dall'occhio umano.

LUMEN

The lumen (symbol: lm) is the SI unit of luminous flux, a measure of the power of light perceived by the human eye.

INTERFACCIA MASTER

L'interfaccia Master è un dispositivo elettronico che riceve il segnale (DALI/DMX/...) e restituisce un segnale modulato per il LED. È in grado di comandare la luce con una intensità di corrente massima.

MASTER INTERFACE

The master interface it is an electronic device which receives the signal (DALI/DMX/...) and returns a modulated signal for the LED. It's able to control the light with a maximum power load.

ALIMENTATORE

L'alimentatore è un dispositivo che fornisce energia elettrica a uno o più carichi elettrici.

POWER SUPPLY

A power supply is a device that supplies electrical energy to one or more electric loads.

RGB

Il modello di colore RGB è un modello di colore aggiuntivo in cui le luci rossa, verde e blu sono abbinate in vari modi per riprodurre un'ampia gamma di colori. Il nome del modello proviene dalle iniziali dei tre colori primari aggiuntivi: rosso (red), verde (green) e blu (blue).

RGB

The RGB color model is an additive color model in which red, green, and blue light are added together in various ways to reproduce a broad array of colors. The name of the model comes from the initials of the three additive primary colors, red, green, and blue.

INTERFACCIA SLAVE

L'interfaccia Slave viene utilizzata per rispondere al segnale modulato dell'interfaccia Master negli impianti in cui il Master è sovraccarico.

SLAVE INTERFACE

The slave interface is used to reply the modulated signal of the master interface in installations where the master is overloaded.

Nota: I dati tecnici sono soggetti a variazione senza alcun preavviso. Le informazioni sono coerenti con le nostre attuali condizioni di produzione e riflettono i valori tipici relativi ai parametri delle specifiche di fabbricazione e per le tipiche destinazioni finali. Si declina qualsiasi responsabilità per eventuali danni causati da uno scorretto utilizzo dei prodotti.

Note: Technical data are subject to changes without any previous notice. Information is consistent with our current production conditions and reflects typical values relating to manufacturing specification parameters and for typical end uses. We accept no liability or responsibility for any damage caused by products incorrectly applied in non typical end uses.

QUICK SEARCH OF PRODUCT

Ref.	Page	Ref.	Page	Ref.	Page	Ref.	Page	Ref.	Page
03.0700.14A	418	03.0723.TKA	421	03.0805.14	424	03.1232.ER	513	03.1256.ER	512
03.0700.14ANT	418	03.0730.14A	422	03.0805.40	424	03.1232.ES	513	03.1256.ES	512
03.0700.40A	418	03.0730.40A	422	03.1060.14	534	03.1233.DR	513	03.1257.DR	512
03.0700.40ANT	418	03.0730.CEA	422	03.1060.29	534	03.1233.DY	513	03.1257.DY	512
03.0701.14A	418	03.0730.TKA	422	03.1060.30	534	03.1233.EQ	513	03.1257.EQ	512
03.0701.14ANT	418	03.0731.14A	422	03.1060.TK	534	03.1233.ER	513	03.1257.ER	512
03.0701.40A	418	03.0731.40A	422	03.1060.WG	534	03.1233.ES	513	03.1257.ES	512
03.0701.40ANT	418	03.0731.CEA	422	03.1061.14	535	03.1235.DR	513	03.1258.DR	512
03.0702.14A	419	03.0731.TKA	422	03.1061.29	535	03.1235.DY	513	03.1258.DY	512
03.0702.14ANT	419	03.0732.14A	422	03.1061.30	535	03.1235.EQ	513	03.1258.EQ	512
03.0702.40A	419	03.0732.40A	422	03.1061.TK	535	03.1235.ER	513	03.1258.ER	512
03.0702.40ANT	419	03.0732.CEA	422	03.1061.WG	535	03.1235.ES	513	03.1258.ES	512
03.0703.14A	419	03.0732.TKA	422	03.1063.14	535	03.1236.DR	513	03.2001.01	355
03.0703.14ANT	419	03.0733.14A	422	03.1063.29	535	03.1236.DY	513	03.2001.01.DA	355
03.0703.40A	419	03.0733.40A	422	03.1063.30	535	03.1236.EQ	513	03.2001.14	355
03.0703.40ANT	419	03.0733.CEA	422	03.1063.TK	535	03.1236.ER	513	03.2001.14.DA	355
03.0704.14A	418	03.0733.TKA	422	03.1063.WG	535	03.1236.ES	513	03.2001.CU	355
03.0704.14ANT	418	03.0734.14A	422	03.1064.14	535	03.1237.DR	513	03.2001.CU.DA	355
03.0704.40A	418	03.0734.40A	422	03.1064.29	535	03.1237.DY	513	03.2003.01	355
03.0704.40ANT	418	03.0734.CEA	422	03.1064.30	535	03.1237.EQ	513	03.2003.01.DA	355
03.0705.14A	418	03.0734.TKA	422	03.1064.TK	535	03.1237.ER	513	03.2003.14	355
03.0705.14ANT	418	03.0735.14A	422	03.1064.WG	535	03.1237.ES	513	03.2003.14.DA	355
03.0705.40A	418	03.0735.40A	422	03.1200.DR	510	03.1238.DR	513	03.2003.CU	355
03.0705.40ANT	418	03.0735.CEA	422	03.1200.DY	510	03.1238.DY	513	03.2003.CU.DA	355
03.0706.14A	419	03.0735.TKA	422	03.1200.EQ	510	03.1238.EQ	513	03.2005.01	356
03.0706.14ANT	419	03.0740.14	424	03.1200.ER	510	03.1238.ER	513	03.2005.01.DA	356
03.0706.40A	419	03.0740.40	424	03.1200.ES	510	03.1238.ES	513	03.2005.14	356
03.0706.40ANT	419	03.0741.14	424	03.1201.DR	510	03.1240.DR	514	03.2005.14.DA	356
03.0707.14A	419	03.0741.40	424	03.1201.DY	510	03.1240.DY	514	03.2005.CU	356
03.0707.14ANT	419	03.0742.14	424	03.1201.EQ	510	03.1240.EQ	514	03.2005.CU.DA	356
03.0707.40A	419	03.0742.40	424	03.1201.ER	510	03.1240.ER	514	03.2006.01	355
03.0707.40ANT	419	03.0743.14	424	03.1201.ES	510	03.1240.ES	514	03.2006.01.DA	355
03.0708.14A	418	03.0743.40	424	03.1205.DR	510	03.1241.DR	514	03.2006.14	355
03.0708.14ANT	418	03.0744.14	424	03.1205.DY	510	03.1241.DY	514	03.2006.14.DA	355
03.0708.40A	418	03.0744.40	424	03.1205.EQ	510	03.1241.EQ	514	03.2006.CU	355
03.0708.40ANT	418	03.0745.14	424	03.1205.ER	510	03.1241.ER	514	03.2006.CU.DA	355
03.0709.14A	418	03.0745.40	424	03.1205.ES	510	03.1241.ES	514	03.2007.01	355
03.0709.14ANT	418	03.0760.14A	421	03.1206.DR	510	03.1242.DR	514	03.2007.01.DA	355
03.0709.40A	418	03.0760.40A	421	03.1206.DY	510	03.1242.DY	514	03.2007.14	355
03.0709.40ANT	418	03.0760.CEA	421	03.1206.EQ	510	03.1242.EQ	514	03.2007.14.DA	355
03.0710.14A	419	03.0760.TKA	421	03.1206.ER	510	03.1242.ER	514	03.2007.CU	355
03.0710.14ANT	419	03.0761.14A	421	03.1206.ES	510	03.1242.ES	514	03.2007.CU.DA	355
03.0710.40A	419	03.0761.40A	421	03.1210.DR	511	03.1243.DR	514	03.2008.01	356
03.0710.40ANT	419	03.0761.CEA	421	03.1210.DY	511	03.1243.DY	514	03.2008.01.DA	356
03.0711.14A	419	03.0761.TKA	421	03.1210.EQ	511	03.1243.EQ	514	03.2008.14	356
03.0711.14ANT	419	03.0762.14A	421	03.1210.ER	511	03.1243.ER	514	03.2008.14.DA	356
03.0711.40A	419	03.0762.40A	421	03.1210.ES	511	03.1243.ES	514	03.2008.CU	356
03.0711.40ANT	419	03.0762.CEA	421	03.1211.DR	511	03.1245.DR	514	03.2008.CU.DA	356
03.0712.14A	420	03.0762.TKA	421	03.1211.DY	511	03.1245.DY	514	03.2210.14A	76
03.0712.14ANT	420	03.0763.14A	421	03.1211.EQ	511	03.1245.EQ	514	03.2210.40A	76
03.0712.40A	420	03.0763.40A	421	03.1211.ER	511	03.1245.ER	514	03.2211.14A	76
03.0712.40ANT	420	03.0763.CEA	421	03.1211.ES	511	03.1245.ES	514	03.2211.40A	76
03.0713.14A	420	03.0763.TKA	421	03.1215.DR	511	03.1246.DR	514	03.2212.14A	76
03.0713.14ANT	420	03.0764.14A	421	03.1215.DY	511	03.1246.DY	514	03.2212.40A	76
03.0713.40A	420	03.0764.40A	421	03.1215.EQ	511	03.1246.EQ	514	03.2213.14A	76
03.0713.40ANT	420	03.0764.CEA	421	03.1215.ER	511	03.1246.ER	514	03.2213.40A	76
03.0714.14A	420	03.0764.TKA	421	03.1215.ES	511	03.1246.ES	514	03.2215.14A	76
03.0714.14ANT	420	03.0765.14A	421	03.1216.DR	511	03.1247.DR	514	03.2215.40A	76
03.0714.40A	420	03.0765.40A	421	03.1216.DY	511	03.1247.DY	514	03.2216.14A	76
03.0714.40ANT	420	03.0765.CEA	421	03.1216.EQ	511	03.1247.EQ	514	03.2216.40A	76
03.0715.14A	420	03.0765.TKA	421	03.1216.ER	511	03.1247.ER	514	03.2217.14A	76
03.0715.14ANT	420	03.0770.14A	422	03.1216.ES	511	03.1247.ES	514	03.2217.40A	76
03.0715.40A	420	03.0770.40A	422	03.1220.DR	510	03.1248.DR	514	03.2218.14A	76
03.0715.40ANT	420	03.0770.CEA	422	03.1220.DY	510	03.1248.DY	514	03.2218.40A	76
03.0716.14A	420	03.0770.TKA	422	03.1220.EQ	510	03.1248.EQ	514	03.2220.14A	77
03.0716.14ANT	420	03.0771.14A	422	03.1220.ER	510	03.1248.ER	514	03.2220.40A	77
03.0716.40A	420	03.0771.40A	422	03.1220.ES	510	03.1248.ES	514	03.2221.14A	77
03.0716.40ANT	420	03.0771.CEA	422	03.1221.DR	510	03.1250.DR	512	03.2221.40A	77
03.0717.14A	420	03.0771.TKA	422	03.1221.DY	510	03.1250.DY	512	03.2222.14A	77
03.0717.14ANT	420	03.0772.14A	422	03.1221.EQ	510	03.1250.EQ	512	03.2222.40A	77
03.0717.40A	420	03.0772.40A	422	03.1221.ER	510	03.1250.ER	512	03.2223.14A	77
03.0717.40ANT	420	03.0772.CEA	422	03.1221.ES	510	03.1250.ES	512	03.2223.40A	77
03.0718.14A	421	03.0772.TKA	422	03.1225.DR	510	03.1251.DR	512	03.2225.14A	77
03.0718.40A	421	03.0773.14A	422	03.1225.DY	510	03.1251.DY	512	03.2225.40A	77
03.0718.CEA	421	03.0773.40A	422	03.1225.EQ	510	03.1251.EQ	512	03.2226.14A	77
03.0718.TKA	421	03.0773.CEA	422	03.1225.ER	510	03.1251.ER	512	03.2226.40A	77
03.0719.14A	421	03.0773.TKA	422	03.1225.ES	510	03.1251.ES	512	03.2227.14A	77
03.0719.40A	421	03.0774.14A	422	03.1226.DR	510	03.1252.DR	512	03.2227.40A	77
03.0719.CEA	421	03.0774.40A	422	03.1226.DY	510	03.1252.DY	512	03.2228.14A	77
03.0719.TKA	421	03.0774.CEA	422	03.1226.EQ	510	03.1252.EQ	512	03.2228.40A	77
03.0720.14A	421	03.0774.TKA	422	03.1226.ER	510	03.1252.ER	512	03.2230.14A	78
03.0720.40A	421	03.0775.14A	422	03.1226.ES	510	03.1252.ES	512	03.2230.40A	78
03.0720.CEA	421	03.0775.40A	422	03.1230.DR	513	03.1253.DR	512	03.2231.14A	78
03.0720.TKA	421	03.0775.CEA	422	03.1230.DY	513	03.1253.DY	512	03.2231.40A	78
03.0721.14A	421	03.0775.TKA	422	03.1230.EQ	513	03.1253.EQ	512	03.2232.14A	78
03.0721.40A	421	03.0800.14	424	03.1230.ER	513	03.1253.ER	512	03.2232.40A	78
03.0721.CEA	421	03.0800.40	424	03.1230.ES	513	03.1253.ES	512	03.2233.14A	78
03.0721.TKA	421	03.0801.14	424	03.1231.DR	513	03.1255.DR	512	03.2233.40A	78
03.0722.14A	421	03.0801.40	424	03.1231.DY	513	03.1255.DY	512	03.2235.14A	78
03.0722.40A	421	03.0802.14	424	03.1231.EQ	513	03.1255.EQ	512	03.2235.40A	78
03.0722.CEA	421	03.0802.40	424	03.1231.ER	513	03.1255.ER	512	03.2236.14A	78
03.0722.TKA	421	03.0803.14	424	03.1231.ES	513	03.1255.ES	512	03.2236.40A	78
03.0723.14A	421	03.0803.40	424	03.1232.DR	513	03.1256.DR	512	03.2237.14A	78
03.0723.40A	421	03.0804.14	424	03.1232.DY	513	03.1256.DY	512	03.2237.40A	78
03.0723.CEA	421	03.0804.40	424	03.1232.EQ	513	03.1256.EQ	512	03.2238.14A	78

QUICK SEARCH OF PRODUCT

Ref.	Page	Ref.	Page	Ref.	Page	Ref.	Page	Ref.	Page
03.2238.40A	78	03.2630.TKA	532	03.3539.14	400	03.4172.BU.LE	329	03.4188.74	279
03.2240.14	79	03.2630.WGA	532	03.3539.30	400	03.4172.CU	328	03.4188.74.LE	280
03.2240.40	79	03.2631.14A	532	03.3902.30C	240	03.4172.CU.LE	329	03.4188.B1	279
03.2241.14	79	03.2631.29A	532	03.3903.30C	240	03.4172.GL	328	03.4188.B1.LE	280
03.2241.40	79	03.2631.30A	532	03.3904.30C	240	03.4172.GL.LE	329	03.4188.BU	279
03.2242.14	79	03.2631.TKA	532	03.3922.30C	240	03.4176.74	317	03.4188.BU.LE	280
03.2242.40	79	03.2631.WGA	532	03.3923.30C	240	03.4176.74.LE	318	03.4188.CU	279
03.2243.14	79	03.2632.14A	532	03.3924.30C	240	03.4176.B1	317	03.4188.CU.LE	280
03.2243.40	79	03.2632.29A	532	03.3960.29B	164	03.4176.B1.LE	318	03.4188.GL	279
03.2245.14	79	03.2632.30A	532	03.3960.ANB	164	03.4176.BU	317	03.4188.GL.LE	280
03.2245.40	79	03.2632.TKA	532	03.3962.29B	164	03.4176.BU.LE	318	03.4189.74	279
03.2246.14	79	03.2632.WGA	532	03.3962.ANB	164	03.4176.CU	317	03.4189.B1	279
03.2246.40	79	03.2635.14A	532	03.3963.29B	164	03.4176.CU.LE	318	03.4189.BU	279
03.2247.14	79	03.2635.29A	532	03.3963.ANB	164	03.4176.GL	317	03.4189.CU	279
03.2247.40	79	03.2635.30A	532	03.3970.02A	165	03.4176.GL.LE	318	03.4189.GL	279
03.2248.14	79	03.2635.TKA	532	03.3970.14A	165	03.4177.74	317	03.4190.74	281
03.2248.40	79	03.2635.WGA	532	03.3970.30A	165	03.4177.B1	317	03.4190.74.LE	282
03.2250.14	79	03.2636.14A	532	03.3971.02A	165	03.4177.BU	317	03.4190.B1	281
03.2250.40	79	03.2636.29A	532	03.3971.14A	165	03.4177.CU	317	03.4190.B1.LE	282
03.2251.14	79	03.2636.30A	532	03.3971.30A	165	03.4177.GL	317	03.4190.BU	281
03.2251.40	79	03.2636.TKA	532	03.3972.02A	165	03.4178.74	321	03.4190.BU.LE	282
03.2252.14	79	03.2636.WGA	532	03.3972.14A	165	03.4178.74.LE	322	03.4190.CU	281
03.2252.40	79	03.2637.14A	532	03.3972.30A	165	03.4178.B1	321	03.4190.CU.LE	282
03.2253.14	79	03.2637.29A	532	03.3975.02A	165	03.4178.B1.LE	322	03.4190.GL	281
03.2253.40	79	03.2637.30A	532	03.3975.14A	165	03.4178.BU	321	03.4190.GL.LE	282
03.2255.14	79	03.2637.TKA	532	03.3975.30A	165	03.4178.BU.LE	322	03.4191.74	281
03.2255.40	79	03.2637.WGA	532	03.3976.02A	165	03.4178.CU	321	03.4191.B1	281
03.2256.14	79	03.2640.14A	533	03.3976.14A	165	03.4178.CU.LE	322	03.4191.BU	281
03.2256.40	79	03.2640.29A	533	03.3976.30A	165	03.4178.GL	321	03.4191.CU	281
03.2257.14	79	03.2640.30A	533	03.3977.02A	165	03.4178.GL.LE	322	03.4191.GL	281
03.2257.40	79	03.2640.TKA	533	03.3977.14A	165	03.4179.74	321	03.4192.74	313
03.2258.14	79	03.2640.WGA	533	03.3977.30A	165	03.4179.B1	321	03.4192.74.LE	314
03.2258.40	79	03.2641.14A	533	03.4060.29	164	03.4179.BU	321	03.4192.B1	313
03.2260.14	74	03.2641.29A	533	03.4060.29.1Y	164	03.4179.CU	321	03.4192.B1.LE	314
03.2261.14	74	03.2641.30A	533	03.4061.29	164	03.4179.GL	321	03.4192.BU	313
03.2262.14	74	03.2641.TKA	533	03.4061.29.1Y	164	03.4180.74	255	03.4192.BU.LE	314
03.2263.14	74	03.2641.WGA	533	03.4062.29	164	03.4180.74.LE	256	03.4192.CU	313
03.2264.14	74	03.2642.14A	533	03.4062.29.1Y	164	03.4180.B1	255	03.4192.CU.LE	314
03.2265.14	74	03.2642.29A	533	03.4063.29	164	03.4180.B1.LE	256	03.4192.GL	313
03.2266.14	74	03.2642.30A	533	03.4063.29.1Y	164	03.4180.BU	255	03.4192.GL.LE	314
03.2267.14	74	03.2642.TKA	533	03.4064.29	164	03.4180.BU.LE	256	03.4193.74	313
03.2268.14	74	03.2642.WGA	533	03.4064.29.1Y	164	03.4180.CU	255	03.4193.B1	313
03.2269.14	74	03.2645.14A	533	03.4065.29	164	03.4180.CU.LE	256	03.4193.BU	313
03.2270.14	74	03.2645.29A	533	03.4065.29.1Y	164	03.4180.GL	255	03.4193.CU	313
03.2271.14	74	03.2645.30A	533	03.4065.29.5Y	164	03.4180.GL.LE	256	03.4193.GL	313
03.2272.14	74	03.2645.TKA	533	03.4153.74	324	03.4181.74	255	03.4194.74	319
03.2273.14	74	03.2645.WGA	533	03.4153.B1	324	03.4181.B1	255	03.4194.74.LE	320
03.2274.14	74	03.2646.14A	533	03.4153.BU	324	03.4181.BU	255	03.4194.B1	319
03.2275.14	74	03.2646.29A	533	03.4153.CU	324	03.4181.CU	255	03.4194.B1.LE	320
03.2280.14	75	03.2646.30A	533	03.4153.GL	324	03.4181.GL	255	03.4194.BU	319
03.2281.14	75	03.2646.TKA	533	03.4155.74	326	03.4182.74	261	03.4194.BU.LE	320
03.2282.14	75	03.2646.WGA	533	03.4155.B1	326	03.4182.74.LE	262	03.4194.CU	319
03.2283.14	75	03.2647.14A	533	03.4155.BU	326	03.4182.B1	261	03.4194.CU.LE	320
03.2284.14	75	03.2647.29A	533	03.4155.CU	326	03.4182.B1.LE	262	03.4194.GL	319
03.2285.14	75	03.2647.30A	533	03.4155.GL	326	03.4182.BU	261	03.4194.GL.LE	320
03.2286.14	75	03.2647.TKA	533	03.4157.74	328	03.4182.BU.LE	262	03.4195.74	319
03.2287.14	75	03.2647.WGA	533	03.4157.B1	328	03.4182.CU	261	03.4195.B1	319
03.2288.14	75	03.2650.14	430	03.4157.BU	328	03.4182.CU.LE	262	03.4195.BU	319
03.2289.14	75	03.2650.30	430	03.4157.CU	328	03.4182.GL	261	03.4195.CU	319
03.2290.14	75	03.2651.14	430	03.4157.GL	328	03.4182.GL.LE	262	03.4195.GL	319
03.2291.14	75	03.2651.30	430	03.4160.74	336	03.4183.74	261	03.4196.74	337
03.2292.14	75	03.2675.14A	429	03.4160.B1	336	03.4183.B1	261	03.4196.74.LE	338
03.2293.14	75	03.2675.30A	429	03.4160.BU	336	03.4183.BU	261	03.4196.B1	337
03.2294.14	75	03.2676.14A	429	03.4160.CU	336	03.4183.CU	261	03.4196.B1.LE	338
03.2295.14	75	03.2676.30A	429	03.4160.GL	336	03.4183.GL	261	03.4196.BU	337
03.2300.14A	77	03.2677.14A	429	03.4162.74	336	03.4184.74	268	03.4196.BU.LE	338
03.2300.40A	77	03.2677.30A	429	03.4162.B1	336	03.4184.74.LE	269	03.4196.CU	337
03.2301.14A	77	03.2680.14A	429	03.4162.BU	336	03.4184.B1	268	03.4196.CU.LE	338
03.2301.40A	77	03.2680.30A	429	03.4162.CU	336	03.4184.B1.LE	269	03.4196.GL	337
03.2302.14A	77	03.2681.14A	429	03.4162.GL	336	03.4184.BU	268	03.4196.GL.LE	338
03.2302.40A	77	03.2681.30A	429	03.4170.74	324	03.4184.BU.LE	269	03.4197.74	337
03.2303.14A	77	03.2682.14A	429	03.4170.74.LE	325	03.4184.CU	268	03.4197.B1	337
03.2303.40A	77	03.2682.30A	429	03.4170.B1	324	03.4184.CU.LE	269	03.4197.BU	337
03.2520.14	430	03.3502.02	402	03.4170.B1.LE	325	03.4184.GL	268	03.4197.CU	337
03.2520.30	430	03.3502.14	402	03.4170.BU	324	03.4184.GL.LE	269	03.4197.GL	337
03.2521.14	430	03.3502.30	402	03.4170.BU.LE	325	03.4185.74	268	03.4198.74	339
03.2521.30	430	03.3505.02	401	03.4170.CU	324	03.4185.B1	268	03.4198.74.LE	340
03.2600.14	534	03.3505.14	401	03.4170.CU.LE	325	03.4185.BU	268	03.4198.B1	339
03.2600.29	534	03.3505.30	401	03.4170.GL	324	03.4185.CU	268	03.4198.B1.LE	340
03.2600.30	534	03.3506.02	400	03.4170.GL.LE	325	03.4185.GL	268	03.4198.BU	339
03.2600.TK	534	03.3506.14	400	03.4171.74	326	03.4186.74	274	03.4198.BU.LE	340
03.2600.WG	534	03.3506.30	400	03.4171.74.LE	327	03.4186.74.LE	275	03.4198.CU	339
03.2601.14	534	03.3507.02	401	03.4171.B1	326	03.4186.B1	274	03.4198.CU.LE	340
03.2601.29	534	03.3507.14	401	03.4171.B1.LE	327	03.4186.B1.LE	275	03.4198.GL	339
03.2601.30	534	03.3507.30	401	03.4171.BU	326	03.4186.BU	274	03.4198.GL.LE	340
03.2601.TK	534	03.3508.02	401	03.4171.BU.LE	327	03.4186.BU.LE	275	03.4199.74	339
03.2601.WG	534	03.3508.14	401	03.4171.CU	326	03.4186.CU	274	03.4199.B1	339
03.2603.14	534	03.3508.30	401	03.4171.CU.LE	327	03.4186.CU.LE	275	03.4199.BU	339
03.2603.29	534	03.3520.02	402	03.4171.GL	326	03.4186.GL	274	03.4199.CU	339
03.2603.30	534	03.3520.14	402	03.4171.GL.LE	327	03.4186.GL.LE	275	03.4199.GL	339
03.2603.TK	534	03.3520.30	402	03.4172.74	328	03.4187.74	274	03.4200.74	332
03.2603.WG	534	03.3538.02	400	03.4172.74.LE	329	03.4187.B1	274	03.4200.74.LE	333
03.2630.14A	532	03.3538.14	400	03.4172.B1	328	03.4187.BU	274	03.4200.B1	332
03.2630.29A	532	03.3538.30	400	03.4172.B1.LE	329	03.4187.CU	274	03.4200.B1.LE	333
03.2630.30A	532	03.3539.02	400	03.4172.BU	328	03.4187.GL	274	03.4200.BU	332

QUICK SEARCH OF PRODUCT

Ref.	Page	Ref.	Page	Ref.	Page	Ref.	Page	Ref.	Page
03.4200.BU.LE	333	03.4237.74	278	03.4311.14A	410	03.4497.CUB	301	03.4537.CU	263
03.4200.CU	332	03.4237.B1	278	03.4311.30A	410	03.4497.CUB1V	301	03.4537.GL	263
03.4200.CU.LE	333	03.4237.BU	278	03.4312.02A	410	03.4497.CUBDA	301	03.4538.74	266
03.4200.GL	332	03.4237.CU	278	03.4312.14A	410	03.4497.GLB	301	03.4538.74.LE	267
03.4200.GL.LE	333	03.4237.GL	278	03.4312.30A	410	03.4497.GLB1V	301	03.4538.B1	266
03.4201.74	332	03.4242.74	283	03.4313.02A	410	03.4497.GLBDA	301	03.4538.B1.LE	267
03.4201.B1	332	03.4242.B1	283	03.4313.14A	410	03.4498.74B	303	03.4538.BU	266
03.4201.BU	332	03.4242.BU	283	03.4313.30A	410	03.4498.74B1V	303	03.4538.BU.LE	267
03.4201.CU	332	03.4242.CU	283	03.4320.02B	411	03.4498.74BDA	303	03.4538.CU	266
03.4201.GL	332	03.4242.GL	283	03.4320.14B	411	03.4498.B1B	303	03.4538.CU.LE	267
03.4208.74	323	03.4243.74	283	03.4320.30B	411	03.4498.B1B1V	303	03.4538.GL	266
03.4208.B1	323	03.4243.B1	283	03.4321.02B	411	03.4498.B1BDA	303	03.4538.GL.LE	267
03.4208.BU	323	03.4243.BU	283	03.4321.14B	411	03.4498.BUB	303	03.4539.74	266
03.4208.CU	323	03.4243.CU	283	03.4321.30B	411	03.4498.BUB1V	303	03.4539.B1	266
03.4208.GL	323	03.4243.GL	283	03.4322.02B	411	03.4498.BUBDA	303	03.4539.BU	266
03.4209.74	323	03.4244.74	283	03.4322.14B	411	03.4498.CUB	303	03.4539.CU	266
03.4209.B1	323	03.4244.B1	283	03.4322.30B	411	03.4498.CUB1V	303	03.4539.GL	266
03.4209.BU	323	03.4244.BU	283	03.4331.02A	411	03.4498.CUBDA	303	03.4540.74	270
03.4209.CU	323	03.4244.CU	283	03.4331.14A	411	03.4498.GLB	303	03.4540.74.LE	271
03.4209.GL	323	03.4244.GL	283	03.4331.30A	411	03.4498.GLB1V	303	03.4540.B1	270
03.4210.74	323	03.4245.74	283	03.4332.02A	411	03.4498.GLBDA	303	03.4540.B1.LE	271
03.4210.B1	323	03.4245.B1	283	03.4332.14A	411	03.4520.11B	528	03.4540.BU	270
03.4210.BU	323	03.4245.BU	283	03.4332.30A	411	03.4520.ANB	528	03.4540.BU.LE	271
03.4210.CU	323	03.4245.CU	283	03.4333.02A	411	03.4520.ASB	528	03.4540.CU	270
03.4210.GL	323	03.4245.GL	283	03.4333.14A	411	03.4520.B3B	528	03.4540.CU.LE	271
03.4211.74	323	03.4287.74	311	03.4333.30A	411	03.4521.11B	528	03.4540.GL	270
03.4211.B1	323	03.4287.74.LE	312	03.4420.74C	299	03.4521.ANB	528	03.4540.GL.LE	271
03.4211.BU	323	03.4287.B1	311	03.4420.74C1V	299	03.4521.ASB	528	03.4541.74	270
03.4211.CU	323	03.4287.B1.LE	312	03.4420.74CDA	299	03.4521.B3B	528	03.4541.B1	270
03.4211.GL	323	03.4287.BU	311	03.4420.B1C	299	03.4522.11B	528	03.4541.BU	270
03.4212.74	336	03.4287.BU.LE	312	03.4420.B1C1V	299	03.4522.ANB	528	03.4541.CU	270
03.4212.B1	336	03.4287.CU	311	03.4420.B1CDA	299	03.4522.ASB	528	03.4541.GL	270
03.4212.BU	336	03.4287.CU.LE	312	03.4420.BUC	299	03.4522.B3B	528	03.4542.74	272
03.4212.CU	336	03.4287.GL	311	03.4420.BUC1V	299	03.4523.11B	528	03.4542.74.LE	273
03.4212.GL	336	03.4287.GL.LE	312	03.4420.BUCDA	299	03.4523.ANB	528	03.4542.B1	272
03.4213.74	336	03.4288.74	311	03.4420.CUC	299	03.4523.ASB	528	03.4542.B1.LE	273
03.4213.B1	336	03.4288.B1	311	03.4420.CUC1V	299	03.4523.B3B	528	03.4542.BU	272
03.4213.BU	336	03.4288.BU	311	03.4420.CUCDA	299	03.4530.74	253	03.4542.BU.LE	273
03.4213.CU	336	03.4288.CU	311	03.4420.GLC	299	03.4530.74.LE	254	03.4542.CU	272
03.4213.GL	336	03.4288.GL	311	03.4420.GLC1V	299	03.4530.B1	253	03.4542.CU.LE	273
03.4218.74	341	03.4293.74	330	03.4420.GLCDA	299	03.4530.B1.LE	254	03.4542.GL	272
03.4218.B1	341	03.4293.74.LE	331	03.4475.74C	303	03.4530.BU	253	03.4542.GL.LE	273
03.4218.BU	341	03.4293.B1	330	03.4475.74C1V	303	03.4530.BU.LE	254	03.4543.74	272
03.4218.CU	341	03.4293.B1.LE	331	03.4475.74CDA	303	03.4530.CU	253	03.4543.B1	272
03.4218.GL	341	03.4293.BU	330	03.4475.B1C	303	03.4530.CU.LE	254	03.4543.BU	272
03.4219.74	341	03.4293.BU.LE	331	03.4475.B1C1V	303	03.4530.GL	253	03.4543.CU	272
03.4219.B1	341	03.4293.CU	330	03.4475.B1CDA	303	03.4530.GL.LE	254	03.4543.GL	272
03.4219.BU	341	03.4293.CU.LE	331	03.4475.BUC	303	03.4531.74	253	03.4544.74	276
03.4219.CU	341	03.4293.GL	330	03.4475.BUC1V	303	03.4531.B1	253	03.4544.74.LE	277
03.4219.GL	341	03.4293.GL.LE	331	03.4475.BUCDA	303	03.4531.BU	253	03.4544.B1	276
03.4220.74	341	03.4294.74	330	03.4475.CUC	303	03.4531.CU	253	03.4544.B1.LE	277
03.4220.B1	341	03.4294.B1	330	03.4475.CUC1V	303	03.4531.GL	253	03.4544.BU	276
03.4220.BU	341	03.4294.BU	330	03.4475.CUCDA	303	03.4532.74	257	03.4544.BU.LE	277
03.4220.CU	341	03.4294.CU	330	03.4475.GLC	303	03.4532.74.LE	258	03.4544.CU	276
03.4220.GL	341	03.4294.GL	330	03.4475.GLC1V	303	03.4532.B1	257	03.4544.CU.LE	277
03.4221.74	341	03.4295.74	334	03.4475.GLCDA	303	03.4532.B1.LE	258	03.4544.GL	276
03.4221.B1	341	03.4295.74.LE	335	03.4482.74C	301	03.4532.BU	257	03.4544.GL.LE	277
03.4221.BU	341	03.4295.B1	334	03.4482.74C1V	301	03.4532.BU.LE	258	03.4545.74	276
03.4221.CU	341	03.4295.B1.LE	335	03.4482.74CDA	301	03.4532.CU	257	03.4545.B1	276
03.4221.GL	341	03.4295.BU	334	03.4482.B1C	301	03.4532.CU.LE	258	03.4545.BU	276
03.4226.74	265	03.4295.BU.LE	335	03.4482.B1C1V	301	03.4532.GL	257	03.4545.CU	276
03.4226.B1	265	03.4295.CU	334	03.4482.B1CDA	301	03.4532.GL.LE	258	03.4545.GL	276
03.4226.BU	265	03.4295.CU.LE	335	03.4482.BUC	301	03.4533.74	257	03.4570.74C	284
03.4226.CU	265	03.4295.GL	334	03.4482.BUC1V	301	03.4533.B1	257	03.4570.74C1V	284
03.4226.GL	265	03.4295.GL.LE	335	03.4482.BUCDA	301	03.4533.BU	257	03.4570.74CDA	284
03.4227.74	265	03.4296.74	334	03.4482.CUC	301	03.4533.CU	257	03.4570.B1C	284
03.4227.B1	265	03.4296.B1	334	03.4482.CUC1V	301	03.4533.GL	257	03.4570.B1C1V	284
03.4227.BU	265	03.4296.BU	334	03.4482.CUCDA	301	03.4534.74	259	03.4570.B1CDA	284
03.4227.CU	265	03.4296.CU	334	03.4482.GLC	301	03.4534.74.LE	260	03.4570.BUC	284
03.4227.GL	265	03.4296.GL	334	03.4482.GLC1V	301	03.4534.B1	259	03.4570.BUC1V	284
03.4228.74	265	03.4297.74	315	03.4482.GLCDA	301	03.4534.B1.LE	260	03.4570.BUCDA	284
03.4228.B1	265	03.4297.74.LE	316	03.4496.74B	299	03.4534.BU	259	03.4570.CUC	284
03.4228.BU	265	03.4297.B1	315	03.4496.74B1V	299	03.4534.BU.LE	260	03.4570.CUC1V	284
03.4228.CU	265	03.4297.B1.LE	316	03.4496.74BDA	299	03.4534.CU	259	03.4570.CUCDA	284
03.4228.GL	265	03.4297.BU	315	03.4496.B1B	299	03.4534.CU.LE	260	03.4570.GLC	284
03.4229.74	265	03.4297.BU.LE	316	03.4496.B1B1V	299	03.4534.GL	259	03.4570.GLC1V	284
03.4229.B1	265	03.4297.CU	315	03.4496.B1BDA	299	03.4534.GL.LE	260	03.4570.GLCDA	284
03.4229.BU	265	03.4297.CU.LE	316	03.4496.BUB	299	03.4535.74	259	03.4572.74	289
03.4229.CU	265	03.4297.GL	315	03.4496.BUB1V	299	03.4535.B1	259	03.4572.B1	289
03.4229.GL	265	03.4297.GL.LE	316	03.4496.BUBDA	299	03.4535.BU	259	03.4572.BU	289
03.4234.74	278	03.4298.74	315	03.4496.CUB	299	03.4535.CU	259	03.4572.CU	289
03.4234.B1	278	03.4298.B1	315	03.4496.CUB1V	299	03.4535.GL	259	03.4572.GL	289
03.4234.BU	278	03.4298.BU	315	03.4496.CUBDA	299	03.4536.74	263	03.4582.74	288
03.4234.CU	278	03.4298.CU	315	03.4496.GLB	299	03.4536.74.LE	264	03.4582.74.1V	288
03.4234.GL	278	03.4298.GL	315	03.4496.GLB1V	299	03.4536.B1	263	03.4582.74.DA	288
03.4235.74	278	03.4300.02B	410	03.4496.GLBDA	299	03.4536.B1.LE	264	03.4582.B1	288
03.4235.B1	278	03.4300.14B	410	03.4497.74B	301	03.4536.BU	263	03.4582.B1.1V	288
03.4235.BU	278	03.4300.30B	410	03.4497.74B1V	301	03.4536.BU.LE	264	03.4582.B1.DA	288
03.4235.CU	278	03.4301.02B	410	03.4497.74BDA	301	03.4536.CU	263	03.4582.BU	288
03.4235.GL	278	03.4301.14B	410	03.4497.B1B	301	03.4536.CU.LE	264	03.4582.BU.1V	288
03.4236.74	278	03.4301.30B	410	03.4497.B1B1V	301	03.4536.GL	263	03.4582.BU.DA	288
03.4236.B1	278	03.4302.02B	410	03.4497.B1BDA	301	03.4536.GL.LE	264	03.4582.CU	288
03.4236.BU	278	03.4302.14B	410	03.4497.BUB	301	03.4537.74	263	03.4582.CU.1V	288
03.4236.CU	278	03.4302.30B	410	03.4497.BUB1V	301	03.4537.B1	263	03.4582.CU.DA	288
03.4236.GL	278	03.4311.02A	410	03.4497.BUBDA	301	03.4537.BU	263	03.4582.GL	288

QUICK SEARCH OF PRODUCT

Ref.	Page	Ref.	Page	Ref.	Page	Ref.	Page	Ref.	Page
03.4582.GL.1V	288	03.4589.B1	304	03.4994.06A	368	03.5911.14	526	03.5950.B1	527
03.4582.GL.DA	288	03.4589.B1.1V	304	03.4994.06ADA	368	03.5911.18	526	03.5951.14	527
03.4583.74	288	03.4589.B1.DA	304	03.4994.14A	368	03.5911.B1	526	03.5951.18	527
03.4583.74.1V	288	03.4589.BU	304	03.4994.14ADA	368	03.5912.14	526	03.5951.B1	527
03.4583.74.DA	288	03.4589.BU.1V	304	03.4994.GLA	368	03.5912.18	526	03.5952.14	527
03.4583.B1	288	03.4589.BU.DA	304	03.4994.GLADA	368	03.5912.B1	526	03.5952.18	527
03.4583.B1.1V	288	03.4589.CU	304	03.4995.06	368	03.5913.14	526	03.5952.B1	527
03.4583.B1.DA	288	03.4589.CU.1V	304	03.4995.06.DA	368	03.5913.18	526	03.5953.14	527
03.4583.BU	288	03.4589.CU.DA	304	03.4995.14	368	03.5913.B1	526	03.5953.18	527
03.4583.BU.1V	288	03.4589.GL	304	03.4995.14.DA	368	03.5914.14	526	03.5953.B1	527
03.4583.BU.DA	288	03.4589.GL.1V	304	03.4995.14.DA	368	03.5914.18	526	03.5954.14	527
03.4583.CU	288	03.4589.GL.DA	304	03.4995.GL.DA	368	03.5914.B1	526	03.5954.18	527
03.4583.CU.1V	288	03.4595.74C	284	03.4996.06A	369	03.5915.14	526	03.5954.B1	527
03.4583.CU.DA	288	03.4595.74C1V	284	03.4996.06ADA	369	03.5915.18	526	03.5955.14	527
03.4583.GL	288	03.4595.74CDA	284	03.4996.14A	369	03.5915.B1	526	03.5955.18	527
03.4583.GL.1V	288	03.4595.B1C	284	03.4996.14ADA	369	03.5916.14	526	03.5955.B1	527
03.4583.GL.DA	288	03.4595.B1C1V	284	03.4996.GLA	369	03.5916.18	526	03.5956.14	527
03.4584.74	300	03.4595.B1CDA	284	03.4996.GLADA	369	03.5916.B1	526	03.5956.18	527
03.4584.74.1V	300	03.4595.BUC	284	03.4997.06	369	03.5917.14	526	03.5956.B1	527
03.4584.74.DA	300	03.4595.BUC1V	284	03.4997.06.DA	369	03.5917.18	526	03.5957.14	527
03.4584.B1	300	03.4595.BUCDA	284	03.4997.14	369	03.5917.B1	526	03.5957.18	527
03.4584.B1.1V	300	03.4595.CUC	284	03.4997.14.DA	369	03.5920.14	522	03.5957.B1	527
03.4584.B1.DA	300	03.4595.CUC1V	284	03.4997.GL	369	03.5920.18	522	03.6000.14	523
03.4584.BU	300	03.4595.CUCDA	284	03.4997.GL.DA	369	03.5920.B1	522	03.6000.14.DA	523
03.4584.BU.1V	300	03.4595.GLC	284	03.4998.06A	369	03.5921.14	522	03.6000.18	523
03.4584.BU.DA	300	03.4595.GLC1V	284	03.4998.06ADA	369	03.5921.18	522	03.6000.18.DA	523
03.4584.CU	300	03.4595.GLCDA	284	03.4998.14A	369	03.5921.B1	522	03.6000.B1	523
03.4584.CU.1V	300	03.4980.06A	368	03.4998.14ADA	369	03.5922.14	522	03.6000.B1.DA	523
03.4584.CU.DA	300	03.4980.06ADA	368	03.4998.GLA	369	03.5922.18	522	03.6001.14	523
03.4584.GL	300	03.4980.14A	368	03.4998.GLADA	369	03.5922.B1	522	03.6001.14.DA	523
03.4584.GL.1V	300	03.4980.14ADA	368	03.4999.06	369	03.5923.14	522	03.6001.18	523
03.4584.GL.DA	300	03.4980.GLA	368	03.4999.06.DA	369	03.5923.18	522	03.6001.18.DA	523
03.4585.74	300	03.4980.GLADA	368	03.4999.14	369	03.5923.B1	522	03.6001.B1	523
03.4585.74.1V	300	03.4981.06	368	03.4999.14.DA	369	03.5924.14	522	03.6001.B1.DA	523
03.4585.74.DA	300	03.4981.06.DA	368	03.4999.GL	369	03.5924.18	522	03.6002.14	523
03.4585.B1	300	03.4981.14	368	03.4999.GL.DA	369	03.5924.B1	522	03.6002.14.DA	523
03.4585.B1.1V	300	03.4981.14.DA	368	03.5730.11B	528	03.5925.14	522	03.6002.18	523
03.4585.B1.DA	300	03.4981.GL	368	03.5730.ANB	528	03.5925.18	522	03.6002.18.DA	523
03.4585.BU	300	03.4981.GL.DA	368	03.5730.ASB	528	03.5925.B1	522	03.6002.B1	523
03.4585.BU.1V	300	03.4982.06A	368	03.5730.B3B	528	03.5926.14	522	03.6002.B1.DA	523
03.4585.BU.DA	300	03.4982.06ADA	368	03.5731.11B	528	03.5926.18	522	03.6003.14	523
03.4585.CU	300	03.4982.14A	368	03.5731.ANB	528	03.5926.B1	522	03.6003.14.DA	523
03.4585.CU.1V	300	03.4982.14ADA	368	03.5731.ASB	528	03.5927.14	522	03.6003.18	523
03.4585.CU.DA	300	03.4982.GLA	368	03.5731.B3B	528	03.5927.18	522	03.6003.18.DA	523
03.4585.GL	300	03.4982.GLADA	368	03.5732.11B	528	03.5927.B1	522	03.6003.B1	523
03.4585.GL.1V	300	03.4983.06	368	03.5732.ANB	528	03.5930.14	525	03.6003.B1.DA	523
03.4585.GL.DA	300	03.4983.06.DA	368	03.5732.ASB	528	03.5930.18	525	03.6004.14	523
03.4586.74	302	03.4983.14	368	03.5732.B3B	528	03.5930.B1	525	03.6004.14.DA	523
03.4586.74.1V	302	03.4983.14.DA	368	03.5733.11B	528	03.5931.14	525	03.6004.18	523
03.4586.74.DA	302	03.4983.GL	368	03.5733.ANB	528	03.5931.18	525	03.6004.18.DA	523
03.4586.B1	302	03.4983.GL.DA	368	03.5733.ASB	528	03.5931.B1	525	03.6004.B1	523
03.4586.B1.1V	302	03.4984.06A	369	03.5733.B3B	528	03.5932.14	525	03.6004.B1.DA	523
03.4586.B1.DA	302	03.4984.06ADA	369	03.5810.11B	529	03.5932.18	525	03.6005.14	523
03.4586.BU	302	03.4984.14A	369	03.5810.ANB	529	03.5932.B1	525	03.6005.14.DA	523
03.4586.BU.1V	302	03.4984.14ADA	369	03.5810.ASB	529	03.5933.14	525	03.6005.18	523
03.4586.BU.DA	302	03.4984.GLA	369	03.5810.B3B	529	03.5933.18	525	03.6005.18.DA	523
03.4586.CU	302	03.4984.GLADA	369	03.5811.11B	529	03.5933.B1	525	03.6005.B1	523
03.4586.CU.1V	302	03.4985.06	369	03.5811.ANB	529	03.5934.14	525	03.6005.B1.DA	523
03.4586.CU.DA	302	03.4985.06.DA	369	03.5811.ASB	529	03.5934.18	525	03.6006.14	523
03.4586.GL	302	03.4985.14	369	03.5811.B3B	529	03.5934.B1	525	03.6006.14.DA	523
03.4586.GL.1V	302	03.4985.14.DA	369	03.5812.11B	529	03.5935.14	525	03.6006.18	523
03.4586.GL.DA	302	03.4985.GL	369	03.5812.ANB	529	03.5935.18	525	03.6006.18.DA	523
03.4587.74	302	03.4985.GL.DA	369	03.5812.ASB	529	03.5935.B1	525	03.6006.B1	523
03.4587.74.1V	302	03.4986.06A	369	03.5812.B3B	529	03.5936.14	525	03.6006.B1.DA	523
03.4587.74.DA	302	03.4986.06ADA	369	03.5813.11B	529	03.5936.18	525	03.6007.14	523
03.4587.B1	302	03.4986.14A	369	03.5813.ANB	529	03.5936.B1	525	03.6007.14.DA	523
03.4587.B1.1V	302	03.4986.14ADA	369	03.5813.ASB	529	03.5937.14	525	03.6007.18	523
03.4587.B1.DA	302	03.4986.GLA	369	03.5813.B3B	529	03.5937.18	525	03.6007.18.DA	523
03.4587.BU	302	03.4986.GLADA	369	03.5900.14	523	03.5937.B1	525	03.6007.B1	523
03.4587.BU.1V	302	03.4987.06	369	03.5900.18	523	03.5940.14	524	03.6007.B1.DA	523
03.4587.BU.DA	302	03.4987.06.DA	369	03.5900.B1	523	03.5940.18	524	03.6010.14	526
03.4587.CU	302	03.4987.14	369	03.5901.14	523	03.5940.B1	524	03.6010.14.DA	526
03.4587.CU.1V	302	03.4987.14.DA	369	03.5901.18	523	03.5941.14	524	03.6010.18	526
03.4587.CU.DA	302	03.4987.GL	369	03.5901.B1	523	03.5941.18	524	03.6010.18.DA	526
03.4587.GL	302	03.4987.GL.DA	369	03.5902.14	523	03.5941.B1	524	03.6010.B1	526
03.4587.GL.1V	302	03.4988.06A	370	03.5902.18	523	03.5942.14	524	03.6010.B1.DA	526
03.4587.GL.DA	302	03.4988.06ADA	370	03.5902.B1	523	03.5942.18	524	03.6011.14	526
03.4588.74	304	03.4989.06	370	03.5903.14	523	03.5942.B1	524	03.6011.14.DA	526
03.4588.74.1V	304	03.4989.06.DA	370	03.5903.18	523	03.5943.14	524	03.6011.18	526
03.4588.74.DA	304	03.4990.06A	370	03.5903.B1	523	03.5943.18	524	03.6011.18.DA	526
03.4588.B1	304	03.4990.06ADA	370	03.5904.14	523	03.5943.B1	524	03.6011.B1	526
03.4588.B1.1V	304	03.4991.06	370	03.5904.18	523	03.5944.14	524	03.6011.B1.DA	526
03.4588.B1.DA	304	03.4991.06.DA	370	03.5904.B1	523	03.5944.18	524	03.6012.14	526
03.4588.BU	304	03.4992.06A	368	03.5905.14	523	03.5944.B1	524	03.6012.14.DA	526
03.4588.BU.1V	304	03.4992.06ADA	368	03.5905.18	523	03.5945.14	524	03.6012.18	526
03.4588.BU.DA	304	03.4992.14A	368	03.5905.18	523	03.5945.18	524	03.6012.18.DA	526
03.4588.CU	304	03.4992.14ADA	368	03.5906.14	523	03.5945.B1	524	03.6012.B1	526
03.4588.CU.1V	304	03.4992.GLA	368	03.5906.18	523	03.5946.14	524	03.6012.B1.DA	526
03.4588.CU.DA	304	03.4992.GLADA	368	03.5906.B1	523	03.5946.18	524	03.6013.14	526
03.4588.GL	304	03.4993.06	368	03.5907.14	523	03.5946.B1	524	03.6013.14.DA	526
03.4588.GL.1V	304	03.4993.06.DA	368	03.5907.18	523	03.5947.14	524	03.6013.18	526
03.4588.GL.DA	304	03.4993.14	368	03.5907.B1	523	03.5947.18	524	03.6013.18.DA	526
03.4589.74	304	03.4993.14.DA	368	03.5910.14	526	03.5947.B1	524	03.6013.B1	526
03.4589.74.1V	304	03.4993.GL	368	03.5910.18	526	03.5950.14	527	03.6013.B1.DA	526
03.4589.74.DA	304	03.4993.GL.DA	368	03.5910.B1	526	03.5950.18	527	03.6014.14	526

QUICK SEARCH OF PRODUCT

Ref.	Page	Ref.	Page	Ref.	Page	Ref.	Page	Ref.	Page
03.6014.14.DA	526	03.6034.14	525	03.6053.B1.DA	527	03.6284.14	97	03.6512.40ADA	362
03.6014.18	526	03.6034.14.DA	525	03.6054.14	527	03.6284.14.CB	97	03.6514.14A	362
03.6014.18.DA	526	03.6034.18	525	03.6054.14.DA	527	03.6284.14ADA	97	03.6514.14ADA	362
03.6014.B1	526	03.6034.18.DA	525	03.6054.18	527	03.6284.40	97	03.6514.40A	362
03.6014.B1.DA	526	03.6034.B1	525	03.6054.18.DA	527	03.6284.40.CB	97	03.6514.40ADA	362
03.6015.14	526	03.6034.B1.DA	525	03.6054.B1	527	03.6284.40ADA	97	03.6520.14A	361
03.6015.14.DA	526	03.6035.14	525	03.6054.B1.DA	527	03.6285.14	97	03.6520.14ADA	361
03.6015.18	526	03.6035.14.DA	525	03.6055.14	527	03.6285.14.CB	97	03.6520.40A	361
03.6015.18.DA	526	03.6035.18	525	03.6055.14.DA	527	03.6285.14ADA	97	03.6520.40ADA	361
03.6015.B1	526	03.6035.18.DA	525	03.6055.18	527	03.6285.40	97	03.6521.14A	361
03.6015.B1.DA	526	03.6035.B1	525	03.6055.18.DA	527	03.6285.40.CB	97	03.6521.14ADA	361
03.6016.14	526	03.6035.B1.DA	525	03.6055.B1	527	03.6285.40ADA	97	03.6521.40A	361
03.6016.14.DA	526	03.6036.14	525	03.6055.B1.DA	527	03.6286.14	97	03.6521.40ADA	361
03.6016.18	526	03.6036.14.DA	525	03.6056.14	527	03.6286.14.CB	97	03.6523.14A	361
03.6016.18.DA	526	03.6036.18	525	03.6056.14.DA	527	03.6286.14ADA	97	03.6523.14ADA	361
03.6016.B1	526	03.6036.18.DA	525	03.6056.18	527	03.6286.40	97	03.6523.40A	361
03.6016.B1.DA	526	03.6036.B1	525	03.6056.18.DA	527	03.6286.40.CB	97	03.6523.40ADA	361
03.6017.14	526	03.6036.B1.DA	525	03.6056.B1	527	03.6286.40ADA	97	03.6524.14A	361
03.6017.14.DA	526	03.6037.14	525	03.6056.B1.DA	527	03.6287.14	97	03.6524.14ADA	361
03.6017.18	526	03.6037.14.DA	525	03.6057.14	527	03.6287.14.CB	97	03.6524.40A	361
03.6017.18.DA	526	03.6037.18	525	03.6057.14.DA	527	03.6287.14ADA	97	03.6524.40ADA	361
03.6017.B1	526	03.6037.18.DA	525	03.6057.18	527	03.6287.40	97	03.6526.14A	360
03.6017.B1.DA	526	03.6037.B1	525	03.6057.18.DA	527	03.6287.40.CB	97	03.6526.14ADA	360
03.6020.14	522	03.6037.B1.DA	525	03.6057.B1	527	03.6287.40ADA	97	03.6526.40A	360
03.6020.14.DA	522	03.6040.14	524	03.6057.B1.DA	527	03.6295.14	102	03.6526.40ADA	360
03.6020.18	522	03.6040.14.DA	524	03.6150.05	407	03.6295.14.CB	102	03.6527.14A	360
03.6020.18.DA	522	03.6040.18	524	03.6150.14	407	03.6295.14.DA	102	03.6527.14ADA	360
03.6020.B1	522	03.6040.18.DA	524	03.6150.30	407	03.6296.14	102	03.6527.40A	360
03.6020.B1.DA	522	03.6040.B1	524	03.6150.GN	407	03.6296.14.CB	102	03.6527.40ADA	360
03.6021.14	522	03.6040.B1.DA	524	03.6154.05A	407	03.6296.14.DA	102	03.6529.14A	360
03.6021.14.DA	522	03.6041.14	524	03.6154.14A	407	03.6297.14	102	03.6529.14ADA	360
03.6021.18	522	03.6041.14.DA	524	03.6154.30A	407	03.6297.14.CB	102	03.6529.40A	360
03.6021.18.DA	522	03.6041.18	524	03.6154.GNA	407	03.6297.14.DA	102	03.6529.40ADA	360
03.6021.B1	522	03.6041.18.DA	524	03.6170.05	501	03.6298.14	102	03.6530.14A	360
03.6021.B1.DA	522	03.6041.B1	524	03.6170.14	501	03.6298.14.CB	102	03.6530.14ADA	360
03.6022.14	522	03.6041.B1.DA	524	03.6170.30	501	03.6298.14.DA	102	03.6530.40A	360
03.6022.14.DA	522	03.6042.14	524	03.6170.GN	501	03.6302.14B	95	03.6530.40ADA	360
03.6022.18	522	03.6042.14.DA	524	03.6174.05A	501	03.6302.14BCB	95	03.6532.14A	362
03.6022.18.DA	522	03.6042.18	524	03.6174.14A	501	03.6302.14CDA	95	03.6532.14ADA	362
03.6022.B1	522	03.6042.18.DA	524	03.6174.30A	501	03.6303.14B	95	03.6532.40A	362
03.6022.B1.DA	522	03.6042.B1	524	03.6174.GNA	501	03.6303.14BCB	95	03.6532.40ADA	362
03.6023.14	522	03.6042.B1.DA	524	03.6260.14.CB	103	03.6303.14CDA	95	03.6534.14A	362
03.6023.14.DA	522	03.6043.14	524	03.6260.14ADA	103	03.6305.14	96	03.6534.14ADA	362
03.6023.18	522	03.6043.14.DA	524	03.6260.14B	103	03.6305.14.CB	96	03.6534.40A	362
03.6023.18.DA	522	03.6043.18	524	03.6261.14.CB	103	03.6305.14ADA	96	03.6534.40ADA	362
03.6023.B1	522	03.6043.18.DA	524	03.6261.14ADA	103	03.6306.14	96	03.6560.14A	364
03.6023.B1.DA	522	03.6043.B1	524	03.6261.14B	103	03.6306.14.CB	96	03.6560.14ADA	364
03.6024.14	522	03.6043.B1.DA	524	03.6262.14.CB	103	03.6306.14ADA	96	03.6560.40A	364
03.6024.14.DA	522	03.6044.14	524	03.6262.14ADA	103	03.6415.05B	405	03.6560.40ADA	364
03.6024.18	522	03.6044.14.DA	524	03.6262.14B	103	03.6415.14B	405	03.6561.14A	364
03.6024.18.DA	522	03.6044.18	524	03.6263.14.CB	103	03.6415.40B	405	03.6561.14ADA	364
03.6024.B1	522	03.6044.18.DA	524	03.6263.14ADA	103	03.6416.05B	405	03.6561.40A	364
03.6024.B1.DA	522	03.6044.B1	524	03.6263.14B	103	03.6416.14B	405	03.6561.40ADA	364
03.6025.14	522	03.6044.B1.DA	524	03.6272.06D	104	03.6416.40B	405	03.6562.14	364
03.6025.14.DA	522	03.6045.14	524	03.6272.06DCB	104	03.6417.05B	405	03.6562.14.DA	364
03.6025.18	522	03.6045.14.DA	524	03.6272.06EDA	104	03.6417.14B	405	03.6562.40	364
03.6025.18.DA	522	03.6045.18	524	03.6272.14D	104	03.6417.40B	405	03.6562.40.DA	364
03.6025.B1	522	03.6045.18.DA	524	03.6272.14DCB	104	03.6418.05B	405	03.6563.14	364
03.6025.B1.DA	522	03.6045.B1	524	03.6272.14EDA	104	03.6418.14B	405	03.6563.14.DA	364
03.6026.14	522	03.6045.B1.DA	524	03.6272.30D	104	03.6418.40B	405	03.6563.40	364
03.6026.14.DA	522	03.6046.14	524	03.6272.30DCB	104	03.6500.14A	361	03.6563.40.DA	364
03.6026.18	522	03.6046.14.DA	524	03.6272.30EDA	104	03.6500.14ADA	361	03.6564.14A	363
03.6026.18.DA	522	03.6046.18	524	03.6273.06D	104	03.6500.40A	361	03.6564.14ADA	363
03.6026.B1	522	03.6046.18.DA	524	03.6273.06DCB	104	03.6500.40ADA	361	03.6564.40A	363
03.6026.B1.DA	522	03.6046.B1	524	03.6273.06EDA	104	03.6501.14A	361	03.6564.40ADA	363
03.6027.14	522	03.6046.B1.DA	524	03.6273.14D	104	03.6501.14ADA	361	03.6565.14A	363
03.6027.14.DA	522	03.6047.14	524	03.6273.14DCB	104	03.6501.40A	361	03.6565.14ADA	363
03.6027.18	522	03.6047.14.DA	524	03.6273.14EDA	104	03.6501.40ADA	361	03.6565.40A	363
03.6027.18.DA	522	03.6047.18	524	03.6273.30D	104	03.6503.14A	361	03.6565.40ADA	363
03.6027.B1	522	03.6047.18.DA	524	03.6273.30DCB	104	03.6503.14ADA	361	03.6566.14	363
03.6027.B1.DA	522	03.6047.B1	524	03.6273.30EDA	104	03.6503.40A	361	03.6566.14.DA	363
03.6030.14	525	03.6047.B1.DA	524	03.6274.14A	104	03.6503.40ADA	361	03.6566.40	363
03.6030.14.DA	525	03.6050.14	527	03.6274.14ACB	104	03.6504.14A	361	03.6566.40.DA	363
03.6030.18	525	03.6050.14.DA	527	03.6274.14ADA	104	03.6504.14ADA	361	03.6567.14	363
03.6030.18.DA	525	03.6050.18	527	03.6274.40A	104	03.6504.40A	361	03.6567.14.DA	363
03.6030.B1	525	03.6050.18.DA	527	03.6274.40ACB	104	03.6504.40ADA	361	03.6567.40	363
03.6030.B1.DA	525	03.6050.B1	527	03.6274.40ADA	104	03.6506.14A	360	03.6567.40.DA	363
03.6031.14	525	03.6050.B1.DA	527	03.6275.14A	104	03.6506.14ADA	360	03.6568.14A	365
03.6031.14.DA	525	03.6051.14	527	03.6275.14ACB	104	03.6506.40A	360	03.6568.14ADA	365
03.6031.18	525	03.6051.14.DA	527	03.6275.14ADA	104	03.6506.40ADA	360	03.6568.40A	365
03.6031.18.DA	525	03.6051.18	527	03.6275.40A	104	03.6507.14A	360	03.6568.40ADA	365
03.6031.B1	525	03.6051.18.DA	527	03.6275.40ACB	104	03.6507.14ADA	360	03.6569.14	365
03.6031.B1.DA	525	03.6051.B1	527	03.6275.40ADA	104	03.6507.40A	360	03.6569.14.DA	365
03.6032.14	525	03.6051.B1.DA	527	03.6277.14A	104	03.6507.40ADA	360	03.6569.40	365
03.6032.14.DA	525	03.6052.14	527	03.6277.14ACB	104	03.6509.14A	360	03.6569.40.DA	365
03.6032.18	525	03.6052.14.DA	527	03.6277.14ADA	104	03.6509.14ADA	360	03.6570.14A	364
03.6032.18.DA	525	03.6052.18	527	03.6277.40A	104	03.6509.40A	360	03.6570.14ADA	364
03.6032.B1	525	03.6052.18.DA	527	03.6277.40ACB	104	03.6509.40ADA	360	03.6570.40A	364
03.6032.B1.DA	525	03.6052.B1	527	03.6277.40ADA	104	03.6510.14A	360	03.6570.40ADA	364
03.6033.14	525	03.6052.B1.DA	527	03.6278.14A	104	03.6510.14ADA	360	03.6571.14A	364
03.6033.14.DA	525	03.6053.14	527	03.6278.14ACB	104	03.6510.40A	360	03.6571.14ADA	364
03.6033.18	525	03.6053.14.DA	527	03.6278.14ADA	104	03.6510.40ADA	360	03.6571.40A	364
03.6033.18.DA	525	03.6053.18	527	03.6278.40A	104	03.6512.14A	362	03.6571.40ADA	364
03.6033.B1	525	03.6053.18.DA	527	03.6278.40ACB	104	03.6512.14ADA	362	03.6572.14	364
03.6033.B1.DA	525	03.6053.B1	527	03.6278.40ADA	104	03.6512.40A	362	03.6572.14.DA	364

QUICK SEARCH OF PRODUCT

Ref.	Page	Ref.	Page	Ref.	Page	Ref.	Page	Ref.	Page
03.6572.40	364	03.6620.14.DA	384	03.6812.3BA	389	03.7005.14	94	03.7321.40A	205
03.6572.40.DA	364	03.6620.40	384	03.6812.3BADA	389	03.7005.14.CB	94	03.7321.40ADA	205
03.6573.14	364	03.6620.40.DA	384	03.6812.3CA	389	03.7005.14ADA	94	03.7322.14A	205
03.6573.14.DA	364	03.6621.14	384	03.6812.3CADA	389	03.7006.14	94	03.7322.14ADA	205
03.6573.40	364	03.6621.14.DA	384	03.6813.1BA	389	03.7006.14.CB	94	03.7322.40A	205
03.6573.40.DA	364	03.6621.40	384	03.6813.1BADA	389	03.7006.14ADA	94	03.7322.40ADA	205
03.6574.14A	363	03.6621.40.DA	384	03.6813.1CA	389	03.7007.14	94	03.7323.14A	205
03.6574.14ADA	363	03.6622.14	384	03.6813.1CADA	389	03.7007.14.CB	94	03.7323.14ADA	205
03.6574.40A	363	03.6622.14.DA	384	03.6813.3BA	389	03.7007.14ADA	94	03.7323.40A	205
03.6574.40ADA	363	03.6622.40	384	03.6813.3BADA	389	03.7300.14A	201	03.7323.40ADA	205
03.6575.14A	363	03.6622.40.DA	384	03.6813.3CA	389	03.7300.14ADA	201	03.7324.14A	207
03.6575.14ADA	363	03.6623.14	384	03.6813.3CADA	389	03.7300.40A	201	03.7324.14ADA	207
03.6575.40A	363	03.6623.14.DA	384	03.6814.1BA	389	03.7300.40ADA	201	03.7324.40A	207
03.6575.40ADA	363	03.6623.40	384	03.6814.1BADA	389	03.7301.14A	201	03.7324.40ADA	207
03.6576.14	363	03.6623.40.DA	384	03.6814.1CA	389	03.7301.14ADA	201	03.7325.14A	207
03.6576.14.DA	363	03.6625.06	383	03.6814.1CADA	389	03.7301.40A	201	03.7325.14ADA	207
03.6576.40	363	03.6625.06.DA	383	03.6814.3BA	389	03.7301.40ADA	201	03.7325.40A	207
03.6576.40.DA	363	03.6625.40	383	03.6814.3BADA	389	03.7302.14A	201	03.7325.40ADA	207
03.6577.14	363	03.6625.40.DA	383	03.6814.3CA	389	03.7302.14ADA	201	03.7326.14A	207
03.6577.14.DA	363	03.6626.06	383	03.6814.3CADA	389	03.7302.40A	201	03.7326.14ADA	207
03.6577.40	363	03.6626.06.DA	383	03.6815.14A	388	03.7302.40ADA	201	03.7326.40A	207
03.6577.40.DA	363	03.6626.40	383	03.6815.14ADA	388	03.7303.14A	201	03.7326.40ADA	207
03.6578.14A	365	03.6626.40.DA	383	03.6815.40A	388	03.7303.14ADA	201	03.7327.14A	207
03.6578.14ADA	365	03.6628.06	385	03.6815.40ADA	388	03.7303.40A	201	03.7327.14ADA	207
03.6578.40A	365	03.6628.06.DA	385	03.6816.14A	388	03.7303.40ADA	201	03.7327.40A	207
03.6578.40ADA	365	03.6628.40	385	03.6816.14ADA	388	03.7304.14A	201	03.7327.40ADA	207
03.6579.14	365	03.6628.40.DA	385	03.6816.40A	388	03.7304.14ADA	201	03.7328.14A	207
03.6579.14.DA	365	03.6629.06	385	03.6816.40ADA	388	03.7304.40A	201	03.7328.14ADA	207
03.6579.40	365	03.6629.06.DA	385	03.6817.14A	388	03.7304.40ADA	201	03.7328.40A	207
03.6579.40.DA	365	03.6629.40	385	03.6817.14ADA	388	03.7305.14A	201	03.7328.40ADA	207
03.6603.14	384	03.6629.40.DA	385	03.6817.40A	388	03.7305.14ADA	201	03.7329.14A	207
03.6603.14.DA	384	03.6800.14A	388	03.6817.40ADA	388	03.7305.40A	201	03.7329.14ADA	207
03.6603.40	384	03.6800.14ADA	388	03.6818.14A	387	03.7305.40ADA	201	03.7329.40A	207
03.6603.40.DA	384	03.6800.40A	388	03.6818.14ADA	387	03.7306.14A	201	03.7329.40ADA	207
03.6604.14	384	03.6800.40ADA	388	03.6818.40A	387	03.7306.14ADA	201	03.7330.14A	207
03.6604.14.DA	384	03.6801.14A	388	03.6818.40ADA	387	03.7306.40A	201	03.7330.14ADA	207
03.6604.40	384	03.6801.14ADA	388	03.6819.14A	387	03.7306.40ADA	201	03.7330.40A	207
03.6604.40.DA	384	03.6801.40A	388	03.6819.14ADA	387	03.7307.14A	201	03.7330.40ADA	207
03.6605.14	384	03.6801.40ADA	388	03.6819.40A	387	03.7307.14ADA	201	03.7331.14A	207
03.6605.14.DA	384	03.6802.14A	388	03.6819.40ADA	387	03.7307.40A	201	03.7331.14ADA	207
03.6605.40	384	03.6802.14ADA	388	03.6820.14A	387	03.7307.40ADA	201	03.7331.40A	207
03.6605.40.DA	384	03.6802.40A	388	03.6820.14ADA	387	03.7308.14A	203	03.7331.40ADA	207
03.6606.14	384	03.6802.40ADA	388	03.6820.40A	387	03.7308.14ADA	203	03.7350.14A	209
03.6606.14.DA	384	03.6803.14A	387	03.6820.40ADA	387	03.7308.40A	203	03.7350.14ADA	209
03.6606.40	384	03.6803.14ADA	387	03.6821.14A	387	03.7308.40ADA	203	03.7350.40A	209
03.6606.40.DA	384	03.6803.40A	387	03.6821.14ADA	387	03.7309.14A	203	03.7350.40ADA	209
03.6607.14	384	03.6803.40ADA	387	03.6821.40A	387	03.7309.14ADA	203	03.7351.14A	209
03.6607.14.DA	384	03.6804.14A	387	03.6821.40ADA	387	03.7309.40A	203	03.7351.14ADA	209
03.6607.40	384	03.6804.14ADA	387	03.6822.14A	387	03.7309.40ADA	203	03.7351.40A	209
03.6607.40.DA	384	03.6804.40A	387	03.6822.14ADA	387	03.7310.14A	203	03.7351.40ADA	209
03.6608.14	384	03.6804.40ADA	387	03.6822.40A	387	03.7310.14ADA	203	03.7352.14A	209
03.6608.14.DA	384	03.6805.14A	387	03.6822.40ADA	387	03.7310.40A	203	03.7352.14ADA	209
03.6608.40	384	03.6805.14ADA	387	03.6823.14A	387	03.7310.40ADA	203	03.7352.40A	209
03.6608.40.DA	384	03.6805.40A	387	03.6823.14ADA	387	03.7311.14A	203	03.7352.40ADA	209
03.6610.1B	383	03.6805.40ADA	387	03.6823.40A	387	03.7311.14ADA	203	03.7353.14A	209
03.6610.1B.DA	383	03.6806.14A	387	03.6823.40ADA	387	03.7311.40A	203	03.7353.14ADA	209
03.6610.1C	383	03.6806.14ADA	387	03.6824.06A	386	03.7311.40ADA	203	03.7353.40A	209
03.6610.1C.DA	383	03.6806.40A	387	03.6824.06ADA	386	03.7312.14A	203	03.7353.40ADA	209
03.6610.3B	383	03.6806.40ADA	387	03.6824.40A	386	03.7312.14ADA	203	03.7354.14A	209
03.6610.3B.DA	383	03.6807.14A	387	03.6824.40ADA	386	03.7312.40A	203	03.7354.14ADA	209
03.6610.3C	383	03.6807.14ADA	387	03.6825.06A	386	03.7312.40ADA	203	03.7354.40A	209
03.6610.3C.DA	383	03.6807.40A	387	03.6825.06ADA	386	03.7313.14A	203	03.7354.40ADA	209
03.6611.1B	383	03.6807.40ADA	387	03.6825.40A	386	03.7313.14ADA	203	03.7355.14A	209
03.6611.1B.DA	383	03.6808.14A	387	03.6825.40ADA	386	03.7313.40A	203	03.7355.14ADA	209
03.6611.1C	383	03.6808.14ADA	387	03.6826.06A	386	03.7313.40ADA	203	03.7355.40A	209
03.6611.1C.DA	383	03.6808.40A	387	03.6826.06ADA	386	03.7314.14A	203	03.7355.40ADA	209
03.6611.3B	383	03.6808.40ADA	387	03.6826.40A	386	03.7314.14ADA	203	03.7356.14A	209
03.6611.3B.DA	383	03.6809.1BA	386	03.6826.40ADA	386	03.7314.40A	203	03.7356.14ADA	209
03.6611.3C	383	03.6809.1BADA	386	03.6827.06A	389	03.7314.40ADA	203	03.7356.40A	209
03.6611.3C.DA	383	03.6809.1CA	386	03.6827.06ADA	389	03.7315.14A	203	03.7356.40ADA	209
03.6613.1B	385	03.6809.1CADA	386	03.6827.40A	389	03.7315.14ADA	203	03.7357.14A	209
03.6613.1B.DA	385	03.6809.3BA	386	03.6827.40ADA	389	03.7315.40A	203	03.7357.14ADA	209
03.6613.1C	385	03.6809.3BADA	386	03.6828.06A	389	03.7315.40ADA	203	03.7357.40A	209
03.6613.1C.DA	385	03.6809.3CA	386	03.6828.06ADA	389	03.7316.14A	205	03.7357.40ADA	209
03.6613.3B	385	03.6809.3CADA	386	03.6828.40A	389	03.7316.14ADA	205	03.7358.14A	211
03.6613.3B.DA	385	03.6810.1BA	386	03.6828.40ADA	389	03.7316.40A	205	03.7358.14ADA	211
03.6613.3C	385	03.6810.1BADA	386	03.6829.06A	389	03.7316.40ADA	205	03.7358.40A	211
03.6613.3C.DA	385	03.6810.1CA	386	03.6829.06ADA	389	03.7317.14A	205	03.7358.40ADA	211
03.6614.1B	385	03.6810.1CADA	386	03.6829.40A	389	03.7317.14ADA	205	03.7359.14A	211
03.6614.1B.DA	385	03.6810.3BA	386	03.6829.40ADA	389	03.7317.40A	205	03.7359.14ADA	211
03.6614.1C	385	03.6810.3BADA	386	03.7000.14	94	03.7317.40ADA	205	03.7359.40A	211
03.6614.1C.DA	385	03.6810.3CA	386	03.7000.14.CB	94	03.7318.14A	205	03.7359.40ADA	211
03.6614.3B	385	03.6810.3CADA	386	03.7000.14ADA	94	03.7318.14ADA	205	03.7360.14A	211
03.6614.3B.DA	385	03.6811.1BA	386	03.7001.14	94	03.7318.40A	205	03.7360.14ADA	211
03.6614.3C	385	03.6811.1BADA	386	03.7001.14.CB	94	03.7318.40ADA	205	03.7360.40A	211
03.6614.3C.DA	385	03.6811.1CA	386	03.7001.14ADA	94	03.7319.14A	205	03.7360.40ADA	211
03.6618.14	384	03.6811.1CADA	386	03.7002.14	94	03.7319.14ADA	205	03.7361.14A	211
03.6618.14.DA	384	03.6811.3BA	386	03.7002.14.CB	94	03.7319.40A	205	03.7361.14ADA	211
03.6618.40	384	03.6811.3BADA	386	03.7002.14ADA	94	03.7319.40ADA	205	03.7361.40A	211
03.6618.40.DA	384	03.6811.3CA	386	03.7003.14	94	03.7320.14A	205	03.7361.40ADA	211
03.6619.14	384	03.6811.3CADA	386	03.7003.14.CB	94	03.7320.14ADA	205	03.7362.14A	211
03.6619.14.DA	384	03.6812.1BA	389	03.7003.14ADA	94	03.7320.40A	205	03.7362.14ADA	211
03.6619.40	384	03.6812.1BADA	389	03.7004.14	94	03.7320.40ADA	205	03.7362.40A	211
03.6619.40.DA	384	03.6812.1CA	389	03.7004.14.CB	94	03.7321.14A	205	03.7362.40ADA	211
03.6620.14	384	03.6812.1CADA	389	03.7004.14ADA	94	03.7321.14ADA	205	03.7363.14A	211

QUICK SEARCH OF PRODUCT

Ref.	Page	Ref.	Page	Ref.	Page	Ref.	Page	Ref.	Page
03.7363.14ADA	211	03.8005.14	119	03.8033.05A1V	120	03.8045.05A1V	21	03.8055.05A	122
03.7363.40A	211	03.8005.14.1V	119	03.8033.05ACB	20	03.8045.05A1V	121	03.8055.05A1V	22
03.7363.40ADA	211	03.8005.14.CB	119	03.8033.05ACB	120	03.8045.05ACB	21	03.8055.05A1V	122
03.7364.14A	211	03.8005.14.DA	119	03.8033.05ADA	20	03.8045.05ACB	121	03.8055.05ACB	22
03.7364.14ADA	211	03.8006.14	119	03.8033.05ADA	120	03.8045.05ADA	21	03.8055.05ACB	122
03.7364.40A	211	03.8006.14.1V	119	03.8033.14A	20	03.8045.05ADA	121	03.8055.05ADA	22
03.7364.40ADA	211	03.8006.14.CB	119	03.8033.14A	120	03.8045.14A	21	03.8055.05ADA	122
03.7365.14A	211	03.8006.14.DA	119	03.8033.14A1V	20	03.8045.14A	121	03.8055.14A	22
03.7365.14ADA	211	03.8007.14	119	03.8033.14A1V	120	03.8045.14A1V	21	03.8055.14A	122
03.7365.40A	211	03.8007.14.1V	119	03.8033.14ACB	20	03.8045.14A1V	121	03.8055.14A1V	22
03.7365.40ADA	211	03.8007.14.CB	119	03.8033.14ACB	120	03.8045.14ACB	21	03.8055.14A1V	122
03.7366.14A	213	03.8007.14.DA	119	03.8033.14ADA	20	03.8045.14ACB	121	03.8055.14ACB	22
03.7366.14ADA	213	03.8008.14	119	03.8033.14ADA	120	03.8045.14ADA	21	03.8055.14ACB	122
03.7366.40A	213	03.8008.14.1V	119	03.8033.40A	20	03.8045.14ADA	121	03.8055.14ADA	22
03.7366.40ADA	213	03.8008.14.CB	119	03.8033.40A	120	03.8045.40A	21	03.8055.14ADA	122
03.7367.14A	213	03.8008.14.DA	119	03.8033.40A1V	20	03.8045.40A	121	03.8055.40A	22
03.7367.14ADA	213	03.8009.14	119	03.8033.40A1V	120	03.8045.40A1V	21	03.8055.40A	122
03.7367.40A	213	03.8009.14.1V	119	03.8033.40ACB	20	03.8045.40A1V	121	03.8055.40A1V	22
03.7367.40ADA	213	03.8009.14.CB	119	03.8033.40ACB	120	03.8045.40ACB	21	03.8055.40A1V	122
03.7368.14A	213	03.8009.14.DA	119	03.8033.40ADA	20	03.8045.40ACB	121	03.8055.40ACB	22
03.7368.14ADA	213	03.8025.05	125	03.8033.40ADA	120	03.8045.40ADA	21	03.8055.40ACB	122
03.7368.40A	213	03.8025.05.1V	125	03.8042.05A	21	03.8045.40ADA	121	03.8055.40ADA	22
03.7368.40ADA	213	03.8025.05.CB	125	03.8042.05A	121	03.8052.05A	22	03.8055.40ADA	122
03.7369.14A	213	03.8025.05.DA	125	03.8042.05A1V	21	03.8052.05A	122	03.8072.05	24
03.7369.14ADA	213	03.8025.14	125	03.8042.05A1V	121	03.8052.05A1V	22	03.8072.05	124
03.7369.40A	213	03.8025.14.1V	125	03.8042.05ACB	21	03.8052.05A1V	122	03.8072.05.1V	24
03.7369.40ADA	213	03.8025.14.CB	125	03.8042.05ACB	121	03.8052.05ACB	22	03.8072.05.1V	124
03.7370.14A	213	03.8025.14.DA	125	03.8042.05ADA	21	03.8052.05ACB	122	03.8072.05.CB	24
03.7370.14ADA	213	03.8025.40	125	03.8042.05ADA	121	03.8052.05ADA	22	03.8072.05.CB	124
03.7370.40A	213	03.8025.40.1V	125	03.8042.14A	21	03.8052.05ADA	122	03.8072.05.DA	24
03.7370.40ADA	213	03.8025.40.CB	125	03.8042.14A	121	03.8052.14A	22	03.8072.05.DA	124
03.7371.14A	213	03.8025.40.DA	125	03.8042.14A1V	21	03.8052.14A	122	03.8072.14	24
03.7371.14ADA	213	03.8026.05	125	03.8042.14A1V	121	03.8052.14A1V	22	03.8072.14	124
03.7371.40A	213	03.8026.05.1V	125	03.8042.14ACB	21	03.8052.14A1V	122	03.8072.14.1V	24
03.7371.40ADA	213	03.8026.05.CB	125	03.8042.14ACB	121	03.8052.14ACB	22	03.8072.14.1V	124
03.7372.14A	213	03.8026.05.DA	125	03.8042.14ADA	21	03.8052.14ACB	122	03.8072.14.CB	24
03.7372.14ADA	213	03.8026.14	125	03.8042.14ADA	121	03.8052.14ADA	22	03.8072.14.CB	124
03.7372.40A	213	03.8026.14.1V	125	03.8042.40A	21	03.8052.14ADA	122	03.8072.14.DA	24
03.7372.40ADA	213	03.8026.14.CB	125	03.8042.40A	121	03.8052.40A	22	03.8072.14.DA	124
03.7373.14A	213	03.8026.14.DA	125	03.8042.40A1V	21	03.8052.40A	122	03.8072.40	24
03.7373.14ADA	213	03.8026.40	125	03.8042.40A1V	121	03.8052.40A1V	22	03.8072.40	124
03.7373.40A	213	03.8026.40.1V	125	03.8042.40ACB	21	03.8052.40A1V	122	03.8072.40.1V	24
03.7373.40ADA	213	03.8026.40.CB	125	03.8042.40ACB	121	03.8052.40ACB	22	03.8072.40.1V	124
03.7374.14A	215	03.8026.40.DA	125	03.8042.40ADA	21	03.8052.40ACB	122	03.8072.40.CB	24
03.7374.14ADA	215	03.8027.05	125	03.8042.40ADA	121	03.8052.40ADA	22	03.8072.40.CB	124
03.7374.40A	215	03.8027.05.1V	125	03.8043.05A	21	03.8052.40ADA	122	03.8072.40.DA	24
03.7374.40ADA	215	03.8027.05.CB	125	03.8043.05A	121	03.8053.05A	22	03.8072.40.DA	124
03.7375.14A	215	03.8027.05.DA	125	03.8043.05A1V	21	03.8053.05A	122	03.8073.05	24
03.7375.14ADA	215	03.8027.14	125	03.8043.05A1V	121	03.8053.05A1V	22	03.8073.05	124
03.7375.40A	215	03.8027.14.1V	125	03.8043.05ACB	21	03.8053.05A1V	122	03.8073.05.1V	24
03.7375.40ADA	215	03.8027.14.CB	125	03.8043.05ACB	121	03.8053.05ACB	22	03.8073.05.1V	124
03.7376.14A	215	03.8027.14.DA	125	03.8043.05ADA	21	03.8053.05ACB	122	03.8073.05.CB	24
03.7376.14ADA	215	03.8027.40	125	03.8043.05ADA	121	03.8053.05ADA	22	03.8073.05.CB	124
03.7376.40A	215	03.8027.40.1V	125	03.8043.14A	21	03.8053.05ADA	122	03.8073.05.DA	24
03.7376.40ADA	215	03.8027.40.CB	125	03.8043.14A	121	03.8053.14A	22	03.8073.05.DA	124
03.7377.14A	215	03.8027.40.DA	125	03.8043.14A1V	21	03.8053.14A	122	03.8073.14	24
03.7377.14ADA	215	03.8028.05	125	03.8043.14A1V	121	03.8053.14A1V	22	03.8073.14	124
03.7377.40A	215	03.8028.05.1V	125	03.8043.14ACB	21	03.8053.14A1V	122	03.8073.14.1V	24
03.7377.40ADA	215	03.8028.05.CB	125	03.8043.14ACB	121	03.8053.14ACB	22	03.8073.14.1V	124
03.7378.14A	215	03.8028.05.DA	125	03.8043.14ADA	21	03.8053.14ACB	122	03.8073.14.CB	24
03.7378.14ADA	215	03.8028.14	125	03.8043.14ADA	121	03.8053.14ADA	22	03.8073.14.CB	124
03.7378.40A	215	03.8028.14.1V	125	03.8043.40A	21	03.8053.14ADA	122	03.8073.14.DA	24
03.7378.40ADA	215	03.8028.14.CB	125	03.8043.40A	121	03.8053.40A	22	03.8073.14.DA	124
03.7379.14A	215	03.8028.14.DA	125	03.8043.40A1V	21	03.8053.40A	122	03.8073.40	24
03.7379.14ADA	215	03.8028.40	125	03.8043.40A1V	121	03.8053.40A1V	22	03.8073.40	124
03.7379.40A	215	03.8028.40.1V	125	03.8043.40ACB	21	03.8053.40A1V	122	03.8073.40.1V	24
03.7379.40ADA	215	03.8028.40.CB	125	03.8043.40ACB	121	03.8053.40ACB	22	03.8073.40.1V	124
03.7380.14A	215	03.8028.40.DA	125	03.8043.40ADA	21	03.8053.40ACB	122	03.8073.40.CB	24
03.7380.14ADA	215	03.8032.05A	20	03.8043.40ADA	121	03.8053.40ADA	22	03.8073.40.CB	124
03.7380.40A	215	03.8032.05A	120	03.8044.05A	21	03.8053.40ADA	122	03.8073.40.DA	24
03.7380.40ADA	215	03.8032.05A1V	20	03.8044.05A	121	03.8054.05A	22	03.8073.40.DA	124
03.7381.14A	215	03.8032.05A1V	120	03.8044.05A1V	21	03.8054.05A	122	03.8074.05	24
03.7381.14ADA	215	03.8032.05ACB	20	03.8044.05A1V	121	03.8054.05A1V	22	03.8074.05	124
03.7381.40A	215	03.8032.05ACB	120	03.8044.05ACB	21	03.8054.05A1V	122	03.8074.05.1V	24
03.7381.40ADA	215	03.8032.05ADA	20	03.8044.05ACB	121	03.8054.05ACB	22	03.8074.05.1V	124
03.8000.14	119	03.8032.05ADA	120	03.8044.05ADA	21	03.8054.05ACB	122	03.8074.05.CB	24
03.8000.14.1V	119	03.8032.14A	20	03.8044.05ADA	121	03.8054.05ADA	22	03.8074.05.CB	124
03.8000.14.CB	119	03.8032.14A	120	03.8044.14A	21	03.8054.05ADA	122	03.8074.05.DA	24
03.8000.14.DA	119	03.8032.14A1V	20	03.8044.14A	121	03.8054.14A	22	03.8074.05.DA	124
03.8001.14	119	03.8032.14A1V	120	03.8044.14A1V	21	03.8054.14A	122	03.8074.14	24
03.8001.14.1V	119	03.8032.14ACB	20	03.8044.14A1V	121	03.8054.14A1V	22	03.8074.14	124
03.8001.14.CB	119	03.8032.14ACB	120	03.8044.14ACB	21	03.8054.14A1V	122	03.8074.14.1V	24
03.8001.14.DA	119	03.8032.14ADA	20	03.8044.14ACB	121	03.8054.14ACB	22	03.8074.14.1V	124
03.8002.14	119	03.8032.14ADA	120	03.8044.14ADA	21	03.8054.14ACB	122	03.8074.14.CB	24
03.8002.14.1V	119	03.8032.40A	20	03.8044.14ADA	121	03.8054.14ADA	22	03.8074.14.CB	124
03.8002.14.CB	119	03.8032.40A	120	03.8044.40A	21	03.8054.14ADA	122	03.8074.14.DA	24
03.8002.14.DA	119	03.8032.40A1V	20	03.8044.40A	121	03.8054.40A	22	03.8074.14.DA	124
03.8003.14	119	03.8032.40A1V	120	03.8044.40A1V	21	03.8054.40A	122	03.8074.40	24
03.8003.14.1V	119	03.8032.40ACB	20	03.8044.40A1V	121	03.8054.40A1V	22	03.8074.40	124
03.8003.14.CB	119	03.8032.40ACB	120	03.8044.40ACB	21	03.8054.40A1V	122	03.8074.40.1V	24
03.8003.14.DA	119	03.8032.40ADA	20	03.8044.40ACB	121	03.8054.40ACB	22	03.8074.40.1V	124
03.8004.14	119	03.8032.40ADA	120	03.8044.40ADA	21	03.8054.40ACB	122	03.8074.40.CB	24
03.8004.14.1V	119	03.8033.05A	20	03.8044.40ADA	121	03.8054.40ADA	22	03.8074.40.CB	124
03.8004.14.CB	119	03.8033.05A	120	03.8045.05A	21	03.8054.40ADA	122	03.8074.40.DA	24
03.8004.14.DA	119	03.8033.05A1V	20	03.8045.05A	121	03.8055.05A	22	03.8074.40.DA	124

QUICK SEARCH OF PRODUCT

Ref.	Page	Ref.	Page	Ref.	Page	Ref.	Page	Ref.	Page
03.8075.05	24	03.8100.40.DA	18	03.8130.00	26	03.8138.RC.DA	27	03.8156.14.DA	23
03.8075.05	124	03.8101.14	18	03.8130.00.1V	26	03.8140.14	25	03.8156.14.DA	123
03.8075.05.1V	24	03.8101.14.1V	18	03.8130.00.CB	26	03.8140.14.1V	25	03.8156.40	23
03.8075.05.1V	124	03.8101.14.CB	18	03.8130.00.DA	26	03.8140.14.CB	25	03.8156.40	123
03.8075.05.CB	24	03.8101.14.DA	18	03.8130.FU	26	03.8140.14.DA	25	03.8156.40.1V	23
03.8075.05.CB	124	03.8101.40	18	03.8130.FU.1V	26	03.8140.40	25	03.8156.40.1V	123
03.8075.05.DA	24	03.8101.40.1V	18	03.8130.FU.CB	26	03.8140.40.1V	25	03.8156.40.CB	23
03.8075.05.DA	124	03.8101.40.CB	18	03.8130.FU.DA	26	03.8140.40.CB	25	03.8156.40.CB	123
03.8075.14	24	03.8101.40.DA	18	03.8130.RC	26	03.8140.40.DA	25	03.8156.40.DA	23
03.8075.14	124	03.8102.14	18	03.8130.RC.1V	26	03.8141.14	25	03.8156.40.DA	123
03.8075.14.1V	24	03.8102.14.1V	18	03.8130.RC.CB	26	03.8141.14.1V	25	03.8157.05	23
03.8075.14.1V	124	03.8102.14.CB	18	03.8130.RC.DA	26	03.8141.14.CB	25	03.8157.05	123
03.8075.14.CB	24	03.8102.14.DA	18	03.8131.00	26	03.8141.14.DA	25	03.8157.05.1V	23
03.8075.14.CB	124	03.8102.40	18	03.8131.00.1V	26	03.8141.40	25	03.8157.05.1V	123
03.8075.14.DA	24	03.8102.40.1V	18	03.8131.00.CB	26	03.8141.40.1V	25	03.8157.05.CB	23
03.8075.14.DA	124	03.8102.40.CB	18	03.8131.00.DA	26	03.8141.40.CB	25	03.8157.05.CB	123
03.8075.40	24	03.8102.40.DA	18	03.8131.FU	26	03.8141.40.DA	25	03.8157.05.DA	23
03.8075.40	124	03.8105.14	18	03.8131.FU.1V	26	03.8142.14	25	03.8157.05.DA	123
03.8075.40.1V	24	03.8105.14.1V	18	03.8131.FU.CB	26	03.8142.14.1V	25	03.8157.14	23
03.8075.40.1V	124	03.8105.14.CB	18	03.8131.FU.DA	26	03.8142.14.CB	25	03.8157.14	123
03.8075.40.CB	24	03.8105.14.DA	18	03.8131.RC	26	03.8142.14.DA	25	03.8157.14.1V	23
03.8075.40.CB	124	03.8105.40	18	03.8131.RC.1V	26	03.8142.40	25	03.8157.14.1V	123
03.8075.40.DA	24	03.8105.40.1V	18	03.8131.RC.CB	26	03.8142.40.1V	25	03.8157.14.CB	23
03.8075.40.DA	124	03.8105.40.CB	18	03.8131.RC.DA	26	03.8142.40.CB	25	03.8157.14.CB	123
03.8076.05	24	03.8105.40.DA	18	03.8132.00	26	03.8142.40.DA	25	03.8157.14.DA	23
03.8076.05	124	03.8106.14	18	03.8132.00.1V	26	03.8143.14	25	03.8157.14.DA	123
03.8076.05.1V	24	03.8106.14.1V	18	03.8132.00.CB	26	03.8143.14.1V	25	03.8157.40	23
03.8076.05.1V	124	03.8106.14.CB	18	03.8132.00.DA	26	03.8143.14.CB	25	03.8157.40	123
03.8076.05.CB	24	03.8106.14.DA	18	03.8132.FU	26	03.8143.14.DA	25	03.8157.40.1V	23
03.8076.05.CB	124	03.8106.40	18	03.8132.FU.1V	26	03.8143.40	25	03.8157.40.1V	123
03.8076.05.DA	24	03.8106.40.1V	18	03.8132.FU.CB	26	03.8143.40.1V	25	03.8157.40.CB	23
03.8076.05.DA	124	03.8106.40.CB	18	03.8132.FU.DA	26	03.8143.40.CB	25	03.8157.40.CB	123
03.8076.14	24	03.8106.40.DA	18	03.8132.RC	26	03.8143.40.DA	25	03.8157.40.DA	23
03.8076.14	124	03.8107.14	18	03.8132.RC.1V	26	03.8154.05	23	03.8157.40.DA	123
03.8076.14.1V	24	03.8107.14.1V	18	03.8132.RC.CB	26	03.8154.05	123	03.8300.14A	185
03.8076.14.1V	124	03.8107.14.CB	18	03.8132.RC.DA	26	03.8154.05.1V	23	03.8300.14ADA	185
03.8076.14.CB	24	03.8107.14.DA	18	03.8133.00	26	03.8154.05.1V	123	03.8300.40A	185
03.8076.14.CB	124	03.8107.40	18	03.8133.00.1V	26	03.8154.05.CB	23	03.8300.40ADA	185
03.8076.14.DA	24	03.8107.40.1V	18	03.8133.00.CB	26	03.8154.05.CB	123	03.8301.14A	185
03.8076.14.DA	124	03.8107.40.CB	18	03.8133.00.DA	26	03.8154.05.DA	23	03.8301.14ADA	185
03.8076.14.DA	124	03.8107.40.DA	18	03.8133.FU	26	03.8154.05.DA	123	03.8301.40A	185
03.8076.40	124	03.8110.14	19	03.8133.FU.1V	26	03.8154.14	23	03.8301.40ADA	185
03.8076.40.1V	24	03.8110.14.1V	19	03.8133.FU.CB	26	03.8154.14	123	03.8302.14A	185
03.8076.40.1V	124	03.8110.14.CB	19	03.8133.FU.DA	26	03.8154.14.1V	23	03.8302.14ADA	185
03.8076.40.CB	24	03.8110.14.DA	19	03.8133.RC	26	03.8154.14.1V	123	03.8302.40A	185
03.8076.40.CB	124	03.8110.40	19	03.8133.RC.1V	26	03.8154.14.CB	23	03.8302.40ADA	185
03.8076.40.DA	24	03.8110.40.1V	19	03.8133.RC.CB	26	03.8154.14.CB	123	03.8303.14A	185
03.8076.40.DA	124	03.8110.40.CB	19	03.8133.RC.DA	26	03.8154.14.DA	23	03.8303.14ADA	185
03.8077.05	24	03.8110.40.DA	19	03.8135.00	26	03.8154.14.DA	123	03.8303.40A	185
03.8077.05	124	03.8111.14	19	03.8135.00.1V	26	03.8154.40	23	03.8303.40ADA	185
03.8077.05.1V	24	03.8111.14.1V	19	03.8135.00.CB	26	03.8154.40	123	03.8304.14A	185
03.8077.05.1V	124	03.8111.14.CB	19	03.8135.00.DA	26	03.8154.40.1V	23	03.8304.14ADA	185
03.8077.05.CB	24	03.8111.14.DA	19	03.8135.FU	26	03.8154.40.1V	123	03.8304.40A	185
03.8077.05.CB	124	03.8111.40	19	03.8135.FU.1V	26	03.8154.40.CB	23	03.8304.40ADA	185
03.8077.05.DA	24	03.8111.40.1V	19	03.8135.FU.CB	26	03.8154.40.CB	123	03.8305.14A	185
03.8077.05.DA	124	03.8111.40.CB	19	03.8135.FU.DA	26	03.8154.40.DA	23	03.8305.14ADA	185
03.8077.14	24	03.8111.40.DA	19	03.8135.RC	26	03.8154.40.DA	123	03.8305.40A	185
03.8077.14	124	03.8112.14	19	03.8135.RC.1V	26	03.8155.05	23	03.8305.40ADA	185
03.8077.14.1V	24	03.8112.14.1V	19	03.8135.RC.CB	26	03.8155.05	123	03.8306.14A	185
03.8077.14.1V	124	03.8112.14.CB	19	03.8135.RC.DA	26	03.8155.05.1V	23	03.8306.14ADA	185
03.8077.14.CB	24	03.8112.14.DA	19	03.8136.00	27	03.8155.05.1V	123	03.8306.40A	185
03.8077.14.CB	124	03.8112.40	19	03.8136.00.1V	27	03.8155.05.CB	23	03.8306.40ADA	185
03.8077.14.DA	24	03.8112.40.1V	19	03.8136.00.CB	27	03.8155.05.CB	123	03.8307.14A	185
03.8077.14.DA	124	03.8112.40.CB	19	03.8136.00.DA	27	03.8155.05.DA	23	03.8307.14ADA	185
03.8077.40	24	03.8112.40.DA	19	03.8136.FU	27	03.8155.05.DA	123	03.8307.40A	185
03.8077.40	124	03.8115.14	19	03.8136.FU.1V	27	03.8155.14	23	03.8307.40ADA	185
03.8077.40.1V	24	03.8115.14.1V	19	03.8136.FU.CB	27	03.8155.14	123	03.8308.14A	187
03.8077.40.1V	124	03.8115.14.CB	19	03.8136.FU.DA	27	03.8155.14.1V	23	03.8308.14ADA	187
03.8077.40.CB	24	03.8115.14.DA	19	03.8136.RC	27	03.8155.14.1V	123	03.8308.40A	187
03.8077.40.CB	124	03.8115.40	19	03.8136.RC.1V	27	03.8155.14.CB	23	03.8308.40ADA	187
03.8077.40.DA	24	03.8115.40.1V	19	03.8136.RC.CB	27	03.8155.14.CB	123	03.8309.14A	187
03.8077.40.DA	124	03.8115.40.CB	19	03.8136.RC.DA	27	03.8155.14.DA	23	03.8309.14ADA	187
03.8090.14	126	03.8115.40.DA	19	03.8137.00	26	03.8155.14.DA	123	03.8309.40A	187
03.8090.14.1V	126	03.8116.14	19	03.8137.00.1V	26	03.8155.40	23	03.8309.40ADA	187
03.8090.14.CB	126	03.8116.14.1V	19	03.8137.00.CB	26	03.8155.40.1V	123	03.8310.14A	187
03.8090.14.DA	126	03.8116.14.CB	19	03.8137.00.DA	26	03.8155.40.1V	23	03.8310.14ADA	187
03.8090.40	126	03.8116.14.DA	19	03.8137.FU	26	03.8155.40.1V	123	03.8310.40A	187
03.8090.40.1V	126	03.8116.40	19	03.8137.FU.1V	26	03.8155.40.CB	23	03.8310.40ADA	187
03.8090.40.CB	126	03.8116.40.1V	19	03.8137.FU.CB	26	03.8155.40.CB	123	03.8311.14A	187
03.8090.40.DA	126	03.8116.40.CB	19	03.8137.FU.DA	26	03.8155.40.DA	23	03.8311.14ADA	187
03.8091.14	126	03.8116.40.DA	19	03.8137.RC	26	03.8155.40.DA	123	03.8311.40A	187
03.8091.14.1V	126	03.8117.14	19	03.8137.RC.1V	26	03.8156.05	23	03.8311.40ADA	187
03.8091.14.CB	126	03.8117.14.1V	19	03.8137.RC.CB	26	03.8156.05	123	03.8312.14A	187
03.8091.14.DA	126	03.8117.14.CB	19	03.8137.RC.DA	26	03.8156.05.1V	23	03.8312.14ADA	187
03.8091.40	126	03.8117.14.DA	19	03.8138.00	27	03.8156.05.1V	123	03.8312.40A	187
03.8091.40.1V	126	03.8117.40	19	03.8138.00.1V	27	03.8156.05.CB	23	03.8312.40ADA	187
03.8091.40.CB	126	03.8117.40.1V	19	03.8138.00.CB	27	03.8156.05.CB	123	03.8313.14A	187
03.8091.40.DA	126	03.8117.40.CB	19	03.8138.00.DA	27	03.8156.05.DA	23	03.8313.14ADA	187
03.8100.14	18	03.8117.40.DA	19	03.8138.FU	27	03.8156.05.DA	123	03.8313.40A	187
03.8100.14.1V	18	03.8120.14	17	03.8138.FU.1V	27	03.8156.14	23	03.8313.40ADA	187
03.8100.14.CB	18	03.8120.40	17	03.8138.FU.CB	27	03.8156.14	123	03.8314.14A	187
03.8100.14.DA	18	03.8121.14	17	03.8138.FU.DA	27	03.8156.14.1V	23	03.8314.14ADA	187
03.8100.40	18	03.8121.40	17	03.8138.RC	27	03.8156.14.1V	123	03.8314.40A	187
03.8100.40.1V	18	03.8122.14	17	03.8138.RC.1V	27	03.8156.14.CB	23	03.8314.40ADA	187
03.8100.40.CB	18	03.8122.40	17	03.8138.RC.CB	27	03.8156.14.CB	123	03.8315.14A	187

QUICK SEARCH OF PRODUCT

Ref.	Page	Ref.	Page	Ref.	Page	Ref.	Page	Ref.	Page
03.8315.14ADA	187	03.8357.14A	193	03.8380.40ADA	199	03.8510.14	12	03.8641.GLA	224
03.8315.40A	187	03.8357.14ADA	193	03.8381.14A	199	03.8510.18	12	03.8642.06A	225
03.8315.40ADA	187	03.8357.40A	193	03.8381.14ADA	199	03.8510.GN	12	03.8642.14A	225
03.8316.14A	189	03.8357.40ADA	193	03.8381.40A	199	03.8511.14	12	03.8642.40A	225
03.8316.14ADA	189	03.8358.14A	195	03.8381.40ADA	199	03.8511.18	12	03.8642.GLA	225
03.8316.40A	189	03.8358.14ADA	195	03.8400.14	33	03.8511.GN	12	03.8643.06A	224
03.8316.40ADA	189	03.8358.40A	195	03.8400.40	33	03.8512.14	12	03.8643.14A	224
03.8317.14A	189	03.8358.40ADA	195	03.8401.14	33	03.8512.18	12	03.8643.40A	224
03.8317.14ADA	189	03.8359.14A	195	03.8401.40	33	03.8512.GN	12	03.8643.GLA	224
03.8317.40A	189	03.8359.14ADA	195	03.8402.14	33	03.8513.14	12	03.8644.06A	224
03.8317.40ADA	189	03.8359.40A	195	03.8402.40	33	03.8513.18	12	03.8644.14A	224
03.8318.14A	189	03.8359.40ADA	195	03.8403.14	33	03.8513.GN	12	03.8644.40A	224
03.8318.14ADA	189	03.8360.14A	195	03.8403.40	33	03.8514.14	12	03.8644.GLA	224
03.8318.40A	189	03.8360.14ADA	195	03.8404.14	33	03.8514.18	12	03.8645.06A	225
03.8318.40ADA	189	03.8360.40A	195	03.8404.40	33	03.8514.GN	12	03.8645.14A	225
03.8319.14A	189	03.8360.40ADA	195	03.8405.14	33	03.8520.14	12	03.8645.40A	225
03.8319.14ADA	189	03.8361.14A	195	03.8405.40	33	03.8520.18	12	03.8645.GLA	225
03.8319.40A	189	03.8361.14ADA	195	03.8410.14	34	03.8520.GN	12	03.8646.06A	225
03.8319.40ADA	189	03.8361.40A	195	03.8410.40	34	03.8521.14	12	03.8646.14A	225
03.8320.14A	189	03.8361.40ADA	195	03.8411.14	34	03.8521.18	12	03.8646.40A	225
03.8320.14ADA	189	03.8362.14A	195	03.8411.40	34	03.8521.GN	12	03.8646.GLA	225
03.8320.40A	189	03.8362.14ADA	195	03.8412.14	34	03.8522.14	12	03.8647.06A	225
03.8320.40ADA	189	03.8362.40A	195	03.8412.40	34	03.8522.18	12	03.8647.14A	225
03.8321.14A	189	03.8362.40ADA	195	03.8413.14	34	03.8522.GN	12	03.8647.40A	225
03.8321.14ADA	189	03.8363.14A	195	03.8413.40	34	03.8600.06A	224	03.8647.GLA	225
03.8321.40A	189	03.8363.14ADA	195	03.8414.14	34	03.8600.14A	224	03.8820.14A	184
03.8321.40ADA	189	03.8363.40A	195	03.8414.40	34	03.8600.40A	224	03.8820.14ADA	184
03.8322.14A	189	03.8363.40ADA	195	03.8415.14	34	03.8600.GLA	224	03.8820.40A	184
03.8322.14ADA	189	03.8364.14A	195	03.8415.40	34	03.8601.06A	224	03.8820.40ADA	184
03.8322.40A	189	03.8364.14ADA	195	03.8420.14	36	03.8601.14A	224	03.8821.14A	184
03.8322.40ADA	189	03.8364.40A	195	03.8420.40	36	03.8601.40A	224	03.8821.14ADA	184
03.8323.14A	189	03.8364.40ADA	195	03.8421.14	36	03.8601.GLA	224	03.8821.40A	184
03.8323.14ADA	189	03.8365.14A	195	03.8421.40	36	03.8602.06A	225	03.8821.40ADA	184
03.8323.40A	189	03.8365.14ADA	195	03.8422.14	36	03.8602.14A	225	03.8822.14A	184
03.8323.40ADA	189	03.8365.40A	195	03.8422.40	36	03.8602.40A	225	03.8822.14ADA	184
03.8324.14A	191	03.8365.40ADA	195	03.8423.14	36	03.8602.GLA	225	03.8822.40A	184
03.8324.14ADA	191	03.8366.14A	197	03.8423.40	36	03.8603.06A	224	03.8822.40ADA	184
03.8324.40A	191	03.8366.14ADA	197	03.8424.14	36	03.8603.14A	224	03.8823.14A	184
03.8324.40ADA	191	03.8366.40A	197	03.8424.40	36	03.8603.40A	224	03.8823.14ADA	184
03.8325.14A	191	03.8366.40ADA	197	03.8425.14	36	03.8603.GLA	224	03.8823.40A	184
03.8325.14ADA	191	03.8367.14A	197	03.8425.40	36	03.8604.06A	224	03.8823.40ADA	184
03.8325.40A	191	03.8367.14ADA	197	03.8430.14	31	03.8604.14A	224	03.8824.14A	184
03.8325.40ADA	191	03.8367.40A	197	03.8430.40	31	03.8604.40A	224	03.8824.14ADA	184
03.8326.14A	191	03.8367.40ADA	197	03.8431.14	31	03.8604.GLA	224	03.8824.40A	184
03.8326.14ADA	191	03.8368.14A	197	03.8431.40	31	03.8605.06A	225	03.8824.40ADA	184
03.8326.40A	191	03.8368.14ADA	197	03.8432.14	31	03.8605.14A	225	03.8825.14A	184
03.8326.40ADA	191	03.8368.40A	197	03.8432.40	31	03.8605.40A	225	03.8825.14ADA	184
03.8327.14A	191	03.8368.40ADA	197	03.8440.14	34	03.8605.GLA	225	03.8825.40A	184
03.8327.14ADA	191	03.8369.14A	197	03.8440.40	34	03.8610.06A	224	03.8825.40ADA	184
03.8327.40A	191	03.8369.14ADA	197	03.8441.14	35	03.8610.14A	224	03.8826.14A	184
03.8327.40ADA	191	03.8369.40A	197	03.8441.40	35	03.8610.40A	224	03.8826.14ADA	184
03.8328.14A	191	03.8369.40ADA	197	03.8442.14	34	03.8610.GLA	224	03.8826.40A	184
03.8328.14ADA	191	03.8370.14A	197	03.8442.40	34	03.8611.06A	224	03.8826.40ADA	184
03.8328.40A	191	03.8370.14ADA	197	03.8443.14	35	03.8611.14A	224	03.8827.14A	184
03.8328.40ADA	191	03.8370.40A	197	03.8443.40	35	03.8611.40A	224	03.8827.14ADA	184
03.8329.14A	191	03.8370.40ADA	197	03.8450.14	35	03.8611.GLA	224	03.8827.40A	184
03.8329.14ADA	191	03.8371.14A	197	03.8450.40	35	03.8612.06A	225	03.8827.40ADA	184
03.8329.40A	191	03.8371.14ADA	197	03.8451.14	35	03.8612.14A	225	03.8828.14A	186
03.8329.40ADA	191	03.8371.40A	197	03.8451.40	35	03.8612.40A	225	03.8828.14ADA	186
03.8330.14A	191	03.8371.40ADA	197	03.8500.14.1V	11	03.8612.GLA	225	03.8828.40A	186
03.8330.14ADA	191	03.8372.14A	197	03.8500.14.CB	11	03.8613.06A	224	03.8828.40ADA	186
03.8330.40A	191	03.8372.14ADA	197	03.8500.14.DA	11	03.8613.14A	224	03.8829.14A	186
03.8330.40ADA	191	03.8372.40A	197	03.8500.18.1V	11	03.8613.40A	224	03.8829.14ADA	186
03.8331.14A	191	03.8372.40ADA	197	03.8500.18.CB	11	03.8613.GLA	224	03.8829.40A	186
03.8331.14ADA	191	03.8373.14A	197	03.8500.18.DA	11	03.8614.06A	224	03.8829.40ADA	186
03.8331.40A	191	03.8373.14ADA	197	03.8500.GN.1V	11	03.8614.14A	224	03.8830.14A	186
03.8331.40ADA	191	03.8373.40A	197	03.8500.GN.CB	11	03.8614.40A	224	03.8830.14ADA	186
03.8350.14A	193	03.8373.40ADA	197	03.8500.GN.DA	11	03.8614.GLA	224	03.8830.40A	186
03.8350.14ADA	193	03.8374.14A	199	03.8501.14.1V	11	03.8615.06A	225	03.8830.40ADA	186
03.8350.40A	193	03.8374.14ADA	199	03.8501.14.CB	11	03.8615.14A	225	03.8831.14A	186
03.8350.40ADA	193	03.8374.40A	199	03.8501.14.DA	11	03.8615.40A	225	03.8831.14ADA	186
03.8351.14A	193	03.8374.40ADA	199	03.8501.18.1V	11	03.8615.GLA	225	03.8831.40A	186
03.8351.14ADA	193	03.8375.14A	199	03.8501.18.CB	11	03.8630.06A	225	03.8831.40ADA	186
03.8351.40A	193	03.8375.14ADA	199	03.8501.18.DA	11	03.8630.14A	225	03.8832.14A	186
03.8351.40ADA	193	03.8375.40A	199	03.8501.GN.1V	11	03.8630.40A	225	03.8832.14ADA	186
03.8352.14A	193	03.8375.40ADA	199	03.8501.GN.CB	11	03.8630.GLA	225	03.8832.40A	186
03.8352.14ADA	193	03.8376.14A	199	03.8501.GN.DA	11	03.8631.06A	225	03.8832.40ADA	186
03.8352.40A	193	03.8376.14ADA	199	03.8505.14.1V	11	03.8631.14A	225	03.8833.14A	186
03.8352.40ADA	193	03.8376.40A	199	03.8505.14.CB	11	03.8631.40A	225	03.8833.14ADA	186
03.8353.14A	193	03.8376.40ADA	199	03.8505.14.DA	11	03.8631.GLA	225	03.8833.40A	186
03.8353.14ADA	193	03.8377.14A	199	03.8505.18.1V	11	03.8635.06A	225	03.8833.40ADA	186
03.8353.40A	193	03.8377.14ADA	199	03.8505.18.CB	11	03.8635.14A	225	03.8834.14A	186
03.8353.40ADA	193	03.8377.40A	199	03.8505.18.DA	11	03.8635.40A	225	03.8834.14ADA	186
03.8354.14A	193	03.8377.40ADA	199	03.8505.GN.1V	11	03.8635.GLA	225	03.8834.40A	186
03.8354.14ADA	193	03.8378.14A	199	03.8505.GN.CB	11	03.8636.06A	225	03.8834.40ADA	186
03.8354.40A	193	03.8378.14ADA	199	03.8505.GN.DA	11	03.8636.14A	225	03.8835.14A	186
03.8354.40ADA	193	03.8378.40A	199	03.8506.14.1V	11	03.8636.40A	225	03.8835.14ADA	186
03.8355.14A	193	03.8378.40ADA	199	03.8506.14.CB	11	03.8636.GLA	225	03.8835.40A	186
03.8355.14ADA	193	03.8379.14A	199	03.8506.14.DA	11	03.8640.06A	224	03.8835.40ADA	186
03.8355.40A	193	03.8379.14ADA	199	03.8506.18.1V	11	03.8640.14A	224	03.8836.14A	188
03.8355.40ADA	193	03.8379.40A	199	03.8506.18.CB	11	03.8640.40A	224	03.8836.14ADA	188
03.8356.14A	193	03.8379.40ADA	199	03.8506.18.DA	11	03.8640.GLA	224	03.8836.40A	188
03.8356.14ADA	193	03.8380.14A	199	03.8506.GN.1V	11	03.8641.06A	224	03.8836.40ADA	188
03.8356.40A	193	03.8380.14ADA	199	03.8506.GN.CB	11	03.8641.14A	224	03.8837.14A	188
03.8356.40ADA	193	03.8380.40A	199	03.8506.GN.DA	11	03.8641.40A	224	03.8837.14ADA	188

QUICK SEARCH OF PRODUCT

Ref.	Page	Ref.	Page	Ref.	Page	Ref.	Page	Ref.	Page
03.8953.40A	98	03.9105.14A	185	03.9133.40ADA	186	03.9163.40A	190	03.9213.14ADA	192
03.8953.40ACB	98	03.9105.14ADA	185	03.9135.14A	187	03.9163.40ADA	190	03.9213.40A	192
03.8953.40BDA	98	03.9105.40A	185	03.9135.14ADA	187	03.9165.14A	191	03.9213.40ADA	192
03.8954.14A	98	03.9105.40ADA	185	03.9135.40A	187	03.9165.14ADA	191	03.9215.14A	193
03.8954.14ACB	98	03.9106.14A	185	03.9135.40ADA	187	03.9165.40A	191	03.9215.14ADA	193
03.8954.14BDA	98	03.9106.14ADA	185	03.9136.14A	187	03.9165.40ADA	191	03.9215.40A	193
03.8954.40A	98	03.9106.40A	185	03.9136.14ADA	187	03.9166.14A	191	03.9215.40ADA	193
03.8954.40ACB	98	03.9106.40ADA	185	03.9136.40A	187	03.9166.14ADA	191	03.9216.14A	193
03.8954.40BDA	98	03.9107.14A	185	03.9136.40ADA	187	03.9166.40A	191	03.9216.14ADA	193
03.8955.14A	98	03.9107.14ADA	185	03.9137.14A	187	03.9166.40ADA	191	03.9216.40A	193
03.8955.14ACB	98	03.9107.40A	185	03.9137.14ADA	187	03.9167.14A	191	03.9216.40ADA	193
03.8955.14BDA	98	03.9107.40ADA	185	03.9137.40A	187	03.9167.14ADA	191	03.9217.14A	193
03.8955.40A	98	03.9108.14A	185	03.9137.40ADA	187	03.9167.40A	191	03.9217.14ADA	193
03.8955.40ACB	98	03.9108.14ADA	185	03.9138.14A	187	03.9167.40ADA	191	03.9217.40A	193
03.8955.40BDA	98	03.9108.40A	185	03.9138.14ADA	187	03.9168.14A	191	03.9217.40ADA	193
03.8956.14A	218	03.9108.40ADA	185	03.9138.40A	187	03.9168.14ADA	191	03.9218.14A	193
03.8956.14ADA	218	03.9110.14A	184	03.9138.40ADA	187	03.9168.40A	191	03.9218.14ADA	193
03.8956.40A	218	03.9110.14ADA	184	03.9140.14A	188	03.9168.40ADA	191	03.9218.40A	193
03.8956.40ADA	218	03.9110.40A	184	03.9140.14ADA	188	03.9170.14A	190	03.9218.40ADA	193
03.8957.14A	218	03.9110.40ADA	184	03.9140.40A	188	03.9170.14ADA	190	03.9220.14A	194
03.8957.14ADA	218	03.9111.14A	184	03.9140.40ADA	188	03.9170.40A	190	03.9220.14ADA	194
03.8957.40A	218	03.9111.14ADA	184	03.9141.14A	188	03.9170.40ADA	190	03.9220.40A	194
03.8957.40ADA	218	03.9111.40A	184	03.9141.14ADA	188	03.9171.14A	190	03.9220.40ADA	194
03.8958.14A	218	03.9111.40ADA	184	03.9141.40A	188	03.9171.14ADA	190	03.9221.14A	194
03.8958.14ADA	218	03.9112.14A	184	03.9141.40ADA	188	03.9171.40A	190	03.9221.14ADA	194
03.8958.40A	218	03.9112.14ADA	184	03.9142.14A	188	03.9171.40ADA	190	03.9221.40A	194
03.8958.40ADA	218	03.9112.40A	184	03.9142.14ADA	188	03.9172.14A	190	03.9221.40ADA	194
03.8959.14A	218	03.9112.40ADA	184	03.9142.40A	188	03.9172.14ADA	190	03.9222.14A	194
03.8959.14ADA	218	03.9113.14A	184	03.9142.40ADA	188	03.9172.40A	190	03.9222.14ADA	194
03.8959.40A	218	03.9113.14ADA	184	03.9143.14A	188	03.9172.40ADA	190	03.9222.40A	194
03.8959.40ADA	218	03.9113.40A	184	03.9143.14ADA	188	03.9173.14A	190	03.9222.40ADA	194
03.8960.14A	218	03.9113.40ADA	184	03.9143.40A	188	03.9173.14ADA	190	03.9223.14A	194
03.8960.14ADA	218	03.9115.14A	185	03.9143.40ADA	188	03.9173.40A	190	03.9223.14ADA	194
03.8960.40A	218	03.9115.14ADA	185	03.9145.14A	189	03.9173.40ADA	190	03.9223.40A	194
03.8960.40ADA	218	03.9115.40A	185	03.9145.14ADA	189	03.9175.14A	191	03.9223.40ADA	194
03.8961.14A	218	03.9115.40ADA	185	03.9145.40A	189	03.9175.14ADA	191	03.9225.14A	195
03.8961.14ADA	218	03.9116.14A	185	03.9145.40ADA	189	03.9175.40A	191	03.9225.14ADA	195
03.8961.40A	218	03.9116.14ADA	185	03.9146.14A	189	03.9175.40ADA	191	03.9225.40A	195
03.8961.40ADA	218	03.9116.40A	185	03.9146.14ADA	189	03.9176.14A	191	03.9225.40ADA	195
03.8962.14A	218	03.9116.40ADA	185	03.9146.40A	189	03.9176.14ADA	191	03.9226.14A	195
03.8962.14ADA	218	03.9117.14A	185	03.9146.40ADA	189	03.9176.40A	191	03.9226.14ADA	195
03.8962.40A	218	03.9117.14ADA	185	03.9147.14A	189	03.9176.40ADA	191	03.9226.40A	195
03.8962.40ADA	218	03.9117.40A	185	03.9147.14ADA	189	03.9177.14A	191	03.9226.40ADA	195
03.8963.14A	218	03.9117.40ADA	185	03.9147.40A	189	03.9177.14ADA	191	03.9227.14A	195
03.8963.14ADA	218	03.9118.14A	185	03.9147.40A	189	03.9177.40A	191	03.9227.14ADA	195
03.8963.40A	218	03.9118.14ADA	185	03.9148.14A	189	03.9177.40ADA	191	03.9227.40A	195
03.8963.40ADA	218	03.9118.40A	185	03.9148.14ADA	189	03.9178.14A	191	03.9227.40ADA	195
03.8964.14A	218	03.9118.40ADA	185	03.9148.40A	189	03.9178.14ADA	191	03.9228.14A	195
03.8964.14ADA	218	03.9120.14A	186	03.9148.40ADA	189	03.9178.40A	191	03.9228.14ADA	195
03.8964.40A	218	03.9120.14ADA	186	03.9150.14A	188	03.9178.40ADA	191	03.9228.40A	195
03.8964.40ADA	218	03.9120.40A	186	03.9150.14ADA	188	03.9200.14A	192	03.9228.40ADA	195
03.8965.14A	218	03.9120.40ADA	186	03.9150.40A	188	03.9200.14ADA	192	03.9230.14A	194
03.8965.14ADA	218	03.9121.14A	186	03.9150.40ADA	188	03.9200.40A	192	03.9230.14ADA	194
03.8965.40A	218	03.9121.14ADA	186	03.9151.14A	188	03.9200.40ADA	192	03.9230.40A	194
03.8965.40ADA	218	03.9121.40A	186	03.9151.14ADA	188	03.9201.14A	192	03.9230.40ADA	194
03.8966.14A	218	03.9121.40ADA	186	03.9151.40A	188	03.9201.14ADA	192	03.9231.14A	194
03.8966.14ADA	218	03.9122.14A	186	03.9151.40ADA	188	03.9201.40A	192	03.9231.14ADA	194
03.8966.40A	218	03.9122.14ADA	186	03.9152.14A	188	03.9201.40ADA	192	03.9231.40A	194
03.8966.40ADA	218	03.9122.40A	186	03.9152.14ADA	188	03.9202.14A	192	03.9231.40ADA	194
03.8967.14A	218	03.9122.40ADA	186	03.9152.40A	188	03.9202.14ADA	192	03.9232.14A	194
03.8967.14ADA	218	03.9123.14A	186	03.9152.40ADA	188	03.9202.40A	192	03.9232.14ADA	194
03.8967.40A	218	03.9123.14ADA	186	03.9153.14A	188	03.9202.40ADA	192	03.9232.40A	194
03.8967.40ADA	218	03.9123.40A	186	03.9153.14ADA	188	03.9203.14A	192	03.9232.40ADA	194
03.8968.14A	218	03.9123.40ADA	186	03.9153.40A	188	03.9203.14ADA	192	03.9233.14A	194
03.8968.14ADA	218	03.9125.14A	187	03.9153.40ADA	188	03.9203.40A	192	03.9233.14ADA	194
03.8968.40A	218	03.9125.14ADA	187	03.9155.14A	189	03.9203.40ADA	192	03.9233.40A	194
03.8968.40ADA	218	03.9125.40A	187	03.9155.14ADA	189	03.9205.14A	193	03.9233.40ADA	194
03.8969.14A	218	03.9125.40ADA	187	03.9155.40A	189	03.9205.14ADA	193	03.9235.14A	195
03.8969.14ADA	218	03.9126.14A	187	03.9155.40ADA	189	03.9205.40A	193	03.9235.14ADA	195
03.8969.40A	218	03.9126.14ADA	187	03.9156.14A	189	03.9205.40ADA	193	03.9235.40A	195
03.8969.40ADA	218	03.9126.40A	187	03.9156.14ADA	189	03.9206.14A	193	03.9235.40ADA	195
03.8970.14A	218	03.9126.40ADA	187	03.9156.40A	189	03.9206.14ADA	193	03.9236.14A	195
03.8970.14ADA	218	03.9127.14A	187	03.9156.40ADA	189	03.9206.40A	193	03.9236.14ADA	195
03.8970.40A	218	03.9127.14ADA	187	03.9157.14A	189	03.9206.40ADA	193	03.9236.40A	195
03.8971.14A	218	03.9127.40A	187	03.9157.14ADA	189	03.9207.14A	193	03.9236.40ADA	195
03.8971.14ADA	218	03.9127.40ADA	187	03.9157.40A	189	03.9207.14ADA	193	03.9237.14A	195
03.8971.40A	218	03.9128.14A	187	03.9157.40ADA	189	03.9207.40A	193	03.9237.14ADA	195
03.8971.40ADA	218	03.9128.14ADA	187	03.9158.14A	189	03.9207.40ADA	193	03.9237.40A	195
03.9100.14A	184	03.9128.40A	187	03.9158.14ADA	189	03.9208.14A	193	03.9237.40ADA	195
03.9100.14ADA	184	03.9128.40ADA	187	03.9158.40A	189	03.9208.14ADA	193	03.9238.14A	195
03.9100.40A	184	03.9130.14A	186	03.9158.40ADA	189	03.9208.40A	193	03.9238.14ADA	195
03.9100.40ADA	184	03.9130.14ADA	186	03.9160.14A	190	03.9208.40ADA	193	03.9238.40A	195
03.9101.14A	184	03.9130.40A	186	03.9160.40A	190	03.9210.14A	192	03.9238.40ADA	195
03.9101.14ADA	184	03.9130.40ADA	186	03.9160.40ADA	190	03.9210.14ADA	192	03.9240.14A	196
03.9101.40A	184	03.9131.14A	186	03.9160.40ADA	190	03.9210.40A	192	03.9240.14ADA	196
03.9101.40ADA	184	03.9131.14ADA	186	03.9161.14A	190	03.9210.40ADA	192	03.9240.40A	196
03.9102.14A	184	03.9131.40A	186	03.9161.14ADA	190	03.9211.14A	192	03.9240.40ADA	196
03.9102.14ADA	184	03.9131.40ADA	186	03.9161.40A	190	03.9211.14ADA	192	03.9241.14A	196
03.9102.40A	184	03.9132.14A	186	03.9161.40ADA	190	03.9211.40A	192	03.9241.14ADA	196
03.9102.40ADA	184	03.9132.14ADA	186	03.9162.14A	190	03.9211.40ADA	192	03.9241.40A	196
03.9103.14A	184	03.9132.40A	186	03.9162.14ADA	190	03.9212.14A	192	03.9241.40ADA	196
03.9103.14ADA	184	03.9132.40ADA	186	03.9162.40A	190	03.9212.14ADA	192	03.9242.14A	196
03.9103.40A	184	03.9133.14A	186	03.9162.40ADA	190	03.9212.40A	192	03.9242.14ADA	196
03.9103.40ADA	184	03.9133.14ADA	186	03.9163.14A	190	03.9212.40ADA	192	03.9242.40A	196
		03.9133.40A	186	03.9163.14ADA	190	03.9213.14A	192	03.9242.40ADA	196

QUICK SEARCH OF PRODUCT

Ref.	Page	Ref.	Page	Ref.	Page	Ref.	Page	Ref.	Page
03.9431.40ADA	210	03.9461.40A	214	03.9621.14ACB	99	03.9661.14A	101	03.9736.14ADA	219
03.9432.14A	210	03.9461.40ADA	214	03.9621.14BDA	99	03.9661.14ACB	101	03.9736.40A	219
03.9432.14ADA	210	03.9462.14A	214	03.9621.40A	99	03.9661.14BDA	101	03.9736.40ADA	219
03.9432.40A	210	03.9462.14ADA	214	03.9621.40ACB	99	03.9661.40A	101	03.9737.14A	219
03.9432.40ADA	210	03.9462.40A	214	03.9621.40BDA	99	03.9661.40ACB	101	03.9737.14ADA	219
03.9433.14A	210	03.9462.40ADA	214	03.9622.14A	99	03.9661.40BDA	101	03.9737.40A	219
03.9433.14ADA	210	03.9463.14A	214	03.9622.14ACB	99	03.9662.14A	101	03.9737.40ADA	219
03.9433.40A	210	03.9463.14ADA	214	03.9622.14BDA	99	03.9662.14ACB	101	03.9738.14A	219
03.9433.40ADA	210	03.9463.40A	214	03.9622.40A	99	03.9662.14BDA	101	03.9738.14ADA	219
03.9435.14A	211	03.9463.40ADA	214	03.9622.40ACB	99	03.9662.40A	101	03.9738.40A	219
03.9435.14ADA	211	03.9465.14A	215	03.9622.40BDA	99	03.9662.40ACB	101	03.9738.40ADA	219
03.9435.40A	211	03.9465.14ADA	215	03.9623.14A	99	03.9662.40BDA	101	03.9760.14A	220
03.9435.40ADA	211	03.9465.40A	215	03.9623.14ACB	99	03.9663.14A	101	03.9760.14ADA	220
03.9436.14A	211	03.9465.40ADA	215	03.9623.14BDA	99	03.9663.14ACB	101	03.9760.40A	220
03.9436.14ADA	211	03.9466.14A	215	03.9623.40A	99	03.9663.14BDA	101	03.9760.40ADA	220
03.9436.40A	211	03.9466.14ADA	215	03.9623.40ACB	99	03.9663.40A	101	03.9761.14A	220
03.9436.40ADA	211	03.9466.40A	215	03.9623.40BDA	99	03.9663.40ACB	101	03.9761.14ADA	220
03.9437.14A	211	03.9466.40ADA	215	03.9625.14A	100	03.9663.40BDA	101	03.9761.40A	220
03.9437.14ADA	211	03.9467.14A	215	03.9625.14ACB	100	03.9664.14A	101	03.9761.40ADA	220
03.9437.40A	211	03.9467.14ADA	215	03.9625.14BDA	100	03.9664.14ACB	101	03.9762.14A	220
03.9437.40ADA	211	03.9467.40A	215	03.9625.40A	100	03.9664.14BDA	101	03.9762.14ADA	220
03.9438.14A	211	03.9467.40ADA	215	03.9625.40ACB	100	03.9664.40A	101	03.9762.40A	220
03.9438.14ADA	211	03.9468.14A	215	03.9625.40BDA	100	03.9664.40ACB	101	03.9762.40ADA	220
03.9438.40A	211	03.9468.14ADA	215	03.9626.14A	100	03.9664.40BDA	101	03.9763.14A	220
03.9438.40ADA	211	03.9468.40A	215	03.9626.14ACB	100	03.9665.14A	101	03.9763.14ADA	220
03.9440.14A	212	03.9468.40ADA	215	03.9626.14BDA	100	03.9665.14ACB	101	03.9763.40A	220
03.9440.14ADA	212	03.9470.14A	214	03.9626.40A	100	03.9665.14BDA	101	03.9763.40ADA	220
03.9440.40A	212	03.9470.14ADA	214	03.9626.40ACB	100	03.9665.40A	101	03.9764.14A	220
03.9440.40ADA	212	03.9470.40A	214	03.9626.40BDA	100	03.9665.40ACB	101	03.9764.14ADA	220
03.9441.14A	212	03.9470.40ADA	214	03.9627.14A	100	03.9665.40BDA	101	03.9764.40A	220
03.9441.14ADA	212	03.9471.14A	214	03.9627.14ACB	100	03.9666.14A	101	03.9764.40ADA	220
03.9441.40A	212	03.9471.14ADA	214	03.9627.14BDA	100	03.9666.14ACB	101	03.9765.14A	220
03.9441.40ADA	212	03.9471.40A	214	03.9627.40A	100	03.9666.14BDA	101	03.9765.14ADA	220
03.9442.14A	212	03.9471.40ADA	214	03.9627.40ACB	100	03.9666.40A	101	03.9765.40A	220
03.9442.14ADA	212	03.9472.14A	214	03.9627.40BDA	100	03.9666.40ACB	101	03.9765.40ADA	220
03.9442.40A	212	03.9472.14ADA	214	03.9628.14A	100	03.9666.40BDA	101	03.9766.14A	220
03.9442.40ADA	212	03.9472.40A	214	03.9628.14ACB	100	03.9667.14A	101	03.9766.14ADA	220
03.9443.14A	212	03.9472.40ADA	214	03.9628.14BDA	100	03.9667.14ACB	101	03.9766.40A	220
03.9443.14ADA	212	03.9473.14A	214	03.9628.40A	100	03.9667.14BDA	101	03.9766.40ADA	220
03.9443.40A	212	03.9473.14ADA	214	03.9628.40ACB	100	03.9667.40A	101	03.9767.14A	220
03.9443.40ADA	212	03.9473.40A	214	03.9628.40BDA	100	03.9667.40ACB	101	03.9767.14ADA	220
03.9445.14A	213	03.9473.40ADA	214	03.9630.14A	99	03.9667.40BDA	101	03.9767.40A	220
03.9445.14ADA	213	03.9475.14A	215	03.9630.14ACB	99	03.9720.14A	218	03.9767.40ADA	220
03.9445.40A	213	03.9475.14ADA	215	03.9630.14BDA	99	03.9720.14ADA	218	03.9820.14A	218
03.9445.40ADA	213	03.9475.40A	215	03.9630.40A	99	03.9720.40A	218	03.9820.14ADA	218
03.9446.14A	213	03.9475.40ADA	215	03.9630.40ACB	99	03.9720.40ADA	218	03.9820.40A	218
03.9446.14ADA	213	03.9476.14A	215	03.9630.40BDA	99	03.9721.14A	218	03.9820.40ADA	218
03.9446.40A	213	03.9476.14ADA	215	03.9631.14A	99	03.9721.14ADA	218	03.9821.14A	218
03.9446.40ADA	213	03.9476.40A	215	03.9631.14ACB	99	03.9721.40A	218	03.9821.40ADA	218
03.9447.14A	213	03.9476.40ADA	215	03.9631.14BDA	99	03.9721.40ADA	218	03.9821.40A	218
03.9447.14ADA	213	03.9477.14A	215	03.9631.40A	99	03.9722.14A	219	03.9821.40ADA	218
03.9447.40A	213	03.9477.14ADA	215	03.9631.40ACB	99	03.9722.14ADA	219	03.9822.14A	219
03.9447.40ADA	213	03.9477.40A	215	03.9631.40BDA	99	03.9722.40A	219	03.9822.14ADA	219
03.9448.14A	213	03.9477.40ADA	215	03.9632.14A	99	03.9722.40ADA	219	03.9822.40A	219
03.9448.14ADA	213	03.9478.14A	215	03.9632.14ACB	99	03.9723.14A	219	03.9822.40ADA	219
03.9448.40A	213	03.9478.14ADA	215	03.9632.14BDA	99	03.9723.14ADA	219	03.9823.14A	219
03.9448.40ADA	213	03.9478.40A	215	03.9632.40A	99	03.9723.40A	219	03.9823.14ADA	219
03.9450.14A	212	03.9478.40ADA	215	03.9632.40ACB	99	03.9723.40ADA	219	03.9823.40A	219
03.9450.14ADA	212	03.9500.02	538	03.9632.40BDA	99	03.9725.14A	219	03.9823.40ADA	219
03.9450.40A	212	03.9500.14	538	03.9633.14A	99	03.9725.14ADA	219	03.9825.14A	219
03.9450.40ADA	212	03.9500.40	538	03.9633.14ACB	99	03.9725.40A	219	03.9825.14ADA	219
03.9451.14A	212	03.9501.02	538	03.9633.14BDA	99	03.9725.40ADA	219	03.9825.40A	219
03.9451.14ADA	212	03.9501.14	538	03.9633.40A	99	03.9726.14A	219	03.9825.40ADA	219
03.9451.40A	212	03.9501.40	538	03.9633.40ACB	99	03.9726.14ADA	219	03.9826.14A	219
03.9451.40ADA	212	03.9502.02	538	03.9633.40BDA	99	03.9726.40A	219	03.9826.14ADA	219
03.9452.14A	212	03.9502.14	538	03.9635.14A	100	03.9726.40ADA	219	03.9826.40A	219
03.9452.14ADA	212	03.9502.40	538	03.9635.14ACB	100	03.9727.14A	219	03.9826.40ADA	219
03.9452.40A	212	03.9503.02	538	03.9635.14BDA	100	03.9727.14ADA	219	03.9827.14A	219
03.9452.40ADA	212	03.9503.14	538	03.9635.40A	100	03.9727.40A	219	03.9827.14ADA	219
03.9453.14A	212	03.9503.40	538	03.9635.40ACB	100	03.9727.40ADA	219	03.9827.40A	219
03.9453.14ADA	212	03.9510.02	538	03.9635.40BDA	100	03.9728.14A	219	03.9827.40ADA	219
03.9453.40A	212	03.9510.14	538	03.9636.14A	100	03.9728.14ADA	219	03.9828.14A	219
03.9453.40ADA	212	03.9510.40	538	03.9636.14ACB	100	03.9728.40A	219	03.9828.14ADA	219
03.9455.14A	213	03.9511.02	538	03.9636.14BDA	100	03.9728.40ADA	219	03.9828.40A	219
03.9455.14ADA	213	03.9511.14	538	03.9636.40A	100	03.9730.14A	218	03.9828.40ADA	219
03.9455.40A	213	03.9511.40	538	03.9636.40ACB	100	03.9730.14ADA	218	03.9830.14A	218
03.9455.40ADA	213	03.9560.02	539	03.9636.40BDA	100	03.9730.40A	218	03.9830.14ADA	218
03.9456.14A	213	03.9560.14	539	03.9637.14A	100	03.9730.40ADA	218	03.9830.40A	218
03.9456.14ADA	213	03.9560.40	539	03.9637.14ACB	100	03.9731.14A	218	03.9830.40ADA	218
03.9456.40A	213	03.9561.02	539	03.9637.14BDA	100	03.9731.14ADA	218	03.9831.14A	218
03.9456.40ADA	213	03.9561.14	539	03.9637.40A	100	03.9731.40A	218	03.9831.14ADA	218
03.9457.14A	213	03.9561.40	539	03.9637.40ACB	100	03.9731.40ADA	218	03.9831.40A	218
03.9457.14ADA	213	03.9570.02	539	03.9637.40BDA	100	03.9732.14A	219	03.9831.40ADA	218
03.9457.40A	213	03.9570.14	539	03.9638.14A	100	03.9732.14ADA	219	03.9832.14A	219
03.9457.40ADA	213	03.9570.40	539	03.9638.14ACB	100	03.9732.40A	219	03.9832.14ADA	219
03.9458.14A	213	03.9571.02	539	03.9638.14BDA	100	03.9732.40ADA	219	03.9832.40A	219
03.9458.14ADA	213	03.9571.14	539	03.9638.40A	100	03.9733.14A	219	03.9832.40ADA	219
03.9458.40A	213	03.9571.40	539	03.9638.40ACB	100	03.9733.14ADA	219	03.9833.14A	219
03.9458.40ADA	213	03.9620.14A	99	03.9638.40BDA	100	03.9733.40A	219	03.9833.14ADA	219
03.9460.14A	214	03.9620.14ACB	99	03.9660.14A	101	03.9733.40ADA	219	03.9833.40A	219
03.9460.14ADA	214	03.9620.14BDA	99	03.9660.14ACB	101	03.9735.14A	219	03.9833.40ADA	219
03.9460.40A	214	03.9620.40A	99	03.9660.14BDA	101	03.9735.14ADA	219	03.9835.14A	219
03.9460.40ADA	214	03.9620.40ACB	99	03.9660.40A	101	03.9735.40A	219	03.9835.14ADA	219
03.9461.14A	214	03.9620.40BDA	99	03.9660.40ACB	101	03.9735.40ADA	219	03.9835.40A	219
03.9461.14ADA	214	03.9621.14A	99	03.9660.40BDA	101	03.9736.14A	219	03.9835.40ADA	219

QUICK SEARCH OF PRODUCT

Ref.	Page	Ref.	Page	Ref.	Page	Ref.	Page	Ref.	Page
03.9836.14A	219	03.9921.GL	230	03.9965.40	230	04.6022.14.NT	436	05.7006.B1	343
03.9836.14ADA	219	03.9922.06	230	03.9965.GL	230	04.6022.20	436	05.7006.BU	343
03.9836.40A	219	03.9922.14	230	03.9966.06	230	04.6022.20.NT	436	05.7006.CU	343
03.9836.40ADA	219	03.9922.40	230	03.9966.14	230	04.6300.08	441	05.7006.GL	343
03.9837.14A	219	03.9922.GL	230	03.9966.40	230	04.6300.14	441	05.7007.74	344
03.9837.14ADA	219	03.9923.06	231	03.9966.GL	230	04.6300.20	441	05.7007.B1	344
03.9837.40A	219	03.9923.14	231	03.9967.06	231	04.6301.08	442	05.7007.BU	344
03.9837.40ADA	219	03.9923.40	231	03.9967.14	231	04.6301.14	442	05.7007.CU	344
03.9838.14A	219	03.9923.GL	231	03.9967.40	231	04.6301.20	442	05.7007.GL	344
03.9838.14ADA	219	03.9924.06	230	03.9967.06	231	04.6302.08	443	05.7010.74	346
03.9838.40A	219	03.9924.14	230	03.9968.06	230	04.6302.14	443	05.7010.B1	346
03.9838.40ADA	219	03.9924.40	230	03.9968.14	230	04.6302.20	443	05.7010.BU	346
03.9860.14A	220	03.9924.GL	230	03.9968.40	230	04.6305.08	441	05.7010.CU	346
03.9860.14ADA	220	03.9931.06A	229	03.9968.GL	230	04.6305.14	441	05.7010.GL	346
03.9860.40A	220	03.9931.14A	229	03.9969.06	230	04.6305.20	441	05.7011.74	347
03.9860.40ADA	220	03.9931.40A	229	03.9969.14	230	04.6306.08	442	05.7011.B1	347
03.9861.14A	220	03.9931.GLA	229	03.9969.40	230	04.6306.14	442	05.7011.BU	347
03.9861.14ADA	220	03.9932.06A	229	03.9969.6A	230	04.6306.20	442	05.7011.CU	347
03.9861.40A	220	03.9932.14A	229	03.9971.06A	229	04.6307.08	443	05.7011.GL	347
03.9861.40ADA	220	03.9932.40A	229	03.9971.14A	229	04.6307.14	443	05.7012.74	348
03.9862.14A	220	03.9932.GLA	229	03.9971.40A	229	04.6307.20	443	05.7012.B1	348
03.9862.14ADA	220	03.9933.06A	229	03.9971.GLA	229	04.6330.08B	441	05.7012.BU	348
03.9862.40A	220	03.9933.14A	229	03.9972.06A	229	04.6330.14B	441	05.7012.CU	348
03.9862.40ADA	220	03.9933.40A	229	03.9972.14A	229	04.6330.20B	441	05.7012.GL	348
03.9863.14A	220	03.9933.GLA	229	03.9972.40A	229	04.6333.08B	442	05.7015.74	346
03.9863.14ADA	220	03.9940.06	232	03.9972.GLA	229	04.6333.14B	442	05.7015.B1	346
03.9863.40A	220	03.9940.14	232	03.9973.06A	229	04.6333.20B	442	05.7015.BU	346
03.9863.40ADA	220	03.9940.40	232	03.9973.14A	229	04.6334.08B	442	05.7015.CU	346
03.9864.14A	220	03.9940.GL	232	03.9973.40A	229	04.6334.14B	442	05.7015.GL	346
03.9864.14ADA	220	03.9941.06	232	03.9973.GLA	229	04.6334.20B	442	05.7016.74	347
03.9864.40A	220	03.9941.14	232	03.9976.06A	229	04.6335.08B	442	05.7016.B1	347
03.9864.40ADA	220	03.9941.40	232	03.9976.14A	229	04.6335.14B	442	05.7016.BU	347
03.9865.14A	220	03.9941.GL	232	03.9976.40A	229	04.6335.20B	442	05.7016.CU	347
03.9865.14ADA	220	03.9942.06	232	03.9976.GLA	229	04.6336.08B	443	05.7016.GL	347
03.9865.40A	220	03.9942.14	232	03.9977.06A	229	04.6336.14B	443	05.7017.74	348
03.9865.40ADA	220	03.9942.40	232	03.9977.14A	229	04.6336.20B	443	05.7017.B1	348
03.9866.14A	220	03.9942.GL	232	03.9977.40A	229	04.6337.08B	443	05.7017.BU	348
03.9866.14ADA	220	03.9943.06	232	03.9977.GLA	229	04.6337.14B	443	05.7017.CU	348
03.9866.40A	220	03.9943.14	232	03.9978.06A	229	04.6337.20B	443	05.7017.GL	348
03.9866.40ADA	220	03.9943.40	232	03.9978.14A	229	04.6338.08B	443	05.7020.74	350
03.9867.14A	220	03.9943.GL	232	03.9978.40A	229	04.6338.14B	443	05.7020.B1	350
03.9867.14ADA	220	03.9950.06	228	03.9978.GLA	229	04.6338.20B	443	05.7020.BU	350
03.9867.40A	220	03.9950.14	228	03.9980.06	232	04.6470.08B	434	05.7020.CU	350
03.9867.40ADA	220	03.9950.40	228	03.9980.14	232	04.6470.14B	434	05.7020.GL	350
03.9900.14A	216	03.9950.GL	228	03.9980.40	232	04.6470.14BNT	434	05.7021.74	350
03.9900.14ADA	216	03.9951.06	228	03.9980.GL	232	04.6470.20B	434	05.7021.B1	350
03.9900.40A	216	03.9951.14	228	03.9981.06	232	04.6471.08B	434	05.7021.BU	350
03.9900.40ADA	216	03.9951.40	228	03.9981.14	232	04.6471.14B	434	05.7021.CU	350
03.9901.14A	216	03.9951.GL	228	03.9981.40	232	04.6471.14BNT	434	05.7021.GL	350
03.9901.14ADA	216	03.9952.06	228	03.9981.GL	232	04.6471.20B	434	05.7030.74	345
03.9901.40A	216	03.9952.14	228	03.9982.06	232	04.6475.08B	434	05.7030.B1	345
03.9901.40ADA	216	03.9952.40	228	03.9982.14	232	04.6475.14B	434	05.7030.BU	345
03.9902.14A	216	03.9952.GL	228	03.9982.40	232	04.6475.14BNT	434	05.7030.CU	345
03.9902.14ADA	216	03.9953.06	228	03.9982.GL	232	04.6475.20B	434	05.7030.GL	345
03.9902.40A	216	03.9953.14	228	03.9983.06	232	04.6476.08B	434	05.7031.74	345
03.9902.40ADA	216	03.9953.40	228	03.9983.14	232	04.6476.14B	434	05.7031.B1	345
03.9903.14A	216	03.9953.GL	228	03.9983.40	232	04.6476.14BNT	434	05.7031.BU	345
03.9903.14ADA	216	03.9954.06	228	03.9983.GL	232	04.6476.20B	434	05.7031.CU	345
03.9903.40A	216	03.9954.14	228	03.9985.06	232	04.6480.08B	435	05.7031.GL	345
03.9903.40ADA	216	03.9954.40	228	03.9985.14	232	04.6480.14B	435	05.7035.74	349
03.9904.14A	102	03.9954.GL	228	03.9985.40	232	04.6480.14BNT	435	05.7035.B1	349
03.9904.14ACB	102	03.9955.06	228	03.9985.GL	232	04.6480.20B	435	05.7035.BU	349
03.9904.14BDA	102	03.9955.14	228	03.9986.06	232	04.6481.08B	435	05.7035.CU	349
03.9904.40A	102	03.9955.40	228	03.9986.14	232	04.6481.14B	435	05.7035.GL	349
03.9904.40ACB	102	03.9955.GL	228	03.9986.40	232	04.6481.14BNT	435	05.7036.74	349
03.9904.40BDA	102	03.9956.06	228	03.9986.GL	232	04.6481.20B	435	05.7036.B1	349
03.9905.14A	102	03.9956.14	228	03.9987.06	232	04.6485.08B	435	05.7036.BU	349
03.9905.14ACB	102	03.9956.40	228	03.9987.14	232	04.6485.14B	435	05.7036.CU	349
03.9905.14BDA	102	03.9956.GL	228	03.9987.40	232	04.6485.14BNT	435	05.7036.GL	349
03.9905.40A	102	03.9957.06	228	03.9987.6A	232	04.6485.20B	435	05.7040.74	351
03.9905.40ACB	102	03.9957.14	228	03.9988.06	232	04.6486.08B	435	05.7040.B1	351
03.9905.40BDA	102	03.9957.40	228	03.9988.14	232	04.6486.14B	435	05.7040.BU	351
03.9910.06	228	03.9957.GL	228	03.9988.40	232	04.6486.14BNT	435	05.7040.CU	351
03.9910.14	228	03.9960.06	230	03.9988.GL	232	04.6486.20B	435	05.7040.GL	351
03.9910.40	228	03.9960.14	230	04.6001.08	437	05.7000.74	342	05.7041.74	351
03.9910.GL	228	03.9960.40	230	04.6001.08.NT	437	05.7000.B1	342	05.7041.B1	351
03.9911.06	228	03.9960.GL	230	04.6001.14	437	05.7000.BU	342	05.7041.BU	351
03.9911.14	228	03.9961.06	230	04.6001.14.NT	437	05.7000.CU	342	05.7041.CU	351
03.9911.40	228	03.9961.14	230	04.6001.20	437	05.7000.GL	342	05.7041.GL	351
03.9911.GL	228	03.9961.40	230	04.6001.20.NT	437	05.7001.74	343	05.7100.74	285
03.9912.06	228	03.9961.GL	230	04.6002.08	437	05.7001.B1	343	05.7100.B1	285
03.9912.14	228	03.9962.06	230	04.6002.08.NT	437	05.7001.BU	343	05.7100.BU	285
03.9912.40	228	03.9962.14	230	04.6002.14	437	05.7001.CU	343	05.7100.CU	285
03.9912.GL	228	03.9962.40	230	04.6002.14.NT	437	05.7001.GL	343	05.7100.GL	285
03.9913.06	228	03.9962.GL	230	04.6002.20	437	05.7002.74	344	05.7101.74	286
03.9913.14	228	03.9963.06	231	04.6002.20.NT	437	05.7002.B1	344	05.7101.B1	286
03.9913.40	228	03.9963.14	231	04.6021.08	436	05.7002.BU	344	05.7101.BU	286
03.9913.GL	228	03.9963.40	231	04.6021.08.NT	436	05.7002.CU	344	05.7101.CU	286
03.9920.06	230	03.9963.GL	231	04.6021.14	436	05.7002.GL	344	05.7101.GL	286
03.9920.14	230	03.9964.06	230	04.6021.14.NT	436	05.7005.74	342	05.7102.74	287
03.9920.40	230	03.9964.14	230	04.6021.20	436	05.7005.B1	342	05.7102.B1	287
03.9920.GL	230	03.9964.40	230	04.6021.20.NT	436	05.7005.BU	342	05.7102.BU	287
03.9921.06	230	03.9964.GL	230	04.6022.08	436	05.7005.CU	342	05.7102.CU	287
03.9921.14	230	03.9965.06	230	04.6022.08.NT	436	05.7005.GL	342	05.7102.GL	287
03.9921.40	230	03.9965.14	230	04.6022.14	436	05.7006.74	343	05.7105.74	285

QUICK SEARCH OF PRODUCT

Ref.	Page	Ref.	Page	Ref.	Page	Ref.	Page	Ref.	Page
05.7105.B1	285	05.7152.B1	298	05.7305.B1	247	05.7410.B1	255	05.7437.B1	339
05.7105.BU	285	05.7152.BU	298	05.7305.BU	247	05.7410.BU	255	05.7437.BU	339
05.7105.CU	285	05.7152.CU	298	05.7305.CU	247	05.7410.CU	255	05.7437.CU	339
05.7105.GL	285	05.7152.GL	298	05.7305.GL	247	05.7410.GL	255	05.7437.GL	339
05.7106.74	286	05.7155.74	296	05.7306.74	248	05.7411.74	255	05.7438.74	332
05.7106.B1	286	05.7155.B1	296	05.7306.B1	248	05.7411.B1	255	05.7438.B1	332
05.7106.BU	286	05.7155.BU	296	05.7306.BU	248	05.7411.BU	255	05.7438.BU	332
05.7106.CU	286	05.7155.CU	296	05.7306.CU	248	05.7411.CU	255	05.7438.CU	332
05.7106.GL	286	05.7155.GL	296	05.7306.GL	248	05.7411.GL	255	05.7438.GL	332
05.7107.74	287	05.7156.74	297	05.7307.74	249	05.7412.74	261	05.7439.74	332
05.7107.B1	287	05.7156.B1	297	05.7307.B1	249	05.7412.B1	261	05.7439.B1	332
05.7107.BU	287	05.7156.BU	297	05.7307.BU	249	05.7412.BU	261	05.7439.BU	332
05.7107.CU	287	05.7156.CU	297	05.7307.CU	249	05.7412.CU	261	05.7439.CU	332
05.7107.GL	287	05.7156.GL	297	05.7307.GL	249	05.7412.GL	261	05.7439.GL	332
05.7110.74	290	05.7157.74	298	05.7310.74	250	05.7413.74	261	05.7440.74	311
05.7110.B1	290	05.7157.B1	298	05.7310.B1	250	05.7413.B1	261	05.7440.B1	311
05.7110.BU	290	05.7157.BU	298	05.7310.BU	250	05.7413.BU	261	05.7440.BU	311
05.7110.CU	290	05.7157.CU	298	05.7310.CU	250	05.7413.CU	261	05.7440.CU	311
05.7110.GL	290	05.7157.GL	298	05.7310.GL	250	05.7413.GL	261	05.7440.GL	311
05.7111.74	291	05.7200.74	305	05.7311.74	251	05.7414.74	268	05.7441.74	311
05.7111.B1	291	05.7200.B1	305	05.7311.B1	251	05.7414.B1	268	05.7441.B1	311
05.7111.BU	291	05.7200.BU	305	05.7311.BU	251	05.7414.BU	268	05.7441.BU	311
05.7111.CU	291	05.7200.CU	305	05.7311.CU	251	05.7414.CU	268	05.7441.CU	311
05.7111.GL	291	05.7200.GL	305	05.7311.GL	251	05.7414.GL	268	05.7441.GL	311
05.7112.74	292	05.7201.74	306	05.7312.74	252	05.7415.74	268	05.7442.74	330
05.7112.B1	292	05.7201.B1	306	05.7312.B1	252	05.7415.B1	268	05.7442.B1	330
05.7112.BU	292	05.7201.BU	306	05.7312.BU	252	05.7415.BU	268	05.7442.BU	330
05.7112.CU	292	05.7201.CU	306	05.7312.CU	252	05.7415.CU	268	05.7442.CU	330
05.7112.GL	292	05.7201.GL	306	05.7312.GL	252	05.7415.GL	268	05.7442.GL	330
05.7115.74	290	05.7202.74	307	05.7315.74	250	05.7416.74	274	05.7443.74	330
05.7115.B1	290	05.7202.B1	307	05.7315.B1	250	05.7416.B1	274	05.7443.B1	330
05.7115.BU	290	05.7202.BU	307	05.7315.BU	250	05.7416.BU	274	05.7443.BU	330
05.7115.CU	290	05.7202.CU	307	05.7315.CU	250	05.7416.CU	274	05.7443.CU	330
05.7115.GL	290	05.7202.GL	307	05.7315.GL	250	05.7416.GL	274	05.7443.GL	330
05.7116.74	291	05.7205.74	305	05.7316.74	251	05.7417.74	274	05.7444.74	334
05.7116.B1	291	05.7205.B1	305	05.7316.B1	251	05.7417.B1	274	05.7444.B1	334
05.7116.BU	291	05.7205.BU	305	05.7316.BU	251	05.7417.BU	274	05.7444.BU	334
05.7116.CU	291	05.7205.CU	305	05.7316.CU	251	05.7417.CU	274	05.7444.CU	334
05.7116.GL	291	05.7205.GL	305	05.7316.GL	251	05.7417.GL	274	05.7444.GL	334
05.7117.74	292	05.7206.74	306	05.7317.74	252	05.7420.74	279	05.7445.74	334
05.7117.B1	292	05.7206.B1	306	05.7317.B1	252	05.7420.B1	279	05.7445.B1	334
05.7117.BU	292	05.7206.BU	306	05.7317.BU	252	05.7420.BU	279	05.7445.BU	334
05.7117.CU	292	05.7206.CU	306	05.7317.CU	252	05.7420.CU	279	05.7445.CU	334
05.7117.GL	292	05.7206.GL	306	05.7317.GL	252	05.7420.GL	279	05.7445.GL	334
05.7120.74	294	05.7207.74	307	05.7400.74	324	05.7421.74	279	05.7446.74	315
05.7120.B1	294	05.7207.B1	307	05.7400.B1	324	05.7421.B1	279	05.7446.B1	315
05.7120.BU	294	05.7207.BU	307	05.7400.BU	324	05.7421.BU	279	05.7446.BU	315
05.7120.CU	294	05.7207.CU	307	05.7400.CU	324	05.7421.CU	279	05.7446.CU	315
05.7120.GL	294	05.7207.GL	307	05.7400.GL	324	05.7421.GL	279	05.7446.GL	315
05.7121.74	294	05.7210.74	308	05.7401.74	326	05.7422.74	281	05.7447.74	315
05.7121.B1	294	05.7210.B1	308	05.7401.B1	326	05.7422.B1	281	05.7447.B1	315
05.7121.BU	294	05.7210.BU	308	05.7401.BU	326	05.7422.BU	281	05.7447.BU	315
05.7121.CU	294	05.7210.CU	308	05.7401.CU	326	05.7422.CU	281	05.7447.CU	315
05.7121.GL	294	05.7210.GL	308	05.7401.GL	326	05.7422.GL	281	05.7447.GL	315
05.7130.74	289	05.7211.74	309	05.7402.74	328	05.7423.74	281	05.7450.74	253
05.7130.B1	289	05.7211.B1	309	05.7402.B1	328	05.7423.B1	281	05.7450.B1	253
05.7130.BU	289	05.7211.BU	309	05.7402.BU	328	05.7423.BU	281	05.7450.BU	253
05.7130.CU	289	05.7211.CU	309	05.7402.CU	328	05.7423.CU	281	05.7450.CU	253
05.7130.GL	289	05.7211.GL	309	05.7402.GL	328	05.7423.GL	281	05.7450.GL	253
05.7131.74	289	05.7212.74	310	05.7403.74	324	05.7430.74	313	05.7451.74	253
05.7131.B1	289	05.7212.B1	310	05.7403.B1	324	05.7430.B1	313	05.7451.B1	253
05.7131.BU	289	05.7212.BU	310	05.7403.BU	324	05.7430.BU	313	05.7451.BU	253
05.7131.CU	289	05.7212.CU	310	05.7403.CU	324	05.7430.CU	313	05.7451.CU	253
05.7131.GL	289	05.7212.GL	310	05.7403.GL	324	05.7430.GL	313	05.7451.GL	253
05.7135.74	293	05.7215.74	308	05.7404.74	326	05.7431.74	313	05.7452.74	257
05.7135.B1	293	05.7215.B1	308	05.7404.B1	326	05.7431.B1	313	05.7452.B1	257
05.7135.BU	293	05.7215.BU	308	05.7404.BU	326	05.7431.BU	313	05.7452.BU	257
05.7135.CU	293	05.7215.CU	308	05.7404.CU	326	05.7431.CU	313	05.7452.CU	257
05.7135.GL	293	05.7215.GL	308	05.7404.GL	326	05.7431.GL	313	05.7452.GL	257
05.7136.74	293	05.7216.74	309	05.7405.74	328	05.7432.74	319	05.7453.74	257
05.7136.B1	293	05.7216.B1	309	05.7405.B1	328	05.7432.B1	319	05.7453.B1	257
05.7136.BU	293	05.7216.BU	309	05.7405.BU	328	05.7432.BU	319	05.7453.BU	257
05.7136.CU	293	05.7216.CU	309	05.7405.CU	328	05.7432.CU	319	05.7453.CU	257
05.7136.GL	293	05.7216.GL	309	05.7405.GL	328	05.7432.GL	319	05.7453.GL	257
05.7140.74	295	05.7217.74	310	05.7406.74	317	05.7433.74	319	05.7454.74	259
05.7140.B1	295	05.7217.B1	310	05.7406.B1	317	05.7433.B1	319	05.7454.B1	259
05.7140.BU	295	05.7217.BU	310	05.7406.BU	317	05.7433.BU	319	05.7454.BU	259
05.7140.CU	295	05.7217.CU	310	05.7406.CU	317	05.7433.CU	319	05.7454.CU	259
05.7140.GL	295	05.7217.GL	310	05.7406.GL	317	05.7433.GL	319	05.7454.GL	259
05.7141.74	295	05.7300.74	247	05.7407.74	317	05.7434.74	337	05.7455.74	259
05.7141.B1	295	05.7300.B1	247	05.7407.B1	317	05.7434.B1	337	05.7455.B1	259
05.7141.BU	295	05.7300.BU	247	05.7407.BU	317	05.7434.BU	337	05.7455.BU	259
05.7141.CU	295	05.7300.CU	247	05.7407.CU	317	05.7434.CU	337	05.7455.CU	259
05.7141.GL	295	05.7300.GL	247	05.7407.GL	317	05.7434.GL	337	05.7455.GL	259
05.7150.74	296	05.7301.74	248	05.7408.74	321	05.7435.74	337	05.7456.74	263
05.7150.B1	296	05.7301.B1	248	05.7408.B1	321	05.7435.B1	337	05.7456.B1	263
05.7150.BU	296	05.7301.BU	248	05.7408.BU	321	05.7435.BU	337	05.7456.BU	263
05.7150.CU	296	05.7301.CU	248	05.7408.CU	321	05.7435.CU	337	05.7456.CU	263
05.7150.GL	296	05.7301.GL	248	05.7408.GL	321	05.7435.GL	337	05.7456.GL	263
05.7151.74	297	05.7302.74	249	05.7409.74	321	05.7436.74	339	05.7457.74	263
05.7151.B1	297	05.7302.B1	249	05.7409.B1	321	05.7436.B1	339	05.7457.B1	263
05.7151.BU	297	05.7302.BU	249	05.7409.BU	321	05.7436.BU	339	05.7457.BU	263
05.7151.CU	297	05.7302.CU	249	05.7409.CU	321	05.7436.CU	339	05.7457.CU	263
05.7151.GL	297	05.7302.GL	249	05.7409.GL	321	05.7436.GL	339	05.7457.GL	263
05.7152.74	298	05.7305.74	247	05.7410.74	255	05.7437.74	339	05.7458.74	266

QUICK SEARCH OF PRODUCT

Ref.	Page	Ref.	Page	Ref.	Page	Ref.	Page	Ref.	Page
05.7458.B1	266	06.1603.40	87	06.1862.14	147	06.5022.40	114	06.5142.14A	16
05.7458.BU	266	06.1604.14	87	06.1862.40	147	06.5023.05	114	06.5142.40A	16
05.7458.CU	266	06.1604.40	87	06.1863.14	147	06.5023.14	114	06.5150.14	17
05.7458.GL	266	06.1605.14	87	06.1863.40	147	06.5023.40	114	06.5150.40	17
05.7459.74	266	06.1605.40	87	06.2500.06	56	06.5024.14	114	06.5151.14	17
05.7459.B1	266	06.1606.14	87	06.2500.14	56	06.5024.40	114	06.5151.40	17
05.7459.BU	266	06.1606.40	87	06.2500.18	56	06.5025.05	115	06.5152.14	17
05.7459.CU	266	06.1607.14	87	06.2500.40	56	06.5025.14	115	06.5152.40	17
05.7459.GL	266	06.1607.40	87	06.2500.CZ	56	06.5025.40	115	06.5153.14	17
05.7460.74	270	06.1608.14	87	06.2501.06	56	06.5026.05	115	06.5153.40	17
05.7460.B1	270	06.1608.40	87	06.2501.14	56	06.5026.14	115	06.5155.14	17
05.7460.BU	270	06.1609.14	87	06.2501.18	56	06.5026.40	115	06.5155.40	17
05.7460.CU	270	06.1609.40	87	06.2501.40	56	06.5040.14	110	06.5156.14	17
05.7460.GL	270	06.1610.14	87	06.2501.CZ	56	06.5041.14	110	06.5156.40	17
05.7461.74	270	06.1610.40	87	06.2502.06	56	06.5042.14	110	06.5157.14	17
05.7461.B1	270	06.1612.14	87	06.2502.14	56	06.5043.14	110	06.5157.40	17
05.7461.BU	270	06.1612.40	87	06.2502.18	56	06.5044.14	110	06.5158.14	17
05.7461.CU	270	06.1614.14A	88	06.2502.40	56	06.5045.14	110	06.5158.40	17
05.7461.GL	270	06.1614.40A	88	06.2502.CZ	56	06.5046.14	110	06.5300.14	48
05.7462.74	272	06.1615.14A	88	06.2506.14	56	06.5047.14	110	06.5300.1A	48
05.7462.B1	272	06.1615.40A	88	06.2506.40	56	06.5050.14	110	06.5300.40	48
05.7462.BU	272	06.1616.14A	88	06.2509.14	57	06.5051.14	110	06.5300.CZ	48
05.7462.CU	272	06.1616.40A	88	06.2509.18	57	06.5052.14	110	06.5301.14	48
05.7462.GL	272	06.1617.14A	88	06.2509.40	57	06.5053.14	110	06.5301.1A	48
05.7463.74	272	06.1617.40A	88	06.2509.CZ	57	06.5054.14	110	06.5301.40	48
05.7463.B1	272	06.1618.14A	88	06.2510.06	64	06.5060.05	112	06.5301.CZ	48
05.7463.BU	272	06.1618.40A	88	06.2510.14	64	06.5060.14	112	06.5302.14	48
05.7463.CU	272	06.1619.14A	88	06.2510.18	64	06.5060.40	112	06.5302.1A	48
05.7463.GL	272	06.1619.40A	88	06.2510.40	64	06.5061.05	112	06.5302.40	48
05.7464.74	276	06.1620.14A	88	06.2510.CZ	64	06.5061.14	112	06.5302.CZ	48
05.7464.B1	276	06.1620.40A	88	06.2511.06	64	06.5061.40	112	06.5303.14	48
05.7464.BU	276	06.1621.14A	88	06.2511.14	64	06.5062.05	112	06.5303.1A	48
05.7464.CU	276	06.1621.40A	88	06.2511.18	64	06.5062.14	112	06.5303.40	48
05.7464.GL	276	06.1622.14A	88	06.2511.40	64	06.5062.40	112	06.5303.CZ	48
05.7465.74	276	06.1622.40A	88	06.2511.CZ	64	06.5063.05	112	06.5304.14	49
05.7465.B1	276	06.1623.14A	88	06.2540.14	56	06.5063.14	112	06.5304.1A	49
05.7465.BU	276	06.1623.40A	88	06.2540.18	56	06.5063.40	112	06.5304.40	49
05.7465.CU	276	06.1624.14	88	06.2540.40	56	06.5064.14	112	06.5304.CZ	49
05.7465.GL	276	06.1624.40	88	06.2540.CZ	56	06.5064.40	112	06.5305.14	49
06.0097.00	166	06.1626.14	89	06.2541.14	56	06.5070.05	114	06.5305.1A	49
06.0098.00	166	06.1626.40	89	06.2541.18	56	06.5070.14	114	06.5305.40	49
06.0157.00	113	06.1627.14	89	06.2541.40	56	06.5070.40	114	06.5305.CZ	49
06.0173.14	13	06.1627.40	89	06.2541.CZ	56	06.5071.05	114	06.5306.14	49
06.0301.00	147	06.1628.14	89	06.2542.14	56	06.5071.14	114	06.5306.1A	49
06.0303.00	147	06.1628.40	89	06.2542.18	56	06.5071.40	114	06.5306.40	49
06.1003.00	609	06.1629.14	89	06.2542.40	56	06.5072.05	114	06.5306.CZ	49
06.1005.00	609	06.1629.40	89	06.2542.CZ	56	06.5072.14	114	06.5310.14	48
06.1005.00	636	06.1630.14	89	06.2543.14	56	06.5072.40	114	06.5310.1A	48
06.1011.00	609	06.1630.40	89	06.2543.18	56	06.5073.05	114	06.5310.40	48
06.1012.00	609	06.1631.14	89	06.2543.40	56	06.5073.14	114	06.5310.CZ	48
06.1012.00	636	06.1631.40	89	06.2543.CZ	56	06.5073.40	114	06.5311.14	48
06.1013.00	610	06.1632.14	89	06.2544.14	56	06.5074.14	114	06.5311.1A	48
06.1013.00	636	06.1632.40	89	06.2544.18	56	06.5074.40	114	06.5311.40	48
06.1014.00	610	06.1633.14	89	06.2544.40	56	06.5100.14	16	06.5311.CZ	48
06.1014.00	637	06.1633.40	89	06.2544.CZ	56	06.5100.40	16	06.5312.14	49
06.1016.00	602	06.1634.14	89	06.2545.14	57	06.5101.14	16	06.5312.1A	49
06.1016.00	636	06.1634.40	89	06.2545.18	57	06.5101.40	16	06.5312.40	49
06.1019.00	609	06.1635.14	89	06.2545.40	57	06.5110.14	16	06.5312.CZ	49
06.1019.00	636	06.1635.40	89	06.2545.CZ	57	06.5110.40	16	06.5313.14	49
06.1020.00	610	06.1638.14	86	06.2546.14	57	06.5111.14	16	06.5313.1A	49
06.1022.00	602	06.1639.14	86	06.2546.18	57	06.5111.40	16	06.5313.40	49
06.1022.00	636	06.1640.14	86	06.2546.40	57	06.5112.14	16	06.5313.CZ	49
06.1022.00	637	06.1641.14	86	06.2546.CZ	57	06.5112.40	16	06.5314.14	48
06.1023.00	602	06.1642.14	86	06.5008.14	111	06.5113.14	16	06.5314.1A	48
06.1024.00	603	06.1643.14	86	06.5010.05	112	06.5113.40	16	06.5314.40	48
06.1025.00	602	06.1644.14	86	06.5010.14	112	06.5115.14	17	06.5314.CZ	48
06.1026.00	602	06.1645.14	86	06.5010.40	112	06.5115.40	17	06.5315.14	49
06.1027.00	602	06.1646.14	86	06.5011.05	112	06.5116.14	17	06.5315.1A	49
06.1028.00	603	06.1647.14	86	06.5011.14	112	06.5116.40	17	06.5315.40	49
06.1032.00	241	06.1648.14	86	06.5011.40	112	06.5117.14	17	06.5315.CZ	49
06.1033.00	241	06.1650.14	86	06.5012.05	112	06.5117.40	17	06.5400.14	31
06.1034.00	241	06.1651.14	86	06.5012.14	112	06.5118.14	17	06.5400.40	31
06.1049.00	636	06.1656.14	89	06.5012.40	112	06.5118.40	17	06.5401.14	31
06.1100.40	176	06.1656.40	89	06.5013.05	112	06.5120.14	17	06.5401.40	31
06.1105.40	176	06.1657.14	89	06.5013.14	112	06.5120.40	17	06.5402.14	31
06.1110.40	176	06.1657.40	89	06.5013.40	112	06.5121.14	17	06.5402.40	31
06.1115.40	176	06.1740.14	89	06.5014.14	112	06.5121.40	17	06.5403.14	31
06.1120.40	176	06.1741.14	89	06.5014.40	112	06.5122.14	17	06.5403.40	31
06.1125.40	176	06.1742.14	89	06.5015.05	112	06.5122.40	17	06.5404.14	31
06.1130.40	176	06.1800.14	132	06.5015.14	112	06.5123.14	17	06.5404.40	31
06.1131.40	176	06.1801.14	132	06.5015.40	112	06.5123.40	17	06.5405.14	31
06.1132.40	176	06.1802.14	132	06.5016.05	112	06.5125.14	17	06.5405.40	31
06.1133.40	176	06.1803.14	132	06.5016.14	112	06.5125.40	17	06.5410.14	31
06.1134.40	176	06.1804.14	132	06.5016.40	112	06.5126.14	17	06.5410.40	31
06.1135.40	176	06.1805.14	132	06.5017.05	112	06.5126.40	17	06.5411.14	31
06.1140.00	176	06.1806.14	132	06.5017.14	112	06.5127.14	17	06.5411.40	31
06.1141.00B	177	06.1807.14	132	06.5017.40	112	06.5127.40	17	06.5412.14	31
06.1142.00B	177	06.1850.14	146	06.5020.05	114	06.5128.14	17	06.5412.40	31
06.1600.14	87	06.1851.14	146	06.5020.14	114	06.5128.40	17	06.5413.14	31
06.1600.40	87	06.1852.14	146	06.5020.40	114	06.5135.14A	16	06.5413.40	31
06.1601.14	87	06.1853.14	146	06.5021.05	114	06.5135.40A	16	06.5414.14	31
06.1601.40	87	06.1860.14	147	06.5021.14	114	06.5140.14	16	06.5414.40	31
06.1602.14	87	06.1860.40	147	06.5021.40	114	06.5140.40	16	06.5415.14	31
06.1602.40	87	06.1861.14	147	06.5022.05	114	06.5141.14	16	06.5415.40	31
06.1603.14	87	06.1861.40	147	06.5022.14	114	06.5141.40	16	06.5420.14	31

QUICK SEARCH OF PRODUCT

Ref.	Page	Ref.	Page	Ref.	Page	Ref.	Page	Ref.	Page
06.5420.40	31	08.0165.40	233	08.0526.40	378	08.8029.14	439	08.8232.30	397
06.5421.14	31	08.0166.00	233	08.0526.40	477	08.8029.20	439	08.8232.30	499
06.5421.40	31	08.0167.00	233	08.0526.40	519	08.8030.08	439	08.8238.14	431
06.5430.14	31	08.0175.14	453	08.0526.BW	27	08.8030.14	439	08.8238.14	535
06.5430.40	31	08.0176.14	453	08.0526.BW	126	08.8030.20	439	08.8239.00B	371
06.6000.14	70	08.0177.14	453	08.0526.BW	141	08.8034.14	403	08.8240.00B	371
06.6001.14	70	08.0178.14	453	08.0526.BW	150	08.8034.14	431	08.8242.14	391
06.6002.14	70	08.0180.00	13	08.0526.BW	378	08.8034.14	535	08.8243.00	371
06.6003.14	70	08.0181.00	13	08.0526.BW	477	08.8036.14	403	08.8243.00.1U	371
06.6004.14	70	08.0182.00	13	08.0526.BW	519	08.8036.14	431	08.8243.00.5U	371
06.6010.14	71	08.0190.14	80	08.0550.00	425	08.8036.14	535	08.8246.00	571
06.6010.40	71	08.0191.14	80	08.0551.00	425	08.8041.68	365	08.8250.00	371
06.6011.14	71	08.0192.00	233	08.0555.00	425	08.8041.68	371	08.8251.00	352
06.6011.40	71	08.0193.00	233	08.0556.14	425	08.8041.68	403	08.8256.00	571
06.6012.14	71	08.0194.00	13	08.0556.40	425	08.8042.64.OD	403	08.8261.00	567
06.6012.40	71	08.0195.00	13	08.0556.CE	425	08.8042.65.OD	403	08.8270.00	633
06.6013.14	71	08.0205.00	515	08.0556.TK	425	08.8042.66.OD	403	08.8270.00	634
06.6013.40	71	08.0206.00	515	08.0557.14	425	08.8042.67.OD	403	08.8270.00	635
06.6014.14	71	08.0207.00	515	08.0557.40	425	08.8042.68	403	08.8270.14	443
06.6014.40	71	08.0208.00	515	08.0557.CE	425	08.8042.69	403	08.8294.00A	602
06.6030.14	70	08.0209.DR	515	08.0557.TK	425	08.8042.98.OD	403	08.8296.00A	602
06.6031.14	71	08.0209.DY	515	08.0580.00	226	08.8042.CL	403	08.8297.00	603
06.6031.40	71	08.0209.EQ	515	08.0581.00	226	08.8042.DL	403	08.8297.00	610
06.6032.14	70	08.0209.ER	515	08.0582.00	226	08.8042.ND	403	08.8297.00	637
06.6033.14	71	08.0209.ES	515	08.0583.00	226	08.8049.14	391	08.8298.00	603
06.6033.40	71	08.0210.00	515	08.0584.00	226	08.8080.00	438	08.8298.00	610
06.6034.14	70	08.0211.DR	515	08.0586.00	226	08.8081.00	438	08.8298.00	637
06.6034.14	71	08.0211.DY	515	08.0600.14	113	08.8084.00	438	08.8306.00	601
06.6034.40	71	08.0211.EQ	515	08.0600.40	113	08.8085.00	438	08.8307.00	601
06.6035.14	70	08.0211.ER	515	08.0611.14	110	08.8118.68	391	08.8308.00	601
06.6035.14	71	08.0211.ES	515	08.0611.14	112	08.8119.00	390	08.8314.00	601
06.6036.14	70	08.0212.DR	515	08.0612.14	110	08.8137.00	390	08.8315.00	601
06.6036.14	71	08.0212.DY	515	08.0612.14	112	08.8149.02	396	08.8316.00	601
06.6036.40	71	08.0212.EQ	515	08.0612.14	115	08.8149.14	396	08.8320.00	601
07.9000.01.E3	570	08.0212.ER	515	08.0613.14A	27	08.8149.30	396	08.8321.00	601
07.9000.04.E3	570	08.0212.ES	515	08.0613.14A	127	08.8152.00	396	08.8322.00	601
07.9000.18.E3	570	08.0226.00	515	08.0614.14	110	08.8156.00	352	08.8330.00	601
07.9000.72.E3	570	08.0227.00	515	08.0614.14	112	08.8160.64.OD	397	08.8356.00	601
07.9001.01.E3	570	08.0228.DR	515	08.0614.14	115	08.8160.64.OD	499	08.8359.00	390
07.9001.04.E3	570	08.0228.DY	515	08.0615.00	113	08.8160.65.OD	397	08.8363.14	173
07.9001.18.E3	570	08.0228.EQ	515	08.0616.00	113	08.8160.65.OD	499	08.8363.30	173
07.9001.72.E3	570	08.0228.ER	515	08.0626.00	115	08.8160.66.OD	397	08.8377.14	391
07.9004.01	571	08.0228.ES	515	08.0627.00	115	08.8160.66.OD	499	08.8380.14	173
07.9004.04	571	08.0231.00	515	08.0630.14	57	08.8160.67.OD	397	08.8380.30	173
07.9004.18	571	08.0254.00	515	08.0630.40	57	08.8160.67.OD	499	08.8410.00	378
07.9004.72	571	08.0255.00	515	08.0631.14	115	08.8160.68	397	08.8410.00	477
07.9005.01	571	08.0500.00	425	08.0631.40	115	08.8160.68	499	08.8411.00	378
07.9005.04	571	08.0501.00	425	08.0632.14	115	08.8160.69	397	08.8411.00	477
07.9005.18	571	08.0505.00	425	08.0632.40	115	08.8160.69	499	08.8412.14	365
07.9005.72	571	08.0506.14	425	08.0640.02	540	08.8160.98.OD	397	08.8412.14	371
07.9006.01C	570	08.0506.40	425	08.0640.14	540	08.8160.98.OD	499	08.8413.00	390
07.9006.04C	570	08.0506.CE	425	08.0640.40	540	08.8160.CL	397	08.8414.00	390
07.9006.18C	570	08.0506.TK	425	08.0641.02	540	08.8160.CL	499	08.8415.00	390
07.9006.72C	570	08.0507.14	425	08.0641.14	540	08.8160.DL	397	08.8418.68A	105
07.9007.01B	570	08.0507.40	425	08.0641.40	540	08.8160.DL	499	08.8418.68A	126
07.9007.04B	570	08.0507.CE	425	08.0642.02	541	08.8160.ND	397	08.8418.68A	405
07.9007.18B	570	08.0507.TK	425	08.0642.14	541	08.8160.ND	499	08.8419.14A	105
07.9007.72B	570	08.0510.00	217	08.0642.40	541	08.8163.68	378	08.8419.14A	126
07.9630.18	551	08.0511.00	217	08.3309.14	173	08.8163.68	397	08.8419.14A	405
07.9630.70	550	08.0512.00	217	08.3310.19	173	08.8163.68	477	08.8420.00	352
07.9630.76	551	08.0513.00	217	08.8012.00	571	08.8163.68	499	08.8421.00	352
07.9630.7C	551	08.0515.00	217	08.8025.08	439	08.8166.14	397	08.8422.00	563
07.9630.AN	550	08.0516.00	217	08.8025.14	439	08.8166.14	499	08.8423.00	565
07.9630.AP	550	08.0517.00	217	08.8025.20	439	08.8169.14	397	08.8427.14	95
07.9630.CE	551	08.0518.00	217	08.8027.08.AC	439	08.8169.14	499	08.8428.00	27
07.9641.14A	550	08.0520.02	540	08.8027.08.AM	439	08.8175.68	378	08.8428.00	126
07.9641.14ADA	550	08.0520.14	540	08.8027.08.AO	439	08.8175.68	397	08.8428.00	141
07.9641.14ADP	550	08.0520.40	540	08.8027.08.CL	439	08.8175.68	477	08.8428.00	150
07.9642.14A	550	08.0521.02	540	08.8027.08.DL	439	08.8175.68	499	08.8428.00	378
07.9642.14ADA	550	08.0521.14	540	08.8027.08.HL	439	08.8180.08	439	08.8428.00	426
07.9642.14ADP	550	08.0521.40	540	08.8027.08.IR	439	08.8180.14	439	08.8428.00	477
08.0030	161	08.0522.02	540	08.8027.08.ND	439	08.8180.20	439	08.8428.00	519
08.0031.00	161	08.0522.14	540	08.8027.08.RO	439	08.8182.14	173	08.8429.00	27
08.0031.00.DA	161	08.0522.40	540	08.8027.08.UV	439	08.8186.14	499	08.8429.00	126
08.0032.00	16	08.0523.02	540	08.8027.14.AC	439	08.8187.00	431	08.8429.00	141
08.0033.00	16	08.0523.14	540	08.8027.14.AM	439	08.8188.00	431	08.8429.00	150
08.0050.00	105	08.0523.40	540	08.8027.14.AO	439	08.8191.00	431	08.8429.00	378
08.0050.00	126	08.0524.02	541	08.8027.14.CL	439	08.8192.00	431	08.8429.00	426
08.0050.00	405	08.0524.14	541	08.8027.14.DL	439	08.8196.14	431	08.8429.00	477
08.0052.90	217	08.0524.40	541	08.8027.14.HL	439	08.8196.14	535	08.8429.00	519
08.0059.90	217	08.0525.02	541	08.8027.14.IR	439	08.8222.30A	371	08.8431.00	27
08.0109.00	161	08.0525.14	541	08.8027.14.ND	439	08.8229.30A	371	08.8431.00	126
08.0110.00	161	08.0525.40	541	08.8027.14.RO	439	08.8230.64.OD	173	08.8431.00	141
08.0111.00	161	08.0526.00	27	08.8027.14.UV	439	08.8230.65.OD	173	08.8431.00	150
08.0112.00	161	08.0526.00	126	08.8027.20.AC	439	08.8230.66.OD	173	08.8431.00	378
08.0113.00	161	08.0526.00	141	08.8027.20.AM	439	08.8230.67.OD	173	08.8431.00	426
08.0114.00	161	08.0526.00	150	08.8027.20.AO	439	08.8230.69	173	08.8431.00	477
08.0132.00	352	08.0526.00	378	08.8027.20.CL	439	08.8230.98.OD	173	08.8431.00	519
08.0160.14	233	08.0526.00	426	08.8027.20.DL	439	08.8230.CL	173	08.8432.00	27
08.0160.40	233	08.0526.00	477	08.8027.20.HL	439	08.8230.DL	173	08.8432.00	126
08.0161.14	233	08.0526.00	519	08.8027.20.IR	439	08.8230.ND	173	08.8432.00	141
08.0161.40	233	08.0526.40	27	08.8027.20.ND	439	08.8232.02	397	08.8432.00	150
08.0164.14	233	08.0526.40	126	08.8027.20.RO	439	08.8232.02	499	08.8432.00	378
08.0164.40	233	08.0526.40	141	08.8027.20.UV	439	08.8232.14	397	08.8432.00	426
08.0165.14	233	08.0526.40	150	08.8029.08	439	08.8232.14	499	08.8432.00	477

QUICK SEARCH OF PRODUCT

Ref.	Page	Ref.	Page	Ref.	Page	Ref.	Page	Ref.	Page
08.8432.00	519	08.8707.30	170	08.9055.NS	161	09.1600.02	396	09.2150.30A	504
08.8439.14	132	08.8708.14	170	08.9056.02	161	09.1600.14	396	09.2151.05A	504
08.8450.00	391	08.8708.30	170	08.9056.40	161	09.1600.30	396	09.2151.14A	504
08.8451.00	391	08.8709.14	170	08.9056.NS	161	09.1630.02C	394	09.2151.30A	504
08.8452.00	391	08.8709.30	170	08.9057.02	161	09.1630.02C1V	394	09.2152.05A	504
08.8453.14	391	08.8710.14	170	08.9057.40	161	09.1630.02CDA	394	09.2152.14A	504
08.8453.40	391	08.8710.30	170	08.9057.NS	161	09.1630.14C	394	09.2152.30A	504
08.8479.00	352	08.8711.00	170	08.9058.02	161	09.1630.14C1V	394	09.2155.05A	505
08.8491.14	352	08.8720.14	170	08.9058.40	161	09.1630.14CDA	394	09.2155.14A	505
08.8491.30	352	08.8720.30	170	08.9058.NS	161	09.1630.30C	394	09.2155.30A	505
08.8491.BU	352	08.8721.14	170	08.9070.14	146	09.1630.30C1V	394	09.2156.05A	505
08.8491.GL	352	08.8721.30	170	08.9071.14	147	09.1630.30CDA	394	09.2156.14A	505
08.8495.14	378	08.8759.00	96	08.9071.40	147	09.1631.02C	394	09.2156.30A	505
08.8495.14	439	08.8760.00	96	08.9074.14	147	09.1631.02C1V	394	09.2157.05A	505
08.8495.14	477	08.8761.00	96	08.9102.00	352	09.1631.02CDA	394	09.2157.14A	505
08.8501.64.OD	173	08.8763.14	486	08.9102.00	423	09.1631.14C	394	09.2157.30A	505
08.8501.64.OD	505	08.8766.64.OD	486	08.9103.00	352	09.1631.14C1V	394	09.2160.05A	504
08.8501.65.OD	173	08.8766.65.OD	486	08.9103.00	423	09.1631.14CDA	394	09.2160.14A	504
08.8501.65.OD	505	08.8766.66.OD	486	08.9104.00	352	09.1631.30C	394	09.2160.30A	504
08.8501.66.OD	173	08.8766.67.OD	486	08.9105.00	423	09.1631.30C1V	394	09.2161.05A	504
08.8501.66.OD	505	08.8768.14	486	08.9107.00	141	09.1631.30CDA	394	09.2161.14A	504
08.8501.67.OD	173	08.8775.40	551	08.9107.00	477	09.1632.02C	394	09.2161.30A	504
08.8501.67.OD	505	08.8782.30	458	08.9107.00	519	09.1632.02C1V	394	09.2162.05A	504
08.8501.69	173	08.8783.06	458	08.9108.00	141	09.1632.02CDA	394	09.2162.14A	504
08.8501.69	505	08.8783.14	458	08.9108.00	477	09.1632.14C	394	09.2162.30A	504
08.8501.CL	173	08.8783.30	458	08.9108.00	519	09.1632.14C1V	394	09.2165.05A	505
08.8501.CL	505	08.8865.14A	86	08.9109.00	141	09.1632.14CDA	394	09.2165.14A	505
08.8501.DL	173	08.8866.14	86	08.9109.00	477	09.1632.30C	394	09.2165.30A	505
08.8501.DL	505	08.8866.14	111	08.9109.00	519	09.1632.30C1V	394	09.2166.05A	505
08.8501.ND	173	08.8866.14	146	08.9110.00	141	09.1632.30CDA	394	09.2166.14A	505
08.8501.ND	505	08.8867.14	86	08.9110.00	477	09.1635.02C	394	09.2166.30A	505
08.8502.14	173	08.8867.14	111	08.9110.00	519	09.1635.02C1V	394	09.2167.05A	505
08.8502.14	505	08.8867.14	146	08.9111.00	141	09.1635.02CDA	394	09.2167.14A	505
08.8503.64.OD	439	08.8883.14A	90	08.9111.00	477	09.1635.14C	394	09.2167.30A	505
08.8503.65.OD	439	08.8883.14A	113	08.9111.00	519	09.1635.14C1V	394	09.2400.02C	491
08.8503.66.OD	439	08.8883.14A	115	08.9114.00	352	09.1635.14CDA	394	09.2400.14C	491
08.8503.67.OD	439	08.8883.40A	90	09.0045.29B	555	09.1635.30C	394	09.2400.30C	491
08.8503.69	439	08.8883.40A	113	09.0045.30B	555	09.1635.30C1V	394	09.2401.02C	491
08.8503.CL	439	08.8883.40A	115	09.0045.BZB	555	09.1635.30CDA	394	09.2401.14C	491
08.8503.DL	439	08.8886.14	90	09.0100.29B	555	09.1636.02C	394	09.2401.30C	491
08.8503.ND	439	08.8886.14.DA	90	09.0100.30B	555	09.1636.02C1V	394	09.2402.02C	491
08.8512.00C	602	08.8886.40	90	09.0100.BZB	555	09.1636.02CDA	394	09.2402.14C	491
08.8513.00C	602	08.8886.40.DA	90	09.0101.29B	555	09.1636.14C	394	09.2402.30C	491
08.8523.00	438	08.8887.14A	87	09.0101.30B	555	09.1636.14C1V	394	09.2405.02B	493
08.8524.00	438	08.8887.14A	89	09.0101.BZB	555	09.1636.14CDA	394	09.2405.14B	493
08.8525.00	438	08.8887.40A	87	09.0102.29B	555	09.1636.30C	394	09.2405.30B	493
08.8526.00	438	08.8887.40A	89	09.0102.30B	555	09.1636.30C1V	394	09.2406.02B	493
08.8572.14C	236	08.8889.14	90	09.0102.BZB	555	09.1636.30CDA	394	09.2406.14B	493
08.8572.14C	237	08.8889.14	113	09.0103.29B	555	09.1637.02C	394	09.2406.30B	493
08.8572.14C1V	236	08.8889.14	115	09.0103.30B	555	09.1637.02C1V	394	09.2407.02B	493
08.8572.14C1V	237	08.8889.40	90	09.0103.BZB	555	09.1637.02CDA	394	09.2407.14B	493
08.8572.14CDA	236	08.8889.40	113	09.0104.29A	555	09.1637.14C	394	09.2407.30B	493
08.8572.14CDA	237	08.8889.40	115	09.0104.30A	555	09.1637.14C1V	394	09.2410.02C	491
08.8573.14C	236	08.8914.40	176	09.0104.BZA	555	09.1637.14CDA	394	09.2410.14C	491
08.8573.14C	237	08.8915.00	177	09.0120.29B	555	09.1637.30C	394	09.2410.30C	491
08.8573.14C1V	236	08.8930.68	403	09.0120.30B	555	09.1637.30C1V	394	09.2411.02C	491
08.8573.14C1V	237	08.8931.68	403	09.0120.BZB	555	09.1637.30CDA	394	09.2411.14C	491
08.8573.14CDA	236	08.8932.64.OD	403	09.0203.14	172	09.1640.02B	395	09.2411.30C	491
08.8573.14CDA	237	08.8932.65.OD	403	09.0203.30	172	09.1640.14B	395	09.2412.02C	491
08.8590.06A	606	08.8932.66.OD	403	09.0211.14A	171	09.1640.30B	395	09.2412.14C	491
08.8590.40A	606	08.8932.67.OD	403	09.0211.30A	171	09.1641.02B	395	09.2412.30C	491
08.8590.AAA	606	08.8932.69	403	09.0212.14A	171	09.1641.14B	395	09.2415.02B	493
08.8591.06A	606	08.8932.98.OD	403	09.0212.30A	171	09.1641.30B	395	09.2415.14B	493
08.8591.40A	606	08.8932.CL	403	09.0213.14A	171	09.1642.02B	395	09.2415.30B	493
08.8591.AAA	606	08.8932.DL	403	09.0213.30A	171	09.1642.14B	395	09.2416.02B	493
08.8595.06A	606	08.8932.ND	403	09.0217.14A	171	09.1642.30B	395	09.2416.14B	493
08.8595.40A	606	08.8933.68	403	09.0217.30A	171	09.1645.02B	395	09.2416.30B	493
08.8595.AAA	606	08.8974.00	357	09.0218.14A	171	09.1645.14B	395	09.2417.02B	493
08.8596.06A	606	08.8975.00	357	09.0218.30A	171	09.1645.30B	395	09.2417.14B	493
08.8596.40A	606	08.8976.14	357	09.0219.14A	171	09.1646.02B	395	09.2417.30B	493
08.8596.AAA	606	08.8977.00	357	09.0219.30A	171	09.1646.14B	395	09.2420.02C	495
08.8627.68	173	08.8978.00	357	09.0220.14A	172	09.1646.30B	395	09.2420.14C	495
08.8634.00	113	08.8979.00	357	09.0220.30A	172	09.1647.02B	395	09.2420.30C	495
08.8634.00	115	08.8980.14	357	09.0221.14A	172	09.1647.14B	395	09.2421.02C	495
08.8662.14C	236	08.8994.14	378	09.0221.30A	172	09.1647.30B	395	09.2421.14C	495
08.8662.14C	237	08.8994.30	378	09.0230.14	172	09.2110.05C	553	09.2421.30C	495
08.8662.14C1V	236	08.8995.14	378	09.0230.30	172	09.2110.05CDA	553	09.2422.02C	495
08.8662.14C1V	237	08.8995.30	378	09.0231.14	172	09.2110.14C	553	09.2422.14C	495
08.8662.14CDA	236	08.9050.02	161	09.0231.30	172	09.2110.14CDA	553	09.2422.30C	495
08.8662.14CDA	237	08.9050.40	161	09.0232.14	172	09.2110.40C	553	09.2425.02B	497
08.8663.14C	236	08.9050.NS	161	09.0232.30	172	09.2110.40CDA	553	09.2425.14B	497
08.8663.14C	237	08.9051.02	161	09.0233.14	172	09.2112.05C	553	09.2425.30B	497
08.8663.14C1V	236	08.9051.40	161	09.0233.30	172	09.2112.05CDA	553	09.2426.02B	497
08.8663.14C1V	237	08.9051.NS	161	09.0360.14	171	09.2112.14C	553	09.2426.14B	497
08.8663.14CDA	236	08.9052.02	161	09.0360.30	171	09.2112.14CDA	553	09.2426.30B	497
08.8663.14CDA	237	08.9052.40	161	09.0361.14	171	09.2112.40C	553	09.2427.02B	497
08.8701.14	170	08.9052.NS	161	09.0361.30	171	09.2112.40CDA	553	09.2427.14B	497
08.8701.30	170	08.9053.02	161	09.0362.14	171	09.2125.05B	553	09.2427.30B	497
08.8702.14	170	08.9053.40	161	09.0362.30	171	09.2125.14B	553	09.2430.02C	495
08.8702.30	170	08.9053.NS	161	09.0365.14	171	09.2125.40B	553	09.2430.14C	495
08.8705.14	170	08.9054.02	161	09.0365.30	171	09.2127.05B	553	09.2430.30C	495
08.8705.30	170	08.9054.40	161	09.0366.14	171	09.2127.14B	553	09.2431.02C	495
08.8706.14	170	08.9054.NS	161	09.0366.30	171	09.2127.40B	553	09.2431.14C	495
08.8706.30	170	08.9055.02	161	09.0367.14	171	09.2150.05A	504	09.2431.30C	495
08.8707.14	170	08.9055.40	161	09.0367.30	171	09.2150.14A	504	09.2432.02C	495

QUICK SEARCH OF PRODUCT

Ref.	Page	Ref.	Page	Ref.	Page	Ref.	Page	Ref.	Page
09.2432.14C	495	09.2580.02A	494	09.2887.30.DA	482	09.2964.30	485	09.3751.14A	456
09.2432.30C	495	09.2580.14A	494	09.2888.14	480	09.2964.30.DA	485	09.3751.30A	456
09.2435.02B	497	09.2580.30A	494	09.2888.14.DA	480	09.2991.14	482	09.3755.06A	456
09.2435.14B	497	09.2581.02A	494	09.2888.30	480	09.2991.14.DA	482	09.3755.14A	456
09.2435.30B	497	09.2581.14A	494	09.2888.30.DA	480	09.2991.30	482	09.3755.30A	456
09.2436.02B	497	09.2581.30A	494	09.2889.14	480	09.2991.30.DA	482	09.3756.06A	456
09.2436.14B	497	09.2585.02A	495	09.2889.14.DA	480	09.2992.14	482	09.3756.14A	456
09.2436.30B	497	09.2585.14A	495	09.2889.30	480	09.2992.14.DA	482	09.3756.30A	456
09.2437.02B	497	09.2585.30A	495	09.2889.30.DA	480	09.2992.30	482	09.3780.06A	456
09.2437.14B	497	09.2586.02A	495	09.2890.14	480	09.2992.30.DA	482	09.3780.14A	456
09.2437.30B	497	09.2586.14A	495	09.2890.14.DA	480	09.2993.14	482	09.3780.30A	456
09.2450.02C	492	09.2586.30A	495	09.2890.30	480	09.2993.14.DA	482	09.3781.06A	456
09.2450.14C	492	09.2865.14	485	09.2890.30.DA	480	09.2993.30	482	09.3781.14A	456
09.2450.30C	492	09.2865.14.DA	485	09.2891.14	483	09.2993.30.DA	482	09.3781.30A	456
09.2451.02C	492	09.2865.30	485	09.2891.14.DA	483	09.2994.14	483	09.3800.06A	58
09.2451.14C	492	09.2865.30.DA	485	09.2891.30	483	09.2994.14.DA	483	09.3800.14A	58
09.2451.30C	492	09.2866.14	485	09.2891.30.DA	483	09.2994.30	483	09.3800.18A	58
09.2452.02C	492	09.2866.14.DA	485	09.2892.14	483	09.2994.30.DA	483	09.3800.40A	58
09.2452.14C	492	09.2866.30	485	09.2892.14.DA	483	09.2995.14	483	09.3800.CZA	58
09.2452.30C	492	09.2866.30.DA	485	09.2892.30	483	09.2995.14.DA	483	09.3801.06A	58
09.2455.02B	494	09.2867.14	485	09.2892.30.DA	483	09.2995.30	483	09.3801.14A	58
09.2455.14B	494	09.2867.14.DA	485	09.2893.14	483	09.2995.30.DA	483	09.3801.18A	58
09.2455.30B	494	09.2867.30	485	09.2893.14.DA	483	09.2996.14	483	09.3801.40A	58
09.2456.02B	494	09.2867.30.DA	485	09.2893.30	483	09.2996.14.DA	483	09.3801.CZA	58
09.2456.14B	494	09.2870.14	480	09.2893.30.DA	483	09.2996.30	483	09.3802.06A	58
09.2456.30B	494	09.2870.14.DA	480	09.2894.14	481	09.2996.30.DA	483	09.3802.14A	58
09.2457.02B	494	09.2870.30	480	09.2894.14.DA	481	09.2997.14	482	09.3802.18A	58
09.2457.14B	494	09.2870.30.DA	480	09.2894.30	481	09.2997.14.DA	482	09.3802.40A	58
09.2457.30B	494	09.2871.14	480	09.2894.30.DA	481	09.2997.30	482	09.3802.CZA	58
09.2460.02C	492	09.2871.14.DA	480	09.2895.14	481	09.2997.30.DA	482	09.3803.06A	58
09.2460.14C	492	09.2871.30	480	09.2895.14.DA	481	09.2998.14	482	09.3803.14A	58
09.2460.30C	492	09.2871.30.DA	480	09.2895.30	481	09.2998.14.DA	482	09.3803.18A	58
09.2461.02C	492	09.2872.14	480	09.2895.30.DA	481	09.2998.30	482	09.3803.40A	58
09.2461.14C	492	09.2872.14.DA	480	09.2896.14	481	09.2998.30.DA	482	09.3803.CZA	58
09.2461.30C	492	09.2872.30	480	09.2896.14.DA	481	09.2999.14	482	09.3810.06A	59
09.2462.02C	492	09.2872.30.DA	480	09.2896.30	481	09.2999.14.DA	482	09.3810.14A	59
09.2462.14C	492	09.2873.14	483	09.2896.30.DA	481	09.2999.30	482	09.3810.18A	59
09.2462.30C	492	09.2873.14.DA	483	09.2897.14	484	09.2999.30.DA	482	09.3810.40A	59
09.2465.02B	494	09.2873.30	483	09.2897.14.DA	484	09.3000.01C	567	09.3810.CZA	59
09.2465.14B	494	09.2873.30.DA	483	09.2897.30	484	09.3000.04C	567	09.3811.06A	59
09.2465.30B	494	09.2874.14	483	09.2897.30.DA	484	09.3000.18C	567	09.3811.14A	59
09.2466.02B	494	09.2874.14.DA	483	09.2898.14	484	09.3000.72C	567	09.3811.18A	59
09.2466.14B	494	09.2874.30	483	09.2898.14.DA	484	09.3001.01B	567	09.3811.40A	59
09.2466.30B	494	09.2874.30.DA	483	09.2898.30	484	09.3001.04B	567	09.3811.CZA	59
09.2467.02B	494	09.2875.14	483	09.2898.30.DA	484	09.3001.18B	567	09.3812.06A	59
09.2467.14B	494	09.2875.14.DA	483	09.2899.14	484	09.3001.72B	567	09.3812.14A	59
09.2467.30B	494	09.2875.30	483	09.2899.14.DA	484	09.3100.14A	414	09.3812.18A	59
09.2470.02C	496	09.2875.30.DA	483	09.2899.30	484	09.3100.30A	414	09.3812.40A	59
09.2470.14C	496	09.2876.14	481	09.2899.30.DA	484	09.3101.14A	414	09.3812.CZA	59
09.2470.30C	496	09.2876.14.DA	481	09.2953.14	480	09.3101.30A	414	09.3813.06A	59
09.2471.02C	496	09.2876.30	481	09.2953.14.DA	480	09.3105.14A	415	09.3813.14A	59
09.2471.14C	496	09.2876.30.DA	481	09.2953.30	480	09.3105.30A	415	09.3813.18A	59
09.2471.30C	496	09.2877.14	481	09.2953.30.DA	480	09.3106.14A	415	09.3813.40A	59
09.2472.02C	496	09.2877.14.DA	481	09.2954.14	480	09.3106.30A	415	09.3813.CZA	59
09.2472.14C	496	09.2877.30	481	09.2954.14.DA	480	09.3110.14A	414	09.3820.06A	61
09.2472.30C	496	09.2877.30.DA	481	09.2954.30	480	09.3110.30A	414	09.3820.14A	61
09.2475.02B	498	09.2878.14	481	09.2954.30.DA	480	09.3111.14A	414	09.3820.18A	61
09.2475.14B	498	09.2878.14.DA	481	09.2955.14	480	09.3111.30A	414	09.3820.40A	61
09.2475.30B	498	09.2878.30	481	09.2955.14.DA	480	09.3115.14A	415	09.3820.CZA	61
09.2476.02B	498	09.2878.30.DA	481	09.2955.30	480	09.3115.30A	415	09.3821.06A	61
09.2476.14B	498	09.2879.14	484	09.2955.30.DA	480	09.3116.14A	415	09.3821.14A	61
09.2476.30B	498	09.2879.14.DA	484	09.2956.14	481	09.3116.30A	415	09.3821.18A	61
09.2477.02B	498	09.2879.30	484	09.2956.14.DA	481	09.3200.29A	563	09.3821.40A	61
09.2477.14B	498	09.2879.30.DA	484	09.2956.30	481	09.3200.30A	563	09.3821.CZA	61
09.2477.30B	498	09.2880.14	484	09.2956.30.DA	481	09.3200.55A	563	09.3822.06A	61
09.2480.02C	496	09.2880.14.DA	484	09.2957.14	481	09.3200.ANA	563	09.3822.14A	61
09.2480.14C	496	09.2880.30	484	09.2957.14.DA	481	09.3200.BZA	563	09.3822.18A	61
09.2480.30C	496	09.2880.30.DA	484	09.2957.30	481	09.3201.29A	563	09.3822.40A	61
09.2481.02C	496	09.2881.14	484	09.2957.30.DA	481	09.3201.30A	563	09.3822.CZA	61
09.2481.14C	496	09.2881.14.DA	484	09.2958.14	481	09.3201.55A	563	09.3823.06A	61
09.2481.30C	496	09.2881.30	484	09.2958.14.DA	481	09.3201.ANA	563	09.3823.14A	61
09.2482.02C	496	09.2881.30.DA	484	09.2958.30	481	09.3201.BZA	563	09.3823.18A	61
09.2482.14C	496	09.2882.14	485	09.2958.30.DA	481	09.3310.01C	565	09.3823.40A	61
09.2482.30C	496	09.2882.14.DA	485	09.2959.14	484	09.3310.04C	565	09.3823.CZA	61
09.2485.02B	498	09.2882.30	485	09.2959.14.DA	484	09.3310.72C	565	09.3830.06A	62
09.2485.14B	498	09.2882.30.DA	485	09.2959.30	484	09.3705.14C	457	09.3830.14A	46
09.2485.30B	498	09.2883.14	485	09.2959.30.DA	484	09.3705.30C	457	09.3830.14A	62
09.2486.02B	498	09.2883.14.DA	485	09.2960.14	484	09.3706.14C	457	09.3830.18A	62
09.2486.14B	498	09.2883.30	485	09.2960.14.DA	484	09.3706.30C	457	09.3830.1AA	46
09.2486.30B	498	09.2883.30.DA	485	09.2960.30	484	09.3707.06	457	09.3830.40A	46
09.2487.02B	498	09.2884.14	485	09.2960.30.DA	484	09.3707.14	457	09.3830.40A	62
09.2487.14B	498	09.2884.14.DA	485	09.2961.14	484	09.3707.30	457	09.3830.CZA	46
09.2487.30B	498	09.2884.30	485	09.2961.14.DA	484	09.3708.06A	457	09.3830.CZA	62
09.2570.02A	490	09.2884.30.DA	485	09.2961.30	484	09.3708.14A	457	09.3831.06A	62
09.2570.14A	490	09.2885.14	482	09.2961.30.DA	484	09.3708.30A	457	09.3831.14A	46
09.2570.30A	490	09.2885.14.DA	482	09.2962.14	485	09.3710.06C	458	09.3831.14A	62
09.2571.02A	490	09.2885.30	482	09.2962.14.DA	485	09.3710.14C	458	09.3831.18A	62
09.2571.14A	490	09.2885.30.DA	482	09.2962.30	485	09.3710.30C	458	09.3831.1AA	46
09.2571.30A	490	09.2886.14	482	09.2962.30.DA	485	09.3711.06C	458	09.3831.40A	46
09.2575.02A	490	09.2886.14.DA	482	09.2963.14	485	09.3711.14C	458	09.3831.40A	62
09.2575.14A	490	09.2886.30	482	09.2963.14.DA	485	09.3711.30C	458	09.3831.CZA	46
09.2575.30A	490	09.2886.30.DA	482	09.2963.30	485	09.3750.06A	456	09.3831.CZA	62
09.2576.02A	490	09.2887.14	482	09.2963.30.DA	485	09.3750.14A	456	09.3832.06A	62
09.2576.14A	490	09.2887.14.DA	482	09.2964.14	485	09.3750.30A	456	09.3832.14A	46
09.2576.30A	490	09.2887.30	482	09.2964.14.DA	485	09.3751.06A	456	09.3832.14A	62

QUICK SEARCH OF PRODUCT

Ref.	Page	Ref.	Page	Ref.	Page	Ref.	Page	Ref.	Page
09.3832.18A	62	09.3900.CZA	58	09.3940.CZA	63	09.4264.30A	465	09.4471.14ADA	463
09.3832.1A	46	09.3901.06A	58	09.3941.06A	63	09.4264.30ADA	465	09.4471.30A	463
09.3832.40A	46	09.3901.14A	58	09.3941.14A	46	09.4265.14	465	09.4471.30ADA	463
09.3832.40A	62	09.3901.18A	58	09.3941.14A	63	09.4265.14.DA	465	09.4472.14A	463
09.3832.CZA	46	09.3901.40A	58	09.3941.18A	63	09.4265.30	465	09.4472.14ADA	463
09.3832.CZA	62	09.3901.CZA	58	09.3941.40A	46	09.4265.30.DA	465	09.4472.30A	463
09.3833.06A	62	09.3902.06A	58	09.3941.40A	63	09.4270.14	465	09.4472.30ADA	463
09.3833.14A	46	09.3902.14A	58	09.3941.CZA	46	09.4270.14.DA	465	09.4480.14A	470
09.3833.14A	62	09.3902.18A	58	09.3941.CZA	63	09.4270.30	465	09.4480.30A	470
09.3833.18A	62	09.3902.40A	58	09.3942.06A	63	09.4270.30.DA	465	09.4481.14A	470
09.3833.1A	46	09.3902.CZA	58	09.3942.14A	46	09.4271.14A	465	09.4481.30A	470
09.3833.40A	46	09.3903.06A	58	09.3942.14A	63	09.4271.14ADA	465	09.4482.14A	470
09.3833.40A	62	09.3903.14A	58	09.3942.18A	63	09.4271.30A	465	09.4482.30A	470
09.3833.CZA	46	09.3903.18A	58	09.3942.40A	46	09.4271.30ADA	465	09.4483.14A	470
09.3840.06A	63	09.3903.40A	58	09.3942.40A	63	09.4272.14	465	09.4483.30A	470
09.3840.14A	46	09.3903.CZA	58	09.3942.CZA	46	09.4272.14.DA	465	09.4484.14A	470
09.3840.14A	63	09.3910.06A	59	09.3942.CZA	63	09.4272.30	465	09.4484.30A	470
09.3840.18A	63	09.3910.14A	59	09.3943.06A	63	09.4272.30.DA	465	09.4485.14A	470
09.3840.1A	46	09.3910.18A	59	09.3943.14A	46	09.4281.14	472	09.4485.30A	470
09.3840.40A	46	09.3910.40A	59	09.3943.14A	63	09.4281.30	472	09.4486.14A	470
09.3840.40A	63	09.3910.CZA	59	09.3943.18A	63	09.4283.14A	472	09.4486.30A	470
09.3840.CZA	46	09.3911.06A	59	09.3943.40A	46	09.4283.30A	472	09.4487.14A	470
09.3840.CZA	63	09.3911.14A	59	09.3943.40A	63	09.4285.14	472	09.4487.30A	470
09.3841.06A	63	09.3911.18A	59	09.3943.CZA	46	09.4285.30	472	09.4488.14A	470
09.3841.14A	46	09.3911.40A	59	09.3943.CZA	63	09.4286.14	472	09.4488.30A	470
09.3841.14A	63	09.3911.CZA	59	09.3950.06	63	09.4286.30	472	09.4510.14A	374
09.3841.18A	63	09.3912.06A	59	09.3950.14	63	09.4287.14A	472	09.4510.14ADA	374
09.3841.1A	46	09.3912.14A	59	09.3950.18	63	09.4287.30A	472	09.4510.30A	374
09.3841.40A	46	09.3912.18A	59	09.3950.40	63	09.4288.14	472	09.4510.30ADA	374
09.3841.40A	63	09.3912.40A	59	09.3950.CZ	63	09.4288.30	472	09.4511.14A	374
09.3841.40A	63	09.3912.CZA	59	09.3951.06	63	09.4440.14A	470	09.4511.14ADA	374
09.3841.CZA	46	09.3913.06A	59	09.3951.14	63	09.4440.14ADA	470	09.4511.30A	374
09.3841.CZA	63	09.3913.14A	59	09.3951.18	63	09.4440.30A	470	09.4511.30ADA	374
09.3842.06A	63	09.3913.18A	59	09.3951.40	63	09.4440.30ADA	470	09.4512.14A	374
09.3842.14A	46	09.3913.40A	59	09.3951.CZ	63	09.4441.14A	470	09.4512.14ADA	374
09.3842.14A	63	09.3913.CZA	59	09.3960.06A	60	09.4441.14ADA	470	09.4512.30A	374
09.3842.18A	63	09.3920.06A	61	09.3960.14A	60	09.4441.30A	470	09.4512.30ADA	374
09.3842.1A	46	09.3920.14A	61	09.3960.18A	60	09.4441.30ADA	470	09.4513.14A	374
09.3842.40A	46	09.3920.18A	61	09.3960.40A	60	09.4442.14A	470	09.4513.14ADA	374
09.3842.40A	63	09.3920.40A	61	09.3960.CZA	60	09.4442.14ADA	470	09.4513.30A	374
09.3842.CZA	46	09.3920.CZA	61	09.3961.06A	60	09.4442.30A	470	09.4513.30ADA	374
09.3842.CZA	63	09.3921.06A	61	09.3961.14A	60	09.4442.30ADA	470	09.4514.14A	374
09.3843.06A	63	09.3921.14A	61	09.3961.18A	60	09.4443.14A	470	09.4514.14ADA	374
09.3843.14A	46	09.3921.18A	61	09.3961.40A	60	09.4443.14ADA	470	09.4514.30A	374
09.3843.14A	63	09.3921.40A	61	09.3961.CZA	60	09.4443.30A	470	09.4514.30ADA	374
09.3843.18A	63	09.3921.CZA	61	09.3962.06A	60	09.4443.30ADA	470	09.4515.14A	374
09.3843.1A	46	09.3922.06A	61	09.3962.14A	60	09.4444.14A	470	09.4515.14ADA	374
09.3843.40A	46	09.3922.14A	61	09.3962.18A	60	09.4444.14ADA	470	09.4515.30A	374
09.3843.40A	63	09.3922.18A	61	09.3962.40A	60	09.4444.30A	470	09.4515.30ADA	374
09.3843.CZA	46	09.3922.40A	61	09.3962.CZA	60	09.4444.30ADA	470	09.4516.14A	374
09.3843.CZA	63	09.3922.CZA	61	09.3963.06A	60	09.4445.14A	470	09.4516.14ADA	374
09.3850.06	63	09.3923.06A	61	09.3963.14A	60	09.4445.14ADA	470	09.4516.30A	374
09.3850.14	63	09.3923.14A	61	09.3963.18A	60	09.4445.30A	470	09.4516.30ADA	374
09.3850.18	63	09.3923.18A	61	09.3963.40A	60	09.4445.30ADA	470	09.4517.14A	374
09.3850.40	63	09.3923.40A	61	09.3963.CZA	60	09.4450.14A	470	09.4517.14ADA	374
09.3850.CZ	63	09.3923.CZA	61	09.3964.06A	60	09.4450.14ADA	470	09.4517.30A	374
09.3851.06	63	09.3930.06A	62	09.3964.14A	60	09.4450.30A	470	09.4517.30ADA	374
09.3851.14	63	09.3930.14A	46	09.3964.18A	60	09.4450.30ADA	470	09.4518.14A	374
09.3851.18	63	09.3930.14A	62	09.3964.40A	60	09.4451.14A	470	09.4518.14ADA	374
09.3851.40	63	09.3930.18A	62	09.3964.CZA	60	09.4451.14ADA	470	09.4518.30A	374
09.3851.CZ	63	09.3930.40A	46	09.3965.06A	60	09.4451.30A	470	09.4518.30ADA	374
09.3860.06A	60	09.3930.40A	62	09.3965.14A	60	09.4451.30ADA	470	09.4519.14A	375
09.3860.14A	60	09.3930.CZA	46	09.3965.18A	60	09.4452.14A	470	09.4519.14ADA	375
09.3860.18A	60	09.3930.CZA	62	09.3965.40A	60	09.4452.14ADA	470	09.4519.30A	375
09.3860.40A	60	09.3931.06A	62	09.3965.CZA	60	09.4452.30A	470	09.4519.30ADA	375
09.3860.CZA	60	09.3931.14A	46	09.4243.14	472	09.4452.30ADA	470	09.4520.14A	375
09.3861.06A	60	09.3931.14A	62	09.4243.14.DA	472	09.4460.14A	463	09.4520.14ADA	375
09.3861.14A	60	09.3931.18A	62	09.4243.30	472	09.4460.14ADA	463	09.4520.30A	375
09.3861.18A	60	09.3931.40A	46	09.4243.30.DA	472	09.4460.30A	463	09.4520.30ADA	375
09.3861.40A	60	09.3931.40A	62	09.4244.14A	472	09.4460.30ADA	463	09.4521.14A	375
09.3861.CZA	60	09.3931.CZA	46	09.4244.14ADA	472	09.4461.14A	463	09.4521.14ADA	375
09.3862.06A	60	09.3931.CZA	62	09.4244.30A	472	09.4461.14ADA	463	09.4521.30A	375
09.3862.14A	60	09.3932.06A	62	09.4244.30ADA	472	09.4461.30A	463	09.4521.30ADA	375
09.3862.18A	60	09.3932.14A	46	09.4245.14	472	09.4461.30ADA	463	09.4522.14A	375
09.3862.40A	60	09.3932.14A	62	09.4245.14.DA	472	09.4462.14A	463	09.4522.14ADA	375
09.3862.CZA	60	09.3932.18A	62	09.4245.30	472	09.4462.14ADA	463	09.4522.30A	375
09.3863.06A	60	09.3932.40A	46	09.4245.30.DA	472	09.4462.30A	463	09.4522.30ADA	375
09.3863.14A	60	09.3932.40A	62	09.4250.14	472	09.4462.30ADA	463	09.4523.14A	375
09.3863.18A	60	09.3932.CZA	46	09.4250.14.DA	472	09.4463.14A	463	09.4523.14ADA	375
09.3863.40A	60	09.3932.CZA	62	09.4250.30	472	09.4463.14ADA	463	09.4523.30A	375
09.3863.CZA	60	09.3933.06A	62	09.4250.30.DA	472	09.4463.30A	463	09.4523.30ADA	375
09.3864.06A	60	09.3933.14A	46	09.4251.14A	472	09.4463.30ADA	463	09.4524.14A	375
09.3864.14A	60	09.3933.14A	62	09.4251.14ADA	472	09.4464.14A	463	09.4524.14ADA	375
09.3864.18A	60	09.3933.18A	62	09.4251.30A	472	09.4464.14ADA	463	09.4524.30A	375
09.3864.40A	60	09.3933.40A	46	09.4251.30ADA	472	09.4464.30A	463	09.4524.30ADA	375
09.3864.CZA	60	09.3933.40A	62	09.4252.14	472	09.4464.30ADA	463	09.4525.14A	375
09.3865.06A	60	09.3933.CZA	46	09.4252.14.DA	472	09.4465.14A	463	09.4525.14ADA	375
09.3865.14A	60	09.3933.CZA	62	09.4252.30	472	09.4465.14ADA	463	09.4525.30A	375
09.3865.18A	60	09.3940.06A	63	09.4252.30.DA	472	09.4465.30A	463	09.4525.30ADA	375
09.3865.40A	60	09.3940.14A	46	09.4263.14	465	09.4465.30ADA	463	09.4526.14A	375
09.3865.CZA	60	09.3940.14A	63	09.4263.14.DA	465	09.4470.14A	463	09.4526.14ADA	375
09.3900.06A	58	09.3940.18A	63	09.4263.30	465	09.4470.14ADA	463	09.4526.30A	375
09.3900.14A	58	09.3940.40A	46	09.4263.30.DA	465	09.4470.30A	463	09.4526.30ADA	375
09.3900.18A	58	09.3940.40A	63	09.4264.14A	465	09.4470.30ADA	463	09.4527.14A	375
09.3900.40A	58	09.3940.CZA	46	09.4264.14ADA	465	09.4471.14A	463	09.4527.14ADA	375

QUICK SEARCH OF PRODUCT

Ref.	Page	Ref.	Page	Ref.	Page	Ref.	Page	Ref.	Page
09.4527.30A	375	09.4910.30ADA	376	09.4982.14	473	09.6020.02BDA	546	09.7277.40A	474
09.4527.30ADA	375	09.4911.14A	376	09.4982.14.DA	473	09.6020.14B	546	09.7277.40A78	138
09.4840.14A	471	09.4911.14ADA	376	09.4982.30	473	09.6020.14BDA	546	09.7277.40A78	474
09.4840.14ADA	471	09.4911.30A	376	09.4982.30.DA	473	09.6020.30B	546	09.7278.14A	138
09.4840.30A	471	09.4911.30ADA	376	09.4983.14	473	09.6020.30BDA	546	09.7278.14A	474
09.4840.30ADA	471	09.4912.14A	376	09.4983.30	473	09.6021.02B	546	09.7278.40A	138
09.4841.14A	471	09.4912.14ADA	376	09.4984.14	473	09.6021.02BDA	546	09.7278.40A	474
09.4841.14ADA	471	09.4912.30A	376	09.4984.30	473	09.6021.14B	546	09.7278.40A78	138
09.4841.30A	471	09.4912.30ADA	376	09.4985.14	473	09.6021.14BDA	546	09.7278.40A78	474
09.4841.30ADA	471	09.4913.14A	376	09.4985.30	473	09.6021.30B	546	09.7290.14A	517
09.4842.14A	471	09.4913.14ADA	376	09.5010.02B	543	09.6021.30BDA	546	09.7290.40A	517
09.4842.14ADA	471	09.4913.30A	376	09.5010.02BDA	543	09.6040.02B	547	09.7291.14A	517
09.4842.30A	471	09.4913.30ADA	376	09.5010.14B	543	09.6040.02BDA	547	09.7291.40A	517
09.4842.30ADA	471	09.4914.14A	376	09.5010.14BDA	543	09.6040.14B	547	09.7292.14A	517
09.4843.14A	471	09.4914.14ADA	376	09.5010.30B	543	09.6040.14BDA	547	09.7292.40A	517
09.4843.14ADA	471	09.4914.30A	376	09.5010.30BDA	543	09.6040.30B	547	09.7293.14A	517
09.4843.30A	471	09.4914.30ADA	376	09.5011.02B	543	09.6040.30BDA	547	09.7293.40A	517
09.4843.30ADA	471	09.4915.14A	376	09.5011.02BDA	543	09.6041.02B	547	09.7294.14A	517
09.4844.14A	471	09.4915.14ADA	376	09.5011.14B	543	09.6041.02BDA	547	09.7294.40A	517
09.4844.14ADA	471	09.4915.30A	376	09.5011.14BDA	543	09.6041.14B	547	09.7295.14A	517
09.4844.30A	471	09.4915.30ADA	376	09.5011.30B	543	09.6041.14BDA	547	09.7295.40A	517
09.4844.30ADA	471	09.4916.14A	376	09.5011.30BDA	543	09.6041.30B	547	09.7296.14A	517
09.4845.14A	471	09.4916.14ADA	376	09.5015.02B	543	09.6041.30BDA	547	09.7296.40A	517
09.4845.14ADA	471	09.4916.30A	376	09.5015.02BDA	543	09.7210.14A	135	09.7297.14A	517
09.4845.30A	471	09.4916.30ADA	376	09.5015.14B	543	09.7210.40A	135	09.7297.40A	517
09.4845.30ADA	471	09.4917.14A	376	09.5015.14BDA	543	09.7210.40A78	135	09.7298.14A	517
09.4850.14A	471	09.4917.14ADA	376	09.5015.30B	543	09.7211.14A	135	09.7298.40A	517
09.4850.14ADA	471	09.4917.30A	376	09.5015.30BDA	543	09.7211.40A	135	09.7300.14	136
09.4850.30A	471	09.4917.30ADA	376	09.5016.02B	543	09.7211.40A78	135	09.7300.40	136
09.4850.30ADA	471	09.4918.14A	376	09.5016.02BDA	543	09.7212.14A	135	09.7300.40.78	136
09.4851.14A	471	09.4918.14ADA	376	09.5016.14B	543	09.7212.40A	135	09.7301.14	136
09.4851.14ADA	471	09.4918.30A	376	09.5016.14BDA	543	09.7212.40A78	135	09.7301.40	136
09.4851.30A	471	09.4918.30ADA	376	09.5016.30B	543	09.7213.14A	135	09.7301.40.78	136
09.4851.30ADA	471	09.4919.14A	377	09.5016.30BDA	543	09.7213.40A	135	09.7302.14	136
09.4852.14A	471	09.4919.14ADA	377	09.5020.02B	544	09.7213.40A78	135	09.7302.40	136
09.4852.14ADA	471	09.4919.30A	377	09.5020.02BDA	544	09.7214.14A	135	09.7302.40.78	136
09.4852.30A	471	09.4919.30ADA	377	09.5020.14B	544	09.7214.40A	135	09.7303.14	136
09.4852.30ADA	471	09.4920.14A	377	09.5020.14BDA	544	09.7214.40A78	135	09.7303.40	136
09.4860.14A	464	09.4920.14ADA	377	09.5020.30B	544	09.7215.14A	135	09.7303.40.78	136
09.4860.14ADA	464	09.4920.30A	377	09.5020.30BDA	544	09.7215.40A	135	09.7304.14	136
09.4860.30A	464	09.4920.30ADA	377	09.5021.02B	544	09.7215.40A78	135	09.7304.40	136
09.4860.30ADA	464	09.4921.14A	377	09.5021.02BDA	544	09.7216.14A	135	09.7304.40.78	136
09.4861.14A	464	09.4921.14ADA	377	09.5021.14B	544	09.7216.40A	135	09.7305.14	136
09.4861.14ADA	464	09.4921.30A	377	09.5021.14BDA	544	09.7216.40A78	135	09.7305.40	136
09.4861.30A	464	09.4921.30ADA	377	09.5021.30B	544	09.7217.14A	135	09.7305.40.78	136
09.4861.30ADA	464	09.4922.14A	377	09.5021.30BDA	544	09.7217.40A	135	09.7306.14	136
09.4862.14A	464	09.4922.14ADA	377	09.5025.02B	544	09.7217.40A78	135	09.7306.40	136
09.4862.14ADA	464	09.4922.30A	377	09.5025.02BDA	544	09.7218.14A	135	09.7306.40.78	136
09.4862.30A	464	09.4922.30ADA	377	09.5025.14B	544	09.7218.40A	135	09.7307.14	136
09.4862.30ADA	464	09.4923.14A	377	09.5025.14BDA	544	09.7218.40A78	135	09.7307.40	136
09.4863.14A	464	09.4923.14ADA	377	09.5025.30B	544	09.7270.14A	138	09.7307.40.78	136
09.4863.14ADA	464	09.4923.30A	377	09.5025.30BDA	544	09.7270.14A	474	09.7308.14	136
09.4863.30A	464	09.4923.30ADA	377	09.5026.02B	544	09.7270.40A	138	09.7308.40	136
09.4863.30ADA	464	09.4924.14A	377	09.5026.02BDA	544	09.7270.40A	474	09.7308.40.78	136
09.4864.14A	464	09.4924.14ADA	377	09.5026.14B	544	09.7270.40A78	138	09.7310.14	139
09.4864.14ADA	464	09.4924.30A	377	09.5026.14BDA	544	09.7270.40A78	474	09.7310.14	475
09.4864.30A	464	09.4924.30ADA	377	09.5026.30B	544	09.7271.14A	138	09.7310.40	139
09.4864.30ADA	464	09.4925.14A	377	09.5026.30BDA	544	09.7271.40A	474	09.7310.40	475
09.4865.14A	464	09.4925.14ADA	377	09.5040.02B	545	09.7271.40A	138	09.7310.40.78	139
09.4865.14ADA	464	09.4925.30A	377	09.5040.02BDA	545	09.7271.40A	474	09.7310.40.78	475
09.4865.30A	464	09.4925.30ADA	377	09.5040.14B	545	09.7271.40A78	138	09.7311.14	139
09.4865.30ADA	464	09.4926.14A	377	09.5040.14BDA	545	09.7271.40A78	474	09.7311.14	475
09.4870.14A	464	09.4926.14ADA	377	09.5040.30B	545	09.7272.14A	138	09.7311.40	139
09.4870.14ADA	464	09.4926.30A	377	09.5040.30BDA	545	09.7272.14A	474	09.7311.40	475
09.4870.30A	464	09.4926.30ADA	377	09.5041.02B	545	09.7272.40A	138	09.7311.40.78	139
09.4870.30ADA	464	09.4927.14A	377	09.5041.02BDA	545	09.7272.40A	474	09.7311.40.78	475
09.4871.14A	464	09.4927.14ADA	377	09.5041.14B	545	09.7272.40A78	138	09.7312.14	139
09.4871.14ADA	464	09.4927.30A	377	09.5041.14BDA	545	09.7272.40A78	474	09.7312.14	475
09.4871.30A	464	09.4927.30ADA	377	09.5041.30B	545	09.7273.14A	138	09.7312.40	139
09.4871.30ADA	464	09.4950.14A	473	09.5041.30BDA	545	09.7273.14A	474	09.7312.40	475
09.4872.14A	464	09.4950.14ADA	473	09.5045.02B	545	09.7273.40A	138	09.7312.40.78	139
09.4872.14ADA	464	09.4950.30A	473	09.5045.02BDA	545	09.7273.40A	474	09.7312.40.78	475
09.4872.30A	464	09.4950.30ADA	473	09.5045.14B	545	09.7273.40A78	138	09.7313.14	139
09.4872.30ADA	464	09.4951.14A	473	09.5045.14BDA	545	09.7273.40A78	474	09.7313.14	475
09.4880.14A	471	09.4951.30A	473	09.5045.30B	545	09.7274.14A	138	09.7313.40	139
09.4880.30A	471	09.4953.14A	473	09.5045.30BDA	545	09.7274.14A	474	09.7313.40	475
09.4881.14A	471	09.4953.14ADA	473	09.5046.02B	545	09.7274.40A	138	09.7313.40.78	139
09.4881.30A	471	09.4953.30A	473	09.5046.02BDA	545	09.7274.40A	474	09.7313.40.78	475
09.4882.14A	471	09.4953.30ADA	473	09.5046.14B	545	09.7274.40A78	138	09.7314.14	139
09.4882.30A	471	09.4954.14A	473	09.5046.14BDA	545	09.7274.40A78	474	09.7314.14	475
09.4883.14A	471	09.4954.30A	473	09.5046.30B	545	09.7275.14A	138	09.7314.40	139
09.4883.30A	471	09.4956.14A	473	09.5046.30BDA	545	09.7275.14A	474	09.7314.40	475
09.4884.14A	471	09.4956.14ADA	473	09.6010.02B	546	09.7275.40A	138	09.7314.40.78	139
09.4884.30A	471	09.4956.30A	473	09.6010.02BDA	546	09.7275.40A	474	09.7314.40.78	475
09.4885.14A	471	09.4956.30ADA	473	09.6010.14B	546	09.7275.40A78	138	09.7315.14	139
09.4885.30A	471	09.4957.14A	473	09.6010.14BDA	546	09.7275.40A78	474	09.7315.14	475
09.4886.14A	471	09.4957.30A	473	09.6010.30B	546	09.7276.14A	138	09.7315.40	139
09.4886.30A	471	09.4980.14	473	09.6010.30BDA	546	09.7276.14A	474	09.7315.40	475
09.4887.14A	471	09.4980.14.DA	473	09.6011.02B	546	09.7276.40A	138	09.7315.40.78	139
09.4887.30A	471	09.4980.30	473	09.6011.02BDA	546	09.7276.40A	474	09.7315.40.78	475
09.4888.14A	471	09.4980.30.DA	473	09.6011.14B	546	09.7276.40A78	138	09.7316.14	139
09.4888.30A	471	09.4981.14	473	09.6011.14BDA	546	09.7276.40A78	474	09.7316.14	475
09.4910.14A	376	09.4981.14.DA	473	09.6011.30B	546	09.7277.14A	138	09.7316.40	139
09.4910.14ADA	376	09.4981.30	473	09.6011.30BDA	546	09.7277.14A	474	09.7316.40	475
09.4910.30A	376	09.4981.30.DA	473	09.6020.02B	546	09.7277.40A	138	09.7316.40.78	139

QUICK SEARCH OF PRODUCT

Ref.	Page	Ref.	Page	Ref.	Page	Ref.	Page	Ref.	Page
09.7316.40.78	475	09.7701.14ADA	466	09.7752.14A	467	09.8010.CZ	43	09.8100.DR.PC	448
09.7317.14	139	09.7701.30A	466	09.7752.14ADA	467	09.8011.14	43	09.8100.WA	448
09.7317.14	475	09.7701.30A78	466	09.7752.30A	467	09.8011.1A	43	09.8100.WA.CB	448
09.7317.40	139	09.7701.30ADA	466	09.7752.30A78	467	09.8011.40	43	09.8100.WA.PC	448
09.7317.40	475	09.7701.30AYU	466	09.7752.30ADA	467	09.8011.CZ	43	09.8101.DR	448
09.7317.40.78	139	09.7702.14A	466	09.7752.30AYU	467	09.8012.14	43	09.8101.DR.CB	448
09.7317.40.78	475	09.7702.14ADA	466	09.7753.14A	467	09.8012.1A	43	09.8101.DR.PC	448
09.7318.14	139	09.7702.30A	466	09.7753.14ADA	467	09.8012.40	43	09.8101.WA	448
09.7318.14	475	09.7702.30A78	466	09.7753.30A	467	09.8012.CZ	43	09.8101.WA.CB	448
09.7318.40	139	09.7702.30ADA	466	09.7753.30A78	467	09.8013.14	43	09.8101.WA.PC	448
09.7318.40	475	09.7702.30AYU	466	09.7753.30ADA	467	09.8013.1A	43	09.8102.DR	448
09.7318.40.78	139	09.7703.14A	466	09.7753.30AYU	467	09.8013.40	43	09.8102.DR.CB	448
09.7318.40.78	475	09.7703.14ADA	466	09.7754.14A	467	09.8013.CZ	43	09.8102.DR.PC	448
09.7320.14	518	09.7703.30A	466	09.7754.14ADA	467	09.8014.14	43	09.8102.WA	448
09.7320.40	518	09.7703.30A78	466	09.7754.30A	467	09.8014.1A	43	09.8102.WA.CB	448
09.7321.14	518	09.7703.30ADA	466	09.7754.30A78	467	09.8014.40	43	09.8102.WA.PC	448
09.7321.40	518	09.7703.30AYU	466	09.7754.30ADA	467	09.8014.CZ	43	09.8103.DR	448
09.7322.14	518	09.7704.14A	466	09.7754.30AYU	467	09.8015.14	43	09.8103.DR.CB	448
09.7322.40	518	09.7704.14ADA	466	09.7755.14A	467	09.8015.1A	43	09.8103.DR.PC	448
09.7323.14	518	09.7704.30A	466	09.7755.14ADA	467	09.8015.40	43	09.8103.WA	448
09.7323.40	518	09.7704.30A78	466	09.7755.30A	467	09.8015.CZ	43	09.8103.WA.CB	448
09.7324.14	518	09.7704.30ADA	466	09.7755.30A78	467	09.8016.14	43	09.8103.WA.PC	448
09.7324.40	518	09.7704.30AYU	466	09.7755.30ADA	467	09.8016.1A	43	09.8104.DR	448
09.7325.14	518	09.7705.14A	466	09.7755.30AYU	467	09.8016.40	43	09.8104.DR.CB	448
09.7325.40	518	09.7705.14ADA	466	09.7756.14A	467	09.8016.CZ	43	09.8104.DR.PC	448
09.7326.14	518	09.7705.30A	466	09.7756.14ADA	467	09.8017.14	43	09.8104.WA	448
09.7326.40	518	09.7705.30A78	466	09.7756.30A	467	09.8017.1A	43	09.8104.WA.CB	448
09.7327.14	518	09.7705.30ADA	466	09.7756.30A78	467	09.8017.40	43	09.8104.WA.PC	448
09.7327.40	518	09.7705.30AYU	466	09.7756.30ADA	467	09.8017.CZ	43	09.8105.DR	448
09.7328.14	518	09.7706.14A	466	09.7756.30AYU	467	09.8020.14	44	09.8105.DR.CB	448
09.7328.40	518	09.7706.14ADA	466	09.7757.14A	467	09.8020.1A	44	09.8105.DR.PC	448
09.7370.14	137	09.7706.30A	466	09.7757.14ADA	467	09.8020.40	44	09.8105.WA	448
09.7370.40	137	09.7706.30A78	466	09.7757.30A	467	09.8020.CZ	44	09.8105.WA.CB	448
09.7370.40.78	137	09.7706.30ADA	466	09.7757.30A78	467	09.8021.14	44	09.8105.WA.PC	448
09.7371.14	137	09.7706.30AYU	466	09.7757.30ADA	467	09.8021.1A	44	09.8106.DR	448
09.7371.40	137	09.7707.14A	466	09.7757.30AYU	467	09.8021.40	44	09.8106.DR.CB	448
09.7371.40.78	137	09.7707.14ADA	466	09.7758.14A	467	09.8021.CZ	44	09.8106.DR.PC	448
09.7372.14	137	09.7707.30A	466	09.7758.14ADA	467	09.8022.14	44	09.8106.WA	448
09.7372.40	137	09.7707.30A78	466	09.7758.30A	467	09.8022.1A	44	09.8106.WA.CB	448
09.7372.40.78	137	09.7707.30ADA	466	09.7758.30A78	467	09.8022.40	44	09.8106.WA.PC	448
09.7373.14	140	09.7707.30AYU	466	09.7758.30ADA	467	09.8022.CZ	44	09.8107.DR	448
09.7373.14	476	09.7708.14A	466	09.7758.30AYU	467	09.8023.14	44	09.8107.DR.CB	448
09.7373.40	140	09.7708.14ADA	466	09.7770.14A	469	09.8023.1A	44	09.8107.DR.PC	448
09.7373.40	476	09.7708.30A	466	09.7770.14ADA	469	09.8023.40	44	09.8107.WA	448
09.7373.40.78	140	09.7708.30A78	466	09.7770.30A	469	09.8023.CZ	44	09.8107.WA.CB	448
09.7373.40.78	476	09.7708.30ADA	466	09.7770.30A78	469	09.8024.14	44	09.8107.WA.PC	448
09.7374.14	140	09.7708.30AYU	466	09.7770.30ADA	469	09.8024.1A	44	09.8108.DR	448
09.7374.14	476	09.7730.14	468	09.7770.30AYU	469	09.8024.40	44	09.8108.DR.CB	448
09.7374.40	140	09.7730.14.DA	468	09.7771.14A	469	09.8024.CZ	44	09.8108.DR.PC	448
09.7374.40	476	09.7730.30	468	09.7771.14ADA	469	09.8025.14	44	09.8108.WA	448
09.7374.40.78	140	09.7730.30.78	468	09.7771.30A	469	09.8025.1A	44	09.8108.WA.CB	448
09.7374.40.78	476	09.7730.30.DA	468	09.7771.30A78	469	09.8025.40	44	09.8108.WA.PC	448
09.7375.14	140	09.7730.30.YU	468	09.7771.30ADA	469	09.8025.CZ	44	09.8109.DR	448
09.7375.14	476	09.7731.14A	468	09.7771.30AYU	469	09.8026.14	44	09.8109.DR.CB	448
09.7375.40	140	09.7731.14ADA	468	09.7772.14A	469	09.8026.1A	44	09.8109.DR.PC	448
09.7375.40	476	09.7731.30A	468	09.7772.14ADA	469	09.8026.40	44	09.8109.WA	448
09.7375.40.78	140	09.7731.30A78	468	09.7772.30A	469	09.8026.CZ	44	09.8109.WA.CB	448
09.7375.40.78	476	09.7731.30ADA	468	09.7772.30A78	469	09.8027.14	44	09.8109.WA.PC	448
09.7500.14	137	09.7731.30AYU	468	09.7772.30ADA	469	09.8027.1A	44	09.8110.DR	450
09.7500.40	137	09.7732.14	468	09.7772.30AYU	469	09.8027.40	44	09.8110.DR.CB	450
09.7500.40.78	137	09.7732.14.DA	468	09.8000.14	42	09.8027.CZ	44	09.8110.DR.DA	450
09.7501.14	137	09.7732.30	468	09.8000.1A	42	09.8030.14	45	09.8110.DR.PC	450
09.7501.40	137	09.7732.30.78	468	09.8000.40	42	09.8030.1A	45	09.8110.WA	450
09.7501.40.78	137	09.7732.30.DA	468	09.8000.CZ	42	09.8030.40	45	09.8110.WA.CB	450
09.7504.14	140	09.7732.30.YU	468	09.8001.14	42	09.8030.CZ	45	09.8110.WA.PC	450
09.7504.14	476	09.7733.14	468	09.8001.1A	42	09.8031.14	45	09.8111.DR	450
09.7504.14.DA	140	09.7733.14.DA	468	09.8001.40	42	09.8031.1A	45	09.8111.DR.CB	450
09.7504.14.DA	476	09.7733.30	468	09.8001.CZ	42	09.8031.40	45	09.8111.DR.DA	450
09.7504.40	140	09.7733.30.78	468	09.8002.14	42	09.8031.CZ	45	09.8111.DR.PC	450
09.7504.40	476	09.7733.30.DA	468	09.8002.1A	42	09.8032.14	45	09.8111.WA	450
09.7504.40.78	140	09.7733.30.YU	468	09.8002.40	42	09.8032.1A	45	09.8111.WA.CB	450
09.7504.40.78	476	09.7734.14A	468	09.8002.CZ	42	09.8032.40	45	09.8111.WA.PC	450
09.7504.40.DA	140	09.7734.14ADA	468	09.8003.14	42	09.8032.CZ	45	09.8111.WA.CB	450
09.7504.40.DA	476	09.7734.30A	468	09.8003.1A	42	09.8033.14	45	09.8111.WA.PC	450
09.7504.40.YU	140	09.7734.30A78	468	09.8003.40	42	09.8033.1A	45	09.8112.DR	450
09.7504.40.YU	476	09.7734.30ADA	468	09.8003.CZ	42	09.8033.40	45	09.8112.DR.CB	450
09.7505.14	140	09.7734.30AYU	468	09.8004.14	42	09.8033.CZ	45	09.8112.DR.DA	450
09.7505.14	476	09.7735.14	468	09.8004.1A	42	09.8034.14	45	09.8112.DR.PC	450
09.7505.14.DA	140	09.7735.14.DA	468	09.8004.40	42	09.8034.1A	45	09.8112.WA	450
09.7505.14.DA	476	09.7735.30	468	09.8004.CZ	42	09.8034.40	45	09.8112.WA.CB	450
09.7505.40	140	09.7735.30.78	468	09.8005.14	42	09.8034.CZ	45	09.8112.WA.PC	450
09.7505.40	476	09.7735.30.DA	468	09.8005.1A	42	09.8035.14	45	09.8112.WA.CB	450
09.7505.40.78	140	09.7735.30.YU	468	09.8005.40	42	09.8035.1A	45	09.8113.DR	450
09.7505.40.78	476	09.7750.14A	467	09.8005.CZ	42	09.8035.40	45	09.8113.DR.CB	450
09.7505.40.DA	140	09.7750.14ADA	467	09.8006.14	42	09.8035.CZ	45	09.8113.DR.DA	450
09.7505.40.DA	476	09.7750.30A	467	09.8006.1A	42	09.8036.14	45	09.8113.DR.PC	450
09.7505.40.YU	140	09.7750.30A78	467	09.8006.40	42	09.8036.1A	45	09.8113.WA	450
09.7505.40.YU	476	09.7750.30ADA	467	09.8006.CZ	42	09.8036.40	45	09.8113.WA.CB	450
09.7700.14A	466	09.7750.30AYU	467	09.8007.14	42	09.8036.CZ	45	09.8113.WA.PC	450
09.7700.14ADA	466	09.7751.14A	467	09.8007.1A	42	09.8037.14	45	09.8113.WA.CB	450
09.7700.30A	466	09.7751.14ADA	467	09.8007.40	42	09.8037.1A	45	09.8114.DR	451
09.7700.30A78	466	09.7751.30A	467	09.8007.CZ	42	09.8037.40	45	09.8114.DR.CB	451
09.7700.30ADA	466	09.7751.30A78	467	09.8010.14	43	09.8037.CZ	45	09.8114.DR.DA	451
09.7700.30AYU	466	09.7751.30ADA	467	09.8010.1A	43	09.8100.DR	448	09.8114.DR.PC	451
09.7701.14A	466	09.7751.30AYU	467	09.8010.40	43	09.8100.DR.CB	448	09.8114.WA	451

QUICK SEARCH OF PRODUCT

Ref.	Page	Ref.	Page	Ref.	Page	Ref.	Page	Ref.	Page
09.8114.WA.CB	451	09.8208.WA.CB	449	09.8301.DR	181	60.3037.14ADA	574	60.3145.11	573
09.8114.WA.DA	451	09.8208.WA.PC	449	09.8301.DV	181	60.3037.29	574	60.3145.14	573
09.8114.WA.PC	451	09.8209.DR	449	09.8301.DW	181	60.3037.29ADA	574	60.3146.11	573
09.8115.DR	450	09.8209.DR.CB	449	09.8301.DX	181	60.3038.11	573	60.3146.14	573
09.8115.DR.CB	450	09.8209.DR.PC	449	09.8301.DY	181	60.3038.11ADA	573	60.3317.11A	133
09.8115.DR.DA	450	09.8209.WA	449	09.8302.AH	181	60.3038.12	573	60.3317.14	133
09.8115.DR.PC	450	09.8209.WA.CB	449	09.8302.DR	181	60.3038.12ADA	573	60.3318.11A	133
09.8115.WA	450	09.8209.WA.PC	449	09.8302.DV	181	60.3038.14	573	60.3318.14	133
09.8115.WA.CB	450	09.8210.DR	452	09.8302.DW	181	60.3038.14ADA	573	60.3319.11A	133
09.8115.WA.DA	450	09.8210.DR.CB	452	09.8302.DX	181	60.3039.11	573	60.3319.14	132
09.8115.WA.PC	450	09.8210.DR.DA	452	09.8302.DY	181	60.3039.11ADA	573	60.3319.14A	133
09.8116.DR	450	09.8210.DR.PC	452	09.8310.AH	181	60.3039.12	573	60.3320.11A	133
09.8116.DR.CB	450	09.8210.WA	452	09.8310.DR	181	60.3039.12ADA	573	60.3320.14	133
09.8116.DR.DA	450	09.8210.WA.CB	452	09.8310.DV	181	60.3039.14	573	60.3321.11A	133
09.8116.DR.PC	450	09.8210.WA.DA	452	09.8310.DW	181	60.3039.14ADA	573	60.3321.14	133
09.8116.WA	450	09.8210.WA.PC	452	09.8310.DX	181	60.3043.11	574	60.3330.11A	133
09.8116.WA.CB	450	09.8211.DR	452	09.8310.DY	181	60.3043.11ADA	574	60.3330.14	133
09.8116.WA.DA	450	09.8211.DR.CB	452	09.8311.AH	181	60.3043.14	574	60.3331.11A	133
09.8116.WA.PC	450	09.8211.DR.DA	452	09.8311.DR	181	60.3043.14ADA	574	60.3331.14	133
09.8117.DR	450	09.8211.DR.PC	452	09.8311.DV	181	60.3043.29	574	60.3333.11A	133
09.8117.DR.CB	450	09.8211.WA	452	09.8311.DW	181	60.3043.29ADA	574	60.3333.14	133
09.8117.DR.DA	450	09.8211.WA.CB	452	09.8311.DX	181	60.3044.11	574	60.3336.11A	133
09.8117.DR.PC	450	09.8211.WA.DA	452	09.8311.DY	181	60.3044.11ADA	574	60.3336.14	133
09.8117.WA	450	09.8211.WA.PC	452	09.8312.AH	181	60.3044.12	574	60.3345	133
09.8117.WA.CB	450	09.8212.DR	452	09.8312.DR	181	60.3044.12ADA	574	60.3351.11A	133
09.8117.WA.DA	450	09.8212.DR.CB	452	09.8312.DV	181	60.3044.14	574	60.3351.14	133
09.8117.WA.PC	450	09.8212.DR.DA	452	09.8312.DW	181	60.3044.14ADA	574	60.3810.11	572
09.8118.DR	450	09.8212.DR.PC	452	09.8312.DX	181	60.3046.11	574	60.3810.11ADA	572
09.8118.DR.CB	450	09.8212.WA	452	09.8312.DY	181	60.3046.14	574	60.3810.14	572
09.8118.DR.DA	450	09.8212.WA.CB	452	09.9070.14	149	60.3046.29	574	60.3810.14ADA	572
09.8118.DR.PC	450	09.8212.WA.DA	452	09.9070.BW	149	60.3047.11	574	60.3810.29	572
09.8118.WA	450	09.8212.WA.PC	452	09.9071.14	149	60.3047.11ADA	574	60.3810.29ADA	572
09.8118.WA.CB	450	09.8213.DR	452	09.9071.BW	149	60.3047.14	574	60.3820.11	572
09.8118.WA.DA	450	09.8213.DR.CB	452	09.9072.14	149	60.3047.14ADA	574	60.3820.11ADA	572
09.8118.WA.PC	450	09.8213.DR.DA	452	09.9072.BW	149	60.3047.29	574	60.3820.14	572
09.8119.DR	451	09.8213.DR.PC	452	09.9075.14	149	60.3047.29ADA	574	60.3820.14ADA	572
09.8119.DR.CB	451	09.8213.WA	452	09.9075.BW	149	60.3048.11	574	60.3820.29	572
09.8119.DR.DA	451	09.8213.WA.CB	452	09.9076.14	149	60.3048.11ADA	574	60.3820.29ADA	572
09.8119.DR.PC	451	09.8213.WA.DA	452	09.9076.BW	149	60.3048.14	574	60.3830.11	572
09.8119.WA	451	09.8213.WA.PC	452	09.9077.14	149	60.3048.14ADA	574	60.3830.11ADA	572
09.8119.WA.CB	451	09.8214.DR	453	09.9077.BW	149	60.3048.29	574	60.3830.14	572
09.8119.WA.DA	451	09.8214.DR.CB	453	09.9083.14	150	60.3048.29ADA	574	60.3830.14ADA	572
09.8119.WA.PC	451	09.8214.DR.DA	453	09.9083.BW	150	60.3049.11	574	60.3830.29	572
09.8200.DR	449	09.8214.DR.PC	453	09.9084.14	150	60.3049.14	574	60.3830.29ADA	572
09.8200.DR.CB	449	09.8214.WA	453	09.9084.BW	150	60.3049.29	574	60.3840.11	572
09.8200.DR.PC	449	09.8214.WA.CB	453	09.9085.14	150	60.3051.11	574	60.3840.11ADA	572
09.8200.WA	449	09.8214.WA.DA	453	09.9085.BW	150	60.3051.14	574	60.3840.14	572
09.8200.WA.CB	449	09.8214.WA.PC	453	09.9086.14	150	60.3051.29	574	60.3840.14ADA	572
09.8200.WA.PC	449	09.8215.DR	452	09.9086.BW	150	60.3053.11	573	60.3840.29	572
09.8201.DR	449	09.8215.DR.CB	452	09.9087.14	150	60.3053.14	573	60.3840.29ADA	572
09.8201.DR.CB	449	09.8215.DR.DA	452	60.3008.11	573	60.3054	574	60.6213	584
09.8201.DR.PC	449	09.8215.DR.PC	452	60.3008.14	573	60.3057.11	573	60.6214	584
09.8201.WA	449	09.8215.WA	452	60.3014.11	113	60.3057.29	573	60.6256	584
09.8201.WA.CB	449	09.8215.WA.CB	452	60.3014.11	115	60.3083.29	573	60.6257	584
09.8201.WA.PC	449	09.8215.WA.DA	452	60.3014.11	573	60.3090.11	573	60.6258	584
09.8202.DR	449	09.8215.WA.PC	452	60.3014.14	113	60.3091.11	573	60.6259	584
09.8202.DR.CB	449	09.8216.DR	452	60.3014.14	115	60.3091.14	573	60.6300	584
09.8202.DR.PC	449	09.8216.DR.CB	452	60.3014.14	573	60.3092.11	573	60.6301	584
09.8202.WA	449	09.8216.DR.DA	452	60.3014.14	113	60.3093.29	573	60.6302	584
09.8202.WA.CB	449	09.8216.DR.PC	452	60.3014.14	115	60.3094.11	573	60.6303	584
09.8202.WA.PC	449	09.8216.WA	452	60.3014.14	573	60.3094.14	573	60.6304	584
09.8203.DR	449	09.8216.WA.CB	452	60.3016.11	574	60.3095.29	573	60.6305	584
09.8203.DR.CB	449	09.8216.WA.DA	452	60.3016.12	574	60.3096.29	573	60.6306	584
09.8203.DR.PC	449	09.8216.WA.PC	452	60.3016.14	574	60.3097.11	113	60.6399	584
09.8203.WA	449	09.8217.DR	452	60.3018.11	573	60.3097.11	115	60.6404	584
09.8203.WA.CB	449	09.8217.DR.CB	452	60.3018.14	573	60.3097.11	146	60.6500	584
09.8203.WA.PC	449	09.8217.DR.DA	452	60.3022.11	574	60.3097.11	573	60.6503	584
09.8204.DR	449	09.8217.DR.PC	452	60.3022.14	574	60.3097.14	113	60.6504	584
09.8204.DR.CB	449	09.8217.WA	452	60.3023.11	574	60.3097.14	115	60.6506	584
09.8204.DR.PC	449	09.8217.WA.CB	452	60.3023.14	574	60.3097.14	146	60.6507	584
09.8204.WA	449	09.8217.WA.DA	452	60.3023.29	574	60.3097.14	573	60.6509	584
09.8204.WA.CB	449	09.8217.WA.PC	452	60.3025.11	573	60.3101.11	572	60.6510	584
09.8204.WA.PC	449	09.8218.DR	452	60.3025.14	573	60.3101.11ADA	572	60.6512	584
09.8205.DR	449	09.8218.DR.CB	452	60.3025.29	573	60.3101.14	572	60.6513	584
09.8205.DR.CB	449	09.8218.DR.DA	452	60.3028.11	574	60.3101.14ADA	572	60.6515	584
09.8205.DR.PC	449	09.8218.DR.PC	452	60.3028.14	574	60.3101.29	572	60.6516	584
09.8205.WA	449	09.8218.WA	452	60.3028.14	574	60.3101.29ADA	572	60.6518	584
09.8205.WA.CB	449	09.8218.WA.CB	452	60.3028.14ADA	574	60.3102.11	572	60.6519	584
09.8205.WA.PC	449	09.8218.WA.DA	452	60.3028.29	574	60.3102.11ADA	572	60.6520	584
09.8206.DR	449	09.8218.WA.PC	452	60.3028.29ADA	574	60.3102.14	572	60.6521	584
09.8206.DR.CB	449	09.8219.DR	453	60.3029.11	574	60.3102.14ADA	572	60.6522	584
09.8206.DR.PC	449	09.8219.DR.CB	453	60.3029.11ADA	574	60.3102.29	572	60.6523	584
09.8206.WA	449	09.8219.DR.DA	453	60.3029.14	574	60.3102.29ADA	572	60.6616	584
09.8206.WA.CB	449	09.8219.DR.PC	453	60.3029.14ADA	574	60.3103.11	572	60.6617	584
09.8206.WA.PC	449	09.8219.WA	453	60.3029.29	574	60.3103.11ADA	572	60.6618	584
09.8207.DR	449	09.8219.WA.CB	453	60.3029.29ADA	574	60.3103.14	572	60.6722	584
09.8207.DR.CB	449	09.8219.WA.DA	453	60.3036.11	574	60.3103.14ADA	572	60.6723	584
09.8207.DR.PC	449	09.8219.WA.PC	453	60.3036.11ADA	574	60.3103.29	572	60.6724	584
09.8207.WA	449	09.8300.AH	181	60.3036.14	574	60.3103.29ADA	572	60.8268	177
09.8207.WA.CB	449	09.8300.DR	181	60.3036.14ADA	574	60.3104.11	572	60.8268	582
09.8207.WA.PC	449	09.8300.DV	181	60.3036.29	574	60.3104.11ADA	572	60.8268	603
09.8208.DR	449	09.8300.DW	181	60.3036.29ADA	574	60.3104.14	572	60.8268	610
09.8208.DR.CB	449	09.8300.DX	181	60.3037.11	574	60.3104.14ADA	572	60.8268	637
09.8208.DR.PC	449	09.8300.DY	181	60.3037.11ADA	574	60.3104.29	572	60.8402	621
09.8208.WA	449	09.8301.AH	181	60.3037.14	574	60.3104.29ADA	572	60.8407	241

QUICK SEARCH OF PRODUCT

Ref.	Page	Ref.	Page	Ref.	Page	Ref.	Page	Ref.	Page
60.8437	578	80.1318	571	SA.1002.3.102	626	SA.1015.3.014	616	SA.4008.3.102	617
60.8515	241	80.1332	571	SA.1002.3.116	626	SA.1015.3.015	616	SA.4009.3.001	618
60.8515	582	80.8067	561	SA.1003.3.001	626	SA.1015.3.025	616	SA.4009.3.003	618
60.8529	580	F0556020	551	SA.1003.3.003	626	SA.1015.3.026	616	SA.4009.3.004	618
60.8635	105	F0557020	551	SA.1003.3.004	626	SA.1015.3.027	616	SA.4009.3.009	618
60.8635	166	F4185009	560	SA.1003.3.009	626	SA.1015.3.102	616	SA.4009.3.015	618
60.8635	555	F4185030	560	SA.1003.3.015	626	SA.1015.3.116	616	SA.4009.3.017	618
60.8635	582	F4185057	560	SA.1003.3.017	626	SA.1019.3.001	615	SA.4009.3.025	618
60.8640	166	F9463009	561	SA.1003.3.025	626	SA.1019.3.003	615	SA.4009.3.026	618
60.8640	241	F9463030	561	SA.1003.3.026	626	SA.1019.3.004	615	SA.4009.3.027	618
60.8640	555	F9463057	561	SA.1003.3.027	626	SA.1019.3.006	615	SA.4009.3.102	618
60.8650	578	F9466057	559	SA.1003.3.102	626	SA.1019.3.009	615	SA.4010.3.001	617
60.8654	579	F9467057	559	SA.1004.3.001	627	SA.1019.3.014	615	SA.4010.3.003	617
60.8655	578	F9474057	560	SA.1004.3.003	627	SA.1019.3.015	615	SA.4010.3.004	617
60.8655	606	F9477057	560	SA.1004.3.004	627	SA.1019.3.025	615	SA.4010.3.009	617
60.8656	579	F9478009	561	SA.1004.3.009	627	SA.1019.3.026	615	SA.4010.3.015	617
60.8656	606	F9478030	561	SA.1004.3.015	627	SA.1019.3.027	615	SA.4010.3.017	617
60.8668	578	F9478057	561	SA.1004.3.017	627	SA.1019.3.102	615	SA.4010.3.025	617
60.8703	166	F9492057	558	SA.1004.3.025	627	SA.1019.3.116	615	SA.4010.3.026	617
60.8703	241	F9493057	558	SA.1004.3.026	627	SA.1034.3.001	624	SA.4010.3.027	617
60.8703	555	F9494057	558	SA.1004.3.027	627	SA.1034.3.116	624	SA.4010.3.102	617
60.8703	582	F9497057	559	SA.1004.3.102	627	SA.1035.1	625	SA.5000.1	612
60.8703	603	RF18525	582	SA.1005.3.001	627	SA.1039.1	623	SA.5001.1	612
60.8703	610	RF18863	584	SA.1005.3.003	627	SA.1040.1	624	SA.5004.1	611
60.8837	579	RF19264	584	SA.1005.3.004	627	SA.1041.1	624	SA.5005.1	611
60.8911	226	RF21466	230	SA.1005.3.009	627	SA.1050.1	236	SA.5006.1F	612
60.8911	578	RF21466	578	SA.1005.3.015	627	SA.1051.1	236	SA.5007.1F	612
60.8919	127	RF21466	606	SA.1005.3.017	627	SA.1052.1	237	SA.5008.1	611
60.9089	105	RF21467	582	SA.1005.3.025	627	SA.2282.1	600	SA.5009.1	611
60.9089	166	RF21468	578	SA.1005.3.026	627	SA.2285.1	600	SA.5020.5A120	607
60.9089	241	RF21469	580	SA.1005.3.027	627	SA.2286.1	600	SA.5020.5A180	607
60.9089	555	RF23065	561	SA.1005.3.102	627	SA.2293.1	598	SA.5020.6A120	607
60.9089	582	RF23065	580	SA.1006.4.11V	628	SA.2294.1	598	SA.5020.6A180	607
60.9089	603	RF26569	578	SA.1006.4.1DA	628	SA.2295.1	598	SA.5021.5A120	607
60.9089	610	RF26570	580	SA.1006.4.200	628	SA.2295.1	599	SA.5021.5A180	607
60.9157	561	RF26571	579	SA.1006.4.21V	628	SA.2303.1	599	SA.5021.6A120	607
60.9157	580	RF27321	27	SA.1006.4.2DA	628	SA.2303.3.120	599	SA.5021.6A180	607
60.9157	623	RF27321	37	SA.1006.4.300	628	SA.2304.1	599	SA.5022.5A120	608
60.9160	581	RF27321	151	SA.1006.5D110	628	SA.2304.3.120	599	SA.5022.5A180	608
60.9170	27	RF27370	226	SA.1006.6D100	628	SA.2313.1	598	SA.5022.6A120	608
60.9170	13	RF27370	230	SA.1007.4.11V	628	SA.2313.3.120	598	SA.5022.6A180	608
60.9170	37	RF27370	230	SA.1007.4.1DA	628	SA.2313.3.140	598	SA.5023.5A120	608
60.9170	151	RF27370	232	SA.1007.4.200	628	SA.2313.3.160	598	SA.5023.5A180	608
60.9207	226	RF27370	232	SA.1007.4.21V	628	SA.2314.1	598	SA.5023.6A120	608
60.9207	581	RF27370	579	SA.1007.4.2DA	628	SA.2314.3.120	598	SA.5023.6A180	608
60.9208	579	RF27535	578	SA.1007.4.300	628	SA.2314.3.140	598	SA.5061.3.076	621
60.9222	579	RF27961	228	SA.1007.5D110	628	SA.2314.3.160	598	SA.5061.3.00G	621
60.9233	578	RF27961	229	SA.1007.6D100	628	SA.2323.1	598	SA.5061.3.0V3	621
60.9268	580	RF27961	230	SA.1008.4.11V	629	SA.2324.1	598	SA.5062.3.076	621
60.9276	579	RF27961	232	SA.1008.4.1DA	629	SA.2325.1	598	SA.5062.3.00G	621
60.9389	580	RF27961	579	SA.1008.4.200	629	SA.2325.1	599	SA.5062.3.0V3	621
60.9392	37	RF28143	105	SA.1008.4.21V	629	SA.2333.1	599	SA.5063.3.076	621
60.9392	47	RF28143	582	SA.1008.4.2DA	629	SA.2333.3.120	599	SA.5063.3.00G	621
60.9392	64	RF28143	637	SA.1008.4.300	629	SA.2334.1	599	SA.5063.3.0V3	621
60.9392	80	RF28210	64	SA.1008.5D110	629	SA.2334.3.120	599	SA.5064.3.076	621
60.9395	37	RF28210	80	SA.1008.6D100	629	SA.2343.1	599	SA.5064.3.00G	621
60.9395	127	RF28211	64	SA.1009.4.11V	629	SA.2343.3.120	599	SA.5064.3.0V3	621
60.9398	582	RF28211	80	SA.1009.4.1DA	629	SA.2343.3.140	599	SA.5065.3.076	621
60.9398	616	RF28212	47	SA.1009.4.200	629	SA.2343.3.160	599	SA.5065.3.00G	621
60.9398	623	RF28212	64	SA.1009.4.21V	629	SA.2344.1	599	SA.5065.3.0V3	621
60.9398	633	RF28212	80	SA.1009.4.2DA	629	SA.2344.3.120	599	SA.5066.3.076	621
60.9398	634	RF28688	105	SA.1009.4.300	629	SA.2344.3.140	599	SA.5066.3.00G	621
60.9398	635	RF28688	241	SA.1009.5D110	629	SA.2344.3.160	599	SA.5066.3.0V3	621
60.9405	580	RF28688	555	SA.1009.6D100	629	SA.2423.5A145	597	SA.5067.3.076	621
60.9411	581	RF28688	582	SA.1010.4.100	630	SA.2423.5A165	597	SA.5067.3.00G	621
60.9414	226	RF28688	603	SA.1010.4.200	630	SA.2424.5A145	597	SA.5067.3.0V3	621
60.9416	47	RF28688	610	SA.1010.4.300	630	SA.2424.5A165	597	SA.5068.3.076	621
60.9416	64	RF28688	637	SA.1010.5D110	630	SA.2453.5A145	597	SA.5068.3.00G	621
60.9416	80	RF30699	228	SA.1010.6D100	630	SA.2453.5A165	597	SA.5068.3.0V3	621
60.9421	580	RF30699	229	SA.1011.4.11V	630	SA.2454.5A145	597	SA.5069.3.076	621
60.9424	582	RF30699	230	SA.1011.4.1DA	630	SA.2454.5A165	597	SA.5069.3.00G	621
60.9424	616	RF30699	232	SA.1011.4.200	630	SA.3009.1	635	SA.5069.3.0V3	621
60.9424	623	RF30699	581	SA.1011.4.21V	630	SA.3010.1C	631	SA.5070.3.076	621
60.9424	633	SA.1001.3.001	625	SA.1011.4.2DA	630	SA.3011.1B	631	SA.5070.3.00G	621
60.9424	634	SA.1001.3.003	625	SA.1011.4.300	630	SA.3012.1B	631	SA.5070.3.0V3	621
60.9424	635	SA.1001.3.004	625	SA.1011.5D110	630	SA.3013.1C	632	SA.5071.3.076	622
60.9426	47	SA.1001.3.006	625	SA.1011.6D100	630	SA.3014.1B	632	SA.5072.3.076	622
60.9426	64	SA.1001.3.009	625	SA.1012.3.019	616	SA.3015.1C	632	SA.5073.3.076	622
60.9426	80	SA.1001.3.014	625	SA.1014.3.001	615	SA.3016.1C	633	SA.5074.3.076	622
60.9439	581	SA.1001.3.015	625	SA.1014.3.003	615	SA.3017.1	633	SA.5075.3.076	622
60.9443	637	SA.1001.3.025	625	SA.1014.3.004	615	SA.3018.1	634	SA.5076.3.076	622
60.9467	581	SA.1001.3.026	625	SA.1014.3.006	615	SA.3019.1	633	SA.5077.3.076	622
60.9483	581	SA.1001.3.027	625	SA.1014.3.009	615	SA.3020.1	634	SA.5078.3.076	622
60.9516	64	SA.1001.3.102	625	SA.1014.3.014	615	SA.3021.1	634	SA.5100.1A	623
60.9592	578	SA.1001.3.116	625	SA.1014.3.015	615	SA.3022.1	635	SA.5101.1A	623
60.9601	580	SA.1002.3.001	626	SA.1014.3.025	615	SA.3023.1	635	SA.5102.1A	623
60.9602	226	SA.1002.3.003	626	SA.1014.3.026	615	SA.4008.3.001	617	SA.5200.5.120	605
60.9604	581	SA.1002.3.004	626	SA.1014.3.027	615	SA.4008.3.003	617	SA.5201.5.120	605
60.9607	27	SA.1002.3.006	626	SA.1014.3.102	615	SA.4008.3.004	617	SA.5202.5.120	605
60.9607	127	SA.1002.3.009	626	SA.1014.3.116	615	SA.4008.3.009	617	SA.5203.5.120	605
60.9607	13	SA.1002.3.014	626	SA.1015.3.001	616	SA.4008.3.015	617	SA.6600.1	390
60.9607	37	SA.1002.3.015	626	SA.1015.3.003	616	SA.4008.3.017	617		
60.9607	151	SA.1002.3.025	626	SA.1015.3.004	616	SA.4008.3.025	617		
60.9678	37	SA.1002.3.026	626	SA.1015.3.006	616	SA.4008.3.026	617		
60.9678	127	SA.1002.3.027	626	SA.1015.3.009	616	SA.4008.3.027	617		

DISTRIBUTION

DISTRIBUTION

**BELGIUM
AND LUXEMBOURG**
Flos Belux
M +32 474 739 080
flosbelux@flos.com

NORWAY
Drammensveien 120
0277 Oslo - Norway
Tel +47 2212 86 00
Fax +47 2212 86 08
info@flos.no

SWEDEN
Flos Scandinavia A/S
Karlalplan Lützengatan 1
S-115-20
Tel +46 (0) 8 660 4405
Fax +46 (0) 8 660 7005
info@flos.se

DENMARK
Flos Scandinavia A/S
Sydhavnsgade 28
DK-2450 København SV
Tel +45 (0) 3388 60 00
Fax +45 (0) 3388 60 10
info@flos.dk

AMSTERDAM
Cruquiusweg 109S
1019 AG Amsterdam
The Netherlands
Tel +31 (0) 20 560 50 60
flosnetherlands@flos.com

FRANCE
Flos France
20-22, Passage Dauphine
75006 Paris
Tel +33 (0) 1 40 64 17 44
flos.france@flos.com

**AUSTRIA - GERMANY
SWITZERLAND**
Flos GmbH
Obermünsterstraße 18
93047 Regensburg,
Germany
Tel +49 941 630837 00
Fax +49 941 630837 60
info@flos-gmbh.de

UNITED KINGDOM
Atrium Ltd.
28 Leonard Street
EC2A 4BY London
Tel +44 (0) 20 7681 9933
Fax +44 (0) 20 7681 9943
flos@atrium.ltd.uk

UNITED KINGDOM
International Projects
UK Division
Tel +44 (0) 20 7681 9933
flos.international@flos.com

DISTRIBUTION

JAPAN
Flos Co., Ltd.
PMC Building 9F
1-23-5 Higashiazabu
Minato-Ku Tokyo 104-0044
Tel: +81 (0)3 3582 1468
Fax: +81 (0)3 3582 0974
flosjapan@flosjapan.com

ASIA PACIFIC
Flos Representative Office
1, Commonwealth Lane
#08-12, 149544 Singapore
Tel +65 (0) 6372 1495
Fax +65 (0) 6372 7607
flosasia@flos.com

CHINA
Flos Illumination
(Shanghai) Co. Ltd.
Unit 101, Floor 1, Building B9
No. 800 of Chang De road
Jing An District, Shanghai,
200040, China
Tel: 86 021 62176187
floschina@flos.com

LATIN AMERICA
Flos LatAm
M +52 55 6960 1772
flos.latinamerica@flos.com

INDIA
Flos Representative Office
1, Commonwealth Lane
#08-12, 149544 Singapore
Tel +91 9999306667
Fax +65 (0) 6372 7607
flosindia@flos.com

U.S.A.
Flos USA Inc.
40-20 22nd Street - 3rd Floor
Long Island City, NY 11101
Tel +1 (8 0 0) 8 4 1 4 0 1 1
info@flosusa.com

MIDDLE EAST
Flos Middle East
Dubai Design District
Floor 3, Office 303
Dubai, United Arab Emirates
Tel +971 54 3567356
flosme@flos.com

HONG KONG
M +852 9307 3713
flosasia@flos.com

SHOWROOMS

STOCKHOLM
FLOS Sverige
Lützengatan 1
11520 Stockholm
Sweden
Tel +46086604405
info.se@flos.com

COPENHAGEN
FLOS Scandinavia
Kuglegaardsvej 13-17
1434 Copenhagen K
Denmark
Tel +4533886000
info.dk@flos.com

AMSTERDAM
Cruquiusweg 109S
1019 AG Amsterdam
The Netherlands
Tel +31 (0) 20 560 50 60
flosnetherlands@flos.com

OSLO
Drammensveien 120
0277 Oslo - Norway
Tel +47 (0) 2212 86 00
Fax +47 (0) 2212 86 08
info@flos.no

MILANO
Corso Monforte, 15
20122 Milano
Tel +39 02 79 84 57
Fax +39 02 89 78 56 41
showroom.milan@flos.com

PARIS
20-22, Passage Dauphine
75006 Paris
Tel +33 (0) 1 40 64 17 44
flos.france@flos.com

TOKYO
PMC Building 8F
1-23-5 Higashiazabu
Minato-Ku
Tokyo 104-0044
Tel: +81 (0)3 3582 1468
Fax: +81 (0)3 3582 0974
info@flosjapan.com

FLAGSHIP STORES

MILANO
Corso Monforte, 9
20122 - Milano
Tel +39 02 37011080
Fax +39 02 780833
flosmilano@flos.com

ROMA
Via del Babuino, 85
00187 - Roma
Tel +39 06 3207631
Fax +39 06 3207690
flosroma@flos.com

NEW YORK
152 Greene Street
NY 10012
Tel +1 212 941 4760
Fax +1 212 941 4763
info@flosusa.com

PARIS
15, Rue de Bourgogne
75007 - Paris
Tel +33 (0) 1 53 85 49 93
Fax +33 (0) 1 53 85 49 99
flosparis@flos.com

LYON
17 Rue Jarente
69002 - Lyon
Tel +33 478621301
Fax +33 478622119
floslyon@flos.com

STOCKHOLM
FLOS Sverige
Lützengatan 1
11520 Stockholm
Sweden
Tel +46086604405
info.se@flos.com

CONTACT

ITALY
Flos Spa
Via Angelo Faini, 2
25073 Bovezzo (Brescia)
Tel +39 0302438.1
Fax +39 0302438.250
info@flos.com

SPAIN
Antares Iluminación S.A.U.
Calle Mallorca, 1
Polígono Industrial Reva
46394 Ribarroja (Valencia)
Tel +34 96 166 95 20
Fax +34 96 166 82 86
flos.architectural@flos.com

CREDITS

ART DIRECTION
Apartamento Studios

GRAPHIC DESIGN
Apartamento Studios

PHOTO PRODUCT /
RENDERING
Piero Fasanotto
Jorge Herrera
Mozing Studio

LAYOUT
Flos Architectural Team

EDITION
October 2021
Copyright © Flos 2021
All rights reserved

PRINTED BY
Graficart Arti Grafiche S.r.l.
Treviso - Italy

Il nostro mondo si evolve continuamente. I progressi tecnici sono all'ordine del giorno nel nostro settore.

Lo scopo di Flos è offrire sempre la tecnologia più affidabile a disposizione, rivedendo continuamente i prodotti e aggiornandoli non appena le evoluzioni tecnologiche offrono vantaggi per i nostri partner e clienti.

Questa filosofia fa sì che il nostro catalogo e le schede tecniche dei nostri prodotti siano anch'essi in continua evoluzione, con la conseguente necessità di aggiornamenti e revisioni continue.

Per tanto, quando avete bisogno di dettagli tecnici e delle informazioni più recenti, sfogliate la sezione prodotti del nostro sito Web ufficiale Flos.com: è aggiornato quotidianamente e offre gli ultimi dettagli dei prodotti, dei codici degli articoli disponibili e tutta la documentazione per il download immediato.

As our world is in constant evolution, technical upgrades happens every day in our business.

Flos aim is to offer always the best reliable technology available, constantly reviewing our products and upgrading them as soon as technologic evolutions offers benefits for our partners and clients.

This philosophy means that our technical catalogue and product data sheets also are in constant evolution, requiring upgrades and constants reviewing.

Thus, when you need technical details and the most recent product information, please browse the product section of our Flos.com official website: it is updated daily, and there you'll find the latest product details, all available part numbers, all product documents available for immediate download.

www.flos.com

