

borled[®]

BORLED AYDINLATMA ÜRÜNLERİ KATALOĐU

**BORLED LIGHTING
PRODUCTS CATALOG**

2021

Ürün Kodu Product Code	Güç(W) Power	Sf. No Page No
BL-S1-2001	3W	15
BL-S1-2002	3W	15
BL-S1-2003	3W	15
BL-S1-2004	6W	15
BL-S1-2005	6W	15
BL-S1-2006	6W	15
BL-S1-2007	9W	15
BL-S1-2008	9W	15
BL-S1-2009	9W	15
BL-S1-2010	12W	15
BL-S1-2011	12W	15
BL-S1-2012	12W	15
BL-S1-2013	15W	15
BL-S1-2014	15W	15
BL-S1-2015	15W	15
BL-S1-2016	18W	15
BL-S1-2017	18W	15
BL-S1-2018	18W	15
BL-S1-2019	24W	15
BL-S1-2020	24W	15
BL-S1-2021	24W	15
BL-S1-2022	18W	16
BL-S1-2023	18W	16
BL-S1-2024	18W	16
BL-S1-2025	24W	16
BL-S1-2026	24W	16
BL-S1-2027	24W	16
BL-BD-0001	8W	17
BL-BD-0002	8W	17
BL-BD-0003	8W	17
BL-BD-0004	12W	17
BL-BD-0005	12W	17
BL-BD-0006	12W	17
BL-BD-0007	18W	17
BL-BD-0008	18W	17
BL-BD-0009	18W	17
BL-BD-0010	24W	17
BL-BD-0011	24W	17
BL-BD-0012	24W	17
BL-BD-1001	8W	18
BL-BD-1002	8W	18
BL-BD-1003	8W	18
BL-BD-1004	12W	18
BL-BD-1005	12W	18
BL-BD-1006	12W	18
BL-BD-1007	18W	18
BL-BD-1008	18W	18
BL-BD-1009	18W	18
BL-BD-1010	24W	18
BL-BD-1011	24W	18

Ürün Kodu Product Code	Güç(W) Power	Sf. No Page No
BL-BD-1012	24W	18
BR-1519	18W	19
BR-1522	24W	19
BR-1521	18W	19
BR-1520	24W	19
BL-D1-0001	9W	20
BL-D1-0002	9W	20
BL-D1-0003	9W	20
BL-D1-0004	18W	20
BL-D1-0005	18W	20
BL-D1-0006	18W	20
BL-D1-0007	24W	20
BL-D1-0008	24W	20
BL-D1-0009	24W	20
BL-D1-0010	36W	20
BL-D1-0011	36W	20
BL-D1-0012	36W	20
BL-O5-2001	40W	21
BL-O5-2002	40W	21
BL-O5-2003	40W	21
BL-O6-2001	24W	22
BL-O6-2002	24W	22
BL-O6-2003	24W	22
BL-O7-2001	48W	22
BL-O7-2002	48W	22
BL-O7-2003	48W	22
BLT-O2-2005	12W	23
BLT-O2-2006	12W	23
BLT-O6-0002	24W	23
BLT-O6-0003	24W	23
BLT-O2-2002	40W	23
BLT-O2-2003	40W	23
BLT-O5-2005	12W	24
BLT-O5-2006	12W	24
BLT-O6-1002	24W	24
BLT-O6-1003	24W	24
BLT-O5-2008	36W	24
BLT-O5-2009	36W	24
BL-O2-2011	40W	25
BL-O2-2012	40W	25
BL-O2-2013	40W	25
BLT-O2-3011	12W	26
BLT-O2-3012	12W	26
BLT-O6-2002	24W	26
BLT-O6-2003	24W	26
BLT-O2-2008	40W	26
BLT-O2-2009	40W	26
BL-O2-3001	15W	27
BL-O2-3002	15W	27
BL-O2-4001	35W	27

Ürün Kodu Product Code	Güç(W) Power	Sf. No Page No
BL-O2-4002	35W	27
BL-O5-3001	15W	28
BL-O5-3002	15W	28
BL-O5-4001	35W	28
BL-O5-4002	35W	28
134-0922	DIŞ ÇERÇEVE 30x30	29
134-0963	LED 60X60 SIVA USTU DEMONTE KASA	29
134-1005	DIŞ ÇERÇEVE 60x60 CLIP-IN KASA	29
BL-Y1-0001	42W	30
BL-Y1-0002	42W	30
BL-Y1-0003	42W	30
BL-Y1-0004	85W	30
BL-Y1-0005	85W	30
BL-Y1-0006	85W	30
BL-Y1-0007	105W	30
BL-Y1-0008	105W	30
BL-Y1-0009	105W	30
BL-Y1-0010	125W	30
BL-Y1-0011	125W	30
BL-Y1-0012	125W	30
BL-Y1-0013	150W	30
BL-Y1-0014	150W	30
BL-Y1-0015	150W	30
BL-L1-1001	15W	31
BL-L1-1002	15W	31
BL-L1-1003	20W	31
BL-L1-1004	20W	31
BL-L1-1005	30W	31
BL-L1-1006	30W	31
BL-L1-1007	40W	31
BL-L1-1008	40W	31
BL-L1-1009	45W	31
BL-L1-1010	45W	31
BL-L1-1011	50W	31
BL-L1-1012	50W	31
BL-L1-1001	15W	32
BL-L1-1002	15W	32
BL-L1-1003	20W	32
BL-L1-1004	20W	32
BL-L1-1005	30W	32
BL-L1-1006	30W	32
BL-L1-1007	40W	32
BL-L1-1008	40W	32
BL-L1-1009	45W	32
BL-L1-1010	45W	32
BL-L1-1011	50W	32
BL-L1-1012	50W	32
BL-E1-0009	15W	33
BL-E1-0009-1H	15W	33
BL-E1-0009-3H	15W	33

Ürün Kodu Product Code	Güç(W) Power	Sf. No Page No
BL-E1-0009-RS	15W	33
BL-E1-0009-RS-1H	15W	33
BL-E1-0009-RS-3H	15W	33
BL-E1-0013	15W	33
BL-E1-0013-1H	15W	33
BL-E1-0013-3H	15W	33
BL-E1-0013-RS	15W	33
BL-E1-0013-RS-1H	15W	33
BL-E1-0013-RS-3H	15W	33
BL-E1-0011	30W	33
BL-E1-0011-1H	30W	33
BL-E1-0011-3H	30W	33
BL-E1-0011-RS	30W	33
BL-E1-0011-RS-1H	30W	33
BL-E1-0011-RS-3H	30W	33
BL-E1-0015	30W	34
BL-E1-0015-1H	30W	34
BL-E1-0015-3H	30W	34
BL-E1-0015-RS	30W	34
BL-E1-0015-RS-1H	30W	34
BL-E1-0015-RS-3H	30W	34
BL-E1-0010	20W	35
BL-E1-0010-1H	20W	35
BL-E1-0010-3H	20W	35
BL-E1-0010-RS	20W	35
BL-E1-0010-RS-1H	20W	35
BL-E1-0010-RS-3H	20W	35
BL-E1-0014	20W	35
BL-E1-0014-1H	20W	35
BL-E1-0014-3H	20W	35
BL-E1-0014-RS	20W	35
BL-E1-0014-RS-1H	20W	35
BL-E1-0014-RS-3H	20W	35
BL-E1-0012	40W	35
BL-E1-0012-1H	40W	35
BL-E1-0012-3H	40W	35
BL-E1-0012-RS	40W	35
BL-E1-0012-RS-1H	40W	35
BL-E1-0012-RS-3H	40W	35
BL-E1-0016	40W	36
BL-E1-0016-1H	40W	36
BL-E1-0016-3H	40W	36
BL-E1-0016-RS	40W	36
BL-E1-0016-RS-1H	40W	36
BL-E1-0016-RS-3H	40W	36
BLT-E1-0009	15W	37
BLT-E1-0009-1H	15W	37
BLT-E1-0009-3H	15W	37
BLT-E1-0009-RS	15W	37
BLT-E1-0009-RS-1H	15W	37

Ürün Kodu Product Code	Güç(W) Power	Sf. No Page No
BLT-E1-0009-RS-3H	15W	37
BLT-E1-0013	15W	37
BLT-E1-0013-1H	15W	37
BLT-E1-0013-3H	15W	37
BLT-E1-0013-RS	15W	37
BLT-E1-0013-RS-1H	15W	37
BLT-E1-0013-RS-3H	15W	37
BLT-E1-0011	30W	37
BLT-E1-0011-1H	30W	37
BLT-E1-0011-3H	30W	37
BLT-E1-0011-RS	30W	37
BLT-E1-0011-RS-1H	30W	37
BLT-E1-0011-RS-3H	30W	37
BLT-E1-0015	30W	38
BLT-E1-0015-1H	30W	38
BLT-E1-0015-3H	30W	38
BLT-E1-0015-RS	30W	38
BLT-E1-0015-RS-1H	30W	38
BLT-E1-0015-RS-3H	30W	38
BLT-E1-0010	20W	39
BLT-E1-0010-1H	20W	39
BLT-E1-0010-3H	20W	39
BLT-E1-0010-RS	20W	39
BLT-E1-0010-RS-1H	20W	39
BLT-E1-0010-RS-3H	20W	39
BLT-E1-0014	20W	39
BLT-E1-0014-1H	20W	39
BLT-E1-0014-3H	20W	39
BLT-E1-0014-RS	20W	39
BLT-E1-0014-RS-1H	20W	39
BLT-E1-0014-RS-3H	20W	39
BLT-E1-0012	40W	39
BLT-E1-0012-1H	40W	39
BLT-E1-0012-3H	40W	39
BLT-E1-0012-RS	40W	39
BLT-E1-0012-RS-1H	40W	39
BLT-E1-0012-RS-3H	40W	39
BLT-E1-0016	40W	40
BLT-E1-0016-1H	40W	40
BLT-E1-0016-3H	40W	40
BLT-E1-0016-RS	40W	40
BLT-E1-0016-RS-1H	40W	40
BLT-E1-0016-RS-3H	40W	40
BL-E3-0001	18W	41
BL-E3-0003	18W	41
BL-E3-0004	36W	41
BL-E3-0006	36W	41
BL-G1-0002	12W	42
BL-G1-0002-1H	12W	42
BL-G1-0002-3H	12W	42

Ürün Kodu Product Code	Güç(W) Power	Sf. No Page No
BL-G1-0002-RS	12W	42
BL-G1-0002-RS-1H	12W	42
BL-G1-0002-RS-3H	12W	42
BL-G1-0014	12W	42
BL-G1-0014-1H	12W	42
BL-G1-0014-3H	12W	42
BL-G1-0014-RS	12W	42
BL-G1-0014-RS-1H	12W	42
BL-G1-0014-RS-3H	12W	42
BL-G1-0008	12W	42
BL-G1-0008-1H	12W	42
BL-G1-0008-3H	12W	42
BL-G1-0008-RS	12W	42
BL-G1-0008-RS-1H	12W	42
BL-G1-0008-RS-3H	12W	42
BL-G1-0004	18W	43
BL-G1-0004-1H	18W	43
BL-G1-0004-3H	18W	43
BL-G1-0004-RS	18W	43
BL-G1-0004-RS-1H	18W	43
BL-G1-0004-RS-3H	18W	43
BL-G1-0016	18W	43
BL-G1-0016-1H	18W	43
BL-G1-0016-3H	18W	43
BL-G1-0016-RS	18W	43
BL-G1-0016-RS-1H	18W	43
BL-G1-0016-RS-3H	18W	43
BL-G1-0010	18W	43
BL-G1-0010-1H	18W	43
BL-G1-0010-3H	18W	43
BL-G1-0010-RS	18W	43
BL-G1-0010-RS-1H	18W	43
BL-G1-0010-RS-3H	18W	43
BL-G1-0006	24W	43
BL-G1-0006-1H	24W	43
BL-G1-0006-3H	24W	43
BL-G1-0006-RS	24W	43
BL-G1-0006-RS-1H	24W	43
BL-G1-0006-RS-3H	24W	43
BL-G1-0018	24W	43
BL-G1-0018-1H	24W	43
BL-G1-0018-3H	24W	43
BL-G1-0018-RS	24W	43
BL-G1-0018-RS-1H	24W	43
BL-G1-0018-RS-3H	24W	43
BL-G1-0012	24W	43
BL-G1-0012-1H	24W	43
BL-G1-0012-3H	24W	43
BL-G1-0012-RS	24W	43
BL-G1-0012-RS-1H	24W	43

Ürün Kodu Product Code	Güç(W) Power	Sf. No Page No	Ürün Kodu Product Code	Güç(W) Power	Sf. No Page No	Ürün Kodu Product Code	Güç(W) Power	Sf. No Page No	Ürün Kodu Product Code	Güç(W) Power	Sf. No Page No
BL-G1-0012-RS-3H	24W	43	BL-G1-0011-1H	24W	45	BL-P2-0018	100W	51	BR-00248-010	Beyaz	58
BL-G1-0001	12W	44	BL-G1-0011-3H	24W	45	BL-P2-0019	150W	51	BR-00244-000	Beyaz	58
BL-G1-0001-1H	12W	44	BL-G1-0011-RS	24W	45	BL-P2-0021	150W	51	BR-00244-010	Beyaz	59
BL-G1-0001-3H	12W	44	BL-G1-0011-RS-1H	24W	45	BL-P2-0022	200W	51	BR-00242-000	Beyaz	59
BL-G1-0001-RS	12W	44	BL-G1-0011-RS-3H	24W	45	BL-P2-0024	200W	51	BR-00242-010	Beyaz	59
BL-G1-0001-RS-1H	12W	44	BL-B1-0007	12W	46	BL-P2-0001-S	10W	52	BR-00245-000	Beyaz	60
BL-G1-0001-RS-3H	12W	44	BL-B1-0008	12W	46	BL-P2-0003-S	10W	52	BR-00245-010	Beyaz	60
BL-G1-0013	12W	44	BL-B1-0009	11W	46	BL-P2-0004-S	20W	52	BR-00201-000	Beyaz	60
BL-G1-0013-1H	12W	44	BL-B1-0010	11W	46	BL-P2-0006-S	20W	52	BR-00201-010	Beyaz	61
BL-G1-0013-3H	12W	44	BL-B1-0011	11W	47	BL-P2-0007-S	30W	52	BR-00247-000	Beyaz	61
BL-G1-0013-RS	12W	44	BL-B1-0012	11W	47	BL-P2-0009-S	30W	52	BR-00247-010	Beyaz	61
BL-G1-0013-RS-1H	12W	44	BL-B1-0015	24W	47	BL-P2-0010-S	50W	52	BR-00230-010	Beyaz	62
BL-G1-0013-RS-3H	12W	44	BL-B1-0016	24W	47	BL-P2-0012-S	50W	52	BR-00230-002	Beyaz	62
BL-G1-0007	12W	44	BL-B1-0017	24W	48	BL-P2-1GRN	10W	53	BR-00230-000	Beyaz	62
BL-G1-0007-1H	12W	44	BL-B1-0018	24W	48	BL-P2-2GRN	20W	53	BR-00231-000	Beyaz	63
BL-G1-0007-3H	12W	44	BL-B1-0019	12W	48	BL-P2-3GRN	30W	53	BR-00231-010	Beyaz	63
BL-G1-0007-RS	12W	44	BL-B1-0020	12W	48	BL-P2-5GRN	50W	53	BR-00243-050	Beyaz	63
BL-G1-0007-RS-1H	12W	44	BL-G2-0002	12W	49	BL-P2-0050	50W	53	BR-00231-020	Beyaz	64
BL-G1-0007-RS-3H	12W	44	BL-G2-0003	12W	49	BL-P2-0070	70W	53	BR-10243 050	Beyaz	64
BL-G1-0003	18W	45	BL-G2-0005	15W	49	BL-P2-0100	100W	53	BR-C0243-050	Beyaz	64
BL-G1-0003-1H	18W	45	BL-G2-0006	15W	49	BL-P2-0150	150W	53	BL-B1-0021	12W	65
BL-G1-0003-3H	18W	45	BL-G2-0008	12W	49	BL-P2-0200	200W	53	BL-B1-0022	12W	65
BL-G1-0003-RS	18W	45	BL-G2-0009	12W	49	BL-RS-0001	40W	54	BL-B1-0024	12W	65
BL-G1-0003-RS-1H	18W	45	BL-G2-0011	15W	49	BL-RS-0002	40W	54	BL-B1-0025	12W	65
BL-G1-0003-RS-3H	18W	45	BL-G2-0012	15W	49	BL-RS-0003	40W	54	BR-00206-010	Beyaz	66
BL-G1-0015	18W	45	BL-G3-0002	12W	49	BL-RS-1001	40W	54	BR-00206-000	Beyaz	66
BL-G1-0015-1H	18W	45	BL-G3-0003	12W	49	BL-RS-1002	40W	54	BR-00220-010	Beyaz	66
BL-G1-0015-3H	18W	45	BL-G3-0005	15W	49	BL-RS-1003	40W	54	BR-00235-000	Beyaz	67
BL-G1-0015-RS	18W	45	BL-G3-0006	15W	49	BL-C2-2001	60W	55	BR-00309-000	Beyaz	67
BL-G1-0015-RS-1H	18W	45	BL-G3-0008	12W	49	BL-C2-2002	60W	55	BR-00220-011	Beyaz	67
BL-G1-0015-RS-3H	18W	45	BL-G3-0009	12W	49	BL-C2-2003	90W	55	BR-00306-000	Beyaz	68
BL-G1-0009	18W	45	BL-G3-0011	15W	49	BL-C2-2004	90W	55	BR-00220-000	Beyaz	68
BL-G1-0009-1H	18W	45	BL-G3-0012	15W	49	BL-C2-2005	120W	55	BR-00220-001	Beyaz	68
BL-G1-0009-3H	18W	45	BL-B1-0001	12W	50	BL-C2-2006	120W	55	BR-00222-000	Beyaz	69
BL-G1-0009-RS	18W	45	BL-B1-0002	12W	50	BL-SL-1001	14.4	56	BR-00307-000	Beyaz	69
BL-G1-0009-RS-1H	18W	45	BL-B1-0003	12W	50	BL-SL-1002	14.4	56	BR-00246-000	Beyaz	69
BL-G1-0009-RS-3H	18W	45	BL-B1-0004	12W	50	BL-SL-1006	14.4	56	BR-00249-000	Beyaz	70
BL-G1-0005	24W	45	BL-B1-0005	12W	50	BL-SL-1003	14.4	56	BR-00246-010	Beyaz	70
BL-G1-0005-1H	24W	45	BL-B1-0006	12W	50	BL-SL-1004	14.4	56	BR-00222-001	Beyaz	70
BL-G1-0005-3H	24W	45	BL-P2-0001	10W	51	BL-SL-1005	14.4	56	BR-818	-	71
BL-G1-0005-RS	24W	45	BL-P2-0003	10W	51	BL-T1-132-1599	60W	56	BR-819	-	71
BL-G1-0005-RS-1H	24W	45	BL-P2-0004	20W	51	BL-T1-132-1600	120W	56	BR-820	-	71
BL-G1-0005-RS-3H	24W	45	BL-P2-0006	20W	51	BL-T1-132-1601	150W	56	BR-821	-	71
BL-G1-0017	24W	45	BL-P2-0007	30W	51	BL-T1-132-1602	200W	56	BR-804	-	72
BL-G1-0017-1H	24W	45	BL-P2-0009	30W	51	BL-T1-132-1603	250W	56	BR-803	-	72
BL-G1-0017-3H	24W	45	BL-P2-0010	50W	51	BL-T1-132-1604	360W	56	BR-806	-	72
BL-G1-0017-RS	24W	45	BL-P2-0012	50W	51	BR-00203-000	Beyaz	57	BR-805	-	72
BL-G1-0017-RS-1H	24W	45	BL-P2-0013	70W	51	BR-00248-000	Beyaz	57	BR-808	-	73
BL-G1-0017-RS-3H	24W	45	BL-P2-0015	70W	51	BR-00203-010	Beyaz	57	BR-807	-	73
BL-G1-0011	24W	45	BL-P2-0016	100W	51	BR-00203-020	Beyaz	58	BR-816	-	73

Ürün Kodu Product Code	Güç(W) Power	Sf. No Page No	Ürün Kodu Product Code	Güç(W) Power	Sf. No Page No	Ürün Kodu Product Code	Güç(W) Power	Sf. No Page No	Ürün Kodu Product Code	Güç(W) Power	Sf. No Page No
BR-815	-	73	BR-1564-2	-	78	BR-1596-5	-	81	BR-1882	16	85
BR-814	-	74	BR-1564-3	-	78	BR-1514	-	81	BR-1882-K	16	85
BR-813	-	74	BR-1564-5	-	78	BR-1510	-	82	BR-1882D	16	85
BR-810	-	74	BR-1566-0	-	78	BR-1511	-	82	BR-1883	25	85
BR-809	-	74	BR-1566-2	-	78	BR-1515	-	82	BR-1883-K	25	85
BR-812	-	75	BR-1566-3	-	78	BR-1516	-	82	BR-1883D	25	85
BR-811	-	75	BR-1566-5	-	78	BR-001411	-	82	BR-1884	35	85
BR-750	-	76	BR-1542-0	-	79	BR-1761 M5	10	83	BR-1884-K	35	85
BR-760	-	76	BR-1542-2	-	79	BR-1761 M5K	10	83	BR-1884D	35	85
BR-770	-	76	BR-1542-3	-	79	BR-1762 M6	16	83	BR-1885	50	85
BR-1713	-	76	BR-1542-5	-	79	BR-1762-M6K	16	83	BR-1885-K	50	85
BR-710	-	76	BR-1543-0	-	79	BR-1763 M8	25	83	BR-1885D	50	85
BR-901	-	76	BR-1543-2	-	79	BR-1763-M8K	25	83	BR-1886	70	85
BR-902	-	76	BR-1543-3	-	79	BR-1764 M8	35	83	BR-1886D	70	85
BR-730	-	76	BR-1543-5	-	79	BR-1764-M8K	35	83	BR-1887	95	85
BR-731	-	76	BR-1586-0	-	79	BR-1765 M10	50	83	BR-1887D	95	85
BR-732	-	76	BR-1586-2	-	79	BR-1765-M10K	50	83	BR-1888	120	85
BR-734	-	76	BR-1586-3	-	79	BR-1766 M10	70	83	BR-1888D	120	85
BR-733	-	76	BR-1586-5	-	79	BR-1767 M10	95	83	BR-1889	150	85
BR-1413	-	76	BR-1572-0	-	79	BR-1768 M12	120	83	BR-1889D	150	85
BR-1708	-	76	BR-1572-2	-	79	BR-1769 M12	150	83	BR-1890	185	85
BR-1712	-	76	BR-1572-3	-	79	BR-1770 M16	185	83	BR-1890D	185	85
BR-1413-E	-	76	BR-1572-5	-	79	BR-1771 M16	240	83	BR-1891	240	85
BR-1708-E	-	76	BR-1573-0	-	80	BR-1772 M16	300	83	BR-1892	300	85
BR-1712-E	-	76	BR-1573-2	-	80	BR-1773 M20	400	83	BR-1893	400	85
BR-1552-0	-	77	BR-1573-3	-	80	BR-1780 M5	6	84			
BR-1552-2	-	77	BR-1573-5	-	80	BR-1780-M5K	6	84			
BR-1552-3	-	77	BR-1574-0	-	80	BR-1781 M5	10	84			
BR-1552-5	-	77	BR-1574-2	-	80	BR-1781-M5K	10	84			
BR-1553-0	-	77	BR-1574-3	-	80	BR-1782 M6	16	84			
BR-1553-2	-	77	BR-1574-5	-	80	BR-1782-M6K	16	84			
BR-1553-3	-	77	BR-1576-0	-	80	BR-1783 M8	25	84			
BR-1553-5	-	77	BR-1576-2	-	80	BR-1783-M8K	25	84			
BR-1554-0	-	77	BR-1576-3	-	80	BR-1784 M8	35	84			
BR-1554-2	-	77	BR-1576-5	-	80	BR-1784-M8K	35	84			
BR-1554-3	-	77	BR-1592-0	-	80	BR-1785 M10	50	84			
BR-1554-5	-	77	BR-1592-2	-	80	BR-1785-M10K	50	84			
BR-1556-0	-	77	BR-1592-3	-	80	BR-1786 M10	70	84			
BR-1556-2	-	77	BR-1592-5	-	80	BR-1787 M10	95	84			
BR-1556-3	-	77	BR-1593-0	-	81	BR-1788 M12	120	84			
BR-1556-5	-	77	BR-1593-2	-	81	BR-1789 M12	150	84			
BR-1562-0	-	78	BR-1593-3	-	81	BR-1790 M16	185	84			
BR-1562-2	-	78	BR-1593-5	-	81	BR-1791 M16	240	84			
BR-1562-3	-	78	BR-1594-0	-	81	BR-1792 M16	300	84			
BR-1562-5	-	78	BR-1594-2	-	81	BR-1793 M20	400	84			
BR-1563-0	-	78	BR-1594-3	-	81	BR-1880	6	85			
BR-1563-2	-	78	BR-1594-5	-	81	BR-1880-K	6	85			
BR-1563-3	-	78	BR-1596-0	-	81	BR-1881	10	85			
BR-1563-5	-	78	BR-1596-2	-	81	BR-1881-K	10	85			
BR-1564-0	-	78	BR-1596-3	-	81	BR-1881D	10	85			

1984'TEN BERİ BÜYÜYEN BİR AİLEYİZ.



“Başarımızın sırrı, insanların kalbini kazanmaktan geçiyor.”

Adnan Ölmez

Yönetim Kurulu Başkanı

Türkiye'nin en büyük gruplarından biri olan Borsan Grup, sektördeki 35. yılını gururla geride bırakırken, her geçen gün emin adımlarla büyümeye devam etmektedir.

Borsan Grup bünyesindeki şirketleriyle; uluslararası kalite standartlarına uygun üretim yaparak üretiminin %50'den fazlasını, 4 kıtada 75 ülkeye ihraç etmekte olup, ihracat yaptığı ülkelerin bazılarında kendi markasıyla pazar lideri konumundadır.

Bünyesinde bulundurduğu şirketlerden bazıları, Türkiye'deki sanayi kuruluşları ve ihracat yapan ilk 500 şirket arasındadır. Borsan Grup, 1000'den fazla kişiyi istihdam etmektedir.

Borsan Kablo, Yılka Kablo, Borsan Cavi, Borkonut, Borpanel, Medicana Hastanesi, firmalarını bünyesinde bulundurmaktadır. Borsan Kablo markasıyla bakır, Yılka Kablo markasıyla alüminyum iletkenli kablo, Borsan Cavi markasıyla özel tasarım ve zayıf akım kablo üretimi gerçekleştirmektedir. Borkonut şirketiyle inşaat, mimari ve tasarımları kendisine ait konut ve iş merkezi projeleri, kalite ve estetiği ustalıklı birleştiren tasarımları hayata geçiren Borpanel firması ile mutfak, banyo, kapı ve panel üretimi gerçekleştirmektedir. Sağlık alanında ise bölgenin en kapsamlı hastanesi Samsun Medicana Hastanesi ile hizmet vermektedir.

Ülkemiz için yapılan yatırımların yanı sıra, Kırgızistan'da inşaat sektöründe Borsan Construction, Ukrayna'da satış-pazarlama alanında BR Ukraina, doğalgaz ve ısı ekipmanları sektöründe Altma firmalarıyla hizmet vermektedir. Grubun iştirakleri arasında Samsun Serbest Bölge işletmeciliği yer almaktadır.

2017 yılının başında Borled Aydınlatma markası ile aydınlatma ürünleri imalatı ve satışı konusunda ilk adımı atarak, AR-GE ve ÜR-GE çalışmalarına başlamıştır. Borsan Grup bünyesinde önemli bir yere sahip olan Borled Aydınlatma, müşterilerinin istek ve ihtiyaçlarını son teknolojiye sahip üretim ekipmanları, kalite yönetimini destekleyici laboratuvar ve test ekipmanları ile karşılamaktadır.

Bünyesindeki fabrikalarda dünya standartlarına uygun olarak üretim gerçekleştirilen Borsan Grup, profesyonellerin ve son kullanıcıların farklı istek ve ihtiyaçlarına yönelik işlev kolaylığı sağlayan özel çözümler üretmektedir. Grubumuz; modern teknoloji, iş disiplini, eğitilmiş ve deneyimli personeli, çağdaş üretim ekipmanları ile müşteri beklentilerine en iyi şekilde cevap vererek, koşulsuz müşteri memnuniyeti sağlamaktadır.

Sosyal sorumluluk projeleri ve çevreye verdiği önem ile topluma örnek olmayı, uzmanlık alanlarını geliştirerek bulunduğu sektörlerde yeni ufuklar açmayı hedeflemektedir.

Her zaman daha ileriye, daha iyiye yönelik gelecek vizyonuyla, global dünyada yerini alan Borsan Grup, birçok alanda daha büyük yatırımlara imza atacaktır.

Borsan Group, one of the largest groups in Turkey, continues to grow with sure steps every day while leaving proudly its 35rd year behind in the sector.

Borsan Group, with its subsidiaries; produces in international quality standards and exports more than 50% of its production to 75 countries in 4 continents and is the market leader in some of the exported countries by its own brand.

Borsan Group companies, which are listed in Turkey's top 500 industrial enterprises and exporting companies, employs more than 1000 people.

Borsan Group has Borsan Kablo, Yılka Kablo, Borsan Cavi, Borkonut, Borpanel, Medicana Hospital, Borsan Group produces copper cable under Borsan Cable brand, aluminum conductor & cable under Yılka Kablo brand, special and low current cable production under Borsan Cavi brand. Borkonut Construction company is expert about residential and business center projects which has own construction, architecture and design. Borpanel company that produces kitchens, bathrooms, doors and panels with its designs, which combine quality and aesthetics with mastery. In the health field, the most comprehensive hospital in the region is provided with Samsun Medicana Hospital.

Apart from the investments made for its country, Borsan Construction services in Kyrgyzstan, BR Ukraina in the field of sales-marketing in Ukraine and Altma in the sector of natural gas and heat equipments. Samsun Free Zone Management is also among the Group's subsidiaries.

At the beginning of 2017, Borled started to work on R&D and P&D by making the first steps in manufacturing and selling lighting products under Borled Lighting brand. Borled has been a brand winner in the Group with manufacturing identity, high-tech production equipment, laboratory and test areas supporting quality management.

Borsan Group, which has been producing in accordance with the world standards, has been providing special solutions to professionals and end users for their different requests and needs. With its modern technology, work discipline, trained and experienced personnel, contemporary manufacturing equipment, our group responds to customer requests at the best level. From now onward, Borsan Group will continue creating new values and growing together with its employees, customers and business partners by making no concessions on these principles.

Borsan Group aimed to open up new horizons in the its target sectors with social responsibility projects and the importance given to the environment.

Borsan Group will always be in the global arena with its future vision for better and better, make big investments in many sectors.

Borled Aydınlatma, yurt içi ve uluslararası aydınlatma sektöründe sürdürülebilir büyüme vizyonu ile yatırımlarına devam eden Borsan Grup'un bünyesinde faaliyet göstermektedir. 2017 yılı itibari ile LED'li aydınlatma ürün imalatında faaliyete geçen Borled Aydınlatma, modern teknoloji ve Borsan Grup'un tecrübesi ile sektörde liderliğe yükselmeyi hedeflemektedir.

Samsun Organize Sanayi Bölgesi içerisinde bulunan, 15.000m²'lik kapalı alanda üretim ve ürün tasarımları yapan Borled Aydınlatma, İstanbul Perpa'da bulunan satış ve pazarlama departmanları ile faaliyetlerini sürdürmektedir. Tecrübeli ve alanında uzman AR-GE, üretim, satış ve pazarlama ekipleriyle, paydaşlarının ihtiyaç duyacağı tüm gereksinimleri karşılamaktadır.

Dünyada süregelen teknolojik gelişmeler ışığında, Borled Aydınlatma olarak ürün gruplarında dayanıklılığı, verimliliği ve tasarrufu en üst düzeye çıkarmaktadır. Benimsediği toplam kalite yönetimi anlayışı sayesinde, müşteri memnuniyetini her zaman ön planda tutmaktadır.

TSE, CE, RoHS kalite belgelerine sahip ürünleri ile; konut, okul, hastane, ofis, AVM, endüstriyel tesisler, kamu kuruluşları gibi alanlarda hizmet vermektedir. Bünyesinde bulunan test laboratuvarları, makine parkuru ve uzman kadrosu ile daha fazla alana hizmet vermek için çalışmalarını sürdürmektedir.

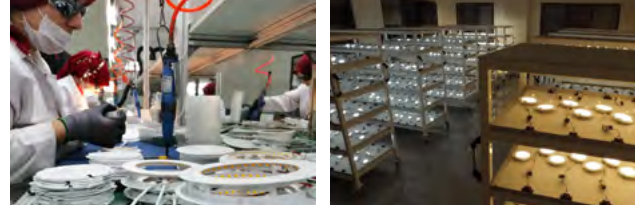

Borled Lighting, which has 15.000 m² closed area for production and product design located in Samsun Organize Sanayi Bölgesi, continues sales-marketing activities with sales office in Perpa, Istanbul. With its experienced and field-trained R&D, production, sales and marketing teams, it meets all the requirements that our partners need.

In the light of the technological developments in the world, we as Borled Lighting, increase the durability, productivity and savings of our product groups to the highest level. We give top priority to our partners contentment with the understanding of total quality management that we have adopted as a company.

We are proud to serve with our TSE, CE, RoHS certified quality products in feilds of residential, school, hospital, office, shopping mall, industrial facilities, public institutions etc.

Borled Lighting Laboratory is providing us to design high quality products under any circumstances. With our expert team and modern technology, we keep our product designs and quality at top level by determining both the mathematical and positive affect of light on human physiology.



Borled Aydınlatma Laboratuvarı, her koşulda üstün niteliklere sahip aydınlatma ekipmanlarının tasarımına olanak sağlamaktadır. Uzman ekibi ve modern teknolojisi sayesinde, ışığın hem matematiksel hem de insan fizyolojisini olumlu etkileyecek özelliklerini belirleyerek, tasarımları ve kalitesini her zaman en üst seviyede sunmaktadır.

Borled Aydınlatma Laboratuvarı, iç ve dış mekân aydınlatması ile ilgili TS EN 60598-1 (Aydınlatma Armatürleri Güvenlik Gereksinimleri) standardına uygun olarak ölçümler gerçekleştirmektedir. Ürünlerin güvenlik testleri, armatür ve lambaların fotometrik değerleri, elektriksel, kimyasal ve fiziksel özelliklerinin ölçümleri yapılmakta olup, cihazlarda yapılan periyodik ara kontrol ve kalibrasyonlar sayesinde ürün kalitesi en üst seviyede tutulmaktadır.



We are proud to serve with our TSE, CE, Rohs certified quality products in feilds of residential, school, hospital, office, shopping mall, industrial facilities, public institutions etc.

Our Borled Lighting Laboratory allow us to make measurements in accordance with TS EN 60598-1 (Lighting Luminaires Safety Requirements) standard for indoor and outdoor lighting. Our products safety tests, photometric values of armatures and lamps, electrical, chemical and physical properties are being tested regularly. With periodic controls and calibrations of our devices we keep our products quality and reliability at the top.



Cihazlarımız

Gonyofotometri Cihazı (Işık Ölçer Küre)

Armatür tasarım sürecinde, ışık dağılım eğrilerini çıkarmakta, toplam lümen ve kamaşma değerlerini ölçmekte, ISOLUX-ISOCANDELA diyagramlarını vermektedir. 2 m ve 30 cm çapındaki Ulbricht küreleri ile ürünlere ait spektral ve tayfsal ölçümler, CCT (Benzer Renk Sıcaklığı), CRI (Renksel Geri Verim İndisi), dalga boyu, renk oranları ve chromacity ölçümleri yapılmaktadır.

Equipments

Goniophotometer (Light Meter Sphere)

In design process, it helps us extracting the light distribution curves, measuring the total lumen and dazzle values, and giving ISOLUX-ISOCANDELA diagrams. Spectral measurements, CCT, CRI, Wavelength, Color ratios and Chromacity measurements of products are being performed by 2 m and 30 cm dia Ulbricht spheres.



Programlanabilir Simülasyon Ortam Sıcaklığı Şok Test Cihazı

Kısa süre içerisinde son derece yüksek ve düşük sıcaklık arasındaki çevre değişikliklerine dayanıklı malzeme yapısını yada kompozit malzemelerin yeteneğini test etmek için kullanılır. Cihaz sayesinde sıcaklık ve çevresel koşulların değişmesiyle daralma ve genişlemeden kaynaklanan fiziksel ve kimyasal sonuçlar gözlemlenebilir.

Programmable Simulation Ambient Temperature Shock Tester

It is used to test materials structure resistance to environmental changes between extremely high and low temperatures in a short time and ability of composite materials on the side. By means of the device, the physical and chemical consequences of narrowing and enlargement can be observed by changing the temperature and environmental conditions.

Yaşlandırma Fırını

Test ürününün belirlenmiş sıcaklık altında çalışarak elektriksel, fiziksel ve kimyasal olarak değişimlerinin gözlemlendiği, üründe zaman içerisinde oluşabilecek arızaların önceden belirlenmesini sağlayan cihazdır.

Aging Furnace

It is a device that allows electrical, physical and chemical changes of the test product to be observed at a speci-fied temperature and help us finding out failures before occurring over time.



Sarsma ve Taşıma Simülasyonu

Test ürününün hareketli bir taban üzerinde, belli frekansta hareket ettirilmesi ve sarsılması ile oluşacak etkilerin gözlemlenmesini sağlar.

Vibration Resistance

This device allows us to test the product by moving and vibrating it on a moving base to observe the effects under certain frequency.

Korozyon Test ve IP Cihazı

Test ürününde kullanılan kaplamaların aşınma dirençlerini ve zamanla oluşabilecek korozyon etkisini ölçmeyi sağlayan ekipmandır.

Corrosion Testing Device

It is the equipment which enables us to measure the corrosion resistance of the coatings used in the tested pro-duct and the corrosion effect that might occur over time.



Yapılan deneyler sonucunda, standartlara uygun olarak hazırlanan ölçüm sonuçları rapor haline getirilerek, müşterilerimize sunulur.

As a result of the tests conducted, the measured test results that prepared in accordance with the standards are reported to our customers in order to meet their demands.

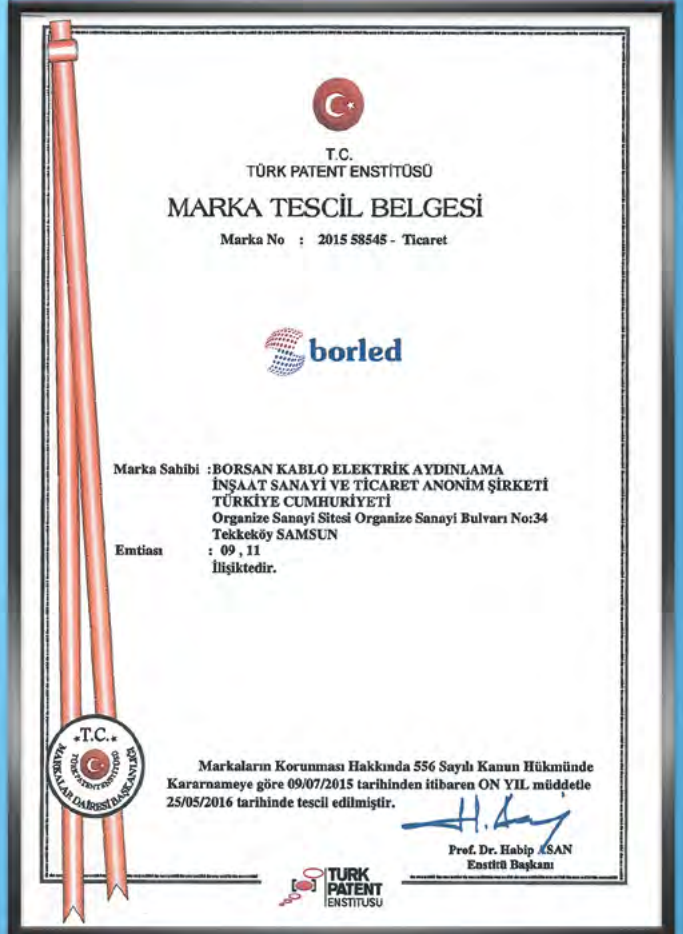



BORSAN
AR-GE



DÜNYA ÇAPINDA KALİTEYE SAHİP KATMA DEĞERLİ ÜRÜNLERİN AR-GE MERKEZİ



AR-GE MERKEZİ BELGESİ

Sanayi ve Teknoloji Bakanlığı tarafından,

Borsan Kablo Elektrik Aydınlatma İnşaat San. ve Ticaret A.Ş.
5746 Sayılı Araştırma ve Geliştirme Faaliyetlerinin Desteklenmesi Hakkında Kanun
kapsamında sağlanan teşvik ve muafiyetlerden yararlanmak üzere bu belge verilmiştir.

Mustafa VARANK
Bakan

Borsan Ar-Ge Merkezi

Borsan R&D Center



Borsan faaliyet gösterdiği tüm sektörlerde bir dünya markası vizyonuna ulaşabilmek için Ar-Ge faaliyetlerine sürekli yatırım yapmaktadır. Sanayi ve Teknoloji Bakanlığı tarafından 2018 yılında tescil edilen Borsan Ar-Ge Merkezi, Samsun'da üçüncü, Türkiye'de ise 1055'inci tescil edilen Ar-Ge merkezidir.

350m² alanda kurulu bulunan ve Karadeniz'in en büyük Aydınlatma Laboratuvarının yanı sıra, Yangın test Laboratuvarı, Metal ve Polimer Laboratuvarı gibi bölümlerde özel ekipman, cihazlar ve test programlarının kullanıldığı Borsan Ar-Ge Merkezi'nde, yirminin üzerinde Ar-Ge mühendisi ve araştırmacı personel görev yapmaktadır.

Borsan, uzun vadeli yaklaşımı ve kalitesiyle fark yaratan ve stratejik yatırımlarıyla güvenle büyüyen, geleceğe gururla taşınan Türkiye'nin lider markalardan biri olmaya daima devam edecektir.

Borsan continuously and consistently invests in R&D activities in all the industries it is active in order to achieve a world brand vision. Registered by the Ministry of Industry and Technology in 2018, Borsan R&D Center is the 3rd registered R&D center in Samsun and 1055th in Turkey.

Borsan R&D Center is built on an area of 350m² and it not only features the largest Illumination Laboratory in all the Black Sea region, but Fire Test Laboratory, Metal and Polymer Laboratory as well. In those labs and departments, where special equipment, devices, gears and testing programs are employed, over 20 R&D engineers and research specialist personnel are working day and night.

Borsan will always be a proud brand growing and leading the way in Turkey with its long-term approach, quality of the highest order aimed at making a difference and strategic investments.



Led Teknolojisini Borled Farkıyla Keşfet



SIVA ALTI ve SIVA ÜSTÜ ARMATÜRLER <i>Recessed and Surface Mounted Luminaires</i>	15 – 29
LINEER, LED ETANJ ve BANT ARMATÜRLER <i>Linear, Led Waterproof and Bant Armatures</i>	30 – 41
LED GLOP ARMATÜRLER <i>Led Ceiling Luminaires</i>	42 – 50
LED PROJEKTÖRLER VE RAY SPOT <i>Led Projectors & Rail Spot</i>	51 – 54
LED SOKAK AYDINLATMA ARMATÜRÜ <i>Led Street Lighting Fixture</i>	55
ŞERİT LED ve TRAFOLARI <i>Led Strip and Transformers</i>	56
TAVAN ARMATÜRLERİ <i>Ceiling Fixture</i>	57 – 66
APLİK ARMATÜRLER <i>Wall Luminare</i>	67 – 70
SİGORTA KUTULARI <i>Fuse Boxes</i>	71 – 75
TERMOPLASTİK BUAT, DÜBEL VE ALÇIPAN KASA <i>Thermoplastic Junction Box, Dowels and Drywall Case</i>	76
GRUP PRİZLER <i>Group Sockets</i>	77 – 81
AKSESUARLAR <i>Accessories</i>	82
TESİSAT MALZEMELERİ <i>Installation material</i>	83 – 85
TEKNİK BİLGİLER <i>Technical Data</i>	87 – 96



Teknik Özellikler:

Technical Specifications

Gövde: Alüminyum
Body: Aluminum

Gövde Renkleri: Beyaz
Body Colors: White

Difüzör: PC
Diffuser: PC

LED Chip: Menşei Taiwan
LED Chip: Origin Taiwan

Sürücü: Menşei Taiwan
Driver: Origin Taiwan

Renksel Geri Verim: 80
CRI: 80

Koruma Sınıfı: 20
IP: 20



LED

IP20

YERLİ ÜRETİM

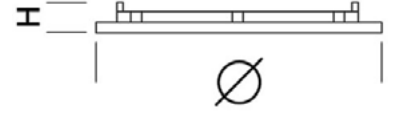

Ürün Kodu Product Code	Güç (W) Power	Renk Sıcaklığı (K) Color Temperature	Işık Akısı (Lm) Luminous Flux	Boyutlar (ØxH) mm Dimensions	Yükseklik (mm) Height	Koli Adeti Quantity in Carton	Fiyat Price
BL-S1-2001	3W	3000 K	165	82x14	73	48	\$3,50
BL-S1-2002	3W	4000 K	165	82x14	73	48	\$3,50
BL-S1-2003	3W	6500 K	165	82x14	73	48	\$3,50
BL-S1-2004	6W	3000 K	390	118x14	110	48	\$4,90
BL-S1-2005	6W	4000 K	390	118x14	110	48	\$4,90
BL-S1-2006	6W	6500 K	390	118x14	110	48	\$4,90
BL-S1-2007	9W	3000 K	630	145x14	135	24	\$6,40
BL-S1-2008	9W	4000 K	630	145x14	135	24	\$6,40
BL-S1-2009	9W	6500 K	630	145x14	135	24	\$6,40
BL-S1-2010	12W	3000 K	960	168x14	155	24	\$7,40
BL-S1-2011	12W	4000 K	960	168x14	155	24	\$7,40
BL-S1-2012	12W	6500 K	960	168x14	155	24	\$7,40
BL-S1-2013	15W	3000 K	1200	190x14	175	24	\$8,40
BL-S1-2014	15W	4000 K	1200	190x14	175	24	\$8,40
BL-S1-2015	15W	6500 K	1200	190x14	175	24	\$8,40
BL-S1-2016	18W	3000 K	1440	225 x 15	210	24	\$9,00
BL-S1-2017	18W	4000 K	1440	225 x 15	210	24	\$9,00
BL-S1-2018	18W	6500 K	1440	225 x 15	210	24	\$9,00
BL-S1-2019	24W	3000 K	2040	300 x 15	285	24	\$14,90
BL-S1-2020	24W	4000 K	2040	300 x 15	285	24	\$14,90
BL-S1-2021	24W	6500 K	2040	300 x 15	285	24	\$14,90

Kare Slim Led Armatür

Square Slim Led Armature



Teknik Özellikler:

Technical Specifications

Gövde: Alüminyum
Body: Aluminum

Gövde Renkleri: Beyaz
Body Colors: White

Difüzör: PC
Diffuser: PC

LED Chip: Menşei Taiwan
LED Chip: Origin Taiwan

Sürücü: Menşei Taiwan
Driver: Origin Taiwan

Renksel Geri Verim: 80
CRI: 80

Koruma Sınıfı: 20
IP: 20



LED

IP20

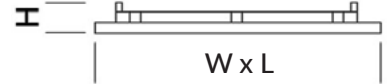

Ürün Kodu Product Code	Güç (W) Power	Renk Sıcaklığı (K) Color Temperature	Işık Akısı (Lm) Luminous Flux	Boyutlar(WxLxH) mm Dimensions	 (mm)	Koli Adeti Quantity in Carton	Fiyat Price
BL-S1-2022	18W	3000 K	1350	225 x 225 x 15	210 x 210	24	\$8,80
BL-S1-2023	18W	4000 K	1350	225 x 225 x 15	210 x 210	24	\$8,80
BL-S1-2024	18W	6500 K	1350	225 x 225 x 15	210 x 210	24	\$8,80
BL-S1-2025	24W	3000 K	1920	300 x 300 x 15	280 x 280	24	\$14,70
BL-S1-2026	24W	4000 K	1920	300 x 300 x 15	280 x 280	24	\$14,70
BL-S1-2027	24W	6500 K	1920	300 x 300 x 15	280 x 280	24	\$14,70



Teknik Özellikler:

Technical Specifications

Gövde: Alüminyum
Body: Aluminum

Gövde Renkleri: Beyaz
Body Colors: White

Difüzör: Opal Polikarbon
Diffuser: Opal Polycarbon

LED Chip: Samsung
LED Chip: Samsung

Sürücü: Menşei Taiwan
Driver: Origin Taiwan

Renksel Geri Verim: 80
CRI: 80

Koruma Sınıfı: 20
IP: 20

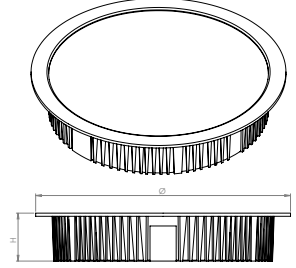

LED

IP20

YERLİ ÜRETİM

Ürün Kodu Product Code	Güç (W) Power	Renk Sıcaklığı (K) Color Temperature	Işık Akısı (Lm) Luminous Flux	Boyutlar (ØxH) mm Dimensions	(mm)	Koli Adeti Quantity in Carton	Fiyat Price
BL-BD-0001	8W	3000 K	600	90 x 25	65	36	\$14,90
BL-BD-0002	8W	4000 K	600	90 x 25	65	36	\$14,90
BL-BD-0003	8W	6500 K	600	90 x 25	65	36	\$14,90
BL-BD-0004	12W	3000 K	1200	120 x 25	100	36	\$18,30
BL-BD-0005	12W	4000 K	1200	120 x 25	100	36	\$18,30
BL-BD-0006	12W	6500 K	1200	120 x 25	100	36	\$18,30
BL-BD-0007	18W	3000 K	1800	145 x 25	130	24	\$21,50
BL-BD-0008	18W	4000 K	1800	145 x 25	130	24	\$21,50
BL-BD-0009	18W	6500 K	1800	145 x 25	130	24	\$21,50
BL-BD-0010	24W	3000 K	2400	170 x 25	150	24	\$23,40
BL-BD-0011	24W	4000 K	2400	170 x 25	150	24	\$23,40
BL-BD-0012	24W	6500 K	2400	170 x 25	150	24	\$23,40

Kare Backlight Downlight Led Armatür

Square Backlight Downlight Led Armature



Teknik Özellikler: Technical Specifications



Gövde: Alüminyum

Body: Aluminum

Gövde Renkleri: Beyaz

Body Colors: White

Difüzör: Opal Polikarbon

Diffuser: Opal Polycarbon

LED Chip: Samsung

LED Chip: Samsung

Sürücü: Menşei Taiwan

Driver: Origin Taiwan

Renksel Geri Verim: 80

CRI: 80

Koruma Sınıfı: 20

IP: 20

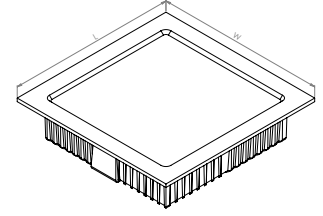

LED

IP20

YERLİ ÜRETİM

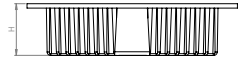

Ürün Kodu Product Code	Güç (W) Power	Renk Sıcaklığı (K) Color Temperature	Işık Akısı (Lm) Luminous Flux	Boyutlar(WxLxH) mm Dimensions	Ø (mm)	Koli Adeti Quantity in Carton	Fiyat Price
BL-BD-1001	8W	3000 K	600	90 x 90 x 25	70 x 70	36	\$16,20
BL-BD-1002	8W	4000 K	600	90 x 90 x 25	70 x 70	36	\$16,20
BL-BD-1003	8W	6500 K	600	90 x 90 x 25	70 x 70	36	\$16,20
BL-BD-1004	12W	3000 K	1200	120 x 120 x 25	100 x 100	36	\$22,20
BL-BD-1005	12W	4000 K	1200	120 x 120 x 25	100 x 100	36	\$22,20
BL-BD-1006	12W	6500 K	1200	120 x 120 x 25	100 x 100	36	\$22,20
BL-BD-1007	18W	3000 K	1800	120 x 120 x 25	100 x 100	24	\$23,40
BL-BD-1008	18W	4000 K	1800	120 x 120 x 25	100 x 100	24	\$23,40
BL-BD-1009	18W	6500 K	1800	120 x 120 x 25	100 x 100	24	\$23,40
BL-BD-1010	24W	3000 K	2400	170 x 170 x 25	150 x 150	24	\$25,10
BL-BD-1011	24W	4000 K	2400	170 x 170 x 25	150 x 150	24	\$25,10
BL-BD-1012	24W	6500 K	2400	170 x 170 x 25	150 x 150	24	\$25,10



Teknik Özellikler:

Technical Specifications

Gövde: ABS
Body: ABS

Gövde Renkleri: Beyaz
Body Colors: White

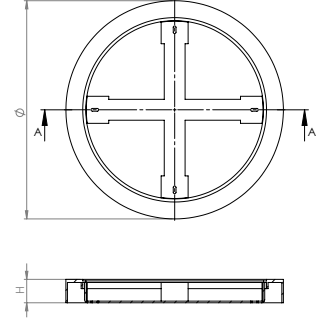
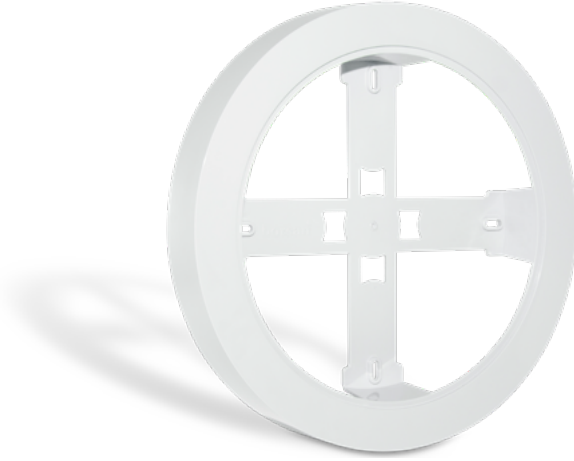

Ürün Kodu Product Code	Güç (W) Power	Ürün Adı Product Name	Boyutlar (ØxH) mm Dimensions	Koli Adeti Quantity in Cartor.	Fiyat Price
BR-1519	18W	Plastik Sıva Üstü Yuvarlak Çerçeve	275 x 38	36	₺25,60
BR-1522	24W	Plastik Sıva Üstü Yuvarlak Çerçeve	355 x 38	34	₺32,80

Kare Slim Led Sıva Üstü Çerçeve

Square Slim Led Surface Mounted Frame

Teknik Özellikler:

Technical Specifications

Gövde: ABS
Body: ABS

Gövde Renkleri: Beyaz
Body Colors: White

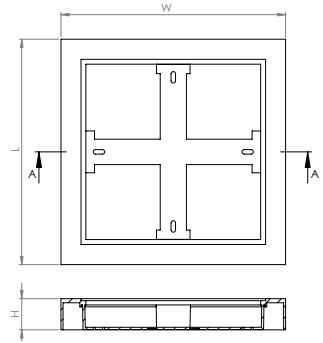
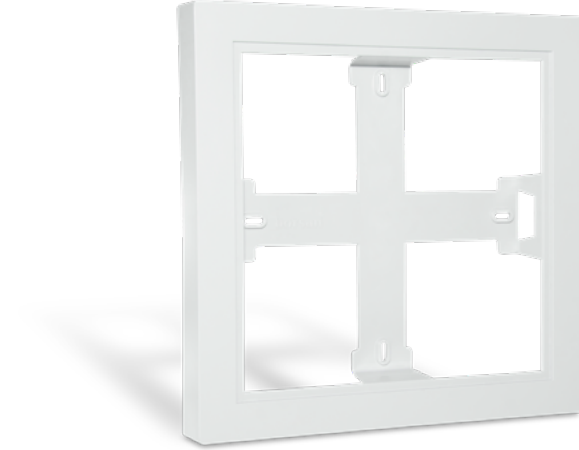

Ürün Kodu Product Code	Güç (W) Power	Ürün Adı Product Name	Boyutlar(WxLxH)mm Dimensions	Koli Adeti Quantity in Cartor.	Fiyat Price
BR-1521	18W	Plastik Sıva Üstü Kare Çerçeve	275 x 275 x 38	36	₺28,60
BR-1520	24W	Plastik Sıva Üstü Kare Çerçeve	355 x 355 x 38	34	₺40,80

Led Sıva Altı Downlight Armatür

Downlight Circular Led Armature

Teknik Özellikler:

Technical Specifications

Gövde: Alüminyum

Body: Aluminum

Gövde Renkleri: Beyaz

Body Colors: White

Difüzör: PC

Diffuser: PC

LED Chip: Menşei Taiwan

LED Chip: Origin Taiwan

Sürücü: Menşei Taiwan

Driver: Origin Taiwan

Renkssel Geri Verim: 80

CRI: 80

Koruma Sınıfı: 40

IP: 40

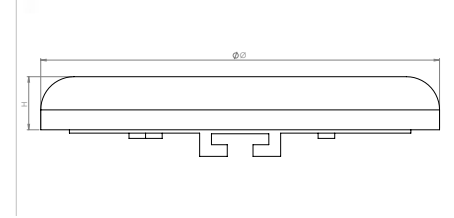

LED

IP40

YERLİ
ÜRETİM

Ürün Kodu Product Code	Güç (W) Power	Renk Sıcaklığı (K) Color Temperature	Işık Akısı (Lm) Luminous Flux	Boyutlar (ØxH) mm Dimensions	 (mm)	Koli Adeti Quantity in Carton	Fiyat Price
BL-D1-0001	9W	3000 K	810	Ø93 x 25	75	36	\$7,60
BL-D1-0002	9W	4000 K	810	Ø93 x 25	75	36	\$7,60
BL-D1-0003	9W	6500 K	810	Ø93 x 25	75	36	\$7,60
BL-D1-0004	18W	3000 K	1620	Ø123 x 25	90 - 105	24	\$10,30
BL-D1-0005	18W	4000 K	1620	Ø123 x 25	90 - 105	24	\$10,30
BL-D1-0006	18W	6500 K	1620	Ø123 x 25	90 - 105	24	\$10,30
BL-D1-0007	24W	3000 K	2160	Ø175 x 25	90 - 150	16	\$14,20
BL-D1-0008	24W	4000 K	2160	Ø175 x 25	90 - 150	16	\$14,20
BL-D1-0009	24W	6500 K	2160	Ø175 x 25	90 - 150	16	\$14,20
BL-D1-0010	36W	3000 K	3240	Ø228 x 25	90 - 210	12	\$22,40
BL-D1-0011	36W	4000 K	3240	Ø228 x 25	90 - 210	12	\$22,40
BL-D1-0012	36W	6500 K	3240	Ø228 x 25	90 - 210	12	\$22,40

Teknik Özellikler:

Technical Specifications

Gövde: Alüminyum

Body: Aluminum

Gövde Renkleri: Beyaz

Body Colors: White

Difüzör: PC

Diffuser: PC

LED Chip: Menşei Taiwan

LED Chip: Origin Taiwan

Sürücü: Menşei Taiwan

Driver: Origin Taiwan

Renksel Geri Verim: 80

CRI: 80

Koruma Sınıfı: 20

IP: 20



LED

IP20

YERLİ ÜRETİM

60 x 60 Slim Led Armatür 40W

Ürün Kodu Product Code	Güç (W) Power	Renk Sıcaklığı (K) Color Temperature	Işık Akısı (Lm) Luminous Flux	Boyutlar(WxLxH)mm Dimensions	 (mm)	Koli Adeti Quantity in Carton	Fiyat Price
BL-O5-2001	40W	3000 K	3600	595 x 595 x 7.5	580 x 580	12	\$39,80
BL-O5-2002	40W	4000 K	3600	595 x 595 x 7.5	580 x 580	12	\$39,80
BL-O5-2003	40W	6500 K	3600	595 x 595 x 7.5	580 x 580	12	\$39,80

30 x 30 Slim Led armatür 24W

Ürün Kodu Product Code	Güç (W) Power	Renk Sıcaklığı (K) Color Temperature	Işık Akısı (Lm) Luminous Flux	Boyutlar(WxLxH)mm Dimensions	 (mm)	Koli Adeti Quantity in Carton	Fiyat Price
BL-O8-0001	24W	3000 K	1600	295x295x7.5	270 x 270	12	\$26,70
BL-O8-0002	24W	4000 K	1600	295x295x7.5	270 x 270	12	\$26,70
BL-O8-0003	24W	6500 K	1600	295x295x7.5	270 x 270	12	\$26,70

30x60 - 30x120 Slim Led Armatür

30x60 - 30x120 Slim Led Armature

Teknik Özellikler:

Technical Specifications

Gövde: Alüminyum

Body: Aluminum

Gövde Renkleri: Beyaz

Body Colors: White

Difüzör: PC

Diffuser: PC

LED Chip: Menşei Taiwan

LED Chip: Origin Taiwan

Sürücü: Menşei Taiwan

Driver: Origin Taiwan

Renksel Geri Verim: 80

CRI: 80

Koruma Sınıfı: 20

IP: 20

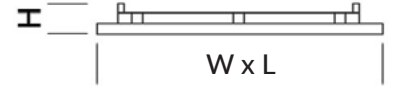

LED

IP20

YERLİ ÜRETİM

30 x 60 Slim Led armatür 24W

Ürün Kodu Product Code	Güç (W) Power	Renk Sıcaklığı (K) Color Temperature	Işık Akısı (Lm) Luminous Flux	Boyutlar(WxLxH)mm Dimensions	 (mm)	Koli Adeti Quantity in Carton	Fiyat Price
BL-O6-2001	24W	3000 K	1600	295 x 595 x 7.5	270 x 580	12	\$30,10
BL-O6-2002	24W	4000 K	1600	295 x 595 x 7.5	270 x 580	12	\$30,10
BL-O6-2003	24W	6500 K	1600	295 x 595 x 7.5	270 x 580	12	\$30,10

30 x 120 Slim Led Armatür 48W

Ürün Kodu Product Code	Güç (W) Power	Renk Sıcaklığı (K) Color Temperature	Işık Akısı (Lm) Luminous Flux	Boyutlar(WxLxH)mm Dimensions	 (mm)	Koli Adeti Quantity in Carton	Fiyat Price
BL-O7-2001	48W	3000 K	3840	295 x 1195 x 7.5	270x1180	12	\$53,70
BL-O7-2002	48W	4000 K	3840	295 x 1195 x 7.5	270x1180	12	\$53,70
BL-O7-2003	48W	6500 K	3840	295 x 1195 x 7.5	270x1180	12	\$53,70

Teknik Özellikler:

Technical Specifications

Gövde: DKP Sac
Body: DKP Metal Sheet

Gövde Renkleri: Beyaz
Body Colors: White

Difüzör: PC
Diffuser: PC

LED Chip: Samsung/Osram
LED Chip: Samsung/Osram

Sürücü: Osram/Eaglerise/Tridonic
Driver: Osram/Eaglerise/Tridonic

Renksel Geri Verim: 80
CRI: 80

Koruma Sınıfı: 20
IP: 20

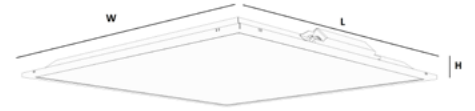

LED

IP20



Ürün Kodu Product Code	Güç (W) Power	Renk Sıcaklığı (K) Color Temperature	Işık Akısı (Lm) Luminous Flux	Boyutlar(WxLxH)mm Dimensions	Koli Adeti Quantity in Carton	Fiyat Price
BLT-O2-2005	12W	4000 K	1575	300 x 300 x 65	8	\$41,60
BLT-O2-2006	12W	6500 K	1575	300 x 300 x 65	8	\$41,60
BLT-O6-0002	24W	4000 K	2750	300 x 600 x 65	4	\$49,50
BLT-O6-0003	24W	6500 K	2750	300 x 600 x 65	4	\$49,50
BLT-O2-2002	36W	4000 K	4500	600 x 600 x 65	2	\$54,10
BLT-O2-2003	36W	6500 K	4500	600 x 600 x 65	2	\$54,10

Led Opal Lensli Backlight Sıva Üstü Armatür

Surface Mounted Slim Led Fixture - Opal Lens



Teknik Özellikler:

Technical Specifications

Gövde: DKP Sac
Body: DKP Metal Sheet

Gövde Renkleri: Beyaz
Body Colors: White

Difüzör: PC
Diffuser: PC

LED Chip: Samsung/Osram
LED Chip: Samsung/Osram

Sürücü: Osram/Eaglerise/Tridonic
Driver: Osram/Eaglerise/Tridonic

Renksel Geri Verim: 80
CRI: 80

Koruma Sınıfı: 20
IP: 20

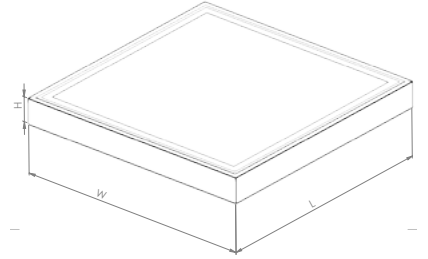

LED

IP20



Ürün Kodu Product Code	Güç (W) Power	Renk Sıcaklığı (K) Color Temperature	Işık Akısı (Lm) Luminous Flux	Boyutlar (WxLxH) mm Dimensions	Koli Adeti Quantity in Carton	Fiyat Price
BLT-05-2005	12W	4000 K	1575	300 x 300 x 65	8	\$47,30
BLT-05-2006	12W	6500 K	1575	300 x 300 x 65	8	\$47,30
BLT-06-1002	24W	4000 K	2750	300 x 600 x 65	4	\$53,90
BLT-06-1003	24W	6500 K	2750	300 x 600 x 65	4	\$53,90
BLT-05-2008	36W	4000 K	4500	600 x 600 x 65	2	\$59,30
BLT-05-2009	36W	6500 K	4500	600 x 600 x 65	2	\$59,30



Teknik Özellikler:

Technical Specifications

Gövde: DKP Sac
Body: DKP Metal Sheet

Gövde Renkleri: Beyaz
Body Colors: White

Difüzör: PC
Diffuser: PC

LED Chip: Menşei Taiwan
LED Chip: Origin Taiwan

Sürücü: Menşei Taiwan
Driver: Origin Taiwan

Renksel Geri Verim: 80
CRI: 80

Koruma Sınıfı: 20
IP: 20



LED

IP20



Ürün Kodu Product Code	Güç (W) Power	Renk Sıcaklığı (K) Color Temperature	Işık Akısı (Lm) Luminous Flux	Boyutlar (WxLxH) mm Dimensions	Koli Adeti Quantity in Carton	Fiyat Price
BL-O2-2011	40W	3000 K	4400	595 x 595 x 35	2	\$39,60
BL-O2-2012	40W	4000 K	4400	595 x 595 x 35	2	\$39,60
BL-O2-2013	40W	6500 K	4400	595 x 595 x 35	2	\$39,60

Led Opal Lensli Backlight Clip-In Armatür

Led Backlight Clip-In Armature - Opal Lens



Teknik Özellikler:

Technical Specifications

Gövde: DKP Sac

Body: DKP Metal Sheet

Gövde Renkleri: Beyaz

Body Colors: White

Difüzör: PC

Diffuser: PC

LED Chip: Samsung/Osram

LED Chip: Samsung/Osram

Sürücü: Osram/Eaglerise/Tridonic

Driver: Osram/Eaglerise/Tridonic

Renksel Geri Verim: 80

CRI: 80

Koruma Sınıfı: 20

IP: 20



LED

IP20



Ürün Kodu Product Code	Güç (W) Power	Renk Sıcaklığı (K) Color Temperature	Işık Akısı (Lm) Luminous Flux	Boyutlar (WxLxH) mm Dimensions	Koli Adeti Quantity in Carton	Fiyat Price
BLT-O2-3011	12W	4000 K	1575	300 x 300 x 65	8	\$49,50
BLT-O2-3012	12W	6500 K	1575	300 x 300 x 65	8	\$49,50
BLT-O6-2002	24W	4000 K	2750	300 x 600 x 65	4	\$57,90
BLT-O6-2003	24W	6500 K	2750	300 x 600 x 65	4	\$57,90
BLT-O2-2008	36W	4000 K	4500	600 x 600 x 65	2	\$62,90
BLT-O2-2009	36W	6500 K	4500	600 x 600 x 65	2	\$62,90



Teknik Özellikler:

Technical Specifications

Gövde: DKP Sac
Body: DKP Metal Sheet

Gövde Renkleri: Beyaz
Body Colors: White

Difüzör: Temperli Cam
Diffuser: Tempered Glass

LED Chip: Samsung/Osram
LED Chip: Samsung/Osram

Sürücü: Osram/Eaglerise/Tridonic
Driver: Osram/Eaglerise/Tridonic

Renksel Geri Verim: 80
CRI: 80

Koruma Sınıfı: 65
IP: 65

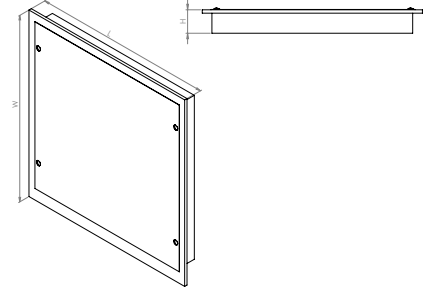
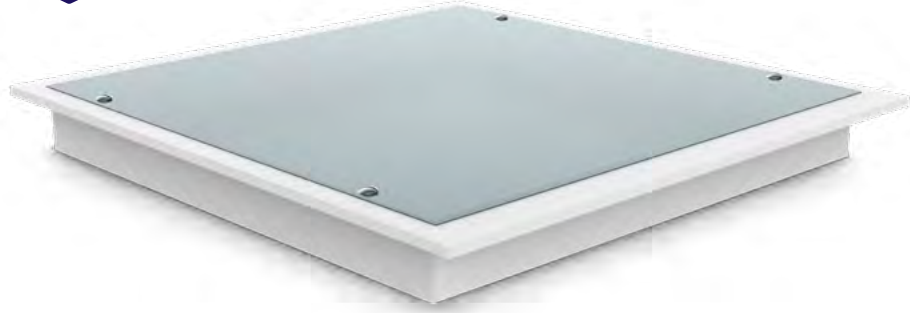

LED

IP65

YERLİ ÜRETİM

Ürün Kodu Product Code	Güç (W) Power	Renk Sıcaklığı (K) Color Temperature	Işık Akısı (Lm) Luminous Flux	Boyutlar(WxLxH)mm Dimensions	Koli Adeti Quantity in Carton	Fiyat Price
BL-O2-3001	15W	4000 K	2160	300 x 300 x 110	1	\$91,10
BL-O2-3002	15W	6500 K	2160	300 x 300 x 110	1	\$91,10
BL-O2-4001	35W	4000 K	4442	600 x 600 x 100	1	\$134,15
BL-O2-4002	35W	6500 K	4442	600 x 600 x 100	1	\$134,15

Led Backlight Steril Ortam Sıva Üstü Armatür

Led Backlight Sterile Ambient Fixture



Teknik Özellikler:

Technical Specifications

Gövde: DKP Sac
Body: DKP Metal Sheet

Gövde Renkleri: Beyaz
Body Colors: White

Difüzör: Temperli Cam
Diffuser: Tempered Glass

LED Chip: Samsung/Osram
LED Chip: Samsung/Osram

Sürücü: Osram/Eaglerise/Tridonic
Driver: Osram/Eaglerise/Tridonic

Renksel Geri Verim: 80
CRI: 80

Koruma Sınıfı: 65
IP: 65

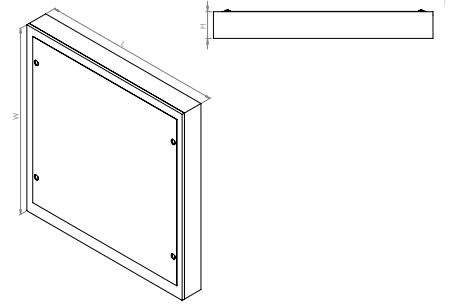

LED

IP65

YERLİ ÜRETİM

Ürün Kodu Product Code	Güç (W) Power	Renk Sıcaklığı (K) Color Temperature	Işık Akısı (Lm) Luminous Flux	Boyutlar(WxLxH)mm Dimensions	Koli Adeti Quantity in Carton	Fiyat Price
BL-O5-3001	15W	4000 K	2160	300 x 300 x 110	1	\$99,75
BL-O5-3002	15W	6500 K	2160	300 x 300 x 110	1	\$99,75
BL-O5-4001	35W	4000 K	4442	600 x 600 x 100	1	\$142,75
BL-O5-4002	35W	6500 K	4442	600 x 600 x 100	1	\$142,75



30x30 Kare Slim Led Sıva Clip-In Çerçeve

30x30 Square Slim Led Downlight Clip-In Frame

Teknik Özellikler:

Technical Specifications

Gövde: DKP Sac
Body: DKP Metal Sheet

Gövde Renkleri: Beyaz
Body Colors: White



Ürün Kodu Product Code	Ürün Adı Product Name	Koli Adeti Quantity in Carton	Fiyat Price
134-0922	DIŞ ÇERÇEVE 30x30 LED SLİM KARE CLIP-IN KASA	24	₺45,20

60x60 Kare Slim Panel Sıva Üstü Çerçeve

60x60 Square Slim Panel Surface Mounted Frame

Teknik Özellikler:

Technical Specifications

Gövde: DKP Sac
Body: DKP Metal Sheet

Gövde Renkleri: Beyaz
Body Colors: White



Ürün Kodu Product Code	Ürün Adı Product Name	Koli Adeti Quantity in Carton	Fiyat Price
134-0963	LED 60X60 SIVA USTU DEMONTE KASA	6	₺45,30

60x60 Kare Slim Panel Clip-In Çerçeve

60x60 Square Slim Panel Clip-In Frame

Teknik Özellikler:

Technical Specifications

Gövde: DKP Sac
Body: DKP Metal Sheet

Gövde Renkleri: Beyaz
Body Colors: White



Ürün Kodu Product Code	Ürün Adı Product Name	Koli Adeti Quantity in Carton	Fiyat Price
134-1005	DIŞ ÇERÇEVE 60x60 CLIP-IN KASA	6	₺42,10

Led Yüksek Tavan Armatür

Led High Ceiling Fixture



Teknik Özellikler:

Technical Specifications



Gövde: Alüminyum
Body: Aluminum

Difüzör: Polikarbon Cam
Diffuser: Polycarbon Glass

LED Chip: Cree Led
LED Chip: Cree Led

Sürücü: Philips
Driver: Philips

Renkset Geri Verim: 80
CRI: 80

Koruma Sınıfı: 54
IP: 54

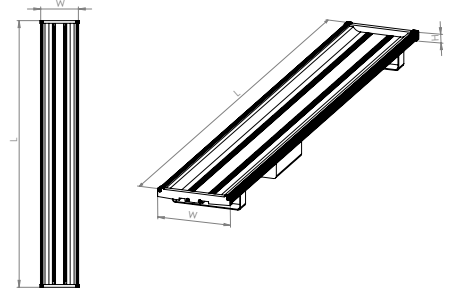

LED

IP54



Ürün Kodu Product Code	Güç (W) Power	Renk Sıcaklığı (K) Color Temperature	Işık Akısı (Lm) Luminous Flux	Boyutlar(WxLxH)mm Dimensions	Koli Adeti Quantity in Carton	Fiyat Price
BL-Y1-0001	42W	3000 K	5846	180 x 630 x 50	1	\$82,50
BL-Y1-0002	42W	4000 K	5846	180 x 630 x 50	1	\$82,50
BL-Y1-0003	42W	6500 K	5846	180 x 630 x 50	1	\$82,50
BL-Y1-0004	85W	3000 K	11791	180 x 1245 x 50	1	\$133,20
BL-Y1-0005	85W	4000 K	11791	180 x 1245 x 50	1	\$133,20
BL-Y1-0006	85W	6500 K	11791	180 x 1245 x 50	1	\$133,20
BL-Y1-0007	105W	3000 K	14566	180 x 1245 x 50	1	\$151,70
BL-Y1-0008	105W	4000 K	14566	180 x 1245 x 50	1	\$151,70
BL-Y1-0009	105W	6500 K	14566	180 x 1245 x 50	1	\$151,70
BL-Y1-0010	125W	3000 K	15717	180 x 1540 x 50	1	\$188,60
BL-Y1-0011	125W	4000 K	15717	180 x 1540 x 50	1	\$188,60
BL-Y1-0012	125W	6500 K	15717	180 x 1540 x 50	1	\$188,60
BL-Y1-0013	150W	3000 K	20681	180 x 1540 x 50	1	\$207,10
BL-Y1-0014	150W	4000 K	20681	180 x 1540 x 50	1	\$207,10
BL-Y1-0015	150W	6500 K	20681	180 x 1540 x 50	1	\$207,10



Teknik Özellikler:

Technical Specifications

Gövde: Alüminyum
Body: Aluminum

Difüzör: Polikarbon Cam
Diffuser: Polycarbon Glass

LED Chip: Menşei Taiwan
LED Chip: Origin Taiwan

Sürücü: Menşei Taiwan
Driver: Origin Taiwan

Renkssel Geri Verim: 80
CRI: 80

Koruma Sınıfı: 54
IP: 54

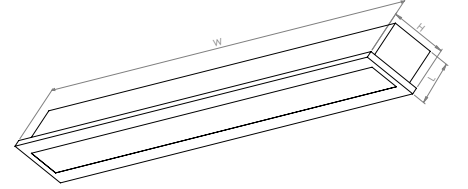
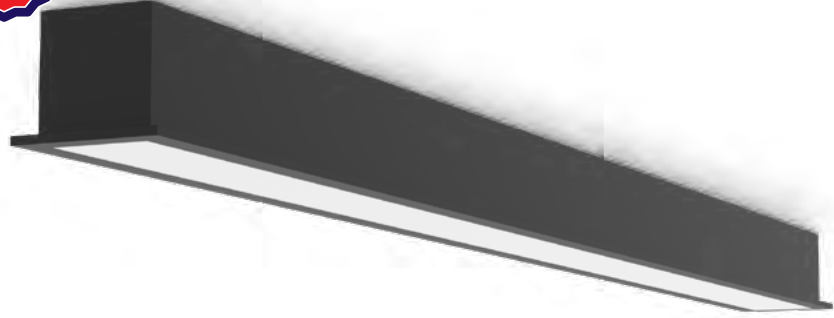

LED

IP54

YERLİ ÜRETİM

Ürün Kodu Product Code	Güç (W) Power	Renk Sıcaklığı (K) Color Temperature	Işık Akısı (Lm) Luminous Flux	Boyutlar(WxLxH)mm Dimensions	Koli Adeti Quantity in Carton	Fiyat Price
BL-L1-1001	15W	4000 K	1800	600 x 90 x 66	1	\$75,50
BL-L1-1002	15W	6500 K	1800	600 x 90 x 66	1	\$75,50
BL-L1-1003	20W	4000 K	2400	600 x 90 x 66	1	\$77,70
BL-L1-1004	20W	6500 K	2400	600 x 90 x 66	1	\$77,70
BL-L1-1005	30W	4000 K	3600	1200 x 90 x 66	1	\$123,60
BL-L1-1006	30W	6500 K	3600	1200 x 90 x 66	1	\$123,60
BL-L1-1007	40W	4000 K	4800	1200 x 90 x 66	1	\$128,20
BL-L1-1008	40W	6500 K	4800	1200 x 90 x 66	1	\$128,20
BL-L1-1009	45W	4000 K	5400	1500 x 90 x 66	1	\$147,20
BL-L1-1010	45W	6500 K	5400	1500 x 90 x 66	1	\$147,20
BL-L1-1011	50W	4000 K	6000	1500 x 90 x 66	1	\$151,70
BL-L1-1012	50W	6500 K	6000	1500 x 90 x 66	1	\$151,70

Led Linear Sıva Üstü Sarkıt Armatür

Surface Mounted Slim Led Fixture - Opal Lens



Teknik Özellikler: Technical Specifications

Gövde: Alüminyum
Body: Aluminum

Difüzör: Polikarbon Cam
Diffuser: Polycarbon Glass

LED Chip: Menşei Taiwan
LED Chip: Origin Taiwan

Sürücü: Menşei Taiwan
Driver: Origin Taiwan

Renksel Geri Verim: 80
CRI: 80

Koruma Sınıfı: 54
IP: 54

*1 m. Askı Teli
* 1 m. Hanger Wire

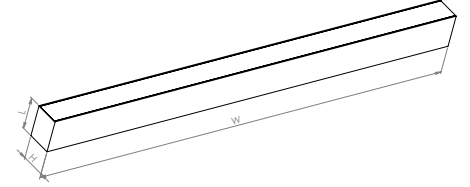
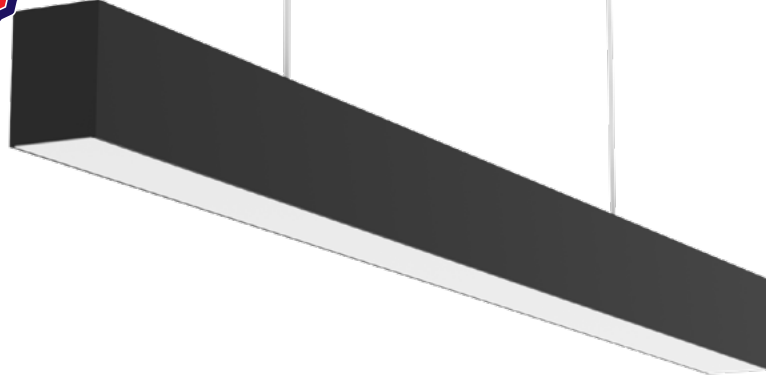

LED

IP54

YERLİ ÜRETİM

Ürün Kodu Product Code	Güç (W) Power	Renk Sıcaklığı (K) Color Temperature	Işık Akısı (Lm) Luminous Flux	Boyutlar(WxLxH)mm Dimensions	Koli Adeti Quantity in Carton	Fiyat Price
BL-L1-2001	15W	4000 K	1800	600 x 90 x 66	1	\$68,70
BL-L1-2002	15W	6500 K	1800	600 x 90 x 66	1	\$68,70
BL-L1-2003	20W	4000 K	2400	600 x 90 x 66	1	\$73,20
BL-L1-2004	20W	6500 K	2400	600 x 90 x 66	1	\$73,20
BL-L1-2005	30W	4000 K	3600	1200 x 90 x 66	1	\$105,60
BL-L1-2006	30W	6500 K	3600	1200 x 90 x 66	1	\$105,60
BL-L1-2007	40W	4000 K	4800	1200 x 90 x 66	1	\$110,10
BL-L1-2008	40W	6500 K	4800	1200 x 90 x 66	1	\$110,10
BL-L1-2009	45W	4000 K	5400	1500 x 90 x 66	1	\$133,70
BL-L1-2010	45W	6500 K	5400	1500 x 90 x 66	1	\$133,70
BL-L1-2011	50W	4000 K	6000	1500 x 90 x 66	1	\$138,20
BL-L1-2012	50W	6500 K	6000	1500 x 90 x 66	1	\$138,20





Teknik Özellikler:

Technical Specifications

Gövde: Polikarbonat
Body: Polycarbonate

Gövde Renkleri: Gri
Body Colors: Grey

Kapak: Polikarbonat
Cover: Polycarbonate

Kapak Rengi: Gri
Cover Color: Gray

LED Chip: Menşei Taiwan
LED Chip: Origin Taiwan

Sürücü: Menşei Taiwan
Driver: Origin Taiwan

Renksel Geri Verim: 80
CRI: 80

Koruma Sınıfı: 65
IP: 65

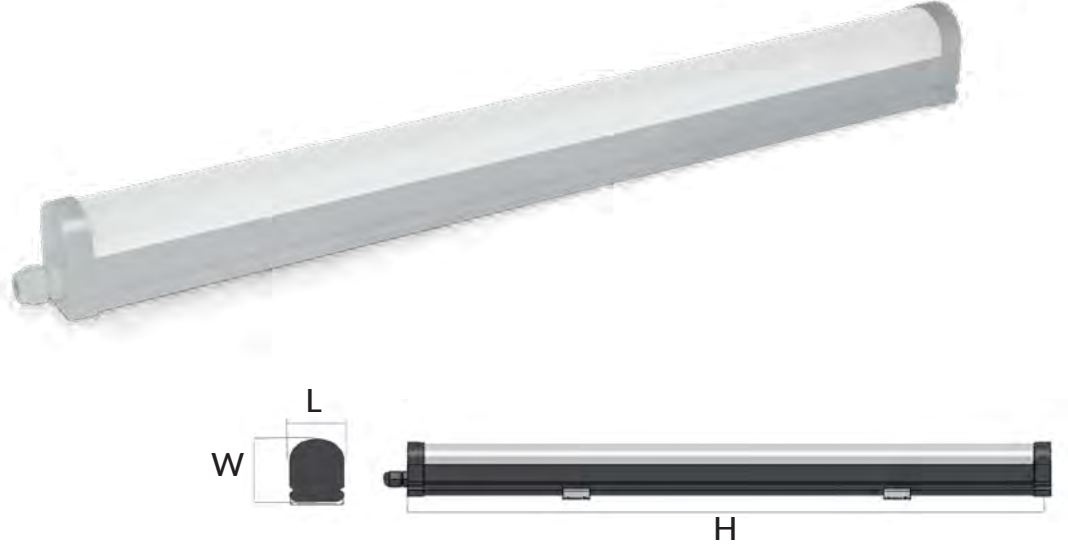

Opsiyonel: Koridor Uygulaması
Optional: Corridor Application

LED

IP65

YERLİ ÜRETİM

Ürün Kodu Product Code	Güç (W) Power	Renk Sıcaklığı (K) Color Temperature	Işık Akısı (Lm) Luminous Flux	Boyutlar (WxLxH)mm Dimensions	Renk Color	Opsiyonlar Options	Koli Adeti Quantity in Carton	Fiyat Price
BL-E1-0009	15W	4000 K	1350	64 x 44 x 600	Gri Grey	-	12	\$16,00
BL-E1-0009-1H	15W	4000 K	1350	64 x 44 x 600	Gri Grey	1 Saat Acil Kit 1 Hour Emergency Kit	12	\$56,50
BL-E1-0009-3H	15W	4000 K	1350	64 x 44 x 600	Gri Grey	3 Saat Acil Kit 3 Hour Emergency Kit	12	\$69,20
BL-E1-0009-RS	15W	4000 K	1350	64 x 44 x 600	Gri Grey	Radar Sensörlü Radar Sensor	12	\$22,50
BL-E1-0009-RS-1H	15W	4000 K	1350	64 x 44 x 600	Gri Grey	Radar Sensörlü 1 Saat Acil Kit Radar Sensor 1 Hour Emergency Kit	12	\$65,00
BL-E1-0009-RS-3H	15W	4000 K	1350	64 x 44 x 600	Gri Grey	Radar Sensörlü 3 Saat Acil Kit Radar Sensor 3 Hour Emergency Kit	12	\$79,60
BL-E1-0013	15W	6500 K	1350	64 x 44 x 600	Gri Grey	-	12	\$16,00
BL-E1-0013-1H	15W	6500 K	1350	64 x 44 x 600	Gri Grey	1 Saat Acil Kit 1 Hour Emergency Kit	12	\$56,50
BL-E1-0013-3H	15W	6500 K	1350	64 x 44 x 600	Gri Grey	3 Saat Acil Kit 3 Hour Emergency Kit	12	\$69,20
BL-E1-0013-RS	15W	6500 K	1350	64 x 44 x 600	Gri Grey	Radar Sensörlü Radar Sensor	12	\$22,50
BL-E1-0013-RS-1H	15W	6500 K	1350	64 x 44 x 600	Gri Grey	Radar Sensörlü 1 Saat Acil Kit Radar Sensor 1 Hour Emergency Kit	12	\$65,00
BL-E1-0013-RS-3H	15W	6500 K	1350	64 x 44 x 600	Gri Grey	Radar Sensörlü 3 Saat Acil Kit Radar Sensor 3 Hour Emergency Kit	12	\$79,60

Level Led Etanj Armatür

Level Led Waterproof Armature

Teknik Özellikler:

Technical Specifications

Gövde: Polikarbonat
Body: Polycarbonate

Gövde Renkleri: Gri
Body Colors: Grey

Kapak: Polikarbonat
Cover: Polycarbonate

Kapak Rengi: Gri
Cover Color: Gray

LED Chip: Menşei Taiwan
LED Chip: Origin Taiwan

Sürücü: Menşei Taiwan
Driver: Origin Taiwan

Renksel Geri Verim: 80
CRI: 80

Koruma Sınıfı: 65
IP: 65

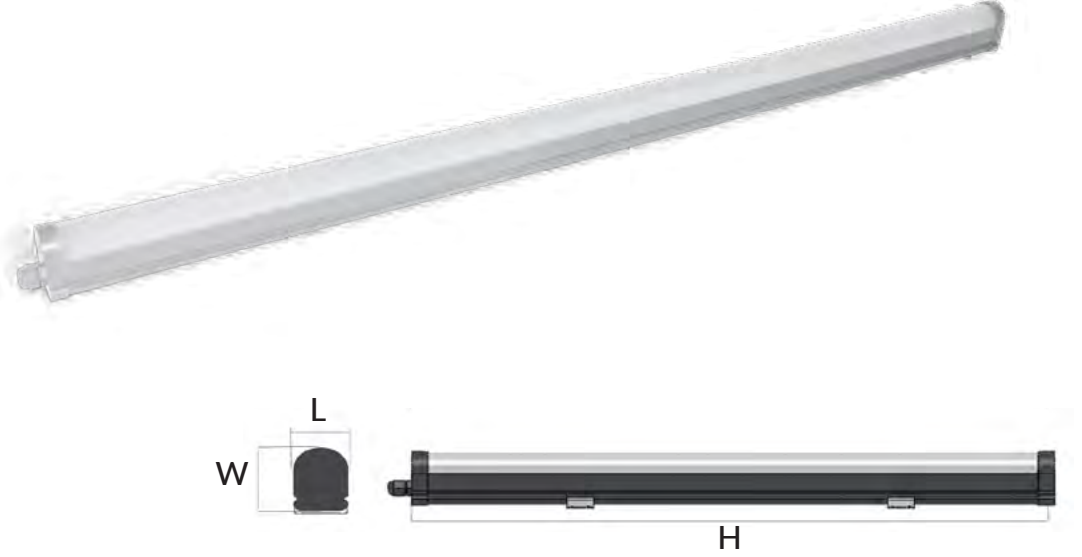

Opsiyonel: Koridor Uygulaması
Optional: Corridor Application

LED

IP65

YERLİ ÜRETİM

Ürün Kodu Product Code	Güç (W) Power	Renk Sıcaklığı (K) Color Temperature	Işık Akısı (Lm) Luminous Flux	Boyutlar(WxLxH)mm Dimensions	Renk Color	Opsiyonlar Options	Koli Adeti Quantity in Carton	Fiyat Price
BL-E1-0011	30W	4000 K	2700	64 x 44 x 1200	Gri Grey	-	12	\$29,40
BL-E1-0011-1H	30W	4000 K	2700	64 x 44 x 1200	Gri Grey	1 Saat Acil Kit 1 Hour Emergency Kit	12	\$71,40
BL-E1-0011-3H	30W	4000 K	2700	64 x 44 x 1200	Gri Grey	3 Saat Acil Kit 3 Hour Emergency Kit	12	\$84,70
BL-E1-0011-RS	30W	4000 K	2700	64 x 44 x 1200	Gri Grey	Radar Sensörlü Radar Sensor	12	\$43,40
BL-E1-0011-RS-1H	30W	4000 K	2700	64 x 44 x 1200	Gri Grey	Radar Sensörlü 1 Saat Acil Kit Radar Sensor 1 Hour Emergency Kit	12	\$82,10
BL-E1-0011-RS-3H	30W	4000 K	2700	64 x 44 x 1200	Gri Grey	Radar Sensörlü 3 Saat Acil Kit Radar Sensor 3 Hour Emergency Kit	12	\$97,40
BL-E1-0015	30W	6500 K	2700	64 x 44 x 1200	Gri Grey	-	12	\$29,40
BL-E1-0015-1H	30W	6500 K	2700	64 x 44 x 1200	Gri Grey	1 Saat Acil Kit 1 Hour Emergency Kit	12	\$71,40
BL-E1-0015-3H	30W	6500 K	2700	64 x 44 x 1200	Gri Grey	3 Saat Acil Kit 3 Hour Emergency Kit	12	\$84,70
BL-E1-0015-RS	30W	6500 K	2700	64 x 44 x 1200	Gri Grey	Radar Sensörlü Radar Sensor	12	\$43,40
BL-E1-0015-RS-1H	30W	6500 K	2700	64 x 44 x 1200	Gri Grey	Radar Sensörlü 1 Saat Acil Kit Radar Sensor 1 Hour Emergency Kit	12	\$82,10
BL-E1-0015-RS-3H	30W	6500 K	2700	64 x 44 x 1200	Gri Grey	Radar Sensörlü 3 Saat Acil Kit Radar Sensor 3 Hour Emergency Kit	12	\$97,40



Teknik Özellikler:

Technical Specifications

Gövde: Polikarbonat
Body: Polycarbonate

Gövde Renkleri: Gri
Body Colors: Grey

Kapak: Polikarbonat
Cover: Polycarbonate

Kapak Rengi: Gri
Cover Color: Gray

LED Chip: Menşei Taiwan
LED Chip: Origin Taiwan

Sürücü: Menşei Taiwan
Driver: Origin Taiwan

Renksel Geri Verim: 80
CRI: 80

Koruma Sınıfı: 65
IP: 65



Opsiyonel: Koridor Uygulaması
Optional: Corridor Application

LED

IP65

YERLİ ÜRETİM

Ürün Kodu Product Code	Güç (W) Power	Renk Sıcaklığı (K) Color Temperature	Işık Akısı (Lm) Luminous Flux	Boyutlar(WxLxH)mm Dimensions	Renk Color	Opsiyonlar Options	Koli Adeti Quantity in Carton	Fiyat Price
BL-E1-0010	20W	4000 K	1800	75 x 75 x 600	Gri Grey	-	12	\$16,60
BL-E1-0010-1H	20W	4000 K	1800	75 x 75 x 600	Gri Grey	1 Saat Acil Kit 1 Hour Emergency Kit	12	\$58,60
BL-E1-0010-3H	20W	4000 K	1800	75 x 75 x 600	Gri Grey	3 Saat Acil Kit 3 Hour Emergency Kit	12	\$71,90
BL-E1-0010-RS	20W	4000 K	1800	75 x 75 x 600	Gri Grey	Radar Sensörlü Radar Sensor	12	\$24,20
BL-E1-0010-RS-1H	20W	4000 K	1800	75 x 75 x 600	Gri Grey	Radar Sensörlü 1 Saat Acil Kit Radar Sensor 1 Hour Emergency Kit	12	\$64,40
BL-E1-0010-RS-3H	20W	4000 K	1800	75 x 75 x 600	Gri Grey	Radar Sensörlü 3 Saat Acil Kit Radar Sensor 3 Hour Emergency Kit	12	\$82,70
BL-E1-0014	20W	6500 K	1800	75 x 75 x 600	Gri Grey	-	12	\$16,60
BL-E1-0014-1H	20W	6500 K	1800	75 x 75 x 600	Gri Grey	1 Saat Acil Kit 1 Hour Emergency Kit	12	\$58,60
BL-E1-0014-3H	20W	6500 K	1800	75 x 75 x 600	Gri Grey	3 Saat Acil Kit 3 Hour Emergency Kit	12	\$71,90
BL-E1-0014-RS	20W	6500 K	1800	75 x 75 x 600	Gri Grey	Radar Sensörlü Radar Sensor	12	\$24,20
BL-E1-0014-RS-1H	20W	6500 K	1800	75 x 75 x 600	Gri Grey	Radar Sensörlü 1 Saat Acil Kit Radar Sensor 1 Hour Emergency Kit	12	\$64,40
BL-E1-0014-RS-3H	20W	6500 K	1800	75 x 75 x 600	Gri Grey	Radar Sensörlü 3 Saat Acil Kit Radar Sensor 3 Hour Emergency Kit	12	\$82,70

Elips Led Etanj Armatür

Elips Led Waterproof Armature

Teknik Özellikler:

Technical Specifications

Gövde: Polikarbonat
Body: Polycarbonate

Gövde Renkleri: Gri
Body Colors: Grey

Kapak: Polikarbonat
Cover: Polycarbonate

Kapak Rengi: Gri
Cover Color: Gray

LED Chip: Menşei Taiwan
LED Chip: Origin Taiwan

Sürücü: Menşei Taiwan
Driver: Origin Taiwan

Renksel Geri Verim: 80
CRI: 80

Koruma Sınıfı: 65
IP: 65



Opsiyonel: Koridor Uygulaması
Optional: Corridor Application

LED

IP65

YERLİ ÜRETİM

Ürün Kodu Product Code	Güç (W) Power	Renk Sıcaklığı (K) Color Temperature	Işık Akısı (Lm) Luminous Flux	Boyutlar(WxLxH)mm Dimensions	Renk Color	Opsiyonlar Options	Koli Adeti Quantity in Carton	Fiyat Price
BL-E1-0012	40W	4000 K	3600	75 x 75 x 1200	Gri Grey	-	12	\$33,00
BL-E1-0012-1H	40W	4000 K	3600	75 x 75 x 1200	Gri Grey	1 Saat Acil Kit 1 Hour Emergency Kit	12	\$75,10
BL-E1-0012-3H	40W	4000 K	3600	75 x 75 x 1200	Gri Grey	3 Saat Acil Kit 3 Hour Emergency Kit	12	\$88,30
BL-E1-0012-RS	40W	4000 K	3600	75 x 75 x 1200	Gri Grey	Radar Sensörlü Radar Sensor	12	\$45,40
BL-E1-0012-RS-1H	40W	4000 K	3600	75 x 75 x 1200	Gri Grey	Radar Sensörlü 1 Saat Acil Kit Radar Sensor 1 Hour Emergency Kit	12	\$86,40
BL-E1-0012-RS-3H	40W	4000 K	3600	75 x 75 x 1200	Gri Grey	Radar Sensörlü 3 Saat Acil Kit Radar Sensor 3 Hour Emergency Kit	12	\$101,60
BL-E1-0016	40W	6500 K	3600	75 x 75 x 1200	Gri Grey	-	12	\$33,00
BL-E1-0016-1H	40W	6500 K	3600	75 x 75 x 1200	Gri Grey	1 Saat Acil Kit 1 Hour Emergency Kit	12	\$75,10
BL-E1-0016-3H	40W	6500 K	3600	75 x 75 x 1200	Gri Grey	3 Saat Acil Kit 3 Hour Emergency Kit	12	\$88,30
BL-E1-0016-RS	40W	6500 K	3600	75 x 75 x 1200	Gri Grey	Radar Sensörlü Radar Sensor	12	\$45,40
BL-E1-0016-RS-1H	40W	6500 K	3600	75 x 75 x 1200	Gri Grey	Radar Sensörlü 1 Saat Acil Kit Radar Sensor 1 Hour Emergency Kit	12	\$86,40
BL-E1-0016-RS-3H	40W	6500 K	3600	75 x 75 x 1200	Gri Grey	Radar Sensörlü 3 Saat Acil Kit Radar Sensor 3 Hour Emergency Kit	12	\$101,60

Teknik Özellikler:

Technical Specifications

Gövde: Polikarbonat
Body: Polycarbonate

Gövde Renkleri: Gri
Body Colors: Grey

Kapak: Polikarbonat
Cover: Polycarbonate

Kapak Rengi: Gri
Cover Color: Gray

LED Chip: Menşei Taiwan
LED Chip: Origin Taiwan

Sürücü: Osram/Eaglerise/Tridonic
Driver: Osram/Eaglerise/Tridonic

Renksel Geri Verim: 80
CRI: 80

Koruma Sınıfı: 65
IP: 65



Opsiyonel: Koridor Uygulaması
Optional: Corridor Application

LED

IP65

YERLİ ÜRETİM

Ürün Kodu Product Code	Güç (W) Power	Renk Sıcaklığı (K) Color Temperature	Işık Akısı (Lm) Luminous Flux	Boyutlar(WxLxH)mm Dimensions	Renk Color	Opsiyonlar Options	Koli Adeti Quantity in Carton	Fiyat Price
BLT-E1-0009	15W	4000 K	1500	64 x 44 x 600	Gri Grey	-	12	\$24,40
BLT-E1-0009-1H	15W	4000 K	1500	64 x 44 x 600	Gri Grey	1 Saat Acil Kit 1 Hour Emergency Kit	12	\$66,50
BLT-E1-0009-3H	15W	4000 K	1500	64 x 44 x 600	Gri Grey	3 Saat Acil Kit 3 Hour Emergency Kit	12	\$79,70
BLT-E1-0009-RS	15W	4000 K	1500	64 x 44 x 600	Gri Grey	Radar Sensörlü Radar Sensor	12	\$51,00
BLT-E1-0009-RS-1H	15W	4000 K	1500	64 x 44 x 600	Gri Grey	Radar Sensörlü 1 Saat Acil Kit Radar Sensor 1 Hour Emergency Kit	12	\$93,00
BLT-E1-0009-RS-3H	15W	4000 K	1500	64 x 44 x 600	Gri Grey	Radar Sensörlü 3 Saat Acil Kit Radar Sensor 3 Hour Emergency Kit	12	\$106,30
BLT-E1-0013	15W	6500 K	1500	64 x 44 x 600	Gri Grey	-	12	\$24,40
BLT-E1-0013-1H	15W	6500 K	1500	64 x 44 x 600	Gri Grey	1 Saat Acil Kit 1 Hour Emergency Kit	12	\$66,50
BLT-E1-0013-3H	15W	6500 K	1500	64 x 44 x 600	Gri Grey	3 Saat Acil Kit 3 Hour Emergency Kit	12	\$79,70
BLT-E1-0013-RS	15W	6500 K	1500	64 x 44 x 600	Gri Grey	Radar Sensörlü Radar Sensor	12	\$51,00
BLT-E1-0013-RS-1H	15W	6500 K	1500	64 x 44 x 600	Gri Grey	Radar Sensörlü 1 Saat Acil Kit Radar Sensor 1 Hour Emergency Kit	12	\$93,00
BLT-E1-0013-RS-3H	15W	6500 K	1500	64 x 44 x 600	Gri Grey	Radar Sensörlü 3 Saat Acil Kit Radar Sensor 3 Hour Emergency Kit	12	\$106,30

Level Led Etanj Armatür TSE

Level Led Waterproof Armature TSE



Teknik Özellikler:

Technical Specifications

Gövde: Polikarbonat
Body: Polycarbonate

Gövde Renkleri: Gri
Body Colors: Grey

Kapak: Polikarbonat
Cover: Polycarbonate

Kapak Rengi: Gri
Cover Color: Gray

LED Chip: Menşei Taiwan
LED Chip: Origin Taiwan

Sürücü: Osram/Eaglerise/Tridonic
Driver: Osram/Eaglerise/Tridonic

Renksel Geri Verim: 80
CRI: 80

Koruma Sınıfı: 65
IP: 65



Opsiyonel: Koridor Uygulaması
Optional: Corridor Application

LED

IP65

YERLİ ÜRETİM

Ürün Kodu Product Code	Güç (W) Power	Renk Sıcaklığı (K) Color Temperature	Işık Akısı (Lm) Luminous Flux	Boyutlar(WxLxH)mm Dimensions	Renk Color	Opsiyonlar Options	Koli Adeti Quantity in Carton	Fiyat Price
BLT-E1-0011	30W	4000 K	3000	64 x 44 x 1200	Gri Grey	-	12	\$34,50
BLT-E1-0011-1H	30W	4000 K	3000	64 x 44 x 1200	Gri Grey	1 Saat Acil Kit 1 Hour Emergency Kit	12	\$76,50
BLT-E1-0011-3H	30W	4000 K	3000	64 x 44 x 1200	Gri Grey	3 Saat Acil Kit 3 Hour Emergency Kit	12	\$89,80
BLT-E1-0011-RS	30W	4000 K	3000	64 x 44 x 1200	Gri Grey	Radar Sensörlü Radar Sensor	12	\$61,00
BLT-E1-0011-RS-1H	30W	4000 K	3000	64 x 44 x 1200	Gri Grey	Radar Sensörlü 1 Saat Acil Kit Radar Sensor 1 Hour Emergency Kit	12	\$103,00
BLT-E1-0011-RS-3H	30W	4000 K	3000	64 x 44 x 1200	Gri Grey	Radar Sensörlü 3 Saat Acil Kit Radar Sensor 3 Hour Emergency Kit	12	\$116,30
BLT-E1-0015	30W	6500 K	3000	64 x 44 x 1200	Gri Grey	-	12	\$34,50
BLT-E1-0015-1H	30W	6500 K	3000	64 x 44 x 1200	Gri Grey	1 Saat Acil Kit 1 Hour Emergency Kit	12	\$76,50
BLT-E1-0015-3H	30W	6500 K	3000	64 x 44 x 1200	Gri Grey	3 Saat Acil Kit 3 Hour Emergency Kit	12	\$89,80
BLT-E1-0015-RS	30W	6500 K	3000	64 x 44 x 1200	Gri Grey	Radar Sensörlü Radar Sensor	12	\$61,00
BLT-E1-0015-RS-1H	30W	6500 K	3000	64 x 44 x 1200	Gri Grey	Radar Sensörlü 1 Saat Acil Kit Radar Sensor 1 Hour Emergency Kit	12	\$103,00
BLT-E1-0015-RS-3H	30W	6500 K	3000	64 x 44 x 1200	Gri Grey	Radar Sensörlü 3 Saat Acil Kit Radar Sensor 3 Hour Emergency Kit	12	\$116,30



Teknik Özellikler:

Technical Specifications

Gövde: Polikarbonat
Body: Polycarbonate

Gövde Renkleri: Gri
Body Colors: Grey

Kapak: Polikarbonat
Cover: Polycarbonate

Kapak Rengi: Gri
Cover Color: Gray

LED Chip: Menşei Taiwan
LED Chip: Origin Taiwan

Sürücü: Osram/Eaglerise/Tridonic
Driver: Osram/Eaglerise/Tridonic

Renksel Geri Verim: 80
CRI: 80

Koruma Sınıfı: 65
IP: 65



Opsiyonel: Koridor Uygulaması
Optional: Corridor Application

LED

IP65

YERLİ ÜRETİM

Ürün Kodu Product Code	Güç (W) Power	Renk Sıcaklığı (K) Color Temperature	Işık Akısı (Lm) Luminous Flux	Boyutlar(WxLxH)mm Dimensions	Renk Color	Opsiyonlar Options	Koli Adeti Quantity in Carton	Fiyat Price
BLT-E1-0010	20W	4000 K	2000	75 x 75 x 600	Gri Grey	-	12	\$27,30
BLT-E1-0010-1H	20W	4000 K	2000	75 x 75 x 600	Gri Grey	1 Saat Acil Kit 1 Hour Emergency Kit	12	\$69,30
BLT-E1-0010-3H	20W	4000 K	2000	75 x 75 x 600	Gri Grey	3 Saat Acil Kit 3 Hour Emergency Kit	12	\$82,60
BLT-E1-0010-RS	20W	4000 K	2000	75 x 75 x 600	Gri Grey	Radar Sensörlü Radar Sensor	12	\$53,90
BLT-E1-0010-RS-1H	20W	4000 K	2000	75 x 75 x 600	Gri Grey	Radar Sensörlü 1 Saat Acil Kit Radar Sensor 1 Hour Emergency Kit	12	\$95,90
BLT-E1-0010-RS-3H	20W	4000 K	2000	75 x 75 x 600	Gri Grey	Radar Sensörlü 3 Saat Acil Kit Radar Sensor 3 Hour Emergency Kit	12	\$109,10
BLT-E1-0014	20W	6500 K	2000	75 x 75 x 600	Gri Grey	-	12	\$27,30
BLT-E1-0014-1H	20W	6500 K	2000	75 x 75 x 600	Gri Grey	1 Saat Acil Kit 1 Hour Emergency Kit	12	\$69,30
BLT-E1-0014-3H	20W	6500 K	2000	75 x 75 x 600	Gri Grey	3 Saat Acil Kit 3 Hour Emergency Kit	12	\$82,60
BLT-E1-0014-RS	20W	6500 K	2000	75 x 75 x 600	Gri Grey	Radar Sensörlü Radar Sensor	12	\$53,90
BLT-E1-0014-RS-1H	20W	6500 K	2000	75 x 75 x 600	Gri Grey	Radar Sensörlü 1 Saat Acil Kit Radar Sensor 1 Hour Emergency Kit	12	\$95,90
BLT-E1-0014-RS-3H	20W	6500 K	2000	75 x 75 x 600	Gri Grey	Radar Sensörlü 3 Saat Acil Kit Radar Sensor 3 Hour Emergency Kit	12	\$109,10

Elips Led Etanj Armatür TSE

Elips Led Waterproof Armature TSE



Teknik Özellikler:

Technical Specifications

Gövde: Polikarbonat
Body: Polycarbonate

Gövde Renkleri: Gri
Body Colors: Grey

Kapak: Polikarbonat
Cover: Polycarbonate

Kapak Rengi: Gri
Cover Color: Gray

LED Chip: Menşei Taiwan
LED Chip: Origin Taiwan

Sürücü: Osram/Eaglerise/Tridonic
Driver: Osram/Eaglerise/Tridonic

Renksel Geri Verim: 80
CRI: 80

Koruma Sınıfı: 65
IP: 65



Opsiyonel: Koridor Uygulaması
Optional: Corridor Application

LED

IP65

YERLİ ÜRETİM

Ürün Kodu Product Code	Güç (W) Power	Renk Sıcaklığı (K) Color Temperature	Işık Akısı (Lm) Luminous Flux	Boyutlar(WxLxH)mm Dimensions	Renk Color	Opsiyonlar Options	Koli Adeti Quantity in Carton	Fiyat Price
BLT-E1-0012	40W	4000 K	4000	75 x 75 x 1200	Gri Grey	-	12	\$38,50
BLT-E1-0012-1H	40W	4000 K	4000	75 x 75 x 1200	Gri Grey	1 Saat Acil Kit 1 Hour Emergency Kit	12	\$80,50
BLT-E1-0012-3H	40W	4000 K	4000	75 x 75 x 1200	Gri Grey	3 Saat Acil Kit 3 Hour Emergency Kit	12	\$93,80
BLT-E1-0012-RS	40W	4000 K	4000	75 x 75 x 1200	Gri Grey	Radar Sensörlü Radar Sensor	12	\$65,00
BLT-E1-0012-RS-1H	40W	4000 K	4000	75 x 75 x 1200	Gri Grey	Radar Sensörlü 1 Saat Acil Kit Radar Sensor 1 Hour Emergency Kit	12	\$107,00
BLT-E1-0012-RS-3H	40W	4000 K	4000	75 x 75 x 1200	Gri Grey	Radar Sensörlü 3 Saat Acil Kit Radar Sensor 3 Hour Emergency Kit	12	\$120,30
BLT-E1-0016	40W	6500 K	4000	75 x 75 x 1200	Gri Grey	-	12	\$38,50
BLT-E1-0016-1H	40W	6500 K	4000	75 x 75 x 1200	Gri Grey	1 Saat Acil Kit 1 Hour Emergency Kit	12	\$80,50
BLT-E1-0016-3H	40W	6500 K	4000	75 x 75 x 1200	Gri Grey	3 Saat Acil Kit 3 Hour Emergency Kit	12	\$93,80
BLT-E1-0016-RS	40W	6500 K	4000	75 x 75 x 1200	Gri Grey	Radar Sensörlü Radar Sensor	12	\$65,00
BLT-E1-0016-RS-1H	40W	6500 K	4000	75 x 75 x 1200	Gri Grey	Radar Sensörlü 1 Saat Acil Kit Radar Sensor 1 Hour Emergency Kit	12	\$107,00
BLT-E1-0016-RS-3H	40W	6500 K	4000	75 x 75 x 1200	Gri Grey	Radar Sensörlü 3 Saat Acil Kit Radar Sensor 3 Hour Emergency Kit	12	\$120,30





Teknik Özellikler:

Technical Specifications

Gövde: Alüminyum
Body: Aluminum

Gövde Renkleri: Beyaz
Body Colors: White

Difüzör: PC
Diffuser: PC

LED Chip: Menşei Taiwan
LED Chip: Origin Taiwan

Sürücü: Menşei Taiwan
Driver: Origin Taiwan

Renksel Geri Verim: 80
CRI: 80

Koruma Sınıfı: 20
IP: 20

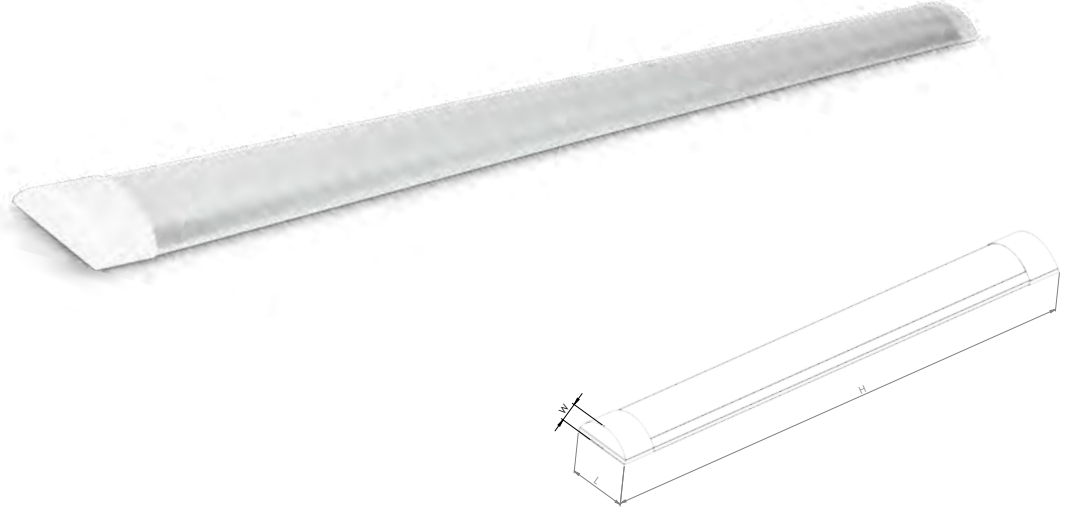

LED

IP20

YERLİ ÜRETİM

Ürün Kodu Product Code	Güç (W) Power	Renk Sıcaklığı (K) Color Temperature	Işık Akısı (Lm) Luminous Flux	Boyutlar(WxLxH) mm Dimensions	Renk Color	Koli Adeti Quantity in Carton	Fiyat Price
BL-E3-0001	18W	6500 K	1500	25 x 75 x 600	Beyaz White	24	\$9,50
BL-E3-0002	18W	4000 K	3000	25 x 75 x 1200	Beyaz White	24	\$9,50
BL-E3-0003	18W	3000 K	1500	25 x 75 x 600	Beyaz White	24	\$9,50
BL-E3-0004	36W	6500 K	3000	25 x 75 x 1200	Beyaz White	24	\$16,40
BL-E3-0005	36W	4000 K	1500	25 x 75 x 600	Beyaz White	24	\$16,40
BL-E3-0006	36W	3000 K	3000	25 x 75 x 1200	Beyaz White	24	\$16,40

Oval Led Glop Armatür

Oval Led Ceiling Armature



Teknik Özellikler:

Technical Specifications

Gövde: DKP Sac
Body: DKP Metal Sheet

Gövde Renkleri: Beyaz
Body Colors: White

Difüzör: Akrilik
Diffuser: Acrylic

LED Chip: Menşei Taiwan
LED Chip: Origin Taiwan

Sürücü: Menşei Taiwan
Driver: Origin Taiwan

Renksel Geri Verim: 80
CRI: 80

Koruma Sınıfı: 20
IP: 20



LED

IP20

YERLİ ÜRETİM

Ürün Kodu Product Code	Güç (W) Power	Renk Sıcaklığı (K) Color Temperature	Işık Akısı (Lm) Luminous Flux	Boyutlar (ØxH) mm Dimensions	Opsiyonlar Options	Koli Adeti Quantity in Carton	Fiyat Price
BL-G1-0002	12W	3000 K	1080	260 x 83	-	24	\$19,00
BL-G1-0002-1H	12W	3000 K	1080	260 x 83	1 Saat Acil Kit 1 Hour Emergency Kit	24	\$29,60
BL-G1-0002-3H	12W	3000 K	1080	260 x 83	3 Saat Acil Kit 3 Hour Emergency Kit	24	\$36,60
BL-G1-0002-RS	12W	3000 K	1080	260 x 83	Radar Sensörlü Radar Sensor	24	\$23,80
BL-G1-0002-RS-1H	12W	3000 K	1080	260 x 83	Radar Sensörlü 1 Saat Acil Kit Radar Sensor 1 Hour Emergency Kit	24	\$34,30
BL-G1-0002-RS-3H	12W	3000 K	1080	260 x 83	Radar Sensörlü 3 Saat Acil Kit Radar Sensor 3 Hour Emergency Kit	24	\$40,40
BL-G1-0014	12W	4000 K	1080	260 x 83	-	24	\$19,00
BL-G1-0014-1H	12W	4000 K	1080	260 x 83	1 Saat Acil Kit 1 Hour Emergency Kit	24	\$29,60
BL-G1-0014-3H	12W	4000 K	1080	260 x 83	3 Saat Acil Kit 3 Hour Emergency Kit	24	\$36,60
BL-G1-0014-RS	12W	4000 K	1080	260 x 83	Radar Sensörlü Radar Sensor	24	\$23,80
BL-G1-0014-RS-1H	12W	4000 K	1080	260 x 83	Radar Sensörlü 1 Saat Acil Kit Radar Sensor 1 Hour Emergency Kit	24	\$34,30
BL-G1-0014-RS-3H	12W	4000 K	1080	260 x 83	Radar Sensörlü 3 Saat Acil Kit Radar Sensor 3 Hour Emergency Kit	24	\$40,40
BL-G1-0008	12W	6500 K	1080	260 x 83	-	24	\$19,00
BL-G1-0008-1H	12W	6500 K	1080	260 x 83	1 Saat Acil Kit 1 Hour Emergency Kit	24	\$29,60
BL-G1-0008-3H	12W	6500 K	1080	260 x 83	3 Saat Acil Kit 3 Hour Emergency Kit	24	\$36,60
BL-G1-0008-RS	12W	6500 K	1080	260 x 83	Radar Sensörlü Radar Sensor	24	\$23,80
BL-G1-0008-RS-1H	12W	6500 K	1080	260 x 83	Radar Sensörlü 1 Saat Acil Kit Radar Sensor 1 Hour Emergency Kit	24	\$34,30
BL-G1-0008-RS-3H	12W	6500 K	1080	260 x 83	Radar Sensörlü 3 Saat Acil Kit Radar Sensor 3 Hour Emergency Kit	24	\$40,40



Ürün Kodu Product Code	Güç (W) Power	Renk Sıcaklığı (K) Color Temperature	Işık Akısı (Lm) Luminous Flux	Boyutlar (ØxH) mm Dimensions	Opsiyonlar Options	Koli Adeti Quantity in Carton	Fiyat Price
BL-G1-0004	18W	3000 K	1620	330 x 96	-	12	\$24,30
BL-G1-0004-1H	18W	3000 K	1620	330 x 96	1 Saat Acil Kit 1 Hour Emergency Kit	12	\$34,90
BL-G1-0004-3H	18W	3000 K	1620	330 x 96	3 Saat Acil Kit 3 Hour Emergency Kit	12	\$41,90
BL-G1-0004-RS	18W	3000 K	1620	330 x 96	Radar Sensörlü Radar Sensor	12	\$29,10
BL-G1-0004-RS-1H	18W	3000 K	1620	330 x 96	Radar Sensörlü 1 Saat Acil Kit Radar Sensor 1 Hour Emergency Kit	12	\$39,70
BL-G1-0004-RS-3H	18W	3000 K	1620	330 x 96	Radar Sensörlü 3 Saat Acil Kit Radar Sensor 3 Hour Emergency Kit	12	\$45,70
BL-G1-0016	18W	4000 K	1620	330 x 96	-	12	\$24,30
BL-G1-0016-1H	18W	4000 K	1620	330 x 96	1 Saat Acil Kit 1 Hour Emergency Kit	12	\$34,90
BL-G1-0016-3H	18W	4000 K	1620	330 x 96	3 Saat Acil Kit 3 Hour Emergency Kit	12	\$41,90
BL-G1-0016-RS	18W	4000 K	1620	330 x 96	Radar Sensörlü Radar Sensor	12	\$29,10
BL-G1-0016-RS-1H	18W	4000 K	1620	330 x 96	Radar Sensörlü 1 Saat Acil Kit Radar Sensor 1 Hour Emergency Kit	12	\$39,70
BL-G1-0016-RS-3H	18W	4000 K	1620	330 x 96	Radar Sensörlü 3 Saat Acil Kit Radar Sensor 3 Hour Emergency Kit	12	\$45,70
BL-G1-0010	18W	6500 K	1620	330 x 96	-	12	\$24,30
BL-G1-0010-1H	18W	6500 K	1620	330 x 96	1 Saat Acil Kit 1 Hour Emergency Kit	12	\$34,90
BL-G1-0010-3H	18W	6500 K	1620	330 x 96	3 Saat Acil Kit 3 Hour Emergency Kit	12	\$41,90
BL-G1-0010-RS	18W	6500 K	1620	330 x 96	Radar Sensörlü Radar Sensor	12	\$29,10
BL-G1-0010-RS-1H	18W	6500 K	1620	330 x 96	Radar Sensörlü 1 Saat Acil Kit Radar Sensor 1 Hour Emergency Kit	12	\$39,70
BL-G1-0010-RS-3H	18W	6500 K	1620	330 x 96	Radar Sensörlü 3 Saat Acil Kit Radar Sensor 3 Hour Emergency Kit	12	\$45,70
BL-G1-0006	24W	3000 K	2160	380 x 100	-	6	\$29,20
BL-G1-0006-1H	24W	3000 K	2160	380 x 100	1 Saat Acil Kit 1 Hour Emergency Kit	6	\$39,70
BL-G1-0006-3H	24W	3000 K	2160	380 x 100	3 Saat Acil Kit 3 Hour Emergency Kit	6	\$46,70
BL-G1-0006-RS	24W	3000 K	2160	380 x 100	Radar Sensörlü Radar Sensor	6	\$34,00
BL-G1-0006-RS-1H	24W	3000 K	2160	380 x 100	Radar Sensörlü 1 Saat Acil Kit Radar Sensor 1 Hour Emergency Kit	6	\$44,50
BL-G1-0006-RS-3H	24W	3000 K	2160	380 x 100	Radar Sensörlü 3 Saat Acil Kit Radar Sensor 3 Hour Emergency Kit	6	\$50,60
BL-G1-0018	24W	4000 K	2160	380 x 100	-	6	\$29,20
BL-G1-0018-1H	24W	4000 K	2160	380 x 100	1 Saat Acil Kit 1 Hour Emergency Kit	6	\$39,70
BL-G1-0018-3H	24W	4000 K	2160	380 x 100	3 Saat Acil Kit 3 Hour Emergency Kit	6	\$46,70
BL-G1-0018-RS	24W	4000 K	2160	380 x 100	Radar Sensörlü Radar Sensor	6	\$34,00
BL-G1-0018-RS-1H	24W	4000 K	2160	380 x 100	Radar Sensörlü 1 Saat Acil Kit Radar Sensor 1 Hour Emergency Kit	6	\$44,50
BL-G1-0018-RS-3H	24W	4000 K	2160	380 x 100	Radar Sensörlü 3 Saat Acil Kit Radar Sensor 3 Hour Emergency Kit	6	\$50,60
BL-G1-0012	24W	6500 K	2160	380 x 100	-	6	\$29,20
BL-G1-0012-1H	24W	6500 K	2160	380 x 100	1 Saat Acil Kit 1 Hour Emergency Kit	6	\$39,70
BL-G1-0012-3H	24W	6500 K	2160	380 x 100	3 Saat Acil Kit 3 Hour Emergency Kit	6	\$46,70
BL-G1-0012-RS	24W	6500 K	2160	380 x 100	Radar Sensörlü Radar Sensor	6	\$34,00
BL-G1-0012-RS-1H	24W	6500 K	2160	380 x 100	Radar Sensörlü 1 Saat Acil Kit Radar Sensor 1 Hour Emergency Kit	6	\$44,50
BL-G1-0012-RS-3H	24W	6500 K	2160	380 x 100	Radar Sensörlü 3 Saat Acil Kit Radar Sensor 3 Hour Emergency Kit	6	\$50,60

Flat Led Glop Armatür

Flat Led Ceiling Armature

Teknik Özellikler:

Technical Specifications

Gövde: DKP Sac
Body: DKP Metal Sheet

Gövde Renkleri: Beyaz
Body Colors: White

Difüzör: Akrilik
Diffuser: Acrylic

LED Chip: Menşei Taiwan
LED Chip: Origin Taiwan

Sürücü: Menşei Taiwan
Driver: Origin Taiwan

Renksel Geri Verim: 80
CRI: 80

Koruma Sınıfı: 20
IP: 20



Ürün Kodu Product Code	Güç (W) Power	Renk Sıcaklığı (K) Color Temperature	Işık Akısı (Lm) Luminous Flux	Boyutlar (ØxH) mm Dimensions	Opsiyonlar Options	Koli Adeti Quantity in Carton	Fiyat Price
BL-G1-0001	12W	3000 K	1080	260 x 83	-	24	\$19,00
BL-G1-0001-1H	12W	3000 K	1080	260 x 83	1 Saat Acil Kit 1 Hour Emergency Kit	24	\$29,60
BL-G1-0001-3H	12W	3000 K	1080	260 x 83	3 Saat Acil Kit 3 Hour Emergency Kit	24	\$36,60
BL-G1-0001-RS	12W	3000 K	1080	260 x 83	Radar Sensörlü Radar Sensor	24	\$23,80
BL-G1-0001-RS-1H	12W	3000 K	1080	260 x 83	Radar Sensörlü 1 Saat Acil Kit Radar Sensor 1 Hour Emergency Kit	24	\$34,30
BL-G1-0001-RS-3H	12W	3000 K	1080	260 x 83	Radar Sensörlü 3 Saat Acil Kit Radar Sensor 3 Hour Emergency Kit	24	\$40,40
BL-G1-0013	12W	4000 K	1080	260 x 83	-	24	\$19,00
BL-G1-0013-1H	12W	4000 K	1080	260 x 83	1 Saat Acil Kit 1 Hour Emergency Kit	24	\$29,60
BL-G1-0013-3H	12W	4000 K	1080	260 x 83	3 Saat Acil Kit 3 Hour Emergency Kit	24	\$36,60
BL-G1-0013-RS	12W	4000 K	1080	260 x 83	Radar Sensörlü Radar Sensor	24	\$23,80
BL-G1-0013-RS-1H	12W	4000 K	1080	260 x 83	Radar Sensörlü 1 Saat Acil Kit Radar Sensor 1 Hour Emergency Kit	24	\$34,30
BL-G1-0013-RS-3H	12W	4000 K	1080	260 x 83	Radar Sensörlü 3 Saat Acil Kit Radar Sensor 3 Hour Emergency Kit	24	\$40,40
BL-G1-0007	12W	6500 K	1080	260 x 83	-	24	\$19,00
BL-G1-0007-1H	12W	6500 K	1080	260 x 83	1 Saat Acil Kit 1 Hour Emergency Kit	24	\$29,60
BL-G1-0007-3H	12W	6500 K	1080	260 x 83	3 Saat Acil Kit 3 Hour Emergency Kit	24	\$36,60
BL-G1-0007-RS	12W	6500 K	1080	260 x 83	Radar Sensörlü Radar Sensor	24	\$23,80
BL-G1-0007-RS-1H	12W	6500 K	1080	260 x 83	Radar Sensörlü 1 Saat Acil Kit Radar Sensor 1 Hour Emergency Kit	24	\$34,30
BL-G1-0007-RS-3H	12W	6500 K	1080	260 x 83	Radar Sensörlü 3 Saat Acil Kit Radar Sensor 3 Hour Emergency Kit	24	\$40,40

Ürün Kodu Product Code	Güç (W) Power	Renk Sıcaklığı (K) Color Temperature	Işık Akısı (Lm) Luminous Flux	Boyutlar (ØxH) mm Dimensions	Opsiyonlar Options	Koli Adeti Quantity in Carton	Fiyat Price
BL-G1-0003	18W	3000 K	1620	330 x 96	-	12	\$24,30
BL-G1-0003-1H	18W	3000 K	1620	330 x 96	1 Saat Acil Kit 1 Hour Emergency Kit	12	\$34,90
BL-G1-0003-3H	18W	3000 K	1620	330 x 96	3 Saat Acil Kit 3 Hour Emergency Kit	12	\$41,90
BL-G1-0003-RS	18W	3000 K	1620	330 x 96	Radar Sensörlü Radar Sensor	12	\$29,10
BL-G1-0003-RS-1H	18W	3000 K	1620	330 x 96	Radar Sensörlü 1 Saat Acil Kit Radar Sensor 1 Hour Emergency Kit	12	\$39,70
BL-G1-0003-RS-3H	18W	3000 K	1620	330 x 96	Radar Sensörlü 3 Saat Acil Kit Radar Sensor 3 Hour Emergency Kit	12	\$45,70
BL-G1-0015	18W	4000 K	1620	330 x 96	-	12	\$24,30
BL-G1-0015-1H	18W	4000 K	1620	330 x 96	1 Saat Acil Kit 1 Hour Emergency Kit	12	\$34,90
BL-G1-0015-3H	18W	4000 K	1620	330 x 96	3 Saat Acil Kit 3 Hour Emergency Kit	12	\$41,90
BL-G1-0015-RS	18W	4000 K	1620	330 x 96	Radar Sensörlü Radar Sensor	12	\$29,10
BL-G1-0015-RS-1H	18W	4000 K	1620	330 x 96	Radar Sensörlü 1 Saat Acil Kit Radar Sensor 1 Hour Emergency Kit	12	\$39,70
BL-G1-0015-RS-3H	18W	4000 K	1620	330 x 96	Radar Sensörlü 3 Saat Acil Kit Radar Sensor 3 Hour Emergency Kit	12	\$45,70
BL-G1-0009	18W	6500 K	1620	330 x 96	-	12	\$24,30
BL-G1-0009-1H	18W	6500 K	1620	330 x 96	1 Saat Acil Kit 1 Hour Emergency Kit	12	\$34,90
BL-G1-0009-3H	18W	6500 K	1620	330 x 96	3 Saat Acil Kit 3 Hour Emergency Kit	12	\$41,90
BL-G1-0009-RS	18W	6500 K	1620	330 x 96	Radar Sensörlü Radar Sensor	12	\$29,10
BL-G1-0009-RS-1H	18W	6500 K	1620	330 x 96	Radar Sensörlü 1 Saat Acil Kit Radar Sensor 1 Hour Emergency Kit	12	\$39,70
BL-G1-0009-RS-3H	18W	6500 K	1620	330 x 96	Radar Sensörlü 3 Saat Acil Kit Radar Sensor 3 Hour Emergency Kit	12	\$45,70
BL-G1-0005	24W	3000 K	2160	380 x 100	-	6	\$29,20
BL-G1-0005-1H	24W	3000 K	2160	380 x 100	1 Saat Acil Kit 1 Hour Emergency Kit	6	\$39,70
BL-G1-0005-3H	24W	3000 K	2160	380 x 100	3 Saat Acil Kit 3 Hour Emergency Kit	6	\$46,70
BL-G1-0005-RS	24W	3000 K	2160	380 x 100	Radar Sensörlü Radar Sensor	6	\$34,00
BL-G1-0005-RS-1H	24W	3000 K	2160	380 x 100	Radar Sensörlü 1 Saat Acil Kit Radar Sensor 1 Hour Emergency Kit	6	\$44,50
BL-G1-0005-RS-3H	24W	3000 K	2160	380 x 100	Radar Sensörlü 3 Saat Acil Kit Radar Sensor 3 Hour Emergency Kit	6	\$50,60
BL-G1-0017	24W	4000 K	2160	380 x 100	-	6	\$29,20
BL-G1-0017-1H	24W	4000 K	2160	380 x 100	1 Saat Acil Kit 1 Hour Emergency Kit	6	\$39,70
BL-G1-0017-3H	24W	4000 K	2160	380 x 100	3 Saat Acil Kit 3 Hour Emergency Kit	6	\$46,70
BL-G1-0017-RS	24W	4000 K	2160	380 x 100	Radar Sensörlü Radar Sensor	6	\$34,00
BL-G1-0017-RS-1H	24W	4000 K	2160	380 x 100	Radar Sensörlü 1 Saat Acil Kit Radar Sensor 1 Hour Emergency Kit	6	\$44,50
BL-G1-0017-RS-3H	24W	4000 K	2160	380 x 100	Radar Sensörlü 3 Saat Acil Kit Radar Sensor 3 Hour Emergency Kit	6	\$50,60
BL-G1-0011	24W	6500 K	2160	380 x 100	-	6	\$29,20
BL-G1-0011-1H	24W	6500 K	2160	380 x 100	1 Saat Acil Kit 1 Hour Emergency Kit	6	\$39,70
BL-G1-0011-3H	24W	6500 K	2160	380 x 100	3 Saat Acil Kit 3 Hour Emergency Kit	6	\$46,70
BL-G1-0011-RS	24W	6500 K	2160	380 x 100	Radar Sensörlü Radar Sensor	6	\$34,00
BL-G1-0011-RS-1H	24W	6500 K	2160	380 x 100	Radar Sensörlü 1 Saat Acil Kit Radar Sensor 1 Hour Emergency Kit	6	\$44,50
BL-G1-0011-RS-3H	24W	6500 K	2160	380 x 100	Radar Sensörlü 3 Saat Acil Kit Radar Sensor 3 Hour Emergency Kit	6	\$50,60

Led Glop Armatürler

Led Glop Armatures

Kare Led Tavan Glop Armatür

Teknik Özellikler:
Technical Specifications

Gövde: ABS
Body: ABS

Cam: S.A.N
Glass: S.A.N

LED Chip: Menşei Taiwan
LED Chip: Origin Taiwan

Sürücü: On-Board
Driver: On-Board

Renkset Geri Verim: 80
CRI: 80

Koruma Sınıfı: 20
IP: 20

LED

IP20

YERLİ ÜRETİM

3 YIL GARANTİ

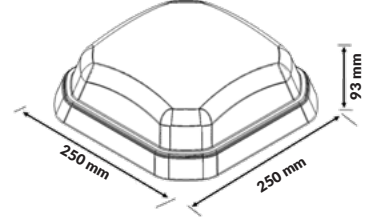

Ürün Kodu Product Code	Güç (W) Power	Renk Sıcaklığı (K) Color Temperature	Işık Akısı (Lm) Luminous Flux	Boyutlar (WxLxH) mm Dimensions	Kutu Adeti Quantity in Box	Koli Adeti Quantity in Carton	Fiyat Price
BL-B1-0007	12W	6500 K	960	250 x 250 x 93	2	24	\$13,70
BL-B1-0008	12W	3000 K	960	250 x 250 x 93	2	24	\$13,70

Ufo Led Tavan Glop Armatür

Teknik Özellikler:
Technical Specifications

Gövde: ABS
Body: ABS

Cam: S.A.N
Glass: S.A.N

LED Chip: Menşei Taiwan
LED Chip: Origin Taiwan

Sürücü: On-Board
Driver: On-Board

Renkset Geri Verim: 80
CRI: 80

Koruma Sınıfı: 20
IP: 20

LED

IP20

YERLİ ÜRETİM

3 YIL GARANTİ

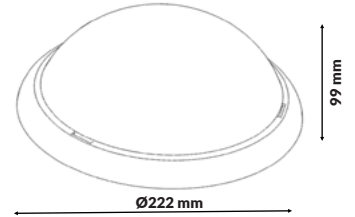

Ürün Kodu Product Code	Güç (W) Power	Renk Sıcaklığı (K) Color Temperature	Işık Akısı (Lm) Luminous Flux	Boyutlar (ØxH) mm Dimensions	Kutu Adeti Quantity in Box	Koli Adeti Quantity in Carton	Fiyat Price
BL-B1-0009	11W	6500 K	880	222 x 99	2	36	\$9,50
BL-B1-0010	11W	3000 K	880	222 x 99	2	36	\$9,50

İnci Led Tavan Glop Armatür

Teknik Özellikler:
Technical Specifications

Gövde: DKP Sac
Body: DKP Metal Sheet

Cam: S.A.N
Glass: S.A.N

LED Chip: Menşei Taiwan
LED Chip: Origin Taiwan

Sürücü: On-Board
Driver: On-Board

Renksel Geri Verim: 80
CRI: 80

Koruma Sınıfı: 20
IP: 20

LED

IP20

YERLİ ÜRETİM

3 YIL GARANTİ

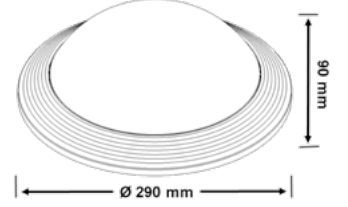

Ürün Kodu Product Code	Güç (W) Power	Renk Sıcaklığı (K) Color Temperature	Işık Akısı (Lm) Luminous Flux	Boyutlar (ØxH) mm Dimensions	Kutu Adeti Quantity in Box	Koli Adeti Quantity in Carton	Fiyat Price
BL-B1-0011	11W	6500 K	880	290 x 90	2	16	\$12,30
BL-B1-0012	11W	3000 K	880	290 x 90	2	16	\$12,30

Okyanus Led Tavan Glop Armatür

Teknik Özellikler:
Technical Specifications

Gövde: ABS
Body: ABS

Cam: S.A.N
Glass: S.A.N

LED Chip: Menşei Taiwan
LED Chip: Origin Taiwan

Sürücü: On-Board
Driver: On-Board

Renksel Geri Verim: 80
CRI: 80

Koruma Sınıfı: 20
IP: 20

LED

IP20

YERLİ ÜRETİM

3 YIL GARANTİ

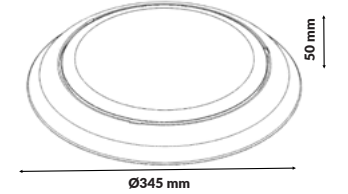

Ürün Kodu Product Code	Güç (W) Power	Renk Sıcaklığı (K) Color Temperature	Işık Akısı (Lm) Luminous Flux	Boyutlar (ØxH) mm Dimensions	Kutu Adeti Quantity in Box	Koli Adeti Quantity in Carton	Fiyat Price
BL-B1-0015	24W	6500 K	1560	345 x 50	2	12	\$14,60
BL-B1-0016	24W	3000 K	1560	345 x 50	2	12	\$14,60

Led Glop Armatürler

Led Glop Armatures



İstanbul Led Tavan Glop Armatür

Teknik Özellikler:

Technical Specifications

Gövde: ABS
Body: ABS

Cam: S.A.N
Glass: S.A.N

LED Chip: Menşei Taiwan
LED Chip: Origin Taiwan

Sürücü: On-Board
Driver: On-Board

Renksel Geri Verim: 80
CRI: 80

Koruma Sınıfı: 20
IP: 20

LED

IP20

YERLİ ÜRETİM

3 YIL GARANTİ

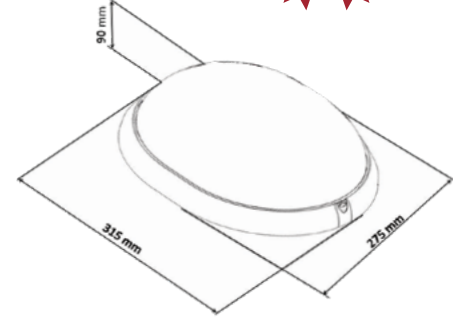

Ürün Kodu Product Code	Güç (W) Power	Renk Sıcaklığı (K) Color Temperature	Işık Akısı (Lm) Luminous Flux	Boyutlar (WxLxH) mm Dimensions	Kutu Adeti Quantity in Box	Koli Adeti Quantity in Carton	Fiyat Price
BL-B1-0017	24W	6500 K	1920	315 x 275 x 90	2	12	\$16,10
BL-B1-0018	24W	3000 K	1920	315 x 275 x 90	2	12	\$16,10

Asos Led Tavan Glop Armatür

Teknik Özellikler:

Technical Specifications

Gövde: ABS
Body: ABS

Cam: S.A.N
Glass: S.A.N

LED Chip: Menşei Taiwan
LED Chip: Origin Taiwan

Sürücü: On-Board
Driver: On-Board

Renksel Geri Verim: 80
CRI: 80

Koruma Sınıfı: 20
IP: 20

LED

IP20

YERLİ ÜRETİM

3 YIL GARANTİ

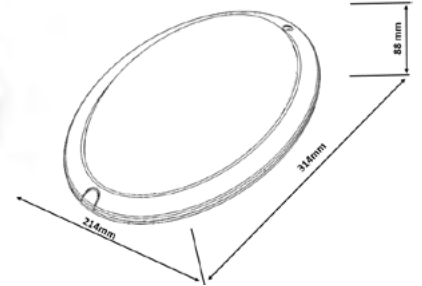

Ürün Kodu Product Code	Güç (W) Power	Renk Sıcaklığı (K) Color Temperature	Işık Akısı (Lm) Luminous Flux	Boyutlar (WxLxH) mm Dimensions	Kutu Adeti Quantity in Box	Koli Adeti Quantity in Carton	Fiyat Price
BL-B1-0019	12W	6500 K	960	314 x 214 x 88	2	24	\$14,30
BL-B1-0020	12W	3000 K	960	314 x 214 x 88	2	24	\$14,30



Led Nemliyer Yuvarlak Glop Tavan Armatür

Teknik Özellikler:
Technical Specifications

Gövde: Polikarbonat
Body: Polycarbonate

Difüzör: Akrilik
Diffuser: Acrylic

LED Chip: Menşei Taiwan
LED Chip: Origin Taiwan

Sürücü: Menşei Taiwan
Driver: Origin Taiwan

Renkssel Geri Verim: 80
CRI: 80

Koruma Sınıfı: 65
IP: 65



LED

IP65

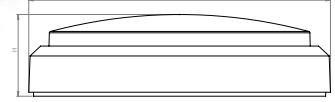

Ürün Kodu Product Code	Güç (W) Power	Renk Sıcaklığı (K) Color Temperature	Işık Akısı (Lm) Luminous Flux	Boyutlar (ØxH) mm Dimensions	Renk Color	Koli Adeti Quantity in Carton	Fiyat Price
BL-G2-0002	12W	4000 K	1080	175 x 60	Beyaz White	24	\$16,90
BL-G2-0003	12W	6500 K	1080	175 x 60	Beyaz White	24	\$16,90
BL-G2-0005	15W	4000 K	1350	210 x 60	Beyaz White	12	\$23,40
BL-G2-0006	15W	6500 K	1350	210 x 60	Beyaz White	12	\$23,40
BL-G2-0008	12W	4000 K	1080	175 x 60	Siyah Black	24	\$16,90
BL-G2-0009	12W	6500 K	1080	175 x 60	Siyah Black	24	\$16,90
BL-G2-0011	15W	4000 K	1350	210 x 60	Siyah Black	12	\$23,40
BL-G2-0012	15W	6500 K	1350	210 x 60	Siyah Black	12	\$23,40

Led Nemliyer Oval Glop Tavan Armatür

Teknik Özellikler:
Technical Specifications

Gövde: Polikarbonat
Body: Polycarbonate

Difüzör: Akrilik
Diffuser: Acrylic

LED Chip: Menşei Taiwan
LED Chip: Origin Taiwan

Sürücü: Menşei Taiwan
Driver: Origin Taiwan

Renkssel Geri Verim: 80
CRI: 80

Koruma Sınıfı: 65
IP: 65



LED

IP65

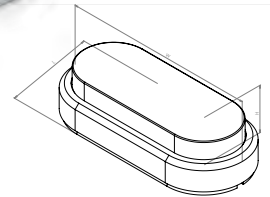

Ürün Kodu Product Code	Güç (W) Power	Renk Sıcaklığı (K) Color Temperature	Işık Akısı (Lm) Luminous Flux	Boyutlar (WxLxH) mm Dimensions	Renk Color	Koli Adeti Quantity in Carton	Fiyat Price
BL-G3-0002	12W	4000 K	1080	200 x 100 x 60	Beyaz White	36	\$16,40
BL-G3-0003	12W	6500 K	1080	200 x 100 x 60	Beyaz White	36	\$16,40
BL-G3-0005	15W	4000 K	1350	230 x 105 x 60	Beyaz White	36	\$17,60
BL-G3-0006	15W	6500 K	1350	230 x 105 x 60	Beyaz White	36	\$17,60
BL-G3-0008	12W	4000 K	1080	200 x 100 x 60	Siyah Black	36	\$16,40
BL-G3-0009	12W	6500 K	1080	200 x 100 x 60	Siyah Black	36	\$16,40
BL-G3-0011	15W	4000 K	1350	230 x 105 x 60	Siyah Black	36	\$17,60
BL-G3-0012	15W	6500 K	1350	230 x 105 x 60	Siyah Black	36	\$17,60

Led Glop Armatürler

Led Glop Armatures

Ekota Led Duvar Aplik

Teknik Özellikler:

Technical Specifications

Gövde: ABS
Body: ABS
Cam: S.A.N
Glass: S.A.N
LED Chip: Menşei Taiwan
LED Chip: Origin Taiwan
Sürücü: On-Board
Driver: On-Board
Renkssel Geri Verim: 80
CRI: 80

Koruma Sınıfı: 20
IP: 20



LED

IP20

YERLİ ÜRETİM

3 YIL GARANTİ

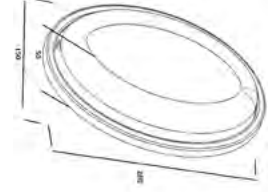

Ürün Kodu Product Code	Güç (W) Power	Renk Sıcaklığı (K) Color Temperature	Işık Akısı (Lm) Luminous Flux	Boyutlar (WxLxH) mm Dimensions	Kutu Adeti Quantity in Box	Koli Adeti Quantity in Carton	Fiyat Price
BL-B1-0001	12W	6500 K	960	150 x 260 x 50	2	36	\$8,20
BL-B1-0002	12W	3000 K	960	150 x 260 x 50	2	36	\$8,20

Ekolight Led Duvar Aplik

Teknik Özellikler:

Technical Specifications

Gövde: ABS
Body: ABS
Cam: S.A.N
Glass: S.A.N
LED Chip: Menşei Taiwan
LED Chip: Origin Taiwan
Sürücü: On-Board
Driver: On-Board
Renkssel Geri Verim: 80
CRI: 80

Koruma Sınıfı: 20
IP: 20



LED

IP20

YERLİ ÜRETİM

3 YIL GARANTİ

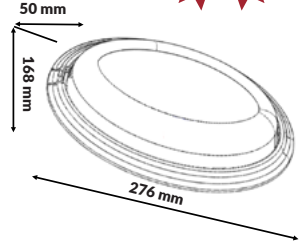

Ürün Kodu Product Code	Güç (W) Power	Renk Sıcaklığı (K) Color Temperature	Işık Akısı (Lm) Luminous Flux	Boyutlar (WxLxH) mm Dimensions	Kutu Adeti Quantity in Box	Koli Adeti Quantity in Carton	Fiyat Price
BL-B1-0003	12W	6500 K	960	168 x 276 x 50	2	36	\$8,50
BL-B1-0004	12W	3000 K	960	168 x 276 x 50	2	36	\$8,50

Nemliyer Led Duvar Aplik

Teknik Özellikler:

Technical Specifications

Gövde: ABS
Body: ABS
Cam: S.A.N
Glass: S.A.N
LED Chip: Menşei Taiwan
LED Chip: Origin Taiwan
Sürücü: On-Board
Driver: On-Board
Renkssel Geri Verim: 80
CRI: 80

Koruma Sınıfı: 65
IP: 65



LED

IP65

YERLİ ÜRETİM

3 YIL GARANTİ

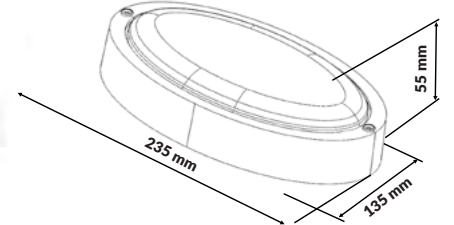

Ürün Kodu Product Code	Güç (W) Power	Renk Sıcaklığı (K) Color Temperature	Işık Akısı (Lm) Luminous Flux	Boyutlar (WxLxH) mm Dimensions	Kutu Adeti Quantity in Box	Koli Adeti Quantity in Carton	Fiyat Price
BL-B1-0005	12W	6500 K	750	135 x 235 x 55	2	36	\$9,80
BL-B1-0006	12W	3000 K	750	135 x 235 x 55	2	36	\$9,80

LED

IP65

YERLİ ÜRETİM

2 YIL GARANTİ

Teknik Özellikler:

Technical Specifications

Gövde: Alüminyum
Body: Aluminum

Cam: Temperli Cam
Glass: Tempered Glass

LED Chip: Menşei Taiwan
LED Chip: Origin Taiwan

Sürücü: On-Board
Driver: On-Board

Renkset Geri Verim: 70
CRI: 70

Koruma Sınıfı: 65
IP: 65

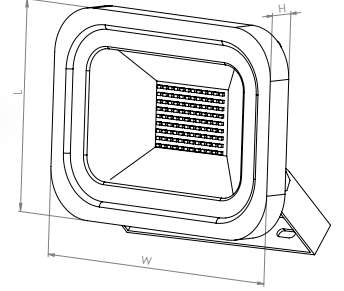

Ürün Kodu Product Code	Güç (W) Power	Renk Sıcaklığı (K) Color Temperature	Işık Akısı (Lm) Luminous Flux	Boyutlar (WxLxH) mm Dimensions	Renk Color	Koli Adeti Quantity in Carton	Fiyat Price
BL-P2-0001	10W	6500 K	800	115 x 32 x 87	Siyah Black	32	\$9,40
BL-P2-0003	10W	3000 K	800	115 x 32 x 87	Siyah Black	32	\$9,40
BL-P2-0004	20W	6500 K	1600	137 x 32 x 107	Siyah Black	32	\$13,70
BL-P2-0006	20W	3000 K	1600	137 x 32 x 107	Siyah Black	32	\$13,70
BL-P2-0007	30W	6500 K	2400	180 x 33 x 140	Siyah Black	16	\$20,00
BL-P2-0009	30W	3000 K	2400	180 x 33 x 140	Siyah Black	16	\$20,00
BL-P2-0010	50W	6500 K	4000	227 x 36 x 185	Siyah Black	10	\$28,60
BL-P2-0012	50W	3000 K	4000	227 x 36 x 185	Siyah Black	10	\$28,60
BL-P2-0013	70W	6500 K	5600	290 x 40 x 240	Siyah Black	5	\$41,30
BL-P2-0015	70W	3000 K	5600	290 x 40 x 240	Siyah Black	5	\$41,30
BL-P2-0016	100W	6500 K	8000	290 x 40 x 240	Siyah Black	5	\$59,20
BL-P2-0018	100W	3000 K	8000	290 x 40 x 240	Siyah Black	5	\$59,20
BL-P2-0019	150W	6500 K	12000	370 x 61 x 290	Siyah Black	3	\$110,90
BL-P2-0021	150W	3000 K	12000	370 x 61 x 290	Siyah Black	3	\$110,90
BL-P2-0022	200W	6500 K	16000	440 x 65 x 310	Siyah Black	3	\$137,80
BL-P2-0024	200W	3000 K	16000	440 x 65 x 310	Siyah Black	3	\$137,80

Sensörlü Led Projektör IP65

Sensor Led Projector IP65



LED

IP65



Teknik Özellikler:

Technical Specifications

Gövde: Alüminyum
Body: Aluminum

Cam: Temperli Cam
Glass: Tempered Glass

LED Chip: Menşei Taiwan
LED Chip: Origin Taiwan

Sürücü: On-Board
Driver: On-Board

Renkset Geri Verim: 70
CRI: 70

Koruma Sınıfı: 65
IP: 65

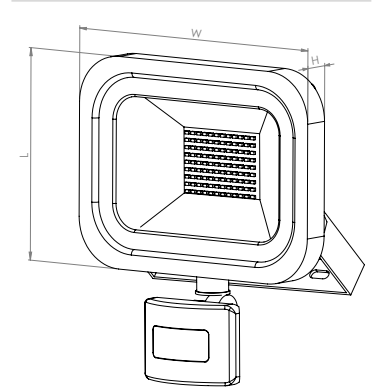

Ürün Kodu Product Code	Güç (W) Power	Renk Sıcaklığı (K) Color Temperature	Işık Akısı (Lm) Luminous Flux	Boyutlar (WxLxH) mm Dimensions	Renk Color	Koli Adeti Quantity in Carton	Fiyat Price
BL-P2-0001-S	10W	6500 K	800	115 x 32 x 87	Siyah Black	32	\$23,10
BL-P2-0003-S	10W	3000 K	800	115 x 32 x 87	Siyah Black	32	\$23,10
BL-P2-0004-S	20W	6500 K	1600	137 x 32 x 107	Siyah Black	32	\$28,10
BL-P2-0006-S	20W	3000 K	1600	137 x 32 x 107	Siyah Black	32	\$28,10
BL-P2-0007-S	30W	6500 K	2400	180 x 33 x 140	Siyah Black	16	\$34,60
BL-P2-0009-S	30W	3000 K	2400	180 x 33 x 140	Siyah Black	16	\$34,60
BL-P2-0010-S	50W	6500 K	4000	227 x 36 x 185	Siyah Black	10	\$42,30
BL-P2-0012-S	50W	3000 K	4000	227 x 36 x 185	Siyah Black	10	\$42,30



Teknik Özellikler:

Technical Specifications

Gövde: Alüminyum
Body: Aluminum

Cam: Temperli Cam
Glass: Tempered Glass

LED Chip: Menşei Taiwan
LED Chip: Origin Taiwan

Sürücü: On-Board
Driver: On-Board

Renksel Geri Verim: 70
CRI: 70

Koruma Sınıfı: 65
IP: 65

LED

IP65

YERLİ ÜRETİM

2 YIL GARANTİ

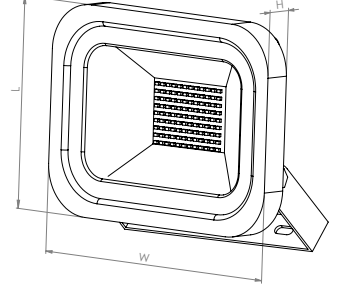

Ürün Kodu Product Code	Güç (W) Power	Renk Sıcaklığı (K) Color Temperature	Işık Akısı (Lm) Luminous Flux	Boyutlar (WxLxH) mm Dimensions	Renk Color	Koli Adeti Quantity in Carton	Fiyat Price
BL-P2-1GRN	10W	Yeşil Green	800	115 x 32 x 87	Siyah Black	32	\$8,30
BL-P2-2GRN	20W	Yeşil Green	1600	137 x 32 x 107	Siyah Black	32	\$14,40
BL-P2-3GRN	30W	Yeşil Green	2400	180 x 33 x 140	Siyah Black	16	\$19,50
BL-P2-5GRN	50W	Yeşil Green	4000	227 x 36 x 185	Siyah Black	10	\$28,00

Led Renk Değiştirilebilir Projektör IP65

Led Color Changeable Projector IP65

Teknik Özellikler:

Technical Specifications

Gövde: Alüminyum
Body: Aluminum

Cam: Temperli Cam
Glass: Tempered Glass

LED Chip: Menşei Taiwan
LED Chip: Origin Taiwan

Sürücü: On-Board
Driver: On-Board

Renksel Geri Verim: 70
CRI: 70

Koruma Sınıfı: 65
IP: 65

YENİ

LED

IP65

YERLİ ÜRETİM

2 YIL GARANTİ

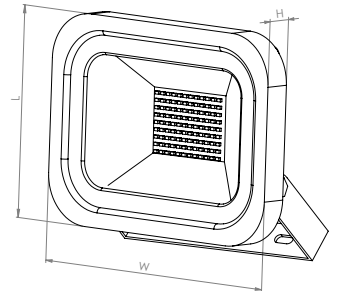

Ürün Kodu Product Code	Güç (W) Power	Renk Sıcaklığı (K) Color Temperature	Işık Akısı (Lm) Luminous Flux	Boyutlar (WxLxH) mm Dimensions	Renk Color	Koli Adeti Quantity in Carton	Fiyat Price
BL-P2-0050	50W	3000-4000-6500 K	4000	227 x 36 x 185	Siyah Black	10	\$44,20
BL-P2-0070	70W	3000-4000-6500 K	5600	290 x 40 x 240	Siyah Black	5	\$64,60
BL-P2-0100	100W	3000-4000-6500 K	8000	290 x 40 x 240	Siyah Black	5	\$73,40
BL-P2-0150	150W	3000-4000-6500 K	12000	370 x 61 x 290	Siyah Black	3	\$124,00
BL-P2-0200	200W	3000-4000-6500 K	16000	440 x 65 x 310	Siyah Black	3	\$162,50

Led Ray Spot

Led Rail Spot



Teknik Özellikler:

Technical Specifications



LED

IP20



Gövde: Alüminyum
Body: Aluminum

Cam: Akrilik
Glass: Acrylic

LED Chip: Samsung
LED Chip: Samsung

Sürücü: Eagrise/Tridonic
Driver: Eagrise/Tridonic

Renkset Geri Verim: 80
CRI: 80

Koruma Sınıfı: 20
IP: 20

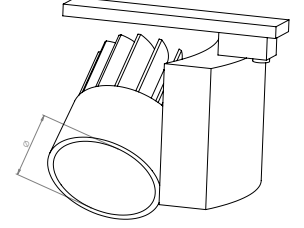

Ürün Kodu Product Code	Güç (W) Power	Renk Sıcaklığı (K) Color Temperature	Işık Akısı (Lm) Luminous Flux	Boyutlar (Ø) mm Dimensions	Renk Color	Koli Adeti Quantity in Carton	Fiyat Price
BL-RS-0001	40W	3000 K	4000	115	Siyah Black	8	\$67,70
BL-RS-0002	40W	4000 K	4000	115	Siyah Black	8	\$67,70
BL-RS-0003	40W	6500 K	4000	115	Siyah Black	8	\$67,70
BL-RS-1001	40W	3000 K	4000	115	Beyaz White	8	\$67,70
BL-RS-1002	40W	4000 K	4000	115	Beyaz White	8	\$67,70
BL-RS-1003	40W	6500 K	4000	115	Beyaz White	8	\$67,70



Teknik Özellikler:

Technical Specifications

Gövde: Alüminyum
Body: Aluminum

Cam: Temperli Cam
Glass: Tempered Glass

LED Chip: Menşei Taiwan
LED Chip: Origin Taiwan

Sürücü: Menşei Taiwan
Driver: Origin Taiwan

Renkset Geri Verim: 70
CRI: 70

Koruma Sınıfı: 65
IP: 65

LED

IP65

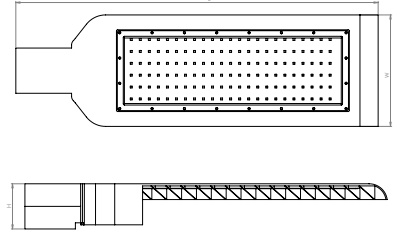

Ürün Kodu Product Code	Güç (W) Power	Renk Sıcaklığı (K) Color Temperature	Işık Akısı (Lm) Luminous Flux	Boyutlar (WxLxH) mm Dimensions	Renk Color	Koli Adeti Quantity in Carton	Fiyat Price
BL-C2-2001	60W	3000 K	5400	150 x 63 x 400	Gri Grey	4	\$75,30
BL-C2-2002	60W	6500 K	5400	150 x 63 x 400	Gri Grey	4	\$75,30
BL-C2-2003	90W	3000 K	8100	165 x 63 x 465	Gri Grey	4	\$87,80
BL-C2-2004	90W	6500 K	8100	165 x 63 x 465	Gri Grey	4	\$87,80
BL-C2-2005	120W	3000 K	10800	180 x 73 x 585	Gri Grey	4	\$118,80
BL-C2-2006	120W	6500 K	10800	180 x 73 x 585	Gri Grey	4	\$118,80

LED



Ürün Kodu Product Code	Güç (W/Mt) Power	Gerilim (V) Voltage (V)	Işık Akısı (Lm/Mt) Luminous Flux	Çip Sayısı Number of Chips	Renk Color	Koli Miktarı (Mt) Box Amount (Mt)	Fiyat Price
BL-SL-1001	14.4	12V	900	60	3000 K	250 Mt	\$1,80
BL-SL-1002	14.4	12V	900	60	6500 K	250 Mt	\$1,80
BL-SL-1003	14.4	12V	120	60	Mavi Blue	250 Mt	\$1,80
BL-SL-1004	14.4	12V	120	60	Yeşil Green	250 Mt	\$2,00
BL-SL-1005	14.4	12V	120	60	Amber Amber	250 Mt	\$2,00

Şerit Led Trafoları

Strip Led Transformers

LED

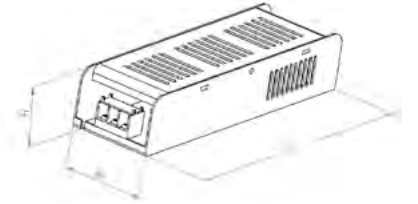

Ürün Kodu Product Code	Güç (W) Power	Akım (A) Current (A)	Voltaj (V) Voltage (V)	Boyutlar (WxLxH) mm Dimensions	Gövde Malzemesi Body Material	Koli Adeti Quantity in Carton	Fiyat Price
BL-T1-132-1599	60W	5A	12V	40 x 160 x 32	Alüminyum	50	\$10,80
BL-T1-132-1600	120W	10A	12V	46 x 190 x 37	Alüminyum	40	\$13,40
BL-T1-132-1601	150W	12,5A	12V	58 x 200 x 40	Alüminyum	40	\$17,90
BL-T1-132-1602	200W	16,5A	12V	58 x 200 x 40	Alüminyum	40	\$21,70
BL-T1-132-1603	250W	20A	12V	68 x 225 x 40	Alüminyum	32	\$24,10
BL-T1-132-1604	360W	30A	12V	68 x 225 x 42	Alüminyum	32	\$28,10

Ufo Tavan Armatür (1xE27 Duylu)

Teknik Özellikler:

Technical Specifications

Gövde: ABS
Body: ABS

Cam: S.A.N
Glass: S.A.N

Gofraj: Alüminyum
Embossing: Aluminum

Koruma Sınıfı: 20
IP: 20

Kullanım: Tasarruf/Led Ampül
Usage: Saving / Led Bulb



IP20

YERLİ ÜRETİM

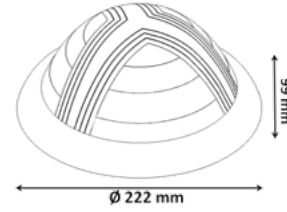

Ürün Kodu Product Code	Renk White	Boyutlar (ØxH) mm Dimensions	Kutu Adeti Quantity in Box	Koli Adeti Quantity in Carton	Fiyat Price
BR-00203-000	Beyaz White	222 x 99	2	36	₺19,60

Ufoline Tavan Armatür (1xE27 Duylu)

Teknik Özellikler:

Technical Specifications

Gövde: ABS
Body: ABS

Cam: S.A.N
Glass: S.A.N

Gofraj: Alüminyum
Embossing: Aluminum

Koruma Sınıfı: 20
IP: 20

Kullanım: Tasarruf/Led Ampül
Usage: Saving / Led Bulb



IP20

YERLİ ÜRETİM

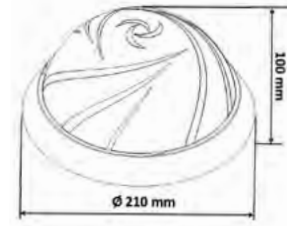

Ürün Kodu Product Code	Renk White	Boyutlar (ØxH) mm Dimensions	Kutu Adeti Quantity in Box	Koli Adeti Quantity in Carton	Fiyat Price
BR-00248-000	Beyaz White	222 x 99	2	36	₺19,60

Ufolux Tavan Armatür (1xE27 Duylu)

Teknik Özellikler:

Technical Specifications

Gövde: ABS
Body: ABS

Cam: S.A.N
Glass: S.A.N

Gofraj: Alüminyum
Embossing: Aluminum

Koruma Sınıfı: 20
IP: 20

Kullanım: Tasarruf/Led Ampül
Usage: Saving / Led Bulb



IP20

YERLİ ÜRETİM

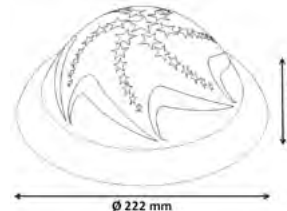

Ürün Kodu Product Code	Renk White	Boyutlar (ØxH) mm Dimensions	Kutu Adeti Quantity in Box	Koli Adeti Quantity in Carton	Fiyat Price
BR-00203-010	Beyaz White	222 x 99	2	36	₺20,80

Güneş Tavan Armatür (1xE27 Duyulu)

Teknik Özellikler:

Technical Specifications

Gövde: ABS
Body: ABS

Cam: S.A.N
Glass: S.A.N

Gofraj: Alüminyum
Embossing: Aluminum

Koruma Sınıfı: 20
IP: 20

Kullanım: Tasarruf/Led Ampül
Usage: Saving / Led Bulb

IP20

YERLİ ÜRETİM



Ürün Kodu Product Code	Renk White	Boyutlar (ØxH) mm Dimensions	Kutu Adeti Quantity in Box	Koli Adeti Quantity in Carton	Fiyat Price
BR-00203-020	Beyaz White	222 x 99	2	36	₺19,90

Vega Tavan Armatür (1xE27 Duyulu)

Teknik Özellikler:

Technical Specifications

Gövde: ABS
Body: ABS

Cam: S.A.N
Glass: S.A.N

Gofraj: Alüminyum
Embossing: Aluminum

Koruma Sınıfı: 20
IP: 20

Kullanım: Tasarruf/Led Ampül
Usage: Saving / Led Bulb

IP20

YERLİ ÜRETİM

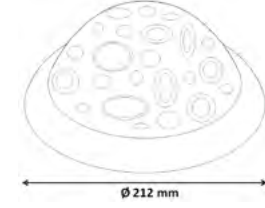

Ürün Kodu Product Code	Renk White	Boyutlar (ØxH) mm Dimensions	Kutu Adeti Quantity in Box	Koli Adeti Quantity in Carton	Fiyat Price
BR-00248-010	Beyaz White	212 x 98	2	36	₺19,70

İsis Tavan Armatür (1xE27 Duyulu)

Teknik Özellikler:

Technical Specifications

Gövde: ABS
Body: ABS

Cam: S.A.N
Glass: S.A.N

Gofraj: Alüminyum
Embossing: Aluminum

Koruma Sınıfı: 20
IP: 20

Kullanım: Tasarruf/Led Ampül
Usage: Saving / Led Bulb

IP20

YERLİ ÜRETİM

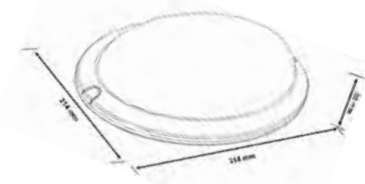

Ürün Kodu Product Code	Renk White	Boyutlar (WxLxH) mm Dimensions	Kutu Adeti Quantity in Box	Koli Adeti Quantity in Carton	Fiyat Price
BR-00244-000	Beyaz White	214 x 314 x 88	2	24	₺36,40

Asos Tavan Armatür (1xE27 Duyulu)

Teknik Özellikler:

Technical Specifications

Gövde: ABS
Body: ABS

Cam: S.A.N
Glass: S.A.N

Gofraj: Alüminyum
Embossing: Aluminum

Koruma Sınıfı: 20
IP: 20

Kullanım: Tasarruf/Led Ampül
Usage: Saving / Led Bulb

IP20

YERLİ ÜRETİM

3 YIL GARANTİ

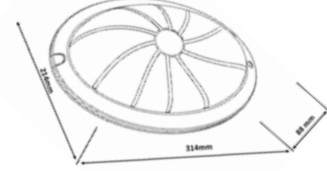

Ürün Kodu Product Code	Renk White	Boyutlar (WxLxH) mm Dimensions	Kutu Adeti Quantity in Box	Koli Adeti Quantity in Carton	Fiyat Price
BR-00244-010	Beyaz White	214 x 314 x 88	2	24	₺36,00

Kare Tavan Armatür (1xE27 Duyulu)

Teknik Özellikler:

Technical Specifications

Gövde: ABS
Body: ABS

Cam: S.A.N
Glass: S.A.N

Gofraj: Alüminyum
Embossing: Aluminum

Koruma Sınıfı: 20
IP: 20

Kullanım: Tasarruf/Led Ampül
Usage: Saving / Led Bulb

IP20

YERLİ ÜRETİM

3 YIL GARANTİ

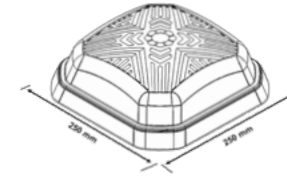

Ürün Kodu Product Code	Renk White	Boyutlar (WxLxH) mm Dimensions	Kutu Adeti Quantity in Box	Koli Adeti Quantity in Carton	Fiyat Price
BR-00242-000	Beyaz White	250 x 250 x 93	2	24	₺38,70

Kare Soft Tavan Armatür (1xE27 Duyulu)

Teknik Özellikler:

Technical Specifications

Gövde: ABS
Body: ABS

Cam: S.A.N
Glass: S.A.N

Gofraj: Alüminyum
Embossing: Aluminum

Koruma Sınıfı: 20
IP: 20

Kullanım: Tasarruf/Led Ampül
Usage: Saving / Led Bulb

IP20

YERLİ ÜRETİM

3 YIL GARANTİ

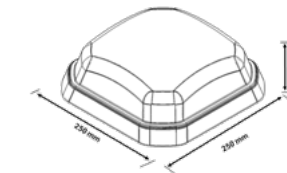

Ürün Kodu Product Code	Renk White	Boyutlar (WxLxH) mm Dimensions	Kutu Adeti Quantity in Box	Koli Adeti Quantity in Carton	Fiyat Price
BR-00242-010	Beyaz White	250 x 250 x 93	2	24	₺37,70

Venüs Tavan Armatür (1xE27 Duyulu)

Teknik Özellikler:

Technical Specifications

Gövde: ABS
Body: ABS

Cam: S.A.N
Glass: S.A.N

Gofraj: Alüminyum
Embossing: Aluminum

Koruma Sınıfı: 20
IP: 20

Kullanım: Tasarruf/Led Ampül
Usage: Saving / Led Bulb



IP20

YERLİ ÜRETİM

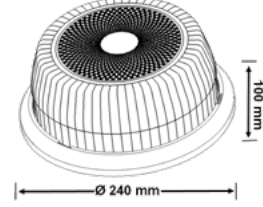

Ürün Kodu Product Code	Renk White	Boyutlar (ØxH) mm Dimensions	Kutu Adeti Quantity in Box	Koli Adeti Quantity in Carton	Fiyat Price
BR-00201-000	Beyaz White	240 x 100	2	36	₺34,80

Yasmin Tavan Armatür (1xE27 Duyulu)

Teknik Özellikler:

Technical Specifications

Gövde: ABS
Body: ABS

Cam: S.A.N
Glass: S.A.N

Gofraj: Alüminyum
Embossing: Aluminum

Koruma Sınıfı: 20
IP: 20

Kullanım: Tasarruf/Led Ampül
Usage: Saving / Led Bulb



IP20

YERLİ ÜRETİM

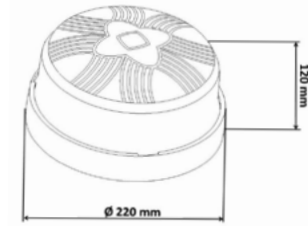

Ürün Kodu Product Code	Renk White	Boyutlar (ØxH) mm Dimensions	Kutu Adeti Quantity in Box	Koli Adeti Quantity in Carton	Fiyat Price
BR-00245-000	Beyaz White	220 x 125	2	36	₺27,90

Neptün Tavan Armatür (1xE27 Duyulu)

Teknik Özellikler:

Technical Specifications

Gövde: ABS
Body: ABS

Cam: S.A.N
Glass: S.A.N

Gofraj: Alüminyum
Embossing: Aluminum

Koruma Sınıfı: 20
IP: 20

Kullanım: Tasarruf/Led Ampül
Usage: Saving / Led Bulb



IP20

YERLİ ÜRETİM

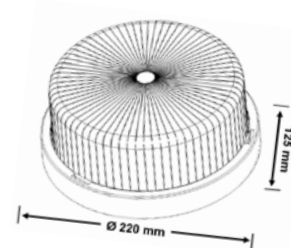

Ürün Kodu Product Code	Renk White	Boyutlar (ØxH) mm Dimensions	Kutu Adeti Quantity in Box	Koli Adeti Quantity in Carton	Fiyat Price
BR-00245-010	Beyaz White	220 x 125	2	36	₺30,10

Uzay Tavan Armatür (1xE27 Duylu)

Teknik Özellikler:

Technical Specifications

Gövde: ABS
Body: ABS

Cam: S.A.N
Glass: S.A.N

Gofraj: Alüminyum
Embossing: Aluminum

Koruma Sınıfı: 20
IP: 20

Kullanım: Tasarruf/Led Ampül
Usage: Saving / Led Bulb



IP20

YERLİ ÜRETİM

3 YIL GARANTİ



Ürün Kodu Product Code	Renk White	Boyutlar (ØxH) mm Dimensions	Kutu Adeti Quantity in Box	Koli Adeti Quantity in Carton	Fiyat Price
BR-00201-010	Beyaz White	240 x 97	2	36	₺ 35,40

İstanbul Tavan Armatür (2xE27 Duylu)

Teknik Özellikler:

Technical Specifications

Gövde: ABS
Body: ABS

Cam: S.A.N
Glass: S.A.N

Gofraj: Alüminyum
Embossing: Aluminum

Koruma Sınıfı: 20
IP: 20

Kullanım: Tasarruf/Led Ampül
Usage: Saving / Led Bulb



IP20

YERLİ ÜRETİM

3 YIL GARANTİ

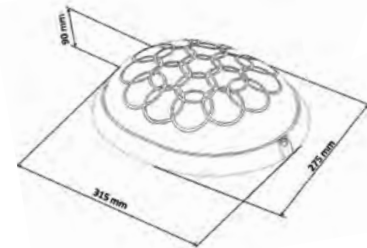

Ürün Kodu Product Code	Renk White	Boyutlar (WxLxH) mm Dimensions	Kutu Adeti Quantity in Box	Koli Adeti Quantity in Carton	Fiyat Price
BR-00247-000	Beyaz White	315 x 275 x 90	2	12	₺ 47,80

Bosphorus Tavan Armatür (2xE27 Duylu)

Teknik Özellikler:

Technical Specifications

Gövde: ABS
Body: ABS

Cam: S.A.N
Glass: S.A.N

Gofraj: Alüminyum
Embossing: Aluminum

Koruma Sınıfı: 20
IP: 20

Kullanım: Tasarruf/Led Ampül
Usage: Saving / Led Bulb



IP20

YERLİ ÜRETİM

3 YIL GARANTİ

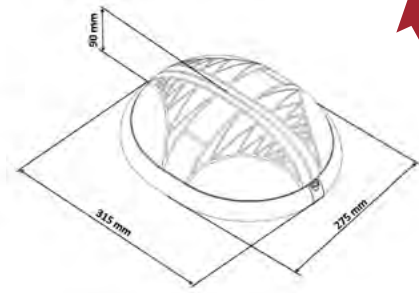

Ürün Kodu Product Code	Renk White	Boyutlar (WxLxH) mm Dimensions	Kutu Adeti Quantity in Box	Koli Adeti Quantity in Carton	Fiyat Price
BR-00247-010	Beyaz White	315 x 275 x 90	2	12	₺ 45,60

Gök Sıva Altı Tavan Armatür (2xE27 Duylu)

Teknik Özellikler:

Technical Specifications

Gövde: ABS
Body: ABS

Cam: S.A.N
Glass: S.A.N

Gofraj: Alüminyum
Embossing: Aluminum

Koruma Sınıfı: 20
IP: 20

Kullanım: Tasarruf/Led Ampül
Usage: Saving / Led Bulb

IP20

YERLİ ÜRETİM

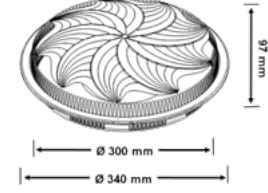

Ürün Kodu Product Code	Renk White	Boyutlar (ØxH) mm Dimensions	Kutu Adeti Quantity in Box	Koli Adeti Quantity in Carton	Fiyat Price
BR-00230-002	Beyaz White	340 x 97	1	12	₺ 70,80

Gök Sıva Üstü Tavan Glop Armatür (2xE27 Duylu)

Teknik Özellikler:

Technical Specifications

Gövde: ABS
Body: ABS

Cam: S.A.N
Glass: S.A.N

Gofraj: Alüminyum
Embossing: Aluminum

Koruma Sınıfı: 20
IP: 20

Kullanım: Tasarruf/Led Ampül
Usage: Saving / Led Bulb

IP20

YERLİ ÜRETİM

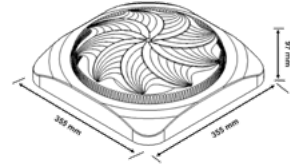

Ürün Kodu Product Code	Renk White	Boyutlar (WxLxH) mm Dimensions	Kutu Adeti Quantity in Box	Koli Adeti Quantity in Carton	Fiyat Price
BR-00230-000	Beyaz White	355 x 355 x 97	1	12	₺ 92,20

Gök Soft Tavan Glop Armatür (2xE27 Duylu)

Teknik Özellikler:

Technical Specifications

Gövde: ABS
Body: ABS

Cam: S.A.N
Glass: S.A.N

Gofraj: Alüminyum
Embossing: Aluminum

Koruma Sınıfı: 20
IP: 20

Kullanım: Tasarruf/Led Ampül
Usage: Saving / Led Bulb

IP20

YERLİ ÜRETİM

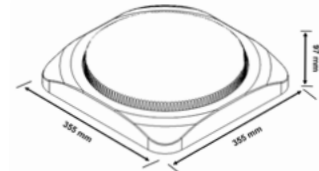

Ürün Kodu Product Code	Renk White	Boyutlar (WxLxH) mm Dimensions	Kutu Adeti Quantity in Box	Koli Adeti Quantity in Carton	Fiyat Price
BR-00230-010	Beyaz White	355 x 355 x 97	1	12	₺ 91,00

Zümrüt Tavan Glop Armatür (2xE27 Duyulu)

Teknik Özellikler:

Technical Specifications

Gövde: DKP Sac
Body: DKP Metal Sheet

Difüzör: Cam
Diffuser: Glass

Koruma Sınıfı: 20
IP: 20

Kullanım: Tasarruf/Led Ampül
Usage: Saving / Led Bulb



IP20

YERLİ ÜRETİM

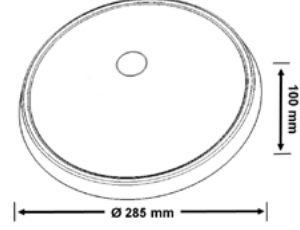

Ürün Kodu Product Code	Renk White	Boyutlar (ØxH) mm Dimensions	Kutu Adeti Quantity in Box	Koli Adeti Quantity in Carton	Fiyat Price
BR-00243-050	Beyaz White	285 x 100	1	10	₺78,20

Okyanus Tavan Armatür (2xE27 Duyulu)

Teknik Özellikler:

Technical Specifications

Gövde: ABS
Body: ABS

Cam: S.A.N
Glass: S.A.N

Gofraj: Alüminyum
Embossing: Aluminum

Koruma Sınıfı: 20
IP: 20

Kullanım: Tasarruf/Led Ampül
Usage: Saving / Led Bulb



IP20

YERLİ ÜRETİM

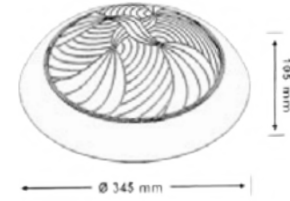

Ürün Kodu Product Code	Renk White	Boyutlar (ØxH) mm Dimensions	Kutu Adeti Quantity in Box	Koli Adeti Quantity in Carton	Fiyat Price
BR-00231-000	Beyaz White	345 x 105	2	12	₺ 41,80

Okyanus Soft Tavan Armatür (2xE27 Duyulu)

Teknik Özellikler:

Technical Specifications

Gövde: ABS
Body: ABS

Cam: S.A.N
Glass: S.A.N

Gofraj: Alüminyum
Embossing: Aluminum

Koruma Sınıfı: 20
IP: 20

Kullanım: Tasarruf/Led Ampül
Usage: Saving / Led Bulb



IP20

YERLİ ÜRETİM

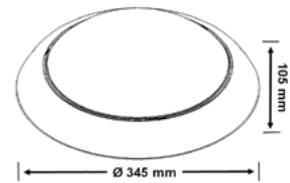

Ürün Kodu Product Code	Renk White	Boyutlar (ØxH) mm Dimensions	Kutu Adeti Quantity in Box	Koli Adeti Quantity in Carton	Fiyat Price
BR-00231-010	Beyaz White	345 x 105	2	12	₺ 41,80

Tavan Armatürleri

Ceiling Fixtures

Zümrüt Sensörlü Tavan Armatür (2xE27 Duyulu)

Teknik Özellikler:

Technical Specifications

Gövde: DKP Sac
Body: DKP Metal Sheet

Difüzör: Cam
Diffuser: Glass

Koruma Sınıfı: 20
IP: 20

Kullanım: Tasarruf/Led Ampül
Usage: Saving / Led Bulb



IP20

YERLİ ÜRETİM

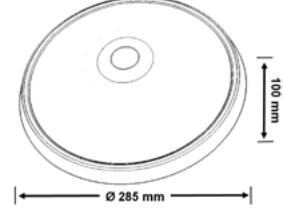

Ürün Kodu Product Code	Renk White	Boyutlar (ØxH) mm Dimensions	Kutu Adeti Quantity in Box	Koli Adeti Quantity in Carton	Fiyat Price
BR-10243 050	Beyaz White	285 x 100	1	10	₺136,70

Zümrüt Sensörlü Tavan Armatür + Acil Kit (2xE27 Duyulu)

Teknik Özellikler:

Technical Specifications

Gövde: DKP Sac
Body: DKP Metal Sheet

Difüzör: Cam
Diffuser: Glass

Koruma Sınıfı: 20
IP: 20

Kullanım: Tasarruf/Led Ampül
Usage: Saving / Led Bulb



IP20

YERLİ ÜRETİM

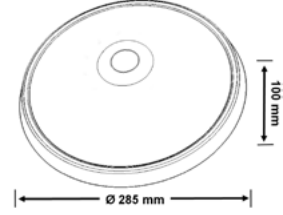

Ürün Kodu Product Code	Renk White	Boyutlar (ØxH) mm Dimensions	Kutu Adeti Quantity in Box	Koli Adeti Quantity in Carton	Fiyat Price
BR-C0243-050	Beyaz White	285 x 100	1	10	₺186,50

Atlantik Tavan Glop Armatür (2xE27 Duyulu)

Teknik Özellikler:

Technical Specifications

Gövde: ABS
Body: ABS

Cam: S.A.N
Glass: S.A.N

Gofraj: Alüminyum
Embossing: Aluminum

Koruma Sınıfı: 20
IP: 20

Kullanım: Tasarruf/Led Ampül
Usage: Saving / Led Bulb



IP20

YERLİ ÜRETİM

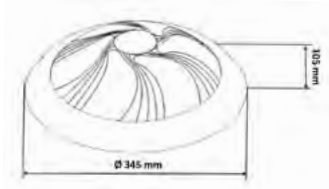

Ürün Kodu Product Code	Renk White	Boyutlar (ØxH) mm Dimensions	Kutu Adeti Quantity in Box	Koli Adeti Quantity in Carton	Fiyat Price
BR-00231-020	Beyaz White	345 x 105	2	12	₺42,20

Led Zümrüt Sensörlü Tavan Glop Armatür

Teknik Özellikler:

Technical Specifications

Gövde: DKP Sac
Body: DKP Metal Sheet

Difüzör: Cam
Diffuser: Glass

LED Chip: Menşei Taiwan
LED Chip: Origin Taiwan

Sürücü: Menşei Taiwan
Driver: Origin Taiwan

Renksel Geri Verim: 80
CRI: 80

Koruma Sınıfı: 20
IP: 20

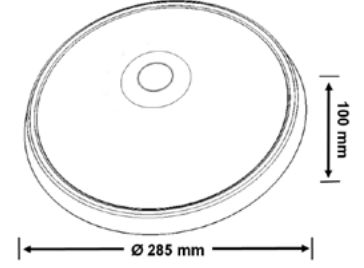

LED

IP20

YERLİ ÜRETİM

Ürün Kodu Product Code	Güç (W) Power	Renk Sıcaklığı (K) Color Temperature	Işık Akısı (Lm) Luminous Flux	Boyutlar (ØxH) mm Dimensions	Koli Adeti Quantity in Carton	Fiyat Price
BL-B1-0021	12W	6500 K	1300	285 x 100	36	\$24,70
BL-B1-0022	12W	4000 K	1300	285 x 100	36	\$24,70

Led Zümrüt Sensörlü Tavan Glop Armatür + Acil Kit

Teknik Özellikler:

Technical Specifications

Gövde: DKP Sac
Body: DKP Metal Sheet

Difüzör: Cam
Diffuser: Glass

LED Chip: Menşei Taiwan
LED Chip: Origin Taiwan

Sürücü: Menşei Taiwan
Driver: Origin Taiwan

Renksel Geri Verim: 80
CRI: 80

Koruma Sınıfı: 20
IP: 20

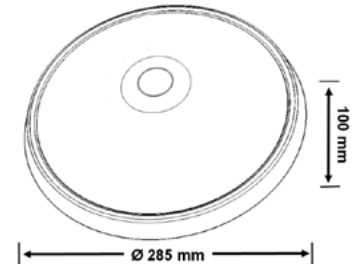

LED

IP20

YERLİ ÜRETİM

Ürün Kodu Product Code	Güç (W) Power	Renk Sıcaklığı (K) Color Temperature	Işık Akısı (Lm) Luminous Flux	Boyutlar (ØxH) mm Dimensions	Koli Adeti Quantity in Carton	Fiyat Price
BL-B1-0024	12W	6500 K	1300	285 x 100	36	\$36,50
BL-B1-0025	12W	4000 K	1300	285 x 100	36	\$36,50



İnci Tavan Armatür (1xE27 Duylu)

Teknik Özellikler:

Technical Specifications

Gövde: DKP Sac
Body: DKP Metal Sheet

Cam: S.A.N
Glass: S.A.N

Koruma Sınıfı: 20
IP: 20

Kullanım: Tasarruf/Led Ampül
Usage: Saving / Led Bulb



IP20

YERLİ ÜRETİM

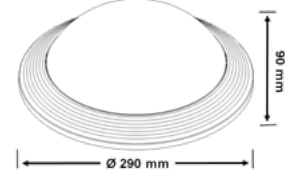

Ürün Kodu Product Code	Renk White	Boyutlar (ØxH) mm Dimensions	Kutu Adeti Quantity in Box	Koli Adeti Quantity in Carton	Fiyat Price
BR-00206-010	Beyaz White	290 x 90	2	16	₺42,40

Yakut Tavan Armatür (1xE27 Duylu)

Teknik Özellikler:

Technical Specifications

Gövde: DKP Sac
Body: DKP Metal Sheet

Cam: S.A.N
Glass: S.A.N

Koruma Sınıfı: 20
IP: 20

Kullanım: Tasarruf/Led Ampül
Usage: Saving / Led Bulb



IP20

YERLİ ÜRETİM

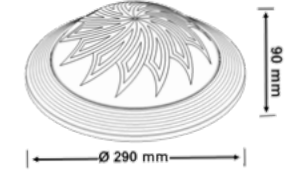

Ürün Kodu Product Code	Renk White	Boyutlar (ØxH) mm Dimensions	Kutu Adeti Quantity in Box	Koli Adeti Quantity in Carton	Fiyat Price
BR-00206-000	Beyaz White	290 x 90	2	16	₺43,50

Duvar Aplik Armatürleri (1xE27 Duylu)

Wall Luminare (1xE27 Lampholder)

Petek Dekoratif Duvar Aplik Armatür (1xE27 Duy)

Teknik Özellikler:

Technical Specifications

Gövde: ABS
Body: ABS

Cam: S.A.N
Glass: S.A.N

Gofraj: Alüminyum
Embossing: Aluminum

Koruma Sınıfı: 44
IP: 44

Kullanım: Tasarruf/Led Ampül
Usage: Saving / Led Bulb



IP44

YERLİ ÜRETİM

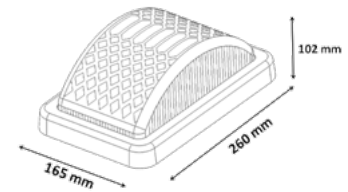

Ürün Kodu Product Code	Renk White	Boyutlar (WxLxH) mm Dimensions	Kutu Adeti Quantity in Box	Koli Adeti Quantity in Carton	Fiyat Price
BR-00220-010	Beyaz White	260 x 165 x 102	1	20	₺52,80

Petek Kafesli Dekoratif Duvar Aplik Armatür (1xE27 Duyulu)

Teknik Özellikler:

Technical Specifications

Gövde: ABS
Body: ABS

Cam: S.A.N
Glass: S.A.N

Gofraj: Alüminyum
Embossing: Aluminum

Koruma Sınıfı: 44
IP: 44

Kullanım: Tasarruf/Led Ampül
Usage: Saving / Led Bulb



IP44

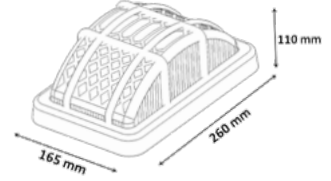

Ürün Kodu Product Code	Renk White	Boyutlar (WxLxH) mm Dimensions	Kutu Adeti Quantity in Box	Koli Adeti Quantity in Carton	Fiyat Price
BR-00220-011	Beyaz White	260 x 165 x 102	1	20	₺56,10

Şah Duvar Aplik Armatür (1xE27 Duyulu)

Teknik Özellikler:

Technical Specifications

Gövde: ABS
Body: ABS

Cam: S.A.N
Glass: S.A.N

Koruma Sınıfı: 40
IP: 40

Kullanım: Tasarruf/Led Ampül
Usage: Saving / Led Bulb



IP40

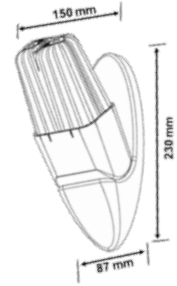

Ürün Kodu Product Code	Renk White	Boyutlar (WxLxH) mm Dimensions	Kutu Adeti Quantity in Box	Koli Adeti Quantity in Carton	Fiyat Price
BR-00309-000	Beyaz White	150 x 87 x 230	1	48	₺26,60

Ayna Üstü Duvar Aplik Armatür (2xE14 Duyulu)

Teknik Özellikler:

Technical Specifications

Gövde: ABS
Body: ABS

Cam: S.A.N
Glass: S.A.N

Koruma Sınıfı: 20
IP: 20

Kullanım: Tasarruf/Led Ampül
Usage: Saving / Led Bulb



IP20

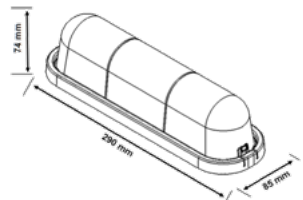

Ürün Kodu Product Code	Renk White	Boyutlar (WxLxH) mm Dimensions	Kutu Adeti Quantity in Box	Koli Adeti Quantity in Carton	Fiyat Price
BR-00235-000	Beyaz White	290 x 85 x 74	1	48	₺32,40

Duvar Aplik Armatürleri

Wall Luminare



Kral Kafesli Dekoratif Duvar Aplik Armatür (1xE27 Duyulu)

Teknik Özellikler:

Technical Specifications

Gövde: ABS

Body: ABS

Cam: S.A.N

Glass: S.A.N

Gofraj: Alüminyum

Embossing: Aluminum

Koruma Sınıfı: 44

IP: 44

Kullanım: Tasarruf/Led Ampül

Usage: Saving / Led Bulb

IP44

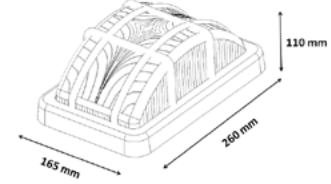

Ürün Kodu Product Code	Renk White	Boyutlar (WxLxH) mm Dimensions	Kutu Adeti Quantity in Box	Koli Adeti Quantity in Carton	Fiyat Price
BR-00220-001	Beyaz White	260 x 165 x 110	1	20	₺56,80

Kral Dekoratif Duvar Aplik Armatür (1xE27 Duyulu)

Teknik Özellikler:

Technical Specifications

Gövde: ABS

Body: ABS

Cam: S.A.N

Glass: S.A.N

Gofraj: Alüminyum

Embossing: Aluminum

Koruma Sınıfı: 44

IP: 44

Kullanım: Tasarruf/Led Ampül

Usage: Saving / Led Bulb

IP44

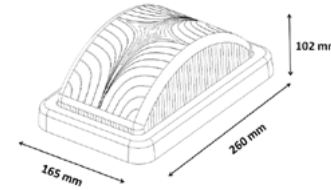

Ürün Kodu Product Code	Renk White	Boyutlar (WxLxH) mm Dimensions	Kutu Adeti Quantity in Box	Koli Adeti Quantity in Carton	Fiyat Price
BR-00220-000	Beyaz White	260 x 165 x 102	1	20	₺53,50

Kraliçe Duvar Aplik Armatür (1xE27 Duyulu)

Teknik Özellikler:

Technical Specifications

Gövde: ABS

Body: ABS

Cam: S.A.N

Glass: S.A.N

Koruma Sınıfı: 20

IP: 20

Kullanım: Tasarruf/Led Ampül

Usage: Saving / Led Bulb

IP20

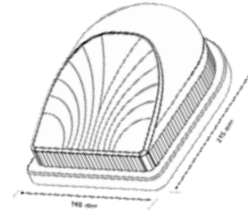

Ürün Kodu Product Code	Renk White	Boyutlar (WxLxH) mm Dimensions	Kutu Adeti Quantity in Box	Koli Adeti Quantity in Carton	Fiyat Price
BR-00306-000	Beyaz White	166 x 236 x 114	2	36	₺23,20



Nemliyer Dekoratif Duvar Aplik Armatür (1xE27 Duyulu)

Teknik Özellikler:

Technical Specifications

Gövde: ABS
Body: ABS

Cam: S.A.N
Glass: S.A.N

Gofraj: Alüminyum
Embossing: Aluminum

Koruma Sınıfı: 65
IP: 65

Kullanım: Tasarruf/Led Ampül
Usage: Saving / Led Bulb



IP65

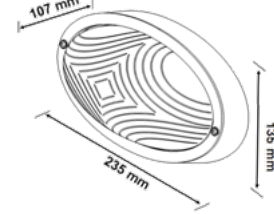

Ürün Kodu Product Code	Renk White	Boyutlar (WxLxH) mm Dimensions	Kutu Adeti Quantity in Box	Koli Adeti Quantity in Carton	Fiyat Price
BR-00222-000	Beyaz White	235 x 135 x 107	1	20	₺42,00

Ekota Duvar Aplik Armatür (1xE27 Duyulu)

Teknik Özellikler:

Technical Specifications

Gövde: ABS
Body: ABS

Cam: S.A.N
Glass: S.A.N

Koruma Sınıfı: 20
IP: 20

Kullanım: Tasarruf/Led Ampül
Usage: Saving / Led Bulb



IP20

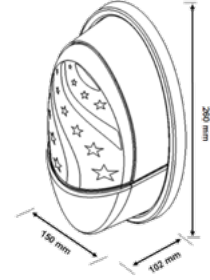

Ürün Kodu Product Code	Renk White	Boyutlar (WxLxH) mm Dimensions	Kutu Adeti Quantity in Box	Koli Adeti Quantity in Carton	Fiyat Price
BR-00307-000	Beyaz White	276 x 168 x 100	2	36	₺28,60

Ekolight Duvar Aplik Armatür (1xE27 Duyulu)

Teknik Özellikler:

Technical Specifications

Gövde: ABS
Body: ABS

Cam: S.A.N
Glass: S.A.N

Koruma Sınıfı: 20
IP: 20

Kullanım: Tasarruf/Led Ampül
Usage: Saving / Led Bulb



IP20

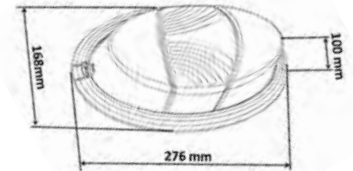

Ürün Kodu Product Code	Renk White	Boyutlar (WxLxH) mm Dimensions	Kutu Adeti Quantity in Box	Koli Adeti Quantity in Carton	Fiyat Price
BR-00246-000	Beyaz White	276 x 168 x 100	2	36	₺30,90

Duvar Aplik Armatürleri

Wall Luminare

Nemliyer Kafesli Dekoratif Duvar Aplik Armatür (1xE27 Duyulu)

Teknik Özellikler:

Technical Specifications

Gövde: ABS
Body: ABS

Cam: S.A.N
Glass: S.A.N

Gofraj: Alüminyum
Embossing: Aluminum

Koruma Sınıfı: 65
IP: 65

Kullanım: Tasarruf/Led Ampül
Usage: Saving / Led Bulb

IP65

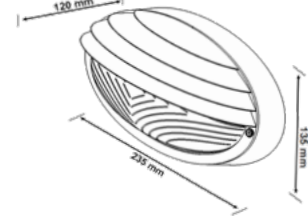

Ürün Kodu Product Code	Renk White	Boyutlar (WxLxH) mm Dimensions	Kutu Adeti Quantity in Box	Koli Adeti Quantity in Carton	Fiyat Price
BR-00222-001	Beyaz White	235 x 135 x 107	1	20	₺50,50

Ekosoft Duvar Aplik Armatür (1xE27 Duyulu)

Teknik Özellikler:

Technical Specifications

Gövde: ABS
Body: ABS

Cam: S.A.N
Glass: S.A.N

Koruma Sınıfı: 20
IP: 20

Kullanım: Tasarruf/Led Ampül
Usage: Saving / Led Bulb

IP20

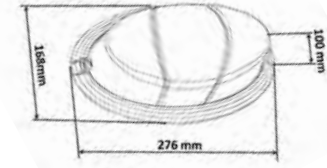

Ürün Kodu Product Code	Renk White	Boyutlar (WxLxH) mm Dimensions	Kutu Adeti Quantity in Box	Koli Adeti Quantity in Carton	Fiyat Price
BR-00246-010	Beyaz White	276 x 168 x 100	2	36	₺30,60

Taç Duvar Aplik Armatür (1xE27 Duyulu)

Teknik Özellikler:

Technical Specifications

Gövde: ABS
Body: ABS

Cam: S.A.N
Glass: S.A.N

Koruma Sınıfı: 20
IP: 20

Kullanım: Tasarruf/Led Ampül
Usage: Saving / Led Bulb

IP20

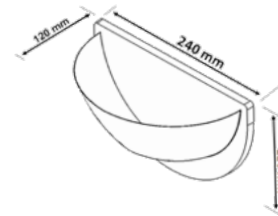

Ürün Kodu Product Code	Renk White	Boyutlar (WxLxH) mm Dimensions	Kutu Adeti Quantity in Box	Koli Adeti Quantity in Carton	Fiyat Price
BR-00249-000	Beyaz White	240 x 120 x 120	2	36	₺11,40

2'li Mühürlü Sigorta Kutusu

2 Module Distribution Box-Sealed

Ürün Kodu Product Code	Ürün Şekli White	Kutu Adeti Quantity in Box	Koli Adeti Quantity in Carton	Fiyat Price
BR-818	Beyaz White	1	98	₺6,10

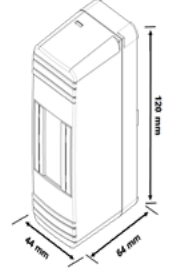

4'lü Mühürlü Sigorta Kutusu

4 Module Distribution Box-Sealed

Ürün Kodu Product Code	Ürün Şekli White	Kutu Adeti Quantity in Box	Koli Adeti Quantity in Carton	Fiyat Price
BR-819	Beyaz White	1	50	₺9,20

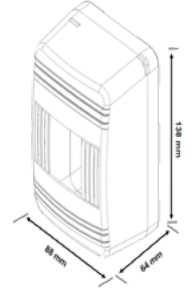

2'li Sıva Üstü Sigorta Kutusu

2 Module Distribution Box-Surface Mounted

Ürün Kodu Product Code	Ürün Şekli White	Kutu Adeti Quantity in Box	Koli Adeti Quantity in Carton	Fiyat Price
BR-820	Beyaz White	2	40	₺20,10

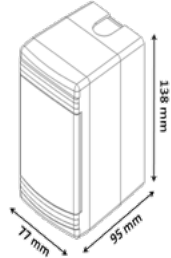

2'li Sıva Altı Sigorta Kutusu

2 Module Distribution Box-Recessed

Ürün Kodu Product Code	Ürün Şekli White	Kutu Adeti Quantity in Box	Koli Adeti Quantity in Carton	Fiyat Price
BR-821	Beyaz White	2	40	₺17,80

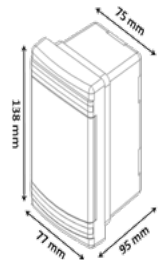

Sıva Altı ve Sıva Üstü Halogen Free Sigorta Kutuları

Recessed and Surface Mounted Halogen Free Fuse Boxes



6'lı Sıva Üstü Sigorta Kutusu

6 Module Distribution Box-Surface Mounted

Ürün Kodu Product Code	Ürün Şekli White	Kutu Adeti Quantity in Box	Koli Adeti Quantity in Carton	Fiyat Price
BR-804	Beyaz White	1	30	₺35,30

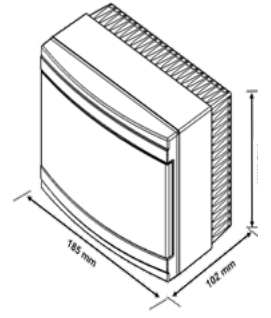

6'lı Sıva Altı Sigorta Kutusu

6 Module Distribution Box-Recessed

Ürün Kodu Product Code	Ürün Şekli White	Kutu Adeti Quantity in Box	Koli Adeti Quantity in Carton	Fiyat Price
BR-803	Beyaz White	1	30	₺29,80

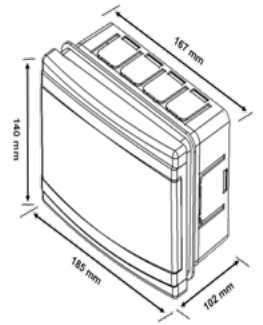

9'lu Sıva Üstü Sigorta Kutusu

9 Module Distribution Box-Surface Mounted

Ürün Kodu Product Code	Ürün Şekli White	Kutu Adeti Quantity in Box	Koli Adeti Quantity in Carton	Fiyat Price
BR-806	Beyaz White	1	20	₺45,90

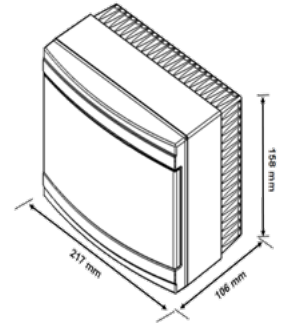

9'lu Sıva Altı Sigorta Kutusu

9 Module Distribution Box-Recessed

Ürün Kodu Product Code	Ürün Şekli White	Kutu Adeti Quantity in Box	Koli Adeti Quantity in Carton	Fiyat Price
BR-805	Beyaz White	1	20	₺38,90

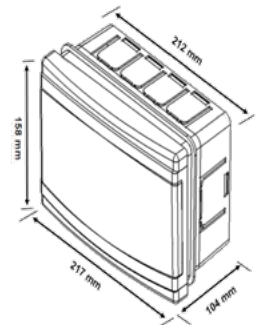

12'li Sıva Üstü Sigorta Kutusu

12 Module Distribution Box-Surface Mounted

Ürün Kodu Product Code	Ürün Şekli White	Kutu Adeti Quantity in Box	Koli Adeti Quantity in Carton	Fiyat Price
BR-808	Beyaz White	1	20	₺61,50

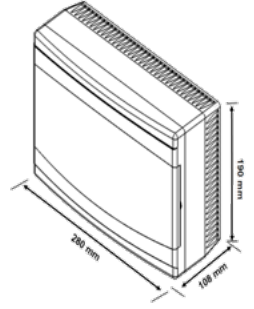
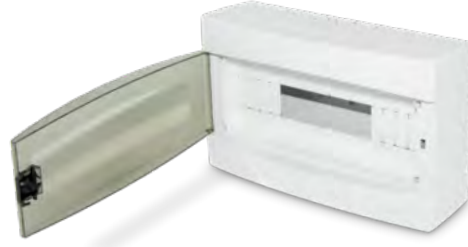

12'li Sıva Altı Sigorta Kutusu

12 Module Distribution Box- Recessed

Ürün Kodu Product Code	Ürün Şekli White	Kutu Adeti Quantity in Box	Koli Adeti Quantity in Carton	Fiyat Price
BR-807	Beyaz White	1	20	₺55,60

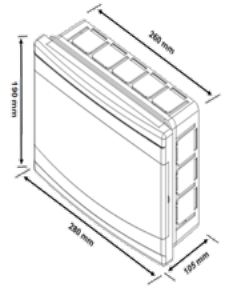

16'li Sıva Üstü Sigorta Kutusu

16 Module Distribution Box-Surface Mounted

Ürün Kodu Product Code	Ürün Şekli White	Kutu Adeti Quantity in Box	Koli Adeti Quantity in Carton	Fiyat Price
BR-816	Beyaz White	1	10	₺83,80

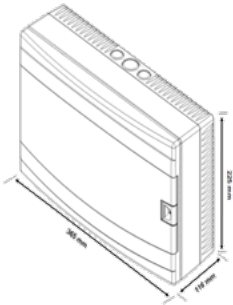

16'li Sıva Altı Sigorta Kutusu

16 Module Distribution Box- Recessed

Ürün Kodu Product Code	Ürün Şekli White	Kutu Adeti Quantity in Box	Koli Adeti Quantity in Carton	Fiyat Price
BR-815	Beyaz White	1	10	₺78,50

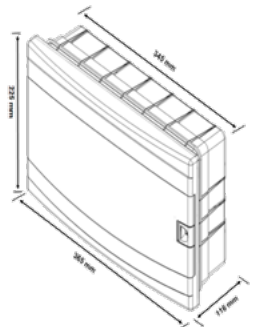

Sıva Altı ve Sıva Üstü Halogen Free Sigorta Kutuları

Recessed and Surface Mounted Halogen Free Fuse Boxes



18'li Sıva Üstü Sigorta Kutusu

18 Module Distribution Box-Surface Mounted

Ürün Kodu Product Code	Ürün Şekli White	Kutu Adeti Quantity in Box	Koli Adeti Quantity in Carton	Fiyat Price
BR-814	Beyaz White	1	10	₺66,40

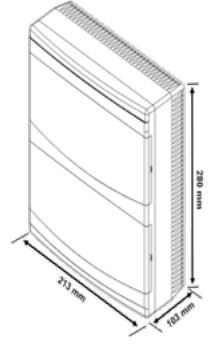

18'li Sıva Altı Sigorta Kutusu

18 Module Distribution Box- Recessed

Ürün Kodu Product Code	Ürün Şekli White	Kutu Adeti Quantity in Box	Koli Adeti Quantity in Carton	Fiyat Price
BR-813	Beyaz White	1	10	₺65,70

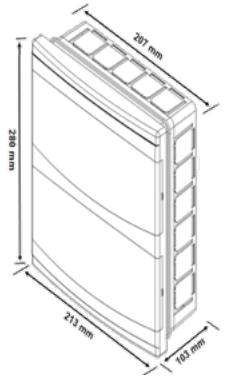

24'lü Sıva Üstü Sigorta Kutusu

24 Module Distribution Box-Surface Mounted

Ürün Kodu Product Code	Ürün Şekli White	Kutu Adeti Quantity in Box	Koli Adeti Quantity in Carton	Fiyat Price
BR-810	Beyaz White	1	10	₺100,70

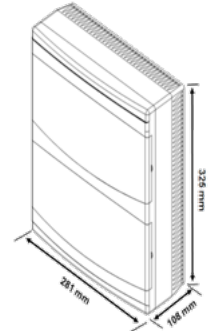

24'lü Sıva Altı Sigorta Kutusu

24 Module Distribution Box- Recessed

Ürün Kodu Product Code	Ürün Şekli White	Kutu Adeti Quantity in Box	Koli Adeti Quantity in Carton	Fiyat Price
BR-809	Beyaz White	1	10	₺92,80

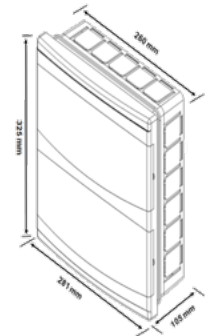

36'lı Sıva Üstü Sigorta Kutusu

36 Module Distribution Box-Surface Mounted

Ürün Kodu Product Code	Ürün Şekli White	Kutu Adeti Quantity in Box	Koli Adeti Quantity in Carton	Fiyat Price
BR-812	Beyaz White	1	5	₺128,70



36'lı Sıva Altı Sigorta Kutusu

36 Module Distribution Box-Recessed

Ürün Kodu Product Code	Ürün Şekli White	Kutu Adeti Quantity in Box	Koli Adeti Quantity in Carton	Fiyat Price
BR-811	Beyaz White	1	5	₺120,90



Termoplastik Buat, Dübel ve Alçıpan Kasa

Thermoplastic Junction Box, Dowels and Drywall Case

Termoplastik Buatlar

Thermoplastic Junction Box

Ürün Kodu Product Code	Boyutlar (WxLxH) mm Dimensions	Koli Adeti Quantity in Carton	Fiyat Price
BR-750	70x80x40	50	₺11,90
BR-760	85x85x40	50	₺14,30
BR-770	110x110x55	20	₺26,10



Buat ve Dübeller

Junction Box and Dowels

Ürün Kodu Product Code	Ürün Adı Product Name	Koli Adeti Quantity in Carton	Fiyat Price
BR-1713	Alçıpan Buat Drywall Junction	100	₺3,20
BR-710	Lüks Buat Kapağı Lux Junction Box Cover	100	₺1,10
BR-901	7 No'lu Dübel Plastic Dowel No: 7	100	₺0,15
BR-902	8 No'lu Dübel Plastic Dowel No: 8	100	₺0,17



Lüks Kare Buatlar (Halogen Free)

Luxury Square Junction Boxes (Halogen Free)



Ürün Kodu Product Code	Boyutlar (WxLxH) mm Dimensions	Koli Adeti Quantity in Carton	Fiyat Price
BR-730	80x80x40	140	₺4,60
BR-731	100x100x45	140	₺7,10
BR-732	130x130x55	180	₺10,40
BR-734	150x150x58	108	₺15,40
BR-733	200x200x70	60	₺28,60

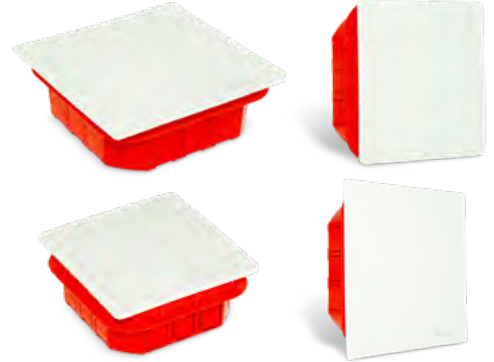

Geçmeli ve Alçıpan Kasa (Kapaksız)

Interlaced and Drywall Case (Without Cover)

Ürün Kodu Product Code	Ürün Adı Product Name	Renk Color	Koli Adeti Quantity in Carton	Fiyat Price
BR-1413	Geçmeli Kasa Büyük Interlaced Case Big	Turuncu Orange	100	₺1,60
BR-1708	Geçmeli Kasa Küçük Interlaced Case Small	Turuncu Orange	200	₺1,40
BR-1712	Alçıpan Kasa Plasterboard Case	Turuncu Orange	200	₺1,90
BR-1413-E	Geçmeli Kasa Büyük Interlaced Case Big	Siyah Black	100	₺0,70
BR-1708-E	Geçmeli Kasa Küçük Interlaced Case Small	Siyah Black	200	₺0,65
BR-1712-E	Alçıpan Kasa Plasterboard Case	Siyah Black	200	₺1,20



2'li Grup Priz Topraklı

2 Module Earthed Group Socket

Ürün Kodu Product Code	Ürün Adı Product Name	Koli Adeti Quantity in Carton	Fiyat Price
BR-1552-0	Klemensli Kablosuz / Cordless	50	₺17,70
BR-1552-2	2 mt. Kordonlu / With Cord	12	₺44,00
BR-1552-3	3 mt. Kordonlu / With Cord	12	₺53,30
BR-1552-5	5 mt. Kordonlu / With Cord	12	₺72,60

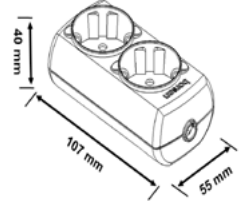

3'lü Grup Priz Topraklı

3 Module Earthed Group Socket

Ürün Kodu Product Code	Ürün Adı Product Name	Koli Adeti Quantity in Carton	Fiyat Price
BR-1553-0	Klemensli Kablosuz / Cordless	48	₺23,60
BR-1553-2	2 mt. Kordonlu / With Cord	12	₺49,90
BR-1553-3	3 mt. Kordonlu / With Cord	18	₺58,60
BR-1553-5	5 mt. Kordonlu / With Cord	12	₺78,00

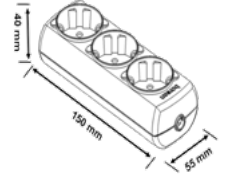

4'lü Grup Priz Topraklı

4 Module Earthed Group Socket

Ürün Kodu Product Code	Ürün Adı Product Name	Koli Adeti Quantity in Carton	Fiyat Price
BR-1554-0	Klemensli Kablosuz / Cordless	40	₺29,30
BR-1554-2	2 mt. Kordonlu / With Cord	12	₺55,50
BR-1554-3	3 mt. Kordonlu / With Cord	12	₺65,20
BR-1554-5	5 mt. Kordonlu / With Cord	12	₺83,90

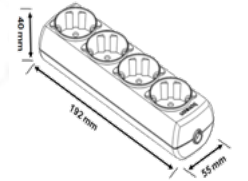

6'lı Grup Priz Topraklı

6 Module Earthed Group Socket

Ürün Kodu Product Code	Ürün Adı Product Name	Koli Adeti Quantity in Carton	Fiyat Price
BR-1556-0	Klemensli Kablosuz / Cordless	24	₺42,80
BR-1556-2	2 mt. Kordonlu / With Cord	12	₺68,80
BR-1556-3	3 mt. Kordonlu / With Cord	12	₺78,20
BR-1556-5	5 mt. Kordonlu / With Cord	12	₺97,00

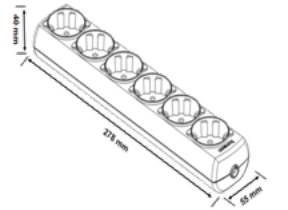

2'li Grup Priz Topraklı Anahtarlı

2 Module Earthed Group Socket With Switch

Ürün Kodu Product Code	Ürün Adı Product Name	Koli Adeti Quantity in Carton	Fiyat Price
BR-1562-0	Klemensli Kablosuz / Cordless	48	₺30,90
BR-1562-2	2 mt. Kordonlu / With Cord	12	₺56,80
BR-1562-3	3 mt. Kordonlu / With Cord	12	₺66,30
BR-1562-5	5 mt. Kordonlu / With Cord	12	₺84,40

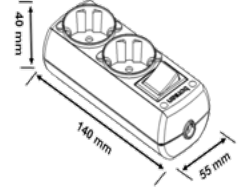

3'lü Grup Priz Topraklı Anahtarlı

3 Module Earthed Group Socket With Switch

Ürün Kodu Product Code	Ürün Adı Product Name	Koli Adeti Quantity in Carton	Fiyat Price
BR-1563-0	Klemensli Kablosuz / Cordless	40	₺36,70
BR-1563-2	2 mt. Kordonlu / With Cord	12	₺63,00
BR-1563-3	3 mt. Kordonlu / With Cord	12	₺72,40
BR-1563-5	5 mt. Kordonlu / With Cord	12	₺91,30

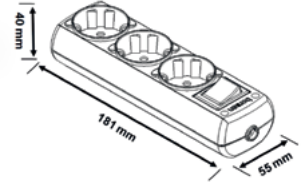

4'lü Grup Priz Topraklı Anahtarlı

4 Module Earthed Group Socket With Switch

Ürün Kodu Product Code	Ürün Adı Product Name	Koli Adeti Quantity in Carton	Fiyat Price
BR-1564-0	Klemensli Kablosuz / Cordless	25	₺43,40
BR-1564-2	2 mt. Kordonlu / With Cord	12	₺69,40
BR-1564-3	3 mt. Kordonlu / With Cord	12	₺78,80
BR-1564-5	5 mt. Kordonlu / With Cord	12	₺97,70

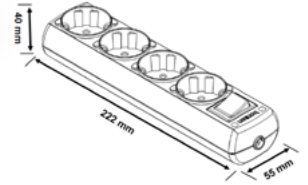

6'lı Grup Priz Topraklı Anahtarlı

6 Module Earthed Group Socket With Switch

Ürün Kodu Product Code	Ürün Adı Product Name	Koli Adeti Quantity in Carton	Fiyat Price
BR-1566-0	Klemensli Kablosuz / Cordless	40	₺55,30
BR-1566-2	2 mt. Kordonlu / With Cord	20	₺81,40
BR-1566-3	3 mt. Kordonlu / With Cord	20	₺90,90
BR-1566-5	5 mt. Kordonlu / With Cord	16	₺110,30

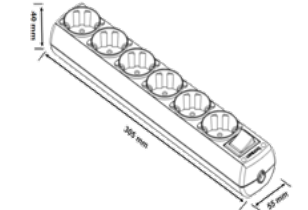

6'lı Grup Priz Topraklı UPS

6 Module Earthed Group Socket With UPS

Ürün Kodu Product Code	Ürün Adı Product Name	Koli Adeti Quantity in Carton	Fiyat Price
BR-1586-0	Klemensli Kablosuz / Cordless	24	₺48,30
BR-1586-2	2 mt. Kordonlu / With Cord	12	₺76,90
BR-1586-3	3 mt. Kordonlu / With Cord	12	₺86,30
BR-1586-5	5 mt. Kordonlu / With Cord	12	₺110,30

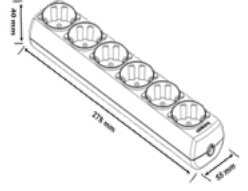

2'li Grup Priz Topraksız

2 Module Group Socket Without Earth

Ürün Kodu Product Code	Ürün Adı Product Name	Koli Adeti Quantity in Carton	Fiyat Price
BR-1542-0	Klemensli Kablosuz / Cordless	50	₺12,50
BR-1542-2	2 mt. Kordonlu / With Cord	12	₺29,20
BR-1542-3	3 mt. Kordonlu / With Cord	12	₺34,50
BR-1542-5	5 mt. Kordonlu / With Cord	12	₺45,40

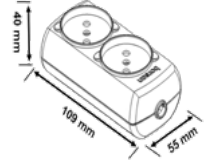

3'lü Grup Priz Topraksız

3 Module Group Socket Without Earth

Ürün Kodu Product Code	Ürün Adı Product Name	Koli Adeti Quantity in Carton	Fiyat Price
BR-1543-0	Klemensli Kablosuz / Cordless	50	₺15,40
BR-1543-2	2 mt. Kordonlu / With Cord	12	₺32,20
BR-1543-3	3 mt. Kordonlu / With Cord	12	₺37,50
BR-1543-5	5 mt. Kordonlu / With Cord	12	₺48,00

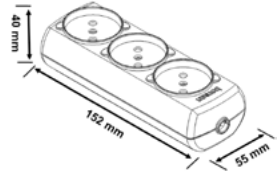

2'li Grup Priz Topraklı Siyah

2 Module Earthed Group Socket Black

Ürün Kodu Product Code	Ürün Adı Product Name	Koli Adeti Quantity in Carton	Fiyat Price
BR-1572-0	Klemensli Kablosuz / Cordless	50	₺17,70
BR-1572-2	2 mt. Kordonlu / With Cord	12	₺44,00
BR-1572-3	3 mt. Kordonlu / With Cord	12	₺53,30
BR-1572-5	5 mt. Kordonlu / With Cord	12	₺72,60

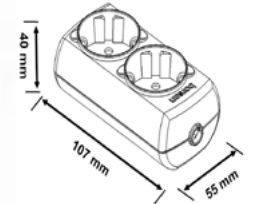

3'lü Grup Priz Topraklı Siyah

3 Module Earthed Group Socket Black

Ürün Kodu Product Code	Ürün Adı Product Name	Koli Adeti Quantity in Carton	Fiyat Price
BR-1573-0	Klemensli Kablosuz / Cordless	48	₺23,60
BR-1573-2	2 mt. Kordonlu / With Cord	12	₺49,90
BR-1573-3	3 mt. Kordonlu / With Cord	12	₺58,60
BR-1573-5	5 mt. Kordonlu / With Cord	12	₺78,00



4'lü Grup Priz Topraklı Siyah

4 Module Earthed Group Socket Black

Ürün Kodu Product Code	Ürün Adı Product Name	Koli Adeti Quantity in Carton	Fiyat Price
BR-1574-0	Klemensli Kablosuz / Cordless	40	₺29,30
BR-1574-2	2 mt. Kordonlu / With Cord	12	₺55,50
BR-1574-3	3 mt. Kordonlu / With Cord	12	₺65,20
BR-1574-5	5 mt. Kordonlu / With Cord	12	₺83,90



6'lı Grup Priz Topraklı Siyah

6 Module Earthed Group Socket Black

Ürün Kodu Product Code	Ürün Adı Product Name	Koli Adeti Quantity in Carton	Fiyat Price
BR-1576-0	Klemensli Kablosuz / Cordless	24	₺42,80
BR-1576-2	2 mt. Kordonlu / With Cord	12	₺68,80
BR-1576-3	3 mt. Kordonlu / With Cord	12	₺78,20
BR-1576-5	5 mt. Kordonlu / With Cord	12	₺97,00

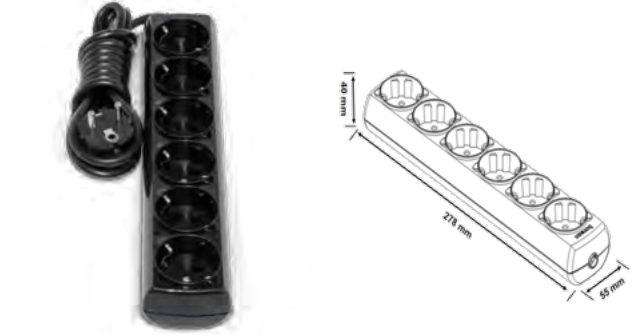

2'li Grup Priz Topraklı Anahtarlı Siyah

2 Module Earthed Group Socket With Switch Black

Ürün Kodu Product Code	Ürün Adı Product Name	Koli Adeti Quantity in Carton	Fiyat Price
BR-1592-0	Klemensli Kablosuz / Cordless	48	₺30,90
BR-1592-2	2 mt. Kordonlu / With Cord	12	₺56,80
BR-1592-3	3 mt. Kordonlu / With Cord	12	₺66,30
BR-1592-5	5 mt. Kordonlu / With Cord	12	₺84,40



3'lü Grup Priz Topraklı Anahtarlı Siyah

3 Module Earthed Group Socket With Switch Black

Ürün Kodu Product Code	Ürün Adı Product Name	Koli Adeti Quantity in Carton	Fiyat Price
BR-1593-0	Klemensli Kablosuz / Cordless	40	₺36,70
BR-1593-2	2 mt. Kordonlu / With Cord	12	₺63,00
BR-1593-3	3 mt. Kordonlu / With Cord	12	₺72,40
BR-1593-5	5 mt. Kordonlu / With Cord	12	₺91,30



4'lü Grup Priz Topraklı Anahtarlı Siyah

4 Module Earthed Group Socket With Switch Black

Ürün Kodu Product Code	Ürün Adı Product Name	Koli Adeti Quantity in Carton	Fiyat Price
BR-1594-0	Klemensli Kablosuz / Cordless	25	₺43,40
BR-1594-2	2 mt. Kordonlu / With Cord	12	₺69,40
BR-1594-3	3 mt. Kordonlu / With Cord	12	₺78,80
BR-1594-5	5 mt. Kordonlu / With Cord	12	₺97,70



6'lı Grup Priz Topraklı Anahtarlı Siyah

6 Module Earthed Group Socket With Switch

Ürün Kodu Product Code	Ürün Adı Product Name	Koli Adeti Quantity in Carton	Fiyat Price
BR-1596-0	Klemensli Kablosuz / Cordless	40	₺55,30
BR-1596-2	2 mt. Kordonlu / With Cord	20	₺81,40
BR-1596-3	3 mt. Kordonlu / With Cord	20	₺90,90
BR-1596-5	5 mt. Kordonlu / With Cord	16	₺110,30



3'lü Buket Priz

3 Grounded Triple Plug Socket Buket

Ürün Kodu Product Code	Ürün Adı Product Name	Koli Adeti Quantity in Carton	Fiyat Price
BR-1514	Buket 3'lü Topraklı Fiş Priz	36	₺24,40





BR-1510



BR-1511



BR-1515



BR-1516



BR-001411

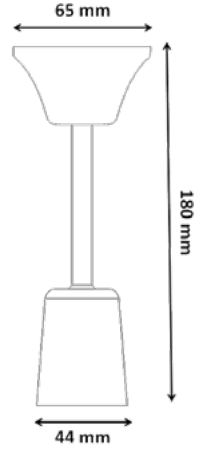

Ürün Kodu Product Code	Ürün Adı Product Name	Kutu Adeti Boxes Piece	Koli Adeti Quantity in Carton	Fiyat Price
BR-1510	Monofaze Erkek Fiş Single Phase Male Plug 10A	50	900	₺5,10
BR-1511	Topraklı Erkek Fiş Earthed Male Plug 16A	50	600	₺7,10
BR-1515	Topraklı Dişi Fiş (Klasik) Earthed Female Plug 16A	40	480	₺9,10
BR-1516	L Tipi Topraklı Erkek Fiş L Type Earthed Male Plug 16A	50	600	₺7,80
BR-001411	Askı Takımı Suspenden Lamp Holder Set	1	100	₺6,10



Sıkmalı Kablo Papuçu Standart Seri TSE

Cable Lugs Standard Series TSE

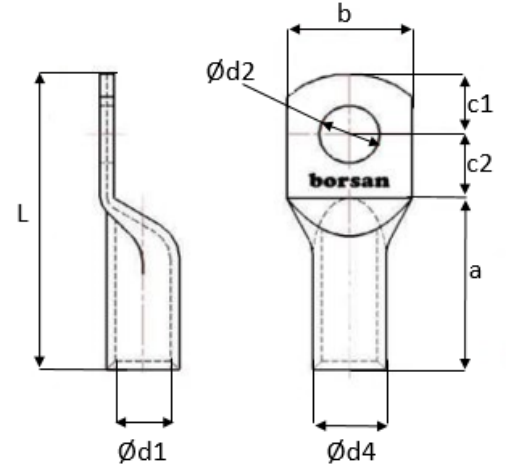

Ürün Kodu Product Code	Kesit Section	d1	Metrik (d2) Metric (d2)	d4	Et Kalınlık Thickness	a	b	c1	c2	L	Kutu Adeti Boxes Piece	Fiyat Price
BR-1761 M5	10	4,76	5,00	6,69	0,97	14,05	10,55	6,25	7,67	27,97	900	FIYAT SORUNUZ
BR-1761 M5K	10	4,76	5,00	6,69	0,97	14,05	10,55	6,25	7,67	27,97	500	FIYAT SORUNUZ
BR-1762 M6	16	5,50	6,00	8,12	1,31	17,20	11,71	7,15	6,81	31,16	600	FIYAT SORUNUZ
BR-1762-M6K	16	5,50	6,00	8,12	1,31	17,20	11,71	7,15	6,81	31,16	300	FIYAT SORUNUZ
BR-1763 M8	25	7,09	8,00	9,59	1,25	22,71	13,54	7,75	8,11	38,57	420	FIYAT SORUNUZ
BR-1763-M8K	25	7,09	8,00	9,59	1,25	22,71	13,54	7,75	8,11	38,57	210	FIYAT SORUNUZ
BR-1764 M8	35	8,29	8,00	10,88	1,30	25,13	15,57	8,50	10,67	44,30	250	FIYAT SORUNUZ
BR-1764-M8K	35	8,29	8,00	10,88	1,30	25,13	15,57	8,50	10,67	44,30	125	FIYAT SORUNUZ
BR-1765 M10	50	9,90	10,00	12,96	1,53	29,80	18,74	18,00	3,71	51,51	170	FIYAT SORUNUZ
BR-1765-M10K	50	9,90	10,00	12,96	1,53	29,80	18,74	18,00	3,71	51,51	85	FIYAT SORUNUZ
BR-1766 M10	70	11,58	10,00	14,76	1,59	33,86	21,31	10,50	10,83	55,19	110	FIYAT SORUNUZ
BR-1767 M10	95	13,46	10,00	16,72	1,63	36,74	24,46	11,00	11,56	59,30	90	FIYAT SORUNUZ
BR-1768 M12	120	15,39	12,00	19,24	1,93	42,37	28,12	14,25	13,23	69,85	65	FIYAT SORUNUZ
BR-1769 M12	150	16,56	12,00	21,11	2,28	42,92	30,23	17,50	15,56	75,98	55	FIYAT SORUNUZ
BR-1770 M16	185	18,21	16,00	22,97	2,38	46,75	33,22	18,50	17,72	82,97	35	FIYAT SORUNUZ
BR-1771 M16	240	21,31	16,00	26,39	2,54	54,90	38,20	17,50	17,23	89,63	25	FIYAT SORUNUZ
BR-1772 M16	300	23,84	16,00	29,54	2,85	55,31	48,78	23,00	20,76	99,07	20	FIYAT SORUNUZ
BR-1773 M20	400	27,52	20,00	33,78	3,13	56,92	49,36	25,00	22,69	104,61	14	FIYAT SORUNUZ



Sıkmalı Kablo Papuçu Seri EKO
Cable Lugs Series ECO

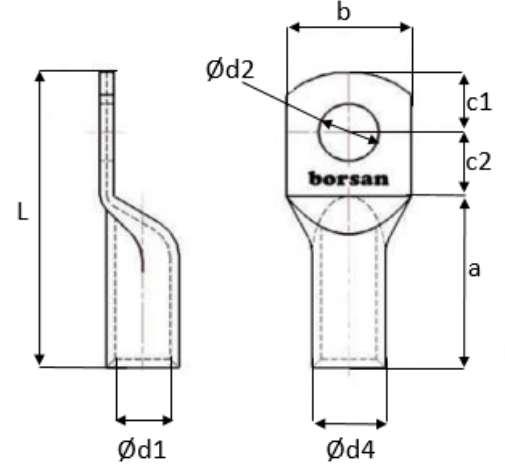

Ürün Kodu Product Code	Kesit Section	d1	Metrik (d2) Metric (d2)	d4	Et Kalınlık Thickness	a	b	c1	c2	L	Kutu Adeti Boxes Piece	Fiyat Price
BR-1780 M5	6	4,50	5,00	5,80	0,65	13,40	8,40	5,00	6,50	24,9	1500	FİYAT SORUNUZ
BR-1780-M5K	6	4,50	5,00	5,80	0,65	13,40	8,40	5,00	6,50	24,9	750	FİYAT SORUNUZ
BR-1781 M5	10	4,90	5,00	6,20	0,65	13,90	10,30	6,60	7,30	27,8	1100	FİYAT SORUNUZ
BR-1781-M5K	10	4,90	5,00	6,20	0,65	13,90	10,30	6,60	7,30	27,8	550	FİYAT SORUNUZ
BR-1782 M6	16	6,60	6,00	7,90	0,65	17,15	11,70	6,40	7,60	31,15	650	FİYAT SORUNUZ
BR-1782-M6K	16	6,60	6,00	7,90	0,65	17,15	11,70	6,40	7,60	31,15	325	FİYAT SORUNUZ
BR-1783 M8	25	7,50	8,00	9,00	0,75	22,50	13,25	8,20	7,90	38,6	420	FİYAT SORUNUZ
BR-1783-M8K	25	7,50	8,00	9,00	0,75	22,50	13,25	8,20	7,90	38,6	210	FİYAT SORUNUZ
BR-1784 M8	35	8,70	8,00	10,80	1,05	24,85	15,50	9,20	10,35	44,4	250	FİYAT SORUNUZ
BR-1784-M8K	35	8,70	8,00	10,80	1,05	24,85	15,50	9,20	10,35	44,4	125	FİYAT SORUNUZ
BR-1785 M10	50	10,30	10,00	12,60	1,15	28,90	18,20	11,50	11,15	51,55	170	FİYAT SORUNUZ
BR-1785-M10K	50	10,30	10,00	12,60	1,15	28,90	18,20	11,50	11,15	51,55	85	FİYAT SORUNUZ
BR-1786 M10	70	11,70	10,00	14,50	1,40	33,90	21,00	10,10	11,10	55,1	110	FİYAT SORUNUZ
BR-1787 M10	95	13,80	10,00	16,50	1,35	36,70	24,20	10,55	12,05	59,3	90	FİYAT SORUNUZ
BR-1788 M12	120	15,90	12,00	19,10	1,60	42,55	28,20	13,90	13,60	70,05	65	FİYAT SORUNUZ
BR-1789 M12	150	17,30	12,00	20,60	1,65	42,20	29,95	16,70	16,80	75,7	55	FİYAT SORUNUZ
BR-1790 M16	185	19,05	16,00	22,60	1,78	46,60	33,25	17,35	18,95	82,9	35	FİYAT SORUNUZ
BR-1791 M16	240	21,55	16,00	25,20	1,83	54,30	37,25	17,35	17,95	89,6	25	FİYAT SORUNUZ
BR-1792 M16	300	24,30	16,00	29,00	2,35	53,50	43,00	22,00	24,50	100	20	FİYAT SORUNUZ
BR-1793 M20	400	27,35	20,00	32,80	2,73	57,50	48,50	24,80	22,20	104,5	14	FİYAT SORUNUZ



Ek Muf

Cable Splice Sleeve



Deliksiz Model
Model Holeless

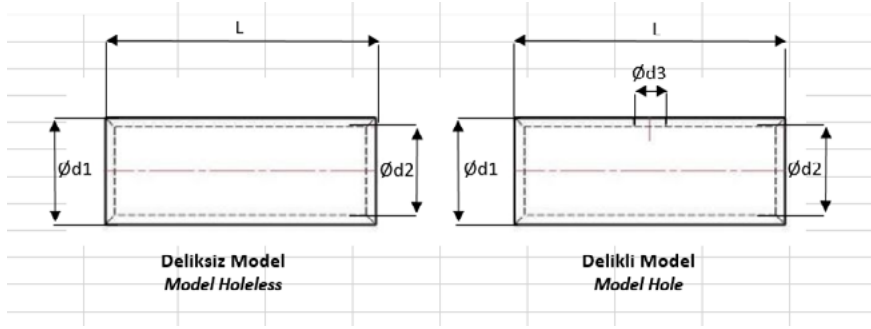

Delikli Model
Model Hole

Ürün Kodu Product Code	Kesit Section	d2	d1	d3	Et Kalınlık Thickness	L	Kutu Adeti Boxes Piece	Fiyat Price
BR-1880	6	4,50	5,80	×	0,65	24	1200	FİYAT SORUNUZ
BR-1880-K	6	4,50	5,80	×	0,65	24	600	FİYAT SORUNUZ
BR-1881	10	4,90	6,20	×	0,65	29	900	FİYAT SORUNUZ
BR-1881-K	10	4,90	6,20	×	0,65	29	450	FİYAT SORUNUZ
BR-1881D	10	4,90	6,20	4,00	0,65	29	900	FİYAT SORUNUZ
BR-1882	16	6,60	7,90	×	0,65	31	500	FİYAT SORUNUZ
BR-1882-K	16	6,60	7,90	×	0,65	31	250	FİYAT SORUNUZ
BR-1882D	16	6,60	7,90	5,00	0,65	31	500	FİYAT SORUNUZ
BR-1883	25	7,50	9,00	×	0,75	40	300	FİYAT SORUNUZ
BR-1883-K	25	7,50	9,00	×	0,75	40	150	FİYAT SORUNUZ
BR-1883D	25	7,50	9,00	5,00	0,75	40	300	FİYAT SORUNUZ
BR-1884	35	8,70	10,80	×	1,05	46	200	FİYAT SORUNUZ
BR-1884-K	35	8,70	10,80	×	1,05	46	100	FİYAT SORUNUZ
BR-1884D	35	8,70	10,80	6,50	1,05	46	200	FİYAT SORUNUZ
BR-1885	50	10,20	12,60	×	1,20	52	170	FİYAT SORUNUZ
BR-1885-K	50	10,20	12,60	×	1,20	52	85	FİYAT SORUNUZ
BR-1885D	50	10,20	12,60	6,50	1,20	52	170	FİYAT SORUNUZ
BR-1886	70	11,70	14,50	×	1,40	56	90	FİYAT SORUNUZ
BR-1886D	70	11,70	14,50	6,50	1,40	56	90	FİYAT SORUNUZ
BR-1887	95	13,80	16,50	×	1,35	60	80	FİYAT SORUNUZ
BR-1887D	95	13,80	16,50	6,50	1,35	60	80	FİYAT SORUNUZ
BR-1888	120	15,9	19,1	×	1,60	70	60	FİYAT SORUNUZ
BR-1888D	120	15,9	19,1	6,5	1,60	70	60	FİYAT SORUNUZ
BR-1889	150	17,3	20,6	×	1,65	79	40	FİYAT SORUNUZ
BR-1889D	150	17,3	20,6	8,5	1,65	79	40	FİYAT SORUNUZ
BR-1890	185	19,05	22,6	×	1,78	85	30	FİYAT SORUNUZ
BR-1890D	185	19,05	22,6	8,5	1,78	85	30	FİYAT SORUNUZ
BR-1891	240	21,55	25,2	×	1,83	92	20	FİYAT SORUNUZ
BR-1892	300	24,3	29	×	2,35	98	15	FİYAT SORUNUZ
BR-1893	400	27,35	32,8	×	2,73	109	9	FİYAT SORUNUZ



DERS: FİZİK

Güç, ne kadar hızlı enerji aktarılabilirdiği ya da ne kadar hızlı iş yapılabilirdiği anlamına gelir.

Birim zamanda aktarılan veya dönüştürülen enerjiye ya da yapılan işe güç denir. Matematiksel olarak simgesiyle gösterilir.



P {power}

$$\text{Güç} = \{\text{iş}\} / \{\text{zaman aralığı}\}$$

$$\text{Güç} = \{\text{aktarılan enerji}\} / \{\text{zaman aralığı}\}$$

$$\text{Güç} = \{\text{dönüştürülen enerji}\} / \{\text{zaman aralığı}\}$$

$$P = W / \Delta t - P = \Delta E / \Delta t$$

Güç türetilmiş bir niceliktir ve skaler bir büyüklüktür.

Birimi watt (W) olarak da adlandırılan J/s'dir.

Aydınlatmada Kullanılan Lambalar

Günümüzde aydınlatmada kullanılan lambalar aşağıdaki gibidir. Önceki yıllarda yapılmış olan aydınlatma sistemleri civa buharlı lambalar yoğun olarak kullanılmaktadır. Günümüzde ise Tedaş'ın şartnamelerinde Civa buharlı lamba kullanımını yasaklanmıştır. Aşağıdaki tablodan da görüldüğü üzere teknoloji sürekli olarak gelişmekte daha yüksek ışık etkinliğine sahip ve daha uzun ömürlü ürünler seçilmektedir.

Lamba Türü	Işık Etkinliği (Lm/W)	Ömür (Saat)
Akkor lamba (Enkandesen)	8 - 16	1000
Halojen lamba (Tungsten)	12 - 26	2.000 - 4.000
Floresan lamba	45 - 100	6.000 - 15.000
Yb Civa Buharlı lamba	36 - 60	6.000 - 8.000
Metal Halide lamba	71 - 98	5.600 - 6.500
Endüksiyon	68 - 72	5.800 - 6.200
YB Sodyum Buharlı lamba	66 - 142	10.000 - 15.000
AB Sodyum Buharlı lamba	100 - 198	11.500 - 20.000
LED	80 - 165	50.000 - 100.000

Işık Akısı (LM)

Bir ışık kaynağından ışıyan akının göze etkiyen kısmına ışık akısı denir. Birimi lümen'dir ve ışının parlaklık duygusu uyandırma yeteneğini temsil eder. Toplam ışık akısı ise bir kaynaktan çıkan ve uzayın muhtelif kısımlarına yayılan ışık akılarının toplamı olarak tanımlanır. Işık enerjisinin ölçüsüdür. Diğer bir deyişle, bir ışık kaynağından toplam çıkış lümenle ifade edilir. Lümen ne kadar yüksek ışık ise o kadar parlak gözükür. (1 lümen = 0.00146 W)

Aydınlık Düzeyi (Lux)

Birim yüzeye düşen toplam ışık akısı o yüzeyin aydınlık düzeyi olarak tanımlanır ve E ile gösterilir. Birimi lux'tür. Bir Lux'ün ışım gücü bir mum ışığına eş değerdir.

Renk Sıcaklığı (Color Temperature K)

Beyaz ışınım yapan bir ışık kaynağının sahip olduğu ışığın rengini ifade eder. Genelde eski tip enkandesan ampuller 2500K ışık rengine sahiptir. Bunun dışında 2700K sarı ışık, 3000K gün ışığı (veya sıcak beyaz), 4000K nötr beyaz, 5000-6500K soğuk beyaz ışık rengi olarak tabir edilir.

Renksel Geri Verim (CRI)

Renksel Geri Verim nesnenin belli bir ışık kaynağı altında renk kalitesini ifade eder. Yüksek CRI değerine sahip bir ışık kaynağı, renklerin daha doğal görünmesini ifade eder. Değer, 0 (çok zayıf renk sunumu) ile 100 (mükemmel renk sunumu) arasında değişmektedir. Genel olarak 80 CRI olan ışık kaynakları uygun olarak kabul edilir.

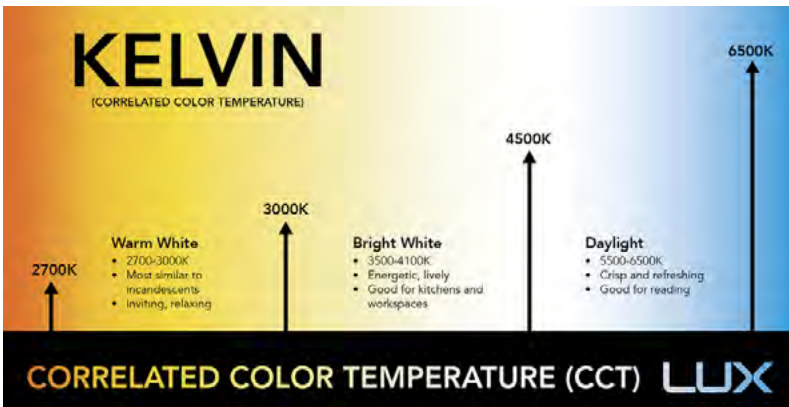

Işık Şiddeti (Cd)

Noktasal bir ışık kaynağının herhangi bir doğrultusundaki ışık şiddeti bu doğrultuyu içine alan uzay açısından çıkan ışık akısının uzay açığı bölümü olarak tanımlanır. Birimi Candela'dır ve 'cd' ile gösterilir. 1 Lümenlik ışık akısının 1 steradyanlık uzay açısından çıkması durumunda ışık şiddeti 1 cd olur.

Işık

Dalga teorisine göre ışık elektromanyetik ışınlanma (radyasyon) enerjisinin gözle görülebilen bir şeklidir. Belli bir yayılma hızına frekansa ve dalga boyuna sahiptir. İnsanoğlu bu elektromanyetik dalgaların sadece dalga boyu 380 nm ile 780 nm arasında değişen ve renk olarak tanımlanan kısmını görebilir.

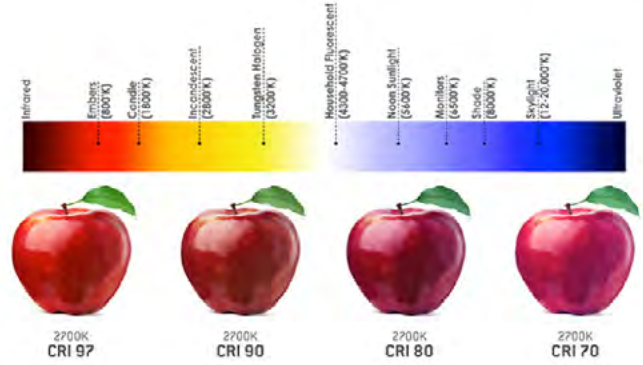

Renk

Farklı dalga boylarındaki ışınların insan beyninde yaptığı çağrışımlardır. Bir ışık demetinin rengini tayfsal özellikleri belirler.

ELEKTROMANYETİK SPEKTRUM

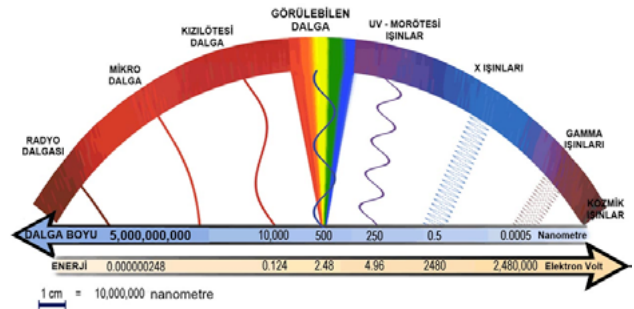

Konik Diagram

Aydınlatma ürününden çıkan ışık akısının baz alınan belli yükseklikler için ne kadarlık ışık şiddeti (lx) oluşturacağı belirtilmektedir. Aşağıdaki tabloda 90 Derece Açılı ile kullanılan armatürlerin farklı yüksekliklerde zemine vurma dağılımı gösterilmektedir. Hesaplama sonucu oluşturulan diagramda ortam koşulları hesaplamalara dahil edilmemiştir.

Distance [m]	Cone Diameter [m]	E ₀ [lx]	E ₁ [lx]	E ₂ [lx]
0.5	1.40	E ₀ [lx]	562*	2018
1.0	2.99	E ₁ [lx]	562*	504
1.5	4.40	E ₂ [lx]	562*	224
2.0	5.98	E ₃ [lx]	562*	126
2.5	7.47	E ₄ [lx]	562*	81
3.0	8.90	E ₅ [lx]	562*	56

Distance [m] Cone Diameter [m] Illuminance [lx]
 *C0 - C180 (Half value angle: 112.4°)

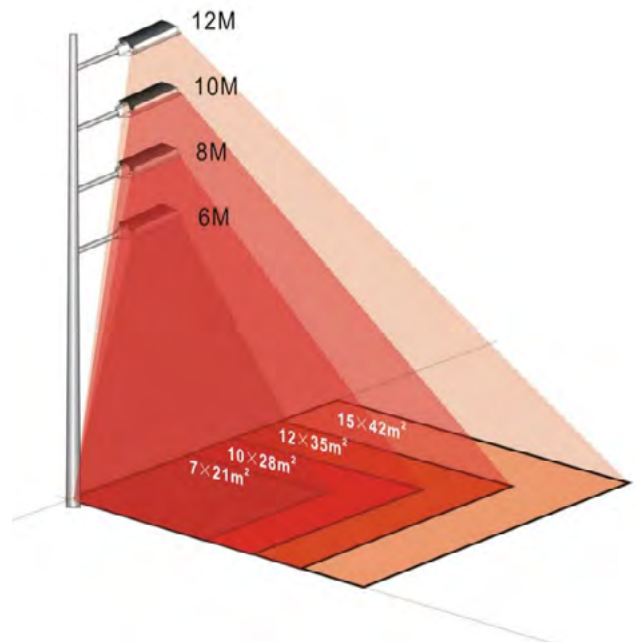

Types of Light Lamps

The lighting lamps in use today are shown below table. Mercury vapor lamps were used intensively in lighting systems. As you may see from following table, technology is always improving therefore long life energy-saving and higher lighting efficiency products are being preferred.

Types of Lamps	Light efficiency (lm/W)	Lifetime (hour)
Incandescent Lamps	8 - 16	1000
Halojen Lamps (Tungsten)	12 - 26	2.000 - 4.000
Floresan Lamps	45 - 100	6.000 - 15.000
High-pressure	36 - 60	6.000 - 8.000
Mercury-vapor Lamps	71 - 98	5.600 - 6.500
Induction	68 - 72	5.800 - 6.200
High Pressure Sodium Lamps	66 - 142	10.000 - 15.000
Low Pressure Sodium Lamps	100 - 198	11.500 - 20.000
LED	80 - 165	50.000 - 100.000

Luminous Flux (LM)

The amount of light (energy) as seen by the human eye that is given off by the light bulb described as luminous flux. It is designated by the symbol F and is expressed in lumens and total luminous flux is described as sum amount of the luminous flux that emitted by a light source and spread into space sundry parts. It is unit of light energy. In other words, total outcome from a light source stated by Lumen. More lumens means it's a brighter light. (1lm=0,00146 W)

Luminous Level (Lux)

Illuminance level is the quantity of total luminous flux falling on unit area of a surface and It is designated by the symbol E. Its unit is lux. One lux equals to a candle light.

Colour Temperature (K)

Defines the color of light of a light source which emits white radiation. Old type incandescent lamps have usually 2500 K light colour. Besides that 2700 K is expressed yellow light, 3000 K is daylight(or warm white), 4000 K is pure white, 5000-6000 K is cool white.

Color Rendering Index (CRI)

Colour rendering index measures the objects appear under a given light source. A light with a high CRI rating will allow an object's colours to be appeared more natural. Value of the CRI is ranging from 0 (very poor color rendition) to 100 (nearly perfect color rendition). Light sources with CPI over 80 are considered excellent for colour recognition.

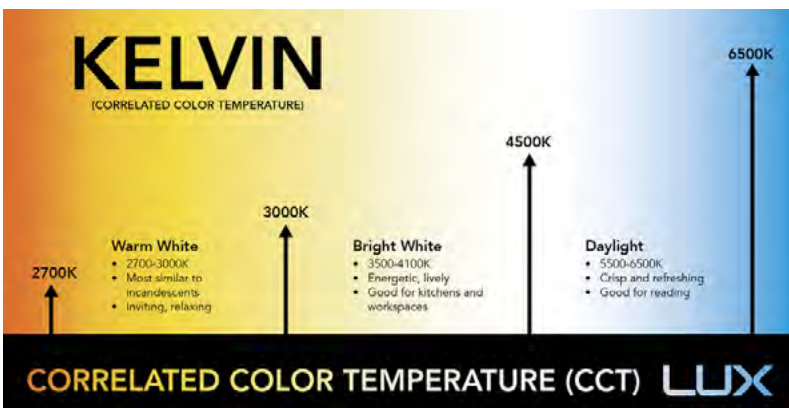

Luminous Intensity (Cd)

Concentration of light emitted in a specific direction per unit time. Unit is the Candela and shown 'cd'. 1 cd luminous intensity is equal to 1 lm luminous flux emitted in 1 steradian space angle.

Light

According to wave theory, light is the way electromagnetic radiation energy that are seen to human eye. It has a specific radiation speed, frequency and wavelength. Only electromagnetic wavelengths between 380 nm and 780 nm and defined as colours are visible to human eye.

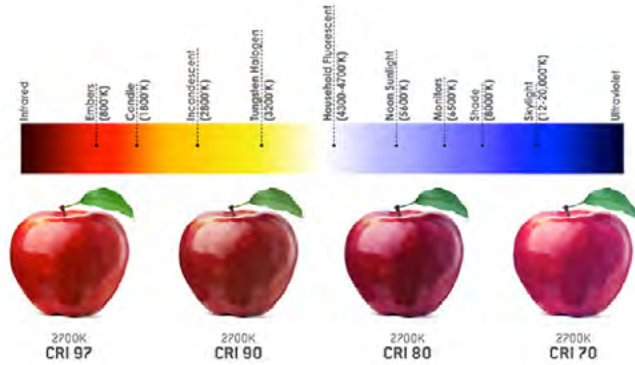

Colour

Associations of different wavelength light beam in the human brain defined as colour. The colour of a light beam is determined by spectrum.

ELECTROMAGNETİK SPECTRUM

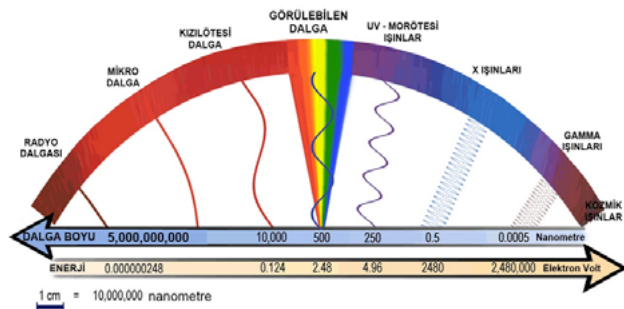

Conic Diagram

It specifies how much luminous intensity (lx) is to be produced based on certain heights by light output of lighting products. The following table shows the distribution of light hitting at different heights of Luminaires with 90 Degree Angle. Environmental conditions are not included in calculations of diagram.

Distance [m]	Cone Diameter [m]	E ₀ [lx]	E ₁ [lx]	E ₂ [lx]
0.5	1.40	2018	174	
1.0	2.99	504	43	
1.5	4.48	224	19	
2.0	5.98	126	11	
2.5	7.47	81	7	
3.0	8.96	56	5	

Distance [m] Cone Diameter [m] Illuminance [lx]



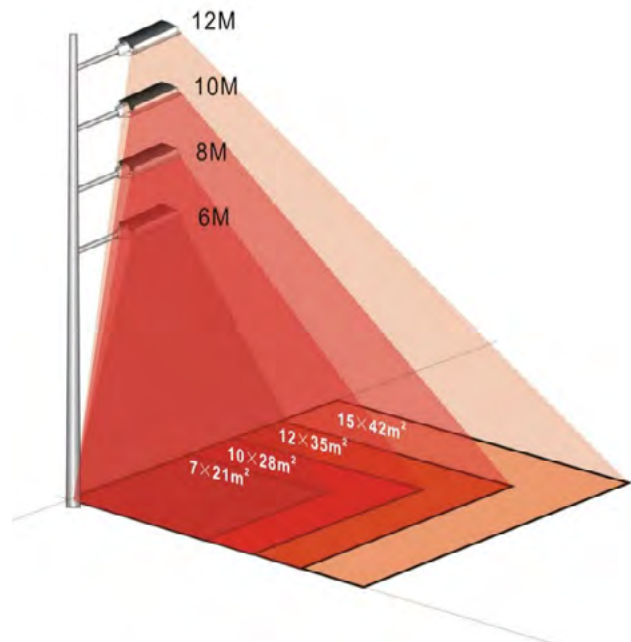







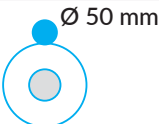

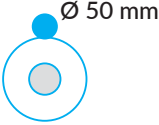

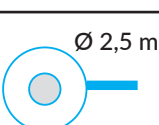

— C0 - C180 (Half value angle: 112.4°)

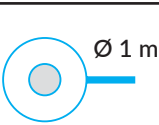

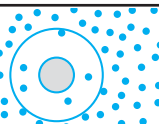

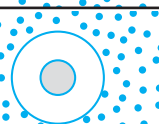





















IP Koruma Sınıfı / Ingress Protection Rating (IP)

IP Kodu armatürlerin katı ve sıvı cisimlere karşı koruma göstergesidir. IP Koruma sınıfları iki rakamla gösterilir. Birinci rakam katı cisimlere karşı ikinci rakam ise sıvılara karşı korumayı gösterir. Koruması yüksek aydınlatma armatürlerinin iç kesimleri daha temiz olacağından armatürlerin reflektörleri daha iyi bir verim sağlayacaktır.

IP Code is a protection indicator of Luminaires against solid and liquid substances. IP Protection classes are indicated by two digits. The first number is against solid objects and the second number shows protection against liquids. High protected luminaires reflectors will provide better efficiency because of their cleaner inner parts.

Birinci Rakam / First Number Katı cisimlere karşı koruma / Degree of Protection (Solids)			İkinci Rakam / Second Number Sıvı cisimlere karşı koruma / Degree of Protection (Water)		
IP	Testler		IP	Testler	
0	 Ø 50 mm	Korumasız Non Protection	0		Korumasız Non Protection
1	 Ø 50 mm	50 mm ² 'den büyük boyutlardaki katı cisimlerden koruma Protection against large foreign bodies (diameter<50mm ²)	1		Düşey olarak akan su damlalarından koruma Protection against vertical water drops
2	 Ø 12,5 mm	12.5 mm ² den büyük boyuttaki katı cisimlerden koruma Protection against medium foreign bodies (diameter<12.5mm ²)	2	 15°	Düşey'le 15° lik açı yapan su damlalarından koruma Protection against inclined water drops (15° from vertical)
3	 Ø 2,5 mm	2.5 mm ² den büyük boyuttaki katı cisimlerden koruma Protection against small foreign bodies (diameter<2.5mm ²)	3	 60°	Düşey'le 60° lik açı yapan su damlalarından koruma Protection against splash water drops (60° from vertical)
4	 Ø 1 mm	1 mm ² den büyük boyuttaki katı cisimlerden koruma Protection against small foreign bodies (diameter<1mm ²)	4		Her yönden gelen su damlalarından koruma Protection against splash water from all directions
5		Tozlardan koruma Dust Protected	5		Her yönden hortum marpuçundan püsküren su fişkırtmalarından koruma Protection against water jets from any angle
6		Tozlara karşı tamamı ile koruma Dust-tight	6		Her yönden. deniz dalgalarına benzer şekilde çarpan suların etkisine karşı tam koruma Protection against temporary flooding
			7		Suya gömülme durumunun etkilerinden koruma Protection against water submersion to 1m for 30 min
			8		Belirlenmemiş koşullar altında uzun sürelerde suya gömülme durumunun etkilerinden koruma Protection against high pressure water and submersion for an indefinite time

Sembol Symbol	Açıklama Explanation	Sembol Symbol	Açıklama Explanation
	Türk Standartlarına Uygunluk Belgesi Turkish Standard Compliance Certificate		Yanıcı Yüzeyle Monte Edilebilir Can be Mounted to flammable surfaces
	Kalite Sistem Belgesi Quality System Certification		1.Sınıf Gövde Koruma Topraklanmış 1.Class of protection. The body is grounded.
	ISO 14001 Kalite Sistem Belgesi ISO 14001 Quality System Certification		Geri Dönüşüme Uygundur Suitable for recyCeiling
	OHSAS 18001 Kalite Sistem Belgesi OHSAS 18001 Quality System Certification		Yetkili Personel Tarafından Müdahale Edilmeli Must be intervened by authorized personnel
	ROHS Uygunluk Sertifikası RoHS Compliance Certificate		IP20 Koruma Sınıfı Protection Class IP 20
	CE Deklarasyon Belgesi CE Declaration Document		IP65 Koruma Sınıfı Protection Class IP 65
	EAC Gümrük Birliği Belgesi EAC Custom Union Certificate		Eğitim Kurumları Educational Institutions
	Ukrayna Standartlarına Uygunluk Belgesi Ukrainian Standards Compliance Certificate		Yaşam Alanı Living Space
	Rusya Standartlarına Uygunluk Belgesi Russian Standards Compliance Certificate		Endüstriyel Tesisler Industrial Plants
	Avrupa Standartlarına Uygunluk Belgesi European Standards Compliance Certificate		Alışveriş Merkezleri Shopping Malls
	Enerji Tasarrufu Energy Saving		Sağlık Kuruluşları Health Institutions
	Alev İletmeyen Ham madde Halogen Free		Dış Mekan Outdoor
	Şebeke Gerilimi (220V) ile Çalışır Works with mains voltage (220V)		

	LUX		LUX
KONUTLAR		X rayonu servisi (ayarlanabilir aydınlatma)	80
Oturma Odaları	500	Dişle ilgili servis büro için (genel aydınlatma)	250
Mutfaklar	250	Hasta koltuğu	5000
Yatak Odaları	250	WC	50
Giriş holü merdivenler çatı karı ambar garajlar	250	Doğum Servisi	
BÜROLAR		Annelerin yatakları	5000
Resim büroları kadastr harita	2500	Çalışma salonu (genel aydınlatma)	250
Projeler teknik resim mimari	750	Çocukların odası	100
Dekoratif resim ve krokiler	500	Bekleme salonları	100
Muhasebe ile ilgili aygıtlar	500	Hastaneler için özel odalar (genel aydınlatma)	50
Hesaplamalar	400	Yatak aydınlatması	200
Daktilo odası	500	HOTEL VE RESTORANLAR	
Belgelerin bulunduğu salon	100	Banyolar	100
Yönetim büroları	250	Aynalar (ek aydınlatma)	200
Bekleme salonları	150	Hol ve merdivenler	50
Konferans salonları	200	Mutfaklar	250
Kantinler	150	Odalar	150
OKULLAR		Yatak ucu aydınlatması	150
Yuvalar anaokulları	100	Büro masası	200
Sınıflar	200	Tuvalet masası	250
Jimnastik salonları	100	Önemli Mekanlar	
İlkokullar sınıflar	250	Konferans salonları	75
Deney sınıfları	300	Platform	200
Toplantı salonu	150	Sergileme ve tanıtımlar	150
Jimnastik salonu	150	Salonlar	50
Meslek Okulları	400	Restoranlar	75
İlk ve ortaokul düzeyindeki teknik okullar		Barlar	75
Sınıflar	250	ÇAMAŞIRHANE	
Resim sınıfları	400	Yıkama yeri	150
Atölyeler	250	Onarım sayım işaret	200
HASTANELER		Özel parça onarımı	400
Doktor Odaları	100	CAM FABRİKASI	
Çalışma masaları	400	Karıştırma	150
Genel aydınlatma	150	Fırınlama.soğutma	150
Dispanser masaları	400	Mak. İşleme salonu	150
Yedek odalar	150	Ölçüye göre kesme	200
Toplantı odası	100	Parlatma	200
Laboratuvarlar		Pahlandırma	400
Araştırma salonları	250	Gravür işleme	500
Çalışma masaları	400	Kontrol	750
Tanı ve terapi odaları (genel aydınlatma)	250	ÇELİK FABRİKASI	
Tanı masası	500	Haddehane	150
Operasyon odası (genel aydınlatma)	500	Boru çubuk tel im.	200
Operasyon masası	20000	Galvanizasyon	200
Sterilizasyon odası	400	Makine dairesi	150

Minimum Aydınlık Düzeyler

Minimum Brightness Levels



	LUX		LUX
Kalite kontrol	400	Denetleme ve lekelerin çıkarılması	1500
YÜKSEK FIRIN		Ütüleme	
Kömür ve cevher deposu	50	Makine ile ya da elle	500
Yükleme	100	Katlama ve üzerinde değişiklikler yapma	750
Kontrol kapak ları	150	TEKSTİL SANAYİ	
Fırın kapakları bakımı	100	Pamuk	
Demir kütük deposu	50	Pamukların açılıp karıştırılması ayrılması	100
Çelik fabrikası	150	Tarama makaradan geçirme iplik durumuna getirme	200
KERESTE FABRİKASI		Haddeden geçirme	400
Makine ile ilk kesme	150	Denetleme	
Y. Hassas işleme	200	Sabit parçalar	400
Hassas işleme	400	Hareketli (hızlı) parçalar	1500
KAYNAK		İpek ve sentetik telli kumaşlar	100
Genel aydınlatma	250	Koyu renkli ipliklerle çalışma	750
Hassas ark kaynağı	2500	Dokuma	400
DÖKÜMHANE		Yün	
Maça imali (Hassas)	350	Yünlerin açılıp karıştırılması ayrılması	100
Maça imali (Kaba)	200	Denetleme	400
Döküm salonu	200	Tarama, çekip uzatma, çirileme mekik geçirme	200
Temizleme parit	200	Haddeden geçirme	
Kontrol		Beyaz	200
AYAKKABI FABRİKASI		Renkli	400
Kesim ve seçme	1000	Dokuma	
Model hazırlanması	1000	Beyaz	400
İnce kesim	1000	Renkli	750
Kauçuk hazırlama	125	SERAMİK SANAYİ	
Vernikleme	200	Öğütme, filtreleme ve kurutma kompanzasyonu	100
Volkanize kesme	200	Formlama, bitirme ve temizleme	150
Taban hazırlama	400	Reklendirme ve parlatma	400
MAKİNE ATÖLYELERİ		Reklendirme ve parlatma (İnce detaylar)	750
Kaba işleme	250	MAĞAZALAR	
İnce işleme ve parlatma	400	Vitrinler	1000
Çok ince işleme	2500	Büyük kentlerdeki satın alma merkezleri (Genel aydınlatma)	1000
GİYİM SANAYİ		Spotla ek aydınlatma	5000
Kumaşların denetimi		Diğer yerlerde (Genel aydınlatma)	500
Açık renkli kumaşlar	1500	Spotla ek aydınlatma	2500
Koyu renkli kumaşlar	2500	Mağaza iç mekanı	
Kesim ve Ütüleme	750	Büyük mağazalar	1000
Açık renkli kumaşlar	500	Büyük kentlerin ticaret merkezleri	1000
Koyu renkli kumaşlar	1000	Diğer yerler	500
Dikme ve Çeşitlendirme	750	Genel mağazalar (Az uğranan bölümler)	250
Açık renkli kumaşlar	750	Fabrika mağazaları (Çok uğranılan bölümler)	300
Koyu renkli kumaşlar	1500	Büyük parçaların yeri	100
BOYAMA		Küçük parçaların yeri	200
Belirginleştirme ayırma yıkama temizleme	200	Çok küçük parçaların yeri	300

	LUX		LUX
Müzeler	150	Park yerleri	50
Tablolar (bölgesel aydınlatma)	750	Sergileme salonları	400
Heykel ve diğer nesnelere	400	OTOMOBİL FABRİKALARI	
TİYATROLAR		Şasilerin toplanması.birleştirilmesi	200
Giriş ve fuaye	200	Şasilerin dizilimi	400
Salon	50	Döşemenin yapımı.çeşitli parçaların toplanıp birleştirilmesi	300
Orkestra yeri	100	Genel birleştirme	400
İbadethane	80	Bitirme ve denetleme	750
SİNEMALAR		Boya Fabrikaları	150
Giriş ve kasa	200	MATBAA	
Fuaye	50	Matris imali	400
Salon	100	Harflerin hazırlanması	200
SPOR SALONLARI		Renk ayırımı	
Stad	200	Baskı yeri	250
Futbol alanı	100	Mizampaj masası	500
Antreman alanı	25	KAĞIT FABRİKASI	
Tenis kortu	250	Karıştırma odası	150
Paten sahası	15	Kağıt makinaları	200
Paten sahası/yarışmalar için)	40	Kesme dek.	200
EKMEK FIRINLARI		Kontrol laboratuvarı	400
Karışım salonları	200	KİMYA SANAYİ	
Hamur reyonları	125	Elle çalıştırılan fırınlar sabit kurutucular ve kristalizasyon kapları	150
Fermantasyon salonu	125	Otomatik fırınlar buharlı kazanlar damıtma kolonları	150
Hazırlama salonu	200	Koyulaştırma kazanları nitrasyon elektroliz	150
Fırınlara bulunduğu salon	150	UÇAK ENDÜSTRİ	
Süsleme ve soğutma	250	Kaynak civata ve taşlama	250
Ambalaj salonu	150	Boya kabini	400
DEĞİRMENLER		Parçaların işlenmesi	400
Karıştırma tem.	200	İnce kaynak	250
Ambalaj salonu	100	Montaj	400
Mamul kontrolü	400	İşin tamamlanması	400
Silo temizliği	100	Kanat ve parça montajı	400
TREN İSTASYONLARI		UÇAK HANGARI	
Bekleme salonları	100	Bakım yeri	250
Bilet alma ve büroların bulunduğu yerler	400	Motor bakımı	400
Serinleme ve dinlenme salonları	150	SABUN ENDÜSTRİSİ	
Bavul emanet yeri	200	Toz sabun imali	150
Peronlar	100	Markalama paket	150
WC	100	Kalıplama ambalaj	250
GARAJLAR		TÜTÜN FABRİKASI	
Atölye	250	Kurutma	150
Tezgahtar	500	Ön hazırlama	150
Yağlama bölümleri	150	Kontrol ve seçme	200
Yağlama yerleri	250	Sigara makinaları	400

Minimum Aydınlık Düzeyler

Minimum Brightness Levels



	LUX		LUX
KONSERVE ENDÜSTRİSİ		Trafiği önemli olmayan ticari cadde	7.5
Yiyecek ayıklama	200	Trafiği olan konutlu cadde	7.5
Yıkama temizleme	200	Trafiği olmayan konutlu cadde	5
Renklerin ayrılması	300	Önemli bir çıkmaz sokak	15
Gerekli parçaları ayırma	300	Dağıtım garları	10
Kutulara koyma mek.	300	Bağımlı İşletmeler	
Kutulara koyma elle	200	Taşıma bölgeleri	20
Boş kutuların kontrolü	100	Stoklama(doldurma ve boşaltım)	20
Kutu kaynağı	300	Gözetleme aydınlatması	5
Paketleme-ambalaj	150	Girişler	50
SÜT ENDÜSTRİSİ		Yükleme platformları	50
Sterilizasyon odası	150	Trafiği olan ticari cadde	10
Pastorizasyon odası	150		
Kalıpların yıkanması	150		
Soğuk odalar	150		
Krema ayrılması	150		
Şişelerin seçimi	200		
Şişe yıkama makinası	400		
Doldurma salonu	125		
Laboratuvar	400		
ŞEKER ENDÜSTRİSİ			
Kesme karıştırma	200		
Temizleme.arıtma	400		
Renk kontrolü	750		
Depolama	50		
ELEKTRİK SANTRALİ			
Yanma hav. haz. Tesis	50		
Akümülatör dairesi	100		
Kazan bakım atölyesi	100		
Kazanların ön kısmı	50		
Kazana yakıt yük.	100		
DIŞ AYDINLATMA			
Genel halka açık aydınlatma			
Yerleşim bölgesinin dışı.ana trafik arteri	20		
Belediyeler arası anayol	15		
Belediyeler arası yol	10		
Yerleşim Bölgesinin İçi	30		
Kent içindeki hızlı dolaşım yolları	20		
Yakın yollar	20		
Tüneller(gün boyunca aydınlatma)	100		
Giriş aydınlatması	1000		
Gece aydınlatması	30		
Sanayi bölgesindeki liman ya da sokaklar	10		
Kıyı tevsiyeye havuzu ya da köprü	10		



İSTANBUL OFİS

Perpa İş Merkezi A Blok Kat: 11 No: 1337-1347
Pk: 34384 Şişli / İstanbul / Türkiye
T: +90 (212) 210 52 62-63 / F: +90 (212) 210 52 68
info@borsan.com.tr / export@borsan.com.tr

BORLED FABRİKA

Kerimbey Mah. OSB Vali M. Erdoğan Cebeci Bul. No:54
Pk: 55330 Tekkeköy / Samsun / Türkiye
T: +90 (362) 266 99 14 / F: +90 (362) 266 99 89
info@borled.com.tr