



INDUSTRIAL ELECTRONICS
MULTIFUNCTIONAL CONTROLLER



GHM-ONE.

Combines the modules of automation..

Editorial. Specialists by Competence.

„Grundlage für einen störungsfreien Prozessablauf sind unserer neuen Industrieelektronik Produkte. Sie sind konsequent zukunftssicher und so effizient wie möglich ausgelegt.“



Torsten Obermann

Electronic & Automation Technology

Phone: +49 172 4343551

Email: t.obermann@ghm-messtechnik.de



Additional information is provided on our website at:
www.ghm-group.de/en/business-units/industrial-electronics/



production processes. It is the task of control and feedback control technology to support this trend and provide the user with devices and systems to quickly implement the new requirements. The GHM-ONE multifunction platform approaches this challenge with a modern and innovative concept for **measuring, controlling, computing, data recording, and closed-loop control**.

Today's process technicians look for possibilities to be able to quickly and efficiently integrate their process technology ideas into new systems, or for retrofitting older systems without long downtimes. A requirement for this is the implementation of an idea without circuitous routes over multiple systems, for example, or hurdles arising from different programming languages.

The GHM-ONE platform provides process technicians with the possibility of effectively putting their ideas in the area of automation and visualisation into practice without programming knowledge. Therefore, the platform is the ideal basis for applications in areas such as:

- **Industrial furnaces, laboratory ovens, heat treatment plants, microbreweries, dryers, test stands, building automation, climate control, pasteurisation systems**

The GHM-ONE platform is the basis for the new generation of multifunction devices. The first multi-function unit of this platform is the MSR 9696H. Fully loaded with innovative hardware and software technologies, the MSR 9696H is our most important development in recent years in the area of multifunction units.

Today's users must be capable of implementing ideas without being deterred by programming languages or battling with limitless depths of visualisation systems.

The MSR 9696H stands out from the masses of automation devices and impresses with its possibilities

- **Implementing measurement, control, and closed-loop control concepts and ideas without the requirement of programming skills for the user**
- **Creating operating and monitoring concepts entirely without knowledge in the area of control system or SCADA technology**

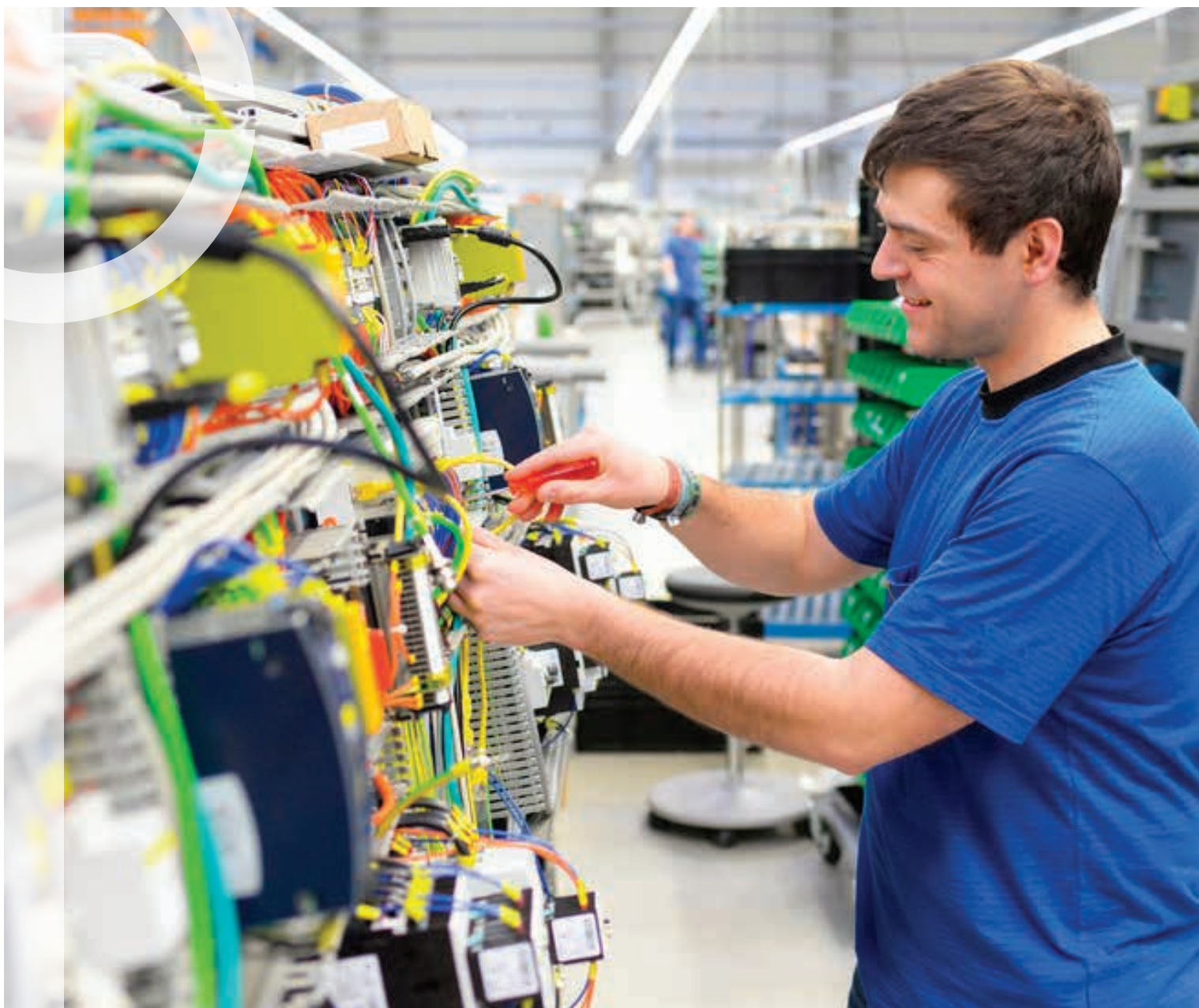

GHM-ONE – Multifunctional controller.



Multifunction controller GHM-ONE MSR9696H	7
GHM-CAT block editor	8
GHM-CAT HMI editor	9
GHM-CAT simulation	10
Programmation	11
GHM-CAT application designer	12
Regulation technical funktions	14
Data recording / trend representation	15
Communication	16
Entering Industrial Age 4.0 with GHM-ONE	17
Control Engineering	18
Technical details	22

Measuring, Controlling, Regulating, Automate Operate, Observe, Visualize, Communicate Calculate, Record, Analyze, Document



Multifunction controller GHM-ONE MSR9696H



Compact automation system

The GHM-ONE is a multifunction unit that can be specifically adapted to process and control requirements with the GHM-CAT configuration software. Therefore, the system becomes an ideal control, regulating, and operating unit.

- Visualisation system with 3.5" TFT display
- Control unit with 4 function keys and touch display
- Modular I/O concept
- Universal PID control function
- Multi-Loop system
- Profiler function
- Process control and PLC functions
- Process calculation with mathematical library
- Screen recorder function
- Data logger function
- Communication with various fieldbuses

At home in all processes

The GHM ONE gives the user the possibility of effectively implementing their ideas in the areas of automation and visualisation without the need for programming skills. The platform is an ideal basis for a wide range of applications, including:

- Industrial furnaces
- Laboratory ovens
- Heat treatment systems
- Microbreweries
- Dryers

- Test applications
- Building automations
- Climate control
- Pasteurisation systems
- Manufacturing plants

Powerful standalone concept

The GHM-ONE is based on a powerful processor which, in combination with a relay card and mains adapter card, serves as the base unit. The base unit can be adapted to applications with a communications card and up to two I/O cards.

The number of physical inputs and outputs can be expanded with external I/O's. This modular layout enables specific adaptation of the hardware to the automation task.

The creation of the application itself takes place in the GHM-ONE with the "Configuration and Application Tool" GHM-CAT. The software assists the user with more than 100 complete function blocks and intuitive operation for the implementation of their ideas.



This saves time when creating applications with high operational reliability.

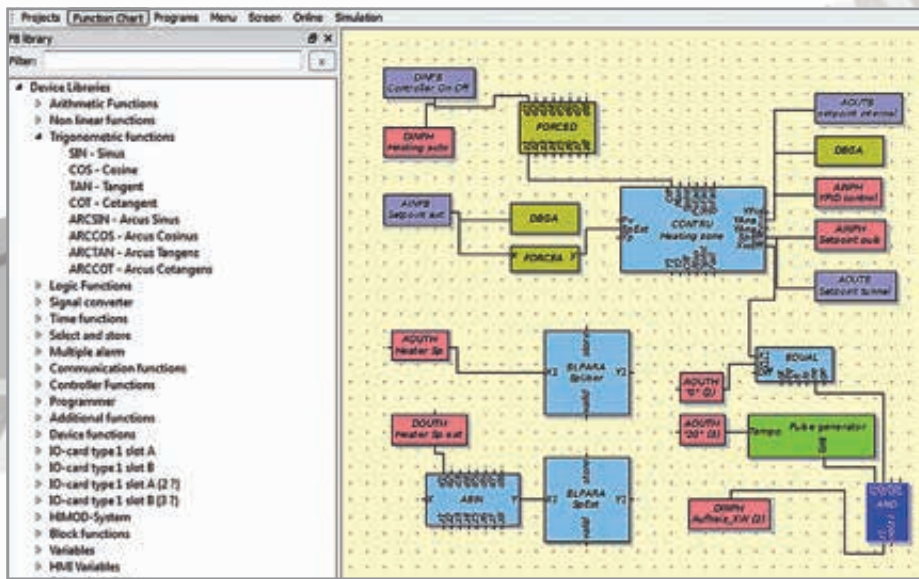

GHM-CAT function block editor (Illustration 1)

Quick and easy to put ideas into practice

The application production is particularly easy with the GHM-ONE. Based on the concept of connecting of existing function-card blocks, the user creates applications comprising process controls, mathematical calculations and process regulation in the shortest possible time.

For this purpose the GHM-CAT configuration software provides a function library with more than 100 tested functions from many areas.

- Input and output signals
- Computing functions
- Logic functions
- Signal conversion
- Time functions
- Memory functions
- Communications functions
- Profiler functions
- Regulating PID functions

Unique simulation function – The GHM-CAT editor

The user only has to combine and connect these functions in the editor and thereby implement their idea without the need for any programming skills.

Therefore, the user can concentrate entirely on implementing their idea. In addition to the support provided to the user by the function library, the GHM-CAT configuration tool offers additional functions in the editor.

For instance, the user can structure their application in order to maintain an overview, create their own function blocks for recurring functions in order to save time, and test sub-areas of their application independently of other project areas with simulation functions.



With the GHM-CAT the user implemented their application without much training time.

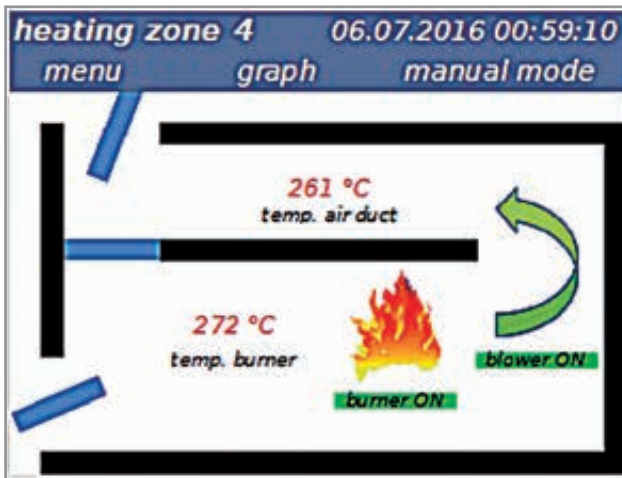

Individual operating side with process-synchronous animation of picture elements (Illustration 2)

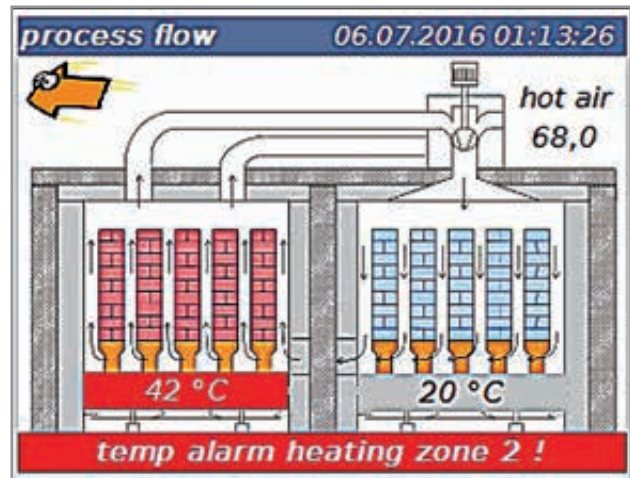

Individual process picture (Illustration 3)

Individual operating and monitoring concepts

The work does not end with the creation of pure process control and regulation for modern machine and system parts. The process technician must provide the operator on site with the possibility of effectively monitoring and operating the system.

The user must also remain well-informed in the event of a fault in order to keep the system downtime to an absolute minimum. Standard operating concepts are of little help in this connection.

Therefore, the GHM-ONE is based on a concept that enables individual design of the operation and visualisation.

The HMI editor of GHM-CAT

For this purpose, the GHM-CAT software provides an image editor that makes it possible to realise the widest range of operating and monitoring concepts with a few simple standard functions.

In addition to the individual operating sides also standard sides are available in the screen editor.

- PID control operation
- Profiler operation
- Trend visualisation
- Parameter dialogue
- Alarm management

With the combination of standard operating screens and individually designed screen, an efficient interface between the operator and the process is created in the shortest time.



**Complex operating structures
be easily realized with the
HMI editor.**



GHM-CAT simulation (Illustration 4)

Testing and commissioning – quickly and easily

Of course, the process technician's work is not finished with the creation of an application and its operation. The application still has to be tested and commissioned afterwards. For this important and in some cases lengthy phase, the new GHM platform provides various functions to streamline this phase.

An essential point is the PC simulation of the complete application. The entire application can be tested on a PC independently of the actual process.

For this purpose, the GHM-CAT software has a simulation environment for the GHM-ONE and for connected I/O assemblies. With this environment, the user is capable of testing the entire application, including operation on the PC, without endangering the real process. Simply test the application at a desk without risk.

There are additional testing functions available to the user for the on-site system commissioning phase.

Online trend function – Debugging und Forcing

An essential component is an integrated online trend function that allows the user to view all analogue and digital signals online in a trend and thereby quickly and easily monitor the desired functions. Of course, there are also debugging and various forcing functions available for the testing.

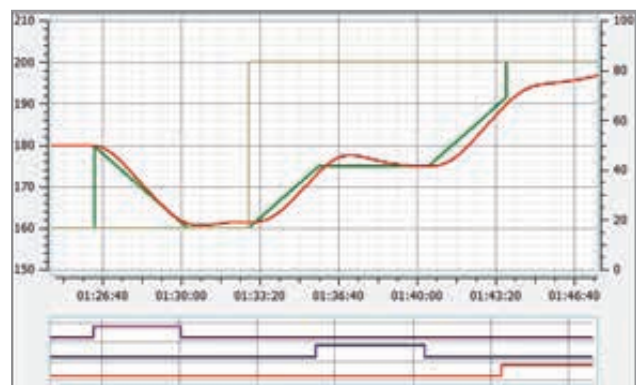

Online trend function (Illustration 5)



Simulation on a PC significantly shortens testing and commissioning times and increases system safety.

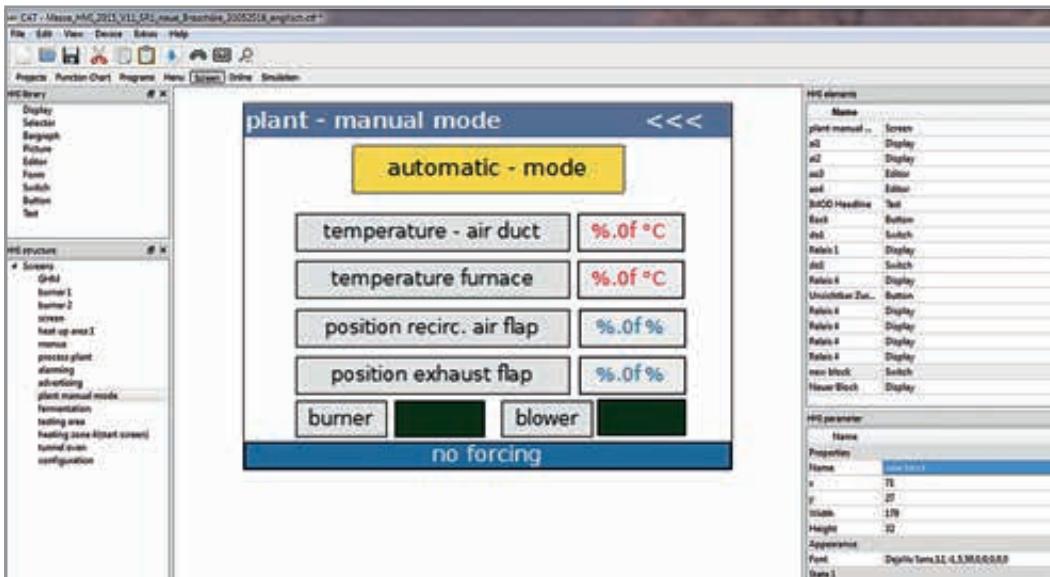

GHM-CAT HMI editor (Illustration 6)

Programming – without computer language GHM-CAT software configuration tool

The GHM-CAT (Configuration and Application Tool) tool enables the user to completely configure the GHM-ONE.

It essentially comprises the function plan editor, the HMI editor, the menu editor, the simulation, and commissioning assistance with debugging function and online diagrams.

The major functions

- Creation of the application from finished functions
- Found invarious libraries
- Graphic linking of functions in the function plan editor
- Automatic alignment of connections
- Parameterisation of functions
- Creation of operating structure and visualisation (HMI)
- Creation of test menus for parameterisation on the GHM-ONE
- Creation of programs for the profiler
- Simulation of the overall application on the PC, including simulation of control paths
- Online device function with debugging functions for application
- Testing
- Transfer of applications to the GHM-ONE
- Firmware update function
- Online help for all functions



All configurations for the GHM-One takes place in a single tool.

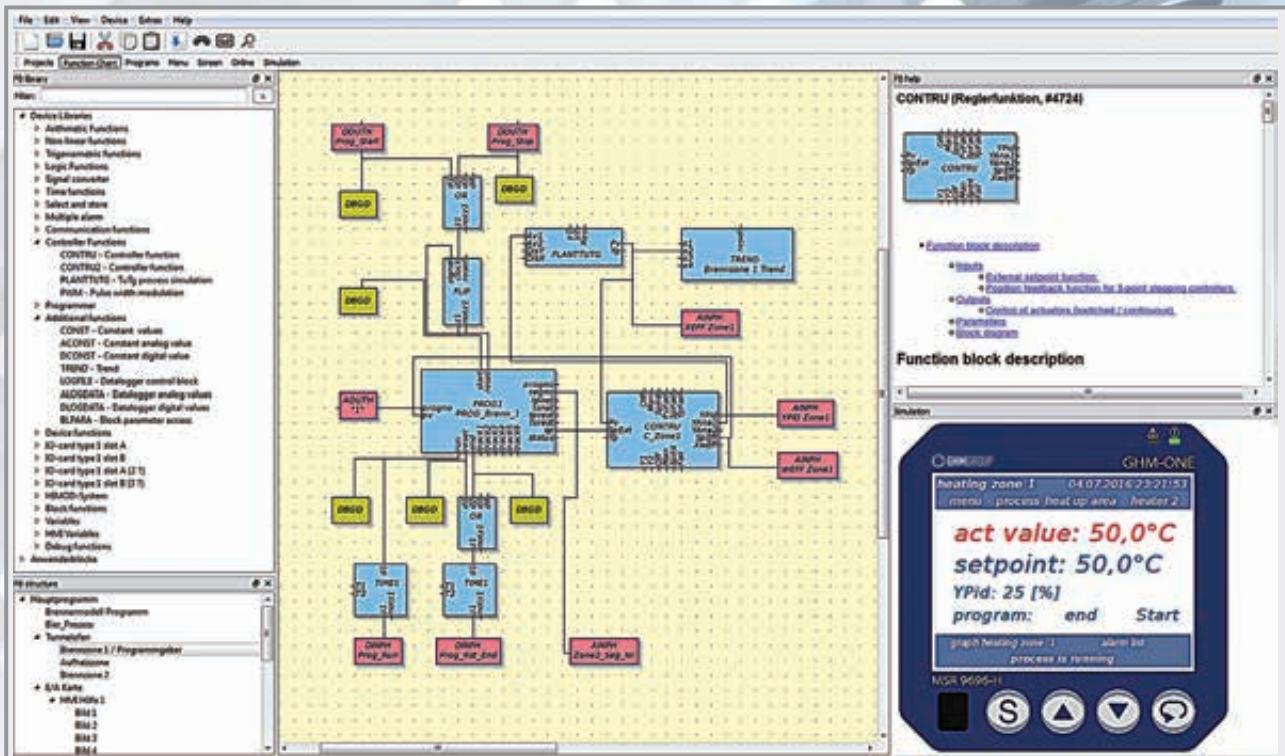

Application designer GHM-CAT (Illustration 7)

Function plan editor with library

The core of the application creation is the function plan editor with the function module library. With the help of the function functions, the user assembles their application without the need for any programming skills.

There are more than 100 tested functions in the library which can be easily placed on the desktop and connected using the mouse. Declaring of variables and complex assignment of functions are omitted. In this manner, the user can effectively create their system or process from finished modules.

The application operating and monitoring screens are then created based on the function block application. Therefore, specific information can be displayed for the person on site and detailed screens can be created for service technicians. These screens are freely configurable. It is even possible to integrate process screens or other graphics. The user can also create text-based operating screens in order to enable efficient input of several types of process data.

Exact simulation of the device – WYSIWYG

After the application has been created, it can also be tested in the GHM-CAT tool. With the simulation, the software offers an exact representation of the device in all its functions. Even the hardware inputs and outputs can be simulated.

The user can test the application in an initial step without any risk for the system.

Support of the user by the GHM-CAT software continues in the scope of the commissioning with various forcing and debugging functions and a refined online visualisation of analogue and digital values. With this wide variety of information and intervention possibilities, efficient commissioning is practically assured.



All configurations for the GHM-ONE takes place in a single tool. The elaborate orientation in various software packages for controllers, data monitors, data loggers, mini-SCADA and mini-PLC can be dispensed with.

Application designer GHM-CAT

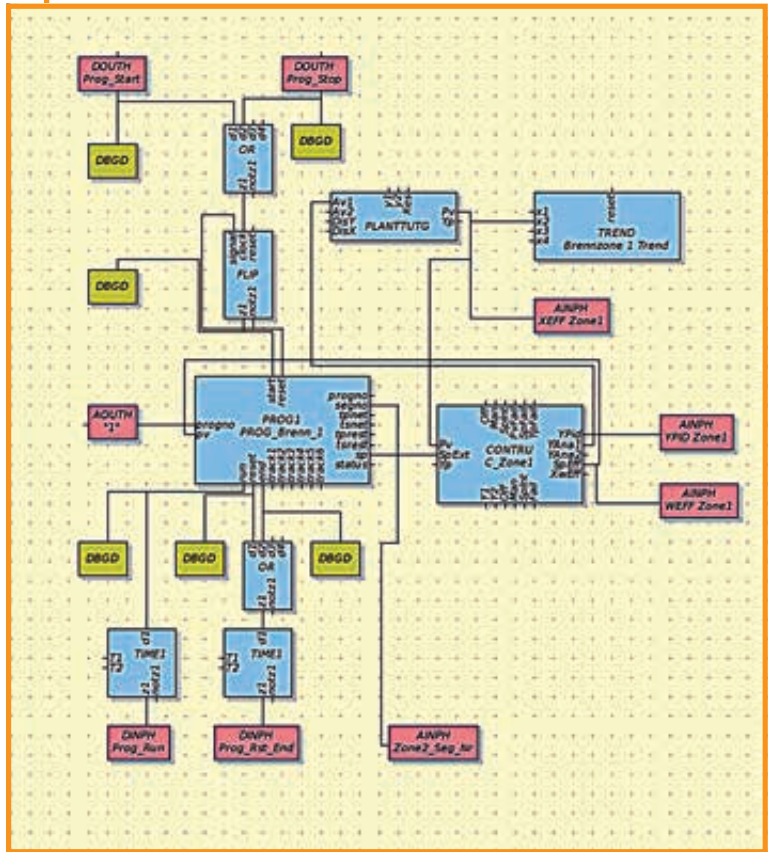
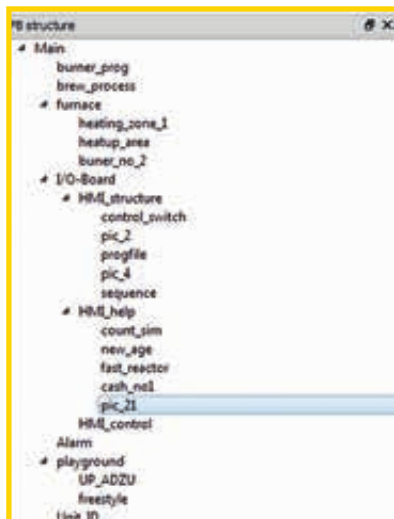
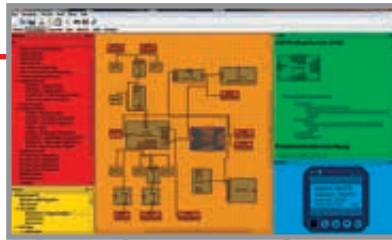
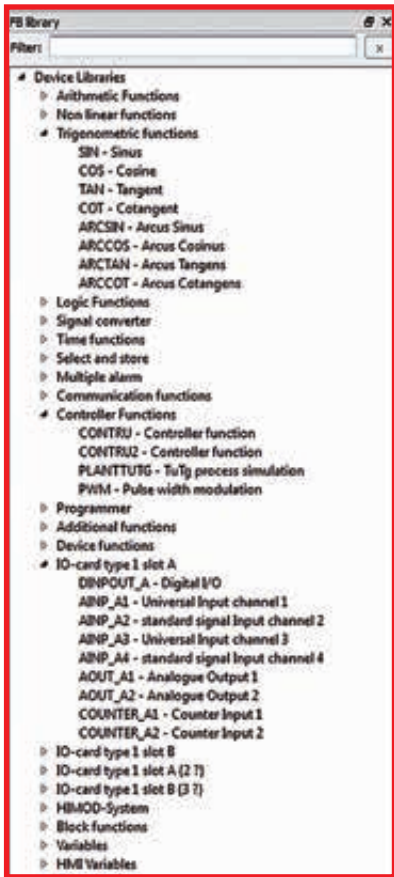

GHM-ONE example controller operation
(Illustration 8.1)



GHM-ONE example profiler operation (Illustration 8.2/8.3)

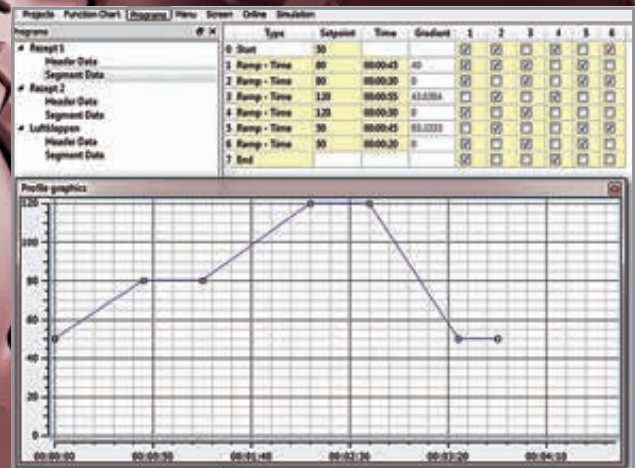

GHM-CAT profile editor (Illustration 9)

Regulation technical functions

The function library provides controller modules as a basis for control-related tasks.

- 2-point controllers
- 3-point controllers
- Motor step controllers
- Steady regulator

It is possible to operate the controllers as constant or switching controllers. A wide spectrum of setpoint and actual value functions and setpoint functions round out the scope of module functions. Other functions are ready for specific duties to support the user by the realisation of the duties.

- Boost function
- Soft start
- Smooth switching
- PID parameter adaptation

With the help of several regulator stones complicated structures can be also moved in the area of the mesh control circuits.

- Cascade control
- Limit control
- Ratio control
- Multi-Loop control

Other control strategies can be implemented using the standard functions. Of course all controllers offer the possibility for self-optimization.

But that is not all when it comes to control technology and process control. The library also provides a profiler that is needed in many cases to adopt the control for certain processes.

This is necessary whenever the material structure must be influenced over the course of a process. The profiler comprises up to 20 programs with 60 segments each.

One analogue and 6 digital tracks are available per segment. The program structure is realised in GHM-CAT with simple input of the segment times and setpoints.



With the help of ready to use controller modules, realisation of control technology tasks is possible without extensive knowledge in the area of control technology.

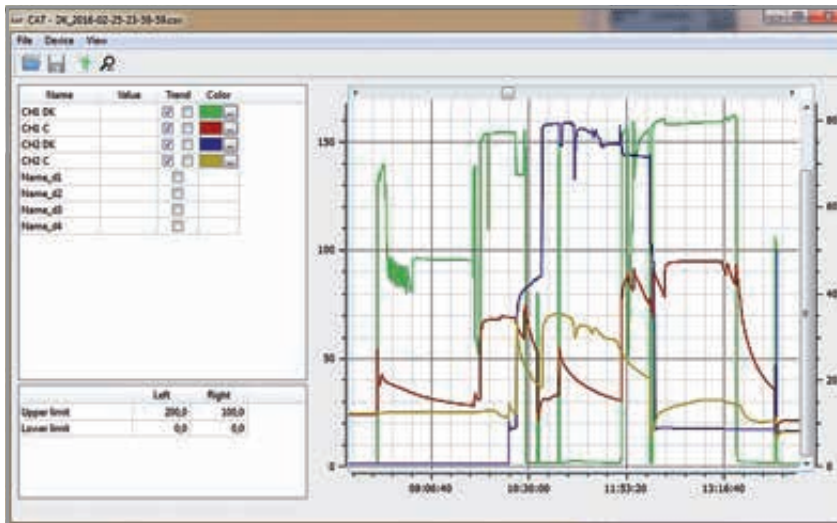

Data recording (Illustration 10)

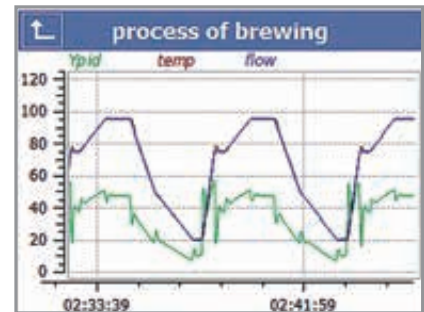

GHM-ONE trend representation (Illustration 11)

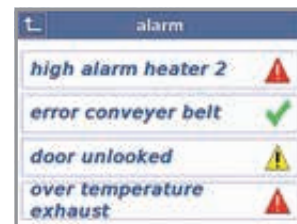

Alarm management (Illustration 12)

Data recording

In many areas of industry, the recording of process data is an essential element of quality assurance. The GHM-ONE library offers the possibility of realising a data logger and a data recorder in the device. Configuration of the data logger takes place directly in GHM-CAT with function blocks. This makes it possible to log digital and analogue signals in various time periods.

The analogue data can be recorded as minimum, maximum or mean values over a specific time period. The data is saved in the device on an eMMC-chip and can be read via the Ethernet port via FTP. The device has a data storage capacity of 2 GB. The readout of data via USB port on the front side is possible.

The data is provided to the user in a standard ASCII format (csv) for further processing and analysis.

Trend representation

The trend representation on the device takes place on predefined operating screens. Up to 4 curves can be represented in one trend.

By cascading the function, various time periods can be represented. Since the trend block can be opened multiple times in the visualisation, it is possible to use the GHM-ONE as a multi-channel recorder.

The trend representation is independent of the logger function, and so various process signals can be displayed and recorded. The library also provides an alarm block. This block can be used to display alarm lists in plain text on the device.

A function block can be used on the device to display alarm lists in plain text. The Alarm Management includes a reset function.



Data recording, data logging and alarming round out the performance spectrum of GHM-ONE. No additional devices are required for visualisation and data backup.

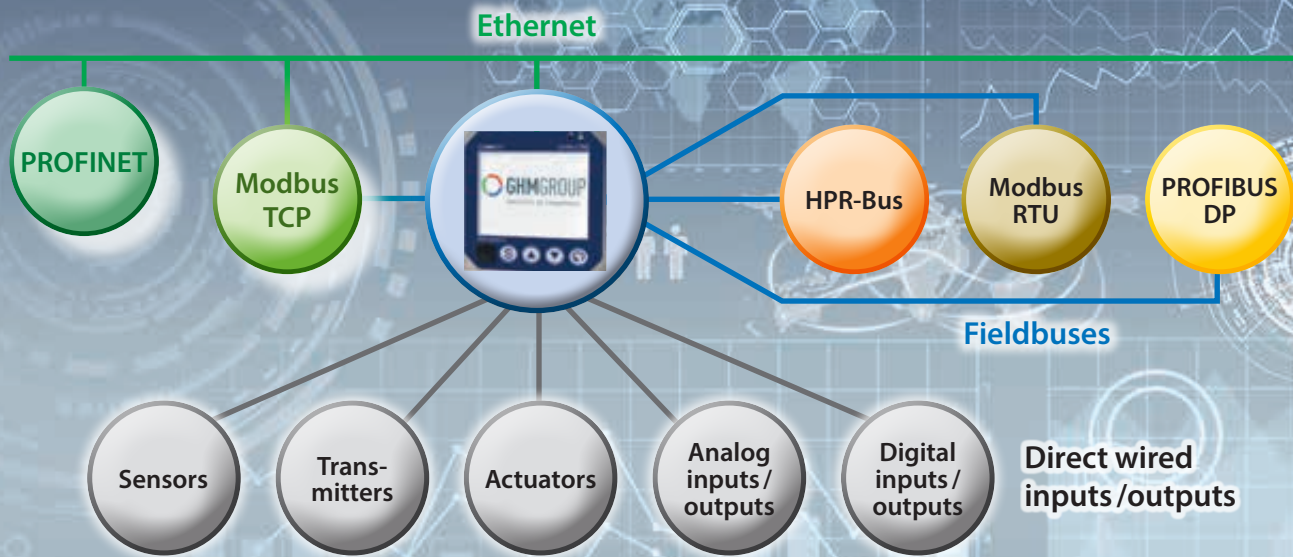

Block diagram – Communication (Illustration 13)

Communication

The GHM-ONE can be expanded with additional analogue and digital signals from the field with the optional communications card.

The expansion can take place with the GHM I/O system, wherein no additional bus couplers are required in the field. The hardware concept of the GHM-ONE also includes the possibility of connecting external I/O or other fieldbus participants via various fieldbus systems.

- Modbus TCP
- Modbus RTU

In the modern world of automation it is increasingly important that devices exchange data M2M with other devices. The user can approach this task with various interfaces to the PLC and control system level. For this purpose, the GHM-ONE offers various fieldbus systems.

- PROFINET
- PROFIBUS DP
- Modbus TCP

With this communication concept, the device can be integrated into various process areas. Of course, in addition to I/O systems, fieldbus compatible sensors and actuators can also be connected directly to the GHM-ONE with the standard systems.

The entire configuration of process values for external communication is created in GHM-CAT.

The files necessary for the master systems are provided for systems such as PROFINET and PROFIBUS DP. Integration takes place with the respective manufacturer's standard systems. Integration into an existing system is thus possible without a major additional expense. The user can use standards that have been established in the market.



Time-saving integration of the GHM-ONE in a superordinate leading calculator or PLC environment using standard fieldbuses. Simple expansion of the GHM-ONE I/O with external fieldbus systems.



Entering Industrial Age 4.0 with GHM-ONE

With "live streaming" in the music industry, the fundamental digitalisation of production processes – i.e. Industry 4.0 / Smart factory – has already been implemented.

However, in many traditional sectors such as machine construction and other industries, the horizontal and vertical networking of production processes are yet to come. With the GHM-ONE multifunction controller and the corresponding GHM-CAT software, Erolzheim-based GHM Messtechnik offers an up-to-date solution for process automation for the production application.

In tune with the times

Anyone looking to lead in the global competition must be able to respond immediately to changing demands with fully developed models. Consequently, manual production systems have already reached their limits.

For implementation in the concept of Industry 4.0, it is necessary to monitor processes more intensively. The initial step in the implementation is the proper equipment of processes with the correct sensors. GHM-ONE takes care of the integration, regardless of whether it is smart or conservative.

Changing requirements

For implementation in the structures of Industry 4.0, it becomes increasingly necessary for process experts to also be programmers. The modern engineering tool GHM-CAT enables graphically-oriented, intuitive operation for configuration of the compact GHM-ONE multifunction controller instead of software that is complex to operate.

Therefore, the GHM-ONE multifunction controller independently manages the process and communicates the relevant process data to superordinate systems via modern interfaces such as PROFINET and Modbus TCP. The new GHM-CAT software paired with the GHM-ONE multifunction controller is a possible solution for step-by-step travel on the road to Industry 4.0 in the area of process automation.

Smart solutions for automation

- Compact automation system
- Direct connection of sensors and actuators
- Communication with field bus and Ethernet networks
- Intuitively operating GHM-CAT engineering tool
- Individual, multi-variable and ratio control
- For temperatures, pressures, flow rates, fill levels, moisture, pH, conductivity, etc.
- Integrated typical PLC tasks
- Decentralised and autarkic automation in the Industry 4.0 concept

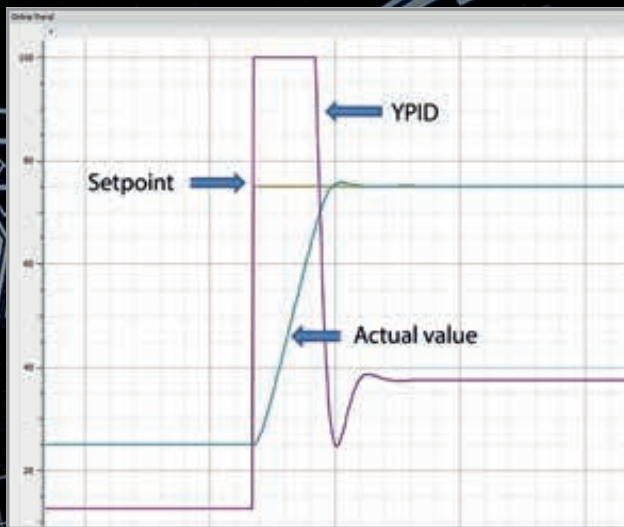

Representation of an optimised approach process (Illustration 14)

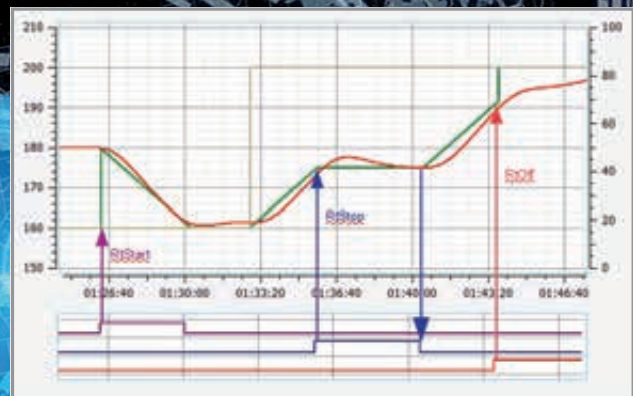

Rated value adjustment with and without ramp course (Illustr. 15)

Control Engineering

The GHM-ONE is the centrepiece of the process control development of the GHM Group and serves as a basis for further developments for industrial compact controllers.

The GHM-ONE is a multi-function platform with a modern, innovative concept for measuring, controlling, computing, recording data, visualising, operating and regulating.

Adaptation to system requirements takes place with a single "GHM-CAT" software package, which can be operated without any programming skills.

All illustrated graphics are taken of the GHM-ONE On-line help.

Highlights

PID controller with self-optimisation

The core of the GHM-ONE is a precise PID controller with self-optimisation that can be adapted for the widest range of control tasks. In the process, the aim is optimal regulation of the process according to the operating company's requirements. Product quality and process stability, as well as a minimisation of process times, are the major areas of emphasis.

The GHM-ONE offers various controller functions that can be combined using efficient functional blocks to create an overall application in order to meet these requirements.

The newly developed algorithm for self-optimisation independently finds the optimal controller parameters for many applications and thus reduces commissioning times. The controller algorithm developed especially for the GHM-ONE is the basis for short regulating times with only minor fluctuations of the control variable. (Illustration 14).

The control accuracy can be influenced by the user or the process in order to always ensure optimal utilisation of energy and material during the operating time.

Shock-free switching

Sensitive adjustment of the setpoint in order to avoid endangering product quality or overstress the switching equipment is a recurring challenge. For this reason, the GHM-ONE controller offers the possibility of a setpoint ramp. In this case, the setpoint jump from the user or the SCADA system is automatically implemented as a ramp (Illustration 15.).

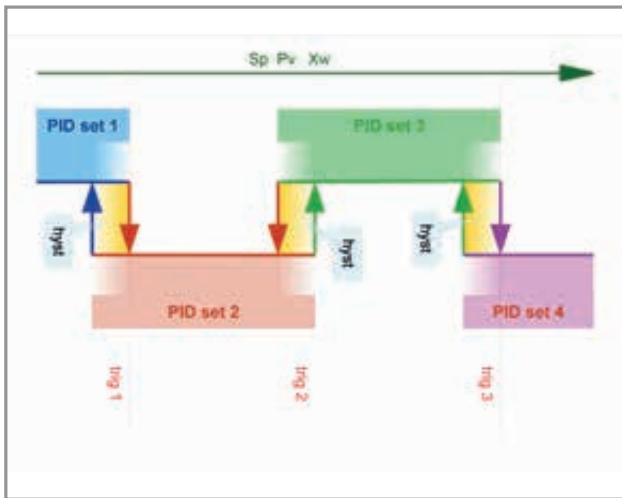

Automatic change-over of the control parameter sentences PID (Illustration 16)

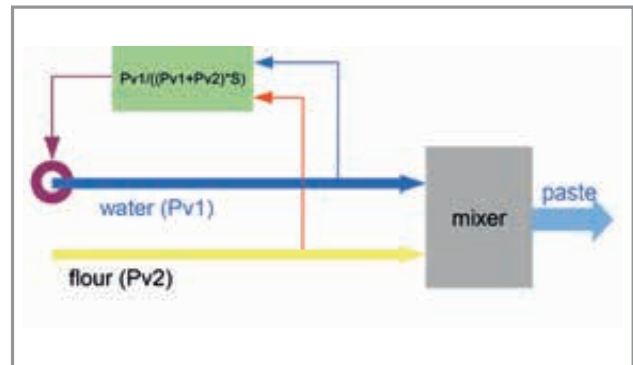

Ratio closed loop control regulation (Illustration 17)

Process-dependent PID parameters

Regulation of non-linear segments or systems with various load states is normally a challenge.

For this purpose, the GHM-ONE supports the user with, among other things, the possibility of process-dependent PID parameters. Therefore, the appropriate set of parameters can be used various phases of the process (Illustration 16). In the process, switching takes place either automatically or by user command.

Ratio and multi-component regulation

In addition to the regulation of process variables, there is always a need to regulate the ratio of process variables. The control module supports the user in this connection with special functions for actual value processing. Therefore, the user can, for instance, regulate the mixture ratio of materials (Illustration 17) or regulate a stoichiometric combustion air ratio. (Illustration 18)

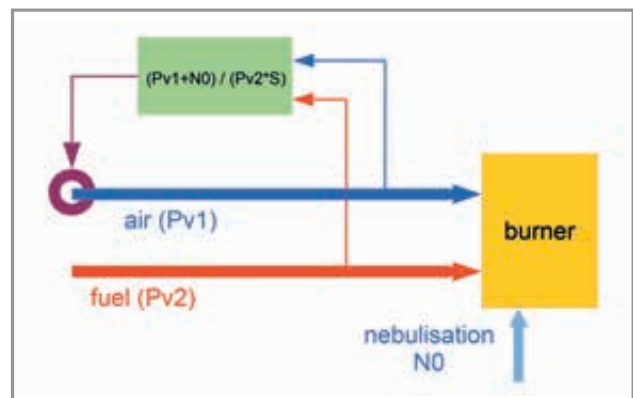

Stoichiometric combustion air ratio (Illustration 18)

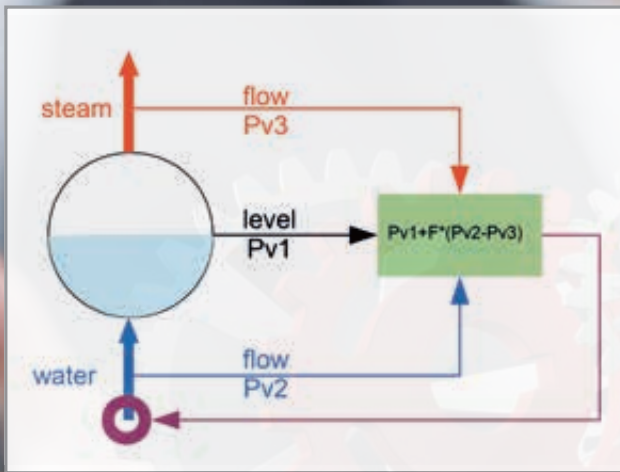

Three-component regulation (Illustration 19)

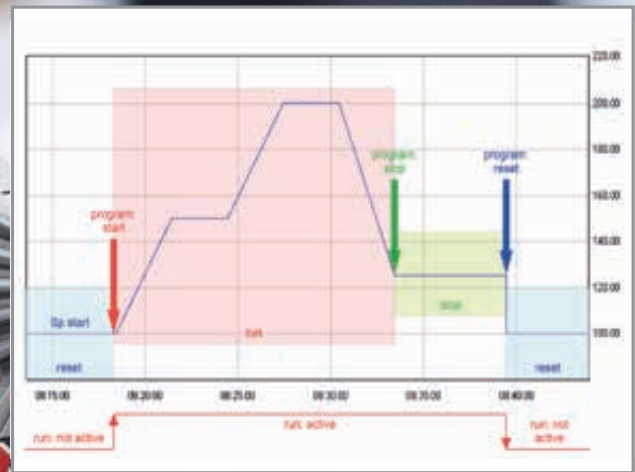

Programmer profile (Illustration 20)

Cascade control / override control / multi-loop system

Since the control module in the GHM-ONE can be used repeatedly, the user can also create more complex regulating structures, such as cascade control for increased control accuracy of intricate processes or an override control (forced control) to prevent excessive stress. Of course, a multi-loop control system is also possible.

Integrated profiler

In many processes a temperature profile or various mixture ratios play an important role during production. In order to ensure that the user does not have to create an elaborate programmer, the GHM-ONE already offers a profiler with profile editor. (Illustration 20).

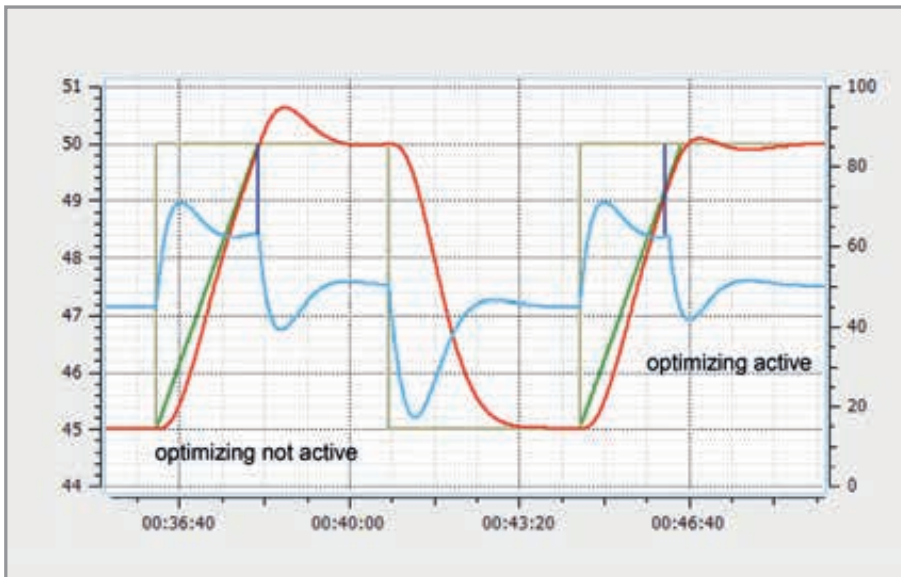

Temperature profiles without harmonics finish function (Illustration 21)

Profiler

This profiler can be used repeatedly within an application. An important element for setpoint profiles is the ramp function. With an external programmer, the user repeatedly faces a situation where there is a heavy overshoot at the end of a ramp.

The GHM-ONE compensates for this with a connection between the profiler and controller modules (Illustration 21).

Finish line function

The controller module has a newly developed finish line function. This function ensures that undesired jumps in variables at the end of a ramp are avoided. The setpoint is approached more gently as a result.

Process computer

The computing functions of the GHM-ONE can be used for calculation of process variables, such as a heat quantity. It is also possible to use the results for additional control processes.

For instance, limiting regulation for chemical applications or C-level regulation for carbonisation processes can be effectively implemented. The logic modules can also be used optimally in this connection.

In addition to the control functions currently expected in industry, the GHM-ONE controller offers numerous additional functions

- Customised operation and visualisation
- Capability of integrating process control units
- Recording and representation of process variables
- Communication modules for integration into various process landscapes

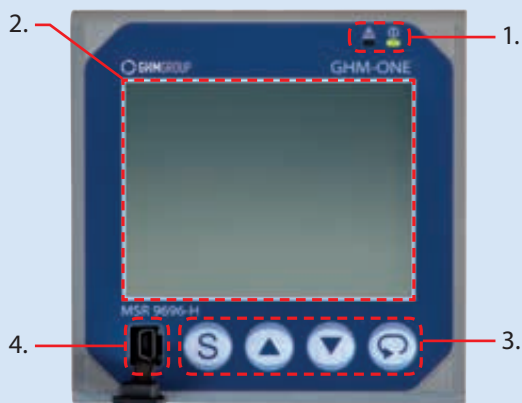

Device front side

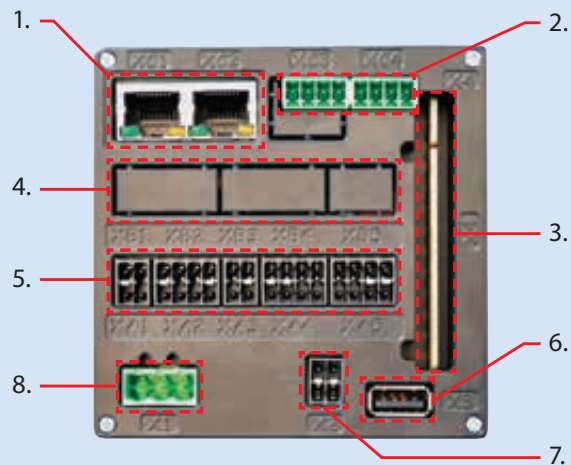

Device rear side

Functions in detail

1. Definable red/green status indicator LEDs
2. 3.5" TFT colour graphic touch display
3. Freely configurable operating keys
4. USB device
 - Load / read applicatio
 - Debugging functions (online representation)
 - Write / read parametersn

1. Ethernet communication interface (see detailed description under "Communication")
2. Serial RS485 Modbus / HPR bus communication interface
3. Relay card with 4 changeover contact (see detailed description under "Relay outputs")
4. I/O card – slot B (see detailed description under "Standard I/O card")
5. I/O card – slot A
6. USB host
7. Transmitter feed
8. Voltage supply

General

- Protection rating IP 65 (Front side)
- Protection rating IP 20 (Rear side)
- Outside dimensions:
96 mm x 96 mm x 115 mm (HxWxD)
(installation length without plugs and wires)



- Coding protection of the terminals
- Easy-to-use spring-type terminals
- Lockable wire terminal plate for relay connections

Overview of rear-side slots / connections

Communications card
Modbus / HPR bus

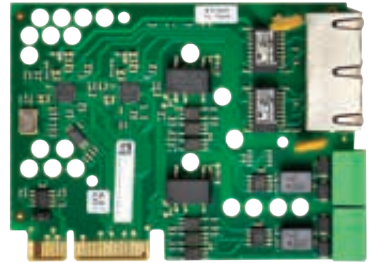

I/O card slot B (optional type 1 or type 2)

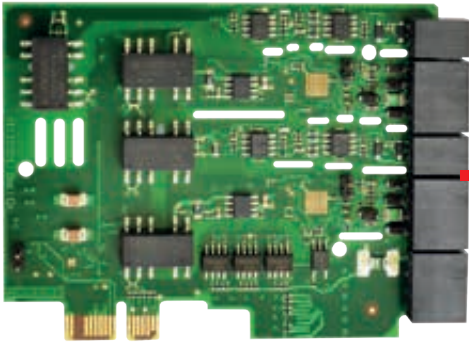

I/O card type A (optional type 1 or type 2)

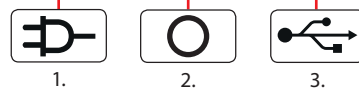
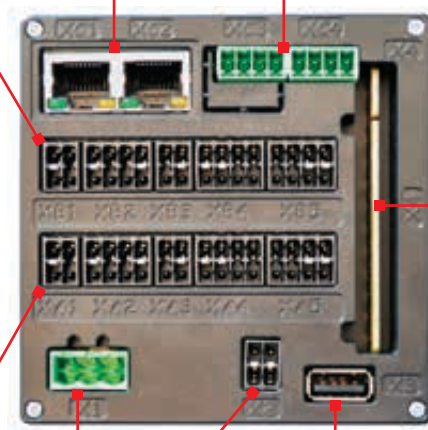
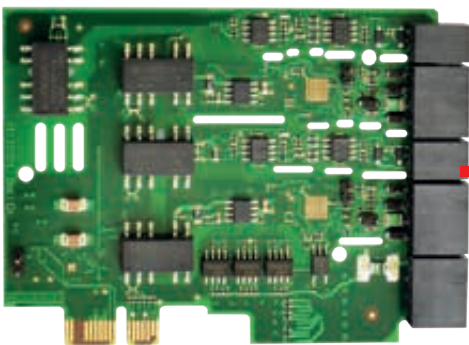

1. Power supply connection
2. Transmitter power supply
3. USB host

Relay card with 4 changeover contacts



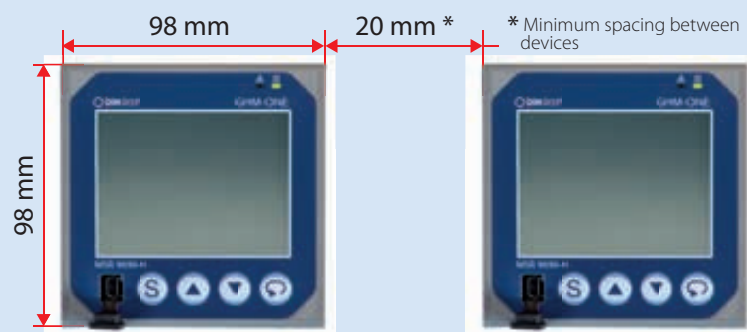
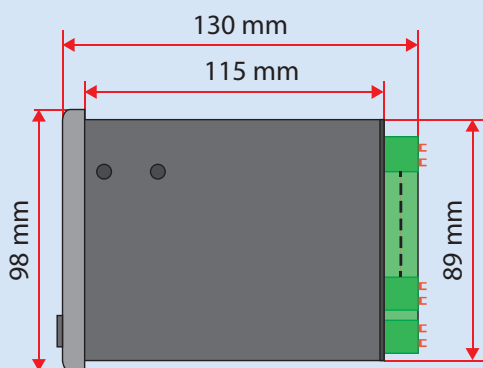

Dimensions

General specifications (base unit)

Controls / device front

Keys:	4 freely assigned keys
Touch function:	Resistive touch display
Display	
Front LEDs:	1 red freely assigned LED 1 green freely assigned LED
Display:	3,5" TFT display 320 × 240 Pixel QVGA resolution

Data logger

Storage medium:	eMMC chip
Storage capacity:	approx 1 GB
Storage rate:	≥ 1 second

Auxiliary energy

Supply voltage:	100 ...240 V AC oder 24 V DC
Power consumption:	Typically 10 W
Electrical connection:	Spring-type terminal, 3-pin
Conductor cross-section:	0,25 mm to 2,5 mm
Galv.anic isolating:	E/A-level / auxiliary energy / processor

Enviromental conditions

Operating Temperatur:	0...+55 °C
Storage temperatur:	-20...+70 °C
Relative air humidity:	95 %, non-condensing

Air- and creep distances

Degree of contamination:	2
Overvoltage category:	II
Maximum elevation:	2000 m

Rated voltage category a:	230 V
Test voltage category a:	3000 VAC 1 min.
Rated voltage category b:	50 V
Test voltage category b:	520 VAC 1 min.

Housing

Type:	Device for control panel installation
Protection rating:	IP65 front side IP20 tube and rear side
Width/height/depth:	98 × 98 × 115 mm (without plug) 98 × 98 × 130 mm (with plug)
Panel cutout :	92 × 92 mm

Outputs (relay card)

The relay card is a base card with 4 relays designed as changeover contacts. It is not possible to exchange the relay card with other I/O cards.

Relay

Type:	Changeover contacts
Number:	4
Electrical connection:	Spring-type terminal
Conductor cross-section:	0.25 mm to 1.5 mm
Switching voltage:	< 250 V AC < 4 A

Note

If a control contactor is connected to a relay output, an RC protective circuit (RC snubber) required according to the contactor manufacturer specifications in order to prevent high voltage peaks. Varistor protective circuits are not recommended.

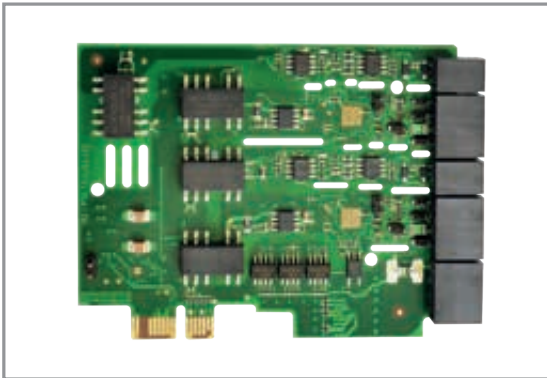

Up to 2 I/O cards can be installed in the device.

Technical specifications I/O card

- 2 analogue universal inputs
- TC / RTD / -1000...+1000 mV / 0...+20 mA)
- 2 analogue standard inputs
(0...+10 V / 0...+20 mA)
- 2 analogue standard outputs
(0...+10 V / 0...+20 mA)
- 6 digital inputs or outputs

Analogue universal inputs

The card is equipped with 2 analogue universal inputs

Galvanic isolation

The two universal inputs are galvanically isolated from each other. There is also galvanic isolation for the power supply, the digital inputs and outputs, analogue outputs, and the processor and the communications. There is a galvanic connection to the corresponding analogue standard input (terminal X2 / terminal X4).

Converter resolution: > 18 Bit
 Cycle time: 50 ms
 Galvanic isolation: corresponding to category a

RTD measurements

Input type: Resistance
 Connection type: 3-wire

Measuring ranges

Pt100 / Pt1000 -200...+850 °C
 Ni100 / Ni1000 -60...+300 °C
 KTY 11-6 -50...+125 °C

Measured current

Pt100 / Ni100 I < 0.5 mA
 Pt1000 / Ni1000 I < 50 µA
 Accuracy: ≤ 1 K
 Temperature drift: ≤ 0.08 % / 10 K
 Measuring circuit monitoring: Short-circuit and interruption

Thermocouple measurements

Input type: Voltage measurement
 Connection type: 2-Wire
 Input resistance: >10 MΩ

Thermocouple

Type	Measuring range	Accuracy	Resolution
L	-200...+900 °C	≤ 2 K	0.05 K
J	-210...+1200 °C	≤ 2 K	0.05 K
K	-270...+1370 °C	≤ 2 K	0.08 K
N	-196...+1299 °C	≤ 2 K	0.08 K
S	-50...+1760 °C	≤ 2 K	0.07 K
R	-50...+1760 °C	≤ 2 K	0.07 K
T	-270...+400 °C	≤ 2 K	0.02 K
E	-270...+1000 °C	≤ 2 K	0.04 K
B	+25...+1820 °C	≤ 3 K	0.1 K
W	0...+2299 °C	≤ 3 K	0.1 K

Temperature drift: ≤ 0.08 % / 10K
 Measuring circuit monitoring: Interruption
 Cold-junction compensation: internal / auxiliary error < 2 K

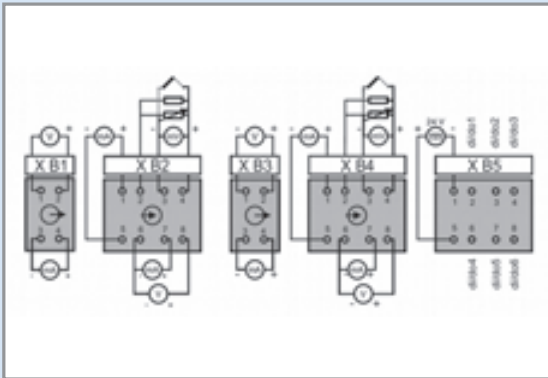

Connections of the I/O card

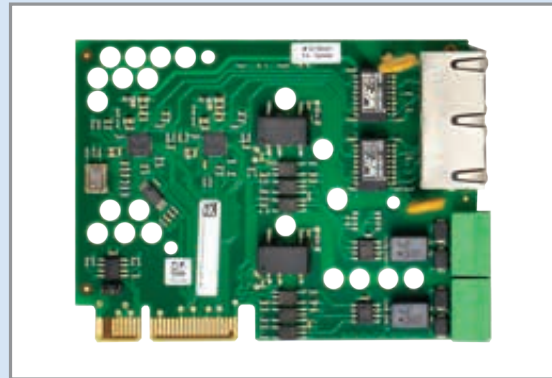

Communication card Ethernet / RS485

Resistance measurement

Input type: Resistance measurement
 Connection type: 2-Wire
 Measuring range: 0...20 k Ω
 Detection range: Measuring range + 10 %
 Accuracy: $\leq 0.1 \%$
 Temperature drift: $\leq 0.08 \%$ / 10 K
 Measuring circuit monitoring: Exceeding the detection range

Current measurement

Input type: Current
 Connection type: 2-Wire
 Measuring range: 0...20 mA
 Detection range: Measuring range + 10 %
 Input impedance: max. 50 Ω
 Accuracy: $\leq 0.1 \%$
 Temperature drift: $\leq 0.08 \%$ / 10K
 Measuring circuit monitoring: Exceeding and/or undercutting the detection range

Analogue standard input

The card is equipped with 2 analogue standard inputs.

Galvanic isolation

The two standard inputs are galvanically isolated from each other. There is also galvanic isolation for the power supply, the digital inputs and outputs, analogue outputs, and the processor and the communications. There is a galvanic connection to the corresponding analogue universal input (terminal X2 / terminal X4).

Converter resolution: > 18 Bit
 Cycle time: 50 ms
 Galvanic isolation: corresponding to category a

Current measurement

Input type: Current
 Connection type: 2-Wire
 Measuring range: 0...20 mA
 Detection range: Measuring range + 10 %
 input impedance: max. 50 Ω
 Accuracy: $\leq 0.1 \%$
 Temperature drift: $\leq 0.08 \%$ / 10 K
 Measuring circuit monitoring: Exceeding and/or undercutting the detection range

Voltage measurement

Input type: Voltage
 Connection type: 2-Wire
 Measuring range: 0...10 V
 Detection range: Measuring range + 10 %
 Input impedance: typically 1.2 M Ω
 Accuracy: $\leq 0.1 \%$
 Temperature drift: $\leq 0.08 \%$ / 10 K
 Measuring circuit monitoring: Overshoot or undercut of the detection range

Analogue output

The card is equipped with 2 analogue standard outputs.

Galvanic isolation

The two standard outputs are galvanically isolated from each other. There is also galvanic isolation for the voltage supply, digital inputs and outputs, analogue inputs and for the processor and communication.

Converter resolution: 12 Bit
 Linearity: < 0.1 %
 Accuracy: < 0.2 %
 Temperature drift: $\leq 0.1 \%$ / 10 K
 Cycle time: 50 ms
 Galvanic isolation: corresponding to Category a

Current output

Control range: 0...+22 mA
Output resistance: max. 500 Ω

Voltage output

Control range: 0...+11 V
Output load: $RL \geq 1 \text{ k}\Omega$

Digital inputs and outputs

The I/O card is equipped with six inputs/outputs with configuration of the function executed by the respective signal in the CAT. The power supply to the inputs/outputs must be fed externally.

Galvanic isolation

The inputs/outputs are galvanically isolated from each other. There is galvanic isolation for the voltage supply, digital inputs and outputs, analogue inputs and for the processor and communication.

Supply voltage: 24 V DC +/- 20 %
Galvanic isolation: corresponding to Category a
Digital outputs: maximum output current 100 mA

Meter input

Two digital inputs (Input 1 and 3) can be configured as meter inputs.

Limit frequency: 10 kHz
Output signal: Pulses per time unit (configurable)

Electrical connections

Electrical connection: Spring-type terminal
Wire cross-section: 0.25 mm to 1.5 mm (with wire end ferrule / without plastic ferrule)

Wire cross-section: 0.25 mm to 0.75 mm (with wire end ferrule / with plastic ferrule)

Communication card Ethernet / RS485

The communication card is equipped with 2 Ethernet ports (in accordance with IEEE 802.3) and 2 RS485 interfaces.

Ethernet connection: RJ-45
Function: 10/100 Mbit/s
Auto-Negotiation
Auto-MDIX
IP via DHCP or fix
LED: Link / Data
Protocol: ModBus TCP Slave
ModBus TCP Master
FTP server

Ordering code

GHM-ONE

MSR9696H - 1. - 2. - 3. - 4. - 5.



GHM		
Multi-function controller		
1. I/O card slot A		
0	No card in slot A	
1	I/O card with 2 universal inputs 2 standard signal inputs 2 analogue standard signal outputs 6 digital inputs or outputs	
2	I/O card with 2 universal inputs 2 high-impedance mV inputs for O ₂ measurement 2 analogue standard signal outputs 6 digital inputs or outputs	
2. I/O card slot B		
0	No card in slot B	
1	I/O card with 2 universal inputs 2 standard signal inputs 2 analogue standard signal outputs 6 digital inputs or outputs	
2	I/O card with 2 universal inputs 2 high-impedance mV inputs for O ₂ measurement 2 analogue standard signal outputs 6 digital inputs or outputs	
3. Communication card		
0	No communication card	
1	Communication card with 2 x Ethernet; 2 x RS485 (Modbus TCP / Modbus RTU and HPR-Bus)	
2	PROFINET, Ethernet/Modbus RTU, HPR-BUS	
4. Auxiliary voltage		
1	230 V AC	
2	24 V DC	
5. Options		
0	No options	
Zubehör		
	USB connecting cable for connection of a PC, length 1.5 m (Art. No. 190064)	

GHM-CAT software

CAT - 1.

GHM		
1. Software licenses		
LZ1	One license dongle	
LZ2	3 license dongle	
LZ5	5 license dongle	
LZ10	10 license dongle	

Notes

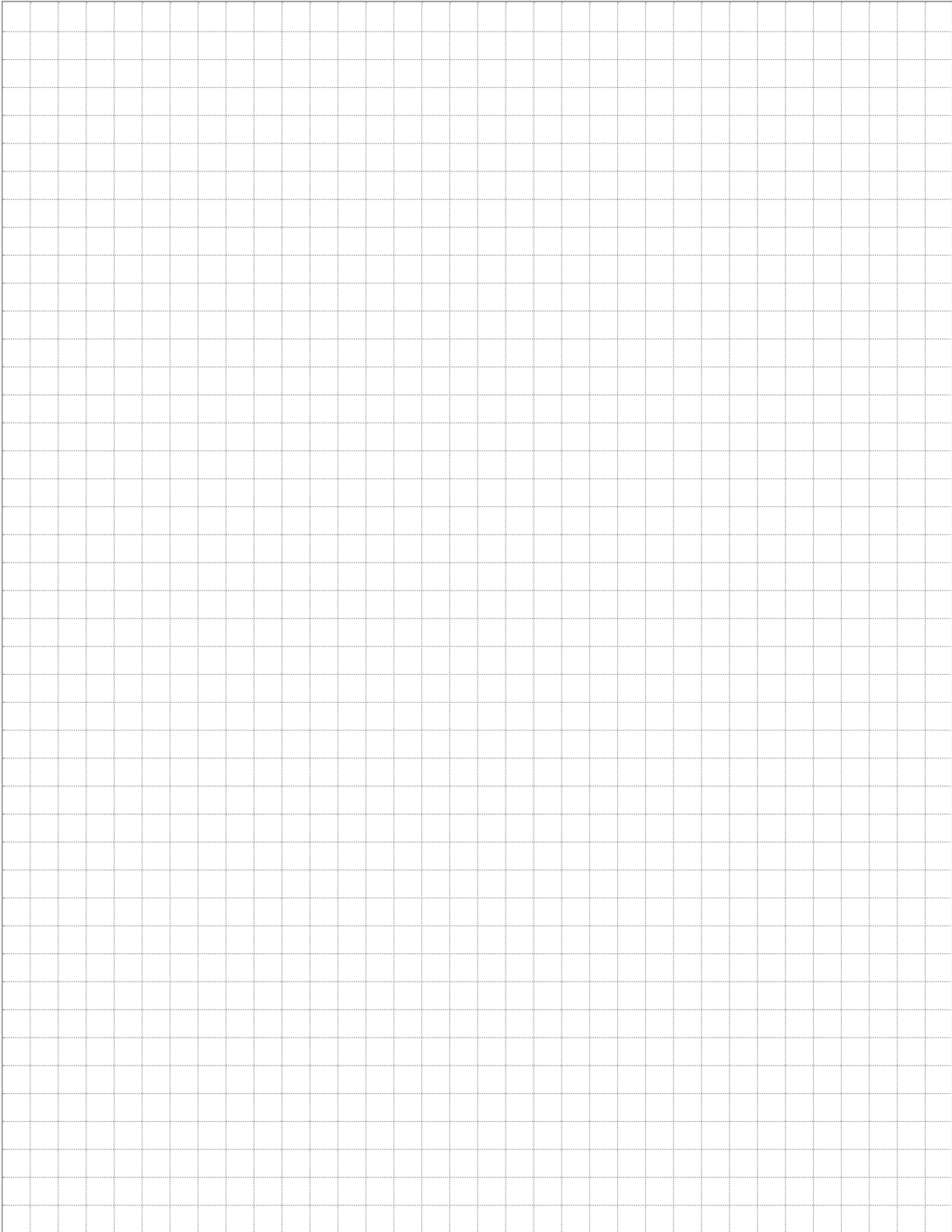

Notes

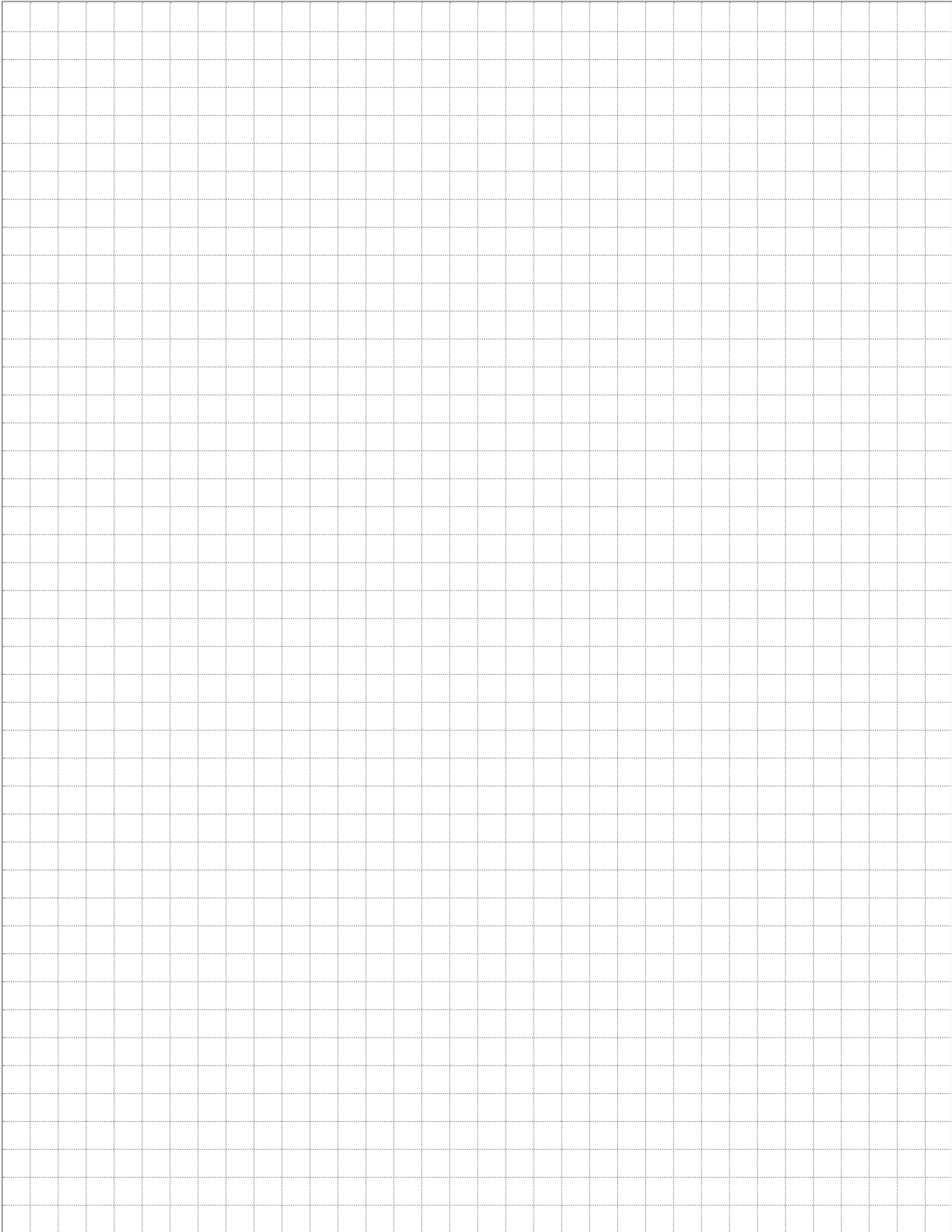

Your contact to us.



Sales Center Export

-  info@ghm-group.de
-  +49 2191 9672-0
-  +49 2191 9672-40



Asia and India

- Subsidiary in Mumbai
- Numerous certified partners



Europe

- 12 locations, including sales centers
- 5 production locations and specialized sales locations



Americas

- Subsidiary in São Paulo
- Qualified partners



Africa

- Subsidiary in Johannesburg
- Reliable partners



Your ideas and requests are our inspiration.

Challenge us.

The GHM Messtechnik GmbH Group was founded in 2009. However, the history of the traditional brands that are bundled under the umbrella brand goes back much further. In its current formation as the GHM GROUP, the enterprise is still obligated to the shared philosophy of the founders: Absolute customer orientation, speed, and first-class product quality!

Innovation with method: An increasing number of tasks in terms of the global economy and in technology reach the limits of feasibility and beyond. We meet this challenge with a broad-based enterprise structure

The Centers of Competence under the umbrella of the GHM GROUP cover a wide range of market-specific solutions for all important areas of application with their respective areas of expertise.

With the GHM GROUP our customers benefit from over 200 years of combined experience. With this expertise, our engineers at the various "Centers of Competence" are quickly and flexibly in a position to develop solutions that meet the specific requirements of our customers and are in-line with market demand.

It is an advantage of our enterprise, which is unrivalled.

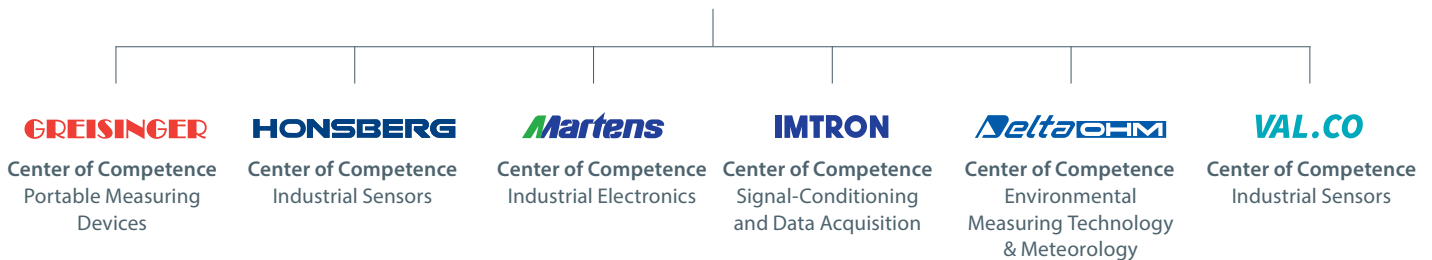

INDUSTRIAL

- Sensors for a variety of process variables such as temperature, flow, level and pressure
- Transmitters and isolators for various input/ output variables
- Indicators and controllers in various formats and performance classes



ENVIRONMENTAL

- Measuring stations for climate and environmental data with the connection to cloud-systems
- Mobile measurement technology for climate, water and gas analysis



TESTING & SERVICES

- Test bench measurement technology with up to 40,000 measurement in the secondary
- Stationary and mobile systems for universal use
- Modular systems for individual adaption to the process needs



Your direct contact to us



+49 2191 9672-0



info@ghm-group.de

Headquarters

GHM Messtechnik GmbH
GHM GROUP CORPORATE
Tenter Weg 2-8
42897 Remscheid | GERMANY
Phone +49 2191 9672-0
Fax +49 2191 9672-40
info@ghm-group.de
www.ghm-group.de

Center of Competence

GHM Messtechnik GmbH
GHM GROUP – Greisinger
Hans-Sachs-Straße 26
93128 Regenstein | GERMANY
Phone +49 9402 9383-52
Fax +49 9402 9383-33
info@greisinger.de
www.greisinger.de

GHM Messtechnik GmbH
GHM GROUP – Honsberg
Tenter Weg 2-8
42897 Remscheid | GERMANY
Phone +49 2191 9672-0
Fax +49 2191 9672-40
info@ghm-group.de
www.ghm-group.de

GHM Messtechnik GmbH
GHM GROUP – Martens
Kiebitzhörn 18
22885 Barsbüttel | GERMANY
Phone +49 40 67073-0
Fax +49 40 67073-288
info@ghm-group.de
www.ghm-group.de

GHM Messtechnik GmbH
GHM GROUP – Imtron
Carl-Benz-Straße 11
88696 Owingen | GERMANY
Phone +49 7551 9290-0
Fax +49 7551 9290-90
info@ghm-group.de
www.ghm-group.de

Delta OHM S.r.l. a socio unico
GHM GROUP – Delta OHM
Via Marconi 5
35030 Caselle di Selvazzano
Padova (PD) | ITALY
Phone +39 049 8977150
info@deltaohm.com
www.deltaohm.com

Valco srl
GHM GROUP – Val.co
Via Rovereto 9/11
20014 S. Ilario di Nerviano
Milano (MI) | ITALY
Phone +39 0331 53 59 20
valco@valco.it
www.valco.it

GHM GROUP International

Austria

GHM Messtechnik GmbH
Office Austria
Breitenseer Str. 76/1/36
1140 Vienna | AUSTRIA
Phone +43 660 7335603
a.froestl@ghm-messtechnik.de
www.ghm-group.de

Brazil & Latin America

GHM Messtechnik Do Brasil Ltda
Av. José de Souza Campos,
1073, cj 06 | Campinas, SP
13025 320 | BRAZIL
Phone +55 19 98275 0069
info@grupoghm.com.br

Czech Republic / Slovakia

GHM Greisinger s.r.o.
Ovci hajek 2 / 2153
158 00 Prague 5
Nové Butovice | CZECH REPUBLIC
Phone +420 251 613828
Fax +420 251 612607
info@greisinger.cz
www.greisinger.cz

Denmark

GHM Maaleteknik ApS
Maarslet Byvej 2
8320 Maarslet | DENMARK
Phone +45 646492-00
Fax +45 646492-01
info@ghm.dk
www.ghm.dk

France

GHM GROUP France SAS
Parc des Pivolle
9 Rue de Catalogne
69150 Décines (Lyon) | FRANCE
Phone +33 6 60 32 06 35
contact@ghm-group.fr
www.ghm-group.fr

India

GHM Messtechnik India Pvt Ltd.
209 | Udyog Bhavan
Sonowala Road | Gregaon (E)
Mumbai - 400 063 | INDIA
Phone +91 22 40236235
info@ghmgroup.in
www.ghmgroup.in

Italy

Sales Greisinger & Delta OHM
GHM GROUP – Delta OHM
Via Marconi 5
35030 Caselle di Selvazzano
Padova (PD) | ITALY
Phone +39 049 8977150
info@deltaohm.com

Italy

Sales Honsberg, Martens, Valco
GHM GROUP – Val.co
Via Rovereto 9/11
20014 S. Ilario di Nerviano
Milano (MI) | ITALY
Phone +39 0331 53 59 20
alessandro.perego@valco.it

Netherlands

GHM Meettechnik BV
Zeeltweg 30
3755 KA Eemnes
NETHERLANDS
Phone +31 35 53805-40
Fax +31 35 53805-41
info@ghm-nl.com
www.ghm-nl.com

South Africa

GHM Messtechnik SA (Pty) Ltd
16 Olivier Street
Verwoerdpark, Alberton 1453
SOUTH AFRICA
Phone +27 74 4590040
j.grobler@ghm-sa.co.za



Visit us: www.ghm-group.de